

- FT 520

W44

TT 520
.W44
Copy 1

WELANDER'S

PERFECTED

COMBINATION SYSTEM

BASED UPON

PRACTICAL, SURE AND SIMPLE METHODS,

GIVING THE EXACT BALANCE AND PROPORTIONS FOR
EACH AND EVERY TYPE AND FORM.

BY

A. W. WELANDER,

CHICAGO, ILLS.

COPYRIGHT APPLIED FOR BY A. W. WELANDER.

ILLUSTRATED BY FOURTEEN PLATES, WITH FULL INSTRUCTIONS FOR DRAFTING THE VARIOUS STYLES OF GENTLEMEN'S AND LADIES' GARMENTS.

PUBLISHED BY A. W. WELANDER.

TT520
1944

1944

CALC-3331-United

.....189

This Certifies, That

of..... has paid \$10.00 for

has paid \$..... for full course of instruction

one copy of "Welanders Perfected Combination System," the same to be
only for his **OWN PERSONAL USE** and is **NOT TRANSFERABLE** in any
shape or manner. All rights reserved.

A. W. Welanders

No.

AUTHOR.



Yours truly,

A. W. Welander

Preface

AS I have been having great success in cutting for several years, I take pleasure in introducing my method to others. This method is founded on practical experience—from daily practice for many years. I have, as you see on opposite page, learned systems in endless variety, with and without diplomas. Some of which I have no books on, or records of, to show at present, but I have given one and all a thorough study before laying them aside. I have found some very good and some very weak in points. There has been too much guess work about some of them. By exchanging ideas with all men who have published these works on garment cutting, I have at last founded my own, and for several years in daily practice used the same for gentlemen's and ladies' cutting with great success. Cutting is a branch of art, and it takes styles and taste to be an up-to-date cutter. And next you must be rapid and sure at your work. To do this it takes a method that there is no guess work about, one that gives the cutter an accurate, balanced and well-fitting garment. And by this method I claim you can cut garments in less time than by any one I ever saw published. The diagrams illustrating the principles set forth have been drawn by myself, perfected and simplified with the utmost care and are so plain that anyone giving them careful study will find them the most reliable ever published on garment cutting for both sexes.

In conclusion, let all those who intend to study and practice these new principles, lay aside all others while using these and the most successful method of cutting will be yours.

YOURS TRULY,

THE AUTHOR.

Index

	PAGE
How to Take the Measure, - - - - -	7
How to Draft the Pants, - - - - -	9
How to Draft the Vest, - - - - -	11
How to Draft a Frock Coat, - - - - -	13
How to Draft a Coat for Humpback Mal., - - - - -	15
Coat and Vest cut from one Draft, - - - - -	17
How to Draft the Sleeve, - - - - -	19
Additional Explanations of Diagrams, - - - - -	20
Practical Remarks from Daily Practice, - - - - -	21
How to Draft a Ladies' Waist, - - - - -	23
Diagram for Ladies' Sleeve, - - - - -	25
Unusual Trousers Pockets, - - - - -	26
A Lay-Out for a Sack Suit, - - - - -	27
Directions for Making a Canvas, - - - - -	28
The Correct Way to Run Lines in Padding Coat and Lapel, - - - - -	29
How to Prepare an Edge for a Stitched Coat, - - - - -	30
Work on Cutting, - - - - -	31
Terms for Instructions, - - - - -	32

Explanation for Measuring.

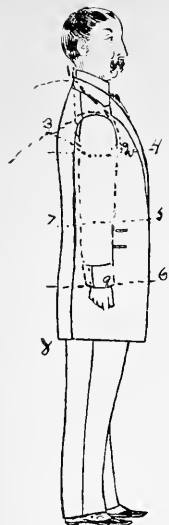

The measure is the first thing to take in getting the customer's shape and form, and should be taken with care. Never be careless in taking the measure.

1 to 2 is strap measure, giving the man's stooping or erect form, and should be taken natural, neither loose nor tight, but fairly snug.

1 around in front at 2 to 1 is upper shoulder measure. Take this natural, neither tight nor loose.

3 around in front at 2 to 3 is lower shoulder measure. Always take this snug.

4 is around breast. Never take this measure snug, but natural on an ordinary figure. But on a fat man take it fairly snug.

5 is around waist. Do not take this loose, but snug on an ordinary figure, and easy on a fat man.

6 is around seat; take easy for the coat, and snug for pants.

2 to 9 is length of sleeve taken with square.

The above measure is for coat, and is taken over the vest for a coat, and over coat for an overcoat.



INSTRUCTIONS FOR VEST MEASUREMENT.

Vest measure is taken same as coat, except a little snugger, as the vest is always cut $\frac{1}{2}$ inch smaller than coat measure.

H to I is first button on vest; H to bottom full length of vest; L around breast; M around waist; strap and shoulder measure are taken the same as for undercoat.

DIRECTIONS FOR PANTS MEASUREMENT.

N is around waist. Take as customers wants it—loose or snug or natural.

P is around largest part of seat, taken snug, not tight.

Measure around knee and bottom width desired.

R to S is full length in inside seam.

N down to O is from hip to sole of heel on shoe.

Take your inside measure good length always.

Take outside to suit customer—high waist or short waist.

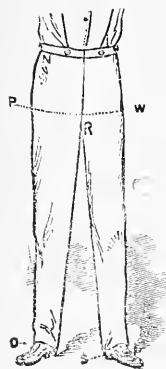

DIAGRAM 1.

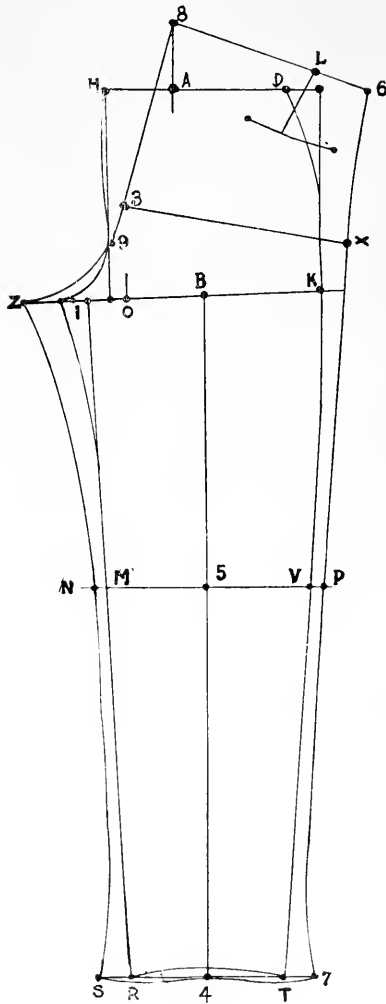

Diagram 1.

HOW TO DRAFT THE PANTS.

32 Waist.	18½ Knee.	42 Outside.
38 Seat.	17¾ Bottom.	32 Inside.

FOREPART OF PANTS.

Draw line from D to H and D to T.
 K to O is $\frac{1}{2}$ of seat measure on division.
 O to I $\frac{1}{4}$ of seat on division.
 Go back $\frac{3}{4}$ inch and forwards $\frac{3}{4}$ inch at L.
 Go forward $\frac{1}{4}$ inch at O.
 B is half way between K and I.
 Draw line to 4.
 4 to T is 4 inches.
 4 to R is 4 inches.
 Draw line R to back of I $\frac{3}{4}$ inch.
 Shape from I half way to knee, as shown.
 O to 9 is $\frac{1}{4}$ of seat on division.
 H to A is 1-6 of seat.
 A to S is 1-6.
 H to D is $\frac{1}{2}$ of waist measure on division.
 5 to V is $\frac{1}{4}$ of knee measure on division.
 Draw line from T to V and V to K.
 Shape from H to 9 and I, as shown; also at D.
 This finishes forepart for the pants.

BACKPART OF PANTS.

Place front part on your paper or cloth, as you may prefer to cut.
 Draw line at H, Z, X and S.
 Draw these lines across.
 Measure from H to D and S to 6, $\frac{1}{2}$ of waist measure, and 1 inch for seams.
 9 to 3 is same as from 9 to O.
 Measure 9 to K and 3 to X, $\frac{1}{2}$ of seat measure, and 2 inches.
 I to Z is 1-12 of seat measure on division.
 Measure from M to V, and X to P, width of knee, and 1 inch for seams.
 Go out same at both sides, V to P as M to X.
 Measure from R to T and S to 7, width around bottom wanted.
 Draw line from 8 to 9 and P to X.
 Shape as shown on diagram, and the draft is finished.

FOR A FAT MAN.

Take out at X if too wide for measure.
 Go in from line to D $\frac{3}{4}$ inch and then forward at H, $\frac{1}{4}$ of waist on division.
 Then shape from H to 9, as usual.
 Go up at H 1-16 of seat if customer is very fat and measure as taken in outside seam.
 This is only for very fat men.

DIAGRAM 2.

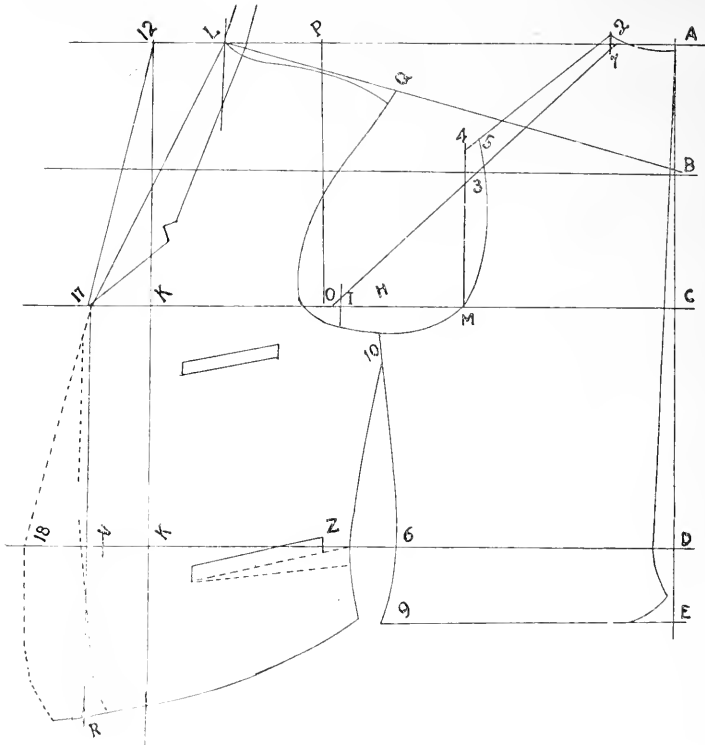

Diagram 2.

HOW TO DRAFT THE VEST.

Draw line from A to 12, and A to E.

A to C is $\frac{1}{3}$ of upper shoulder measure on division.

B is half way between A and C.

C to O is $\frac{1}{3}$ of lower shoulder measure.

I is $\frac{3}{4}$ back of O.

C to K is $\frac{1}{2}$ of breast measure.

K to 17 is 2 inches for seams.

Draw lines B, C, O, K, and 17 to 12.

A to 2 is $\frac{1}{6}$ of breast, with addition.

7 to 2 is $\frac{3}{8}$ inch.

Go below line $\frac{1}{4}$ inch at A.

P to L is $\frac{1}{6}$ of breast, with addition from K to 17.

Draw line from 7 to I, crossing B line at 3.

Draw line from 3 to M.

3 to 4 is 1 inch on vest and $1\frac{1}{4}$ on coat.

4 to 5 is 1 inch; shape from 2 to 5.

Measure from A to 2 and O to L, length of strap, and $\frac{1}{2}$ inch added.

Draw line from L to B.

L to Q is the same as from 2 to 5.

Go under line at Q on a vest; also for a fat man's coat.

Shape as shown in diagram from 5 to Q.

Go under O at 10 1 inch, and in front of O line $\frac{3}{8}$ inch.

Now draw line from 17 to V.

Go out $\frac{1}{2}$ inch at V and then draw line to R.

D is natural waist.

Go in $\frac{3}{4}$ inch at D, and draw line to A.

D to E is 3 inches.

6 to 9 is 3 inches.

6 to D line is $\frac{1}{4}$ waist and 1 inch.

Z to V line is $\frac{1}{4}$ waist and 1 inch.

Take out between Z and 6, the difference.

Measure A to 2 and G to 17, opening of vest, and add 1 inch.

And down to R full length, and $1\frac{1}{4}$ inch for a stitch and 1 inch, for bound vests.

Shape front as shown.

Now I will explain 18. This is for a fat man, or a man being less than 4 inches smaller over waist than breast. Add $\frac{1}{3}$ of every inch he is larger over the waist than proportion, and add balance in side.

Add from V line to 18, and draw line from 17 to 18, and 18 down. If a man is very fat, take out at Z $\frac{1}{24}$ of waist, but add seams between at Z, and add at bottom what you take out at Z. To make back and front same length, back should always be $\frac{3}{8}$ inch longer at 9. This finishes the vest draft.

DIAGRAM 3.

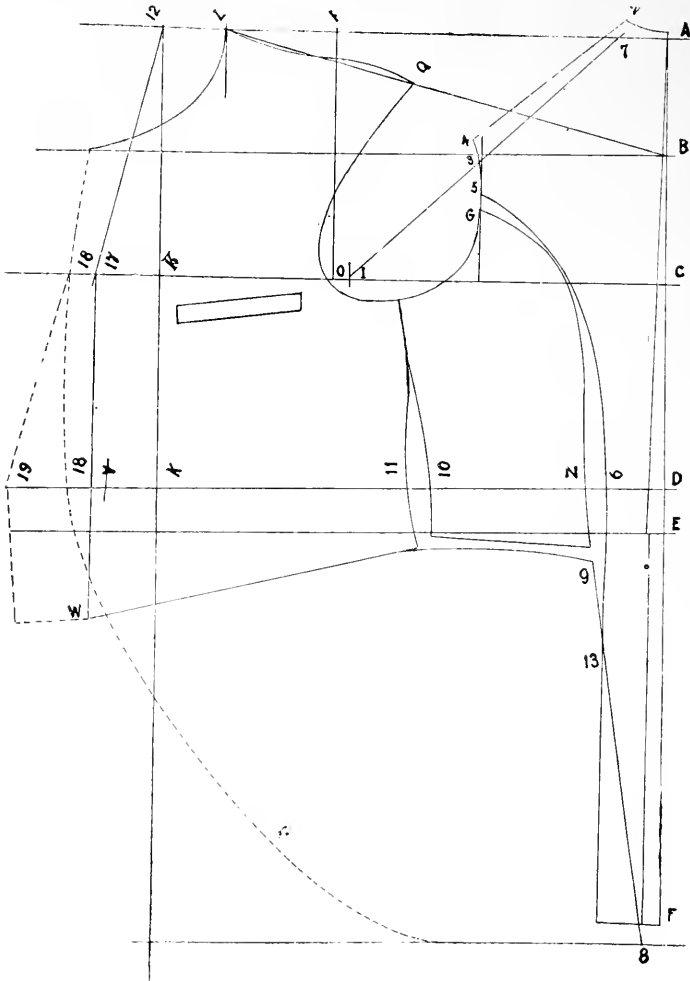

Diagram 3.

HOW TO DRAFT THE FROCK COAT.

Draw line from A to 12, and A to F.

A to C is $\frac{1}{3}$ of upper shoulder measure on division.

B is half way between A and C.

C to O is $\frac{1}{2}$ of lower shoulder measure.

I is $\frac{3}{4}$ inch back of O.

C to K is $\frac{1}{2}$ of breast measure.

K to 17 is 2 inches for seams.

17 to 18 is $1\frac{1}{2}$ to 2 inches on single breasted, and $2\frac{1}{2}$ to 5 inches on a double breasted coat.

Draw lines B, C, O, K, and 17 to 12.

A to 2 is $\frac{1}{3}$ of breast, with addition from K to 17.

7 to 2 is $\frac{5}{8}$ inch.

P to L is 1-6 of breast, with addition.

Draw line from 7 to I, crossing B line at 3. This gives exact width of back.

Draw line from 3 to M.

3 to 4 is $1\frac{1}{4}$ inch.

4 to 5 is $\frac{1}{8}$ of breast, with addition.

Shape from 2 to 4, and 4 to 5; take out $\frac{5}{8}$ inch between 5 and G.

Measure from A to 2, and O to L, length of strap and $\frac{1}{2}$ inch added.

Draw line from L to B.

L to Q is the same as from 2 to 4.

Shape is shown at G and around armhole; go in front of line at O $\frac{1}{2}$ inch, and under line C at I $\frac{7}{8}$ inch.

A to B is natural waist, D to E is $1\frac{1}{4}$ inch.

A to F is full length.

Go in $\frac{3}{4}$ inch at E; from D to G is $\frac{1}{8}$ of breast, with addition; take out $1\frac{1}{4}$ inch between 6 and N, and $\frac{7}{8}$ inch between 10 and 11.

N to 10 is $\frac{1}{4}$ of breast, no addition.

Go out $\frac{1}{2}$ inch at V.

Draw line from 17 to V, and V to W.

Sweep from 1 to W by L.

Shape draft as shown.

TO DRAFT THE SKIRT.

E to 13 is $9\frac{1}{2}$ inches.

1 to 9 is $\frac{1}{2}$ inch.

Measure width of back, and from K line back to 13 is $\frac{1}{2}$ of seat and 1 inch added.

Shape top to W; go below line $\frac{1}{4}$ inch at W.

Draw line from 13 down; shape from sidebody to 13 down.

Shape front from upper 18 to S. This finishes the draft.

Now I will explain 19. V to 19 is $\frac{1}{3}$ of every inch the measure is over proportion, which is 4 inches less over waist than breast measure. Whatever a customer measures more over the waist than proportion, add $\frac{1}{3}$ of every inch, and draw line from upper 18 to 19, and 19 down. Add balance of measure between 10 and 11, and 6 and N. This will cut a perfect garment for a corpulent man.

DIAGRAM 4.

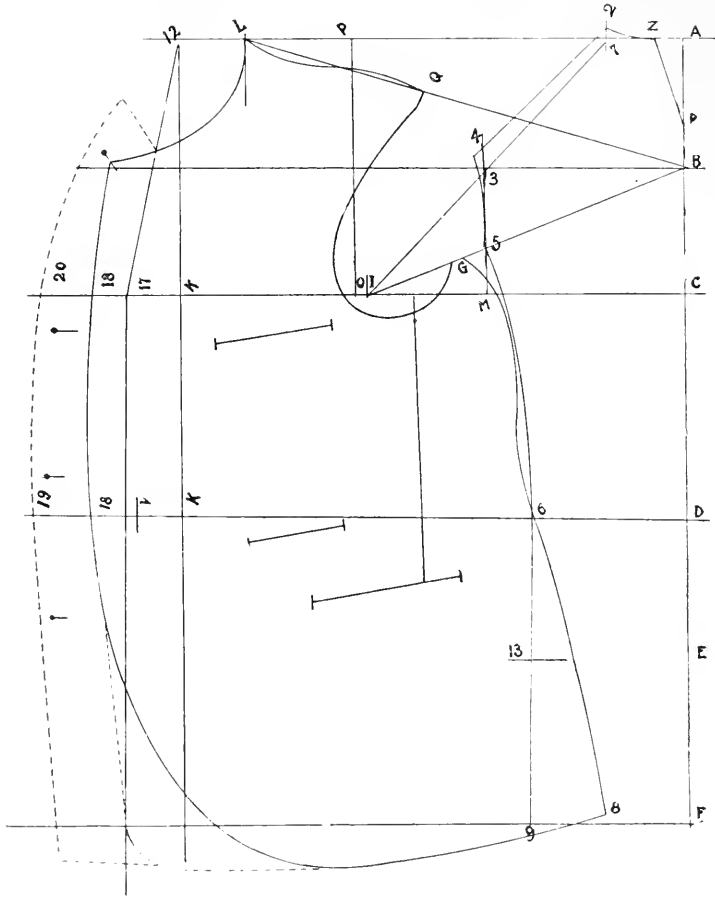

Diagram 4.

How to Draft a Coat for a Humpback Man.

DRAFT AS BELOW. This is drafted the same as any other coat except at the neck and the back.

A SINGLE BREASTED FOUR-BUTTON AND DOUBLE BREASTED SACK.

Draw line from A to 12, and A to F.

A to C is $\frac{1}{3}$ of upper shoulder measure.

B is $\frac{1}{3}$ way between A and C.

C to O is $\frac{1}{2}$ of lower shoulder measure.

I is $\frac{3}{4}$ inch back of O.

C to K is $\frac{1}{2}$ of breast measure.

K to 17 is 2 inches for seams.

17 to 18 is $1\frac{1}{2}$ to 2 inches on single breasted, and 17 to 20 is $2\frac{1}{2}$ to 5 inches on double breasted.

Draw lines B, C, O, K and 17 to 12.

A to Z is 1-12 of breast, no addition.

Z to 2 is $\frac{1}{8}$ of breast, with addition from K to 17.

7 to 2 is $\frac{5}{8}$ inch.

P to L is 1-6 of breast, with addition.

Draw line from 7 to 1, crossing B line at 3.

Draw line from 3 to M.

3 to 4 is $1\frac{1}{4}$ inch.

Draw line from B to I.

Shape from 2 to 4, and 4 to 5.

Take out $\frac{7}{8}$ inch between 5 and G.

Measure from Z to 2 and O to L, length of strap, and $\frac{1}{5}$ inch added.

Draw line from L to B.

L to Q is the same as from 2 to 4.

Shape as shown at Q and around armhole to G; go in front of line at O $\frac{1}{2}$ inch, and under C line at I $\frac{7}{8}$ inch.

Z to R is sharpest point on hump.

D is natural waist.

F is full length.

D to 6 is $\frac{1}{3}$ of breast, no addition.

6 to 13 is 8 inches.

Measure from E to 13, and K line back to 13, is $\frac{1}{2}$ of seat and 1 inch added.

Place tape at 5 to 9 and then at G.

Sweep back to 8, and sweep 8 by L over in front.

Shape from G to 13 down to 8.

Go out $\frac{1}{2}$ inch at V.

Draw line from 17 to V and V down.

Shape front as shown for single and double breasted coats. Overcoats are cut the very same way in front and back only larger, as the measure for overcoats are used larger for same man.

Take out a seam under arm down to pocket or take out $\frac{3}{8}$ inch extra at G and M.

Pocket is 12 inches below armhole or 6 inches above full length of sleeve, from bottom of sleeve upwards to armhole.

DIAGRAM 5.

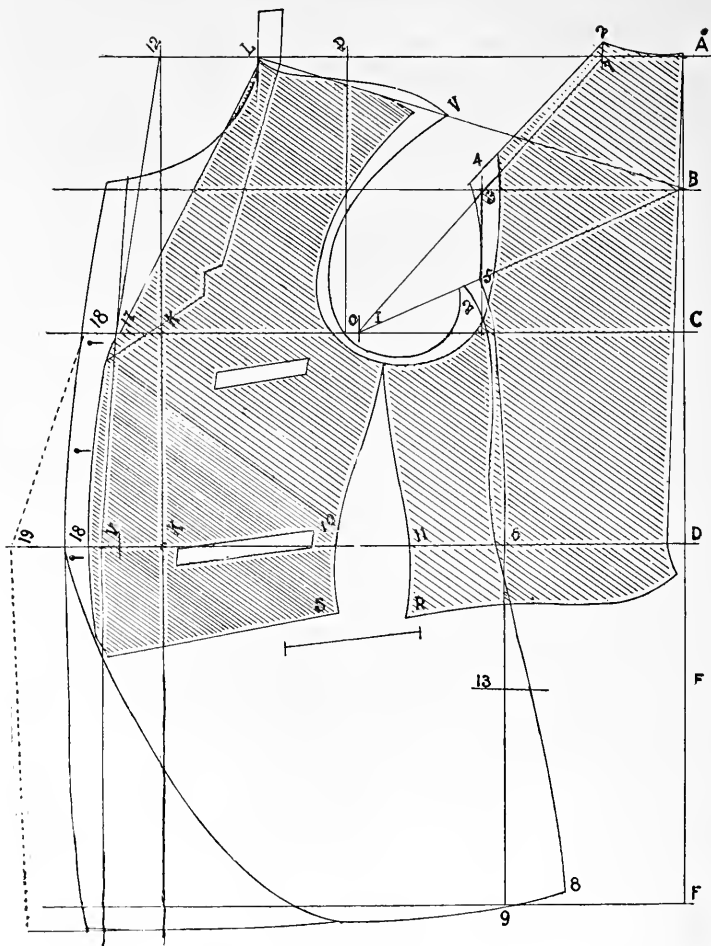

Diagram 5.

Showing Coat and Vest Cut from same Draft.

Draw line from A to 12, and A to F.
 A to C is $\frac{1}{3}$ of upper shoulder measure.
 B is half way between A and C.
 C to O is $\frac{1}{3}$ of lower shoulder measure.
 I is $\frac{3}{4}$ inch back of O.
 C to K is $\frac{1}{2}$ of breast measure.
 K to 17 is 2 inches for seams.
 17 to 18 is $1\frac{1}{2}$ to 2 inches on single breasted, and $2\frac{1}{2}$ to 5 on double breasted.
 Draw lines B, C, O, K, and 17 to 12.
 A to 2 is $\frac{1}{8}$ of breast, with addition from K to 17.
 7 to 2 is $\frac{5}{8}$ inch.
 P to L is 1 6 of breast, with addition.
 Draw line from 7 to I, crossing B line at 3.
 Draw line from 3 to M.
 3 to 4 is $1\frac{1}{4}$ inch.
 Draw line from B to I.
 Shape from 2 to 4, and 4 to 5.
 Take out $\frac{5}{8}$ inch between 5 and G.
 Measure from A to 2 and O to L, length of strap, and $\frac{1}{4}$ inch added.
 Draw line from L to B.
 L to Q is the same as from 2 to 4.
 Shape as shown at Q and around armhole to G line.
 Go in front of line at O $\frac{1}{2}$ inch, and under C line at I $\frac{3}{8}$ inch.
 D is natural waist.
 F is full length.
 Draw lines D and F, go inside line at D $\frac{5}{8}$ inch, and draw line to A, and shape down to bottom coming out to line at F, less $\frac{3}{8}$ inch.
 Draw line down in front at K.

Go out $\frac{1}{2}$ inch at V and draw line from 17 to V and from V down.
 6 to 13 is 8 inches.
 Measure from E to 13, and K line back to 13, is $\frac{1}{2}$ of seat and 1 inch added.
 Place tape at 5 to 9, and then at G.
 Sweep back to 8, and sweep 8 by L, over in front.
 Shape from G to 13 down to S.
 Shape front from upper 13 to bottom, whatever shape is desired in front; if 3 button, 4 button, or straight front or double breasted.
 Take a seam under arm down to pocket, or take out $\frac{3}{8}$ inch extra at G and M.
 Pocket is 12 inches below armhole, or 6 inches above full length of sleeve, from bottom of sleeve upwards to armhole. This finishes draft for a usual form.
 Now I will explain 19. V to I9 is for a fat man, or any man measuring more around waist than proportion, which is explained in diagram 3.
 I will now explain how the vest is cut by the same draft as coat.
 Trace the coat draft onto a piece of paper the width of vest same as coat, only go under line at Q and go back 1 inch at 4, and go below $\frac{1}{4}$ inch at A and 2; go below line under arm 1 inch and $\frac{7}{8}$ inch in front at O.
 H to R is 3 inches.
 D to 11 is $\frac{1}{4}$ of waist and 1 inch.
 V to 10 is $\frac{1}{4}$ of waist and 1 inch.
 Measure from A to 2, and L to 17, first button, and add 1 inch, and down to bottom of vest, full length, and $1\frac{1}{4}$ inch for a stitched vest, and 1 inch for binding.
 Shape front and sides, as shown.
 This way of cutting the vest saves half the time and half the work in cutting the garment.

Diagram 6.

HOW TO DRAFT THE SLEEVE.

Draw lines A to 5, and A to S.

A to 5 is $\frac{1}{2}$ of sleeve.

Draw line down.

A to B is $1\frac{1}{4}$ inch.

A to C is $\frac{1}{4}$ of armhole on division, and $\frac{1}{2}$ inch.

D to K is length of sleeve.

5 to Z is $1\frac{3}{4}$ inch.

Draw line to S.

Sweep from Z to B by F; and shape top of sleeve.

O to B is 1 inch.

8 to D is 1 inch.

Shape from O to 8 as diagram.

Place square at K and P, and draw line to S.

K to S and is width around cuffs.

L is width around elbow.

Shape from A to S, and O to L.

Go out 1 inch at D and K and in 1 inch at D and K.

Shape as dotted lines.

This finishes diagram 6.

Additional Explanations of Diagrams

1, 2, 3, 4, 5 and 6.

I have already explained each diagram and how to cut each one, but as we know it needs some experience to be a skillful mechanic of any kind, it also requires some experience to be a good cutter; therefore I will give some daily practice and practical experience with each diagram which will help a great deal to the one cutting by the system. As far as I have seen, I know of no system published that gives this additional work.

Most of the works published on cutting start with a coat diagram, but as you will see my first diagram is a pants. We all start at the bottom and go upwards, and in this trade of ours we always learn the pants first, then the vest, coat, etc. So it strikes me that the proper way would be to explain the pants first.

REMARKS ON THE PANTS.

Now in regard to the pants, there is not much to be said except what has been explained in diagram 1.

In cutting well-fitting pants, some care should always be taken in shaping the draft as you see the man is built. At H to G should be shaped and not follow straight line, as the pants will not fit so well. At D should be shaped in for about $1\frac{1}{2}$ inch and come out short or long on hip, as customer is built. Z down to X should not be shaped in too much, as the pants will wrinkle around the thigh some. Between X to P should not be hollowed in more than $\frac{5}{8}$ inch, on fashionable pants. For spring bottom, or a narrow leg, take out more between X to P and add on to line from P to 7. In making, never let the tailor stretch them much between Z to R. At knee and bottom, always go out same on each side, front part.

For a fat man, go in at D 1 inch and then forward with the measure $\frac{1}{2}$ of waist on division and draw line from H to bottom on line $\frac{1}{4}$ inch forward of O. Then shape to G and I, and draw line from G to 8, where line H crosses. H to A is the same as A to 8. Go in at X what you go forwards at G, which measure will show when applied from G to K, and G to X, and 2 inches added.

REMARKS ON THE VEST.

The vest is cut the same as the coat, with the exception of a few points at L where I always go out $\frac{3}{8}$ inch as I cut no stand on collar. It is not used on fashionable cutting. At Q I always go under line $\frac{1}{4}$ inch to $\frac{3}{8}$ inch, as there is no wadding canvass or padding in the vest at this point like there is in the coat. At A and 2 I go under line one large seam, or $\frac{1}{4}$ inch, and at 4 I make back smaller from 4 to 2 one inch, and the same from L to Q. At O I go forward $\frac{7}{8}$ inch, and under line at H 1 inch.

REMARKS ON THE COAT.

In cutting the frock coat, care should be taken in shaping sidebody from G to X, so as not to leave too much of a hump at back, and give it graceful shape at N and 10. Forepart at 11 is one seam longer than sidebody, and sidepart is two seams below line at 1, and one seam at 10. I to 7, crossing line B at 3, will always give correct width of back. There is no need of measuring the customer's back.

K to 17, and K to V, is 2 inches for seams, but then I always go $\frac{1}{2}$ inch forward at V, and then draw the line from 17 to V and V to bottom. For a slim man, never take off any in front at 18 and V, but take out at 11 and A, V, taking out on front part to make his correct measure.

For a fat man, after adding $\frac{1}{3}$ of his fatness in front at 19, go back 2 inches and draw line down about 11 inches, and measure from this line back to 13. Half of seat and 1 inch added is usual. This is very important to get his seat measure and balance. Button stand must be added at 19, but not at upper 18, as the draft shows a button stand added from 17 to 18, which is for both fat and slim. Any other information desired, can be obtained by personal instruction where I form classes and teach it, as I keep no school, but travel and form classes and sell the work.

Practical Remarks from Daily Practice as it Appears on the Bench, Cutting Board, and in Business.

There are many things a cutter must know to be fitted for every branch of the trade. He should be a tailor from the first to the last. He should be a good salesman, a good business man, pleasing to customers, to his tailors who work for him, to his cutters, to his salesmen, if he employs any, never proud and with everlasting patience, the first at the office in the morning and last to leave in the evening. Never go out for dinner or supper, when customers are most apt to come in to see you.

Now we cannot fill all these places at once, as we start out as cutters, but we can all acquire them little by little. I have myself practiced all these things, and at an early age learned tailoring on the bench. I learned my trade in Europe, and worked there as a journeyman tailor for many years for many of the finest tailors in that country, and at the early age of fourteen learned cutting, and practiced cutting on my own account, at different times taking orders and working for myself. But being young, I wanted to travel and see the world, so I finally came to America where I have been working as a coat maker for Chicago's finest tailors for several years, and also in different parts of the Northwest, until I made up my mind I would practice cutting and follow it, as I always had a liking for that branch of the trade. This I did with great success, both as cutter, manager for tailoring business, and in business for myself.

My work in preparing this system has taken me several years to perfect, and by using it in daily practice, I have, to my greatest satisfaction, accomplished the work for publication. The ladies' system is alone a piece of work that cost me three years' study, and can cut the most perfect-fitting ladies' garment by it without a try-on, as with the gentlemen's. I hardly ever try on a garment until seams are sewed, and nine times out of ten without an alteration.

Now we can fit a customer, but not always please him, though you may be the best cutter in the world. But never lose patience with a customer. You may be ready to fly into pieces, but never show it to a customer, and it will be to your interest whether you are a cutter or a boss. Try to please him, if ever so "cranky"; try and try again and when you win him he is your best customer. But one thing: Get your prices out of him. Never make him a lower price: rather let him go; he will come back and pay your price if you have pleased him, because nobody else can please him any better. If you work for a "cranky" boss, never talk cross, or act mean when he tells you anything, but answer freely when in a pleasant mood, and in a way to please him. You will be in his favor and make more money by so doing. If you want to quit your job, do so without quarreling, and the boss will think much more of you.

Now if you are in business and have people working for you, be to them as you wish them to be to you. Speak well to them and they will do things right for you, work cheaper, do better work—do all to please you, rather than to leave their job, even if a bigger salary is offered them. It is necessary to keep good tailors to succeed in business and they are very hard to get at times when you need them. Do all to your own interest. Keep a good man—when you have him it pays.

This is my own daily experience, and may be of some value to the reader. I have myself made hundreds of dollars by using the above method, and lost as many more by not knowing it until of late years.

Yours truly,

THE AUTHOR.

Diagram 7.

HOW TO DRAFT LADIES' WAIST GARMENTS.

To draft, draw line down from A to E, and from A to 12.

A to C is $\frac{1}{3}$ of upper shoulder measure.

B is half way between.

Draw lines B and C.

C to O is $\frac{1}{2}$ of lower shoulder measure.

C to K is $\frac{1}{2}$ of bust.

K to 17 is 2 inches for seams.

17 to 18 is 1 inch always.

Draw lines O, K, and 17 as shown.

A to 2 is $\frac{1}{8}$ of bust measure, with addition from K to 17.

P to L is 1-6 of bust, with addition.

Go back 1 inch at O to I, and draw line from 2 to I, as shown, crossing line at 3.

Draw line down at 3 to M.

3 to 4 is 1 inch.

3 to 5 is $1\frac{1}{4}$ inch.

Shape from 2 to 4.

Measure from A to 2 and O to L, your length of strap measure, and $\frac{1}{2}$ inch.

Draw line from L to E.

L to Q is the same as from 2 to 4.

Shape as shown.

Go forward line O 1 inch, and under at 7 1 inch.

Measure A to 2 and L to X, the measure around the neck.

Shape L to X, as shown.

Go below line $1\frac{1}{2}$ inch at A.

A to D is length of waist.

D to W is $1\frac{1}{2}$ inch for fashionable waist.

A to E is full length.

Draw line D

D to 6 is $\frac{3}{4}$ inch.

6 is $1\frac{3}{4}$ inch wide.

Take out 1 inch between 6 and Z.

Z is 1-6 of bust, no addition.

Take out 1 inch between Z and 10.

10 is 1-6 of bust, no addition.

Take out 1 inch between 10 and 11.

Divide balance of waist measure between 11 and V, into 1 or 2 darts.

Allow seams at waist for each and every piece.

5 to G, take out $1\frac{1}{2}$ inch.

G to M is 1-6 of bust, no addition.

7 is half way between M and O.

Shape all pieces as shown.

17 to 20 is $1\frac{1}{2}$ to 5 inches for double breasted front.

V to 20 is same as from 17 to 20.

In shaping front from X to V, go out $\frac{1}{2}$ inch at V.

V to 19 is for a fat lady, or $\frac{1}{3}$ of every inch the waist measure is over proportion, which is 11 inches less than bust measure always, and add balance in side seams. This finishes draft 7.

DIAGRAM 8.

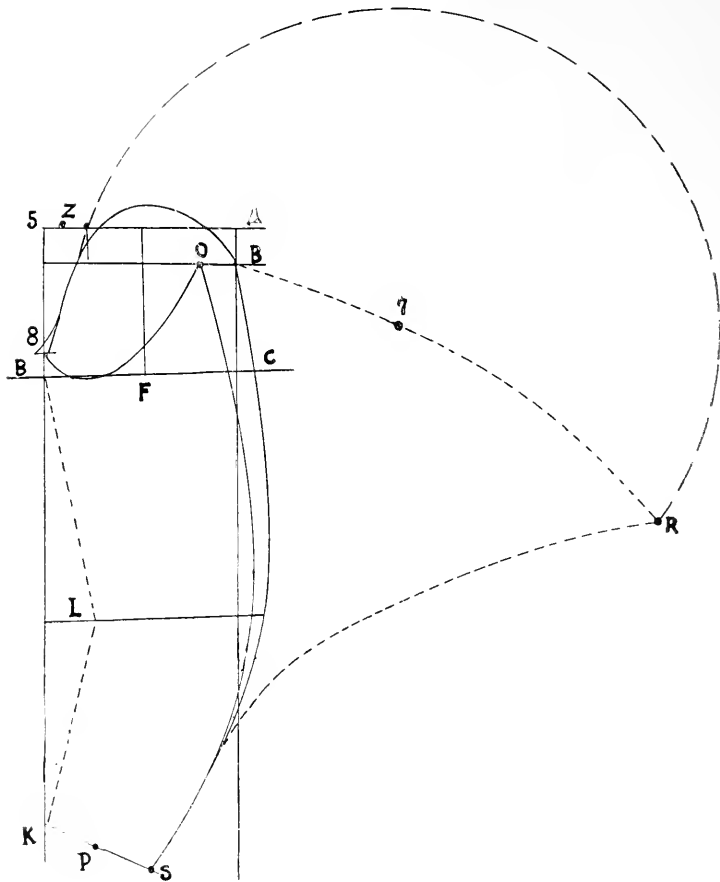

Diagram 8.

DRAFT FOR LADIES' SLEEVE.

To draft draw line from A to 5, and A down.

A to B is 1 inch.

A to C is $\frac{1}{4}$ of armhole on division.

A to 5 is $\frac{1}{2}$ of armhole.

Draw line 5 to K.

F is half way between C and 9.

B to O is 2 inches.

5 to Z is $1\frac{3}{4}$ inch.

Sweep from B to Z by F.

Draw line from Z to S.

9 to K is full length of sleeve, taking in inside seam on sleeve.

Place square on F and K.

Draw line to S.

K to S is width around cuff.

Go in $1\frac{1}{2}$ inch at L, then measure your width of elbow.

Shape as shown. This will finish the draft.

HOW TO DRAFT A WIDE OR LEG OF MUTTON SLEEVE.

P is half way between K and S.

Sweep from B to R by P.

Now measure your width desired at top from 5 to R.

7 is half way between.

Sweep S to R by 7.

S to R is same as S to O on undersleeve.

This finishes the large sleeve.

Cut with undersleeve or without, as your style calls for.

Addition to Diagram 1.

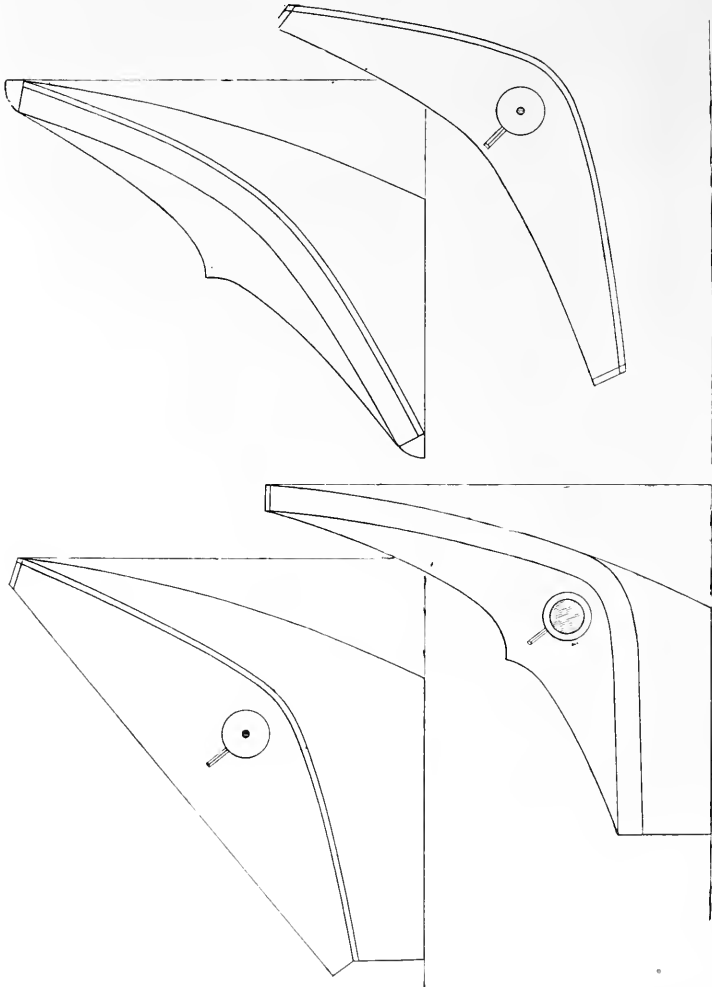

This cut shows different kinds of unusual Trousers Pockets which are sometimes called for by customers, and which were made a great deal on Dress Trousers years ago.

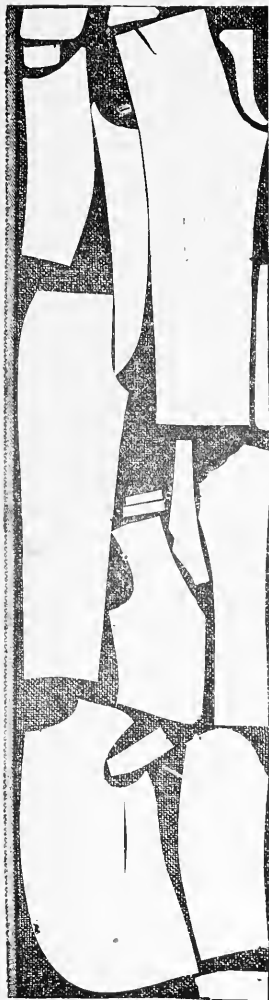

Addition No. 1 to Diagrams 1, 2, 3, 4, 5 and 6.

AN EASY LAYOUT FOR A SUIT OF CLOTHES,

38 Breast, 32 Leg, and cut out of three
yards regular 54-inch goods.

Now this represents a sack suit, but a three-button frock will cut just as easy out of same length coat, not exceeding 33 inches in length.

This cut is only a facsimile of our every-day practice when we are cutting. There are hundreds of other different ways to lay out a suit of clothes, but this book would not allow space to show all the different ones. This is a starter, and will help in cutting your own suit, or for your friend if nothing more. Knowledge is the power in all things.

Addition No. 2 to Diagrams 3, 4 and 5.

This Diagram represents a
Canvas cut ready
for making.

This canvas is cut crossways not lengthways, and is used for frock coats mostly, as for sack and overcoats the canvas would be too short in cutting it this way. The object in cutting the canvas across the goods is to get more elasticity in the canvas, and to keep the front from falling back in pleats after the coat is worn a while. It also makes a better lapel and shoulders, as you see there is only one V taken out in the shoulder. This V will give breast shrunk in at H H, give it ease at L to M, and at G to F, and keep the shape in shoulders after the garments are worn for some time; only cut this V down opposite M.

Shrink up at O to P, or put in V, as would be required of a large breast. The stay tape is put on from N to B, and B to R to C, down in to the skirt part of the coat. I do not claim this is the only way to cut a canvas but I have found this a very good way, and suggest that you try, and judge for yourself. There are many good tailors, but we could be better by exchanging with each other ideas.

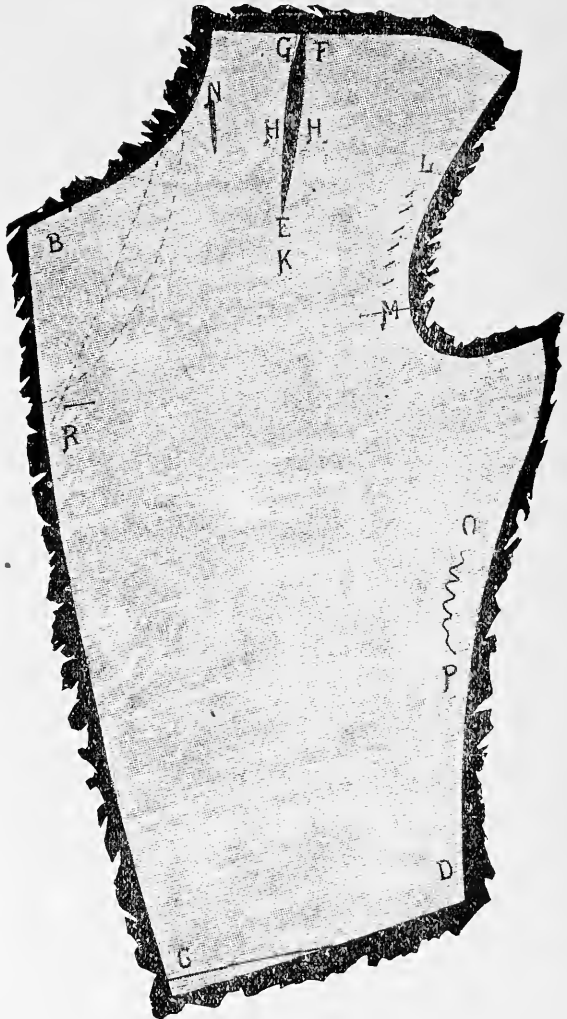

Addition No. 3 to Diagrams 4 and 5.

(29)

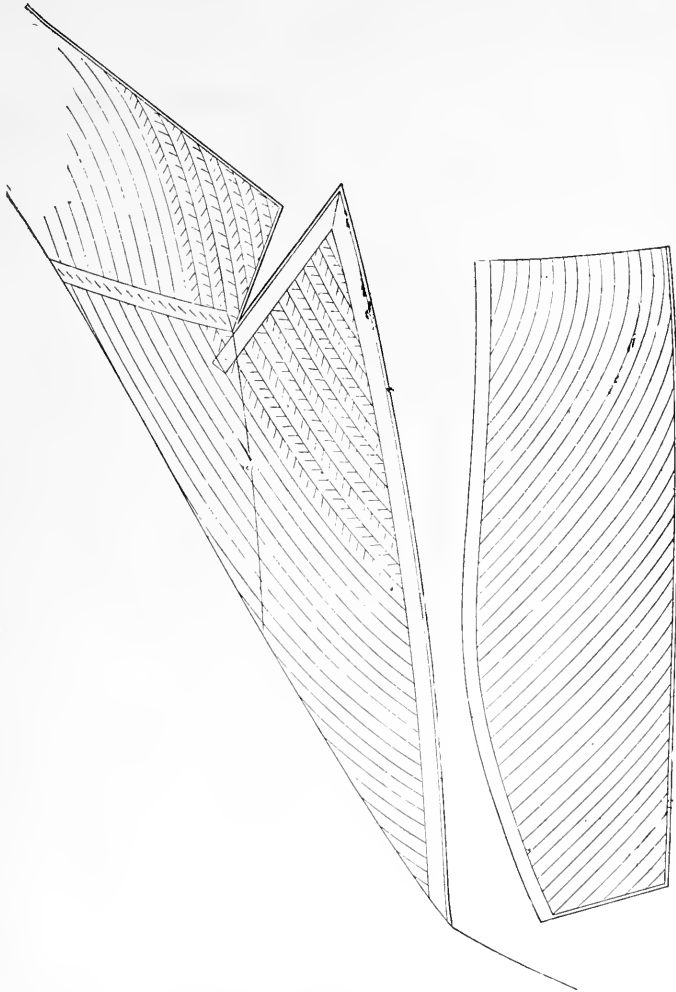

This diagram represents the Collar and Lapels of coat as it appears in work. It shows the correct way to run the lines in padding the collar and lapels. This way of running the lines will roll the lapels and collar very nicely. To get a nice lapel the lines should be close together, and not get the canvas too full between lines so as to make creases on canvas when pressed, but enough ease should be allowed on canvas so as to roll the lapel nicely.

Addition No. 4 to Diagrams 4 and 5.

These three cuts represent the edges of the coat as they appear in work, and how to get a thin edge on a stitched garment.

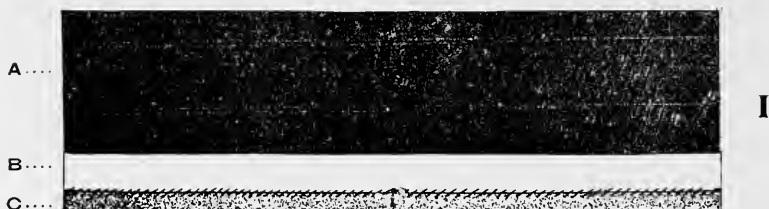

Cut 1 shows edge seamed and seam pressed open. A is facing; B is stay tape; C is canvas. A is sewed onto front of coat; B meets even with seam after it is pressed open and trimmed off; A is facing, and is trimmed off so as to meet between B and C, or in the middle on the tape.

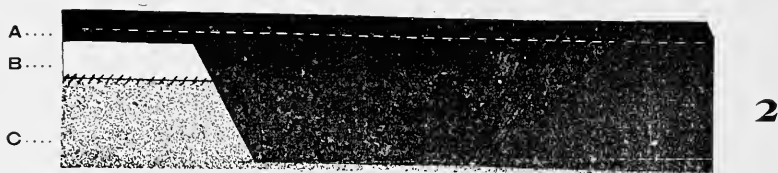

Cut 2 shows A, B, C, after it is turned over and basted; A is facing turned over; B is stay tape; C is canvas. Baste easy, not pulling the thread too hard so as to make the edge crooked. Pains should be taken to press the edge straight.



Cut 3 represents the edge finished, with a stitching either by hand or machine. To press the edge, take a wet sponge cloth and just press light enough to steam through edge. This will even the edge, and then use farmer satin for dry-pressing the edge. Linen is not very good. It gives a hard gloss, and will often burn your garments. Silesia is better and safer.

Works on Cutting

Welander's Perfected Combination System



On Cutting Gentlemen's



And Ladies' Garments.

WELANDER'S PERFECTED TROUSER SYSTEM	
WELANDER'S PERFECTED VEST SYSTEM.....	
WELANDER'S PERFECTED COAT SYSTEM.....	
WELANDER'S PERFECTED LADIES' SYSTEM	
The above Combined Works.....	\$10.00

The above works will be sent on receipt of price. No books sent C. O. D.

My system is taught by myself only, and by forming classes all over, where I teach the work personally. Where arrangements are made for the assurance of a class of from five to ten who wish to learn cutting, I will come and give instructions day or evening, or both, as may suit.

I make a speciality of teaching my system in this way, and introducing it. I keep no school different from the above plan, but start schools when I have a class from five to ten, or more, wishing to take the system.

When arrangements are made for a class, where I am to go any distance, a remittance is required as an assurance that the agreement is good. The amount can be agreed upon by correspondence.

Address all correspondence to

A. W. WELANDER,
P. O. Box, RED WING, MINN., U. S. A.

A. W. WELANDER,

PROPRIETOR AND
INSTRUCTOR OF THE

“Perfected Combination System.”

(COPYRIGHT APPLIED FOR.)

The Self-Instructions for this System are printed in the English, German and Scandinavian Languages, so as to make it

EASY FOR PERSONS OF ANY NATIONALITY TO LEARN IT ON SHORT STUDY.

TERMS FOR INSTRUCTIONS.

For a Complete Course of Instructions on Trousers Diagram alone.....	\$15.00
For a Complete Course of Instructions on Vest Diagram alone.....	15.00
For a Complete Course of Instructions on Coat Diagram alone.....	25.00
For a Complete Course of Instructions on Ladies' Diagram alone.....	25.00
For a Complete Course of Instructions on the above works combined....	70.00
For Coat, Vest, and Pants.....	50.00

The tuition on the above works must be paid in advance in all cases.
Address all correspondence to

A. W. WELANDER,
P. O. BOX, RED WING, MINN., U. S. A.

LIBRARY OF CONGRESS



0 013 964 942 4 ●

LIBRARY OF CONGRESS



0 013 964 942 4 ●

Hollinger Corp.
pH 8.5