

TT
520
S54

N. S. SHEPHERD'S
SYSTEM OF
DESIGNING and GRADING
LADIES' MESES & CHILDREN'S
GARMENTS



Class TT520

Book 554

Copyright N^o _____

COPYRIGHT DEPOSIT

N. S. SHEIFER'S
SYSTEM OF
DESIGNING and GRADING
LADIES' MISSES' & CHILDREN'S
GARMENTS

Published by N. S. SHEIFER, 1908

Copyright, by N. S. Sheifer.
1908

IN presenting this work, I have the assurance of meeting the wants of the Designing Profession by furnishing a System of Actual Measurements and Drafting with my System Scale Ruler. It is a System that will reach every shape for the Wholesale and Custom trade, in cutting perfect-fitting garments. A System simple in its construction, based on mathematical and practical principles which can easily be mastered. It has taken many years of study and experimenting, and stands without a rival.

N. S. SHEIFER, - - 22 WEST 17th ST., NEW YORK

T 15 4

LIBRARY OF CONGRESS
Two Copies Received
JUN 1 1908
JOURNAL ENTRY
Apr 8 1908
204256
COPY

204256

The Measurements

1. Blade Measure. From point A over the shoulder around the arm. See that your measure is in good order, perfectly level and close under the arm to the centre of Back, say $22\frac{1}{2}$ inches. Now place a pin in Centre of back, level with depth of arm, for Nape Measure. See Fig. 1.
2. Nape Measure. From A, say 7 inches. See Fig. 1.
3. Length of Waist. From A, say $15\frac{1}{2}$ inches. See Fig. 1.
4. Total length.
5. Width of Shoulder. From A, say 8 inches. See Fig. 2.
6. Depth of Arm. Place a Pencil or Ruler straight under the arm and measure. From point A, say 12 inches. See Fig. 2.
7. Side Waist. From A, straight down to Waist, say 21 inches. See Fig. 2.
8. Length of Sleeve. From A down to Wrist, say 30 inches. See Fig. 3.
9. Height of Bust. From A, say 16 inches. See Fig. 4.
10. Length of Front Waist. From A, say $23\frac{1}{2}$ inches. See Fig. 4.
11. Bust. Say 39 inches. See Fig. 5.
12. Waist. Say 25 inches. See Fig. 5.
13. Hip. Say 43 inches. See Fig. 5.

Full Measurements

$22\frac{1}{2}$ — 7— $15\frac{1}{2}$ — 8—12—21

30—16— $23\frac{1}{2}$ —39—25—43

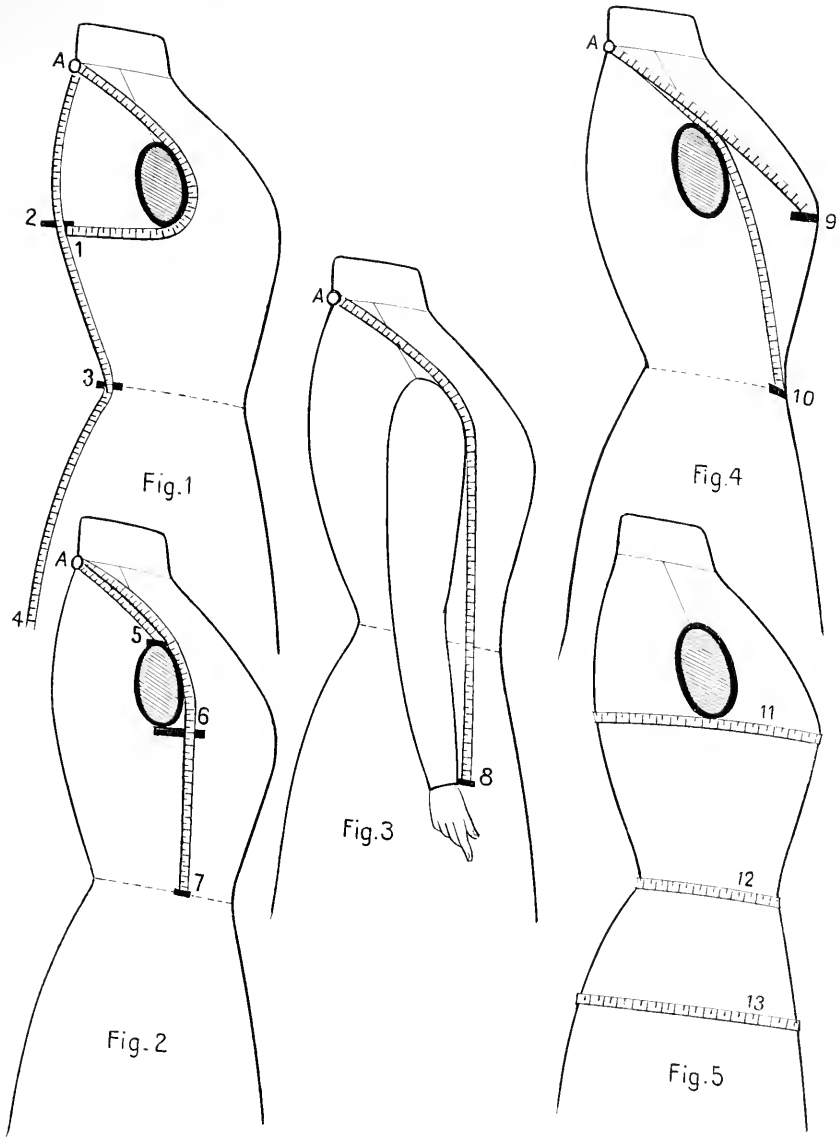

N.S.SHEIFERS'S SYSTEM.

Drafting the Outlines

Measurements

$22\frac{1}{2}$ —7— $15\frac{1}{2}$ —8—12—21

30—16— $23\frac{1}{2}$ —39—25—43

1. Draw line on bottom of paper.
2. Square line 2 by line 1.
3. Blade measure $22\frac{1}{2}$ inches. Apply $22\frac{1}{2}$ on scale No. 1 from line 1. Draw line.
4. Depth of arm 12 inches. Apply 12 inches from line 2. Draw line.
5. Nape measure 7 inches. Apply 7 inches from line 4 on line 1.
6. Length of waist $15\frac{1}{2}$ inches. Apply $15\frac{1}{2}$ inches from point 5 on line 1.
7. Side waist 21 inches. Apply 21 inches from line 2 on line 3. Draw line from 6 to 7.
8. 2 inches from point 6. Draw lines from 8 to 5 and from 5 to corner of lines 2 and 3.
9. Shoulder measure 8 inches. Apply 8 inches from 5.
10. Blade measure $22\frac{1}{2}$ inches. Apply $22\frac{1}{2}$ inches on scale No. 2 from line 3 on line 4. Draw line from 9 to 10.
11. Measure the distance in inches from line 3 to point 10 (say 5 inches). Apply same number, 5 on scale No. 3 from point 5.
12. From line 2, $\frac{3}{4}$ inches less than there is from 5 to 11. Draw line up.
- 13 and 14. Divide in 3 parts between 9 and 10.
15. $1\frac{1}{2}$ inch from line 1
16. Blade measure $22\frac{1}{2}$ inches. Apply $22\frac{1}{2}$ on scale No. 2 from point 12.
17. Allow 1 inch from point 16.
18. From point 12, $\frac{1}{3}$ of space from point 12 to line 4.
19. Bust measure 39 inches. Apply half from line 8 and 5.
20. Allow 3 inches for seams from point 19.
21. Measure the distance from line 3 to point 19. Say you have $8\frac{1}{2}$ inches: apply same number $8\frac{1}{2}$ on scale No. 3 from point 16. Draw line from 20 to 21.
22. From 21, $\frac{1}{3}$ of space between 21 to 20. Add $\frac{3}{4}$ inch for notch collar. Draw line from 22 to point 12.
23. Square line from point 20 by line 4.
24. Height of bust measure 16 inches. Add $1\frac{1}{2}$ inches, apply $17\frac{1}{2}$ inches from line 2 over point 17.
25. Front waist measure $23\frac{1}{2}$ inches, add $\frac{3}{4}$ inch, apply $24\frac{1}{4}$ from line 2 over point 17. Draw line from point 7 to 25. Draw the bust line from point 24 parallel with line 25 and 7.
26. 3 inches from line 3.
27. Lip line 6 inches below waist line.

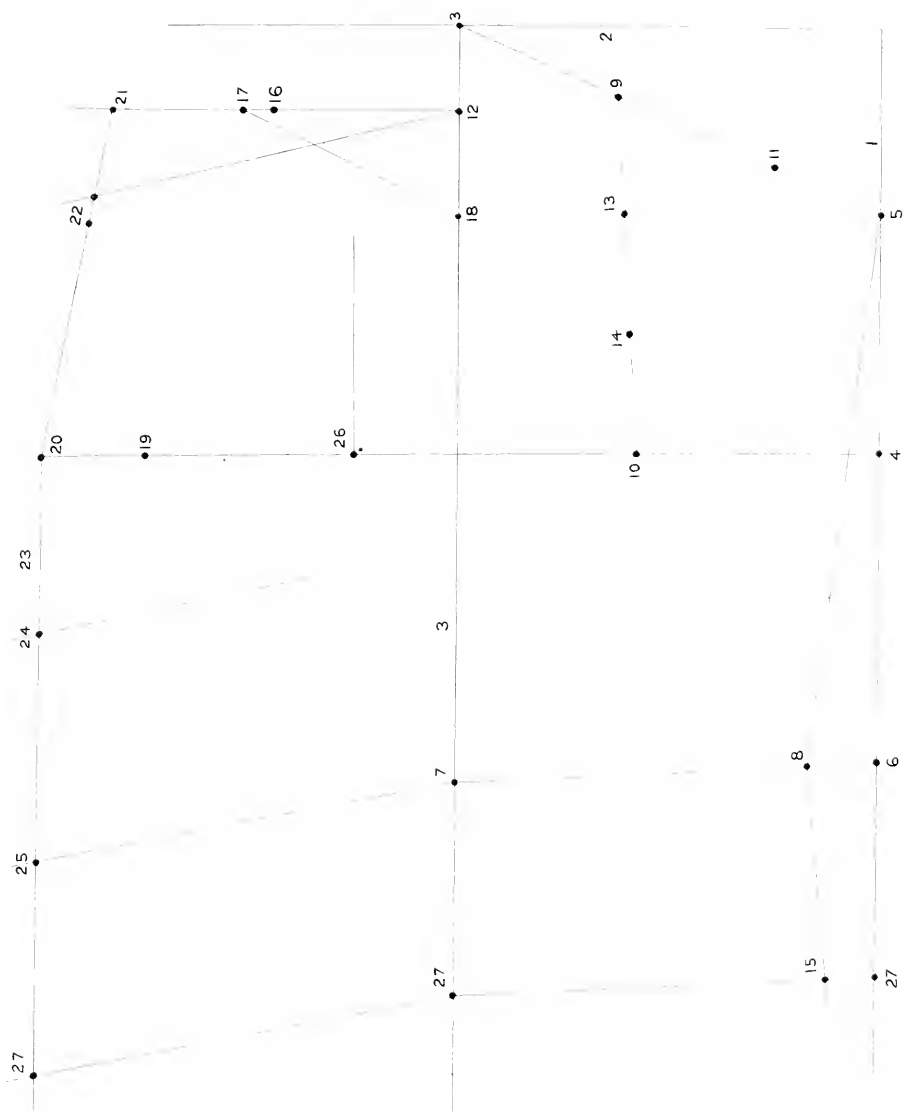

N. S. SHEIFERS' SYSTEM.

Drafting a Tight-Fitting Coat, One Dart

- A. $1\frac{1}{4}$ inch from point 13.
 - B. 1 inch from point 14.
 - C. $1\frac{1}{4}$ inch from point 10.
 - D. Width of back at waist about 2 inches.
 - E. Width of back at hip 1 inch wider than on waist.
 - F. 1 inch from D. Draw line down from C and F.
 - G. 1 inch from line 3 draw line.
 - H. In center between lines F and G draw line.
 - I and J. $5\frac{8}{16}$ inch from each side of line H at the waist. The garment at the waist line from line G to point 8 must measure $\frac{1}{4}$ of waist measure, allowing for seams.
 - K. 1 inch from line F at the hip.
 - L and M. 1 inch from each side of line H at the hip.
 - N. 1 inch from line G at the hip.
 - O. $3\frac{3}{4}$ inch above line 4.
 - P. $3\frac{3}{4}$ inch from B.
 - Q. Width of shoulder for front same as width of shoulder for back.
 - R. Drop side gore $1\frac{1}{4}$ inch below line 4.
 - S. $3\frac{3}{4}$ inch from line G. Waist length of front to correspond with length of side gore.
 - T. $2\frac{1}{2}$ inches from line G at the hip line.
 - U. 1 inch from point 25 on waist line draw a line from point 20 and U. This line is the center of front.
 - V. Measure the width of front at the bust line and apply 1 inch less than half of measure from line U. Draw line parallel with line U.
 - W and X. Measure the width of front at the waist line from U to S, deduct $\frac{1}{4}$ of waist measure, making allowances for seams, and take out the balance at the dart. Say you have $3\frac{3}{4}$ inches over: take out at the waist line $1\frac{1}{4}$ inch from line V to W and $2\frac{1}{2}$ inches from line V to X. Draw the dart lines from waist down parallel with line V.
 - Y. Allowance for lap of coat according to style, say $1\frac{1}{2}$ inches for single breasted and about 3 inches for double breasted.
- † Tape measure should be applied in all cases at the hip to prove that the parts of the garment correspond with hip measure, making allowances for seams and for making up.

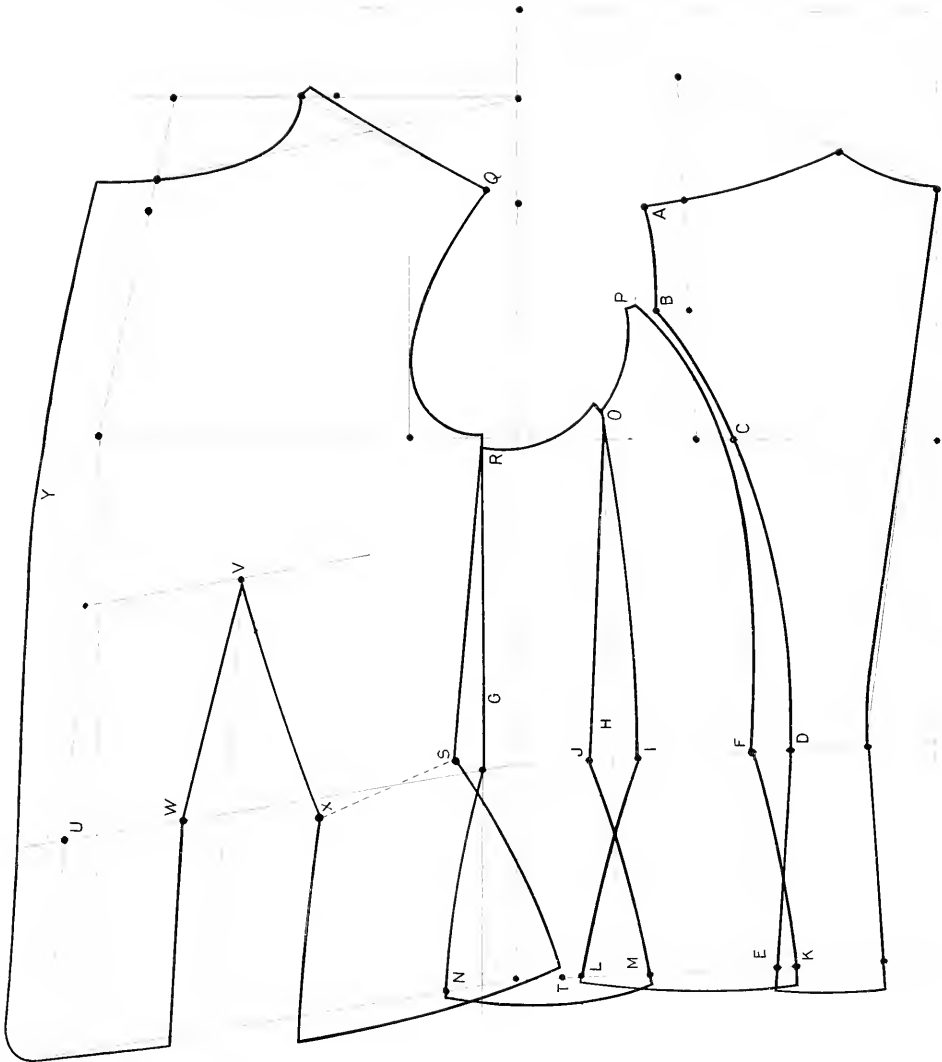

N. S. SHEIFERS' SYSTEM.

Drafting a Tight-Fitting Coat, Two Darts

- A. $1\frac{1}{2}$ inch from point 25, draw line from point 20 and A.
- B. In center of front at the bust line.
- C. In center of line A and point B. Draw line down from point C parallel with line A.
- D. and E. Measure the width of front at the waist line, deduct $\frac{1}{4}$ of waist measure and make allowances for seams—say you have over $3\frac{1}{2}$ inches, take out of front dart $1\frac{1}{4}$ inch, $\frac{5}{8}$ inch on each side at waist line.
- F. 2 inches from E.
- G. $2\frac{1}{4}$ inches (balance of the waist measure) from F.
- H. Draw line down parallel with line C.
- I. $2\frac{1}{2}$ inches from H at the hip.

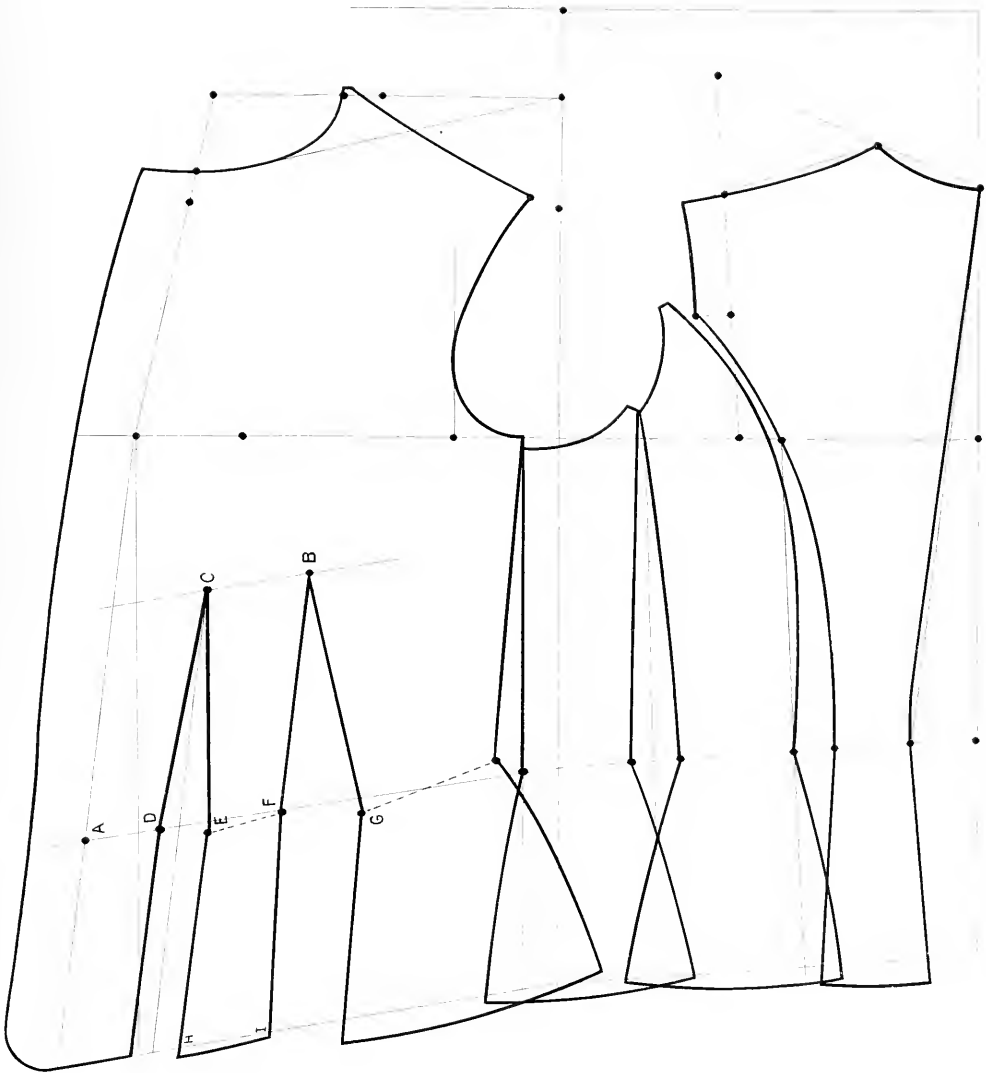

N. S. SHEIFER'S, SYSTEM.

Drafting a Tight-Fitting Back and Semi-Fitting Front

- A. $1\frac{1}{2}$ inches from point 25.
- B. Same as tight-fitting one dart.
- C. From line A at the hip, $\frac{1}{2}$ inch less than there is from line A to B.
Draw line from B and C.
- D. $2\frac{1}{2}$ inches for dart at the waist line.
- E. $3\frac{1}{2}$ inches from C at the hip line.
- F. Allowance for lap, 2 inches for single breasted and 3 to $3\frac{1}{2}$ inches for double breasted.

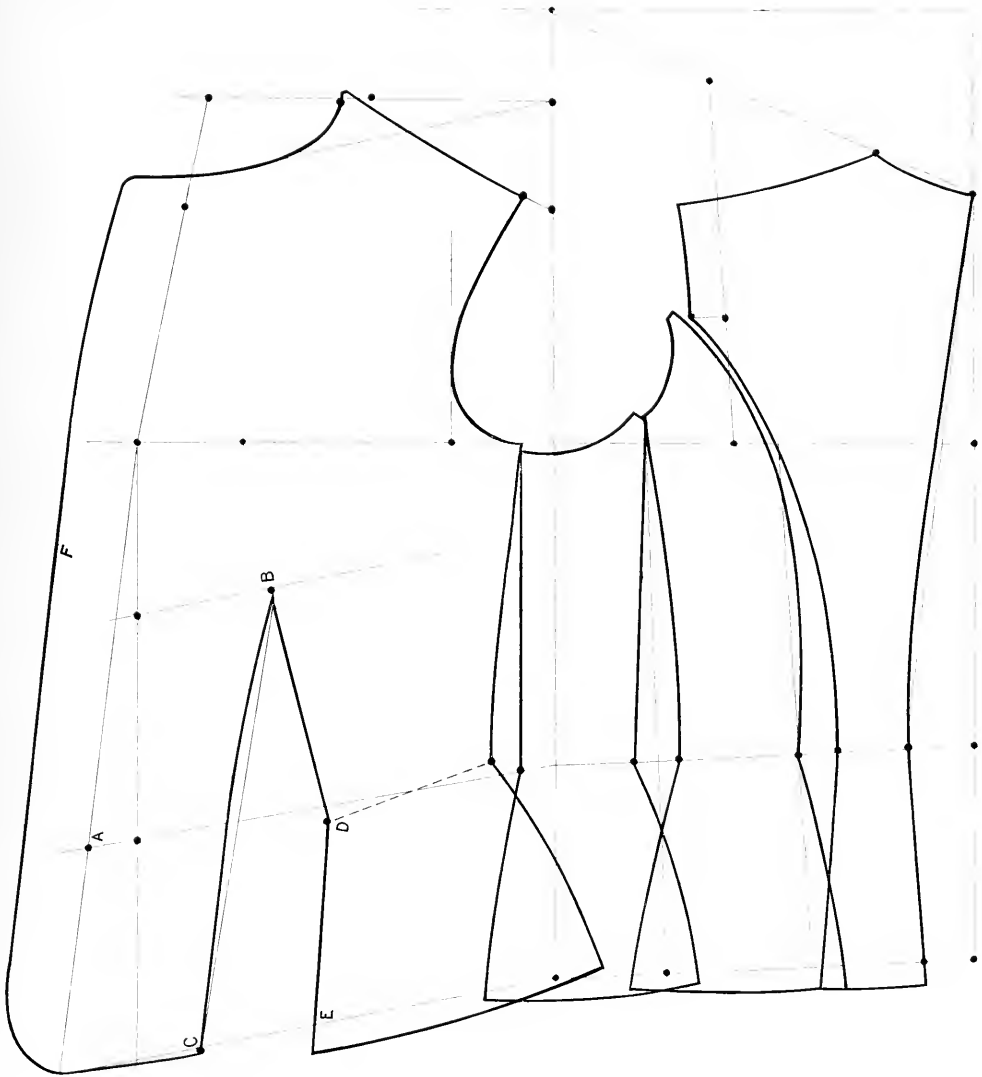

N. S. SHEIFER'S, SYSTEM.



Drafting the Eton Jackets

Figure 1.

- A. In center between line 3 and point 10.
- B. $\frac{3}{4}$ inch less than the fourth part of waist measure, $5\frac{1}{2}$ inches for width of back at the waist.
- C. Back without seam take off $\frac{3}{8}$ inch.
- D. Take out for 2 seams $1\frac{1}{2}$ inches from A to D.
- E. Draw line from point D to line 3 at waist line.
- F. Dart line same as tight-fitting coat. Dart to be taken out according to waist measure by deducting the back, and take out balance of waist measure in dart, making allowance for seams.
- G. For collarless, allow $\frac{3}{8}$ to $\frac{3}{4}$ inch at the neck.

Figure 2. Eton Jacket with gore.

- A. $\frac{3}{4}$ inch below point 14.
- B. Width of back according to style and taste, say about 3 inches.
- C. $1\frac{1}{2}$ inch from line 3 draw line.
- D. $\frac{5}{8}$ inch from line C at the waist line.
- E. $2\frac{1}{2}$ inches from D.

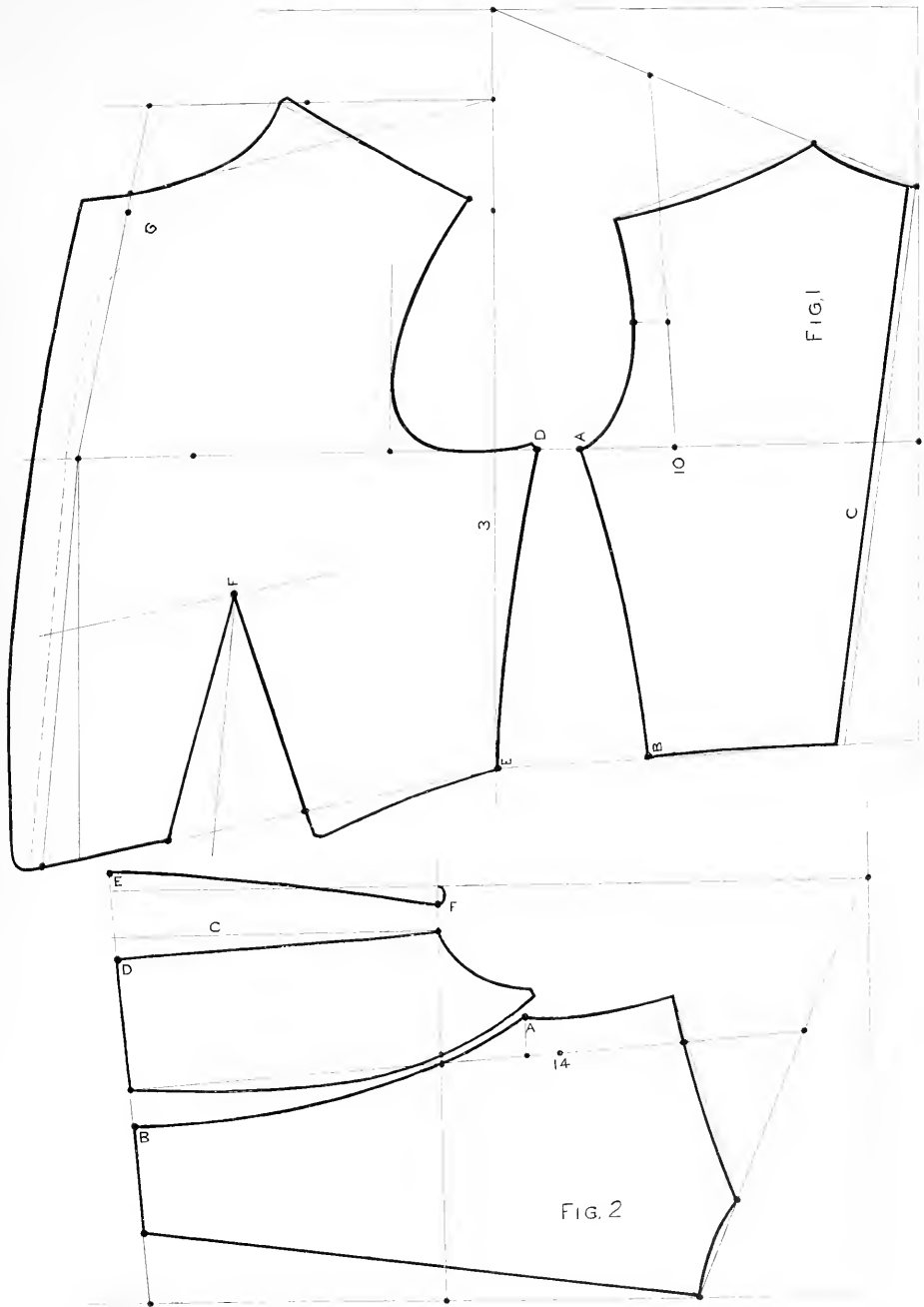

N. S. SHEIFER'S SYSTEM.



Drafting a Box Coat

- A. Take off $\frac{1}{2}$ seam $\frac{3}{8}$ inch from point 5.
- B. According to fullness of back, you may allow from $\frac{1}{2}$ to 2 inches outside of line 1 at the waist. Draw line down from A and B.
- C. Allow $\frac{3}{4}$ inch to height of neck.
- D. In center between line 3 and point 10.
- E. From line 3 to E $1\frac{1}{4}$ inches less than there is from line 3 to D.
- F. $1\frac{1}{4}$ inches from point D.
- G. $1\frac{1}{4}$ to $1\frac{1}{2}$ inches from point E. Draw line for back from D and E and for front from F and G.
- H. Allow 1 inch on neck shoulder point for Box Coat.
- I. $\frac{1}{2}$ inch from point 25.
- J. Length of coat, square line up with line 1.
- K. $\frac{1}{2}$ inch from line J.
- L. Measure from D to K (length of back) and apply same measure from F.
- M. For short coat, $1\frac{1}{2}$ inch and for long coat, $\frac{3}{4}$ inch from line J.
- N. $2\frac{1}{2}$ inches for single breasted.
- O. $3\frac{1}{2}$ to 4 inches for double breasted.
- P. Pocket 3 inches below waist line. Draw line down with arm-hole and place pocket $\frac{2}{3}$ toward front and $\frac{1}{3}$ toward back.
For full length loose coat at the bottom, cut the back not less than 18 inches and front 27 inches.

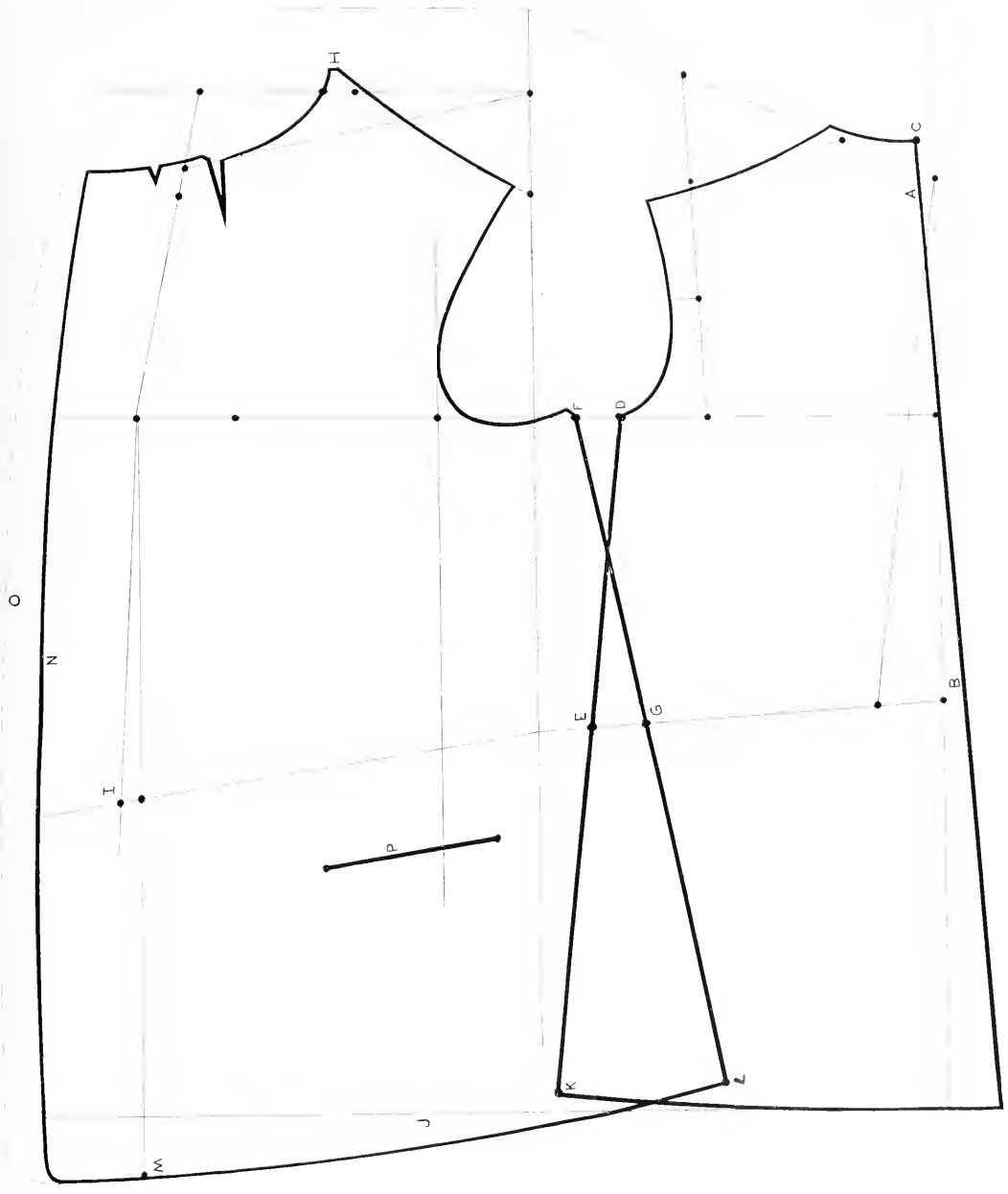

N. S. SHEIFER'S, SYSTEM.



Drafting a Semi-Fitting Coat

- A. $\frac{1}{2}$ inch from point 8.
- B. 1 inch from line 1.
- C. 1 inch below point 14.
- D. Width of back at waist, which is a matter of style and taste—say from 4 to $4\frac{1}{2}$ inches.
- E. Width of back at hip 1 inch wider than at waist.
- F. $\frac{1}{2}$ to $\frac{3}{4}$ inch from point D.
- G. Width of side gore, which is matter of taste, about $\frac{3}{4}$ inch from line 3. Draw line.
- H. $\frac{3}{8}$ inch from line G at the waist line.
- I. $1\frac{1}{2}$ inch from H to I at the waist line and take out seam $\frac{3}{4}$ inch between gore and front at the armhole.
- J. 1 inch from line G at the hip line.
- K. $1\frac{1}{2}$ inches from line G at the hip line. Draft front same as Box Coat. Dotted lines shows front semi-fitting cut with dart.
- L. Allow $1\frac{1}{2}$ inches.
- M. Dart line parallel with line L.
- N. From 2 to $2\frac{1}{2}$ inches for dart at waist line.
Take out at bottom of dart as much as there is at bottom from line 23 to line L.

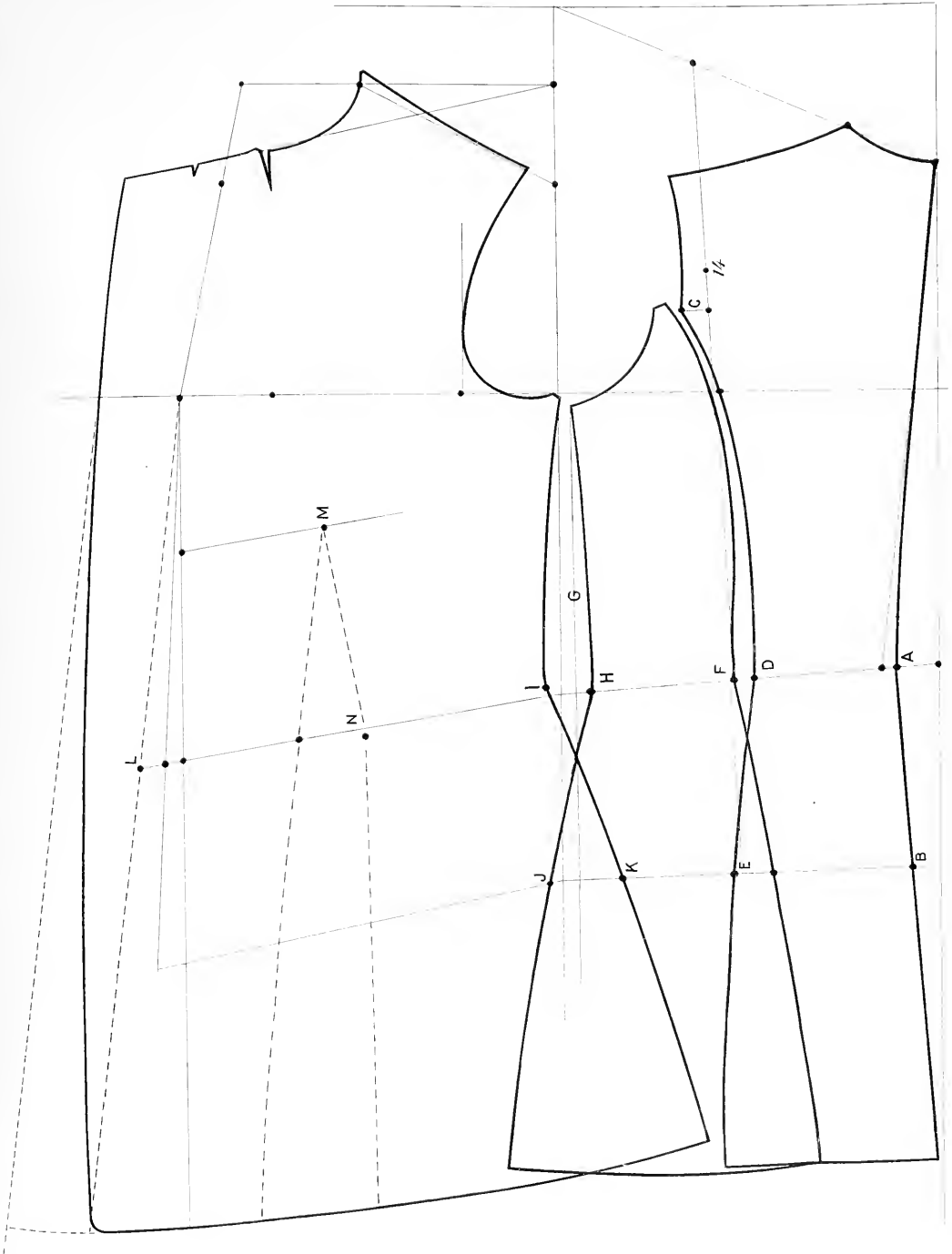

N. S. SHEIFER'S, SYSTEM.



Drafting a French-Seam Tight-Fitting Coat

- A. $1\frac{3}{4}$ inches from point 14.
- B. $2\frac{3}{8}$ inches from point 13.
- C. In center between point 11 and B draw line from C to width of back at waist. Curve in the back about $\frac{1}{4}$ inch from line.
- D. Take out $\frac{3}{8}$ inch from point C.
- E. From point 17 the same as from point 11 to C. Draft front from E to dart.
- F. Allow $\frac{3}{4}$ inch for seam from E.
- G. From F same as from D to B.

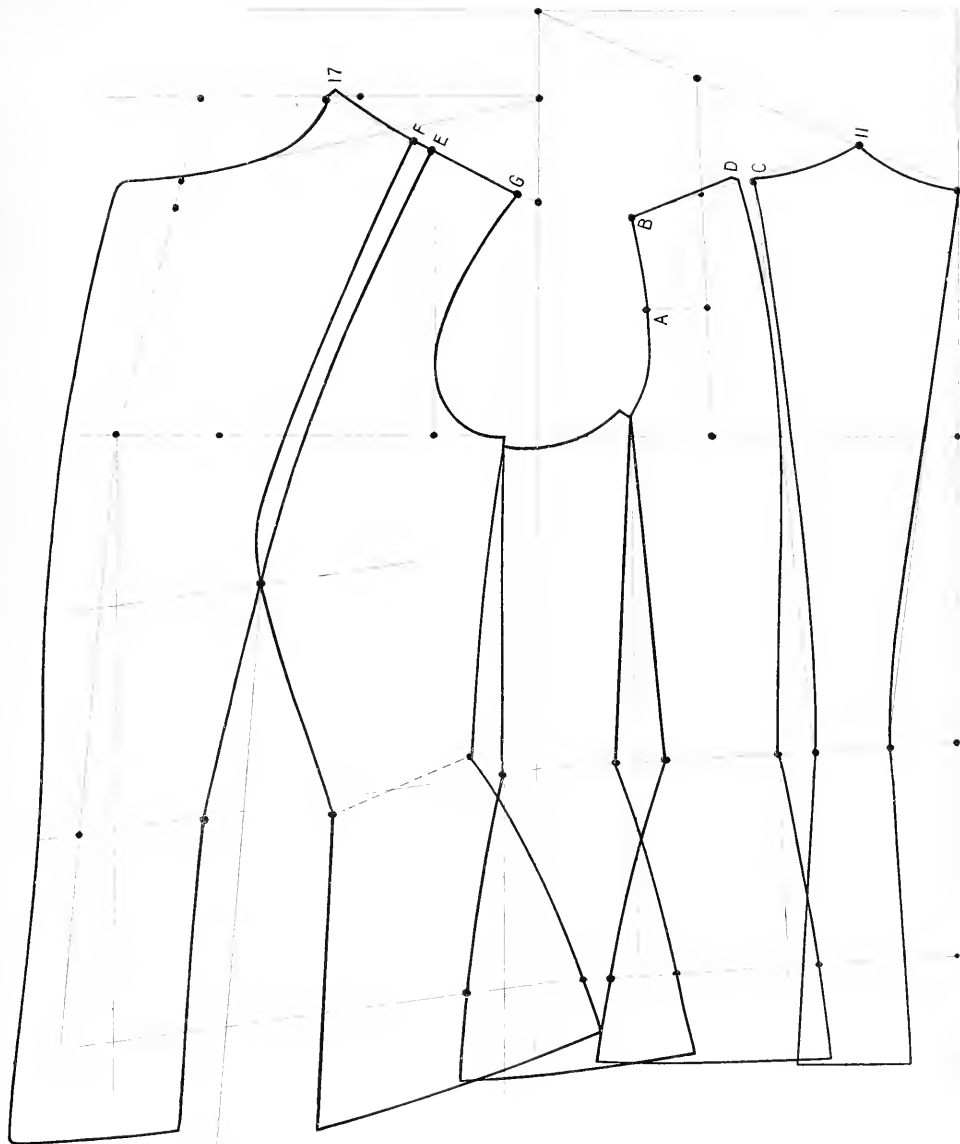

N.S. SHEIFER'S SYSTEM.



Drafting a Tight-Fitting Double French-Seam Coat

- A. If back without seam take off $\frac{3}{8}$ inch.
 - B. About $1\frac{1}{2}$ inches from point 11.
 - C. Width of back at the waist line, which is a matter of taste, say $1\frac{1}{2}$ inches finish—take half ($\frac{3}{4}$ inch) from line A at waist line.
 - D. Width of back at the hip $\frac{3}{4}$ inch wider than waist line.
 - E. $\frac{1}{4}$ inch from C. Draw line from B and E.
 - F. $1\frac{7}{8}$ inches from E, which is double the width as from line A to C at waist, and adding $\frac{3}{8}$ for $\frac{1}{2}$ seam.
 - G. Draw line from point 13 to F.
 - H. $\frac{3}{4}$ inch from line E at the hip line.
 - I. From H to I, 1 inch wider than from E to F.
 - J. $\frac{3}{4}$ inch from F.
 - K. $\frac{3}{8}$ inch from G.
 - L. 2 inches from K.
 - M. Measure the distance from 11 to B and allow $\frac{3}{8}$ inch for half seam, and apply same measure from point 17 to M.
 - N. Allow $\frac{3}{4}$ inch for seam from M to N.
 - O. Measure the distance from B to G and allow $\frac{3}{8}$ inch for half seam, apply same measure from N to O.
 - P. Allow $\frac{3}{4}$ inch for seam from O to P.
 - Q. From P the same measure as from K to L.
- Seams must be allowed to back from point B, $\frac{1}{2}$ seam on each part.

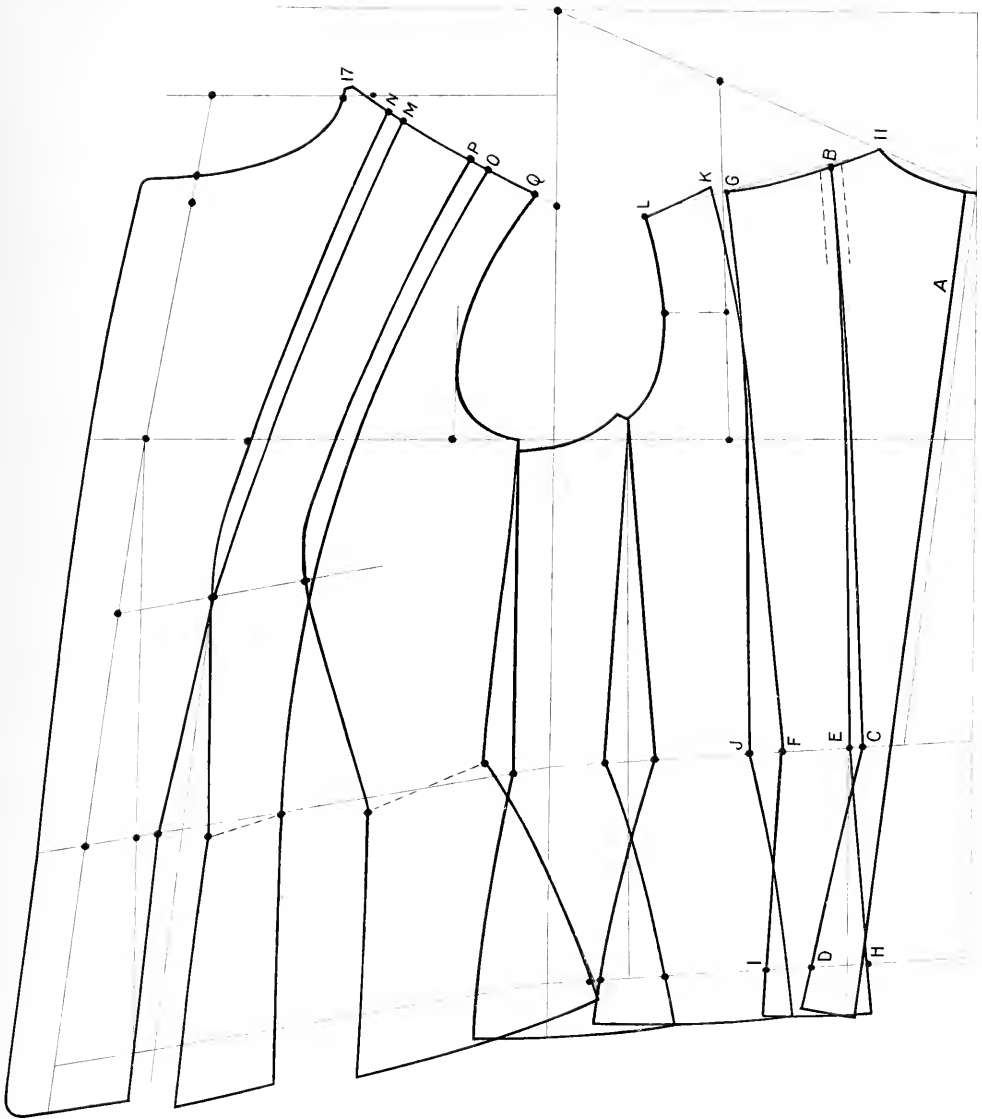

N. S. SHEIFER'S, SYSTEM.

Drafting a 17-Piece Corset Coat

Back drafted same as double French-seam coat.

- A.** $1\frac{1}{2}$ inches from line 3 draw line.
- B.** $\frac{3}{4}$ inch out for gore.
- C and D.** Divide in 3 parts between A and B, draw line for gores.
Take out at the waist line $\frac{1}{4}$ inch from each side of lines A and C.
Take out $\frac{1}{4}$ inch toward the front and $\frac{1}{2}$ inch toward the back of line D at the waist, so as to make the side gores equal width.
At the hip line allow $\frac{3}{4}$ inch on each side of lines A, B, C, D.
All these points are subject to measurements of waist and hip.
Tape measure should be applied on draft to prove if measurements are correct.
- E, F and G.** Divide in 4 parts between line A and front.
Draft the front darts as usual.
- H.** In centre, between A and dart, draw line from G and H.
- I.** $1\frac{1}{2}$ inches at the hip line from line A.
- J.** $\frac{1}{2}$ inch on each side of line H at the hip.
Have seams on shoulder to correspond same as double French-seam coat.
Allow for extra seams to back and for the extra seam on front and $\frac{1}{4}$ inch to each of the 3 gores to make up for the additional seam of a gore.

18-Piece Coat is drafted by having a seam in centre of back and making the width at the waist of back and next part the same width, say from $1\frac{1}{2}$ to $1\frac{5}{8}$ inch. All other parts drafted same as 17-piece coat.

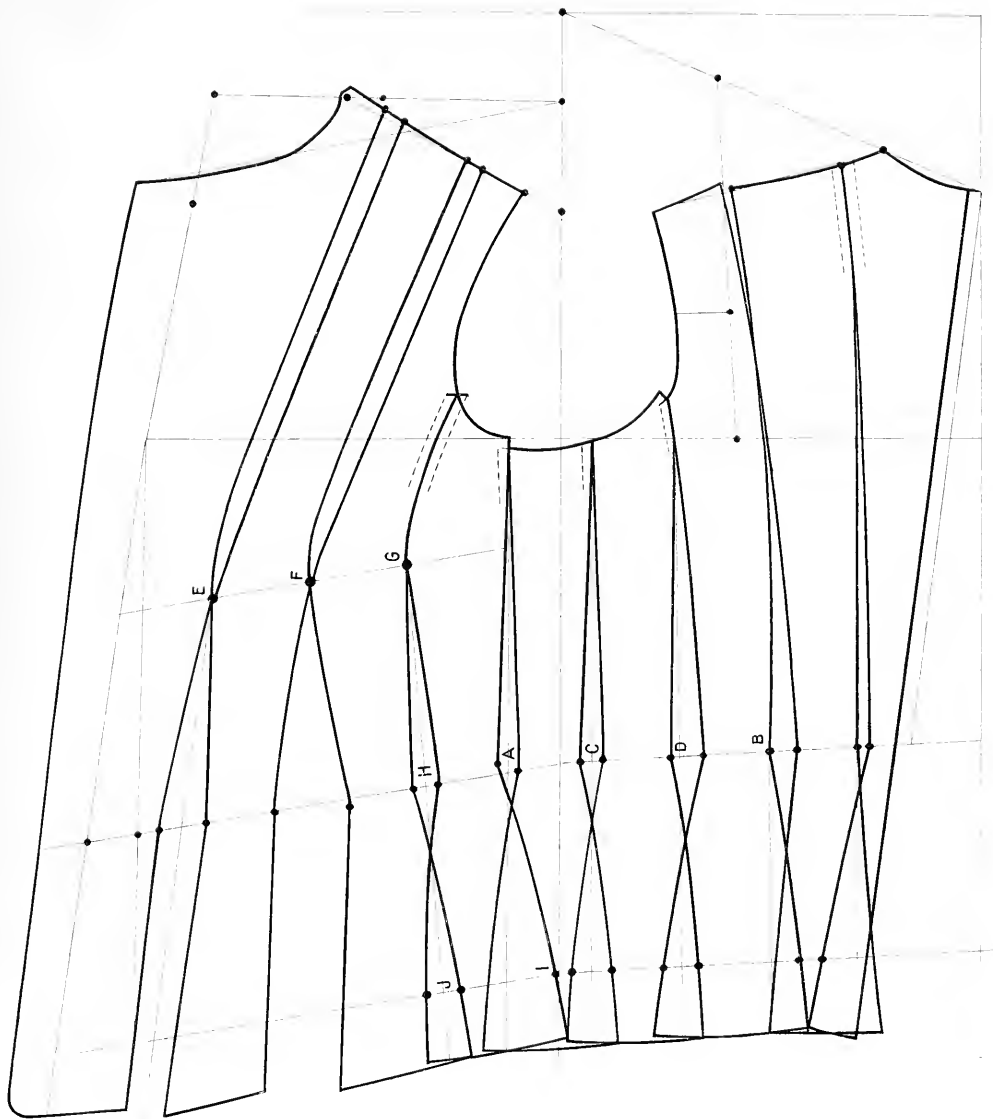

N.S. SHEIFER'S, SYSTEM.

Drafting a 22-Piece Corset Coat

- A. About 1 inch from point 11.
- B. Width of back at the waist, say 1 inch finish. Allow $\frac{3}{8}$ inch for $\frac{1}{2}$ seam. $1\frac{3}{8}$ inches.
- C. Width of back at the hip 1 inch wider than waist.
- D. $\frac{1}{4}$ inch from B.
- E. About $1\frac{3}{4}$ inches from A.
- F. 1 inch from D.
- G. $\frac{3}{4}$ inch from C at the hip line.
- H. 2 inches from G at the hip line.
- I. $\frac{1}{4}$ inch from F.
- J. From E to J, $\frac{1}{2}$ seam wider than from A to E.
- K. From I, $\frac{1}{2}$ seam wider than from D to F.
- L. $\frac{3}{4}$ inch from H at the hip line.
- M. From L, 1 inch wider than from I to K.
- N. $\frac{1}{2}$ inch from K at waist line. Divide gores same as 17- or 18-piece coat.
- P, Q, R, S. Divide front in 5 parts at the bust line.
- T. From point 17 same as from 11 to A, including allowance for half seam.
- U. Allow $\frac{3}{4}$ inch for seam from T.
- V. From U same as from A to E, including allowance for seam.
- W. Allow $\frac{3}{4}$ inch for seam from V.
- X. From W same as from E to J, including allowance for half seam.
- Y. Allow $\frac{3}{4}$ inch for seam from X.
- Z. Draw line from point P parallel with front. Now measure the width of front at waist line, and deduct the 4th part of waist measure, including 3 seams. Say you have 3 inches over, take out $\frac{3}{4}$ inch on first dart on waist line.
 - 1. $1\frac{3}{4}$ inches at waist line.
 - 2. $2\frac{1}{4}$ inches at hip line.
 - 3. 1 inch for second dart.
 - 4. $1\frac{3}{4}$ inches at waist line.
 - 5. $2\frac{1}{4}$ inches at hip line.
 - 6. $\frac{3}{4}$ inch third dart at waist line.
 - 7. $\frac{1}{2}$ inch balance of the 3 inches.
 - 8. $2\frac{1}{4}$ inches at hip line.

Make allowance for extra seams at the back on lines A and E, also extra seam for front on line S, and add $\frac{1}{4}$ inch for each of the 3 gores to make up shortage of one seam.

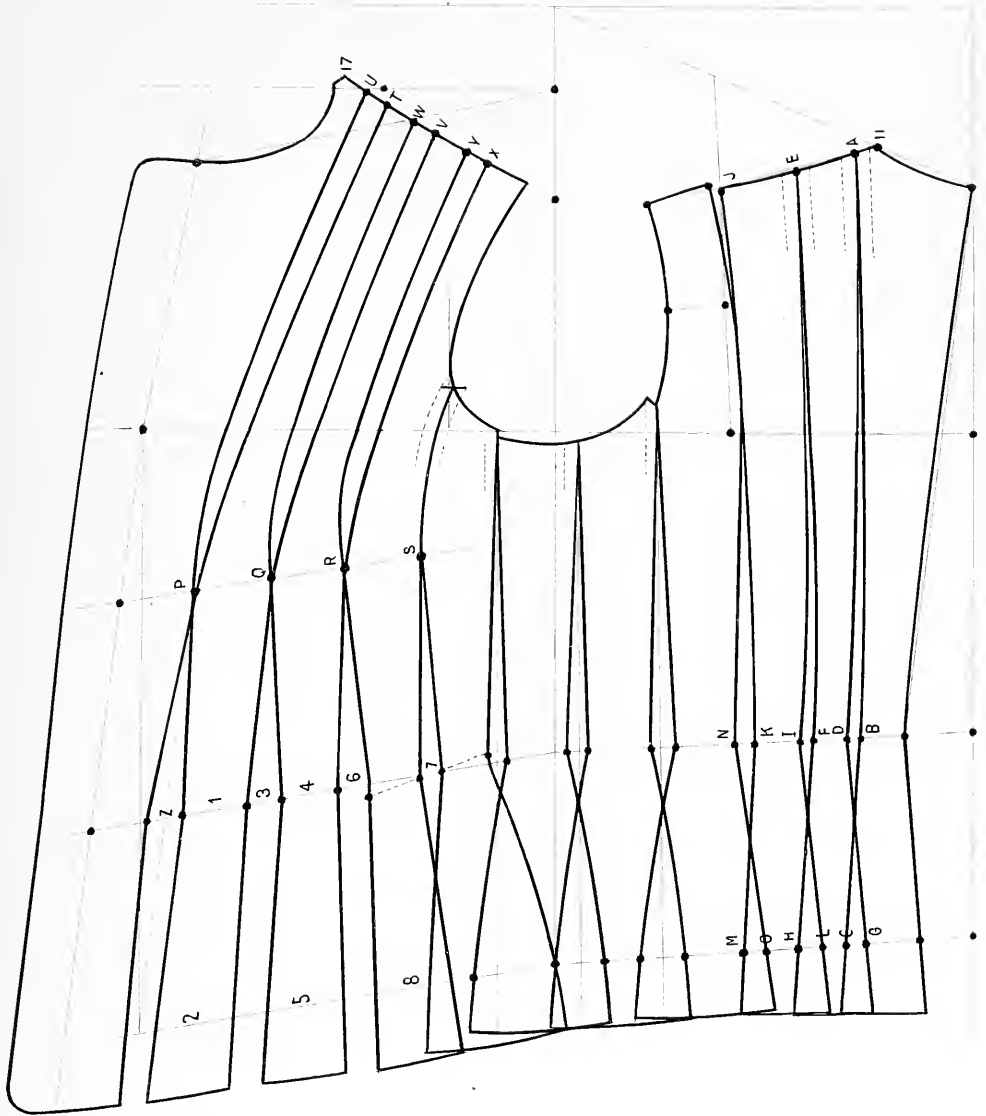

N.S. SHEIFERS'S SYSTEM.

Drafting a French-Seam Semi-Fitting Coat

- A. Allow $\frac{1}{2}$ inch from point 8.
- B. Width of back at the waist, which is a matter of taste, from 3 to $3\frac{1}{2}$ inches.
- C. Width of back at the shoulder about 4 inches.
- D. $\frac{1}{2}$ to $\frac{3}{4}$ inch from B.
- E. Width of side body, which is a matter of taste, from $\frac{3}{4}$ to $1\frac{1}{4}$ inch from line 3. Draw line.
- F. $\frac{3}{8}$ inch from line E at the waist line.
- G. $1\frac{1}{2}$ to 2 inches from F, take out seam $\frac{3}{4}$ inch between gore and front at the armhole. Front dart same as semi-fitting front; see that seams on shoulder correspond.

Dotted lines on back show how same coat is cut without seam in centre of back.
- H. Take off $\frac{3}{8}$ inch ($\frac{1}{2}$ seam) and draw line down. Width of back at waist from $2\frac{1}{2}$ to 3 inches.
- I. Width of back at hip 1 inch wider than waist, from line H.

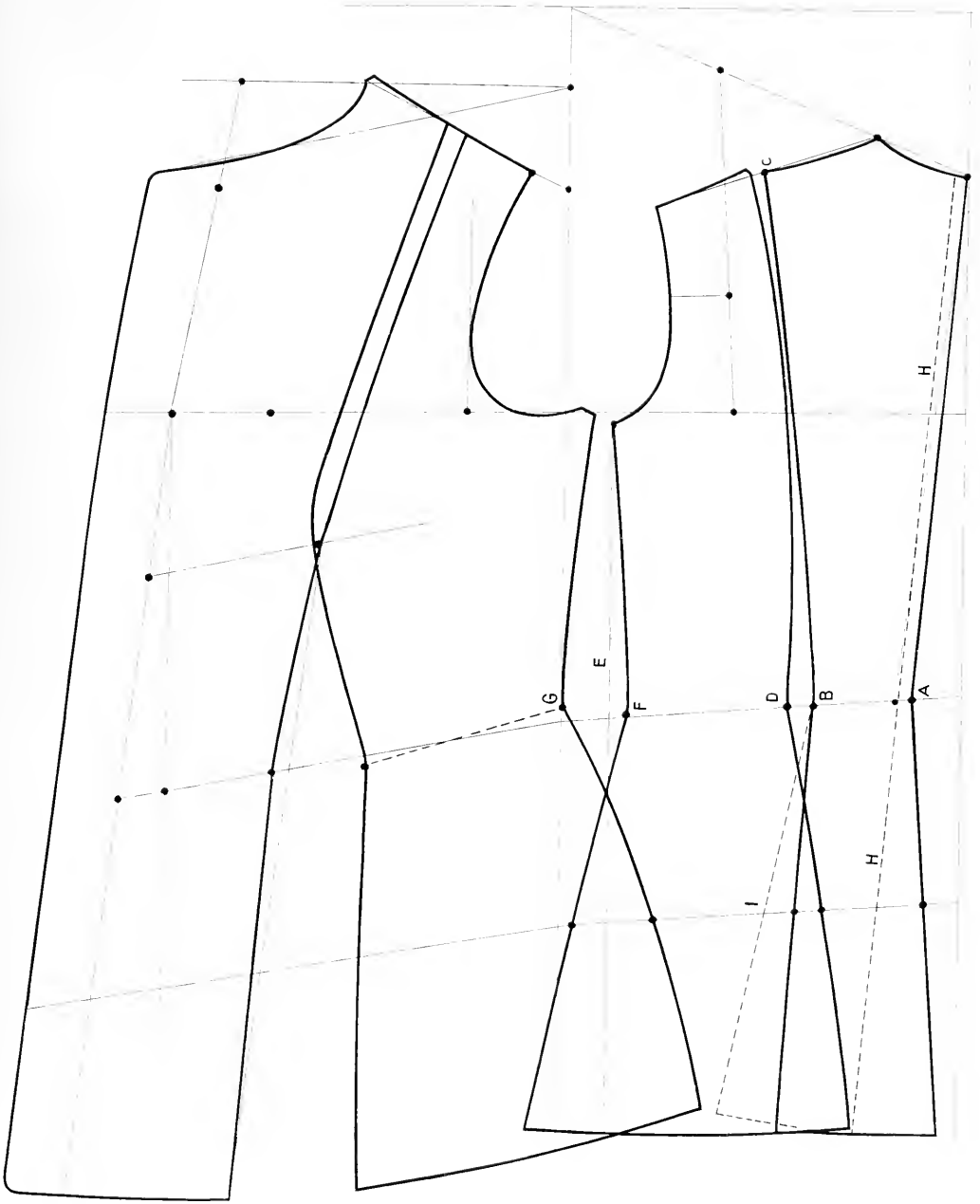

N. S. SHEIFERS' SYSTEM.

Drafting the Collars

Fig. 1. Notch or Shawl Collar

Draw line the length of lapel you desire to neck shoulder point, and draw line for stand of collar, say $1\frac{1}{2}$ inches.

A to B. Same width as width of back at the top of neck.

Fig. 2. Wide Shawl Suitable for Fur

A. 1 inch above neck shoulder point, draw line as deep as you want collar.

B. 1 inch from A.

C. Draft collar from B, touching line A and neck, and down to D. Width of collar according to style. Measure the distance from D to E and apply same from E to F, also from C to F must measure the same as from C to D.

G to H. Same as measure from neck shoulder point to B.

Fig. 3. Storm Collar

A. Square line. Height of Collar about 6 inches.

B. Neck measure and add 3 seams, and $\frac{3}{4}$ inch down.

C. Same width as neck at top of back.

D. From C to D same as from A to C.

E. 2 inches from A.

F. $1\frac{1}{4}$ inch from line A.

G and H. 1 inch on each side of line.

I and J. $\frac{3}{4}$ inch on each side of line.

Fig. 4. Standing Collar

Width of collar according to style.

A. Neck measure.

B. $\frac{3}{4}$ inch from A.

C. $\frac{1}{2}$ inch from line A.

Fig. 5. Stand and Turndown Collar.

Draft stand same as Fig. 4.

A. $1\frac{1}{2}$ inches for spring.

B. Curve the turn 1 inch from standing band.

Fig. 6. Sailor Collar

Place front and back together at the shoulder and draft collar as shown on diagram. Make allowance about 1 inch at the neck for stand of collar.

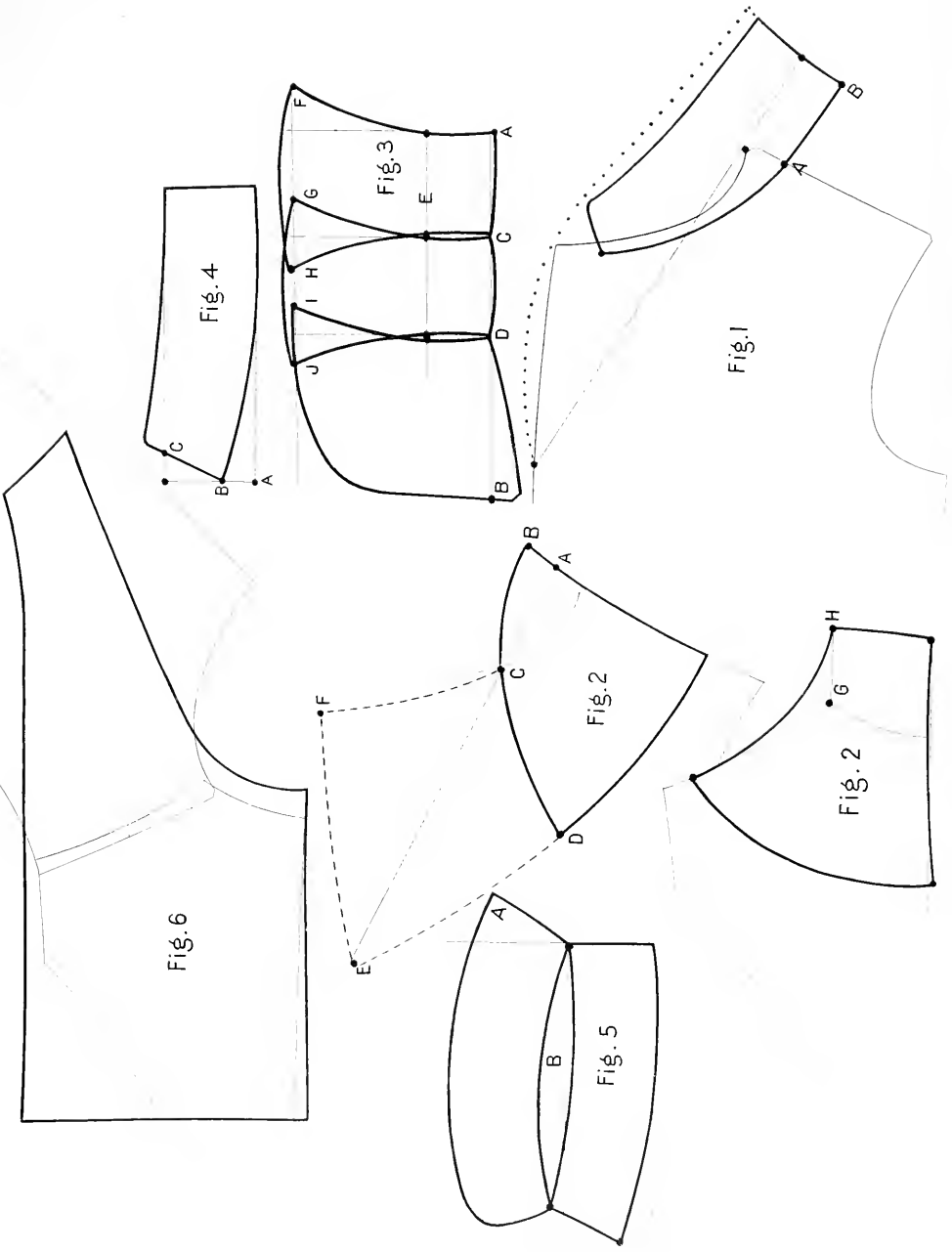

Drafting a Sleeve

Fig. 1.

1. Draw line.
 2. Square line by line 1.
 3. Blade measure $22\frac{1}{2}$. Apply one half ($11\frac{1}{4}$) and add 2 inches. $13\frac{1}{4}$ inches from line 1, draw line.
 4. Depth of arm 12 inches. Apply one half (6 inches) from line 2; draw line 4.
 5. Blade measure $22\frac{1}{2}$ inches. On scale No. 2, from line 3 on line 4.
 6. 2 inches from point 5.
 7. 2 inches from line 4 on line 1.
 8. Length of sleeve 30 inches, deduct depth of arm measure 12 inches, and apply 18 inches from line 4 on line 3.
 9. 1 inch from point 8.
 10. Width of sleeve at the wrist, according to style, say about 11 inches finish; apply $5\frac{1}{2}$ inches from 9.
 11. $1\frac{1}{2}$ inches for seams from 10.
 12. In centre between line 4 and point 8.
 13. From line 4, $1\frac{1}{2}$ inches lower than from line 4 to 12; draw line from 12 to 13.
 14. $1\frac{1}{2}$ inches from 12.
 15. In centre between 13 and 14.
 16. In centre between 13 and 15.
- Cut under sleeve $\frac{1}{2}$ inch longer at bottom. Dotted lines in front of sleeve show the allowance to upper sleeve and reduce as much for under sleeve.
- Cross points show the allowance for larger sleeve, which can be enlarged according to style.
17. Measure from point 16 to 7 and apply same from 16 to 17 and make allowance for head of sleeve according to style.

Fig. 2—Represents the sleeve cut in one piece.

- A. Place upper and under sleeve lapping over a seam as far as the elbow.
- B. Make allowance from 4 to 5 inches according to style.

Fig. 3—Represents the Bishop sleeve.

Split the one piece sleeve in centre and open on bottom according to what width you want; top of sleeve can be made smaller by lapping over one on the other.

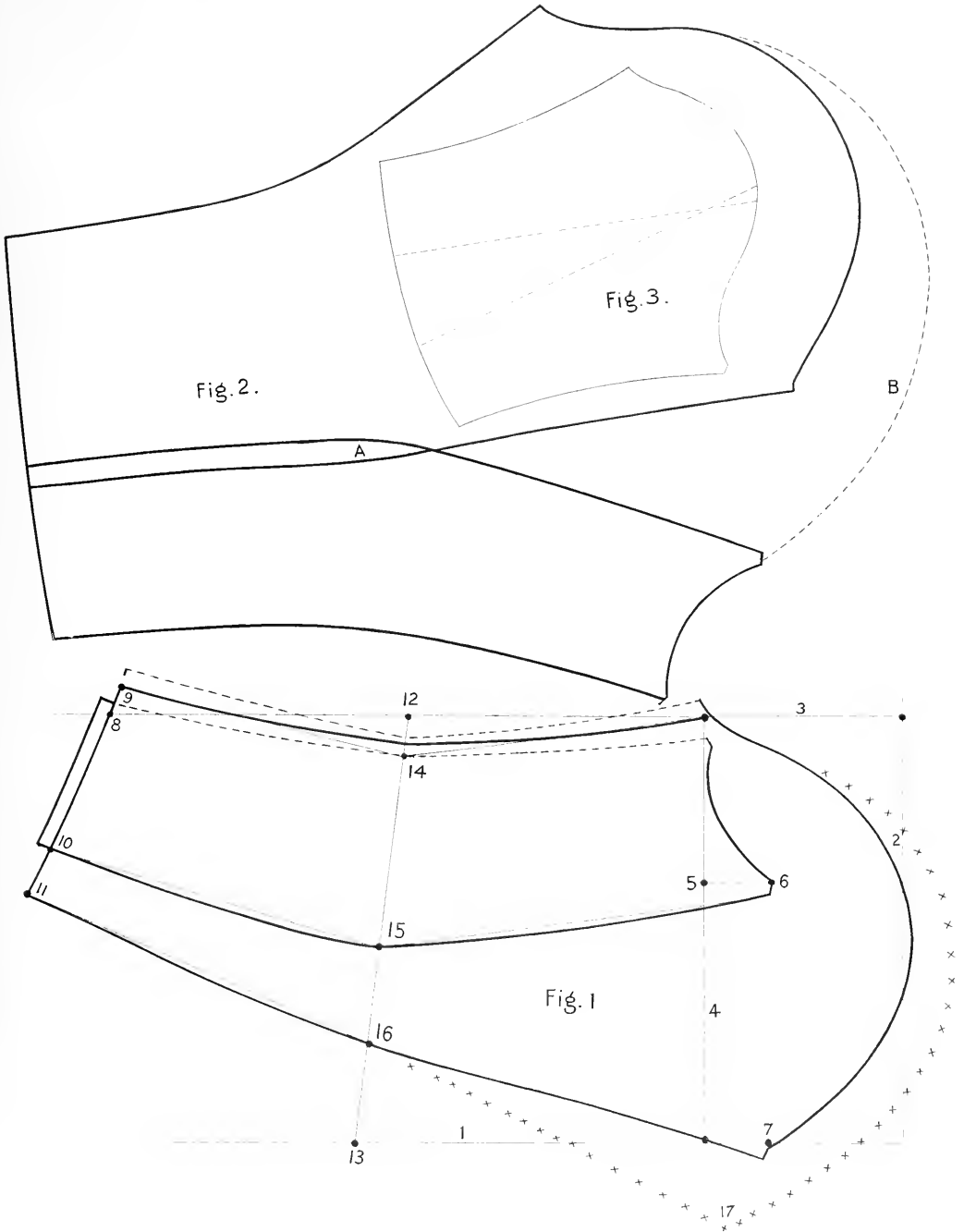

N. S. SHEIFERS' SYSTEM.

Drafting a Cape and Hood

Fig. 1.

Draw line.

- A. Place the back 2 inches from line at the waist
- B. Place the front and back together at the shoulder lapping over a seam.
- C. Cut neck of cape $\frac{1}{2}$ inch lower.

Cape length over shoulder to be cut from $2\frac{1}{2}$ to 3 inches longer than length of back and front.

Fig. 2—Drafting a Hood.

- D. Length of hood about 13 inches from neck.
- E. About 13 inches from D.
- F. About 4 inches from E and curve up about $1\frac{1}{2}$ inches.

Fig. 3.

This diagram shows how cape is reduced in sweep at bottom, by cutting with 2 darts on shoulder.

- G. Back dart same length and width as shoulder of back.
- H. $1\frac{1}{2}$ inch wide.
- I. 3 inches from G.

Reduce your sweep of cape at the bottom according to what width you require and allow for seams on shoulder darts.

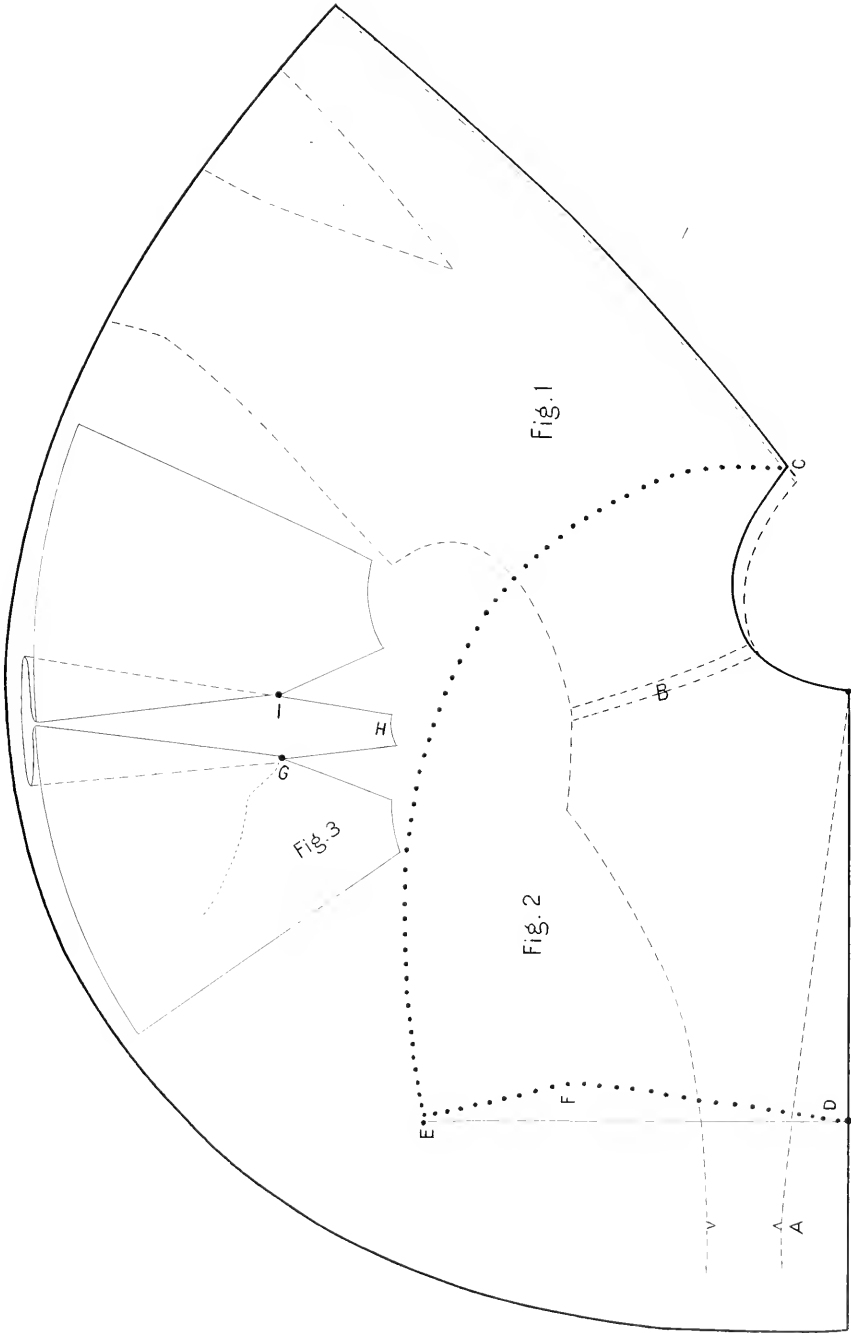

N. S. SHEIFER'S, SYSTEM.

Drafting a Skirt

Measurements

Waist	25
Hip	43
Front length	42
Side “	44
Back “	44 $\frac{1}{2}$

- A. Draw line.
- B. Square line by line A.
- C. Waist measure 25 inches. Apply half of measure and add 3 inches—15 $\frac{1}{2}$ inches from line A on line B.
- D. 3 $\frac{1}{2}$ inches from C draw line from D to cor. of lines A and B.
- E. Hip line 6 inches below waist line.
- F. Half of hip measure from line A on line E.
- G. Front length of skirt.
- H. Side length of skirt.
- I. Back length of skirt.
- J. Width of skirt at bottom. According to style. Draw line J from width at bottom touching point F.
- K. Width of front, which is a matter of style and taste, and depends on the number of gores.
- L. and M. If seven-gore skirt divide in 3 parts between K and line J. Now measure the distance between lines A and J at the waist, deduct half of waist measure and take out balance of measure between darts, making the strongest dart at the largest part of hip. All seams must be allowed for in skirt patterns.

Fig. 2. Shows how a skirt yoke is cut. Cut off the top of skirt to hip and place darts together, this will form the yoke.

A circular skirt can be cut from yoke by simply drawing lines down with front and back.

Fig. 3. Shows how skirt is divided into 13 gores, or you may divide in as many gores as you require.



N. S. SHEIFER'S, SYSTEM.

Extension of Length to a Short Coat

- A and B.** Place ruler $\frac{1}{4}$ inch from waist to the hip point and draw lines down.
- C and D.** Place ruler $\frac{3}{4}$ inch from waist to hip point and draw lines down.
- E and F.** Same as C and D.
- G.** Place ruler $1\frac{1}{2}$ inches from waist to hip point and draw line down.
- I and J.** Draw lines straight down with dart

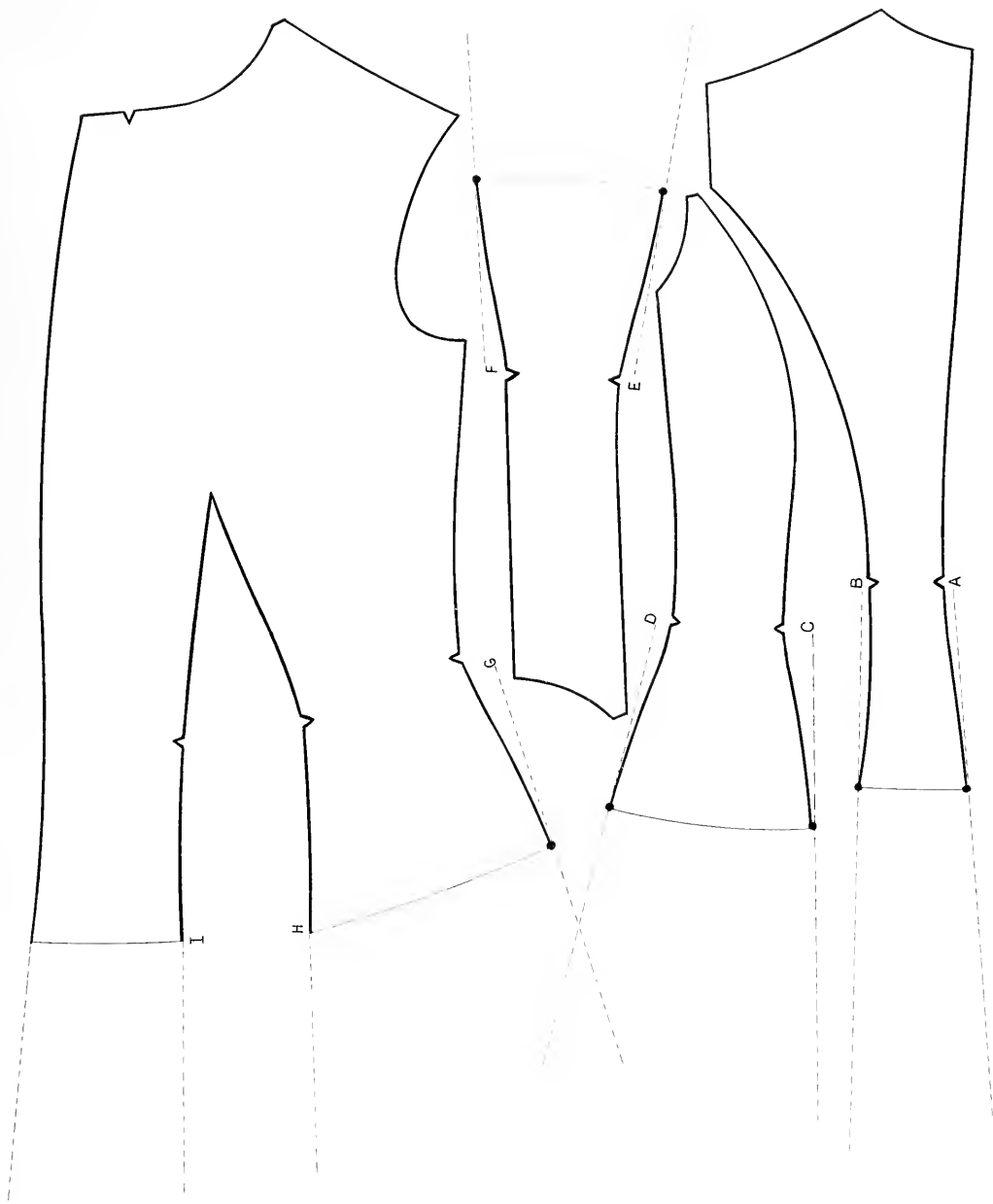

N. S. SHEIFER'S, SYSTEM.

Drafting a Skirt Coat

In cutting a skirt garment cut out the plain parts first to length you require.

- A. Place side gores together from waist, lapping over a seam.
- B. Place front and side gore $\frac{3}{4}$ inch apart $1\frac{1}{2}$ inches below waist and lap over a seam at the hip.
- C. Start skirt about 2 inches below waist. This is a matter of taste as you can bring the seam for skirt higher or lower. Skirt at point B should be shaped a little higher and make a dart at point B for the hip.
- D. Make the seam below waist for skirt in front about 1 inch lower than in back.
- E. From D same width as there is from 1 to 2 deducting a seam.

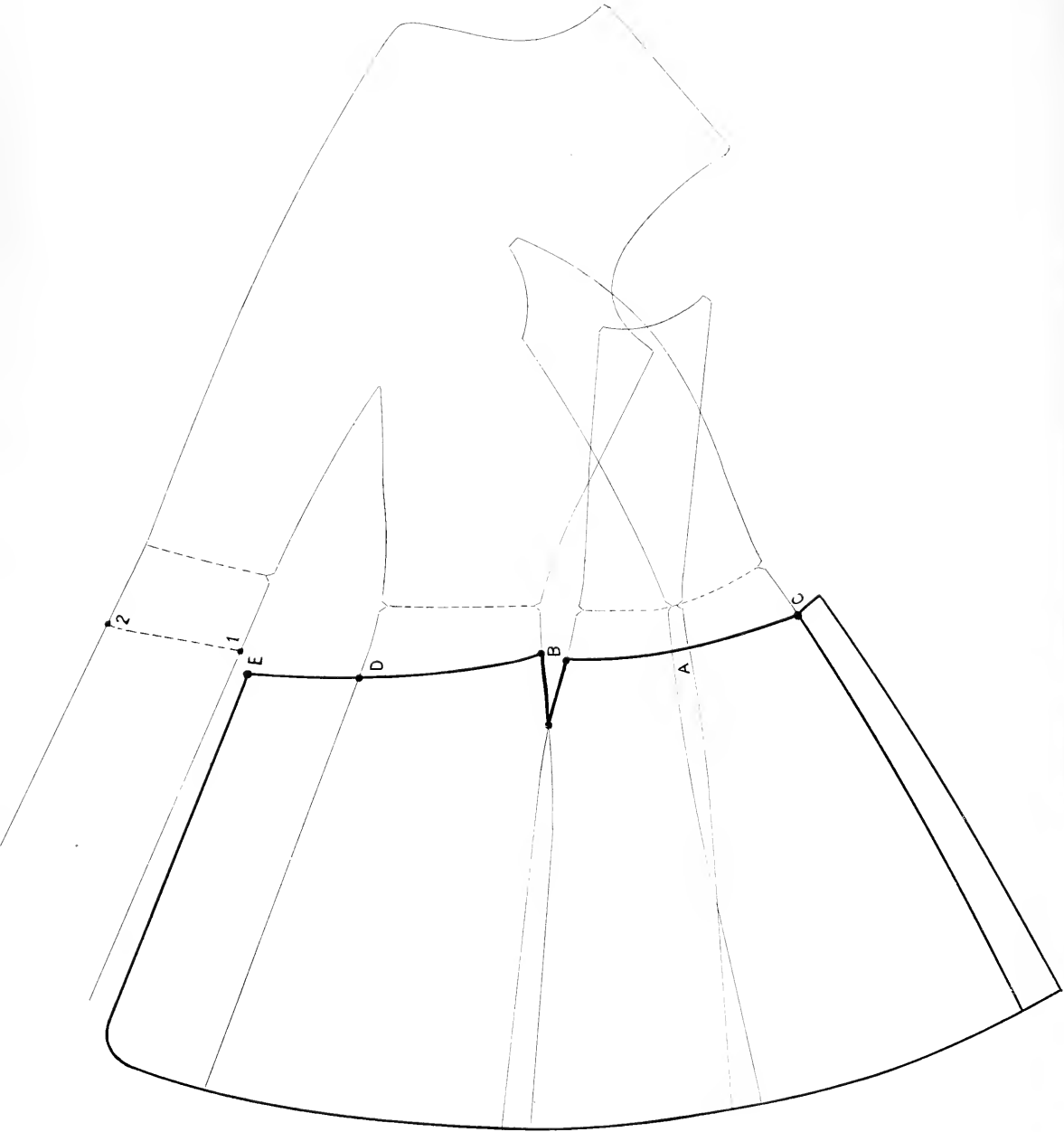

N. S. SHEIFER'S, SYSTEM.

Drafting Children's Garments

SIZE 8 OR ANY OTHER SIZE

1. Draw line.
2. Square line by line 1.
3. For size 8, bust measure $26\frac{1}{2}$ inches. Apply $26\frac{1}{2}$ on proportion scale. From line 1 draw line.
4. From line 2 same as from line 1 to 3 draw line.
5. Length of waist 12 inches for size 8. Apply $\frac{1}{2}$ inch less than half of waist, $5\frac{1}{2}$ inches from line 4 on line 1.
6. Length of waist 12 inches from 5 on line 1.
7. From line 2 the same as from line 2 to 6. Draw line straight up.
8. $1\frac{1}{2}$ inches.
- 9 and 10. From line 3 same number on scale 2 as it measures on scale 1 from 1 to 3.
- 11, 12, 13 and 14. In proportion the same as in Ladies.
15. 1 inch from line 1.
16. From 12 the same as from 10 to line 3.
17. Add $\frac{1}{2}$ inch.
18. From 12, $\frac{1}{3}$ the distance between 12 and line 4.
19. Half of bust.
20. Add 3 inches.
21. In proportion the same as in Ladies.
22. In proportion the same as in Ladies.
23. Square by line 4.
27. Hip line 4 inches below waist line.
 - A. $\frac{3}{4}$ inch.
 - B. $\frac{3}{4}$ inch.
 - C. Width of back at waist about 3 in.
 - D. Width of back at hip $\frac{3}{4}$ inch wider than waist.
 - E. $\frac{3}{4}$ inch from C.
 - F. About $\frac{3}{4}$ inch from line 3 draw line and take out at waist $\frac{3}{4}$ inch, $\frac{3}{8}$ inch on each side.

G and H. 1 inch on each side of line F on hip line.

J. $1\frac{1}{4}$ inch from line 23 at waist and draw line from 22.

Dotted lines show the box coat which is drafted in proportion the same as Ladies. Take out between back and front at the armhole $\frac{3}{4}$ inch and add to top of back at the neck $\frac{1}{2}$ inch.

Drafting the Children's Sleeve

Draw lines 1 and 2.

3. For size 8 bust measure $26\frac{1}{2}$, apply $26\frac{1}{2}$ on proportion scale. From line 1 draw line.
4. From line 2 one half of the distance that there is from 1 to 3. Draw line.
5. From line 3 on scale No. 2 the same number as it measures on scale 1, from 1 to 3.
6. $1\frac{1}{2}$ inches.
7. $1\frac{1}{2}$ inches.
8. Waist length and add $1\frac{1}{2}$ inches ($13\frac{1}{2}$ inches). From line 4.
9. $\frac{3}{4}$ inches from 8.
10. About $4\frac{1}{2}$ inches from 9.
11. $1\frac{1}{2}$ inches from 10.
12. In centre between line 4 and 8.
13. From line 4, 1 inch lower as from line 4 to 12.
14. 1 inch from 12.
15. In centre between 14 and 13.
16. In centre between 13 and 15.

In drafting Misses' patterns you follow the same instructions as on Ladies.

The measurements for size 16 is as follows:

$21\frac{1}{2}$ — $6\frac{3}{4}$ — 15 — $7\frac{3}{4}$ — $11\frac{1}{2}$ — 20
 29 — 15 — $22\frac{1}{2}$ — 36 — 24 — 41

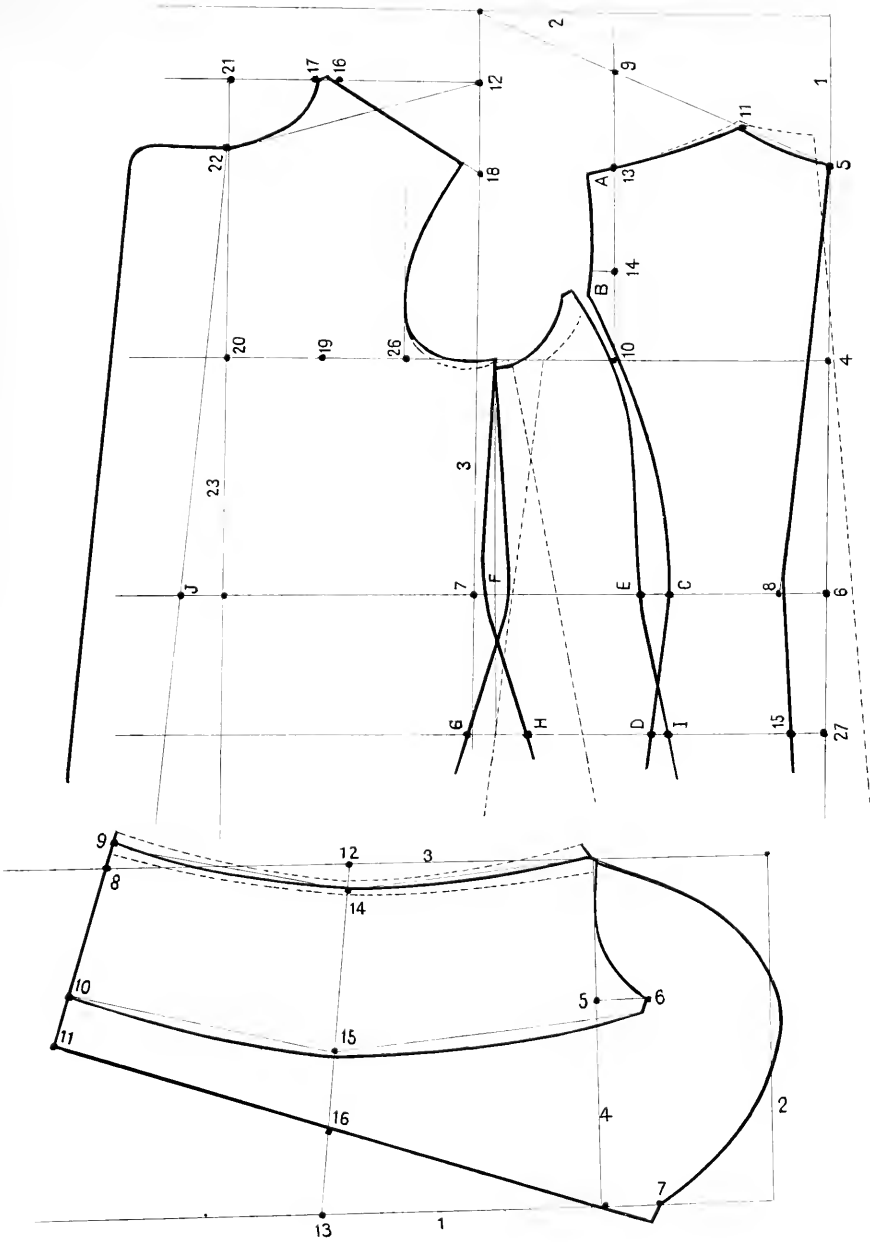

N. S. SHEIFER'S SYSTEM.

Grading Patterns of Ladies' Garments

Add to larger and reduce smaller sizes.

Grading the Back

- A. $\frac{1}{8}$ inch for width of neck at the top of back.
- B. $\frac{1}{4}$ inch for width of back.
- C. $\frac{1}{4}$ inch in width of back and $\frac{1}{8}$ inch in height. For sizes below 36 you can make the waist $\frac{1}{4}$ inch shorter at top of back.
- D. For tight-fitting add $\frac{1}{8}$ inch for width at waist line.

Grading the Gores

- E and F. For 2 side-gores to pattern add $\frac{1}{8}$ inch to each in width. For 1 gore add $\frac{1}{4}$ inch to width.

Grading the Front

- G. $\frac{1}{4}$ inch from neck shoulder point.
It is not advisable to increase the height of shoulder above size 36 as the 36 size is cut so large at the present time. Add the $\frac{1}{4}$ inch (point G) parallel with shoulder, which makes the neck shoulder point higher from size to size. For sizes below 36 you can reduce the height of shoulder $\frac{1}{8}$ inch.
- H. Width of shoulder $\frac{1}{8}$ inch size to size.
- I. Armhole $\frac{3}{16}$ inch.
- J. $\frac{1}{2}$ inch for width of front.
- K. From G $\frac{1}{8}$ inch for neck for each size.
- L. Dart $\frac{1}{4}$ inch.

Grading the Sleeve

- M. $\frac{3}{8}$ inch in width and $\frac{1}{8}$ inch in height.
- N. $\frac{3}{16}$ inch in width.
- O. $\frac{3}{16}$ in width and $\frac{1}{8}$ inch in height.
- P. $\frac{3}{16}$ inch in width.

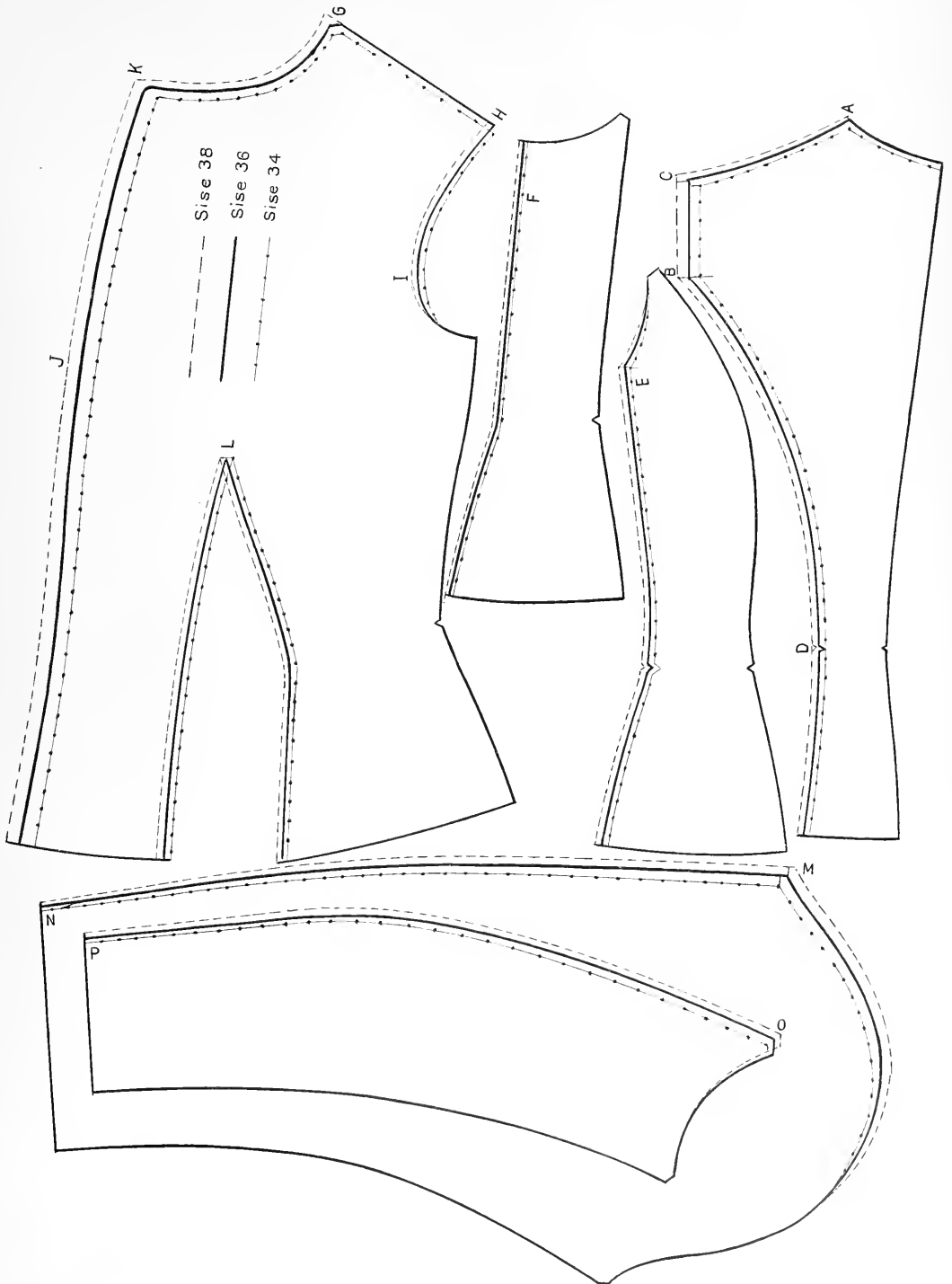

N. S. SHEIFERS' SYSTEM.

Grading the French-Seam Pattern

- A. $\frac{1}{8}$ inch for width of neck at the top of back.
- B. $\frac{3}{16}$ inch in width and $\frac{1}{8}$ inch in height.
- C. $\frac{1}{8}$ inch in width.
- D. If 2 gores, $\frac{1}{8}$ inch in width, and if 1 gore, $\frac{1}{4}$ inch.
- E. $\frac{1}{8}$ inch in height.
- F. $\frac{3}{16}$ inch in width.
- G. $\frac{1}{4}$ inch in width
- H. $\frac{3}{16}$ inch in width of shoulder.

For sizes below 36 make shoulder $\frac{1}{8}$ inch lower.

- I. $\frac{3}{16}$ inch in width.
- J. $\frac{1}{4}$ inch in width. Neck $\frac{1}{8}$ inch size to size. Lengths of front must be matched from shoulder and make allowance for larger and reduce for smaller sizes. See diagram.

Grading the back where there are 2 parts to pattern back and front, Eton or Box Coat.

- K. $\frac{1}{4}$ inch in width of back.
- L. $\frac{1}{2}$ inch in width of underarm seam. Grade front as usual.
- M. This diagram shows how armholes in sizes from 40 up in all patterns and styles should be cut down, $\frac{1}{4}$ inch from each size to the other, so as to make armholes larger and underarm lengths shorter for large sizes.

It is also advisable to make a little more allowance for the fronts of size 44 from waist down to front and in darts.

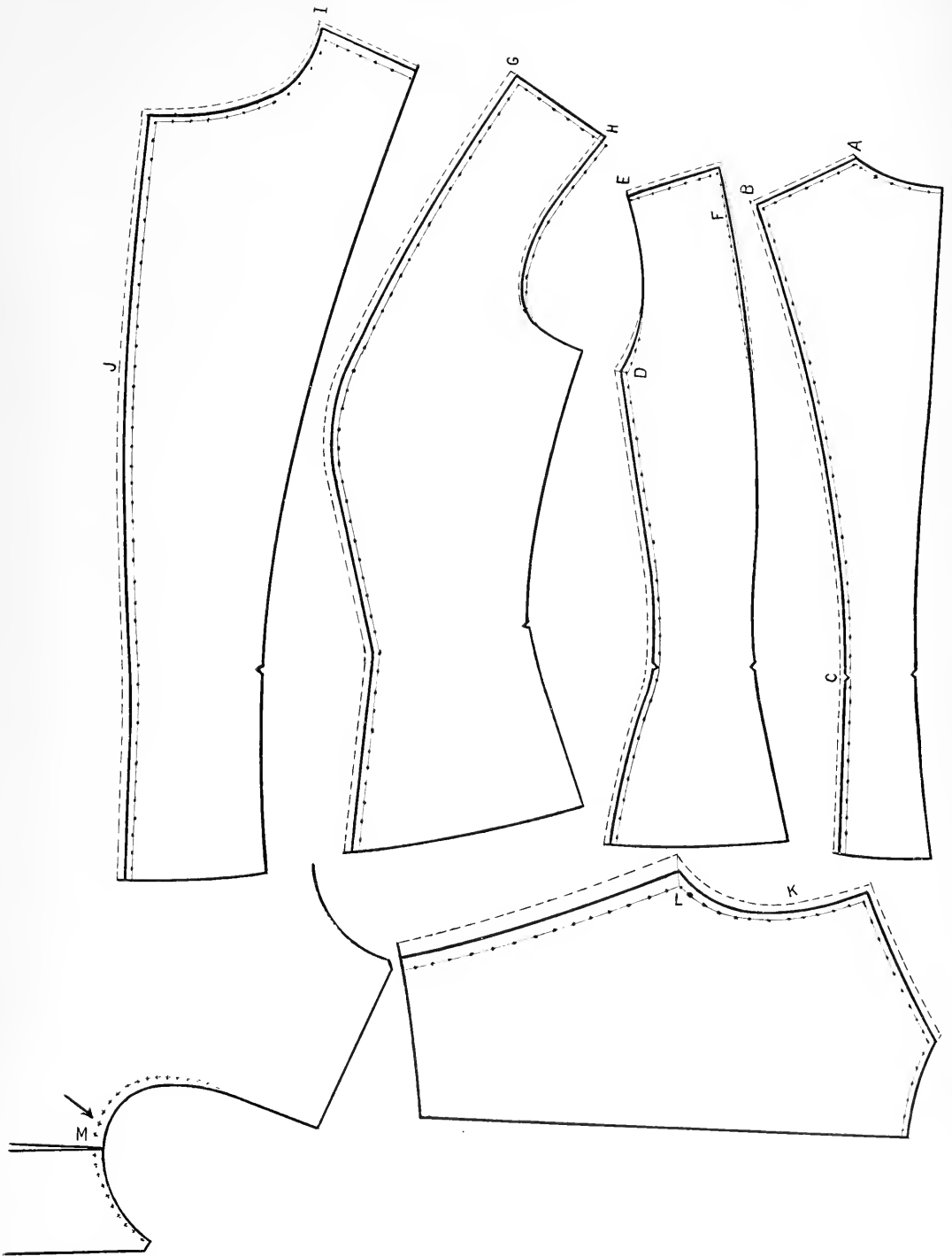

N.S. SHEIFERS, SYSTEM.

Grading Misses' Patterns

Back

- A. $\frac{1}{8}$ inch in height of neck.
- B. $\frac{1}{8}$ inch in width of neck.
- C. $\frac{1}{4}$ inch in width of back.
- D. $\frac{1}{4}$ inch in width and $\frac{1}{8}$ inch in height.
- E. Length of waist $\frac{1}{2}$ from A. Width of back at the waist for tight-fitting garments should be made same width for all misses' sizes.

Side Gores

- F. $\frac{1}{8}$ in height and $\frac{1}{8}$ inch in width all the way down.
- G. From F to G to correspond in length with back from C to waist line..
- H. $\frac{1}{8}$ inch in height and $\frac{1}{8}$ inch in width.
- I. From H to I to correspond in length with back gore. If one gore to pattern, add $\frac{1}{4}$ inch in height and $\frac{1}{4}$ inch in width at point F.

Front

- J. $\frac{1}{4}$ inch in width and $\frac{1}{4}$ inch in height of neck shoulder point.
- K. $\frac{1}{2}$ inch for width of front.
- L. Neck $\frac{1}{8}$ inch for each size.
- M. Shoulder in width to correspond with back shoulder.
- N. $\frac{1}{4}$ inch for armhole.
- O. Underarm length to correspond with gore.
- P. Dart $\frac{1}{4}$ inch in width. Cut dart at waist $\frac{1}{4}$ inch larger for large sizes.

Grading Children's Patterns

- Q. $\frac{1}{4}$ inch in height. Width same as Misses.
- R. $\frac{1}{2}$ inch for length of waist. Keep width of back at waist same width for all children sizes, with exception of loose back, where allowance must be made all the way down.
- S. $\frac{1}{8}$ inch in height and $\frac{1}{8}$ inch width.
- T. From S to T to correspond in length with back.
- U. $\frac{1}{4}$ inch in width and $\frac{1}{4}$ inch in height of neck shoulder point.
- V. $\frac{1}{2}$ inch for width of front. For smaller sizes you may reduce less than $\frac{1}{2}$ inch at waist so as to leave more width for the abdomen of smaller children.
- W. Underarm length to correspond with gore length.

Grading Misses' and Children's Sleeves

Grade the width same as Ladies' sizes. For the lengths add and reduce $\frac{1}{2}$ inch to Misses', $\frac{1}{4}$ inch from elbow up and $\frac{1}{4}$ from elbow down. For children's lengths add $\frac{1}{2}$ inch, $\frac{1}{2}$ inch from elbow up and $\frac{1}{2}$ inch from elbow down.

The proportions for lengths of Misses' and Children's garments depend generally on the trade of the manufacturer and is mostly furnished by the house to the designer.

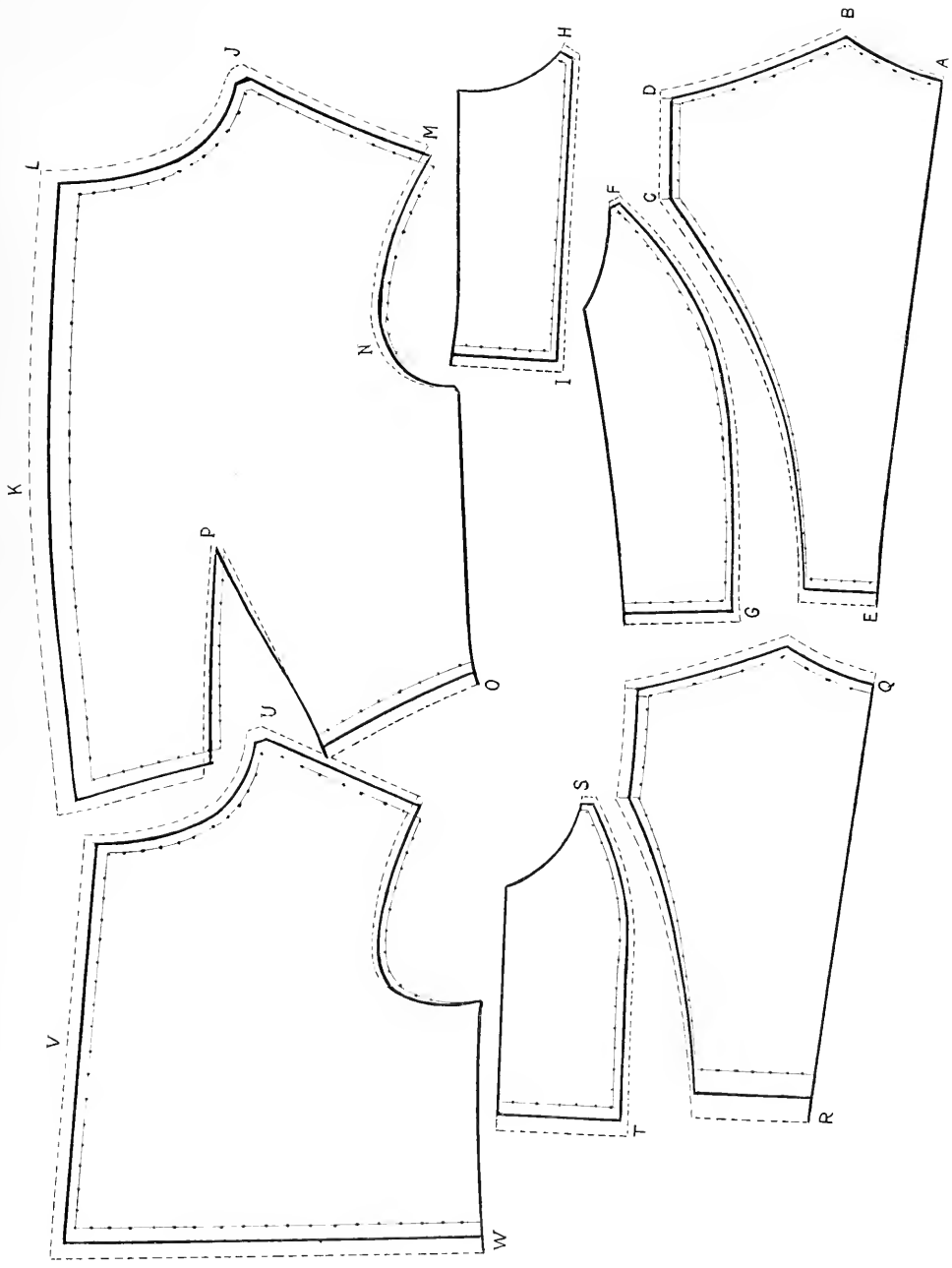

N. S. SHEIFERS, SYSTEM.

Drafting a Pattern Without Seams Allowed on such as Suitable for Fine Ladies' Tailoring

- A. On scale No. 3 one number less; instead of 5 apply 4.
- B. In thirds one number lower.
- C. Width of back at waist about $1\frac{1}{4}$ inches.
- D. About 2 inches from point 10.
- E. $1\frac{1}{2}$ inches below line 3 draw line and divide gores from E; take out at waist line according to waist measure which must be $\frac{1}{4}$ of waist measure from E including the back.
- F. Blade measure on scale No. 2, $1\frac{1}{4}$ inches less from line 3.
- G. Add $\frac{3}{4}$ inch to half of bust measure
- H. From F $\frac{1}{3}$ part as there is from line 3 to G.
- I. $\frac{3}{4}$ inch from line 3 for armhole.
- J. 1 inch above point 18 for shoulder.
- K. This point is a matter of taste. Dart can be placed either further to front or back.

Dart at waist to be taken out according to measure. Front must have $\frac{1}{4}$ of waist measure at the waist.

All other styles patterns without seams can be cut the same way in proportion.

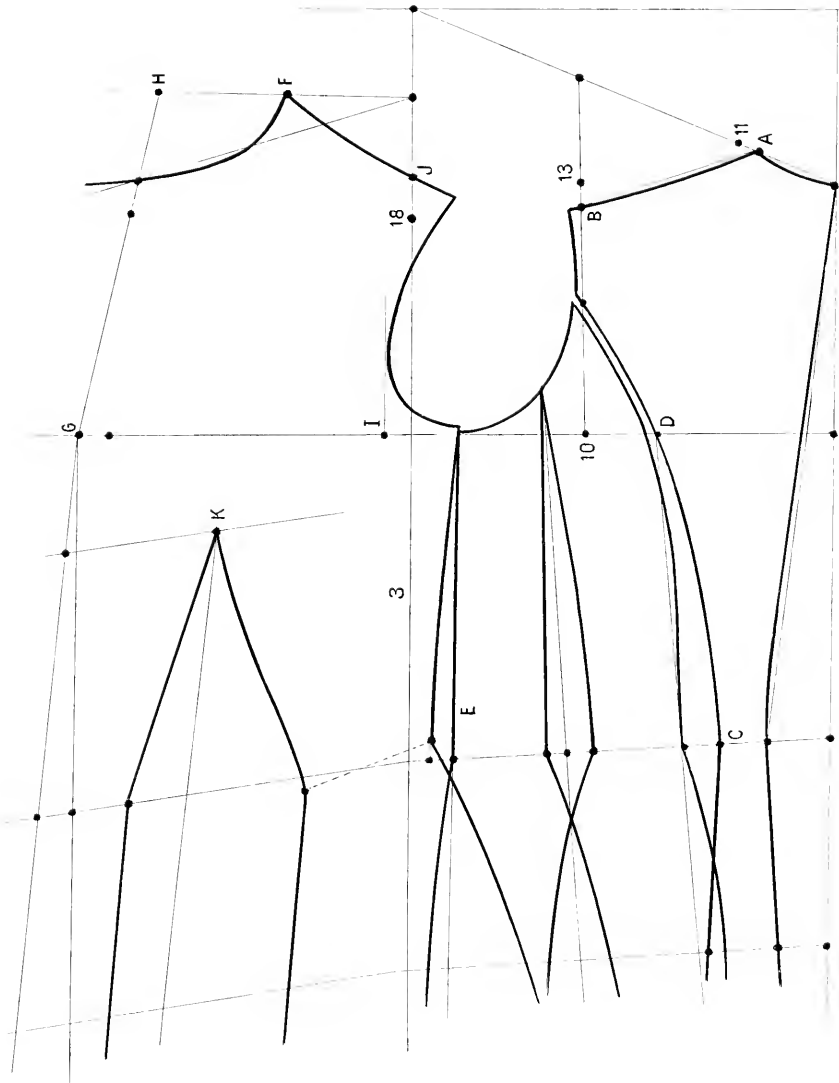

N.S. SHEIFER'S, SYSTEM.



JUN 1 1908



LIBRARY OF CONGRESS



0 013 973 189 A 6