

WAR DEPARTMENT

BASIC FIELD MANUAL



**DOG TEAM
TRANSPORTATION**

FM 25-6

BASIC FIELD MANUAL



DOG TEAM TRANSPORTATION

Prepared under direction of the
Chief of Infantry



**UNITED STATES
GOVERNMENT PRINTING OFFICE
WASHINGTON : 1941**

WAR DEPARTMENT,
WASHINGTON, January 4, 1941.

FM 25-6, Basic Field Manual, Dog Team Transportation, is published for the information and guidance of all concerned.

[A. G. 062.11 (12-27-39).]

BY ORDER OF THE SECRETARY OF WAR:

G. C. MARSHALL,
Chief of Staff.

OFFICIAL:

E. S. ADAMS,
*Major General,
The Adjutant General.*

TABLE OF CONTENTS

	Paragraphs	Page
CHAPTER 1. SLED DOG.....	1-5	1
CHAPTER 2. EQUIPMENT.		
Section I. Harness.....	6-13	5
II. Sleds.....	14-18	15
CHAPTER 3. KENNEL MANAGEMENT.		
Section I. Personnel, administration, and facilities.....	19-24	22
II. Feeding and care.....	25-29	26
III. Training.....	30-40	29
CHAPTER 4. FIELD MANAGEMENT.....	41-50	37
CHAPTER 5. PHYSIOLOGY AND HYGIENE.		
Section I. Anatomy, breeding, weaning, spaying, etc., and treatment.....	51-53	43
II. Prevention and first-aid treatment of disease and injuries.....	54-64	49
CHAPTER 6. TRANSPORTATION OF DOG TEAMS.....	65-67	66
CHAPTER 7. LOADS AND LOADING.		
Section I. General.....	68-70	68
II. Specific loads for a detachment of Infantry.....	71-74	70
Index.....		75

BASIC FIELD MANUAL

DOG TEAM TRANSPORTATION

(This manual supersedes TR 1380-20, June 15, 1926)

CHAPTER 1

SLED DOG

■ 1. USE OF DOG TEAMS.—Dog transportation is useful under conditions of snow and ice which preclude the use of horses, mules, or motorized transportation. Dogs can pull loads across country and along difficult trails where crusted or windswept snow is solid enough to support the sled on its runners. Dry snow and cold dry weather are most favorable for dog transportation. When snow is soft, a trail must be broken for the dogs and sleds by marching men, preferably wearing snowshoes. Wet snow, even if only a few inches deep, may prevent movement entirely by sticking to the snowshoes of men breaking trail and by gathering in masses under the sled. Light, damp snow adds greatly to the difficulty of movement by clinging to the sled runners. A sled that has halted may adhere to damp snow so tightly that the efforts of several men are required to "break it out" before the dogs can resume the march.

■ 2. CLASSIFICATION.—In general, dog transportation is classified into two groups according to speed: Messenger or courier teams which are composed of fast-running dogs and freight teams which are trained to slower gaits under heavier loads. Unlike the horse, the trained sled dog has only one gait which he endeavors to hold under all conditions. Difficult conditions of weather or steep grades necessitate frequent halts and reduce the average rate of march; but unless the team is very tired, a brisk gait will be the rule. Accordingly, sled transportation will move by bounds in rear of marching troops and men cannot accompany a sled on foot for a greater distance than they can move at a run.

a. Messenger teams.—(1) Fast teams are used when speedy communication is necessary, and for emergencies such as relief expeditions and the rapid transportation of sick or medical supplies. Rescue parties for airplanes that have made forced landings in isolated places usually employ fast dog teams. The rate and length of marches vary greatly. When fresh, a team moving under good conditions will exceed a rate of 10 miles per hour and will average from 5 to 6 miles per hour for an 8-hour day.

(2) Messenger teams should not be overloaded and forced to slower gaits. A slower gait soon becomes habitual with them and fast service cannot be resumed. Feed pans, dog chains, the driver's equipment, tools, and rations comprise a load which can seldom be reduced below 25 pounds per dog. The urgency of the mission and other conditions will necessitate certain loading which will in turn affect the length and rate of march.

b. Freight teams.—Freight teams are used for transportation of equipment and supplies. Personnel of equal weight may be substituted when desired. Under average conditions of trail and weather, teams will travel at a rate of 4 to 6 miles per hour, but for an 8-hour day frequent halts, which are necessary, reduce the average rate to about 3 miles per hour. Freight teams under average conditions of trail and weather can pull a useful load of 100 pounds for every dog in excess of three. The three dogs will provide for the sled, the driver, and his personal equipment, tools, chains, feed pans, and rations. It is difficult to establish a rule as conditions are subject to great variation. Loads twice as heavy as provided by the above formula are within the capabilities of dogs for short distances or on level trails. Steep hills and difficult places may be passed by unloading a part of the load and returning for it after transporting the first part over the hard stretch.

■ 3. TYPES OF DOGS.—*a.* A medium-sized dog may be put to general utility. However, an alert, long-legged, rangy type is preferable for courier service. A dog of sturdy conformation, blocky, short-coupled, and stolid, however nimble, will not be able to keep up with fast dogs on long trips and should be

employed for freighting with slower dogs. One dog of this type in a fast team will not only reduce the rate of travel but will annoy and disorganize the teamwork of the others. Very large, heavy, and slow-moving freight dogs are not well adapted to military use.

b. An all-purpose sled dog, well adapted to military service, would fill the following description: Short-haired, weighing from 80 to 95 pounds, and of the following measurements: Height, shoulder to ground, 24 to 28 inches; chest to ground, 15 to 19 inches; length, shoulder to root of tail, 24 to 30 inches. Large feet and sturdy, straight, hind legs as viewed from the rear are desirable. They should be alert, smart, and quick-moving. In general appearance they should have broad chest and shoulders, body slightly tapering to well-developed hind quarters, moderately heavy bones, and prick ears preferably to lop ears. Strength and length of leg are desirable for breaking trail.

■ 4. AGES.—The average dog will remain useful until about 9 years of age. His training should begin at about 6 to 8 months, but he should not be put to hard work until he is at least 16 months old. His greatest usefulness will be in his fourth to sixth years.

■ 5. HITCHES.—a. *General*.—Teams may be hitched in tandem or in pairs. Mature dogs accustomed to working in harness may be hitched either in tandem or in pairs without expectation of difficulty. Each system has its advantages and both are used in Alaska and the Yukon Territory.

b. *Tandem hitches*.—(1) Freighting with small teams by one handler over narrow, broken trails is commonly done with a tandem hitch. A trail broken by men marching single file on snowshoes is not quite wide enough for the standard 22-inch sled or for dogs hitched in pairs because both dogs and sleds drag against the sides of the trail and the snow falls down on the sled, increasing the weight. At curves or turns, the bow of the sled cuts into the snowbanks on the sides of the trail, which greatly increases the difficulties of travel. Also, sled runners of a loaded sled will slide off the hardened, trampled, part of a broken trail and cause

the sled to turn over to the outside and into the bank instead of riding up on the edge of the higher snow. In such a situation a narrow sled about 16 inches in width may be pulled without difficulty either by hand or by a small team of dogs hitched in tandem. A combat sled loaded with light machine guns or trench mortars accompanying troops should be narrow and may conveniently be drawn by a team in tandem hitch. The dogs readily learn to follow a beaten trail walking behind a column on snowshoes.

(2) For large teams, tandem hitching makes the team too long for efficient control. When going around curves, tension in the towline tends to drag the wheel dogs and the sled off the trail. The dogs in rear not only have to keep their footing on the trail under this side strain, but are forced to pull the sled alone. Accordingly, it is difficult with a long team hitched in tandem to turn a corner. On a hairpin turn, crossing a bridge, the sled and rear dogs may be pulled off the road into the gulch. This situation also arises with a long team hitched in pairs. When pulling a heavy load dogs are hitched very close together in tandem harness. When traveling light or with empty sleds, the speed may be increased by hitching them farther apart. This is accomplished by lengthening the traces.

c. *Pair hitches.*—Hitching in pairs with a single dog leading will ordinarily give best results. The pair hitch gives the dogs greater freedom of movement, the teams are shortened, and the difficulty of turning corners is reduced. Moreover, an accident to a single dog or harness does not disable the whole team as in tandem hitches where the traces are continuous from front to rear.

CHAPTER 2

EQUIPMENT

	Paragraphs
SECTION I. Harness.....	6-13
II. Sleds.....	14-18

SECTION I

HARNESS

■ 6. **GENERAL.**—Dog harness is made of leather, webbing, canvas, or native-tanned skins, and, with the exception of the collars, which are made over a steel or rattan ring, can readily be made by the kennel personnel. Collars should be purchased as they are available commercially. In Alaska, harness is sometimes made of skins tanned with the hair on so as to bring the fur side next to the dog, but these native-tanned skins are not available in quantity and therefore are not to be considered for military use. Harness made of webbing, or several thicknesses of canvas sewed together, is satisfactory and is preferred by many. It is not so easy to handle as leather and requires a machine capable of sewing heavy material, consequently repairs on the trail are difficult to make. Leather harness will stretch and freeze when wet and some dogs will chew it, but adjustments may be made to compensate for stretching and dressings applied to keep the leather soft and to make it water-repellent. For general use the leather harness is superior to other kinds.

■ 7. **CONSTRUCTION.**—*a. Materials required.*—The following supplies are necessary for the manufacture and maintenance of harness:

Collars, steel ring, sizes 5-, 6-, and 7-inch.

Leather, heavy, black, whole sides.

Thread, leather-stitching.

Hardware, buckles, rings, D-rings, Conway loops, rivets and burrs, needles, roundhead screws, washers, swivel snaps

(round eye), Hubbard loops, $\frac{5}{8}$ -inch brass tubing, $\frac{3}{16}$ -inch steel rod.

b. *Tools.*—Trimming knife, leather splitter, leather gage knife, harness punch, rivet set and header, hammer, cutting nippers, screw drivers, and pliers. A stitching horse is desirable, but would be left behind with the leather splitter when going into the field.

■ 8. *TYPES.*—Three types of harness are illustrated:

a. *Type 1* (fig. 1).—This is used for racing and light, fast teaming. It is made of leather, the yoke is stuffed with reindeer hair, and it is not adjustable. This type is also made of canvas stuffed with the same material; or of straps of several thicknesses of canvas, not stuffed. The simplicity of this harness recommends it, but it has the disadvantage that power is transmitted over the dog's back.

b. *Type 2* (fig. 2).—Tandem harness is suitable for use when tandem hitching is employed. Extra strong traces are needed on the harness of rear dogs, otherwise strong dogs pulling heavy loads will break the traces. In tandem hitching, injury to one harness incapacitates the entire team.

c. *Type 3* (fig. 3).—This is an all-purpose harness of excellent design, suitable for teaming in pairs, which will be found superior for military service.

(1) *Dimensions.*—Heavy leather from the back of the hide is necessary for traces. Traces should be $1\frac{1}{8}$ inches in width but 1 inch will do for a light dog or when using unusually thick leather. Latigo leather is strong enough for back pads, cross straps, collar checks, and belly bands. Straps cut from the sides and belly of hides are suitable for making these pieces. Back pads should be made $1\frac{1}{2}$ to 2 inches wide, cross straps 1 inch, belly bands and collar checks $\frac{3}{4}$ inch in width.

(2) *Adjustments.*—The collar is perforated for the traces after it has been fitted to the dog. The trace strap is split near the end to pass through the collar and double back to a Conway loop fastening which permits adjustment. Loops on the back pad are large enough to permit plenty of vertical play in the traces. Traces are adjusted to bring the single-tree to within 2 or 3 inches of the rear of the dog, where it is supported by the cross straps. When the dog is in traction,

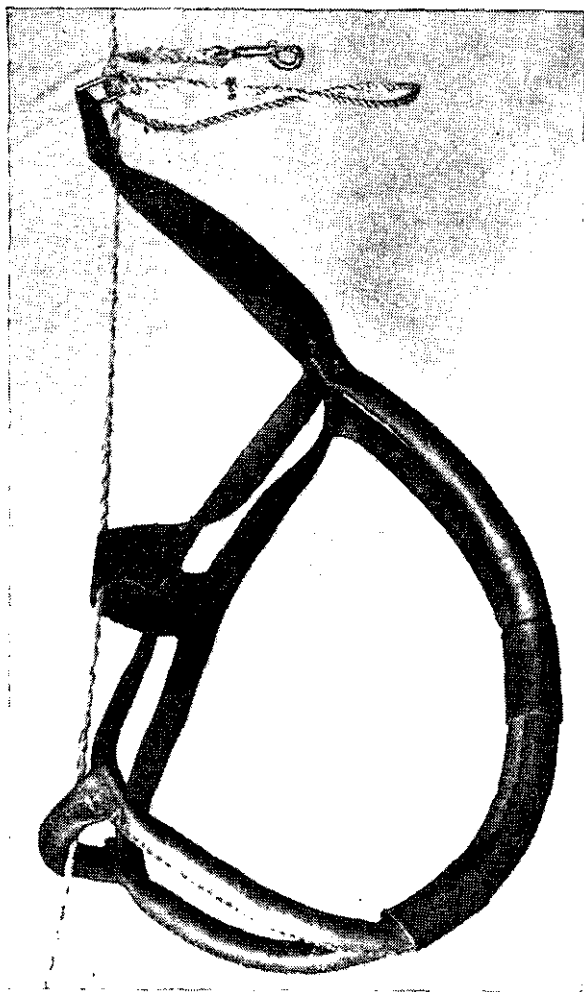

FIGURE 1.—Racing and light, fast-teaming harness.

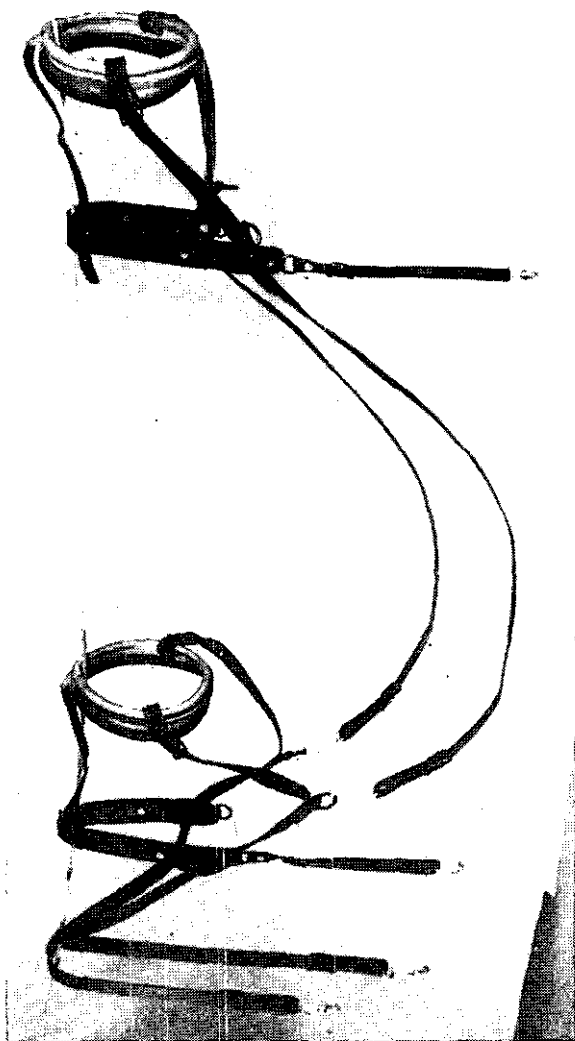

FIGURE 2.—Tandem harness.

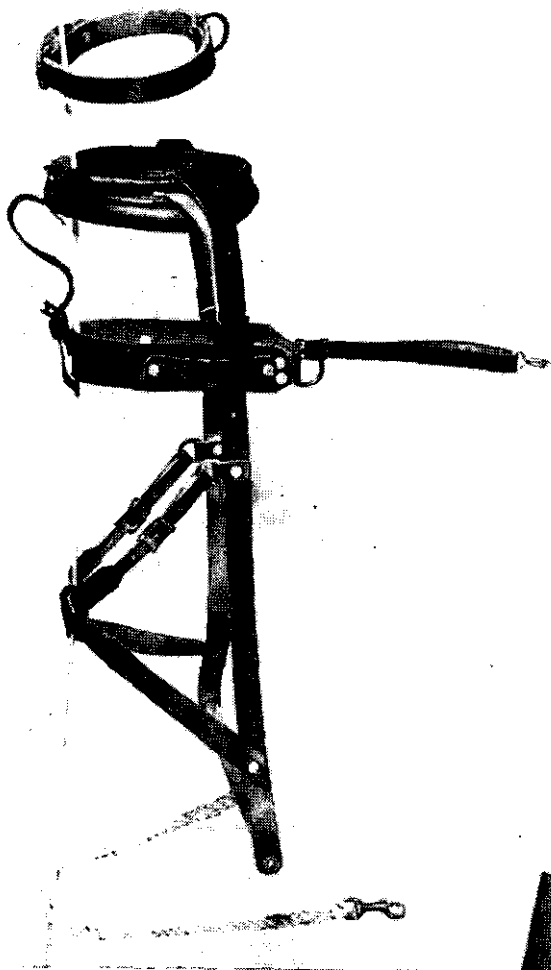

Figure 3.—All-purpose harness.

the cross straps should be adjusted to rest lightly on his hips and not pull down. A Hubbard loop snap is convenient to fasten the belly band as it has a positive action which may be forced when the snap is frozen. If the belly band is adjusted loosely enough to pass the hand through, it will not be tight when the dog is breathing heavily. The collar check from top of collar to back pad serves to keep the dog from pulling his head out of the collar. It is adjusted to fit without tension.

(3) *Singletrees and tug ropes* (fig. 4 ①).—Singletrees are made of hickory. Roundheaded screws and metal washers are used to fasten the traces tightly to the ends so that they will not revolve. The tug rope with a swivel snap is passed through the staple and secured by a larkshead knot. The tug rope may be shortened when necessary by taking one or more hitches around the singletree. The tug ropes will normally remain attached to the harness, but new ones will probably be necessary each year. Extra tug ropes should always be carried on each sled.

■ 9. COLLARS.—*a.* Collars are oval-shaped and sized in even inches along the longer or vertical diameter. Three sizes are available, ranging from the small (5-inch) to the large (7-inch) collar. As a dog's shoulders are narrow, the collar should be supported mainly by the neck muscles. For the average dog, a well-fitting collar is one that will just slip over his head and which will leave about one finger's width clearance between the point of the shoulders and the collar. New collars should be properly broken in by light work before they are put into service. Once fitted to a dog, a collar should not be considered interchangeable, but a used collar can be broken in for another dog.

b. Collars should be made over a steel ring, well-padded and covered with good leather. Some collars have a rattan ring instead of a steel one, but these are not considered as good because they are much less durable. Furthermore, for heavy work, rattan collars may be too pliable as they become elongated horizontally by the tension of the traces and tend to choke the dog. They do form-fit themselves to the dog's neck very quickly, especially when wet.

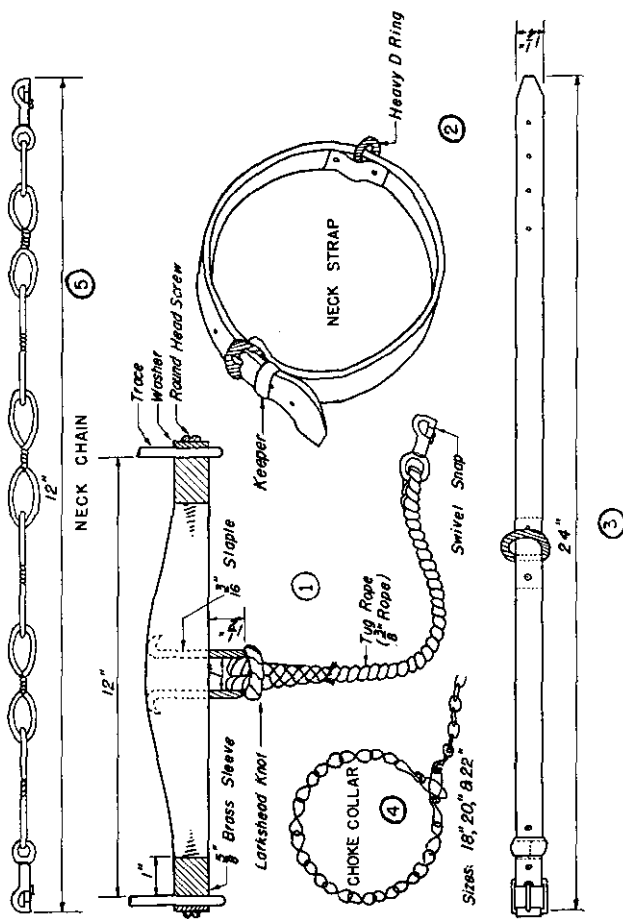

FIGURE 4.—Harness detail.

c. Breast straps of leather, cloth, or webbing, and hair-stuffed yokes are sometimes used in place of collars but are not as suitable for all purposes. These substitutes are usually employed because collars are expensive and often difficult to obtain.

■ 10. **NECK STRAPS** (fig. 4 ② and ③).—Neck straps are always worn by the dog whether in harness or out. They are 24 inches long, made of heavy leather $1\frac{1}{8}$ inches wide with a buckle, keeper, and a $1\frac{1}{4}$ -inch D-ring made of $\frac{3}{8}$ -inch metal. All seams should be copper riveted. When the dog is being harnessed, the neck strap is pulled through the collar and used to fasten him to the tow rope by means of the neck chain. When not in harness, the dog chain is snapped to the neck strap.

■ 11. **CHOKE COLLARS** (fig. 4 ④).—Vicious dogs, and those that lunge to break their chains, may be fastened with a choke collar made of leather-covered cable or chains. An 18-inch size will fit the average dog but a few 20-inch and 22-inch sizes will be required.

■ 12. **NECK CHAINS** (fig. 4 ⑤).—Two neck chains with swivel snaps at each end about 15 inches over-all should be attached to each section of the towline. A strong chain 2-0, weldless, $6\frac{1}{2}$ links per foot, is recommended. A dog that has fallen or is slow to start will be dragged by the neck chain until he regains his feet and a lighter chain will part under the strain. Thongs or ropes cannot be used as the dog will chew them apart.

■ 13. **TOWLINES** (fig. 4 ⑥).—The towline should be made in sections 5 feet 8 inches over-all, one section to each pair of dogs (fig. 5). Residents of Alaska use light, strong lines of rawhide, and native-cured leather, but hard-braided rope treated to be water-repellent makes a suitable substitute. Ordinary rope will do and will often be the only thing available, but it softens when exposed to the weather and, having absorbed water, becomes heavy and is also difficult to handle when frozen. Rear sections of the towline should be made of $\frac{3}{4}$ -inch rope while $\frac{1}{2}$ -inch rope will suffice for the second and third pairs from the front. The lead dog should be on an elongated tug of $\frac{3}{8}$ -inch rope passing between the first pair in his rear (fig. 6). A ring is spliced on the front of each section of the towline and a clevis or bull snap is used at the rear to fasten them together or to the sled (fig. 5). Ordinary snaps are not strong enough for use in a towline.

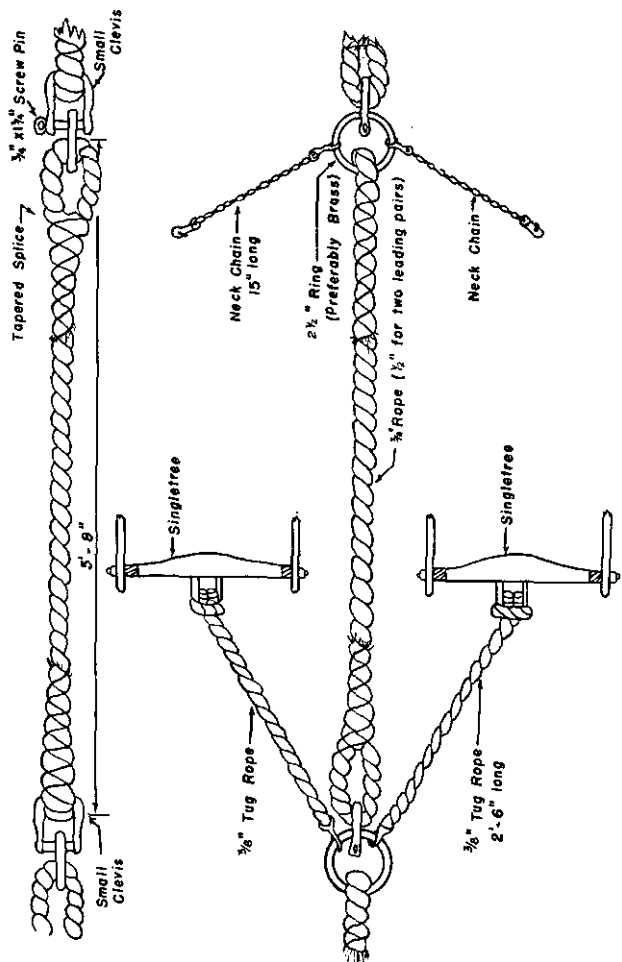

FIGURE 5.—Towline section, showing method of hitching one pair.

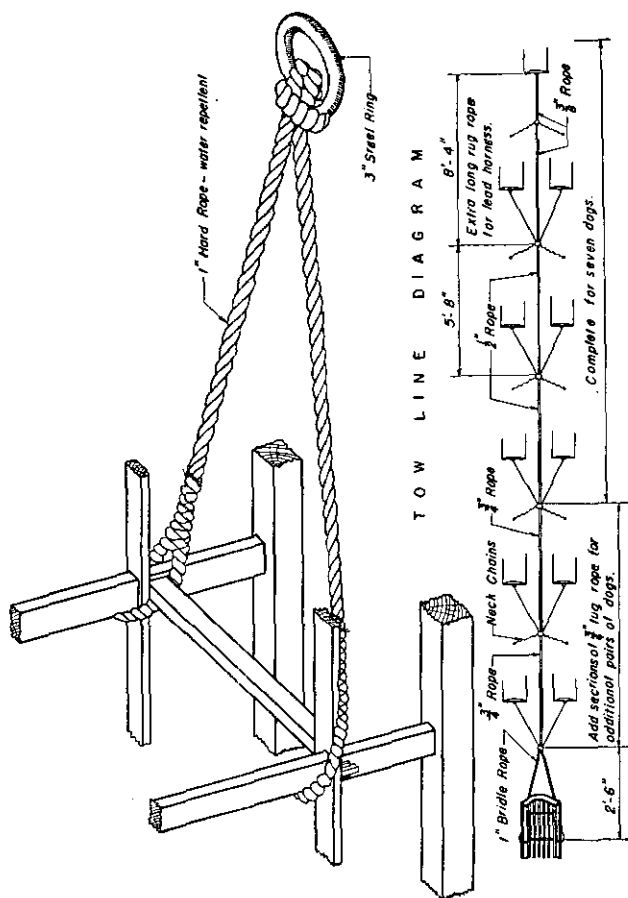

FIGURE 6.—Bridle rope, showing method of attachment.

SECTION II

SLEDS

■ 14. BASKET SLED (fig. 7).—*a. Size.*—The 13-foot cross country sled made of hickory, with six bays and a bow will weigh about 120 pounds. It is as large as may be conveniently handled by a driver for ordinary cross country work. When properly constructed, it is flexible and will stand hard use over rough surfaces. Larger sleds can be used over level stretches under favorable conditions, but the 13-foot sled well loaded will be as much as dogs can pull on upgrades and the driver can handle on curves and downgrades.

b. Construction.—The services of an experienced wheelwright and a shop equipped with steam pressure for bending wood are necessary to build sleds to the following specifications:

(1) *Material.*—Hardwood, preferably No. 1, straight grain hickory (second growth).

(2) *Length over-all.*—14 feet 4 inches (13-foot loading space on bed).

(3) *Runners.*—1 inch high by $1\frac{3}{4}$ inches wide, upper edges beveled between uprights. To be shod with nickel steel closely bolted to the wood. Nickel steel shoes are best on wet snow and ice or wherever wind-swept gravel is encountered. These may be purchased ready drilled and countersunk for bolts. Wooden runners made to fit over the steel ones are best in extremely cold weather. They are faster but wear out easily. During construction, an inch block under the rear of the runners and another under the front between the first and second uprights will give the runner a slight arch throughout. The front rises to 18 inches above the ground at the bow piece.

(4) *Width between runners.*—22 inches at the rear tapering to $21\frac{3}{4}$ inches at point runners bend up in front. This taper allows snow to pass freely between runners without clogging.

(5) *Bed rails.*—(a) *Exterior.*— $\frac{1}{2}$ inch by 3 inches. Lashed to cross bents and uprights, bolted to forward cross bent, bow piece, and rear cross strip.

(b) *Interior.*— $\frac{1}{2}$ inch by 2 inches.

(6) *Lashing hooks or cleats.*—Lightweight, screwed to under side of exterior bed raves; hooks turned under.

(7) *Uprights.*—From runners to bed raves $1\frac{3}{4}$ inches by $\frac{7}{8}$ inch, from bed raves to top rail they taper to $1\frac{1}{4}$ inches by $\frac{7}{8}$ inch.

(8) *Rear uprights.*—Height from shoe to top rail about 3 feet 6 inches; forward upright about 16 inches; uprights 19 inches on centers. All uprights slope to the rear about 10° from the vertical.

(9) *Top rails.*— $\frac{5}{8}$ inch by $\frac{7}{8}$ inch.

(10) *Bow piece.*— $2\frac{1}{2}$ inches thick, cut out and fashioned as shown to fit between runner and bed raves on either side of the bow.

(11) *Cross bents.*— $\frac{7}{8}$ inch by 2 inches mortised through uprights sufficiently to project through and be held in place by wooden pins. Secured in a flexible manner by two figure-eight lashings.

(12) *Fastenings.*—Joints are mortised and bound with babiche (rawhide). The alternate method of fastening uprights to runners shown in detail has a tendency to drag snow and the simpler joint is therefore preferred. Bolts are used to attach the steel shoes to the runners and on the brake and brake tongue. Brass screws are used on the rear frame, handle bars, and to attach the interior bed raves to the cross bents.

(13) *Lashings.*—Cross lashings between uprights are of tightly stretched babiche closely wrapped with No. 3 cotton hanging twine to discourage the dogs from chewing it.

(14) *Finish.*—All sharp edges are beveled off, all parts sandpapered smooth and finished with two coats of valspar over a coat of shellac.

(15) *Bridle rope.*—A 1-inch rope tied in the center with larkshead knot to a 3-inch steel ring of heavy stock is spliced to the sled at opposite sides to form a V, 2 feet 6 inches in length (see fig. 6). The rear section of the towrope is attached to this ring with an anchor shackle or end clevis.

■ 15. MESSENGER OR RACING SLED (fig. 8).—This sled is built with 9-foot runners of the same material and on the same lines as the 13-foot sled described in paragraph 14. It is

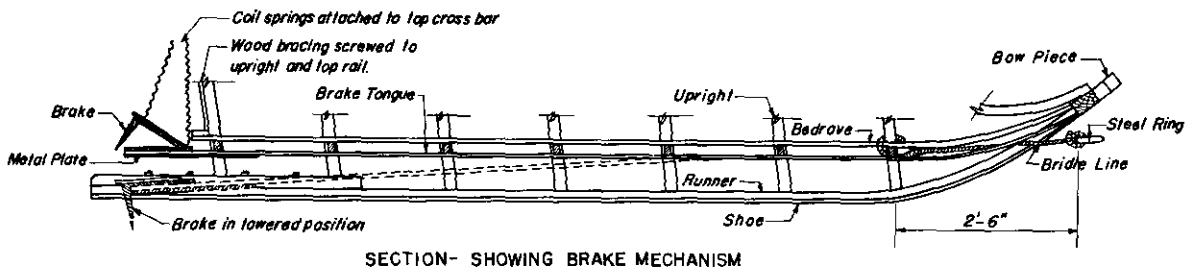

SECTION- SHOWING BRAKE MECHANISM

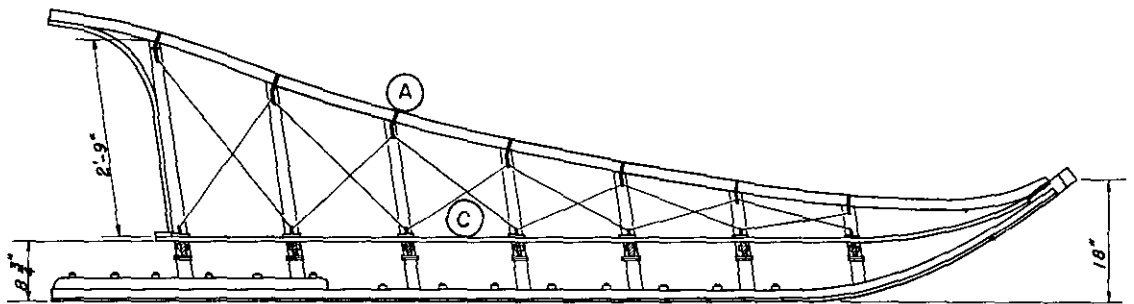

SIDE ELEVATION

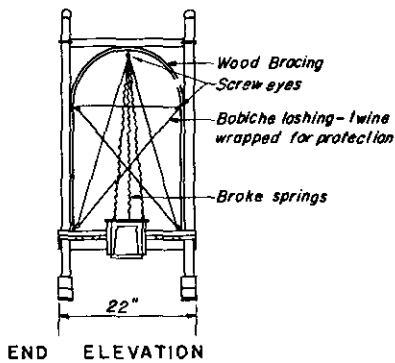

END ELEVATION

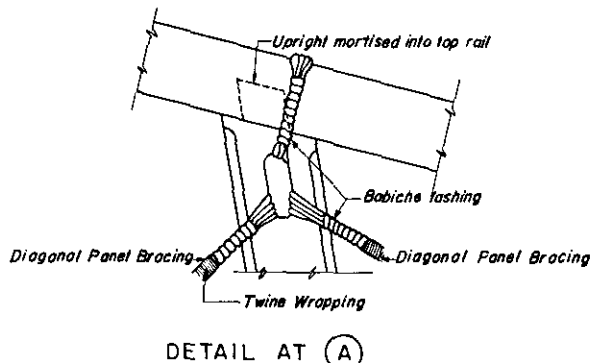

DETAIL AT A

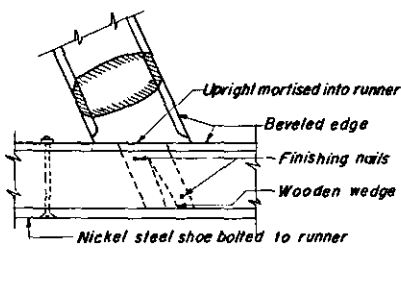

DETAIL AT B

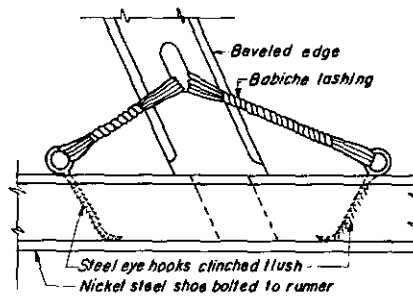

ALTERNATE DETAIL AT B

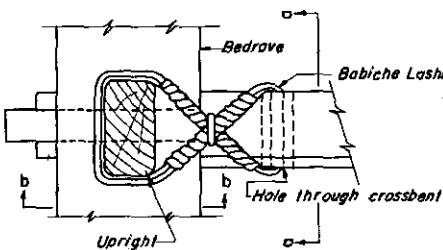
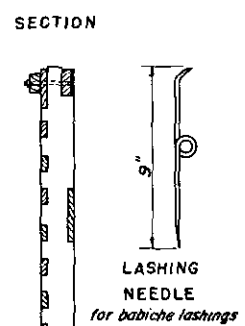
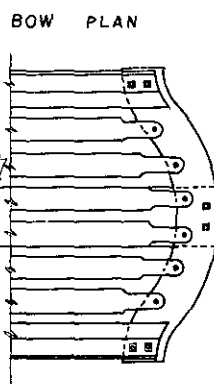
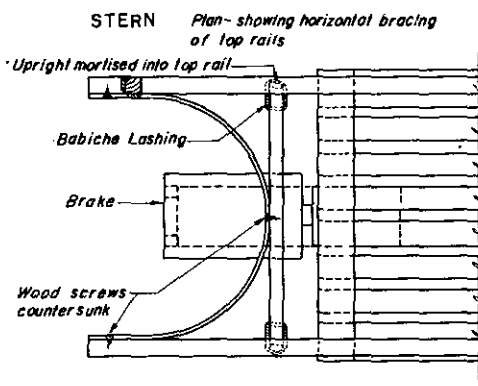

PLAN VIEW
DETAIL AT C

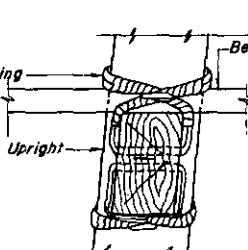

SECTION a-a

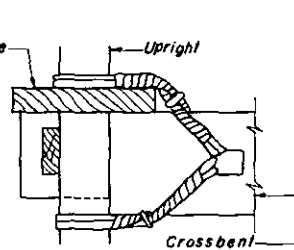

SECTION b-b

FIGURE 7.—13-foot cross country sled

useful for fast travel with small loads. The high stern arch adds to riding comfort of the driver, but the absence of handle bars makes control more difficult. A useful load of 25 pounds per dog in addition to the necessary tools, supplies, and driver's equipment will fill the available space on this sled.

■ 16. TOBOGGAN (fig. 9).—*a.* A toboggan is useful on deep, soft snow and over areas where snow is drifted and trails are not broken. It will also travel well over hard surfaces.

b. Construction of a toboggan is comparatively simple. It is made of parallel bed strips of hardwood steamed and bent like sled runners. The outside strips and the center strip are made of thicker material and shod with metal to form low runners which serve to prevent side slipping and thereby hold the toboggan on its course. Small stove bolts countersunk at top and bottom are used to fasten all strips to the battens and to attach the shoes. The rails are bent with the bed strips and are fastened rigidly to the ends of the battens with small bolts that reach through the runners and shoes. Lash ropes for the load are passed through the gaps between the bed strips and the rails. The bottom is flat without the rocker effect of a runner sled. The bridle is attached to eyes on each side of the curved front high enough above the bottom to avoid catching a mass of snow in the angle between the rope and runner. If desired, uprights, a top rail, and handle bars can be provided as on a cross country sled. A chain can be fastened on opposite sides and dragged in a loop under the bottom to retard speed when going downhill.

■ 17. FREIGHT SLED (fig. 10).—*a.* The freight sled with 13-foot runners is made for convenience in handling bulky and heavy articles. Ordinarily, no brake is provided; therefore, great care must be taken to prevent the loaded sled from injuring dogs and personnel by coasting into them on hills. The dog team may be unfastened from a sled while the driver attempts to take it safely downhill by riding the gee pole. Chains wrapped around the runners are effective to control coasting. An extra section of towline between the sled and the rear pair of dogs will provide room for the driver to walk

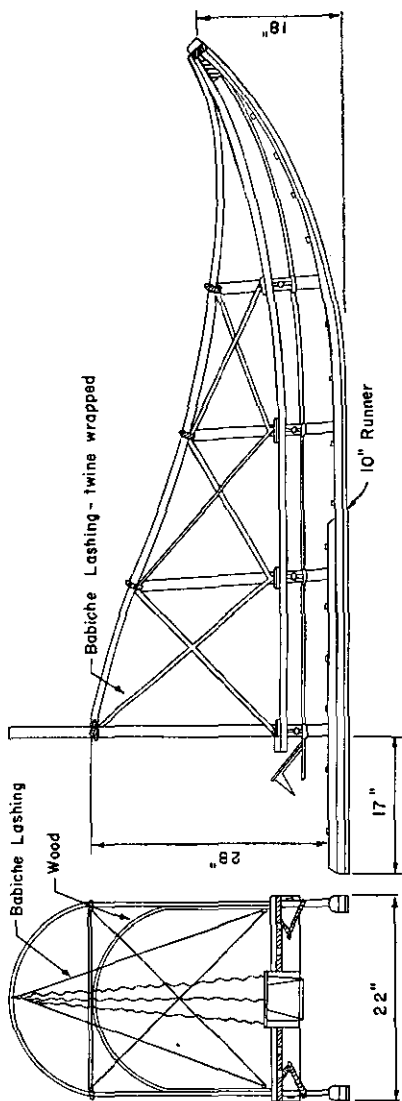

FIGURE 8.—Messenger sled (8- to 9-foot bed).

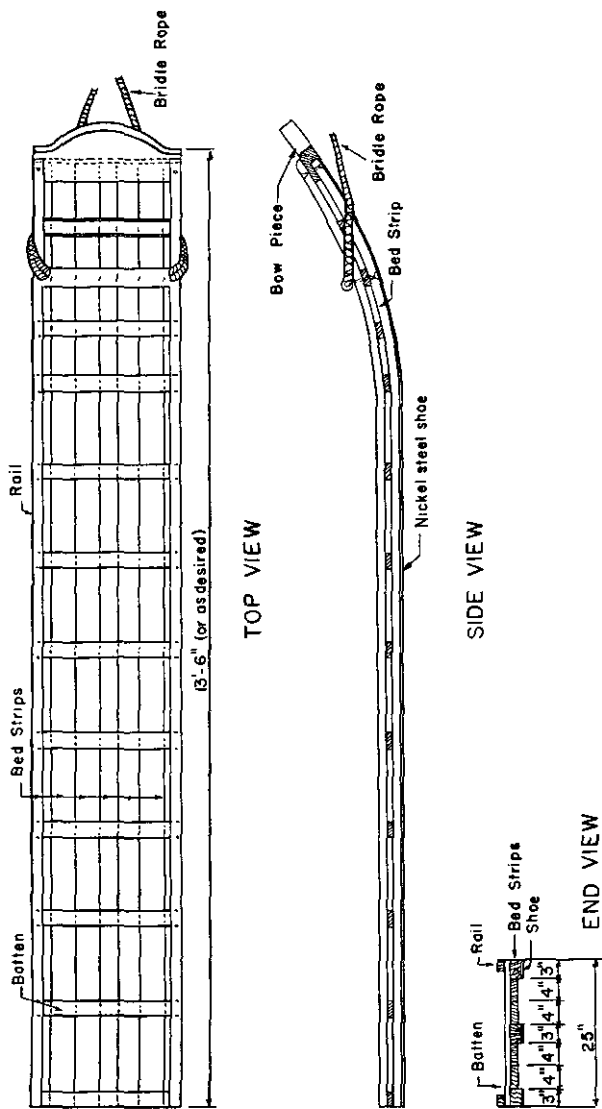

FIGURE 9.—Toboggan sled.

astride the towline while controlling the sled with the gee pole. This procedure will only be practicable behind a slow-moving freight team or when a team is moving in rear of a column that is breaking trail on foot. Small brakes, which will turn over out of the way when not in use, may be attached to the ends of the runners on freight sleds. Another man will be needed to operate these brakes at times when the driver's services are required on the gee pole. On side-hills, application of the brake on the upper side only will aid greatly in keeping the sled on its course. The gee pole, shown on the front of this sled, may be used either for pulling or holding back and is necessary for steering the sled on crooked trails. When ropes are used to pull a freight sled by hand, one man steers and holds the sled by means of the gee pole.

b. Trailers are added when it is desired to move more freight with one team. Unless it is known that the route is level, tow poles should be used instead of lines, as this will keep trailers from coasting into the sled ahead. The length of the tow pole should be such that the gee pole of the towed sled is within easy reach of the driver of the towing sled. He is then in position to control both sleds on hills and curves. Hauling 1,200 pounds on a sled and two trailers may be accomplished by loading 600 pounds on the main sled, 400 pounds on the first trailer, and 200 pounds on the second.

■ 18. BRAKES.—*a.* A good brake is an absolute necessity for fast driving. Without an effective brake, the sled will get out of hand when going downhill which will frighten or injure the dogs. When making sudden stops, the sled will coast into the team and on turns it will swing wide of the course, unless it is retarded by a brake.

b. Prongs on brakes should be from 5 to 6 inches long and far enough apart to prevent snow and ice from packing between them. Two prongs will be adequate under most circumstances. A satisfactory type of brake is shown on the sleds shown in figure 7. If the brake tongue is fastened near the front of the sled where the bridle is attached, application of the brake will cause very little internal strain in the sled. A long radius brings the prongs into normal contact with the ground, causing a true drag instead of a plowing effect.

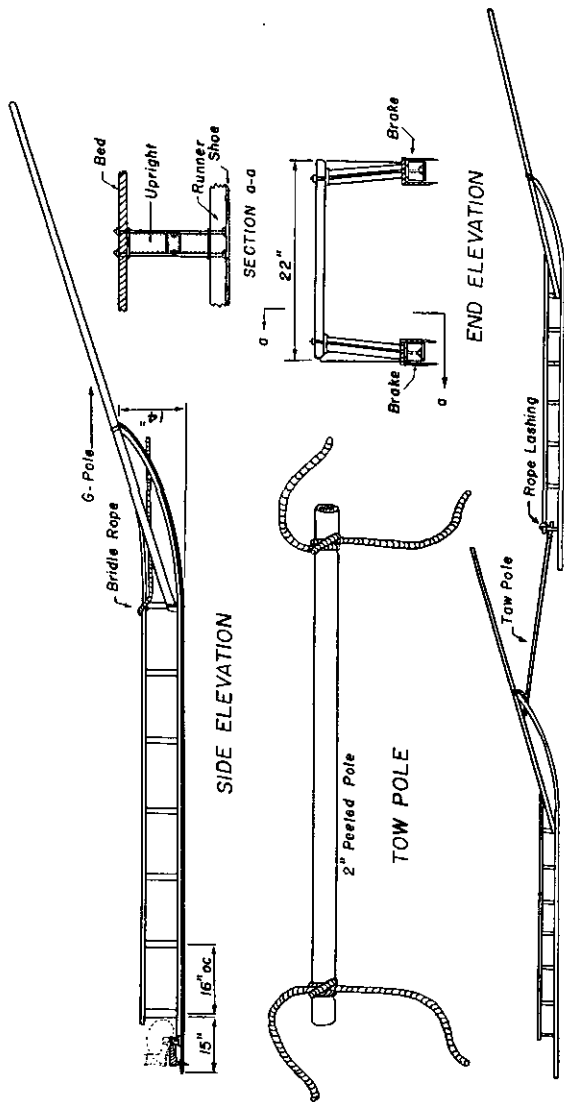

TOW POLE ATTACHMENT

FIGURE 10.—Freight sled (12- to 13-foot bed).

CHAPTER 3

KENNEL MANAGEMENT

	Paragraphs
SECTION I. Personnel, administration, and facilities.....	19-24
II. Feeding and care.....	25-29
III. Training	30-40

SECTION I

PERSONNEL, ADMINISTRATION, AND FACILITIES

■ 19. **KENNEL PERSONNEL.**—*a.* An officer should be placed in charge of the kennels. He should see that the men on duty at the kennels are properly instructed in the care and handling of the dogs and that the prescribed kennel routine is faithfully carried out. The enlisted personnel should consist of one noncommissioned officer and enough privates, or privates first class, to perform the necessary work and drive the teams. One private or private first class will be needed for every 15 dogs or major fraction thereof in the kennel.

b. An active man who is patient, even-tempered, firm, and intelligent will get the best results as a driver. Cruelty, harshness, and rough behavior are no asset to a dog handler. During the training period, it is desirable to have each team handled entirely by one man, who also feeds and looks after it at the kennel. Changes may be made with mature trained dogs, but the best results will be attained by retaining the same driver with a team over a long period of time.

■ 20. **LOCATION.**—The kennels should be situated at least one quarter mile distant from the post proper, on the leeward side, otherwise howling of the dogs will disturb residents of the post. Well-drained ground is necessary and, if the soil is not naturally sandy, it is desirable to gravel the area.

■ 21. **CONSTRUCTION.**—Figure 11 shows a satisfactory arrangement of a kennel that will accommodate 52 dogs. The kennels proper should be inclosed in a 6-foot woven-wire fence.

The quarters for two dog handlers, kitchen, harness repair room, supply room, and storage room for sleds and other equipment are situated in one long building. A veterinary infirmary is also provided. The building should be so located as to shelter the yard from the prevailing winds. Specifications for satisfactory individual box kennels built on bases of 2- by 8-inch stringers on edge, and the details of houses suitable to accommodate a dam and ten puppies, are shown in figure 12. In windy open country where drifting snow is the rule, dog barns are considered superior to individual kennels. Narrow stalls on short platforms are provided on opposite sides of the barn and the dogs must be chained short to keep them from jumping the partitions between stalls and hanging themselves. The dogs may be tied outside during the daytime.

■ 22. SECURING DOGS.—Each dog is secured by a 6-foot length of chain fastened at one end to an eyebolt or staple driven into the kennel base in the front and to one side of the door. The other end is snapped to the D-ring of the dog's neck strap. Ordinarily, 3-0 dog chains are not strong enough and it is recommended that chains be made up of solid-link chain of $\frac{3}{16}$ -inch stock, 14 links to the foot, with swivel snaps at each end and a swivel link near the center. Dogs with small heads will require choke collars. On other dogs, ordinary heavy leather neck straps as shown in figure 4 will be satisfactory.

■ 23. KENNEL POLICE.—Each morning the kennel area should be thoroughly policed. All dung and food scraps should be collected and hauled to the dump. The interior of the kennels should be cleaned and the straw used for bedding changed every other day. The use of straw for bedding is not necessary during the summer months. The kennels and the surrounding ground should be sprayed with a 2-percent cresol solution every 10 days.

■ 24. RECORDS.—The following kennel records should be kept:
a. A brief service record of each dog, including the following data: dam, sire, name, serial number, age, sex, breed, and the markings. Under remarks, such data as vaccinations, dates

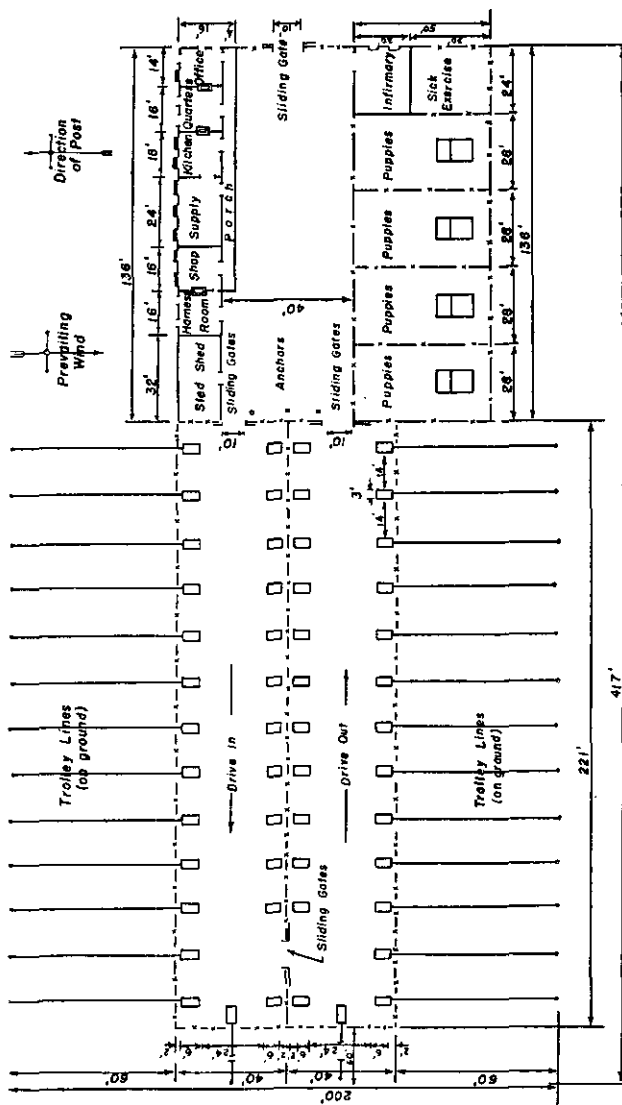

FIGURE 11.—Kennel lay-out.

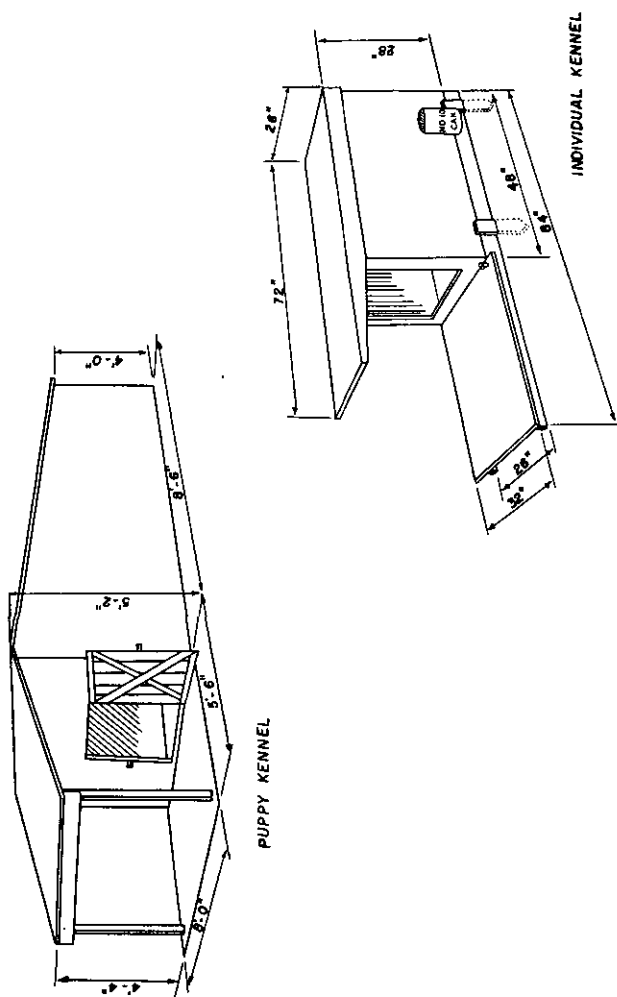

FIGURE 12.—Dog kennels.

of worming, weights, and if a female, dates of mating, etc., should be shown.

b. Record of kennel property.

c. (1) A food record must be maintained at the kennels in order to insure the correct expenditure and requisitioning of foodstuffs.

(2) The quantity of food fed each dog per day is in proportion to the amount of work done. After the training program is fixed, the amount of food required for a certain period on the program is computed by the simple process of multiplying the pounds per day per dog by the number of days in the given period. It is necessary to estimate in advance the number of dogs that will be on hand, taking into consideration the expected variation in the number of grown dogs and the estimated number of puppies born.

(3) After the food has been divided into portions for different periods, a constant surveillance is necessary to keep the consumption of food within the budget allowance. A food shortage is apt to occur if the stock is carelessly expended.

SECTION II

FEEDING AND CARE

■ 25. GENERAL.—The health and condition of dogs depend largely upon the kind of food received and the time of feeding. To feed so as to obtain the best results requires a knowledge of the digestive system of dogs, the food constituents required for their sustenance, the correct proportions of these elements, proper methods of preparation, and the best time for feeding. The organs of the digestive system are enumerated in paragraph 51c. In addition, there are certain accessory organs of digestion as the salivary glands, liver, and pancreas. At feeding time the flow of saliva from the salivary glands, the ducts of which open into the mouth, is stimulated. Dogs bolt their food, gulping it down as soon as they have bitten it into chunks small enough to be swallowed. The copious flow of saliva moistens the food so that it can be more readily swallowed and initiates the preliminary digestive processes. In the stomach the food is acted upon by the gastric juice and dilute hydrochloric acid supplied by

the gastric glands located in the stomach wall. The food passes on to the small intestine, where the digestive process is completed, aided by pancreatic juice and bile supplied by the pancreas and liver, respectively, entering the first part of the intestine by a common duct. The absorption of the digested food materials into the blood stream also occurs in the small intestine. The undigested residue is passed on into the large intestine, where most of the water is absorbed, and then eliminated as feces through the rectum and anus.

■ 26. **FOOD CONSTITUENTS.**—Food constituents are classified according to the function they perform in the animal system. All standard brands of prepared dog food contain a balanced ration of the following food constituents:

a. Proteins.—Protein (flesh-making and tissue-building) is mainly supplied to dogs in the form of meat.

b. Fats.—Fats are essential in the production of energy and heat. In dogs, this is principally supplied by the fat contained in meats, tallow, grease, beef suet, and fish.

c. Carbohydrates.—Carbohydrates are the main supply of energy. The carbohydrates are supplied to dogs in cereals.

d. Minerals.—Minerals are essential for proper development of bones and teeth and their repair. The principal sources are cereals, salt, and bones.

e. Vitamins and roughage.—These are supplied principally by vegetables, but there are some vitamins in meat and cereals.

■ 27. **PROPORTION AND PREPARATION OF FOOD.**—*a.* For idle dogs, enough food to maintain normal body weight is required. For an ordinary dog, weighing from 75 to 95 pounds, a satisfactory ration would consist of a mixture of 1 pound of meat (canned dog food may be substituted) and cooked grains or cereals, and kitchen scraps to give a total weight of from 2 to 3 pounds. Rice, cornmeal, or oatmeal mush makes satisfactory foods, in which kitchen scraps or fish may be cooked for taste. Salted fish should not be used as it tends to produce diarrhea. Fresh fish should be cooked or frozen before it is given to the dogs. All cooked foods should be cooled before feeding. Several pieces of cracked bones a

day per dog are desirable. Heavier dogs may require additional food to maintain their normal weight. All dogs do not require the same amount of nourishment. The kennel personnel must observe the dogs, and increase or decrease the amount of food in accordance with their individual requirements.

b. Average-weight dogs on winter trail or moderate exercise are fed a ration consisting of a mixture of 3 pounds of canned dog food, or 1½ pounds of smoked, or preferably dried, salmon, with ½ pound of oatmeal, cornmeal, or rice. A ration that may be substituted consists of 2 pounds of dried or smoked salmon and ¼ pound of tallow or grease of some sort, such as beef suet. For long trips, where economy of space in packing the sleds is necessary, the following ration may be used and should be cooked fresh every day: 1 pound of rice, 1 pound of grease, and ¼ pound of fish for flavor. If unrendered grease is used, such as suet, old bacon, etc., cut up the grease and fish into a kettle containing enough water to make a thick mixture and boil until the grease is boiled out well; add rice and more water as required, boil thoroughly without stirring. If a mixture is once stirred, the stirring must be kept up constantly to keep the rice from burning. When well cooked, add a little moistened cornmeal or oatmeal and then stir continuously until the meal is cooked through. The mixture should then be cooled and should be of thick, firm consistency. As it becomes nearly cool, stir frequently in order to distribute the grease evenly throughout. When rendered grease is used, put the rice and fish in a kettle of water, boil until done, then add the grease and stir until cool enough to feed. When feeding the dry feed—that is, the dried salmon and tallow—a cooked meal should be given once a week to keep the bowels in condition. It is sometimes advisable to add bran about once a week, at the rate of 1 ounce per ration, to keep the bowels in condition.

■ 28. WATERING.—It is preferable to water dogs twice a day, once in early morning and once just before feeding. While dogs will eat snow on the trail, water is preferable when it can be obtained.

■ 29. FEEDING TIME.—Experience has taught that 4:00 P. M., or the end of the work day, is the best time for feeding dogs. If fed in the morning, the dogs are sluggish and want to sleep. When they are working especially hard, a light meal may be fed early in the morning, or at noon if a long halt can be made at that time. In either case the dogs should be worked easily for a short time thereafter. One-pound bread pans make good receptacles for both food and water. They will hold approximately 3 pounds of mixed food. To insure that all the food is consumed the pans are left out overnight and gathered the following morning. They are then washed with hot, soapy water and rinsed with hot, clean water. The feeding pan of any sick dog should be washed separately and not used to feed any other dog.

SECTION III

TRAINING

■ 30. PUPPIES.—*a.* The training of puppies should begin at the age of from 6 to 8 months, by fitting them with a harness and taking them for short runs with a team including a few older dogs. Most pups take naturally to harness and under favorable conditions will perform satisfactorily from the start.

b. A team with a slow leader and some steady dogs should be driven until they have settled down to a normal gait before hitching in puppies. A good pair will be required immediately in rear of the leader to help keep the towline tight. Another pair of trained dogs should be hitched next to the empty sled. Pups might be struck by the sled if hitched next to it and would be afraid of it thereafter.

c. One or two pairs of pups and older dogs, as desired, may now be hitched in intermediate positions on the towline. One reason for starting training early is that the older dogs will not ordinarily bite the puppies. Although nearly full grown as to size and appearance, a puppy will behave in very different manner from a veteran dog. He will scuffle with his teammate, roll around on the ground, cross the towline, and invariably become tangled with the harness at halts.

Patience is essential to insure good results. An extra driver, riding on the sled, is useful to untangle the pups and to help keep the team in order.

d. If he becomes frightened, a pup is apt to pull back. He will be dragged along by his neck chain and neck strap. As long as he is able to keep on his feet there is a chance that he will resume the gait. In most cases, and certainly if he loses his feet entirely, a stop should be made to encourage the pup and to give him a fresh start. Difficulties arise at once when the gait becomes too fast, as when the team is running free downhill. For this reason level ground is preferable for training dogs. In its absence the driver must apply the brake freely to hold a slow speed going downhill.

e. Encouragement of pups is effective and punishment should be avoided. As stated, most pups if handled intelligently will perform well from the start. More time, patience, and special attention must be expended on those that do not take naturally to the work. Progress is satisfactory when a pup shows interest and runs along willingly in position. Within a short time he can be expected to pull his share of the load.

f. At this stage of instruction, it is desirable that the pups be hitched with the same teammate and always on the same side and handled by the same driver. Care should be taken not to tax him with heavy work or hard running until he has attained an age of at least 16 months. Patience will be rewarded. Pups making an indifferent showing during the period of early training frequently develop into the best workers during the next season.

■ 31. COMMANDS.—*a.* In harness, the team is controlled by commands to the leader. The command to start is "All right!" (preferable to "Mush"). At this command every dog in the team should jump into his collar and start at full gait.

b. "Gee" and "Haw" are used to turn right and left, respectively.

c. "Whoa" stops the team. All dogs know this command but keep moving until the leader stops.

■ 32. THE LEADER.—*a.* The importance of the leader is evident from the fact that there is no rein on the team. Dogs will follow a well-broken trail over a familiar course, but when it is necessary to turn, or when traveling over open country, a lead dog responsive to the commands is a necessity. More than one leader should be available in each team. The best leader will be used regularly and the others driven in positions in the team until emergency requires their use. Additional leaders can be used to take their turn breaking trail.

b. In addition to obeying commands, a leader is expected to "hold-out" the towline. The dogs are attached to this line by their neck chains in front and traces at the rear and necessarily keep their respective places when the line is taut. It is an important responsibility of the leader to keep the team strung out in formation by "holding-out" the line at all times on the trail and also while the team is being hitched and unhitched. A good pair of dogs immediately in his rear is desirable to help him "hold-out" the line. If the lead dog lies down during halts and when hitching and unhitching, the other dogs will generally follow his example.

c. It is the responsibility of the lead dog to pilot the team past distractions. When passing through a village he should keep a uniform rate and hold the team to their task despite the fact that local dogs bark and rush out at them. Upon meeting a team he should turn out widely to lead his team around, and thus avoid a melee. The team, fighting as a pack, will quickly dispatch a single dog that comes within reach. In open country, a good leader may be expected to lead a runaway team on a circular course back to the driver.

d. Over open ground, and during storms when the trail is indistinct to the driver or has been obliterated, the lead dog is expected to follow it. He may do this by scent, running slightly on the leeward side of the old trail and zigzagging when he has lost it. When there is no trail, he is responsible for keeping the general direction indicated by the driver. The tendency to run straight into or straight away from a driving storm must be resisted when the trail takes an oblique course. Free (unharnessed) leaders are employed.

A good leader not in harness will keep his position at the head of the team and will have greater freedom of movement and be able to devote more strength to the task of breaking trail when he is relieved of the responsibility of holding-out the line and pulling a share of the load.

e. An intelligent dog, large and strong enough to break trail and as fast as any dog in the team, should be selected for the leader. A stubborn dog will not make a good leader. The driver may observe that certain dogs in the team respond to commands as promptly as the leader. Such dogs, if otherwise qualified, are potential leaders. It is not necessary that the leader be the best fighter in the team as is commonly supposed. His standing with the team results from the position he holds and his relationship to the driver.

f. A good leader is used to train other leaders. After hitching the pupil beside the leader, but slightly in rear so that the leader can easily swing him to the right or left, the training should proceed over ground where the trail is not well-defined. As the pupil becomes proficient, his tug rope is lengthened gradually until he is fully abreast of the leader. Several periods of instruction will be necessary before the regular leader can be hitched further back in the team and the new leader permitted to carry on alone. Much experience is necessary to develop a leader to his full capabilities.

■ 33. **PETTING.**—*a.* Affectionate dogs, looking for a caress, will not keep their positions, will disorganize the work of the team, and will take advantage of their driver. Pets will not maintain the businesslike attitude necessary on the part of both men and dogs when at work.

b. The average sled dog will not display affection unless it is first invited by the driver. Good results will be attained where there is a feeling of mutual confidence and respect. A friendly attitude, as distinguished from the affectionate behavior of a pet, is desirable. The time for making friends is when the dog is not at work but never before he is thoroughly trained in harness. This is especially true of the leader. It is difficult to keep him properly disciplined while at the same time making a pet of him.

c. Exceptions to the rule that sled dogs should not be made into pets are common. Through long association, a close bond of feeling and understanding is created between some capable drivers and their teams. Examples are not uncommon of runaway teams and individual loose dogs that have returned to a driver for whom they have an affection. However, a good rule in a kennel is not to pet the dogs, and to touch them only to hitch and unhitch them or when necessary for other purposes. On the other hand, it is a mistake to assume that harshness and rough handling will get good results. Cruelty is out of place at all times.

■ 34. WHIP.—*a.* A whip is carried on each sled, though it is seldom that necessity will arise for its use. It can be employed to prevent fights, and to frighten away dogs that approach the team, especially when one team is passing another. The mere presence of the whip has a salutary effect, and it will rarely be necessary to employ it to punish an individual dog. It is a good rule not to whip dogs in the presence of pups as they become unnerved and frightened when whipping takes place in their immediate vicinity.

b. The dogs are too far away and close together to permit the use of a whip from the driver's position at the rear of the sled. There is a chance of hitting the wrong dog and danger of striking one in an eye. Accordingly, delay in administering punishment will follow an offense because of the time necessary to stop the sled and approach the dog; and unless it is certain that the dog will associate the punishment with the actual misbehavior, it is well to forego it.

c. In harness, the dog should feel secure and nothing should be done to confuse or disconcert him. Calling him by name will generally suffice to make him pull, or stop doing a wrong thing. Usually, trained dogs are conscious of misconduct. Having spoken to him twice, if the offense is repeated, it may be advisable to whip him. Unless the driver can strike him in the very act, it is better to uphook his neck chain and tug rope and take him out of the team while whipping him. He is then returned to his place, and the idea that he is safe in harness is thus preserved.

d. The back is a point of weakness, and it is considered better to risk a lame muscle by whipping a dog on the flanks and shoulders than to risk an internal injury by striking him on the back. Several sharp blows will suffice, and the driver should move up quickly to administer them. Running up quickly with the whip, or punishing a dog too close to the others, may frighten the team and cause a runaway. Occasionally a dog will attack the driver or another dog in defense of his teammate.

e. Mutual confidence is essential. A dog that is timid and cowering, that shrinks away and lies down upon the approach of a driver, may be as difficult to handle as one that will bite when the driver tries to untangle him or adjust his harness.

■ 35. VICIOUSNESS.—A vicious dog will bite a man or dog without provocation. Viciousness is a serious fault and is not to be associated with high spirits, courage, strength, and endurance. One good bite on the leg or foot may disable a dog for a long time or destroy his usefulness entirely. Thus, on the trail a vicious dog may bring about a failure of the undertaking by injuring others. A light wire muzzle may be used if designed so that the dog can eat snow while wearing it.

■ 36. FIGHTING.—Fighting is common among sled dogs and must be guarded against. Occasionally they bite and hold, especially when in harness, but generally they slash and tear at each other. The best fighters grab the front legs and feet and endeavor to kill their antagonist. Once started, whipping is not effective in stopping a fight. A man trying to stop a fight will be considered a participant by the dogs and may be injured. In a general fight among loose dogs in the kennels whipping indiscriminately may suffice to stop it. By catching hold of the neck strap from the rear, raising up his front feet, and striking him several blows on the nose, an individual dog may be made to stop fighting, at some risk to the driver. Effective measures against fighting are best taken before the actual fight begins. At that time speaking to them and flourishing the whip may avert trouble. In harness the dogs of one team will fight other dogs as a pack. Some pains must be taken to protect a strange dog until the others become used to his presence.

■ 37. **Loose Dogs.**—A dog may break loose by tugging and lunging against his chain. He may then run away, but will almost invariably return for feeding. When loose, the dogs may injure other animals or indiscriminate breeding may result. Loose dogs frequently start fighting with other dogs in the kennel, which causes an uproar and often ends with one or more serious injuries. Dogs breaking loose may remain quietly by their individual kennel, but this, unfortunately, is seldom true. In any event, sled dogs should never be loose. When not in harness, they should be securely chained. The sled dog gets his exercise and recreation in work, which he enjoys because it takes him away from the confinement of the kennel.

■ 38. **HARNESSING.**—*a.* The towline, with a section for each pair of dogs, is assembled and stretched out with the leader's harness and tug rope at the front end and anchored to a pole or other fixed object by a rope or chain extending from the bridle ring along the snow under the sled. A hold may be safely taken through the brake, but an anchor chain around the uprights may pull the sled apart under the strain. The other harnesses are laid on the snow in position.

b. The leader is brought out first. Since an excited dog can drag a man by the chain and as footing on the snow or ice is seldom secure, the dog should be held by the neck strap in order that his front feet can be raised from the ground, if necessary, to restrain him. The driver grasps the dog between his knees at the flanks and holds him securely while slipping the collar over his head, he then pulls the neck strap through the collar, and fastens the belly band. A tight collar may be slipped over the dog's head with less difficulty if revolved 90° to bring the long axis horizontal. The lead dog will now assume his task of holding-out the line as the dogs are brought out singly and fastened to the line from front to rear. The neck chain is fastened as the driver releases the dog from between his knees. He then moves back and snaps the tug rope to the sled line. To take advantage of the enthusiasm and minimize the period of nervous excitement, a prompt start should be made. This will mean, in general, that the sled is loaded before the team is harnessed and

everything in readiness before the anchor chain is released. When the driver is in position, he releases the sled, and the team dashes wildly away. A turn in the road or an obstacle is very apt to cause a serious wreck during the first moments of running.

■ 39. SUPERVISION.—When hitched, dogs require constant attention to keep them from fighting and from chewing ropes or harness of any material. The latter habit, once acquired, is difficult to break.

■ 40. UNHITCHING.—The dogs do not sweat and it is unnecessary to cool them off upon return from a hard run. The sled is anchored as at the start and the dogs taken off in reverse order; that is, the rear dogs first and the leader, who is holding-out the line, last. When all dogs are chained to their kennels, the sled and harness are put away. If the harness is wet, it should be straightened out to keep it from freezing into unusual shapes. The dogs should be examined for sore feet and treated for any other injuries.

CHAPTER 4

FIELD MANAGEMENT

■ 41. ON THE TRAIL.—*a.* If several sleds are traveling together, they will proceed in column. When a light fall of snow necessitates trail-breaking, the leading position should be shifted regularly among the teams to equalize the work. Dog teaming is more dependent upon favorable weather conditions than is any other kind of transportation. Without snow no movement whatsoever is possible. Sleds cannot travel in damp snow which adheres to the runners and gathers in masses between them. In soft, deep snow a trail must be broken by other means before dog teams can move successfully.

b. Conditions favorable for dog teams are cold, dry snow, crusted or windswept. Extreme cold weather is no deterrent, but may necessitate the use of wooden runners. A thaw may cause the crusted snow to break under the weight of a sled, stopping all movement. After thaws set in, it will be possible to march on cold nights and in the early morning hours when slush is frozen.

■ 42. EQUIPMENT.—The following equipment is carried when on the trail for an extended period. A good plan is to have this equipment in a roll or box placed on the sled where it is readily available. Do not make the mistake of loading and lashing the pay load on top of these items.

First aid kit:

- Iodine.
- Ointment.
- Bandages.
- Cotton and swabs.
- Sutures and needles.
- Scissors.
- Tweezers.
- Adhesive tape.

Tool kit:

- Rivet nippers.
- Pliers.
- Hatchet.
- Leather punch.
- Rivet punch.
- Box of $\frac{5}{8}$ -inch rivets and burrs.
- Cold chisel.
- Screw driver.

Accessories:

1 Whip, loaded handle.	Dog shoes for team.
1 Feed pan per dog.	Rings, snaps, and wire picket pins.
1 Chain per dog.	2 Lash ropes, 30 feet by $\frac{1}{4}$ inch.
2 Extra neck chains.	Mantas and lash ropes for small articles.
4 Extra tug ropes.	
2 Extra towrope sections.	

■ 43. **DOG SHOES** (fig. 13).—Small boots of leather and canvas should be worn on sensitive and sore feet. These may develop at any time when working hard, but especially when teaming on salt water ice or thin crusted snow. The dogs should be accustomed to wearing these before taking the trail. Because the foot, relaxed, will pass through a small shoe top, it is possible to secure a fair fit on the leg. The bottom should be large enough to take care of expansion of the foot caused by weight and pressure. The thongs may be tied around the legs or attached to parts of the harness to serve as suspenders.

■ 44. **TEAMING UP.**—*a.* An alert and willing pair of dogs should be hitched immediately in rear of the leader to help him hold-out the line. A slow, headstrong, tired, or unwilling dog in this position can soon discourage a leader. The lighter dogs should generally precede with the heavier, slower dogs following. Experienced, powerful dogs should be hitched next to the sled. A dog that is not afraid of the sled, and who knows how to avoid being run over, is desirable on "the wheel." The rear pair should be strong enough to handle the sled on sharp curves when the rest of the team is pulling at an angle. The tug ropes of this pair should be hitched to the bridle ring of the sled and not to a section of the towrope proper. This precaution will insure one pair of dogs to pull-in the empty sled in the event the rest of the team breaks away. On long trips, when the loss of dogs would be a serious matter, short tieropes may be employed as couplings across the joints between sections of the towrope, to hold temporarily should the line break. The newest and strongest sections of the towline should be in rear.

b. On short runs, bitches may be used when not in heat. They should always be teamed up with a dog. For cross country work, it is undesirable to have more than one bitch in a team. A dog is generally preferred because of his greater size and strength.

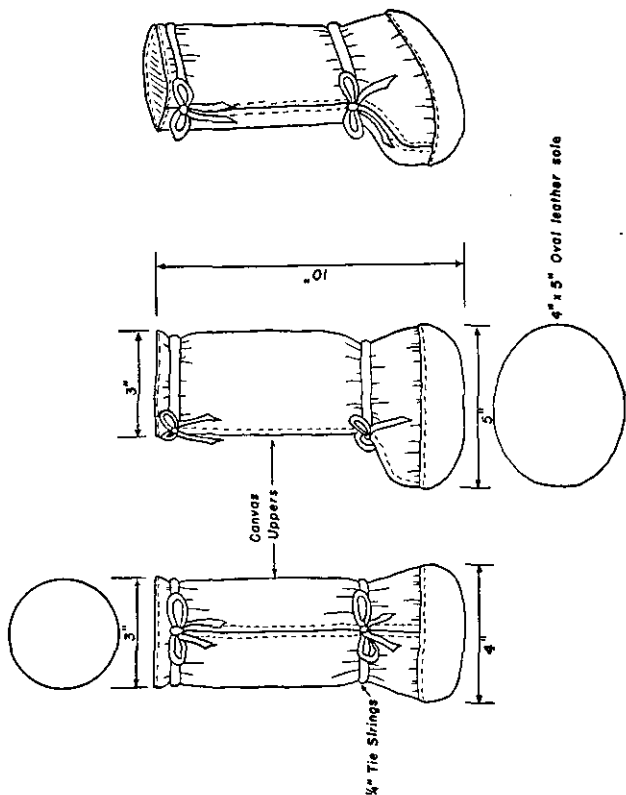

FIGURE 13.—Dog shoes.

■ 45. THE START.—About 30 minutes are required for the drivers to pack their personal effects and eat breakfast. Packing the sleds and harnessing the teams will consume an

hour unless done simultaneously by different crews. Unless the teams are allowed to precede the troops, a delay will be necessary before the start, as the dog teams must proceed by bounds because of their faster rate. The teams should not be hitched up until the actual moment of starting, otherwise the dogs will become worn out with impatience, start fighting, chewing the harness, etc.

■ 46. CARE.—*a.* Dogs require a minimum of care on the trail. One meal a day after camp is reached, preferably around 4 o'clock, is all that they require. The dogs will eat snow even while running; and although it is desirable to water them both morning and afternoon, as water quenches thirst better than snow, it is not necessary.

b. The camp should be made at a place where the dogs will be sheltered from wind, as in a ravine or under a bank. Shelter from rain is advisable as dogs are soon chilled and exhausted by dampness. Unless trees are available to which to chain the dogs at night, a picket line will be necessary. This adds additional weight to the load. The line is stretched on the ground with stakes or deadmen at either end, or the sled can be used to hold one end in an emergency. The dogs are then tied by short chains at suitable intervals along the line. On the ice, small picket pins will serve to fasten the dogs and, being lighter, are preferable to a picket line.

c. At the end of the day's work, the dogs should be inspected for sore feet and other injuries and given first-aid treatment.

■ 47. HARNESS AND SLED.—The sled should be turned on its side or set up on skids overnight and the runners wiped clean so that there will be no ice on the shoes at the next start. If wet, care should be taken to keep the harness from freezing into inconvenient shapes. It should be hung up on trees, or on a cabin wall inside the cabin when space is available. The sled must be protected from the dogs to keep them from chewing the lashings. One loose dog can destroy the sled in a night. A driver may spread his bed on the sled to be on hand to prevent injury to it.

■ 48. DRIVING.—Skillful handling of the sled by the driver avoids many difficulties, saves his team, and insures the successful completion of his trip. By throwing his weight from side to side to steer, lifting up on the handle bars to help the sled over hard places, shifting the rear end to give the sled a new direction, and holding it to prevent an upset the driver is able to avoid many serious mishaps and to spare his team much effort and inconvenience. By running behind the sled when going uphill, pushing it when necessary, and jumping on to ride across level places and downhill only the driver increases the length and speed of the march and saves the strength of his team. Skillful use of the brake will have the same effect. By applying it when the lead dog is coming abreast of an obstacle such as a log, rock, sharp curve, etc., a timely effect is produced which will insure a safe passage. Care must be taken at all times, but especially when stopping and on down grades, to apply the brake quickly to prevent the sled from running into the dogs. A loaded sled will gather great momentum on a hill, and the runner passing over the foot of a man or dog will do serious injury. The most difficult feat expected of a driver is to mush his sled when breaking trail on a hillside.

■ 49. RATE OF TRAVEL.—a. The rate of travel will be determined by the type of team and certain other conditions. Within limits, the dogs choose their own gait and speed. When they start to slow down the driver should encourage them by voice, usually calling individual dogs by name. Many short halts are preferable to long ones as the dogs recuperate very quickly. A 2-minute halt every mile will be sufficient when the going is good.

b. When the dogs show signs of tiring by slowing down or breathing heavily, the driver should halt them before they stop of their own accord. Their interest and enthusiasm in their work wane markedly as they become tired. The driver's encouragement is then effective in keeping up the pace.

■ 50. TIRED OR INJURED DOGS.—An injured dog may be put on the sled to ride, but he should be tied to prevent his jumping off. When a dog begins to tire, he can be rested by

removing his harness and allowing him to run along in his place without pulling. Otherwise he can be tied to the sled with a rope and allowed to follow for an hour or so until he is rested. For quick results, he may be ridden on the sled, but this should be avoided, as a dog soon acquires a taste for riding and may be spoiled. After a short rest the dog may be put back in harness and will finish the day without difficulty. An utterly exhausted dog may be left on the snow beside the trail, and when rested he may be expected to overtake the sled. In a reindeer country, however, he cannot be depended upon to rejoin them, as dogs like to chase these animals.

CHAPTER 5

PHYSIOLOGY AND HYGIENE

	Paragraphs
SECTION I. <i>Anatomy, breeding, weaning, spaying, etc., and treatment</i>	51-53
II. <i>Prevention and first-aid treatment of disease and injuries</i>	54-64

SECTION I

ANATOMY, BREEDING, WEANING, SPAYING, ETC., AND TREATMENT

■ 51. **GENERAL STRUCTURE.**—The body of the dog is made up of the following systems: skeletal, muscular, digestive, respiratory, circulatory, nervous, urinary, reproductive, and an integument of skin and hair.

a. Skeletal system.—The skeletal system is the bony framework which gives the body form and rigidity and forms cavities for protection of the vital organs. The bones and their joints together form a system of levers and pulleys which, through muscular action, gives the body power of locomotion.

b. Muscular system.—The muscles make up most of the bulk of the body, and by their action produce all movements. Muscles are attached to the various bones by either broad fibrous bands or rounded tendons which pass over one or more joints.

c. Digestive system.—The digestive system is a long tube, known as the alimentary canal, beginning at the mouth and terminating at the anus. The alimentary canal consists of the mouth, oesophagus, stomach, small intestine, large intestine, and anus. Its function is to receive and digest food. In the mouth the food is masticated (or chewed) and mixed with saliva. From the mouth the food passes through the oesophagus to the stomach, where it is mixed with digestive juices, and the process of digestion begins. In the small intestine the bulk of the digested food is absorbed into the blood stream.

In the large intestine the bulk of the water is absorbed, leaving a residue of undigested material which is eliminated as feces by the process of defecation. The feces normally should be of soft consistency and formed. The daily amount varies between 4 and 10 ounces, depending on the amount and kind of the diet.

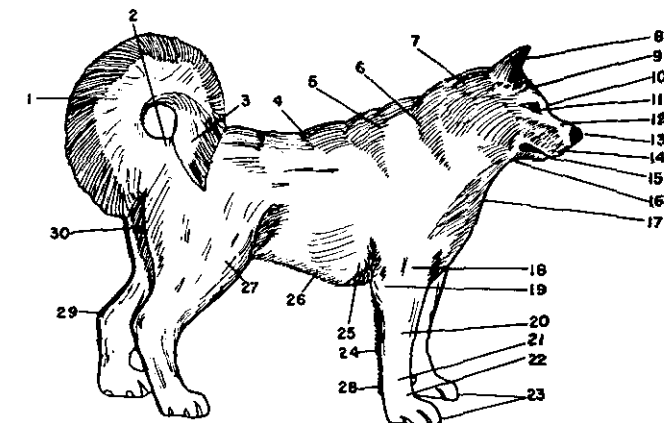

- | | |
|----------------------|------------------------|
| 1. Brush. | 16. Dewlap. |
| 2. Hip. | 17. Apron. |
| 3. Rump or withers. | 18. Arm. |
| 4. Back. | 19. Elbow. |
| 5. Shoulder. | 20. Forearm. |
| 6. Neck. | 21. Wrist. |
| 7. Occiput. | 22. Pastern. |
| 8. Ear or "leather." | 23. Pads. |
| 9. Dome. | 24. Feather. |
| 10. Stop. | 25. Chest. |
| 11. Haw. | 26. Fringe. |
| 12. Muzzle. | 27. Stifle or knee. |
| 13. Nose. | 28. Dew-claw. |
| 14. Chop. | 29. Hock or heel. |
| 15. Flews. | 30. Breeching or flag. |

FIGURE 14.—Outline chart of sled dog.

d. Respiratory system.—The organs of the respiratory system are the nasal passages, the pharynx, the larynx (or voice box), trachea (or windpipe), the bronchi, and lungs. The function of this system is to supply the blood with

oxygen and to throw off waste gases. The process of breathing is divided into an inspiratory and expiratory phase. Inspiration is the process of drawing fresh air into the lungs where the oxygen is absorbed into the blood stream. Expiration is the process of expelling waste gases from the lungs. At rest, the normal rate of breathing varies with the age, size, and sex. As a rule the rate of breathing in the female is somewhat faster than in the male. Young dogs have a faster rate than mature dogs. Smaller dogs breathe faster than larger dogs. Therefore, the respiratory rate varies from 18 to 30 per minute, and the breathing is free, soft, and noiseless. After exercise, the respiration becomes rapid, short, and noisy because of the increased oxygen requirements to supply working muscles. After cessation of exercise, the rate of breathing quickly subsides to normal.

e. Circulatory system.—The circulatory system consists of the heart and blood vessels. The blood vessels are the arteries that carry the blood from the heart to all parts of the body, and the veins that return the blood to the heart. The small arteries terminate in fine capillary vessels which form a close network in all body tissues. The blood is collected from the capillary bed by small veins which progressively increase in size as they approach the heart. Oxygen and food materials are absorbed by the tissues in the capillary bed, and waste products are absorbed by the blood and eliminated. The heart is a muscular organ divided into four chambers consisting of the right and left auricles and the right and left ventricles. On each contraction of the heart, the blood is forced from the right ventricle through the pulmonary arteries to the lungs, where it is aerated and is then collected by the pulmonary veins and returned to the left auricle. From the left auricle, the blood passes into the left ventricle from which it is forced through the aorta and its branches to all parts of the body, where it is collected in the veins and returned to the right auricle. The heart beat varies from 80 to 120 per minute.

f. Nervous system.—The nervous system consists of a brain, spinal cord, and nerves running to all parts of the body. The nerves are of two kinds; those that carry messages

from the brain and those that carry sensations to the brain. Nerves usually lie close to the arteries in their course. In training dogs, by constant repetition of certain movements habit reflexes are developed. This is accomplished by a short-circuiting of the incoming nerve impulses through the spinal cord out through the nerves to the muscle groups involved, thereby excluding the brain from the process.

g. Urinary system.—The urinary system consists of two kidneys, two ureters, the bladder, and the urethra. The kidneys are bean-shaped organs situated deeply in the upper part of the abdominal cavity. They are freely supplied with blood and extract most nitrogenous waste material dissolved in water. This waste material (urine) passes through the ureters, which are long tubes leading from the kidney to the bladder. Upon filling, the bladder contracts, forcing the urine through the urethra, a tube leading from the bladder to the outside of the body. In the male, the urethra opens through the penis; and in the female, it opens into the upper part of the vagina. The amount of urine excreted daily varies with the food, work, external temperature, season, condition of the animal, and other factors. The average amount of urine excreted daily by large dogs is 1 quart.

h. Reproductive system.—(1) *Function.*—The function of this system is the reproducing of their kind. The male dog will breed at all seasons of the year. The oestrus, or period of sexual desire in the bitch, occurs two or three times yearly, usually during the spring and fall seasons, and lasts for a period of approximately 10 to 14 days. At the beginning of the oestrus period, the vulva or lips of the vagina become swollen and a slight bloody discharge takes place. The bitch will only submit to sexual intercourse while in heat. If, during the oestrus period, the bitch is bred and becomes fertilized, the ensuing pregnancy lasts 60 days. The age of puberty, which may be defined as the time when reproduction may occur for the first time, is attained in the bitch from 6 months to 1 year of age. However, the full reproductive capacity may not be attained at this time. There may be rather a marked variation in the age at which puberty is reached. It is principally affected by the state of nutrition

and the climatic condition, occurring earlier in the warmer climates.

(2) *Breeding and cross-breeding.*—(a) In Alaska the type of dog known as the Husky, which is an Eskimo dog of unstandardized breed, is recommended as the best type of sled dog. The Malamute is an excellent dog, supposedly possessing some wolf strain, and nearly equal to the Husky when a short-haired type can be obtained. A wolf strain, however, is not generally esteemed in sled dogs. The Siberian dog is small and makes fast time over long distances on packed snow or ice but is inferior for breaking trail in deep snow, as it is too short-legged and tires quickly. Collies and shepherd dogs are of little value as they are not native to a very cold climate and cannot stand extreme temperatures. They are also too affectionate and willing to work, which results in the team spending itself early each day, usually before the distance desired can be accomplished. Their strain is not considered desirable in sled dogs.

(b) Large, heavy freight dogs should not be bred with light-weight dogs as the resulting pups are apt to show poor conformation. That is, they may have a heavy forefront with a long, light body and rangy hind quarters. The Newfoundland strain is satisfactory for heavy freight work but is not good for speed. Some setter strain is considered valuable to improve the nose for following trails.

(c) For breeding purposes a bitch should be selected that is in good condition, not over 6 or under 2 years old, and weighing from 75 to 85 pounds. She should be intelligent, with good markings and having a conformation as described in paragraph 3. The bitch should be of proved stamina, spirited, but not vicious. The male should be mature, having the same desirable characteristics as the bitch. The male dog can be used for breeding purposes up to 8 years of age. Inbreeding should be avoided generally, but in some cases it has been found satisfactory for one generation, but full brothers and sisters, or father and mother and one of their pups, should not be mated. A bitch should not bear more than one litter of pups a year. To insure pregnancy taking place, the bitch should be bred first on the seventh or

eighth day of the oestrus period, repeated after an interval of one day, and in case the oestrus period is not over, a third mating can be accomplished on the twelfth or thirteenth day. During pregnancy, the bitch should receive good care, nutritious food, and sufficient exercise, but should not be overworked.

(3) *Weaning*.—A bitch and litter of six puppies could be cared for under the following routine: Pups are allowed to nurse for 4 weeks. During this period, the bitch is fed two cans of canned milk per day. The fifth week one can of milk is given to the pups, thus diminishing the nursing and teaching them to lap milk. During the fifth week only one can of milk is given to the bitch daily. The sixth week the bitch is given no milk and the pups are given two cans daily. No further nursing is allowed after the sixth week. The seventh week the pups are started on thin oatmeal gruel and small amounts of canned dog food or small amounts of finely ground meat. At about 8 to 9 weeks pups are put on a regular diet except that no heavy rice or oatmeal mixtures are given. At 10 weeks no restrictions are placed on the diet, but two meals are fed daily until the pups are 4 months old.

(4) *Spaying*.—Spaying is the removal of female sex glands (ovaries). In general, female pups should be spayed at approximately 5 months of age, which is well in advance of the first oestrus period. Female dogs that are spayed after the oestrus cycle has been established are apt to become fat and lazy, and although incapable of becoming pregnant still attract the male dog, thereby becoming a nuisance in a sled team. Female pups that have been successfully spayed should develop into good sled dogs, and can work with other dogs in the team without causing undue excitement and inefficiency as a normal bitch in heat. The chief disadvantages of spaying are—

(a) The bitch can never be used for breeding purposes even though she develops into an unusually fine animal.

(b) Although the operation is performed before the oestrus period has been established the animal may still show a tendency to become fat and lazy and thereby become useless as a sled dog.

i. Skin and hair.—The skin forms the outer protective covering of the body. Sweating occurs only through the foot-pads and not from any other part of the skin. Dogs shed twice a year. Huskies and Malamutes have a thick, heavy coat of hair and can stand extremely low, dry temperatures without apparent discomfort. When long-haired dogs go through water, such as overflow on creeks, the hair on the belly and legs becomes wet and coated with ice, which adds a wearying weight. It is difficult to remove this ice unless the dog can be taken into a warm place. The short-haired dog does not present this problem and is therefore preferred to a longer-haired type.

■ 52. TEMPERATURE.—The average normal body temperature taken rectally of the dog at rest is 101.5° F. but may vary from 100.5° to 102.5° F. Factors that may produce variations in temperatures are air temperature, exercise, excitement, and disease. Temperatures are taken by clinical thermometer inserted into the rectum.

■ 53. AGE.—The average dog can work efficiently until about 9 years of age. The training of dogs should begin at about 6 to 8 months, but they should not be given hard transport work until they are at least 16 months old. The average duration of life is about 9 years.

SECTION II

PREVENTION AND FIRST-AID TREATMENT OF DISEASE AND INJURIES

■ 54. GENERAL.—The treatment of disease and injuries among animals, as well as prevention of disease, is the function of the Veterinary Corps. Most diseases and injuries are preventable if all concerned are vigilant, intelligent, and untiring in the application of simple preventive measures. Frequently the development of serious disease or injury may be prevented by prompt first aid measures and early treatment. In this section the causes, prevention, symptoms, and first aid treatment of some of the more common diseases are briefly discussed.

■ 55. SYMPTOMS OF DISEASE.—The most common indications of disease are partial or complete loss of appetite, temperature above 102° F., accelerated breathing, increased pulse rate, listlessness, dejected countenance, stiffness, nasal discharge, cough, diarrhea, constipation, lameness, inflamed mucous membranes, unhealthy coat of hair, loss of hair, itching, or unnatural heat or swelling in any part of the body.

■ 56. INSPECTION FOR SICK ANIMALS.—The best time to inspect animals for evidence of sickness or injury is while they are being fed. One of the first and most important symptoms of sickness is loss of appetite and sluggishness. Take the temperature of animals that refuse their feed. Move each animal around and look for lameness and nasal discharge and listen for coughs.

■ 57. KENNEL VETERINARY KIT.—For use in treating dogs in the absence of veterinary service or for first aid treatment, small quantities of medicines, bandages, and adhesive tape may be issued. The doses and uses of drugs are as follows:

a. *Boric acid powder*.—For external use only. May be used, as supplied, as a drying powder for dusting on a wound or applied under a dressing. For eye or mouth wash, dissolve two mess kit spoonfuls (level) in one mess kit cupful of warm boiled water.

b. *Iodine and potassium iodide*.—Issued in tubes for making iodine solution. For external use only. Add contents of two tubes to special bottle and fill with water. Use as antiseptic and disinfectant on wounds. May be painted on skin over sprains, strains, or swelling. Do not use in eye.

c. *Cresolis solution*.—Antiseptic and disinfectant for external use only. Use only in solutions as indicated. For wetting antiseptic pack to bandage over wound, add one-half mess kit spoonful to mess kit cup brimful of water. For washing wounds, add one mess kit spoonful to mess kit cup brimful of water. For disinfecting wood, leather, cloth, metal, etc., add one and one-half mess kit spoonfuls to mess kit cup of water.

d. *Castor oil*.—To be used as a laxative and purgative in doses of from one to eight tablespoonfuls.

■ 58. CLASSES OF DISEASES AND INJURIES.—*a.* Diseases are divided into two classes, communicable and noncommunicable.

(1) Communicable diseases are diseases that are transmitted or spread from animal to animal either by direct contact or indirectly through the medium of infected kennels, water and feed pans, food, etc. These diseases deserve more attention than noncommunicable diseases because some are incurable, some may be transmitted to man, and all may cause great losses if not held in check. The general measures for controlling this type of disease are considered in paragraph 59.

(2) Noncommunicable diseases include all diseases that are not transmissible, either directly or indirectly, from one animal to another.

b. An injury is a break in the tissue of the body resulting from external violence or from muscular activity of the body itself. The more common injuries of animals are roughly classified as wounds, bruises, strains, sprains, and fractures.

■ 59. COMMUNICABLE DISEASES.—*a. Prevention and control.*—

(1) *General health.*—Maintain animals in good condition, feed well, keep in clean surroundings, do not overwork, protect from undue exposure, and they will resist many forms of infection. Animals in run-down condition are very susceptible to disease.

(2) *Segregation.*—Animals should be divided into three groups; affected, suspected, and healthy. The suspected animals include all those which have been in contact with the diseased. Attendants, watering and feeding arrangements, and all equipment should be included in the separation and should be kept separate until the outbreak is over. Once an animal is placed in the affected group it should remain there until all danger is over. To avoid possible introduction of communicable diseases, all animals are quarantined at least 21 days upon arrival at any new station.

(3) *Disinfection.*—Strict cleanliness of kennels, equipment, water, and feed pans is a good safeguard against the spread of disease. Kennels, equipment, etc., which have been in con-

tact with diseased animals should be disinfected with cresolis solution (par. 57c). Articles that can be boiled may be thoroughly disinfected in this manner. (See AR 40-2095.)

(4) *Inspections.*—Inspection of all suspected and healthy animals should be carried out daily. In cases where it may serve as a guide, the temperature of suspected animals should be recorded.

(5) *Destruction of dogs.*—Certain diseases are incurable and it is necessary to destroy the animal. This may be accomplished by shooting the dog in the middle of the forehead about 1 inch above the level of the eyes.

(6) *Disposal of dead.*—All carcasses of dogs dying as a result of communicable disease should be burned if practicable; otherwise buried at depth and covered with quicklime if available. Ground where discharges from the dead have fallen should be disinfected.

b. *Acute nasal catarrh or coryza.*—This is an acute inflammatory condition of nasal mucous membrane producing a serous or mucous discharge.

(1) *Cause.*—Inhalations of dust or other foreign material such as gases or chemicals, prolonged exposure to damp cold, and infection by certain germs.

(2) *Symptoms.*—Sneezing in the presence of a thin serous discharge in the early stages, which later is mixed with mucous which becomes dry and adheres around the nose opening. The nose is rubbed against objects and wiped by the paws. Scratches frequently appear around margins of nostril. The prognosis is favorable and recovery usually takes place within 1 to 2 weeks.

(3) *Treatment.*—The dog should be kept warm and protected from draughts of cold air and segregated from the well dogs. Clean or spray the nasal passages with a warm 2 percent boric acid solution. A drop or two of a 5 to 10 percent argyrol solution may be placed in the nose once daily. Vaseline may be applied to the scratches around the nasal opening.

c. *Acute tracheobronchitis.*—This is an acute, inflammatory condition involving the mucous membranes of the trachea (windpipe) and bronchial tubes.

(1) *Cause*.—Inhalations of small particles of foreign bodies, dust, etc., entering the trachea and bronchial tubes produce an irritation and congestion of the mucous membranes which allow infection to take place by certain germs. These organisms are already present in the upper respiratory tract. Factors lowering the general body resistance of the dog, such as extreme fatigue and prolonged exposure to damp cold, are predisposing factors in developing the disease.

(2) *Symptoms*.—(a) *General*.—Moderate fever (a rise of 1° to 2° F.), quickened pulse, partial loss of appetite, and increased thirst are the general symptoms present. In severe cases there is complete loss of appetite, high fever, and general depression.

(b) *Cough*.—This is the most important symptom as it is never absent although it may be slight or severe and at times it may be paroxysmal in type which often ends in nausea and vomiting. The cough is dry and harsh in the early stages, later becoming moist as the inflamed mucous membranes produce an increased secretion. The object of the cough is to expel accumulated mucous from the air passages.

(c) *Discharge*.—This is always present except in the early stages. It contains only mucous at first, but the mucous is replaced by more and more pus as the disease progresses. In dogs, the discharge is expelled from the trachea and bronchi directly into the mouth and swallowed.

(d) *Dyspnea*.—The degree of dyspnea (shortness of breath) depends upon the obstruction of the free movement of air through the bronchial tubes. In mild cases it may not be noticed but in severe cases in which the caliber of the bronchi is materially decreased by swelling of the mucous membranes, it may be quite distressing.

(3) *Prognosis*.—The prognosis is favorable in mild and moderate cases. The course of the disease is usually 8 to 14 days.

(4) *Treatment*.—The dog must be kept in a warm, dry place having good ventilation, but direct currents of cold air must be avoided. The dog should be segregated to prevent spread of the disease. A light diet such as milk, extract of beef, soups, or small amounts of cooked beef is given. In cases

where the animal will not eat he should be given raw milk to which egg has been added. When a severe cough is present, cough mixtures containing sedatives may be administered under the direction of a veterinary officer.

d. Catarrhal pneumonia (bronchopneumonia.)—This is an infectious process involving scattered areas of lung tissue.

(1) *Cause.*—Pneumonia is caused by certain germs, principally, the pneumococcus associated with many other germs. Predisposing factors are chilling of the body surface due to prolonged exposure to damp, cold air associated with fatigue, other diseases which lower the animal's general resistance, and inhalation and aspiration of infectious material in the mouth and nose.

(2) *Symptoms.*—The symptoms of pneumonia develop rapidly, usually beginning with a chill, and the dog appears depressed and restless. The temperature is high (104° to 106° F.), shortness of breath is marked, breathing being short, shallow, and very rapid. A short, painful cough is noticed and the pulse is accelerated (180 to 200 per minute).

(3) *Prognosis.*—Unfavorable.

(4) *Treatment.*—The dog should be segregated in a warm, dry, well-ventilated room free from cold draughts. The dog's strength should be sustained by the use of appetizing and nourishing foods such as milk, beef extract, soups, and egg-nogs given warm, in small quantities, every few hours. During convalescence, small amounts of lean meat and other nutritious foods should be given three to four times a day. At the onset, a purgative (calomel 0.03 gram and sodium bicarbonate 0.5 gram) should be given to produce free purgation and stimulate the activity of the kidneys. Expectorants are useful as an aid in expelling the discharge from the bronchial tubes. Counterirritants to the wall of the chest in the form of mustard plasters are helpful. The heart action in severe cases should be stimulated by the use of digitalis.

e. Distemper.—Distemper is an acute, infectious, communicable disease which in most cases affects young dogs.

(1) *Occurrence.*—This is one of the most common diseases affecting dogs and is known in every country where dogs are

found. It is particularly a disease of young animals, the majority of dogs contracting it at some time during the first year of their lives. Whole litters of puppies or all the animals in the kennels may become affected at one time. It occurs in districts as a local disease. It is more prevalent in cities than in the open country and it is most prevalent during the fall and winter months. Highly bred animals are more commonly affected than those bred by natural selection.

(2) *Cause*.—The disease is thought to be produced by a living organism which is small enough to escape all filters. Infection may be either direct, the animals coming in direct contact with each other, or indirect through intermediary agents, the virus being taken into the digestive tract with food or drink. A number of factors tend to favor the development of the virus, such as reduction of the general resistance of the animal by poor food, insufficient food, colds, injuries, operations, and various diseases or conditions interfering with the assimilation of food. Puppies with weak constitutions are especially susceptible. Ordinarily in animals the development is from 3 months to 1 year of age. Older animals are very seldom affected, and if so, take the disease in a mild form.

(3) *Symptoms*.—The acute form begins with a moderately high temperature (103° to 106° F.), which may remain elevated from several days to several weeks. The dog is depressed, the hair coat becomes rough and loses its gloss, the nose is found to be hot and dry, and the dog may sneeze considerably. In a large number of cases, inflammation of membranes covering the eyeball and inside of the lids is a common symptom. In the early cases there is a serous or watery discharge from the eyes which later becomes pus. In severe cases corneal ulcers occur which result in white scars. Vomiting is an early symptom in a large number of cases. The animal is thirsty and drinks large quantities of water. Constipation is invariably the rule during the early stages followed by diarrhea in the course of a day or two. The stools are very frothy, fetid, often shiny, and sometimes bloody. Early there is a nasal discharge, first clear, later becoming pus. The dog shows much distress and makes fre-

quent attempts to clear the nasal passages by sudden expiratory efforts, rubbing the nose against objects and clawing at the nasal openings with the forepaws. In severe cases the discharge is so copious that the nostril may be found partially or completely closed. Inflammation of the bronchi is very common, producing severe coughing and labored breathing. The fatal cases have a terminal pneumonia. Frequently, nervous symptoms such as excitement, restlessness, a yelping cry, and in certain cases fits occur. In extreme cases paralysis may follow this disease.

(4) *Prognosis*.—The prognosis is not favorable even in the milder forms of the disease.

(5) *Treatment*.—The dog should be fed easily digested, nourishing food, such as raw meat, finely chopped or scraped; beef broth, warm milk, or egg-nogs. The dog should be segregated from other dogs in a dry, warm, well-ventilated room, free from cold draughts, with a plentiful supply of fresh water. During the early stage calomel (0.075 to 0.1 gram) is used as a purgative. To correct the constipation, warm laxative foods are indicated. Eyes should be bathed twice daily with a 3-percent solution of boric acid, followed by a few drops of cod-liver oil in each eye. The nostrils should be cleansed twice daily with a warm solution of boric acid, followed by a few drops of a 5-percent solution of argyrol, along with a few drops of glycerine, placed in each nostril. Distemper serum is highly recommended.

(6) *Prophylaxis*.—All puppies should be immunized at 4 to 6 months of age, using vaccine, virus of canine distemper. All newly received dogs under 1 year of age should be immunized as above unless a definite record of previous vaccination is shown.

f. Rabies.—Rabies is an acute, infectious disease, fatal in the majority of cases and characterized clinically by disturbance of consciousness, marked irritability, and later by symptoms of paralysis. At the present time it is unknown in Alaska.

(1) *Cause*.—Rabies is produced by an extremely minute germ and is induced in practically all cases by the victim being bitten by a rabid animal, introducing the virulent saliva into the wound.

(2) *Types and symptoms.*—There are two types of rabies: furious rabies and dumb rabies. Different trains of symptoms depend on whether the brain or spinal cord is primarily involved.

(a) *Furious rabies.*—In furious rabies there are three stages of development:

1. *Melancholic or prodromal stage.*—From 3 to 7 weeks after the dog has been bitten by a rabid animal it becomes sullen, afraid, seeks dark places, and is easily irritated, restless, and obstinate. Early there is not much effect on the appetite, but later the dog is inclined to eat indigestible objects, such as pieces of wood, and eat their own feces and lap up their own urine. The salivary secretion is increased and saliva hangs from the mouth in long strands. The dog will often bite or scratch the place of infection and sometimes extensively injure the area. This stage lasts from 1 to 3 days.

2. *Maniacal or irritative stage.*—In the stage of irritation the symptoms reach a higher degree of development. Excitement increases. Hallucinations which bring about violent fury or rage are apparent and the voice of the animal changes decidedly from the normal. This is a very characteristic symptom of rabies and no doubt develops from the congestion and paralysis of the vocal cords. At this stage they become vicious and, if confined, show a tendency to chew objects and tear them to pieces. If they are not confined they will wander away and bite other animals or persons that happen to come into their path. Often during a short period of time they will travel long distances before returning, which they invariably do. A rabid animal in this stage, unless confined, may inoculate a large number of animals. As this stage progresses, the period of fury becomes shorter and soon marked depression is noted. The stage of fury lasts 2 to 4 days.

3. *Paralytic stage*.—In the paralytic stage the symptoms of paralysis become pronounced and the dog is less vicious. Complete loss of voice and inability to swallow with paralysis of the tongue and chewing muscles are early symptoms of this stage. The mouth is held open. The dried tongue is protruded and completely paralyzed. The eyes are retracted and lose their expression and luster; the pupils become dilated and in some cases unequal. The animal shows marked general wasting and there is much exhaustion. The general paralysis asserts itself, beginning in most cases in the tail and hindquarters. The animal has difficulty in walking or standing. Paralysis rapidly ascends to the foreparts and central nervous system, causing death on the fifth to eighth day of the attack. During the early stages of rabies the temperature may be high; later it becomes subnormal.

(b) *Dumb rabies*.—This form is characterized by paralysis of the lower jaw, tongue, and throat. This symptom develops early in the disease and is the most prominent one until general paralysis manifests itself. This often leads to the suspicion that the animal has a bone or some other object lodged between its teeth or in its throat. In the majority of cases no nervous or excitable systems are shown; the paralytic symptoms gradually become more pronounced until the animal succumbs to general paralysis. There is the same peculiar expression from the eyes as in other forms. The dog often attempts eating and drinking, which the paralysis prevents. There is usually no tendency to bite or viciousness manifested. On the other hand, a tendency to become more affectionate usually predominates. The disease is fatal in practically all cases.

(3) *Treatment*.—After rabies has once developed in an animal no treatment will have any effect on the disease. Wounds that have been caused by the bite of a rabid dog should be opened freely, washed thoroughly with formalin, and cauterized with fuming nitric acid. A preventive vac-

cine is now inoculated into unexposed animals which is considered to be quite efficient. Exposed animals may be given antirabic vaccine. However, due to the marked susceptibility of dogs to rabies, the treatment will fail in a considerable percentage of cases. Under no circumstances should a dog showing symptoms of rabies be killed. It should be securely confined in quarantine until the disease has terminated fatally. Immediately thereafter the head should be removed, placed in a watertight container packed in ice, which should be replenished as necessary, and sent to a competent laboratory for microscopic examination.

g. Mange.—Mange is a communicable, parasitic skin disease spread both by direct and indirect contact.

(1) *Cause.*—Mange is caused by a very small animal parasite which lives on or in the skin.

(2) *Symptoms.*—There is a patchy loss of hair associated with intense itching. The surfaces of the affected areas are likely to be moist and raw or scabby, due to the activity of the parasite and scratching or rubbing of the animal. Later the skin becomes much thickened and tends to lie in ridges.

(3) *Treatment.*—Mange is not easily cured and must be thoroughly treated. Infected dogs must be isolated and their kennel thoroughly disinfected. The skin of the animal should be cleaned and all crusts and scales removed. This may be done by washing or scrubbing with water containing a mild soap. One of the best preparations used in the treatment of mange is a lime-sulphur dip containing 1½ percent of polysulphide sulphur (see par. 8, AR 40-2125). As a rule, at least three treatments are necessary at 48-hour intervals and in very advanced cases six or more may have to be given. The solution should be heated to at least body temperature and the animal allowed to remain in the bath for 5 minutes in order to attain the maximum results. Precautions should be taken to prevent the solution from running into the ear or having contact with the eye.

h. Ringworm.—This is a communicable skin disease spread by direct or indirect contact.

(1) *Cause.*—It is caused by a fungus quite similar to ordinary mold. This fungus will remain infectious in kennels and on equipment for a long period.

(2) *Symptoms.*—Ringworm is characterized by a small, well-defined circular area occurring most commonly on the head and legs. First, slightly reddened, these areas are soon covered with dirty, gray, crusted scabs. At times, there is intense itching, inducing scratching and rubbing which removes the crusts and leaves the surface raw and bleeding.

(3) *Treatment.*—In cases where large areas are involved, dipping in hot lime and sulphur solution prepared according to paragraph 8, AR 40-2125, is recommended. Small areas may be treated with tincture of iodine. Patients must be isolated in quarantine and all personnel handling these cases must exercise due precautions to prevent contracting the disease.

i. *Fleas.*—A dog is the most commonly affected, of the small animals, with fleas. Fleas are large enough to be seen with the naked eye. They are jumping insects without wings, brown in color, and from 2 to 4 millimeters long. The female is the larger. They obtain nourishment by sucking blood. They readily pass from one animal to another and may reside in dust and filth. The eggs are dropped or deposited on the ground or floor and hatch in 6 to 12 days. The final transformation into an adult insect requires 3 to 5 weeks, depending on the temperature.

(1) *Symptoms.*—Sedentary, feeble, or young animals, or those nursing young are particularly susceptible; also animals kept in close quarters. Fleas are tormenting and harm the animal chiefly by disturbing rest and quiet. Large numbers may produce chronic skin eruptions but the most damage to the skin results from frequent and persistent scratching which produces irritated areas of the skin of the neck, back of the ears, and back of the forearm.

(2) *Treatment.*—The destruction of fleas on dogs is effected with dilute creolin (1 to 2 percent solution).

j. *Worms.*—Dogs are not infrequently infested with worms. The two common types are the tapeworm and roundworm:

(1) *Tapeworm.*—(a) *Symptoms.*—The symptoms in tapeworm vary considerably. The usual clinical picture is as

follows: abdominal pain, the appetite may become diminished or in other cases the dog may become greedy. Dogs often show symptoms of abdominal irritation by rolling or rubbing the abdomen on the ground, or biting at it. Dogs may develop a shaggy coat and leanness. Ripe segments of the worm occurring in the rectum and anal glands frequently produce irritation causing the dog to assume a sitting attitude and to drag the anus over the ground. Either diarrhea or constipation may be present. A correct diagnosis can only be made by finding worm segments on the hair or bedding or a laboratory examination of the feces. Tapeworms are acquired by eating raw or insufficiently cooked flesh of animals and fish, and occasionally from swallowing infested fleas.

(b) *Treatment.*—The usual drug employed is arecoline hydrobromide in doses of $\frac{1}{16}$ to 1 grain, depending upon the weight of the dog. The drug is administered preferably as a drench in a small quantity of water or it may be given in a capsule. The drug is very well tolerated but it easily causes vomiting. In order to prevent this the dog should be prepared by giving only milk for 24 hours and then fasting for another 24 hours. Usually the worms are passed in from 10 to 20 minutes, but if no worms are passed it is advisable to repeat the dose and follow with an enema.

(2) *Roundworm.*—Roundworms are quite common in dogs, especially in puppies. The source of infestation is from the eggs of female worms passed from the dog with the feces. Under natural conditions the development of the embryo may take place in water or soil. The eggs are extremely resistant and may remain viable for a considerable period. Dogs become infested by ingesting this embryonic egg with food or water. Infestation with this parasite commonly occurs in unborn puppies which accounts for finding roundworm infestation in newborn puppies.

(a) *Symptoms.*—The puppies show symptoms of wasting at from 3 to 5 weeks of age. They are stupid and do not play as animals usually do at this stage. Vomiting is common and quite often some of the worms are expelled. Leanness increases, the linings of the mouth and lids are pale,

and the abdomen is enlarged. Diarrhea is not uncommon, often alternating with constipation. Frequently the symptoms become more severe, food is refused, followed by weakness, unconsciousness, and death. In mild cases, or in older dogs, the symptoms are less severe and are often unnoticed. The appetite remains good and is often voracious. The hair coat is dull and rough and the growth is impaired. Diagnosis can only positively be made by finding the eggs in the feces or worms in the vomitus or feces.

(b) *Treatment*.—This should be given as soon as the symptoms are noted and before the dog becomes too weak. Oil of chenopodium in doses of 1 to 4 drops in $\frac{1}{2}$ to 1 ounce of castor oil produces excellent results. This should be given after a short period of starvation. It is advisable to have the feces examined at regular intervals in order to ascertain if reinfestation occurs.

(c) *Prevention*.—In order to rear young animals free from roundworm infestation, energetic measures must be directed toward a cure of all infested dogs and a thorough disinfection of all the premises to which they have access. This is best done in the early winter because the weather conditions are unfavorable for their development. All additions to the kennel should be examined and treated before being allowed with the other dogs. Pregnant animals should be entirely free of all parasites and thoroughly washed to remove all eggs or embryos that may be on their hair or skin. Feed and water and all receptacles must not be permitted to be soiled by dogs which harbor worms.

■ 60. NONCOMMUNICABLE DISEASES.—*a. Diarrhea*.—(1) *Symptoms and causes*.—This term is applied to a too frequent evacuation of feces of a more or less liquid discharge. It may be caused from drinking excess quantities of milk or water or eating large quantities of fat meat, lard, or butter. Foods will sometimes produce diarrhea by their irritating action on the mucous membranes. It may also be caused from eating such substances as table scraps containing fruit stones, parings, salty fish, and cheese.

(2) *Treatment*.—All food should be withheld for 24 to 48 hours. Castor oil, from $\frac{1}{2}$ to 1 ounce is valuable. If the

diarrhea persists following this treatment, tincture of opium may be given.

b. Constipation.—(1) *Symptoms and causes.*—Constipation is infrequent or difficult evacuation of feces which are abnormally dry or hard. The common causes of constipation in dogs are lack of exercise and feeding dry food.

(2) *Treatment.*—Constipation may be relieved by the use of a purgative, such as from $\frac{1}{2}$ to 1 ounce of castor oil. The proper diet and exercise should be provided.

■ 61. *INJURIES.*—*a. Wounds.*—(1) *Types.*—Wounds are divided into incised wounds or cuts, lacerated wounds or tears, and puncture wounds or holes.

(2) *Treatment.*—(a) *Precautions.*—Cleanliness of the wound itself, of the dressings, and the dresser is of the greatest importance.

(b) *To stop bleeding.*—Often just pressure with a snug bandage is sufficient to control the flow of blood. Sometimes tight bandaging above and below the wound is necessary. If a large blood vessel is cut and the end exposed it should be ligated. This can be done by tying the vessel with a clean thread which has been soaked in an antiseptic.

(c) *To clean.*—Cut the hair from the edges of the wound. Remove all dirt, clots of blood, splinters, and foreign bodies of all kinds. This may be done by careful syringing of the parts with clean, warm water or clean antiseptic solution.

(d) *To close.*—Large gaping wounds should be closed with stitches, tightly bandaged, and firmly fastened with adhesive tape to prevent the dog from tearing out the stitches. In applying stitches the edges of the wound should be brought together in their natural position. The needle and thread are passed through the skin at one side of the wound and out at the other and tied so as to approximate the edges without tension. Stitches should be from $\frac{1}{4}$ to $\frac{1}{2}$ inch from the edge and about $\frac{3}{4}$ of an inch apart. The stitches may be removed in 8 to 10 days.

(e) *Drainage.*—Should infection develop, several of the lower stitches are removed and the edges of the wound spread to allow for drainage.

(f) *Dressings.*—Wounds should be treated promptly after the injury occurs with an antiseptic, preferably with tincture of iodine, dried carefully with gauze or cotton, covered with dry gauze, and a bandage applied. After a wound has begun to fill in with repair tissue it will often heal much better if no dressing or bandage is placed in contact with the wound, providing it is not irritated with flies. It is preferable to rest a dog until wounds are healed.

(g) *After care.*—All wounds should be kept dry, and the dressings should be changed only often enough to keep the wound clean. As little washing as possible should be done and the parts sopped instead of rubbed.

b. *Contusions.*—Contusions (bruises) are injuries of a part without a break in the overlying skin, frequently caused by a blow from a blunt object.

(1) *Symptoms.*—When over a muscle, they produce soreness and lameness and if severe may rupture a blood vessel which will result in a fluctuating swelling caused by an accumulation of blood, usually just under the skin.

(2) *Treatment.*—Rest and hot applications. In bruises where there is a fluctuating swelling that does not reduce in 7 to 10 days, the swelling may be opened with a knife at its lowest point to allow the fluid contents to escape. After opening, the incision should be kept clean and painted with iodine once daily.

c. *Sprains.*—A sprain is an injury to a joint without any break in the overlying skin. It is caused by twisting or pulling of the joint or bending the joint beyond its normal range of action resulting in the stretching or tearing of the ligaments.

(1) *Symptoms.*—Marked lameness; heat and swelling over the joint and tenderness on pressure or movement.

(2) *Treatment.*—Rest and hot applications and massage with chloroform liniment once or twice a day.

d. *Strains.*—A strain is an injury to one of the larger muscles or muscle groups resulting from stretching or tearing which is caused by sudden and marked muscular action.

(1) *Symptoms.*—Pain, tenderness, swelling, and disability in the region affected.

(2) *Treatment.*—Hot applications and rest.

e. Fractures.—Fractures are broken bones, classified as simple and compound. In a simple fracture there is no break in the overlying skin. In a compound fracture a fragment protrudes through the broken skin.

(1) *Symptoms.*—If any long, supporting bone of the leg is completely fractured, the leg dangles helplessly and will bear no weight. In incomplete fractures there is usually swelling, tenderness, and loss of weight-bearing capacity, with or without deformity.

(2) *Treatment.*—Incomplete fractures may be supported with a tight bandage and should heal with 2 to 3 weeks' rest. In simple complete fractures of an extremity, splints may be used, but are difficult to keep on, and complete rest in a very small enclosure for a period of 3 to 4 weeks is necessary. In all fractures the services of a veterinarian should be secured. Until professional assistance arrives the patient should be confined in a box or similar enclosure just large enough to permit the animal to lie down. In case of compound fractures a gauze pad saturated in 70-percent alcohol should be placed over the broken skin and held in place with adhesive tape. Dogs with compound fractures are very successfully treated by veterinarians, if their services are available, and should not be destroyed.

■ 62. **DEW CLAWS.**—Dew claws on hind legs are prone to injury when a dog breaks trail through crusted snow, resulting in lameness. It has been noted the "Husky" strain of sled dog does not have dew claws on the hind legs. It is recommended that dew claws on the hind legs of puppies be cut off as a prophylactic measure.

■ 63. **TOENAILS.**—Ordinarily the nails wear down naturally, but if the dogs are used in soft snow for long periods, the nails may require paring. Inspection should be made regularly and the hard ends of the nails cut off when necessary. Very long nails may pull out and cause lameness.

■ 64. **SHEDDING.**—Twice yearly healthy dogs shed some of their hair. This usually falls out naturally, but if the dogs seem irritated, they can be made more comfortable by combing.

CHAPTER 6

TRANSPORTATION OF DOG TEAMS

■ 65. MOVEMENT BY TRUCK.—*a.* Advantage should be taken of available motor transportation to move the dogs as far forward as the roads can be kept open. Beyond the point where any land transport except men on foot can move, dog transportation is useful under favorable conditions.

b. A full-size cross country sled and a team of 13 dogs can be loaded in a 1½-ton truck. The sled is lashed in a central position with the bow projecting over the tailgate which is adjusted to the horizontal position. The dogs are then tied up short on both sides of the sled with chains from 8 to 12 inches long either attached to the sled or passed around the bows of the truck cover.

c. The dog driver will determine the sequence in which the dogs are to be loaded, arranging them in the order which, in his best judgment, will minimize fighting and keep together those that will require special attention. A moderate load may then be spread out evenly over the sled, except for the projecting bow upon which the harness or a few light articles only may be placed. The driver should ride on top of the load, free to move and control the dogs. As some dogs become sick from riding in a truck, it is desirable to wait a few moments after detrucking before starting the sled team.

d. At the detrucking point, two assistants should be available to help unload the dogs and sled. Each dog is fastened to the truck, as soon as unloaded, with a chain short enough to prevent him from fighting the others. After the sled is unloaded, it can be anchored to the truck, in the absence of a more convenient object, while the team is being hitched. One extra truck for each three or four dog teams transported will be necessary to haul the balance of the sled loads.

■ 66. MOVEMENT BY RAIL.—*a.* Two sleds with full loads, two dog teams and their equipment, and a driver and one attendant for each team can be conveniently loaded in a 36-foot boxcar. One sled should be placed in each end of the car,

centrally located, with its bow toward the doors. The dogs should be chained short on either side of their respective sleds to staples driven into the sides of the car. At least one attendant should be with each team at all times.

b. If some straw is available for bedding it will be easier to keep the car clean. A shovel must be available for clearing up droppings and a bucket at hand from which to fill the dogs' individual pans with water.

c. Except in the case of a hard driving storm both doors of the car should be open at all times, one door should be open in any event.

d. No loading facilities will be necessary. With several men available to lift up the sleds and pass up the loads, rations, and dogs, it is possible to load the sled at any place where a man can climb into the car.

e. Sled dogs are fed cold food. When traveling by train, prepared dog food in sufficient quantity should be carried and given to the dogs daily in their pans. The only cooking facilities needed will be those necessary to prepare food for the men accompanying the dogs.

f. It will not be necessary to unload the dogs for rest and recuperation. This would not be practicable in any event unless the ground is covered with snow, as a dog team cannot be handled unless hitched to a sled.

■ 67. MOVEMENT BY WATER.—a. Any seagoing vessel is suitable for the transportation of many dog teams together with their sleds and equipment. If loaded on deck, sleds must be lashed securely in place to prevent them from shifting about.

b. Dogs can be tied short along the ship's rail at any time when bad weather or splashing waves will not wet them. Any crate or box of suitable size will do for a kennel if it is considered desirable to restrain the dogs. Good-sized boxes with flap lids may be utilized provided the lids are propped up a short distance for ventilation and light.

c. The routine of watering and feeding will be carried on daily as at the kennel. Any dog taken out of his box or kennel for a rest and exercise must be held securely by his chain. Attendants should accompany the dogs as it is not desirable to intrust them to the care of members of the crew.

CHAPTER 7

LOADS AND LOADING

	Paragraphs
SECTION I. General	68-70
II. Specific loads for a detachment of Infantry.....	71-74

SECTION I

GENERAL

■ 68. **MANEUVERABILITY.**—In order to understand the problems involved in loading dog sleds, certain information concerning the construction of the sled must be borne in mind. As the principal joints are lashed with babiche (rawhide), a sled is quite flexible. Furthermore, the runners are slightly convex, similar to the rockers of a chair. These factors make the sled, if properly loaded, maneuverable for the dogs and driver.

■ 69. **DRIVER'S RESPONSIBILITY.**—The driver should not ordinarily be required to handle the cargo during the loading and the unloading operations since his attention will be occupied with the team, but he should be directly charged with the following responsibilities:

a. Maximum load should not be exceeded unless ordered by proper authority.—The following empirical formula will determine the maximum pay load for a freight team operating on a good, well-packed trail. Allow three dogs of the team to pull the sled, equipment, and driver. Then allow 100 pounds of pay load for each additional dog of the team. Thus, a team of nine dogs should not be required to pull more than 6 times 100, or 600 pounds pay load. This load should not be exceeded except for short hauls over level country and then only when specifically authorized.

b. Proper location and distribution of load on basket sled.—Efficient loading insures the maximum use of cargo carrying

capacity and safety in transit. If a load is not properly balanced the sled will be in constant danger of overturning; and it will be difficult for the driver and dogs to handle. The following principles should be adhered to in loading all freight-carrying sleds:

(1) The heaviest part of the load should be placed just in rear of the center of gravity of the sled. When the center of gravity of the load is in this position, the sled will pivot easily upon the convex runners when it is pulled to the right or left by the rear pair of dogs to keep it on the trail. This pivoting action will also enable the driver to steer the sled, either by throwing his weight from side to side or by lifting up on the handle bars and shifting the rear of the sled to the right or left.

(2) The heaviest part of the load should be placed on the bottom and evenly distributed on the right and left sides.

(3) Cargo should be nested carefully together in order to prevent the load from shifting.

(4) Unless very light, the load should not be higher than the sides of the sled. A high load has a decided tendency to cause swaying, augments the danger of overturning, and makes the sled exceedingly difficult to maneuver.

(5) A light, bulky load should never be built up to a point where it will obstruct the vision or freedom of movement of the driver when in position at the rear of the sled.

(6) Since the sled is not a covered vehicle, articles comprising the load should be packed in containers which will withstand the elements.

c. Securing load to sled.—(1) Small packages should be assembled and placed on mantas and tied into bundles the width of the sled before loading.

(2) When the load is in position it should be securely lashed on the sled. Two 30-foot pieces of quarter-inch rope are necessary to lash the ordinary cargo to the sled. Lash hooks or cleats are usually provided under the bed rails of cargo-carrying sleds. The following procedure should be followed when lashing the load:

(a) Tuck all loose ends or protruding parts of the load inside of the top rails and uprights.

(b) Fasten one end of a lash rope to front lash hook or cleat.

(c) Pass the lash rope under the top rail of the sled, diagonally across the top of the load, under the opposite top rail, then around a cleat or lash hook, and take up the slack.

(d) Continue the process until the rear of the sled has been reached and secure the end of the rope.

(e) Using the second lash rope, start at the other front corner of the sled, repeat the procedure indicated above, using alternate cleats or lash hooks, and secure the end of the rope at the rear of the sled.

d. Safety of load in transit.—After the load has been placed on the sled, the driver becomes responsible for its safety until the destination is reached.

■ 70. TRAILERS.—When only one dog team is available to handle a bulky load which exceeds the capacity of one sled, but is not beyond the capabilities of the team, a loaded sled may be hitched in rear by means of a tow pole (fig. 10). It should be attached to the bed of the leading sled at one side, in order not to interfere with the driver, and to the bow of the sled being towed. The tow pole should be of such a length that the driver can reach the gee pole of the rear sled to steer it while mushing his own sled.

SECTION II

SPECIFIC LOADS FOR A DETACHMENT OF INFANTRY

■ 71. GENERAL.—An infantry detachment of 39 riflemen and one light machine-gun squad and one 60-mm mortar squad attached, together with field equipment, ammunition, and 4 days' rations for men and dogs, may undertake operations employing dog transportation in the following manner:

a. Train.—Rations for 4 days for men and dogs for a detachment of 39 riflemen and one light machine-gun squad and one 60-mm mortar squad, together with kitchen equipment and tools, may be loaded on two sleds in the following manner:

(1) Divide the equipment and supplies into two loads of equal weight. Care should be taken that the field range, kitchen tentage, and tools are kept together on one sled.

(2) Next place the field range on edge just in rear of the center of gravity of the sled. Other articles should be placed around the field range to prevent it from shifting about.

(3) Crosscut saws, because of their length, should be placed on the bottom of the sled with the teeth pointing inward.

(4) Axes should be sheathed and placed where they will be easily accessible.

(5) Other components of the load should be placed on the sled so that the heavier items are at the rear and the lighter articles are toward the front.

(6) Small articles should be made up into convenient packages for loading. Empty gunny sacks are useful for this purpose.

(7) It is desirable that quarters of beef be boned and placed in light containers.

(8) Bread should be packed in a cardboard container or in a canvas bag and loaded on the forward part of the sled. Mattress covers make excellent bread carriers.

(9) Transportation of liquids and canned goods subject to damage by freezing should be avoided and articles such as powdered milk and eggs should be substituted.

(10) Dog rations for the team should be loaded on the front of each sled.

(11) For individual packs, see *d* below.

b. Combat loads.—Two light machine guns and one 60-mm mortar with a supply of ammunition may be loaded on one sled in the following manner:

(1) *Light machine guns.*—Two light machine guns and 1,750 rounds of ammunition per gun should be loaded on a basket sled in the following manner:

(a) Place a layer of ammunition chests, lying on their sides, on the bottom of the sled.

(b) Place a light machine gun, muzzle to the front, bolt handle up, and its tripod folded, cradle to the front, on top of the ammunition chest at the rear of the sled, gun on the

left side and tripod on the right. Between trail legs and gun, place an ammunition or spare parts chest.

(c) In front of the first gun and tripod place a second gun and tripod in similar manner except reverse the position and place the gun on right side, tripod on the left.

(d) Place a light tarpaulin or canvas, folded to appropriate size, over the load and lash all securely to the sled.

(2) *60-mm mortar*.—A 60-mm mortar complete with 60 rounds of ammunition may be loaded on the same sled with the light machine guns in the following manner:

(a) In front of the light machine-gun load place the mortar and bipod on the right side of the sled. On the left side place the base plate and accessories.

(b) In between these pieces and in front of them place the loaded ammunition containers.

(c) Cover all with a canvas or light tarpaulin and lash securely to the sled.

NOTE.—The regular sled equipment and 4 days' rations for the dogs may be loaded in front of the two light machine guns and 60-mm mortar and their ammunition, and lashed with the rest of the load.

(3) *Ammunition*.—The ammunition load of 160 rounds per man for a detachment of 39 men can be carried on one sled in the following manner:

(a) Remove the metal containers with the ammunition from the wooden box.

(b) Place the four metal boxes of ammunition flat on their sides on the bottom of the sled, starting from the center and loading toward the rear.

(c) The additional 240 rounds required may be put in a canvas bag and placed in front of the four metal boxes.

(d) Lash the load securely to the sled.

NOTE.—The regular sled equipment and rations for 4 days for the dogs pulling the sled may be placed forward of the ammunition load.

■ 72. WEIGHTS.—The following table gives the weights of the articles comprising the above loads:

Load	Item	Pounds	Total
No. 1...	1 range, field, No. 2.....	150	782
	Tentage and tools.....	150	
	44 dog rations, 3 pounds each.....	132	
	70 rations, 5 pounds each.....	350	
No. 2...	44 dog rations, 3 pounds each.....	132	802
	134 rations, 5 pounds each.....	670	
No. 3...	2 light machine guns.....	40	781
	2 tripods, light machine guns.....	62	
	3,500 rounds (14 belts).....	287(389)	
	1 60-mm mortar.....	28	
	1 base plate and accessories.....	23	
	60 rounds, 60-mm ammunition.....	209(260)	
No. 4...	44 dog rations, 3 pounds each.....	132(132)	558
	6,240 cartridges ball, cal. .30.....	450	
	36 dog rations, 3 pounds each.....	108	

NOTE.—Three sleds with teams of 11 dogs each should be used to transport loads Nos. 1, 2, and 3, and one sled with a team of 9 dogs for load No. 4. Three of the dogs in each team are provided for the sled, driver, and regular sled equipment.

■ 73. INDIVIDUAL PACKS.—When troops are operating in very cold country the special equipment required by the individual is decidedly heavy and bulky. For this reason it is desirable that whenever possible a portion of the soldiers' pack be transported by sled. When the sleds can precede the marching column to the new bivouac area it will usually be possible, because of their greater mobility, for them to return empty and pick up the sleeping bags on a second load. The sleeping bags, packed with the men's extra clothing and weighing about 25 pounds each, can be readily carried by three sleds. By this method the packs may be lightened without increasing the amount of dog transportation when the march does not exceed 9 miles.

■ 74. HEAVY WEAPONS EQUIPMENT.—Heavy weapons sections may be transported by dog team in the following substitution of each type section for the rifle company weapons squads:

	Load	Item	Pounds	Total
Or-	No. 3.....	2 heavy machine guns (cal. .30).....	67	646
		2 tripods.....	102	
		5,750 rounds.....	471	
	No. 3.....	2 81-mm mortars (complete).....	272	872
		60 rounds M-3 (light shell).....	600	

NOTE.—No. 4 sled could be utilized to carry the second section of a heavy weapons platoon, or for extra ammunition.

INDEX

	Paragraphs	Pages
Basket sled	14	15
Brakes, sled	18	20
Care and feeding dog team	25-29, 46, 50	26, 40, 41
Chains, neck, harness	12	12
Claws, dew, care	64	65
Collars, harness	9	10
Choke	11	12
Commands, dog team	31	30
Dog team:		
Classification	2	1
Equipment, field	42	37
Feeding and care	25-29, 46, 50	26, 40, 41
Harness	6-13	5
Hitches	5	3
Loads and loading	68-70	68
Infantry detachment	71-74	70
Management, field	41-50	37
Care	46	40
Driving	48	41
Harness and sled	47	40
On the trail	41	37
Rate of travel	49	41
Starting	45	39
Teaming up	44	38
Tired or injured dogs	50	41
Training	30-40	29
Transportation for:		
Rail	66	66
Truck	65	66
Water	67	67
Use	1	1
Dogs:		
Ages	4, 53	3, 49
Anatomy, treatment, breeding, spaying, wear- ing, etc	51-53	43
Diseases:		
Classes	58	51
Communicable	59	51
Inspection for	56	50
Noncommunicable	60	62
Prevention and first-aid treatment	54-60	49
Symptoms	55	50
Veterinary kit, use	57	50
General structure	51	43
Injuries:		
Classes	58	51
Dew claws	62	65
Prevention and first-aid treatment	54, 61-64	49, 63
Toenails	63	65
Veterinary kit, use	57	50

INDEX

	Paragraphs	Pages
Shedding.....	64	65
Shoes for.....	43	38
Sick, inspection for.....	56	50
Temperature.....	52	49
Tired or injured.....	50	41
Types.....	3	2
Vicious.....	35	34
Equipment:		
Dog team, field.....	42	37
Heavy weapons company, transportation by dog team.....	74	74
Feeding and care of dogs.....	25-29, 46, 50	26, 40, 41
Feeding time.....	29	29
Food.....	26	27
Preparation and proportioning.....	27	27
Watering.....	28	28
Fighting among dogs.....	36	34
First-aid treatment for diseases and injury.....	54-64	49
Harness	6, 47	5, 40
Collars.....	9, 11	10, 12
Construction.....	7	5
Neck.....	10	12
Chains.....	12	12
Straps.....	10	12
Towlines.....	13	12
Types.....	8	6
Harnessing dogs.....	38	35
Heavy weapons company equipment, transportation by dog team.....	74	74
Infantry detachment loads for dog team.....	71-74	70
Inspection for sick animals.....	56	50
Kennel veterinary kit.....	57	50
Kennels:		
Construction.....	21	22
Location.....	20	22
Personnel for.....	19	22
Policing.....	22	23
Records.....	23	23
Leaders, dog team.....	32	31
Loads, and loading, dog team:		
Driver's responsibility.....	69	68
Infantry detachment.....	71-74	70
Heavy weapons company equipment.....	74	74
Packs, individual.....	73	73
Weights.....	72	73
Maneuverability.....	68	68
Trailers.....	70	70
Loose dogs.....	37	35

INDEX

	Paragraphs	Pages
Neck:		
Chains.....	12	12
Straps.....	10	12
Packs, infantry, individual, transportation by dog team.....	73	73
Personnel, kennel.....	22	23
Petting dogs.....	32	31
Police, kennel.....	22	23
Puppies, training.....	30	29
Records, kennel.....	24	23
Shedding dogs.....	64	65
Shoes, dog.....	43	38
Sickness, inspection for.....	56	50
Sleds.....	14-18, 47	15, 40
Basket.....	14	15
Brakes.....	18	20
Freight.....	17	17
Messenger or racing.....	15	16
Toboggan.....	16	17
Straps, neck, harness.....	10	12
Teams, dog:		
Classification.....	2	1
Feeding and care.....	25-29, 46, 50	26, 40, 41
Harness.....	6-13, 47	5, 40
Hitches.....	5	3
Loads and loading.....	68-70	68
Infantry detachment.....	71-74	70
Management, field.....	41-50	37
Sleds.....	14-18, 47	15, 40
Training.....	30-40	29
Transportation of.....	65-67	66
Use.....	1	1
Travel rate.....	49	41
Toboggan sled.....	16	17
Toenails, care.....	63	65
Towlines, harness.....	13	12
Trailers, sled.....	70	70
Training, dog team.....	30-40	29
Commands.....	31	30
Fighting.....	36	34
Harnessing.....	38	35
Leader.....	32	31
Loose dogs.....	37	35
Petting.....	32	31
Supervision.....	39	36
Unhitching.....	40	36
Vicious dogs.....	35	34
Whip, use.....	33	32
Unhitching dogs.....	40	36

INDEX

	Paragraphs	Pages
Veterinary klt, kennel.....	57	50
Watering dog team.....	28	28
Whip, dog team.....	33	32

○