

C. Pecorini's Perfect System of Cutting Ladies' Garments



Chicago



Class TT 520

Book P 35

Copyright N^o _____

COPYRIGHT DEPOSIT.

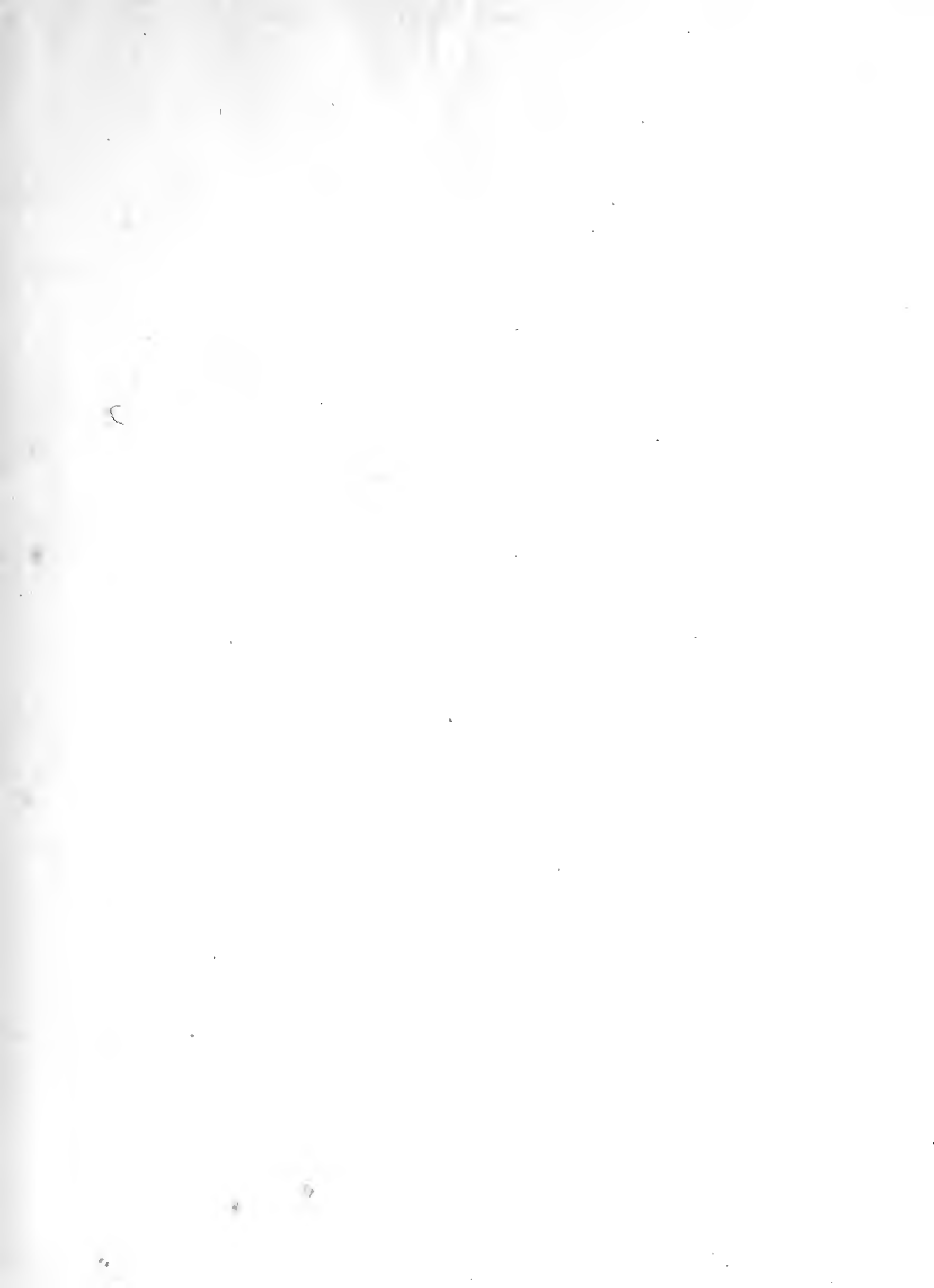

Eugene Pecori's
PERFECT SYSTEM
OF
CUTTING LADIES
GARMENTS

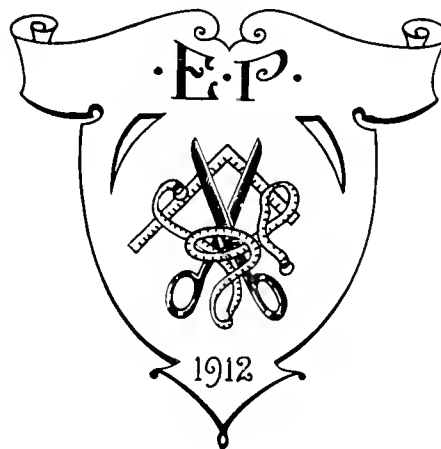

WRITTEN AND PUBLISHED BY
EUGENE PECORI

COPYRIGHTED 1912
By Eugene Pecori

7 / 520
135

PREFACE.

Mr. Eugene Pecoris' Perfect System of Cutting Garments is simple in theory and practical in every sense of the term. It is of paramount importance to every individual, whether advanced or just commencing the study of cutting, he being employed in the ladies' tailoring business since the year 1892; has served not only the largest but the best establishments in New York, Philadelphia and Chicago, and has gained the distinction of being the leading cutter and tailor of ladies' garments.

Since the year 1892, to the present year, 1912, much knowledge has been obtained by the instructor of this system, who has come in contact with many cutters and dressmakers and who listened to many disputes between the people of different chosen work, and has finally come to the conclusion that the theory of cutting perfectly the ladies' garments would be of great importance, coupled with careful practice, would eliminate that faulty fitting garment and also arguments.

In the past years, cutters received highest salaried positions; today, the tailor who studies the system of cutting is more in demand. The necessity of this system being, therefore, of great importance, and especially to the tailors. Mr. Pecori, for this particular reason, thought of publishing the present simple volume, which will be undoubtedly appreciated by all who consult its pages.

Be at once assured that in studying the following diagrams, designed by Mr. Pecori, who has had many years of practical experience in cutting and fitting ladies' garments, you are offered the real foundation of the Perfect System of Cutting.

You may know that ladies' tailoring is progressive in itself and every season we have a change in style and also in fitting. The cutters using a machine or any other method will unquestionably encounter many difficulties, and a faulty fitting garment is the result.

When Mr. Eugene Pecori's System is mastered it can be used forever. The theory is simple and perfectly shown in this volume. Therefore it does not materialize any when styles are changed.

Chicago, 1912.

S. W.

INTRODUCTION.

In introducing Pecori's perfect cutting system we are thereby to do away with all the complications which cause trouble in cutting and fitting ladies' garments. In the illustration of the following diagrams our aim is to emphasize particularly on the points which are most necessary in order to bring out perfect patterns of coats, waists and all other garments which extend from the shoulder to the floor. In applying our system it is not necessary to use special squares or any other kinds of complicated tools. All you need is a tape measure and an ordinary tailor's square. You will notice as you go along with our system that it is based on all straight and definite points. For example, take the Bust line, Waist line and Hip line. These represent the circles of the three main parts of the body. In calling your attention to the facts concerning these three lines, we are convinced that you understand what we mean when we say that in finishing a garment these three lines must be in their right places. Take notice also of the back line which is the main point where we apply our measures or regular proportions. For the regular size use the 36 in. measure for Beginning scholars, which, divided by two equals 18 in. We are using the half 9 in., the third 6 in., the fourth $4\frac{1}{2}$ in., the sixth 3 in., the eighth $2\frac{1}{4}$ in. and the twelfth $1\frac{1}{2}$ in. Notice that these proportions will be found on any regular square whether from 32 to 44 inch sizes they are marked always by halves which means that if, for example, you cut size 40, use 20 for any proportions, or if you want size 34, use 17 and so on for any size. In connection with this explanation scholars should be well posted on the regular tailor's square. We have also an illustration that shows how to take measures. You will see in this illustration that we use very few measures but these must however be taken very carefully to avoid mistakes. Notice the main measures that we take are the Bust, the Waist length, hip and the one that starts from the center of back neck to the point of the Bust down to Waist front. Remember that this last measure is one of the particular points of our system which denotes the high Bust, low bust and the perfect pose of woman whether stooped or straight. This you will find in the course of our system. As these are facts based upon years of experience we beg our scholars to be careful and pay particular attention to these things. If you follow our instructions you will see for yourself that in fitting a garment you will have no trouble, no twisting, no wrinkles of any kind, but a beautiful hanging garment.

HOW TO TAKE MEASUREMENTS.

The correct fitting of a garment depends entirely on the manner applied in taking measurements from the person for whom it is made and it is for this reason that we have founded the Pecori System on a basis of simplicity, which requires only the principle and necessary measurements for cutting garments. With the diagrams on the opposite page we illustrate the front and back of a lady. Always take the measurements from the back first. Measure from No. 2 to 9 for the waist length; from No. 9 to 13 is the full length of a garment and from 5 to 7 for the width of shoulders. Then place your half at No. 7, come down to 14 for the elbow measurement and down to 15 for the full length of shoulder and sleeve. In the taking of these measurements from 2 to 9 for the waist length and from 5 to 7 for the shoulder width, exceptional care must be taken as they are the most important part of the diagram. Exceptional care should also be taken in the following measurements for the front. Measure from 6 to 7 for the bust; from 8 to 10 for the waist and from 11 to 12 for the hip in each case going completely around the body. These are the three most important measurements for the front. We also give you another measurement. Place your measure on No. 2 of the back diagram, cross around the neck to 3, come down to the point of bust and down to 9. Remember that these measurements must be taken very accurately and you will find in the course of practice that they give you the principle proportions of the lady. Also measure from 6 to 8 of the front diagram for the length from waist to arm hole and from 6 to 16 to 17 for the full length of sleeve. These are the main measures of coats and all garments running from shoulder down.

MEASUREMENTS FOR SKIRTS.

There are only 5 skirt measurements. Measure from 8 to 10 for the waist, from 11 to 12 for the hip; from 9 to floor and 8 to 11 to floor for the length. Measure the back in exactly the same manner. These measurements must be taken very accurately to cut with Pecori's system.

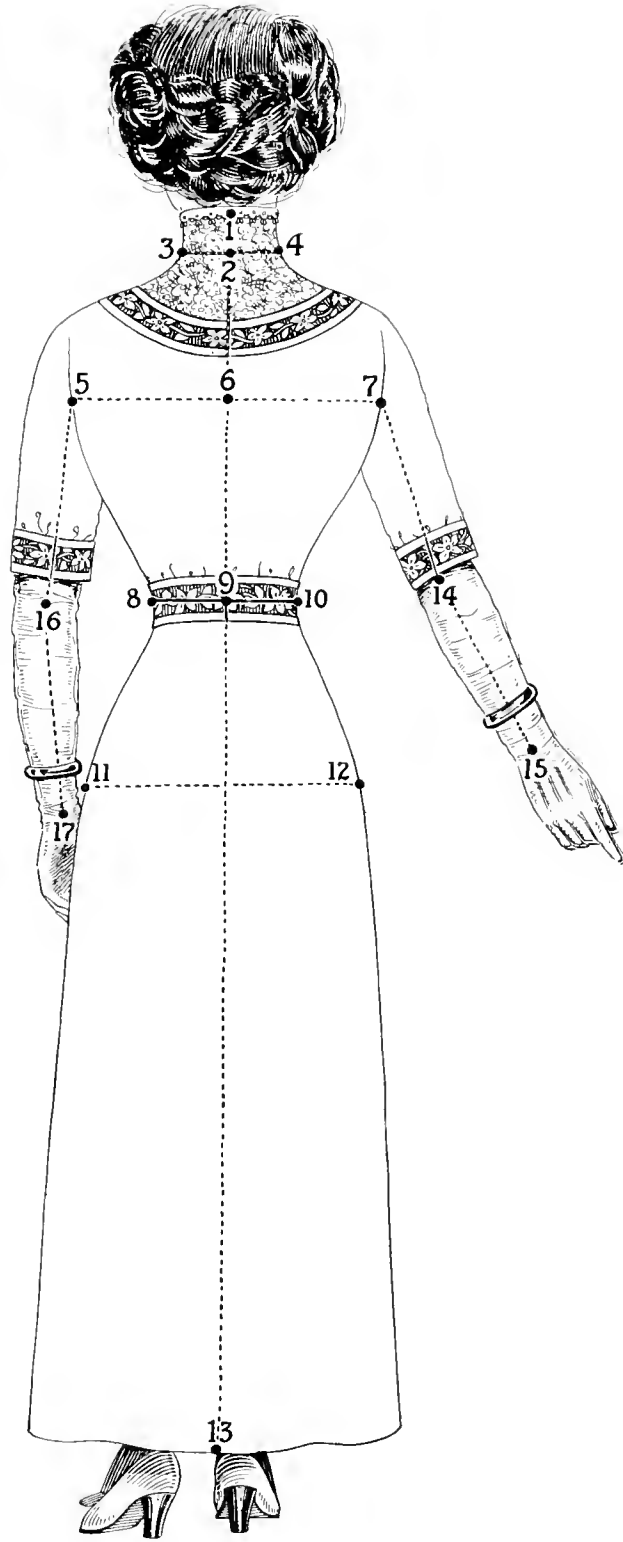
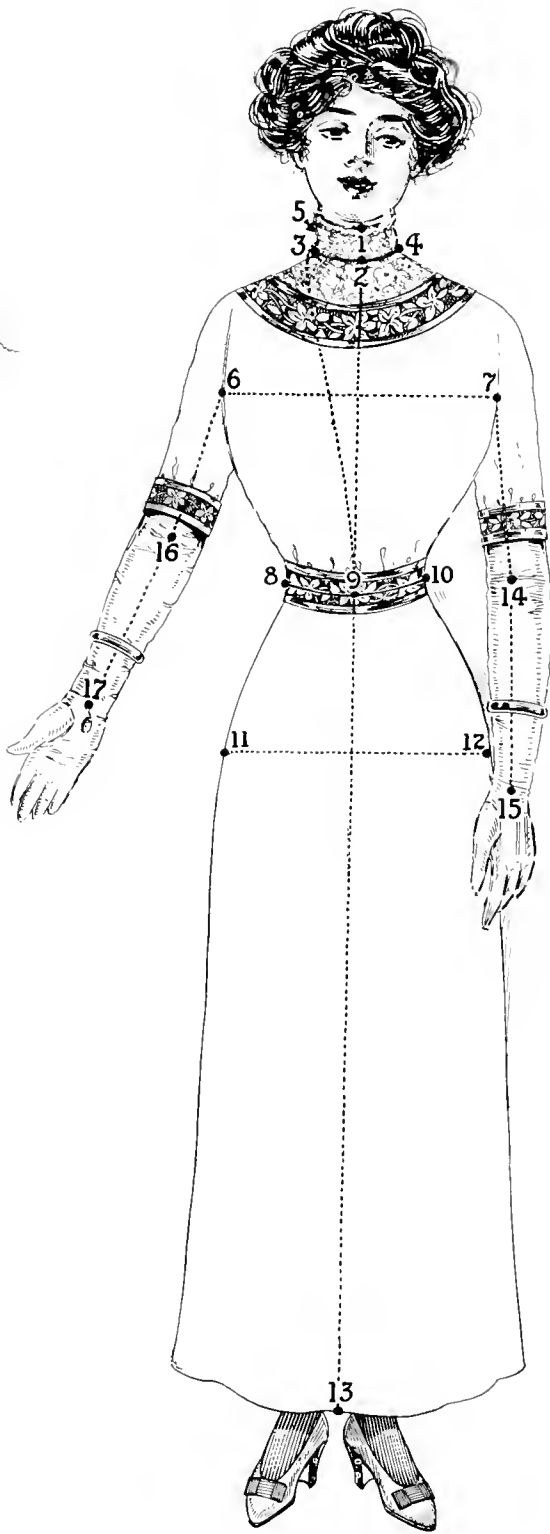

Lesson 1

Diagram No. 1 illustrates the first lesson in a very simple manner. You will find simplicity is the most valuable part of this system. From A to B and from A to C is the regular square from which we will start our proportions, whether from a regular bust measure or from a full woman's measure. Having this square before you, start to draw the following lines: from A to E will be 6 inches, which will mean the depth, and from A to D, which is 15 inches, is the waist length, and from D to F, which is 3 inches, is the hip line. Draw a line from E to S, from D to X and from F to Y. As we are following the 36 Bust measure, half of which is 18 inches, we will continue to follow the instructions according to the usual division. From D to Q is $\frac{1}{8}$ of the Bust measure, which is $2\frac{1}{4}$ inches and square down from A to Q. Place your square on the Q dot and draw a line from Q to G. We wish to call special attention that all the points will start from this line A, J, Q, K and G, which is the back seam of any garment cut with Pecori's system. From J to H is $\frac{1}{2}$ of the Bust measure and from Q to 5 is the same—9 inches. Draw a line from I to E. From 7 to 6 is $\frac{1}{12}$ the Bust measure, which is $1\frac{1}{2}$ inches. From 7 to 9 is $\frac{1}{6}$, which is 3 inches, and from 9 to 8 is $1\frac{1}{2}$ inches. Place your square from 8 to S and draw a line down to Y. From S to M is $\frac{1}{6}$, which is 3 inches. From H to N is $\frac{1}{8}$, which is $2\frac{1}{4}$ inches. From H to W, W to U and U to J are all $\frac{1}{6}$, which is 3 inches. From 3 to 2 is $\frac{1}{8}$, which is $2\frac{1}{4}$ inches, and from 7 to 10 is $\frac{1}{6}$, which is 3 inches. From 5 to O and from O to Z from 7 to 10 is $\frac{1}{6}$, which is 3 inches. From 5 to O and from O to Z is $\frac{1}{6}$, which is 3 inches. Draw a line from U to Z to P and from W to H and you will have the complete diagram as you see it before you. As this diagram is the most part of our system you will have to be careful to carry the instructions to perfection. All garments, from a shirt waist to a long coat and all other top coats, you will get from the same diagram, as you will see in the following ones.

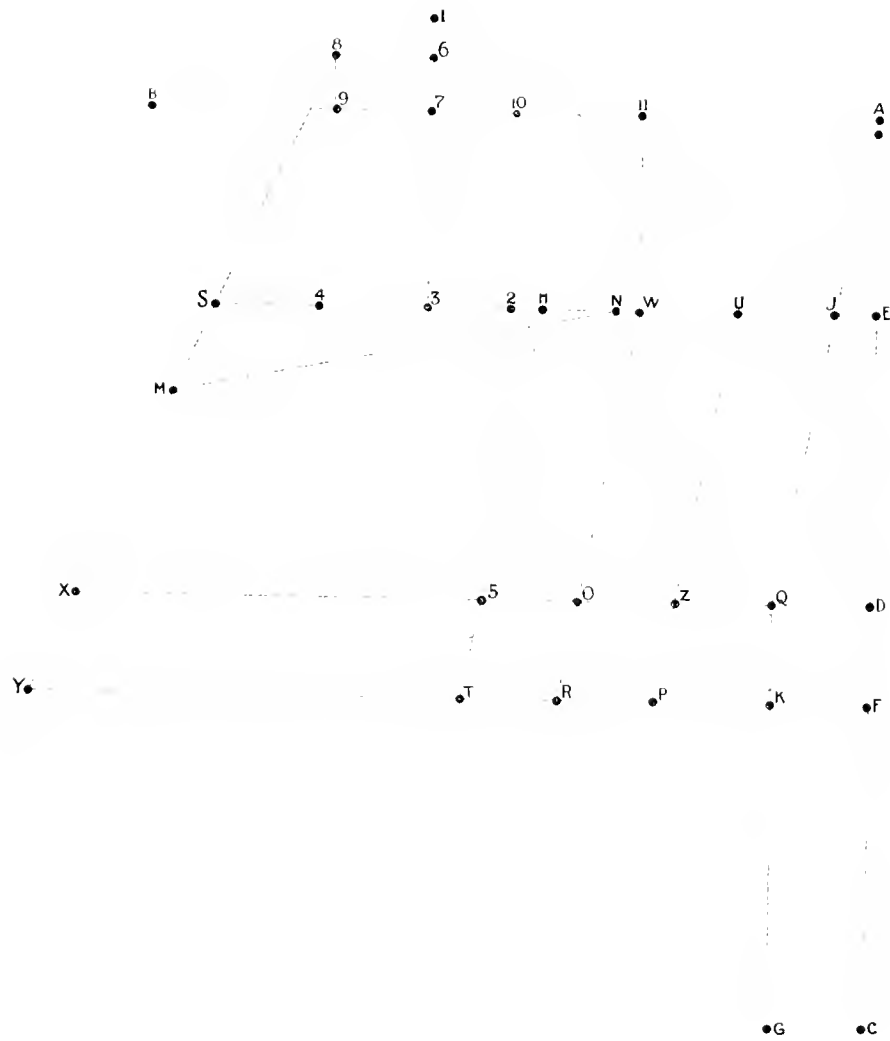

LESSON NO. 1

Lesson 2

In the second lesson we illustrate a complete tight fitting waist. You will notice that the under lines are identically the same as the ones in the first lesson, which you will use for all kinds of waists and coats as we have stated before. Having a diagram of our first lesson drafted completely, you will start to outline the waist that you see before you. From A to 2 is $\frac{1}{8}$ or $2\frac{1}{4}$ in. From A to 1 is $\frac{1}{2}$ in. Curve from 2 to 1. From A to 3 is $\frac{1}{6}$ or 3 in. From 3 to 33 and 44 will give you exactly the back measure from waist down. Draw a line from 2 to 11. From 11 to 13 is $\frac{1}{6}$ or 3 in. From E to 33 is $\frac{1}{6}$ or 3 in. From 35 to 34 to 36 and 38 to 37 to 39 and 41 to 40 is $\frac{1}{16}$ or $1\frac{1}{8}$. Draw a line from 17 to 34 up to shoulder line, from 17 to 36 and 11 to 37. From 13 to 15 is $\frac{1}{2}$ in. Draw a line from 15 to 39, from 23 to 40, and you have the complete back. From 18 to 19 is $3\frac{1}{4}$ in. From 41 to 27 is $\frac{1}{12}$ or $1\frac{1}{2}$ in. Draw a line from 19 to 27. Measure from 23 to 40 and from 19 to 27, which should be equal. From 19 to 20, 21, 22 are $\frac{1}{6}$ or 3 in. From 20 to 7 is $\frac{1}{3}$ or 6 in. and from 7 to 10 is $\frac{1}{6}$ or 3 in. From 7 to 6 and from 7 to 8 are $\frac{1}{6}$ or 3 in. Place your square from 7 to 21 and draw a line down. Do the same thing from 6 to 20. From 20 to 12 is $\frac{1}{8}$ or $2\frac{1}{2}$ in. Draw a line from 5 to 12 and curve from 19 to 12 to 5 from 23 to 15 and you have your arm hole line. Curve your shoulder from 10 to 5. From 8 to 9 is $1\frac{1}{12}$ or $1\frac{1}{2}$ in. Curve from 10 to 9 as shown in the diagram and get your neck line. Next we will show how to use the neck, bust and front waist measure. Measure from 1 to 2. Place your measure in the direction of 3 to 7 and come down to 25 which you will find that the regular size of 36 will measure 15. Follow again until you reach 29, which will give you the correct front waist measure of $21\frac{1}{2}$, which is the regular size. From 27 to 42 is $\frac{1}{8}$ or $2\frac{1}{4}$ in. From 28 to 29 is $\frac{1}{12}$ or $1\frac{1}{2}$ in. Notice that 24, 25 and 28 are placed on the line that comes from 6, 12, 20, 24. The 25 is on the line of 7, 21. From 29 to 30 is $\frac{1}{6}$ or 3 in. Draw a line from 24 to 42, measure distance and get the 28 in the right place.

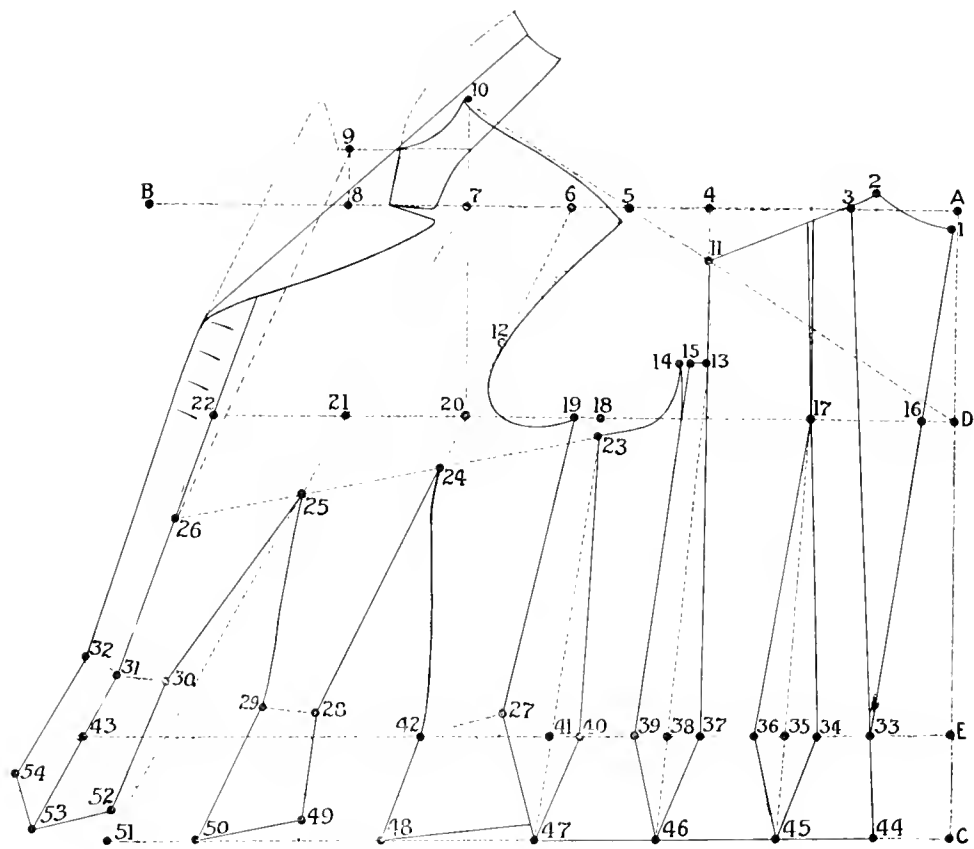

LESSON NO. 2

Lesson 3

The third lesson illustrates a semi-fitting coat with the seam running through the shoulder in back and front with one side body. As you see, the diagram is exactly the same as the first and second lessons. We also wish to call your attention to the fact that every garment that you cut in the line of coats and waists you will have to draft the simple diagram that we show you in the first lesson. Follow instructions same as the previous lessons. A, 48, 49 and 60 forms your back seam. From 48 to 46 is $1/6$ or 3 in. From D to 21 is $1/4$ or $4\frac{1}{2}$ in. From 21 to 22 is $1/16$ or $1\frac{1}{8}$ in. From 46 to 45 is $1\frac{1}{2}$ or $1/12$. From 4 to 5 is $1\frac{1}{2}$ in. or $1/12$. From 22 to 26 is $4\frac{1}{2}$ or $1/4$. From 24 to 17 is $1\frac{1}{2}$ in. or $1/12$. From 17 to 15 is 3 in. or $1/6$. From 15 to 16 is $1/2$ in. From 42 to 43 is $3\frac{1}{4}$ in. Draw a line from 4 to 62, 5 to 22, 22 to 45 and from 26 to 43. Draw a line from 43 to 54 and from 49 to 51 to 52 to 54 must be half of the hip measure, which size 36 is 42. From 42 to 41 is $1/12$ or $1\frac{1}{2}$ in. From 25 to 27 is $1/16$ or $1\frac{1}{8}$ in. 27, 28, 29, 30, 18, 8, 9, 14, 13, 10 are same as previous lessons. From 10 to 69 is the same as 2 to 4. From 7 to 70 is the same as 5 to 16. From 30 to 33 is $1/6$ or 3 in. Draw a line from 24 to 33 and place 32. Draw a line from 69 to 32 and from 70 to 32. From 41 to 35 is $1/4$ or $4\frac{1}{2}$ in. Measure from 26 to 43 and from 27 to 34 must be equal. Draw a line from 32 to 35 and from 27 to 34. From 35 to 36 is $1/4$ or $4\frac{1}{2}$ in. From 32 to 36 must be equal to 32, 35. From 36 to 37 is $1/8$ or $2\frac{1}{4}$ in. Draw a line from 13 to 67. From 67 to 66 is $1/8$ or $2\frac{1}{4}$ in. Draw a line from 36 to 65. From 54 to 56 is $1/3$ or 6 in. Place your square from 35 to 56 and square down to 65. Draw a line from 34 to 54 and from 54 to 63. Allow $2\frac{1}{4}$ in. for button lap and your pattern is complete. Lapels can be high or low at wish. 28 is raised from the line. Square to 29. Draw a line from 25 to 29. Measure distance from 25 to 29. Get your 30 in the right place. Square from 34 to 45, 36 to 45, 37 to 45, 40 to 47, 39 to 46, 27 to 47, 42 to 48, 28 to 49, 29 to 49, 29 to 50 and 30 to 52. From 30 to 31 is $1/12$ or $1\frac{1}{2}$. From 52 to 53 is $2\frac{1}{4}$ in. or $1/8$. Draw a line from 3L to 53. Place your square on dot of 31 and dot of 26 and draw a straight line up and you have completed the center of the front. Allow $1\frac{1}{2}$ in. or 2 in. for button lap. The lapels can be made of any style.

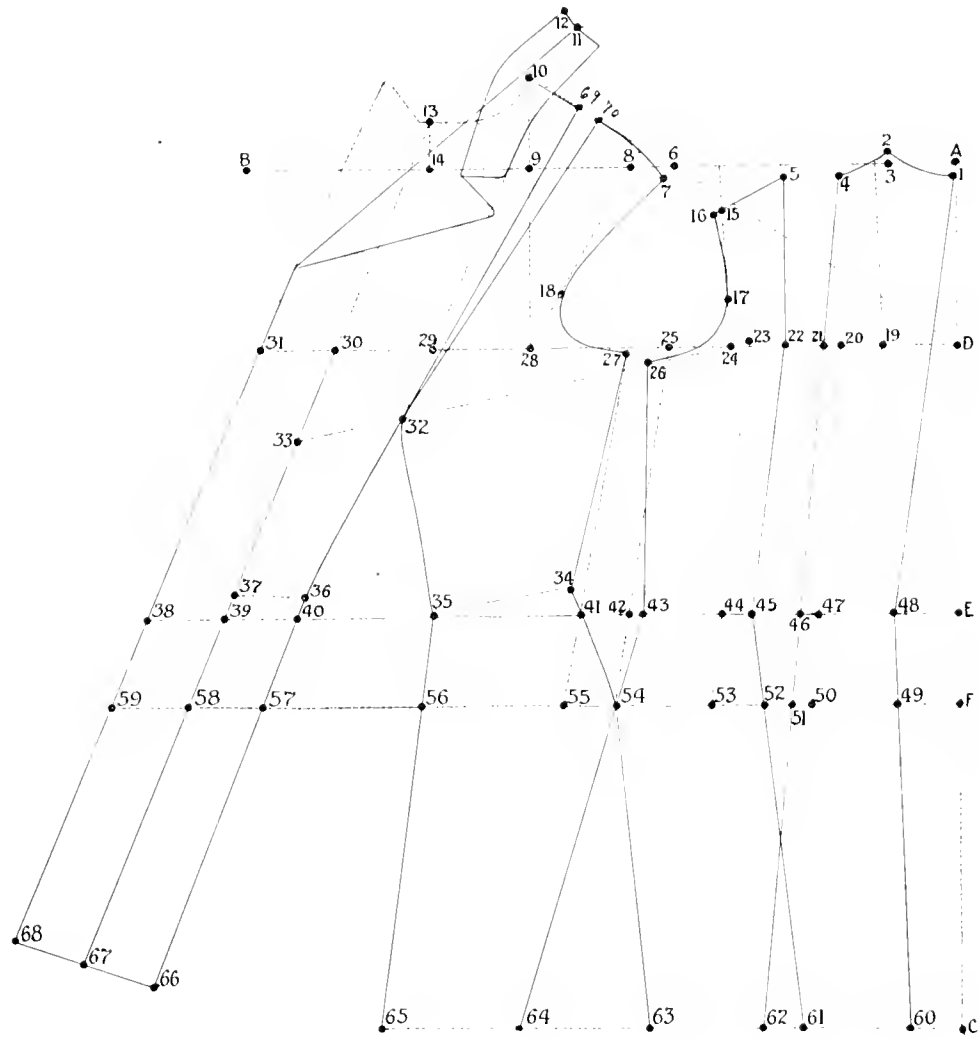

LESSON NO. 3

Lesson 4

This diagram illustrates a semi-fitting coat with one piece back, one side body and a dart. This is cut on the same diagram with little moving of the two seams. A, 7, 3, 38, 47 are the back seam same as the previous coats. From 7 to N is $\frac{1}{3}$ or 6 in. From N to 10 is $\frac{1}{12}$ or $1\frac{1}{2}$ in. From 10 to L is $\frac{1}{6}$ in. From L to PP is $\frac{1}{16}$ or $1\frac{1}{8}$ in. From PP to O to P to 1 is $\frac{1}{6}$ or 3 in. From O, L, S, Q, K, G, T same as previous diagrams. From 3 to 27 is $\frac{1}{4}$ or $4\frac{1}{2}$ in. From 27 to 28 is $\frac{1}{8}$ or $2\frac{1}{4}$ in. From 28 to 30 is $\frac{1}{6}$ or 3 in. From 30 to 31 is $\frac{1}{12}$ or $1\frac{1}{2}$ in. From 31 to 33 is $\frac{1}{4}$ or $4\frac{1}{2}$ in. From 33 to 34 is $\frac{1}{4}$ or $4\frac{1}{2}$ in. From 34 to 37 is $\frac{1}{8}$ or $2\frac{1}{4}$ in. From 1 to 17 is $\frac{1}{6}$ or 3 in. Draw a line from 10 to 17, from R to 56 and get your 18, which is the point of the bust. From 38 to 40 is $\frac{1}{4}$ or $4\frac{1}{2}$ in. From 40 to 41 is $\frac{1}{16}$ or $1\frac{1}{8}$ in. From 41 to 43 is $\frac{1}{4}$ or $4\frac{1}{2}$ in. From 43 to 44 is $\frac{1}{3}$ or 6 in. From 45 to 46 is $\frac{1}{8}$ or $2\frac{1}{4}$ in. From 9 to 13 is $\frac{1}{6}$ or 3 in. Draw a line from 13 to 27, from 14 to 28, from L to 30 and from PP to 31. Measure from H to 30 and from PP to 32 must be equal. Draw a line from 18 to 33, from 18 to 35, from 35 to 56, from 33 to 55, from 32 to 43 to 52, from 30 to 43 to 53, from 28 to 41 to 49 and from 27 to 40 to 40. Curve from H to 15. From 15 to 14 is $\frac{3}{8}$ in., and you have the complete sketch.

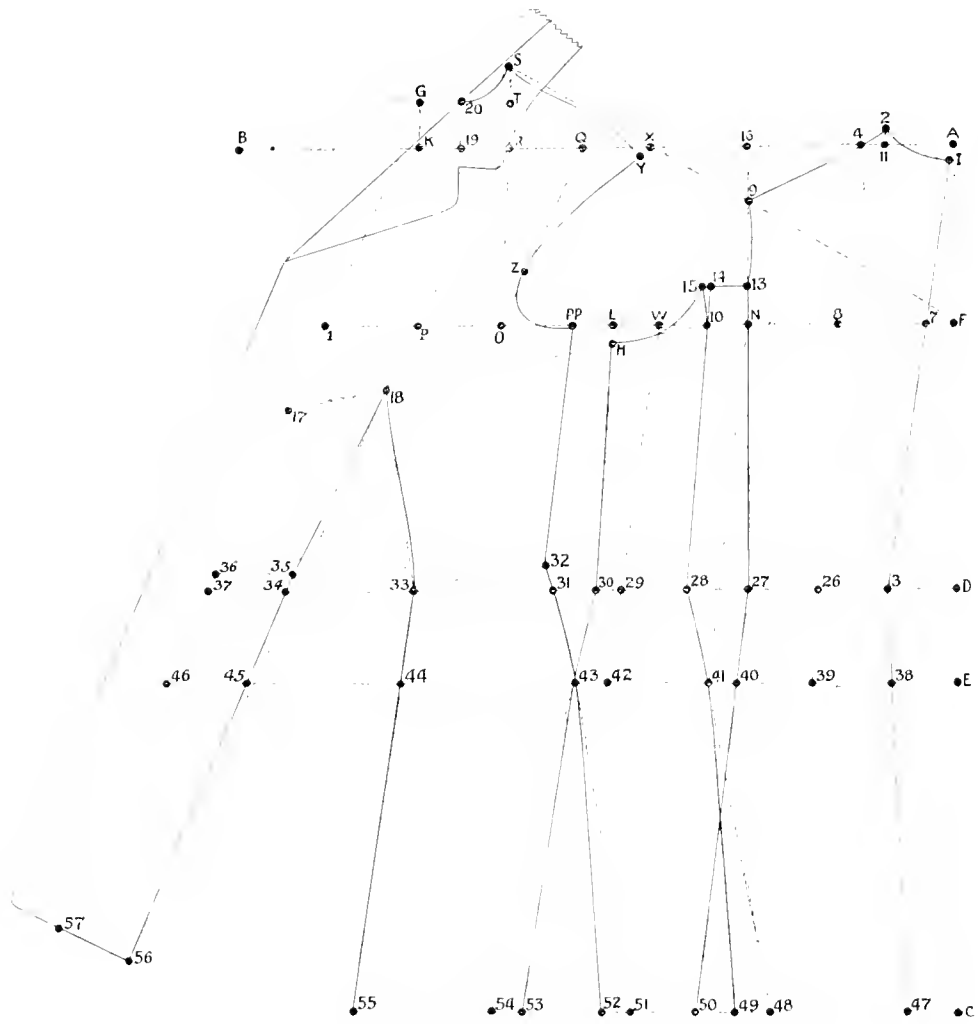

LESSON NO. 4

Lesson 5

In this lesson we illustrate the complete tight fitting coat. As you see, it is the same diagram as in the first lesson. Draw a diagram and start your division. A, 7, 3, 6, 5 are the same as in other diagrams. A to 9 same as any other shoulder. From 7 to 7 is $1/3$ or 6 in. From N to A is $1/8$ or $2\frac{1}{4}$ in. From 9 to 10 is $1/12$ or $1\frac{1}{2}$ in. From N to 12 is $1/6$ or 3 in. From 3 to 26 is $1/12$ or $1\frac{1}{2}$ in. Draw a line from 10 to 8, 26, 31 to 41 as is shown in the diagram. From 26 to 27 is $1/16$ or $1\frac{1}{8}$ in. From 27 to 28 is $1/8$ or $2\frac{1}{4}$ in. Draw a line from 8 to 27, from 27 to 32, from 32 to 40. From 13 to N, 28 and from 28 to 33, from 33 to 53, from 53 to 43. From 13 to 12 is $1/16$ or $1\frac{1}{8}$ in. Curve a line from 12 to 13 as shown in the diagram. From 28 to 29 is $1/12$ or $1\frac{1}{2}$ in. From L to W is $1/8$ or $2\frac{1}{4}$ in. From 29 to 30 is $1/8$ or $2\frac{1}{4}$ in. From W to 14 is the same as from N to 13. Draw a straight line from 14 to 29, from 29 to 33, from 33 to 42. Draw a straight line from L to 30, from 30 to 34, 45. From 14 to 15 is $1/2$ in. Curve as shown in diagram down to H and you have the complete back of the tight fitting. From W to PP is $1/6$ or 3 in. From PP to 20 must be the same as H to 30. From 30 to 20 is $1/12$ or $1\frac{1}{2}$ in. Draw a line from PP to 20, from 20 to 35, from 35 to 44. From 20 to 21 is $1/6$ or 3 in. From 35 to 36 is $1/4$ or $4\frac{1}{2}$ in. Draw a line from 19, 21, 36 to 46. From 21 to 22 is $1/6$ or 3 in. From 22 to 23 is $1/12$ or $1\frac{1}{2}$ in. Draw a line from 19 to 22 to 37 to 47. See that from 19 to 21 is the same as 19 to 22. From 23 to 24 is $1/8$ or $2\frac{1}{4}$ in. Draw a line from 18 to 23, from 18 to 24, from 23, 38 to 48 and from 24 to 39, 49. The front line is the same as in previous diagrams and so the shoulders and all the rest of this garment.

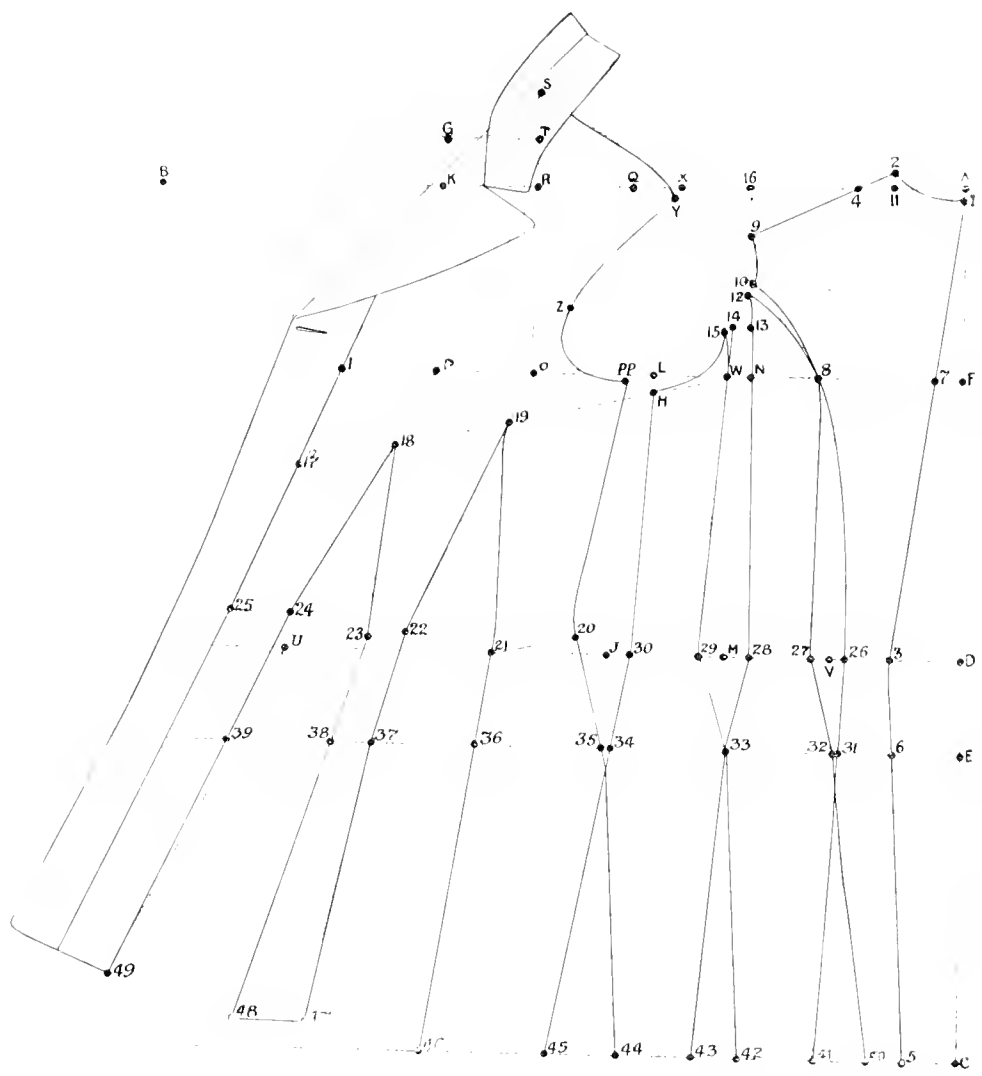

LESSON NO. 5

Lesson 6

In this lesson we illustrate a shirt waist or a loose garment of any kind. As you see, this is always the same system. We present these diagrams to you to impress upon the scholars that no matter what garments you will cut you will use the same diagram as you did in the first lesson. As you see A, 30, 19, 29. A to 5, 30 to 10, 15, 8, 9, 11, 12 are placed on the same lines always. From 30 to 18 is $\frac{1}{2}$ or 9 in. From 15 to 16, from 18 to 17 are $\frac{1}{4}$ or $\frac{3}{4}$ in. From 16 to 15 is $\frac{1}{6}$ or 3 in. From 15 to 14 is $\frac{1}{3}$ or 6 in. Draw a line from 11, 14, 23. Allow 2 in. for button lap and draw a line from 13 to 25 up, from 10 to 11, from 10 to 6, from 6 to 17, from 5 to 18 as shown in diagram. From 21 to 20 is $\frac{1}{16}$ or $\frac{1}{8}$ in. From 21 to 22 is $\frac{1}{16}$ or $\frac{1}{8}$ in. Draw a line from 18 to 20, from 20 to 28, from 17 to 22 to 27. Now you have before you the same draft as shown in the sixth lesson.

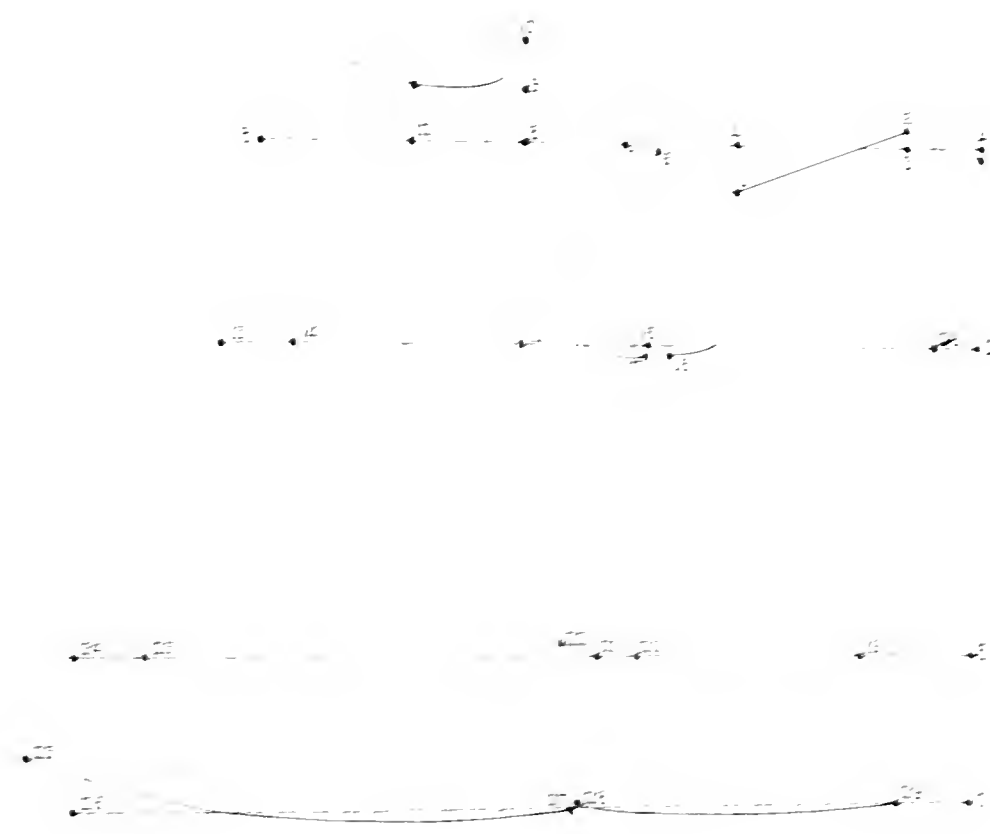

LESSON No 6

Lesson 7

We also have in Lesson 7 a jacket semi-fitting, with seam running through the shoulder down the bust line. As you see nothing has changed in our diagram. It is the same as the previous lessons. As you can see in these first lessons we have illustrated the main ordinary straight coats. This is to show our scholars that no matter what kind of a coat or how many seams or how many side bodies in the garment, he must place them always in the same diagram. As you see that a, g, q, k, 29, g, 3, 4, 8, 9, 5, g, n, W, h, l, 14, 13, 9, 7, s, 24, 27, 37, 10, 14, v, 25, x, y, 38, 6, n, 4, 5, n, q, z, o, 20, x, k, y, are always drafted same as before. The difference in this draft is how to divide it to cut the two side backs, the back and front part. From q to z is $\frac{1}{8}$ or $2\frac{1}{4}$ in. From z to 15 and from z to 16 is $\frac{1}{2}$ in. From 16 to 17 is $\frac{1}{8}$ or $2\frac{1}{4}$ in. From o to 17 and from o to 18 is $\frac{3}{4}$ in. From 18 to 19 is $\frac{1}{8}$ or $2\frac{1}{4}$ in. From 20 to 22 is $\frac{1}{16}$ or $1\frac{1}{8}$ in. From e to h is $\frac{1}{6}$ or 3 in. From h to n is $\frac{1}{8}$ or $2\frac{1}{4}$ in. From n to l is $\frac{1}{6}$ or 3 in. Draw your lines from u to 15 and from n to 16, from 2 to 17, from n to 18, from h to 19 and from l to 22. The measure from h to 19 and from l to 21 must be the same. From 21 to 23 is $1\frac{1}{4}$ or $4\frac{1}{2}$ in. From 3 to 28 is $\frac{1}{3}$ or 6 in. From 5 to 9 must be the same as from 12 to 14. From 8 to 4 must be same as 3 to 14. Draw a line from 9, s, 24, 26 down to 37 and from 8, s to 23, 28, 36. From 21, t, 34, 19, t, 35, 18, r, 32 16 to 30 and 15 to 31. Curve a line from 5 to l from h to oo and allow 2 in. from 14 to 13 and from 38 to 39. Draw a line all the way and you have a complete diagram of the 7th lesson.

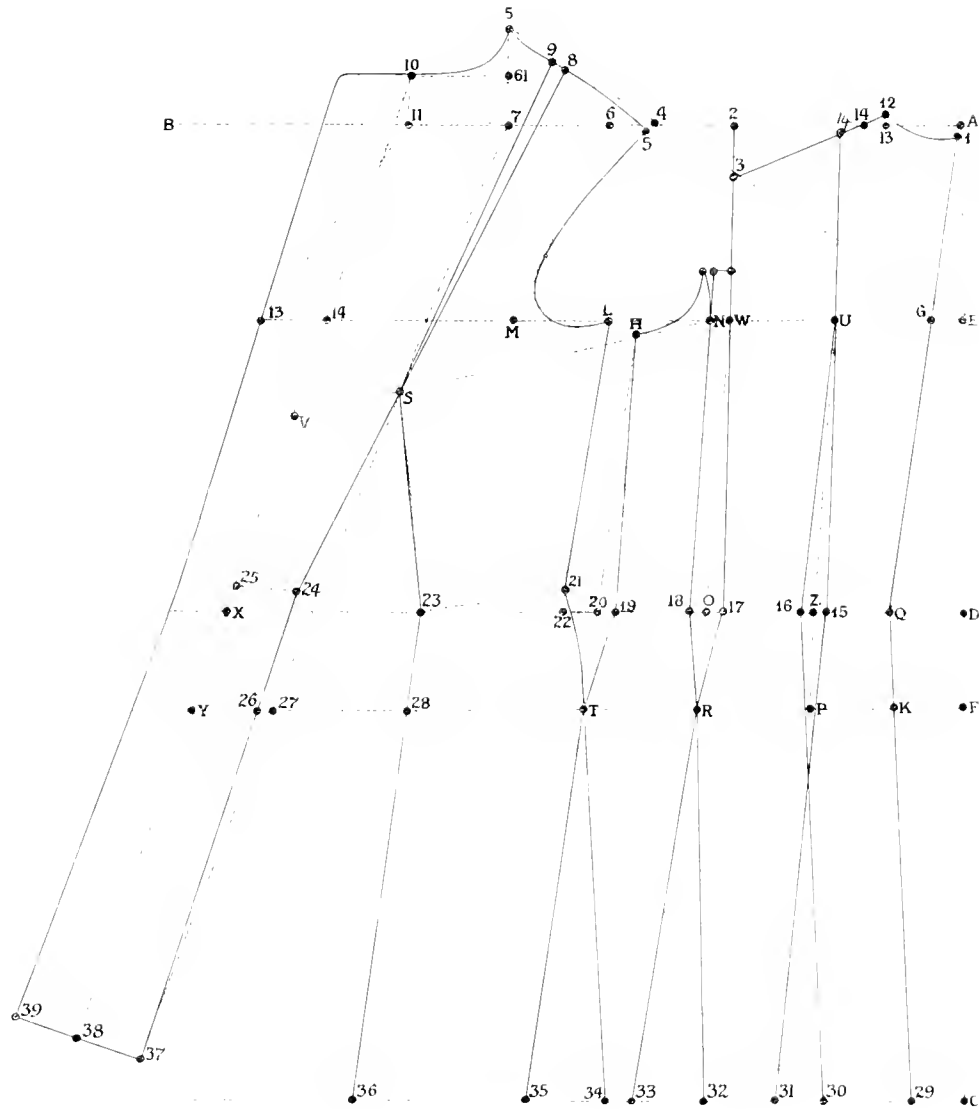

LESSON NO. 7

Lesson 8

Lesson 8 illustrates the regular tailored sleeve. In cutting the sleeve you draw a square on a paper as is shown in the diagram from a to b and a to c. From a to 4 is 12 in. Square down from 4 to 20 and follow measures or division by system. As we show the sleeve for a regular size 36 we will follow this diagram with divisions accordingly. From 9 to 11 is $1/16$ or $1\frac{1}{8}$ in. From 11 to 15 is $1/2$ or 9 in. From 9 to 10 is $1/16$ or $1\frac{1}{8}$ in. Draw a line from 10 to 22, from 11 to 21, from 15 to 3 to 18. From 15 to 14 is $1/6$ or 3 in. From 15 to 12 is $1/8$ or $2\frac{1}{4}$ in. Square 12, 13, 14. From 3 to 31 is $1/8$ or $2\frac{1}{4}$ in. From 31 to 32 is $1/6$ or 3 in. From 11 to 3 is $1/24$ or $3\frac{1}{4}$ in. From 12 to 27 is $2/3$ or 12 in. Draw a line from 27 to 6. From 23 to 24 is $3/4$ in. Curve a line from 3 to 6 to 7. From 24 to 25 is $1/12$ or $1\frac{1}{2}$ in. Draw a line from 10 to 25 to 22. From 18 to 19 is $1/8$ or $2\frac{1}{4}$ in. Draw a line from 17 to 22 and curve 7 to 20 to 22 accordingly. Curve 5, 31, 32, 9, 3 and you have the complete sleeve as in diagram.

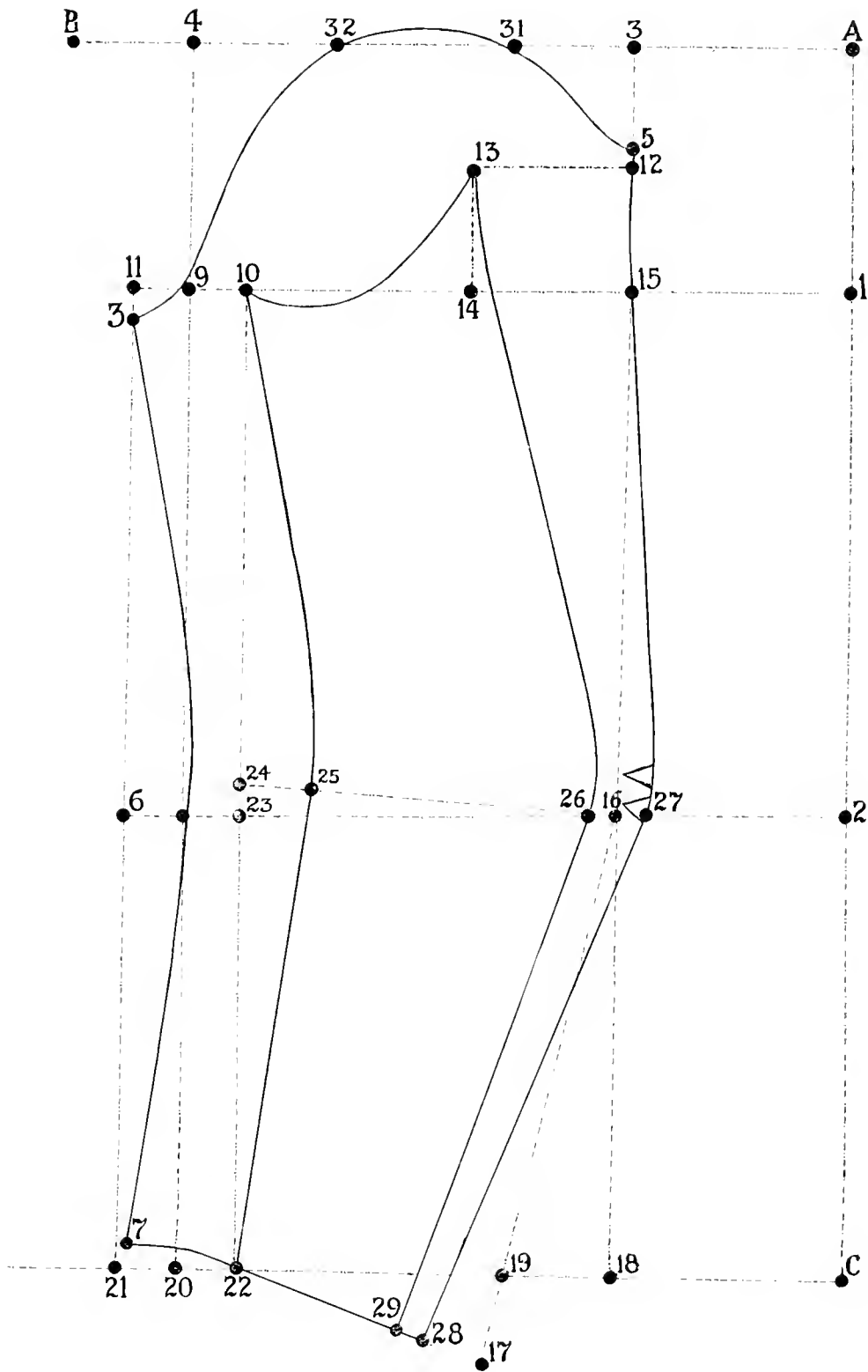

LESSON NO. 8

Lesson 9

Lesson 9 illustrates a tight-fitting sleeve which is generally used for waists. Square down same as lesson 8 and follow accordingly. As you see in the diagram the sleeve gets a different shape. From t to 3 is $\frac{1}{4}$ or $4\frac{1}{2}$ in. From 8 to 4 is $\frac{1}{4}$ or $4\frac{1}{2}$ in. From 3 to 9 is $\frac{1}{8}$ or $2\frac{3}{4}$ in. From 9 to 6 is $\frac{1}{6}$ or 3 in. From 3 to 27 is 1-6 or 3 in. From 27 to 28 is $\frac{1}{6}$ or 3 in. From b to 29 is $\frac{1}{6}$ or 3 in. From 9 to 32 is $\frac{2}{3}$ or 12 in. From 10 to 8 is $\frac{1}{16}$ or $1\frac{1}{8}$ in. From 10 to 11 is $\frac{1}{24}$ or $\frac{3}{4}$ in. From 12 to 16 is $\frac{1}{6}$ or 3 in. From 15 to 17 is 1-12 or $1\frac{1}{2}$ in. From 17 to 16 is $\frac{1}{16}$ or $1\frac{1}{8}$ in. From 1 to 18 and from 1 to 32 is $\frac{1}{16}$ or $1\frac{1}{8}$ in. Draw a line from 6 to 13, from 18 to 24, from 30, 27, 28, 29 to 11 and from 11, 16 to 26, from 6 to 8, from 8, 17 to 34. Draw a line from 22 to 26 and you have a complete tight-fitting sleeve.

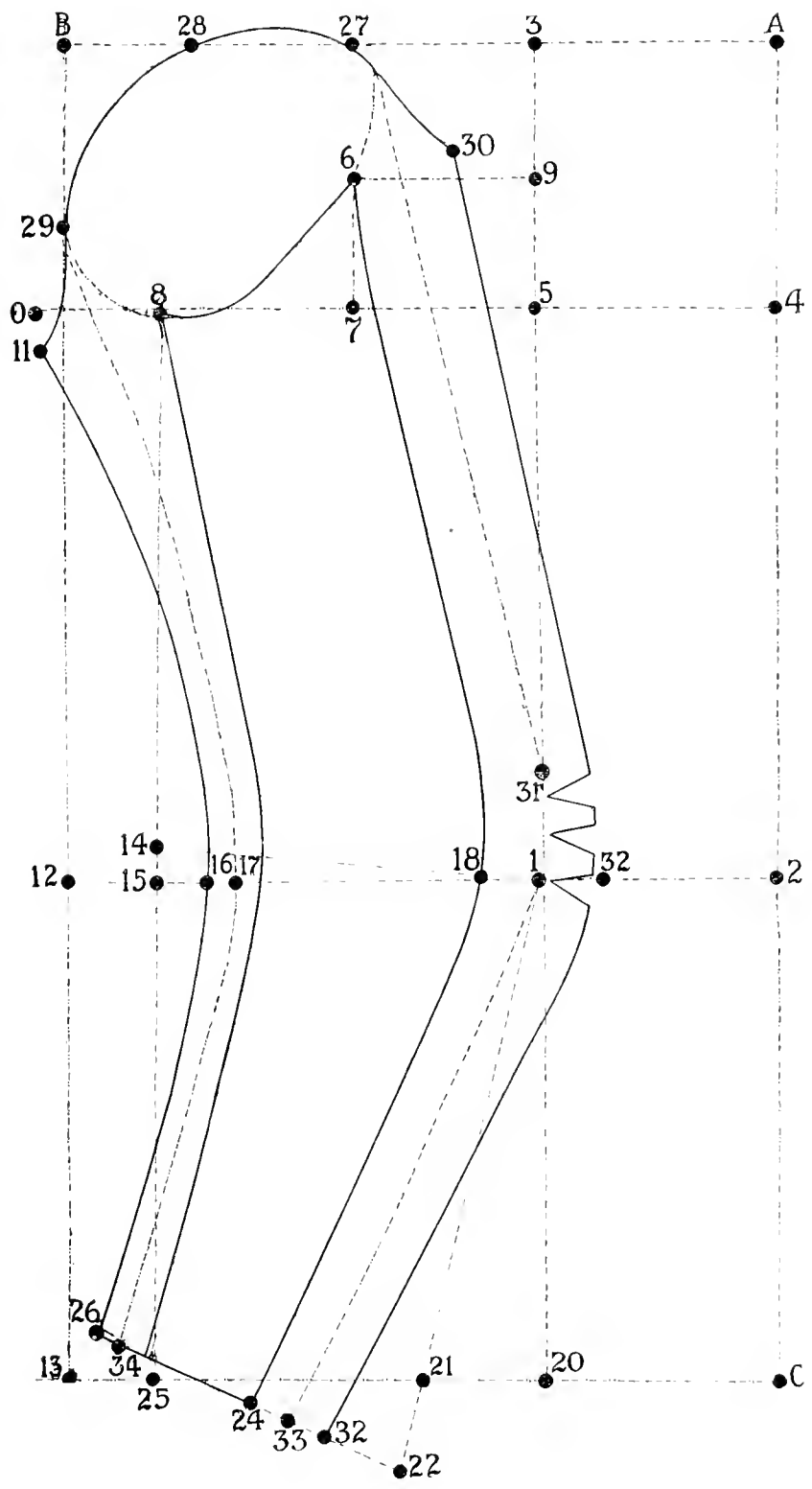

LESSON NO. 9

Lesson 10

In cutting the skirt with Pecori's system we start in the same way with a few simple lines as is shown in the first diagram. We are shown five straight lines which are called the front line, the hip line from waist down, the back line, the hip line around the hip and the waist line. From these five simple lines we show to our learners how to get all the skirts no matter what style or what fullness may be required. Very particular attention should be paid to the value of the five lines for they are the division of all the skirts as you will see as we go along with our illustrations. As we follow the 36-size garment which is 24 waist, 42 hip, front length 41, hip length 43 and $43\frac{1}{2}$ back length. In starting place your square from A to B and from A to C and get your line correctly. From A to D is 1-3 or 6 in. Draw a line from D to E and that will give you the hip line which has to be kept straight all the time. From E to 2 is $\frac{1}{2}$ or 9 in. Draw a line from A to 2 and you have the waist line. From D to H is $\frac{1}{2}$ the hip line or 11 in. Square down to I and up to G, 3 and you have a complete diagram of the Pecori system for cutting skirts.

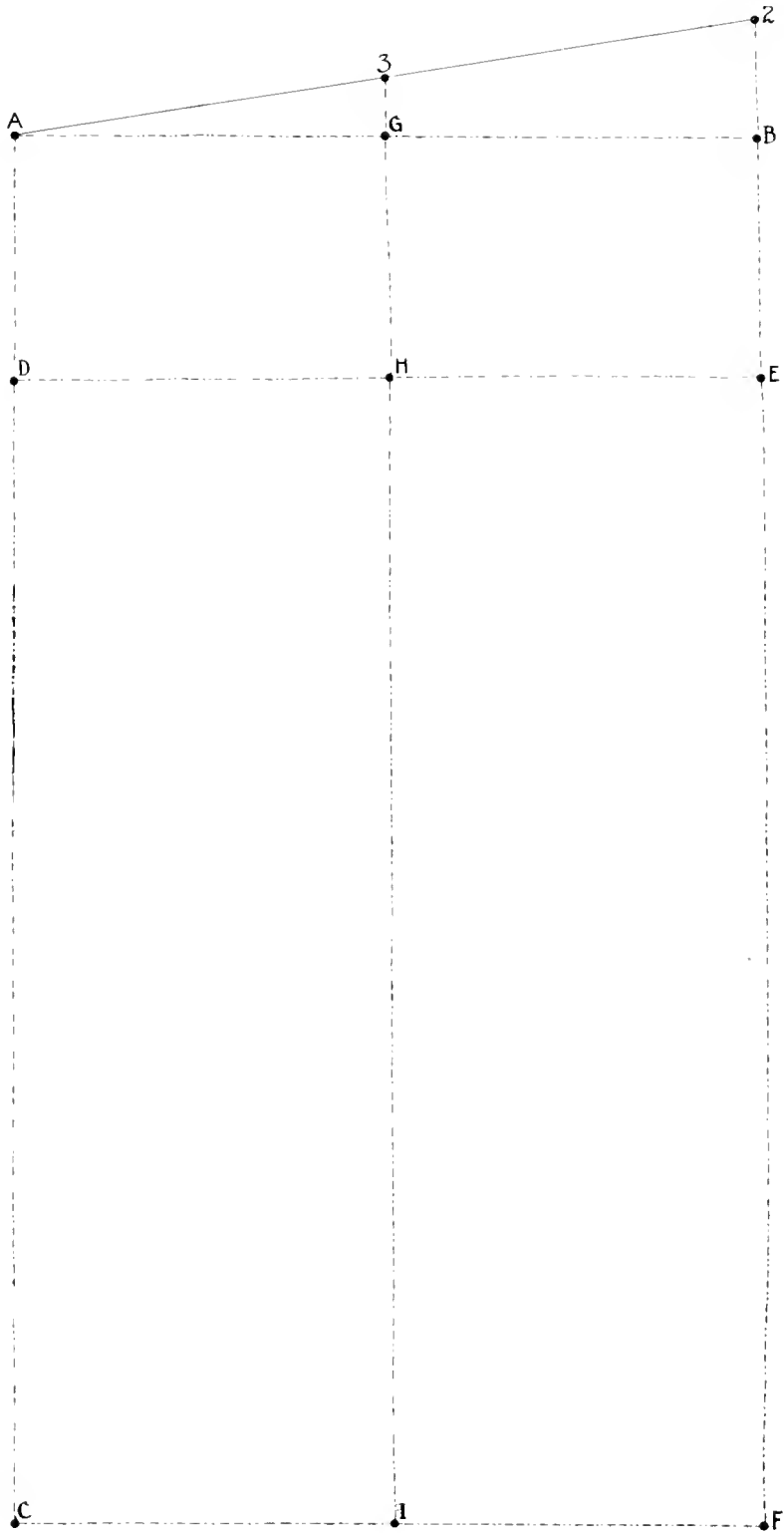

LESSON No. 10

Lesson 11

In the second diagram of the skirts we show you how to divide a skirt in gores. Remember that the hip is divided in eight parts which half is four. In dividing these four parts use the same system as in first lesson and divide the hip line in four equal parts as we show here to be 21 in. In this way you will obtain all the parts from E, 10, 11, 12, B and so you square up from 10 to 2, from 11 to 4 and 12 to 6. As we have used 24 half of which means 12, divide it into 4 parts which will be 3 in. From A to 1 is 3 in. From 2 to 3 is 3 in. From 4 to 5 is 3 in. From 6 to 7 is 3 in. Draw a line from 10 to 1, from 11 to 3 and from 12 to 5 and you have the complete division of the hip to the waist.

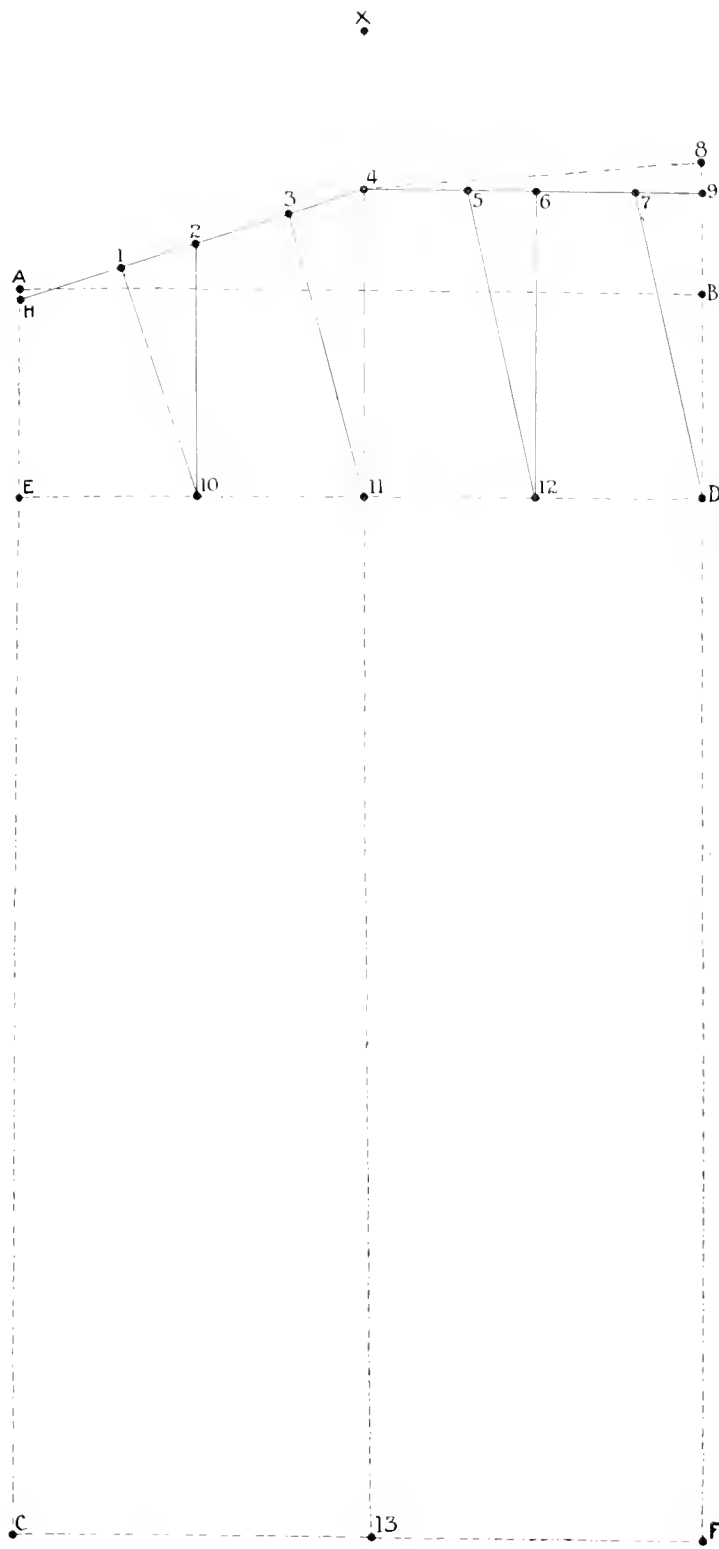

LESSON NO. 11

Lesson 12

In the third diagram we have a drawing of the skirt complete. Draw your diagram as in the previous lessons which will give you the complete part from the hip to waist which is A, D, 1, 2, 3, 4, 5, 6, 7, F, B, E, 8, 13, 12, G. Draw a straight line from 2, 8, 14, 4, 13, 16, 6, 12, 18. If you want a skirt 2- $\frac{1}{2}$ yds. wide around the bottom take half which is 1- $\frac{1}{4}$ or 45 in. and divide in 4 parts. Start from C to 15, from 14 to 17, from 16 to 19 and from 18 to H. Draw a line from 8 to 15, from 13 to 17, from 12 to 19 and from G to H and you will have exactly the same diagram as is shown in this lesson. I also wish to call your attention to the hip line which in many cases you will find high or low hip as you see from 9, 10, 11.

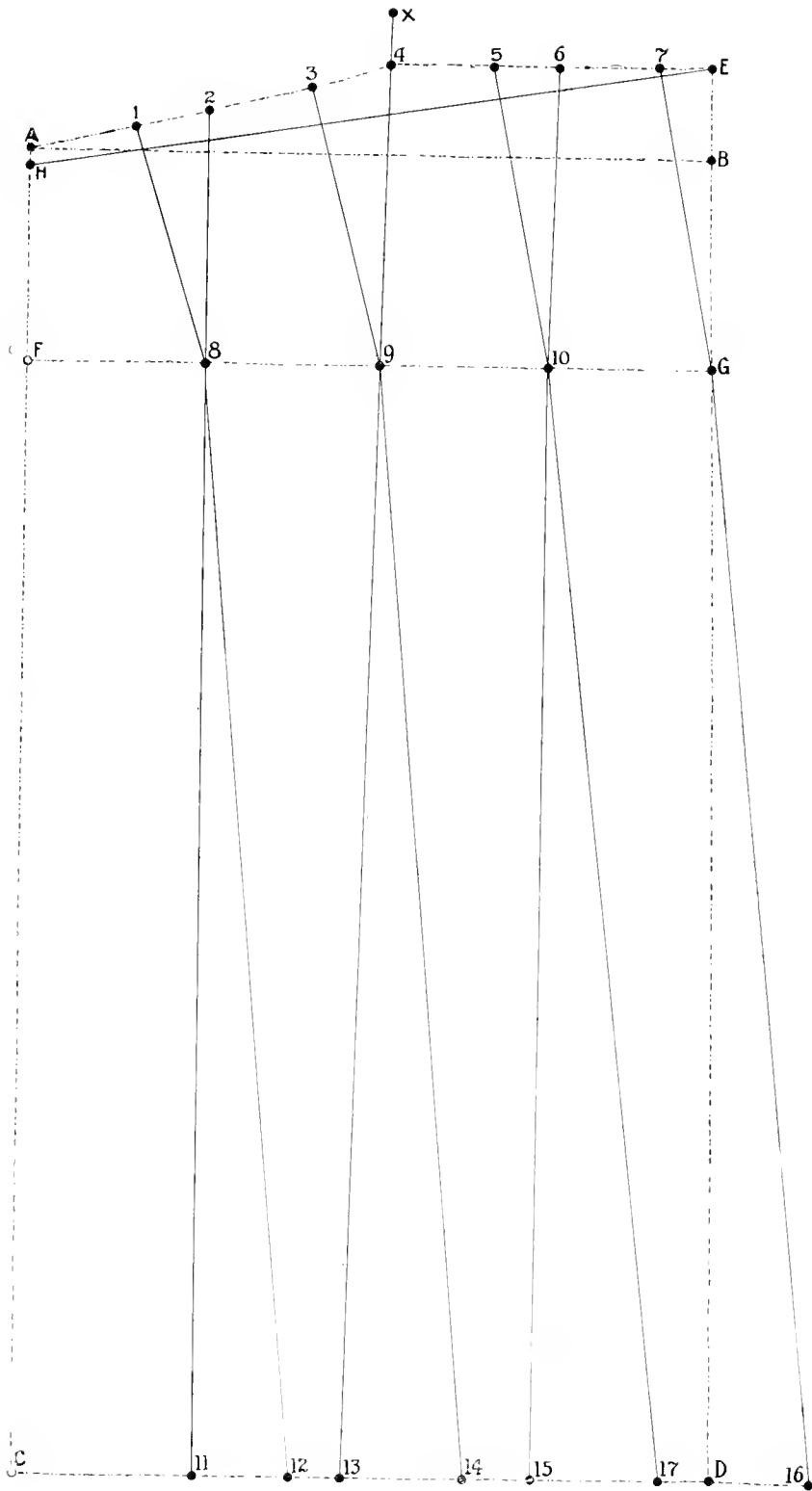

LESSON NO. 12

Lesson 13

In Lesson 13 we show you a diagram showing how to cut the high hips. Square A, B, C, E, 8, 9, 10, G, H, E, 11, 12, 13, 14, 17, D, 16, which are the same as the previous diagrams. Take notice. The X shown in the diagram denotes the hip measure. This measure taken to the floor in general you will find is $1\frac{1}{2}$ in. difference from the front. If you should find this measure any longer than $1\frac{1}{2}$ in. add just as much from 9 to 4 and raise your waist line as is shown in the diagram. This is the reason that we take all the measurements for skirts from waist to the floor and in the same way. You will find the difference in back and front seams. If you find that a lady is longer in front than back raise the waist line accordingly.

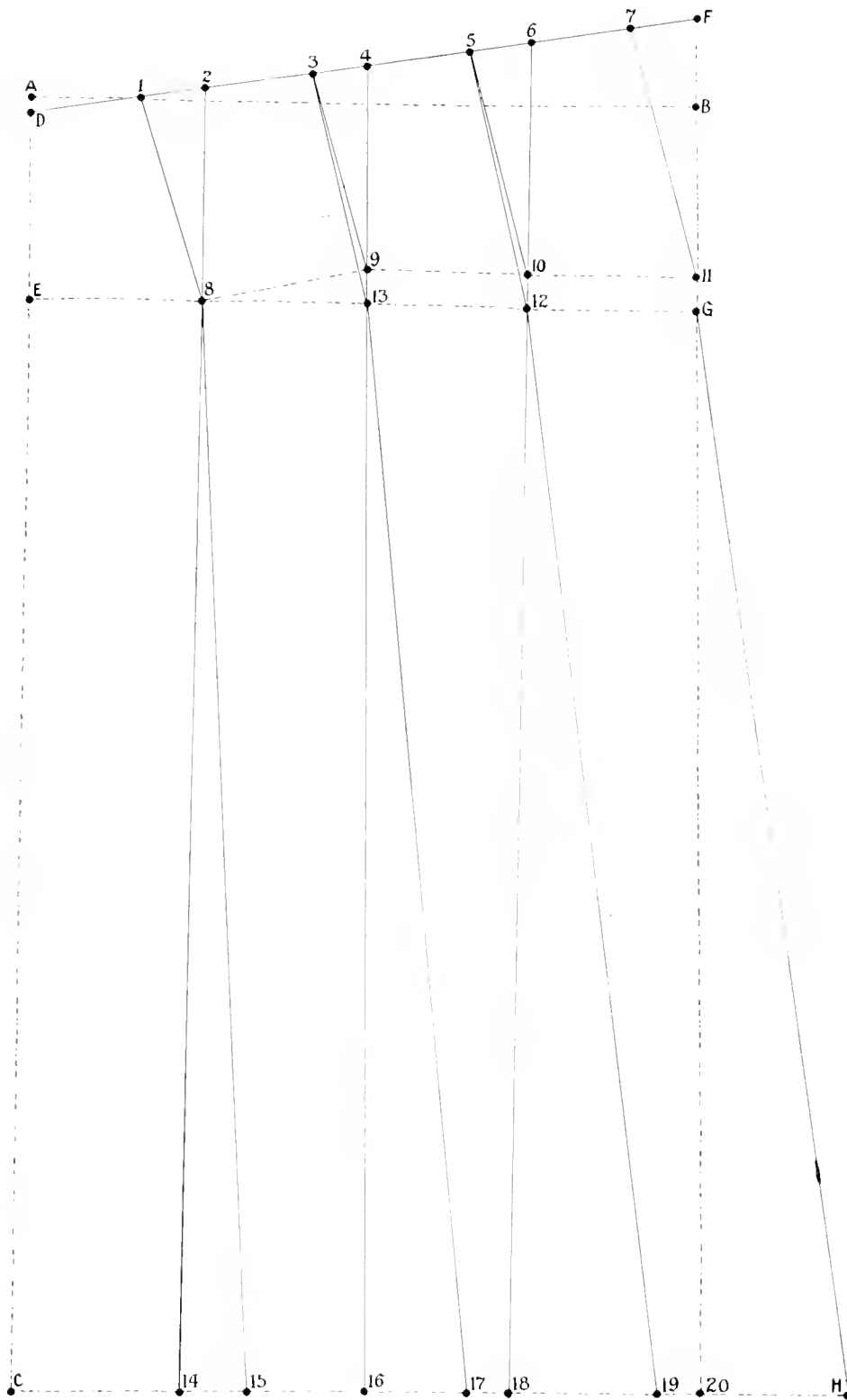

LESSON NO. 13

Lesson 14

In the 14th lesson we are illustrating the nine gored skirt half pleated all around. As you notice it is cut with the same diagram as you have in previous lessons. Draw a line from B to A and B to F. From A to D to C, from D to E to 10 are the same as the last lesson. From A to 1 and from D to 11 is the width of the front panel. This panel can be made 4, 5 or 6 inches at will. Divide 11, 12, 13, 14, E into 4 equal parts or any number of gores you wish in the skirt. If you want a seven-gore skirt divide in three; if you want a five-gore skirt divide in two. From A to 1 is $1/12$ or $1\frac{1}{2}$ in. From 2 to 3 is a fourth part of the remainder of the waist measure which is 24 in. From 4 to 5, 6 to 7, 8 to 9 are the same. Draw a line from 1 to 11, from 2 to 11, from 3 to 12, from 4 to 12, from 5 to 13, from 6 to 13, from 7 to 14, from 8 to 14, from 9 to E, from E to 30 to 47. From 14 to 45, 14 to 43, 13 to 42, 13 to 39, 12 to 39, 12 to 38, 12 to 36, 11 to 33 and then mark your pleats. The ones we are showing are 15 in. and they are 2 in. deep. From 16 to 15 is 2 in. From 33 to C is $2\frac{1}{2}$ in. From 16 to 17, 18, 20, 21, 22, 23, 24, 25, 26, 27, 28, 29, 30, 31 are the same as from 16 to 15.

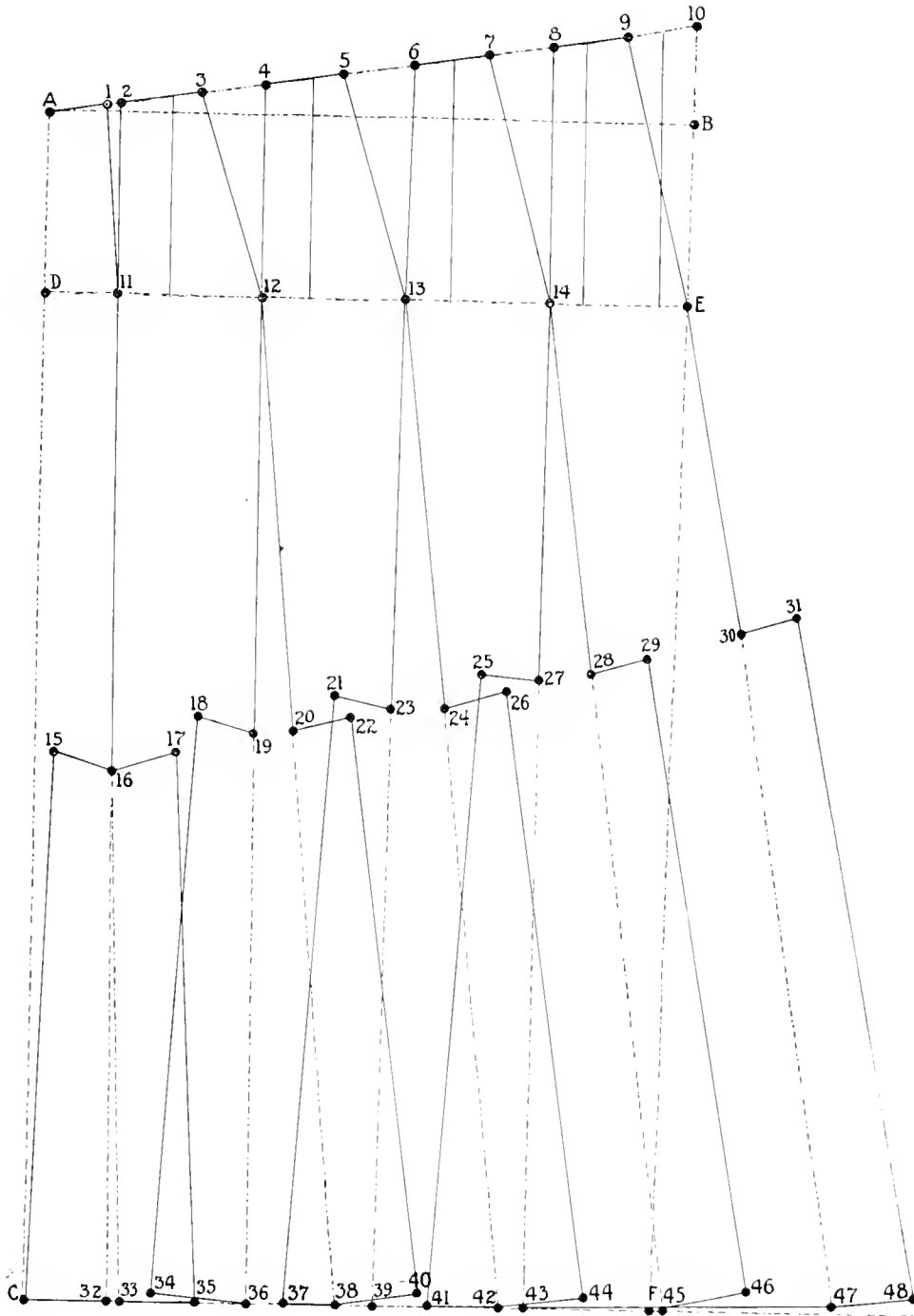

LESSON NO. 14

Lesson 15

In the 15th lesson we will illustrate how to cut a circular skirt. Notice that we are cutting this skirt on the same diagram that is used by Pecori's system. We are confident that you will agree with us that this is the easiest, the best and the perfect way to cut a circular skirt. With years of experience we have found that in cutting this skirt following our instructions you will never fail to get a perfect circular skirt. Draw a square A, B to C. Get your lines D to E, A to S, A to F same as the previous ones. Divide your hip measure in 4 equal parts and so the waist line in 4 parts getting size 36 which the waist measure is 24 and hip measure is 42 you will find that from D to 9, from 9 to 10, 10 to 11, from 11 to E are $5\frac{1}{2}$ in. From 8 to 1, from 2 to 3, 4 to 5 and from 6 to 7 is 3 in. Draw a line from 1, 9 to 12. From 3 to 13 touching 10, 5 to 14 touching 11 and 7 to 15 touching E. Cut from 16 to 9, from 17 to 10, from 18 to 11 close 2 to 1, 4 to 3, 6 to 5 and you have a perfect circular skirt as we are showing in the 16th lesson.

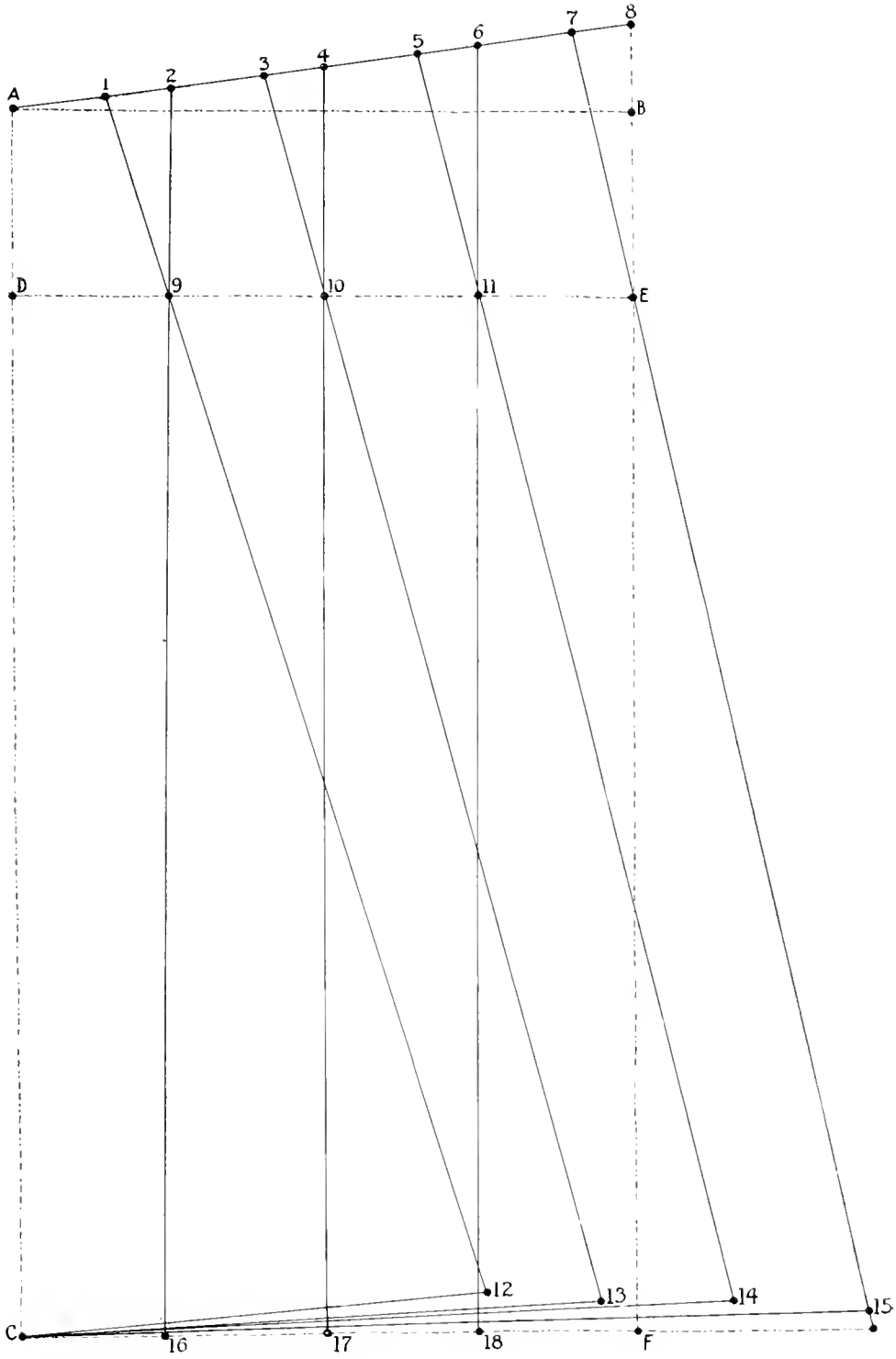

LESSON NO. 15

Lesson 16

In illustrating Lesson 16 we will call the attention of our scholars to the fact that A, C, B must be always placed on the straight of the goods that forms the front part. This circular skirt is from the hip down giving the perfect hanging. Wishing to have a fuller skirt, the fullness will start from the waist up cut open 5, 6, 7 and 8 at the amount of the fullness you may want. Keep 1, 3, 4, which is the waist measure always closed. This skirt can be made of any style or design either double or triple. As we are not following styles but the more important points of fitting garments we give you the foundation of everything concerning ladies' garments which over that you can copy or create from French or domestic models.

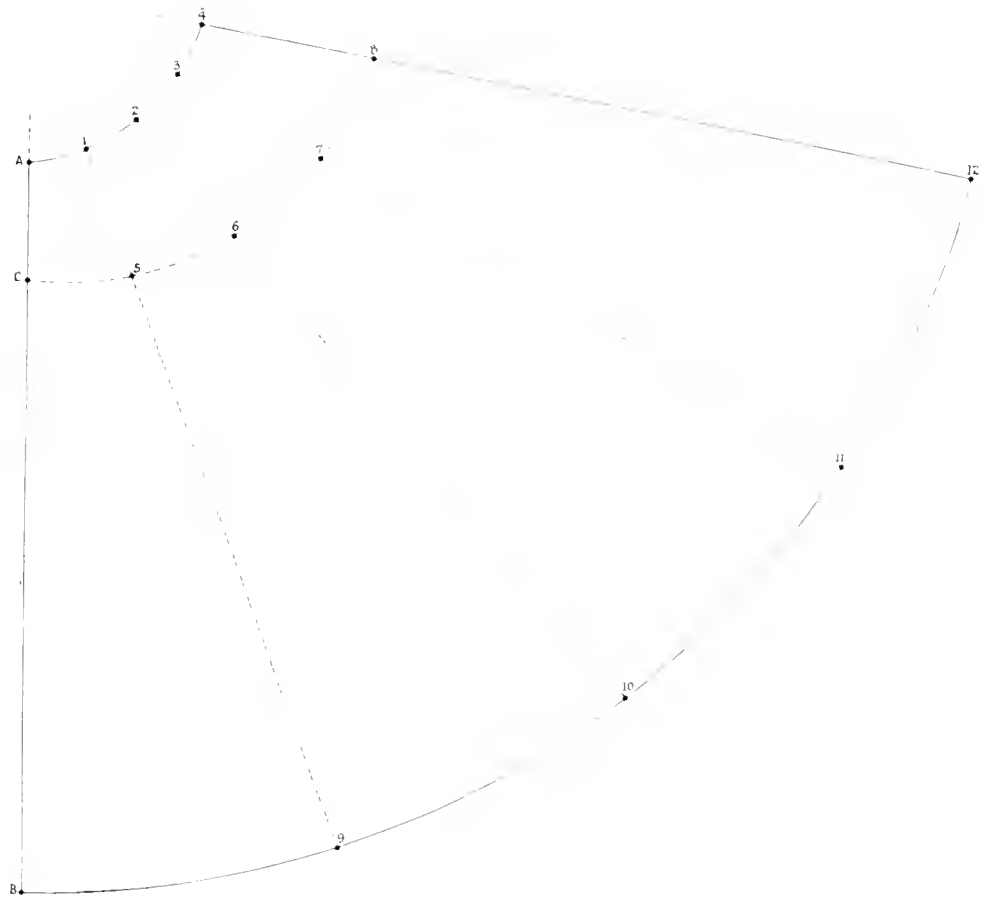

LESSON No. 16

Lesson 17

In Lesson 17 we illustrate the sideways safety riding skirt. This skirt is the newest design, for it has been created over Pecori's system. This skirt has been made and worn by one of Chicago's most popular society debutantes and has met with perfect success by the best riding class. As you see by our illustrations that we have tried to simplify so our scholars will have no trouble in cutting and fitting the skirt. Start the square as you did in previous lessons from A to B to D. From A to C is $\frac{1}{2}$ or 9 in. of the regular size 36. Square a line from C to E which is the full extent of the front part of the skirt or 40 in. From C to 15, from 15 to 14, from 14 to 12 and from 12 to E is divided in 4 equal parts 10 in. Square from 14 to 7, from 15 to 9 and from 12 to 5. From A to 10 is 1-6 or 3 in. From 10 to 8 is $\frac{1}{4}$ or 10 in. From 8 to 4 is $\frac{1}{12}$ or $1\frac{1}{2}$ in. From 10 to 11 is $\frac{1}{16}$ or $1\frac{1}{8}$ in. From 12 to 13 is $\frac{1}{8}$ or $2\frac{1}{4}$ in. Draw a line from 13 to 2 and from 5 to 1. From 6 to 2 is $\frac{1}{8}$ or $2\frac{1}{4}$ in. From 2 to 3 is $\frac{3}{4}$ in. Raise from 14 $\frac{1}{6}$ or 3 in. Outline from 11 to 4 and from 4 to 6 to 3. Below from E $\frac{1}{8}$ or $2\frac{1}{4}$ in. From A to B is 38 in. or the length of the skirt. Draw a line from D to 2 to 16. From D to 17 is 36 in. From 17 to 16 is 12 in. From c to 18 is $\frac{1}{6}$ or 3 in. Draw a line from 10, 11, C to 18. Outline from 4, 13, 17 and from 13 to E as shown in the diagram and from E to 16 and you have the complete part of the front of the skirt.

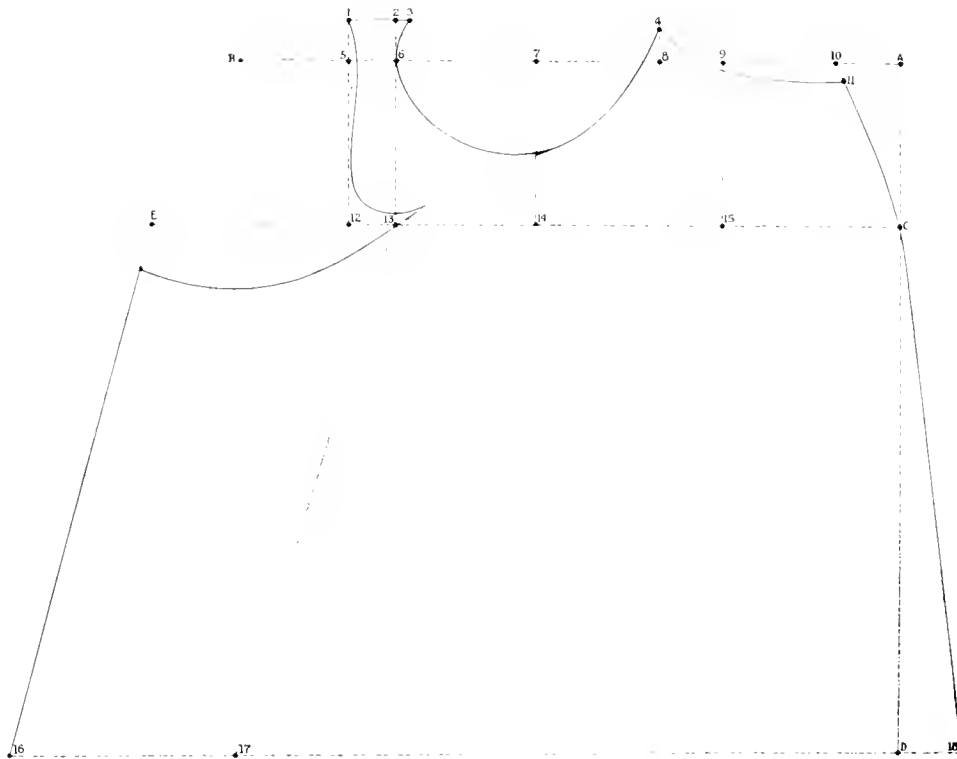

LESSON NO. 17

Lesson 18

In the 18th lesson we illustrate the back part of the riding skirt. Square from A to B to A to C. From A to D is 9 in. Square from D to E. From D to 15 is $\frac{1}{2}$ or 9 in. From 15 to 14 is $\frac{1}{4}$ or $4\frac{1}{2}$ in. From 14 to 13 is $\frac{1}{4}$ or $4\frac{1}{2}$ in. From 13 to 11 is 1.6 or 3 in. From 11 to E is $\frac{2}{3}$ or 12 in. Draw a line from 14 to 4 and 14 to 22. From A to C is 38 in. Square from C to 20. From 10 to 4 is $\frac{1}{8}$ or $2\frac{1}{4}$ in. From 4 to 5 is 1.6 or 3 in. From 9 to 3 is 1.6 or 3 in. From 3 to 4 is $\frac{1}{4}$ or $4\frac{1}{2}$ in. From 22 to 24 is $\frac{1}{2}$ or 9 in. From 22 to 20 is $\frac{2}{3}$ or 12 in. From C to 23 is $\frac{2}{3}$ or 12 in. From A to 6 is $\frac{1}{4}$ or $4\frac{1}{2}$ in. Draw a line from 6, 15 to 23. Draw a line from 5, 15, 19, 24. From 13 to 12 is $\frac{1}{8}$ or $2\frac{1}{4}$ in. Draw a line from 3, 12 to 27. From 1 to 2 is $\frac{1}{16}$ or $1\frac{1}{8}$ in. From 12 to 3 and from 12 to 2 must be the same length. Draw a line from 2, A to 12. From A to 7 is 1.3 or 6 in. From 17 to G is 20 in. From G to 26 is 1.6 or 3 in. Draw a line from 2 to 7, 7 to E to G to 26. Curve up to 27, come down to 20 and you have the complete back of the riding skirt.

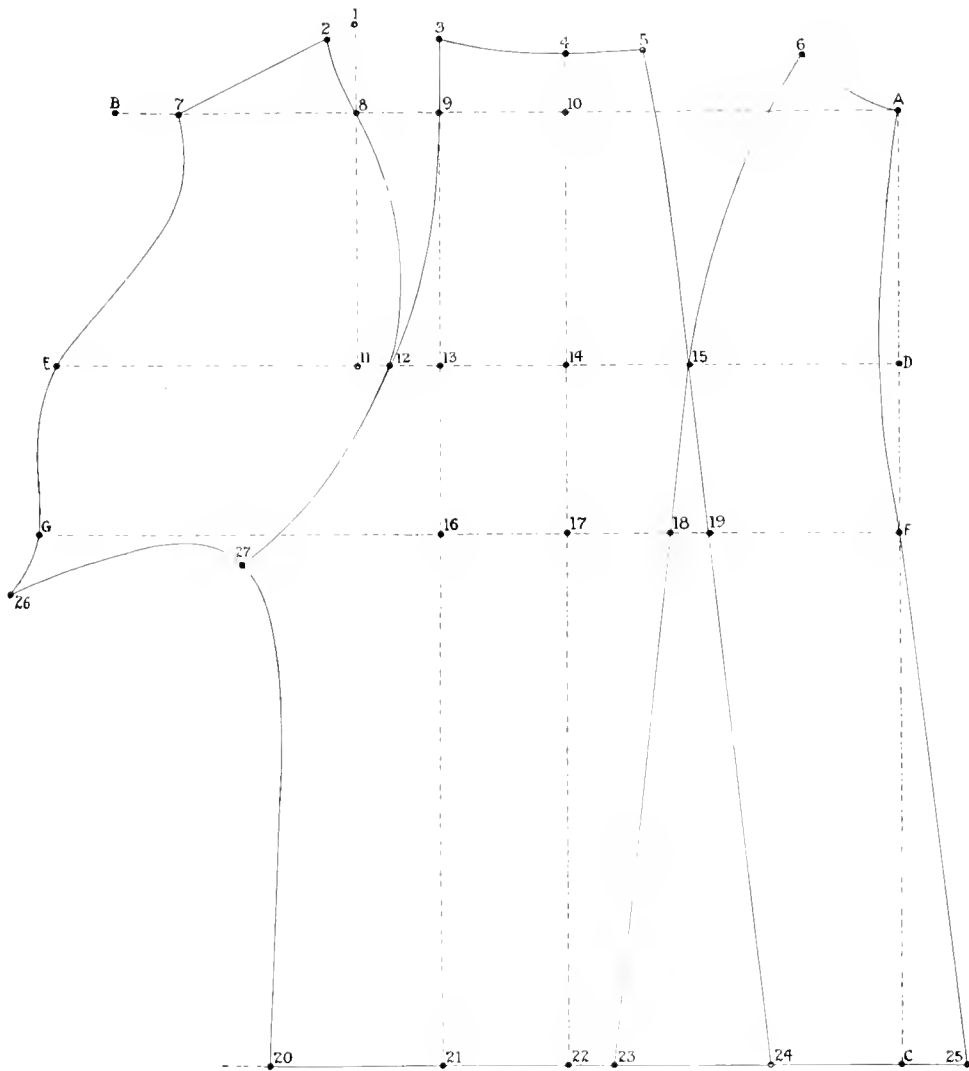

LESSON NO. 18

Lesson 19

In the 19th lesson we will illustrate riding bloomers. Follow instructions as usual. Square from A to B and from A to C. From A to E is 1-3 or 6 in. From E to F is $\frac{1}{2}$ or 9 in. From A to D is 1-6 or 3 in. From A to G is the length of the knee 22 in. From G to H is $\frac{1}{8}$ or $2\frac{1}{4}$ in. From H to I is 1-12 or $1\frac{1}{2}$ in. From I to J is 1-6 or 3 in. From J to C is 1-12 or $1\frac{1}{2}$ in. Square from D to 6, from E to 14, from F to 23, from J to 32, from H to 33, from I to 43, from J to 46 and from C to 48. From A to 2 is 2-3 or 12 in. Draw a line from 2 to 49. From 12 to 10 is 1-3 or 6 in. Square down from 10 to 52. From 12 to 13 is $\frac{1}{8}$ or $2\frac{1}{4}$ in. From 20 to 21 is 1-6 or 3 in. Square from 13 to 21. From 21 to 15 is $\frac{1}{8}$ or $2\frac{1}{4}$ in. From 21 to 22 is 1-6 or 3 in. Draw a line from 13, 15 to 22. From 49 to 48 is 1-6 or 3 in. Draw a line from 42 to 48. From 49 to 51 is 1-6 or 3 in. From 19 to 25 is $\frac{1}{8}$ or $2\frac{1}{4}$ in. Draw a line from 25 to 61. From 12 to 11 is $\frac{1}{4}$ or $4\frac{1}{2}$ in. From 19 to 17 is 1-6 or 3 in. Draw a line from 11, 17 to 18, 25, 28. From 27 to 28 is 1-16 or $1\frac{1}{8}$ in. Draw a line from 28 to 38 and from 28 to 41, 51. From 32 to 31 is 1-16 or $1\frac{1}{8}$ in. Draw a line from 22 to 31 to 34, 46, from 31, 43, 48. From 22 to 23 is 1-6 or 3 in. From 23 to 24 is $\frac{1}{8}$ or $2\frac{1}{4}$ in. Draw a line from 24 to 31. From 10 to 9 is $\frac{1}{4}$ or $4\frac{1}{2}$ in. From 7 to 8 is $\frac{1}{2}$ or 9 in. From 20 to 16 is 1-6 or 3 in. Draw a line from 3 to 16, from 16 to 8, from 8 to 9, from 9 to 18, from 18 to 29 to 37 to 45 and you will have a complete diagram of riding bloomers. Remember that these are regular fitting bloomers which from the same diagram you can cut all kinds, tight or loose fitting.

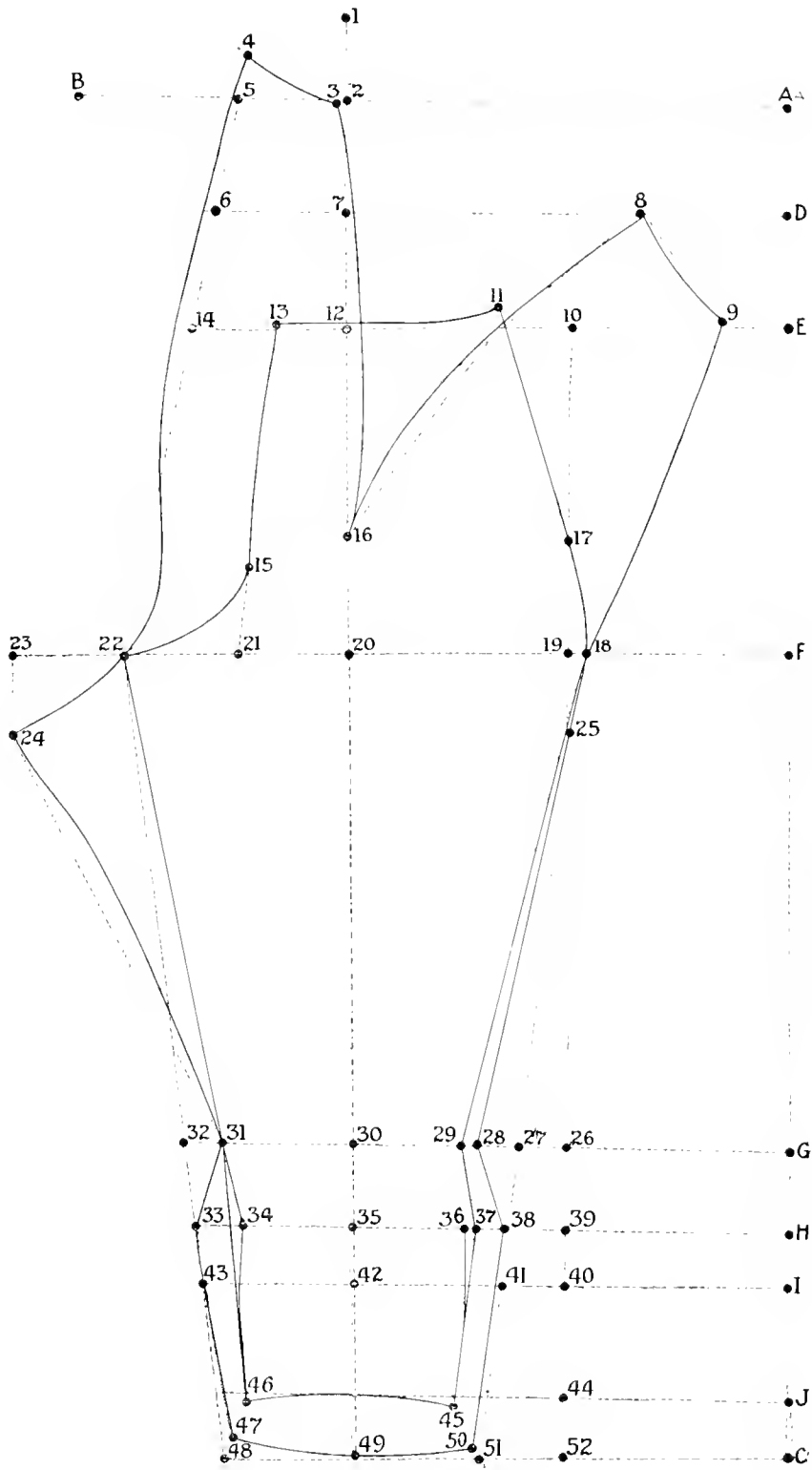

LESSON NO. 19

Lesson 20

Lesson 20 shows a diagram of a double-breasted riding coat. Follow instructions as in previous lessons. A, B, C, E, G, I, 26, 42, 43, 63, 15, 14, 12, 11, 10, 9, 2, 25, 22, 21, 28, 37 are the same as any other coat diagram. From 42 to 41 is 1 1/2 or 1 1/2 in. From 41 to 39 is 1-6 or 3 in. From 39 to 38 is 1/4 or 4 1/2 in. From 38 to 37 is 1-6 or 3 in. From 37 to 36 is 1/4 or 4 1/2 in. From 36 to 35 is 1/8 or 2 1/4 in. From 34 to 33 is 1-6 or 3 in. From 32 to 31 is 1/8 or 2 1/4 in. From 43 to 44 is 2 in. From 44 to 46 is 1/8 or 2 1/4 in. From 47 to 45 is 1-3 or 6 in. From 47 to 48 is 1-16 or 1 1/16 or 1 1/8 in. From 48 to 36, 56 is 6 in. Draw a line from 36 to 55, 55 to 35, and get your 34, 54 line. From 54 to 53 is 1-6 or 3 in. From 53 to 51 is 1-12 or 1 1/2 in. Draw a line from 32 to 51, 52. Draw a line from 33, 53. Curve up to 32, 29, 33, 29, 34, 37, 36, 27, 23 to 37, 48, 49, 58, 24, 38, 47, 49, 57. From 25 to 18 is 1/8 or 2 1/4 in. Curve from 18 to 24. From 16 to 17 is 1-12 or 1 1/2 in. Curve from 17 to 41 to 44, 61, 18, 1/2 in. below the 17. Close with the back to 39, 45, 62. Get your shoulder from 15 to 16 and your neck from A to 15. Draw a line from 3 to 21. Curve from 2 to 3. From 20 to 19 is 1-16 or 1 1/8 in. Draw a line from 19, 9, 3, 21 to 20. Get a dart 2 in. deep between 20 and 19. From 9 to 8 is 1/8 or 2 1/4 in. From 21 to 4 is 9 in. Draw a line from 21 to 4. From 28 to 30 is 1-6 or 3 in. for button lap. From 4 to 5 is 1/12 or 1 1/2 in. Shape lapel 4, 5, 7, 30, 31 and you will have the complete diagram of the tight-fitting riding coat.

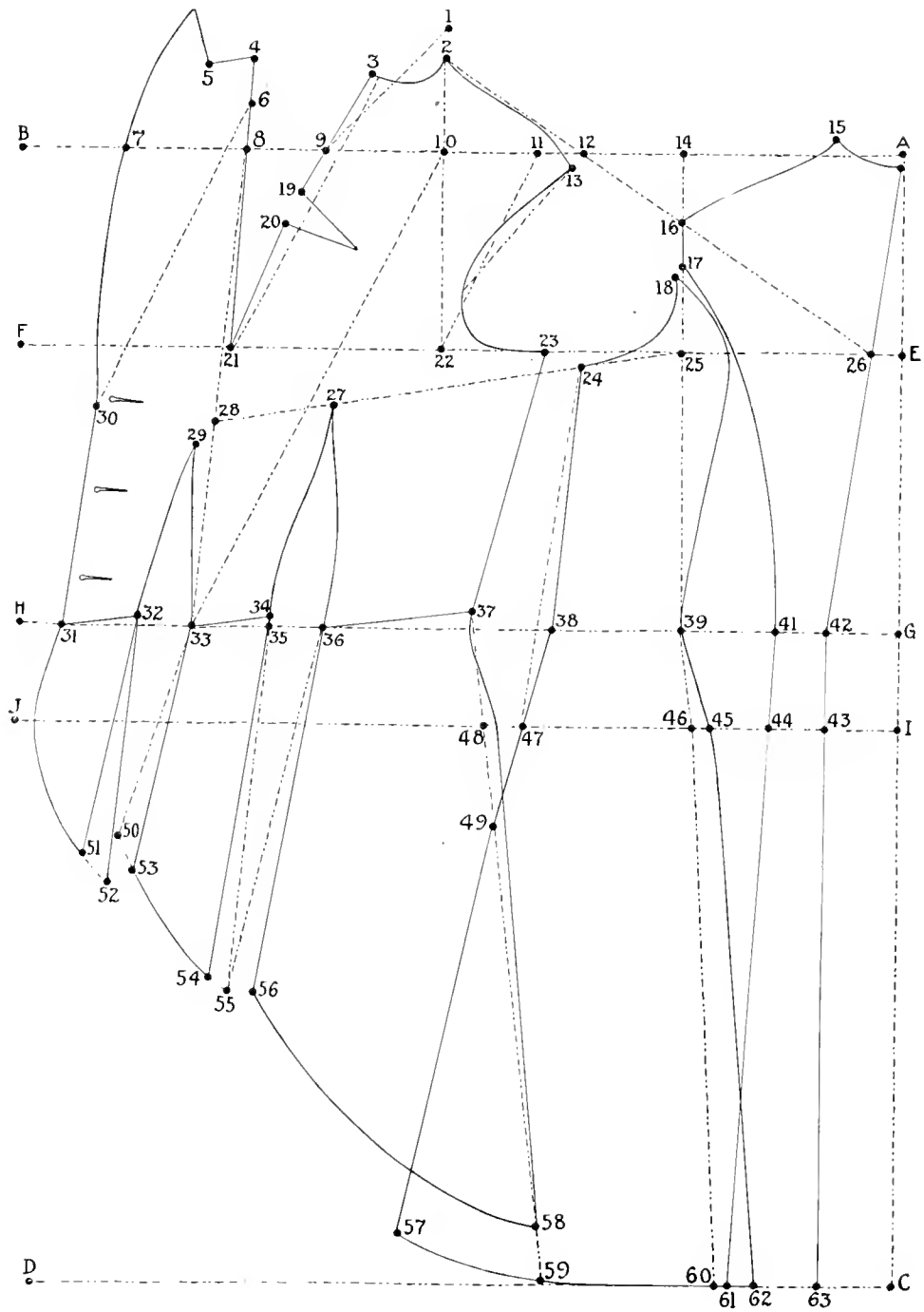

LESSON NO. 20

Lesson 21

In Lesson 21 we show you three garments at the same time, a cut-away coat, a Prince Albert coat, and full dress coat. Notice that the top from the waist up are exactly the same as in Lesson 20. Draw a diagram and start to get the necessary points to get your skirts. The one outlined with the heavy line is a cut-away coat. Get your point on the diagram A to B, E to F, G to H, I to J, K to L. From I to K is 3 in. or $1/6$. Get your 15, 27, 47, 54, 57, 66, 17, 46, 53, 56, 62. Notice that 45 to 61, 48 to 65 and 44 to 64 are inlaid. Get your 18, 26, 42, and place your 43. Curve from 43 to 55 to 63 and 43 to 41. From 41 to 37 is $1/8$ or $2 1/4$. Dart down to 52, 41 and 52 to 37. From 38 to 36 is $1/8$ or $4 1/2$ in. From 36 to 34 is $1/4$ or $4 1/2$ in. From 36 to 34 is $1/4$ or $4 1/2$ in. From 31 to 34 is $1/16$ or $1 1/8$ in. Draw a line from 38 to 36 and 36 to 34. Curve down to 61, 63. From 38 to 39 is $1/24$ or $3/4$ in. and you have the skirt of the cut-away coat. The Prince Albert skirt is the same with the exception of a small change in the front. From 36 to 35 is $1/8$ or $2 1/4$ in. From 35 to 30 is $1/8$ or $2 1/4$ in. Square down from 35 to 16, from 30 to 58, from 58, 59 to 64 and you also have the Prince Albert skirt. The Full dress skirt. From 34 to 49 is $1/12$ or $1 1/2$ in. From 49 to 50 is $1/4$ or $4 1/2$ in. From 36 to 50 is $1/8$ or $2 1/4$ in. Draw a line from 50 to 61 and you have the full Dress skirt.

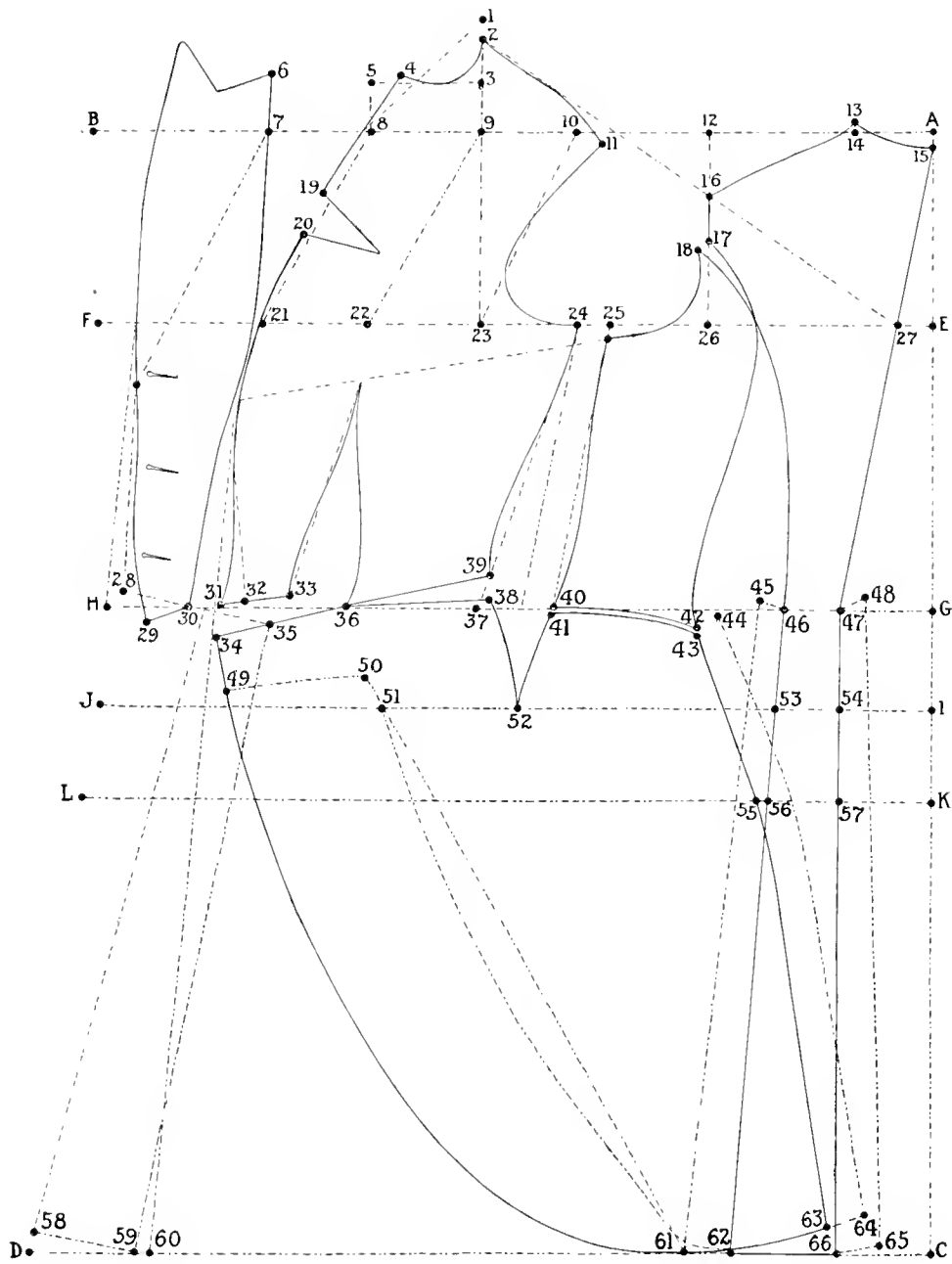

LESSON NO. 21

Lesson 22

The 22nd Lesson illustrates a raclan. Notice that we have the same diagram as in the first lesson. Square A, B, C. Get your D, E, F, 21, 8, 6, 4, 7, 3, 9, 10, 15, 22, 39, 32, 40, 12, 13, 11, 14, the same as the previous diagrams. From 22 to 20 is $\frac{1}{2}$ or 9 in. From 20 to 19 is $1\frac{1}{2}$ or $1\frac{1}{2}$ in. From 19 to 18 is $\frac{1}{6}$ or 3 in. From 18 to 17 is $\frac{1}{3}$ or 6 in. From 17 to 16 is $\frac{1}{2}$ or 9 in. From 32 to 31 is $\frac{1}{2}$ the hip measure or $10\frac{1}{2}$ in. From 27 to 28 is $1\frac{1}{2}$ or $1\frac{1}{2}$ in. Draw a line from 24, 28, 31, 38, from 23, 27, 31, 39, from 12 to 20. From 23, 15, 4 and from 4, 3, 2 as shown in diagram. Draw a line from 7, 17, 34. Draw a line from 17 to 37, from 17 to 2 and from 2, 16 to 33. Cut between 1 and 2 as far as 17. Close 34 to 37 and you will have exactly the same diagram as you see in the picture. Wishing to cut the sleeve as shown in diagram draw a line from 28 to 5. From 28 to 5 is 18 in. From 29 to 28 is 9 in. or $\frac{1}{2}$ and it must be always from 22 to 20 and from A to 5. Square down from 5, 11, 14 and from 5, 9 to 15 and you will have the top of the sleeve. Remember that with the same diagram you can cut all kinds of loose coats with or without the sleeve running to the shoulder.

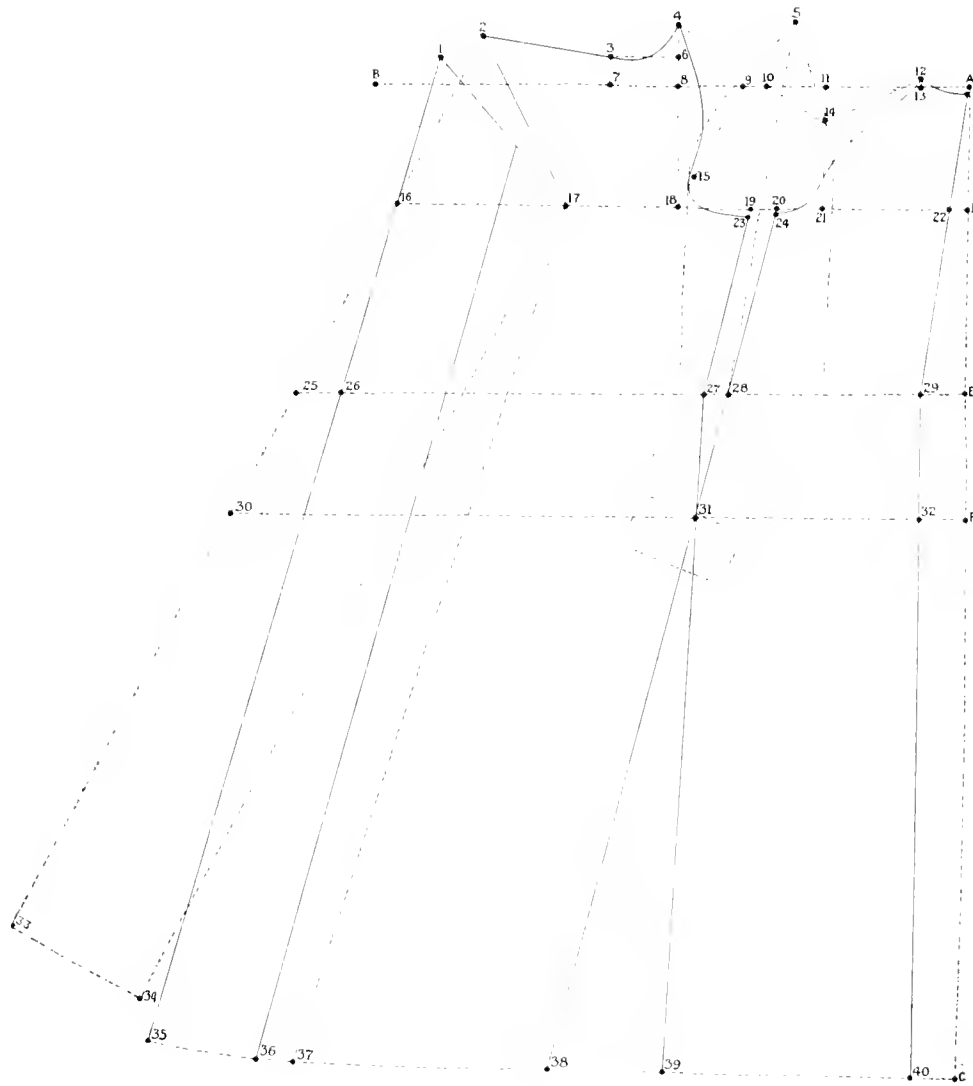

LESSON NO. 22

Lesson 23

In Lesson 23 we are illustrating a diagram of a cape. If you notice the cape is cut on the same diagrams of the coats with the exception of a little changing on the shoulder. Draw a square A, B, C. From A to D, is 6 in. or $\frac{1}{3}$. From A to 19 is the waist length or 15 in. From 19 to 18 is $\frac{1}{8}$ or $2\frac{1}{4}$ in. Draw a line from A to 18 and get your 15. From 15 to 16 is 9 in. From 16 to 17 is 9 in. From 17 to E is $\frac{1}{8}$ or $2\frac{1}{4}$ in. Square up from 16 to 3 which is 9 in. and draw a line from 3 to K. From 3 to 9 is $\frac{1}{4}$ or $4\frac{1}{2}$ in. From A to 13 is $\frac{1}{8}$ or $2\frac{1}{4}$ in. From 13 to 12 is $\frac{3}{4}$ in. Place your square from 12 to 9 and draw a line from X. From 6 to 5 is 3 in. From 6 to 4 is $2\frac{1}{4}$ in. Square from 5 to 2 to 4. From 1 to 2 is $\frac{1}{12}$ or $1\frac{1}{2}$ in. Draw a line from 1 to K and you have the front line. From 3 to 7 is $2\frac{1}{4}$ in. Place measure and curve line from K to K. From 9 to 10 is $\frac{1}{8}$ or $2\frac{1}{4}$ in. Place measure on 10 dart and compass from X to X and you have the complete cape 24 in. long size 36. Remember that over the same diagram you can cut all capes whether circles or fitted over the shoulder.

*Gap 24 inches long
Size 36*

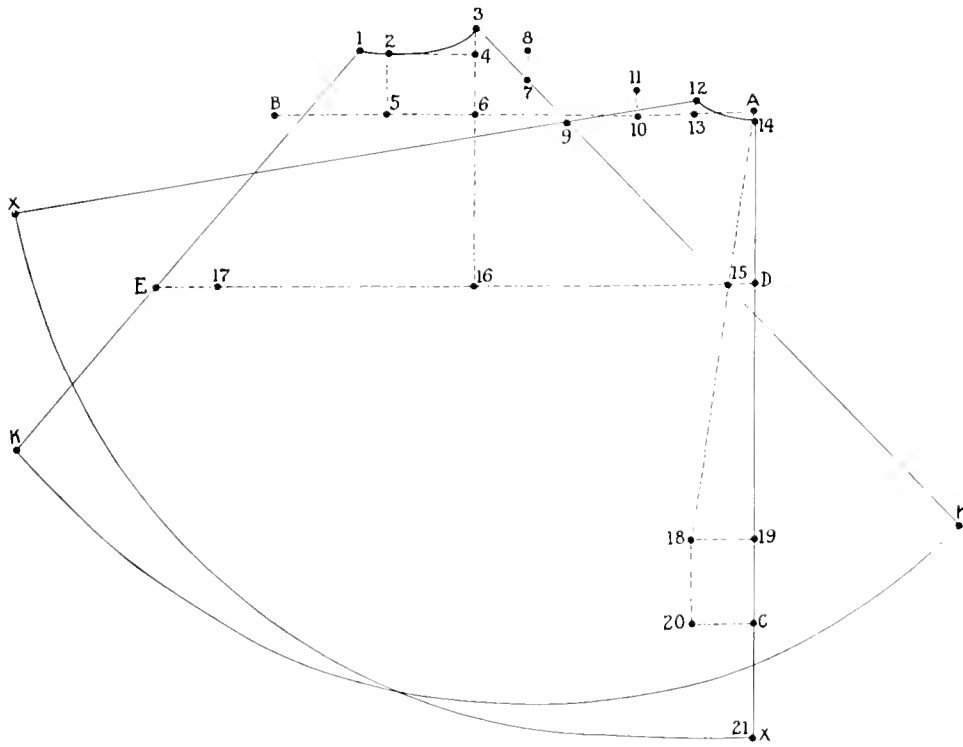

LESSON NO. 23

Lesson 24

In Lesson 24 we will illustrate diagrams of collars. Number 1 shows a strictly tailored collar. Square A to B to C. From A to C is $1/6$ or 3 in. Draw a line from C to D. From D to E is $1/12$ or $1-1/2$ in. From C to G is $1/4$ or $4-1/2$ in. From C to F is $1/16$ or $1-1/8$ in. Draw a line from E to G to C, from G to F, from H to B and from B to E as shown in the diagram and you have the perfect collar. In the second diagram we will show you how to cut the straight or waist collar. Draw a diagram from A to C. From C to F is $1/8$ or $2-1/4$ in. From D to E is $1/24$ or $3/4$ in. Draw a line from C to E and from F to B and you have the correct standing collar for the waist. Number three is the storm collar. Square A to B, A to C. From A to C is 3 in. Draw a line to D. From D to E is $3/4$ in. From C to G is $2-1/4$ in. From C to F is $1/16$ or $1-1/8$ in. From F to H is $2-1/4$ in. From A to 4 is $1/24$ or $3/4$ in. Place your square from F to 4 and draw a line up to M. As we are cutting this collar $4-1/2$ inches or you can cut it 3 or 6 inches you will always measure from F to M. We call your attention to the fact that your height starts from F, H, E. From A to K is $1/6$ or 3 in. Curve a line from H to O and from O to N. From A to I is $1-1/8$ in. Draw a line from H to I, N. From Q to R is $3/8$ in. Curve from N to R and from R to B to E and you have the complete storm collar to perfection.

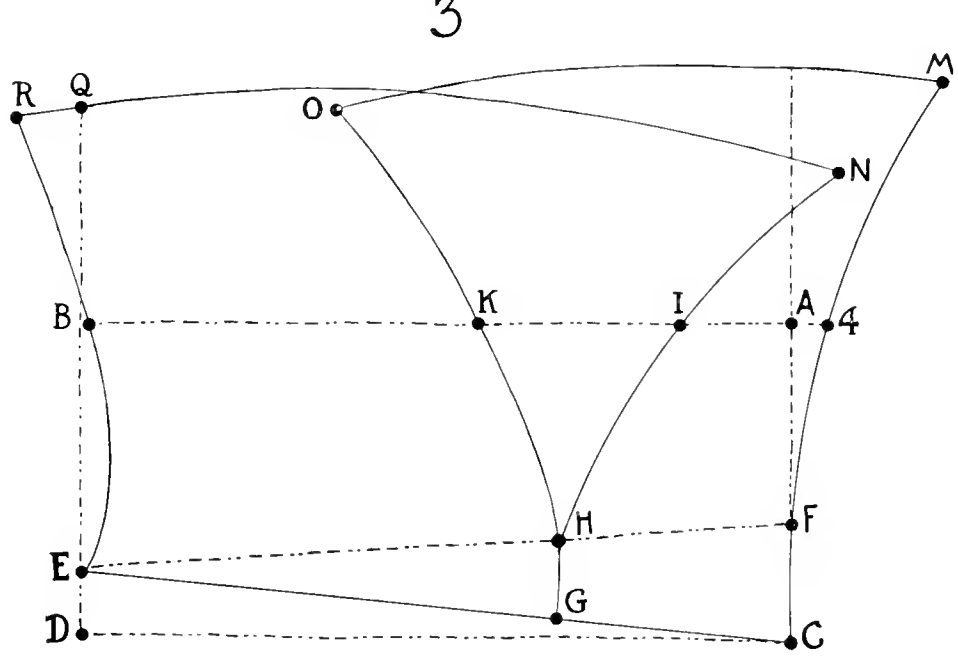
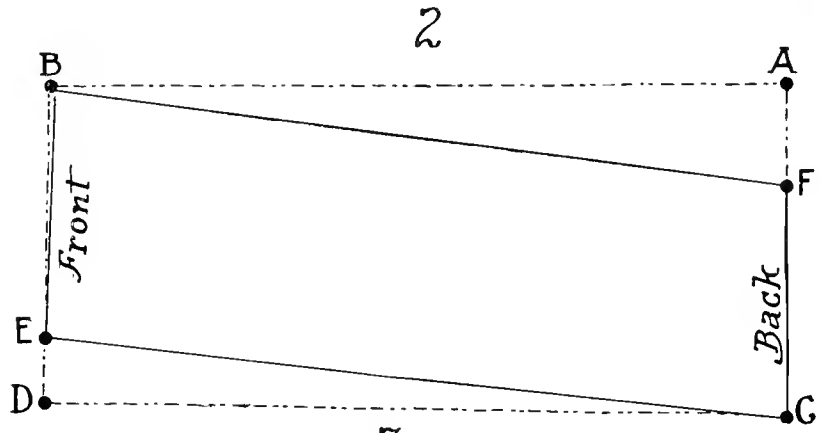
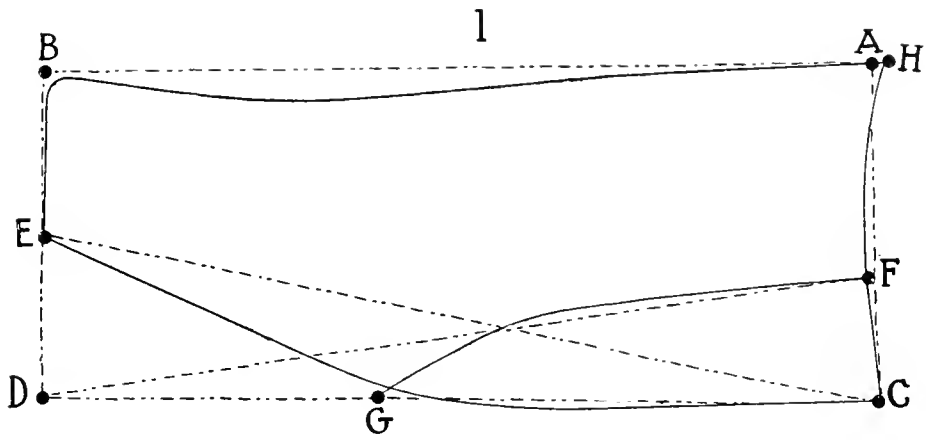

Lesson 25

Lesson 25th is a diagram illustrating a Sailor collar and "dickey." Square from A to B and from A to C. From A to B is 7 in. From A to C is 18 in. From A to 2 is $4\frac{1}{4}$ or $4\frac{1}{2}$ in. From A to E is $1\frac{1}{3}$ or 6 in. From E to G is $2\frac{1}{4}$ or $2\frac{1}{8}$ in. Square from E to F. Square from C to D. From C to 12 is $2\frac{1}{4}$ in. From D to 11 is $1\frac{1}{12}$ or $1\frac{1}{2}$ in. From G to 10 is $1\frac{3}{32}$ or $\frac{5}{8}$ in. Draw a line from 10 to 12 and from 6 to 12. From 9 to 8 is $1\frac{1}{16}$ or $1\frac{1}{8}$ in. From 3 to 5 is $1\frac{1}{24}$ or $\frac{3}{4}$ in. Curve a line from 2, 5, 6, 10. Draw a line from B to 11 and from 6 to 11. From F to 4 is $1\frac{1}{16}$ or $1\frac{1}{8}$ in. From 6 to 4 is the shoulder seam. The dotted line from 12 to 1 shows the inlaid of the "dickey." The sailor collar is $4\frac{1}{2}$ in. deep but can be made 6 or more and the same in the width but never change the center diagram which is the circle around the neck to perfection.

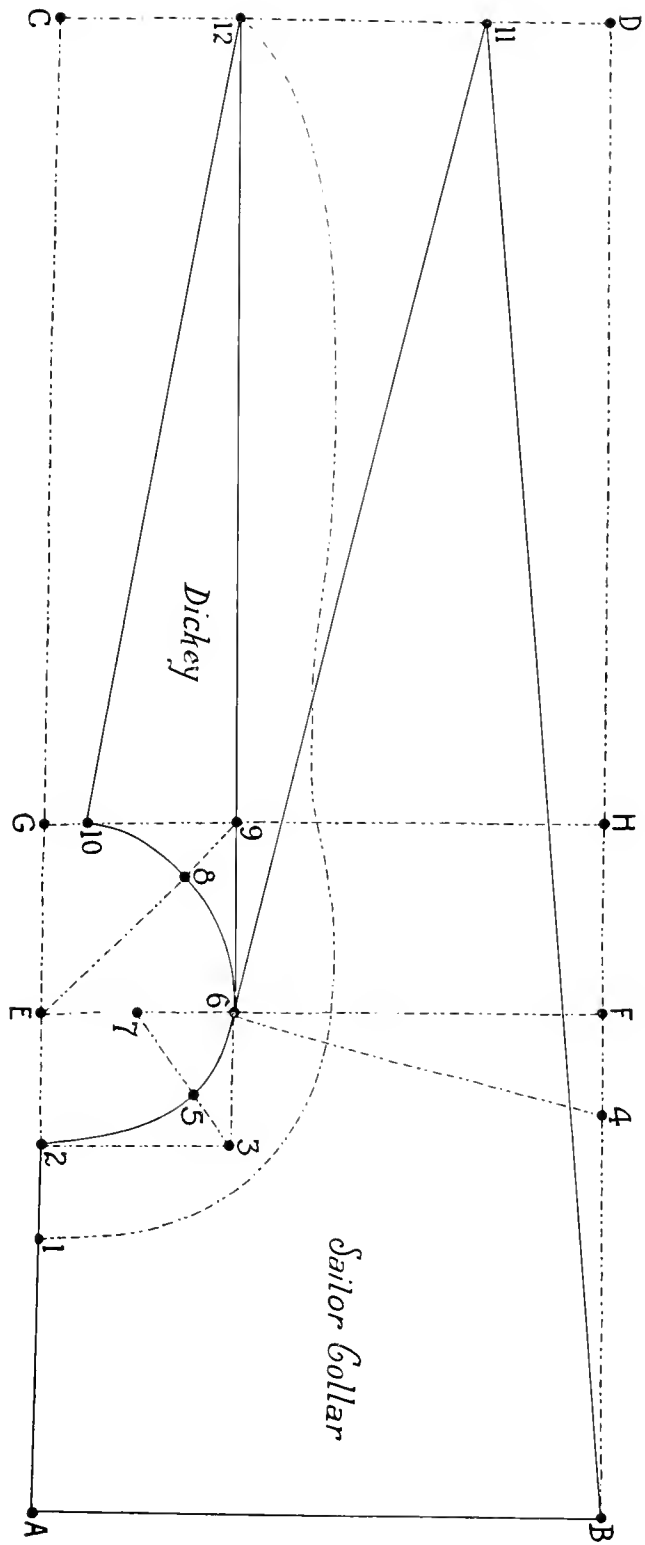

LESSON NO. 25

Lesson 26

We will illustrate three diagrams. The first one is a plain diagram over which you can cut all circle collars of different shapes. Square A, B, I. From A to E is $\frac{2}{3}$ or 12 in. From E to G is $\frac{1}{12}$ or $1\frac{1}{2}$ in. From G to C is $\frac{1}{8}$ or $2\frac{1}{4}$ in. From C to I is $\frac{2}{3}$ or 12 in. Square from E to F, from G to H, from C to D and from I to G. From E to 30 is $\frac{1}{8}$ or $2\frac{1}{4}$ in. Square down to 7. From G to 4 is $\frac{1}{16}$ or $1\frac{1}{8}$ in. From C to G is $\frac{1}{24}$ or $\frac{3}{4}$ in. From I to X is $\frac{1}{8}$ or $2\frac{1}{4}$ in. From A to B is 7 in. Draw a line from 6 to X, from B to J. Curve from E, 5, 6. The line that goes from 5 to F is the shoulder seam. Over this diagram you may cut and shape any collar you wish as we are going to illustrate in diagram 2. In diagram 2 we illustrate two collars. Draw your lines D, C, B, J, H, F, 4, 5, 6, 2, 3, A, 9 which are the same as in the first diagram. The first collar is 9 in. deep in the back point as you see from D, I, G, E, 8, 6. The small collar that you see in the diagram is $1\frac{1}{2}$ in. wide as you see from 1 to 7 to D and so you can cut them any shape. In diagram 3 we show a hood which is drafted the same as the first. Square A, B, C. From A to E, G, C, 3, 5, 7, D, H, F, B are the same as the first diagram. From B to I is $\frac{1}{6}$ or 3 in. Draw a line from A to 2 crossing 1 which is 12 in. Curve E, 5, 6, 7 down to 2 as diagram and you will have a perfect hood.

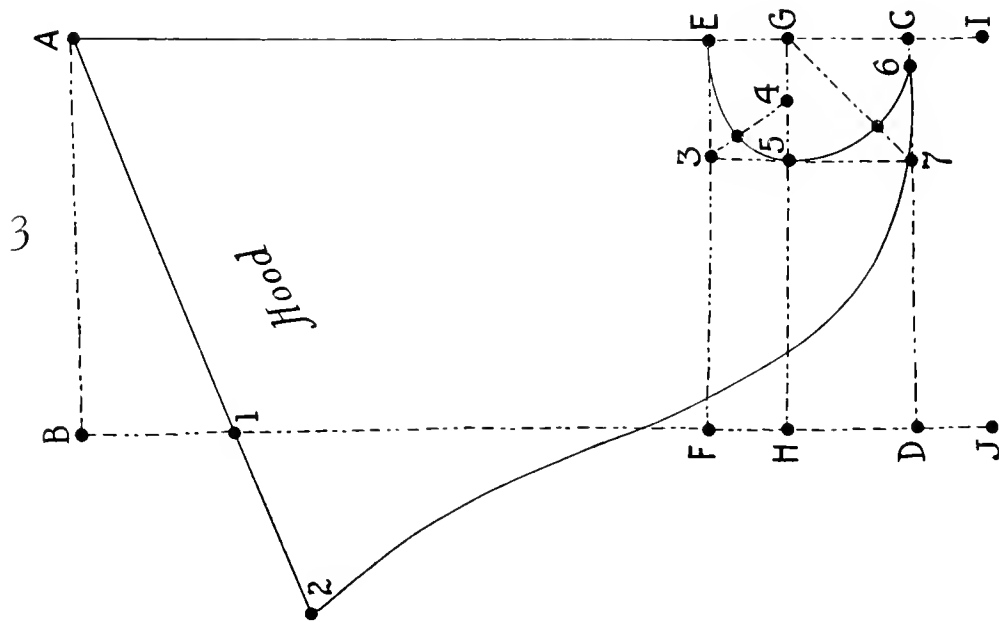
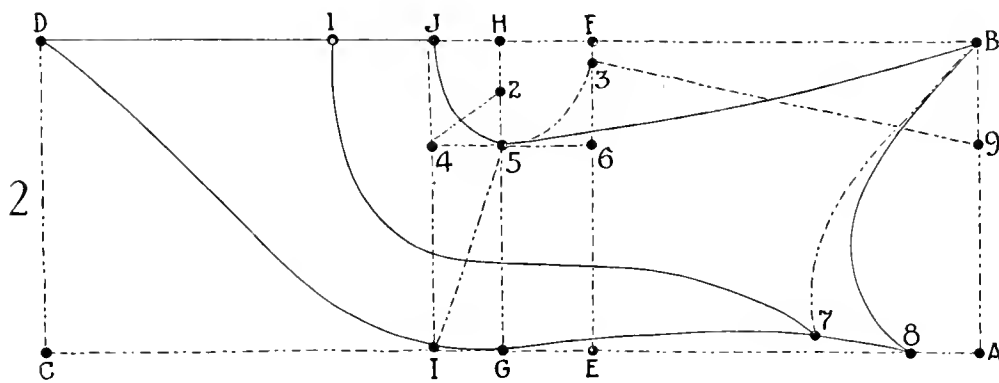
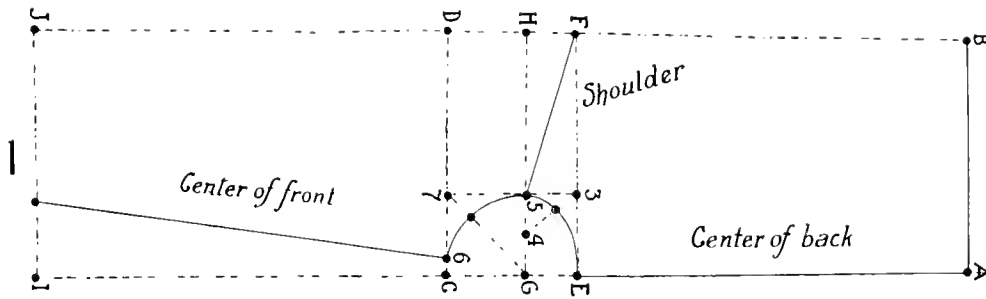

LESSON NO. 26

E A JANNOTTA & CO.
PRINTERS & PUBLISHERS
312-16 WEST ONTARIO ST
CHICAGO

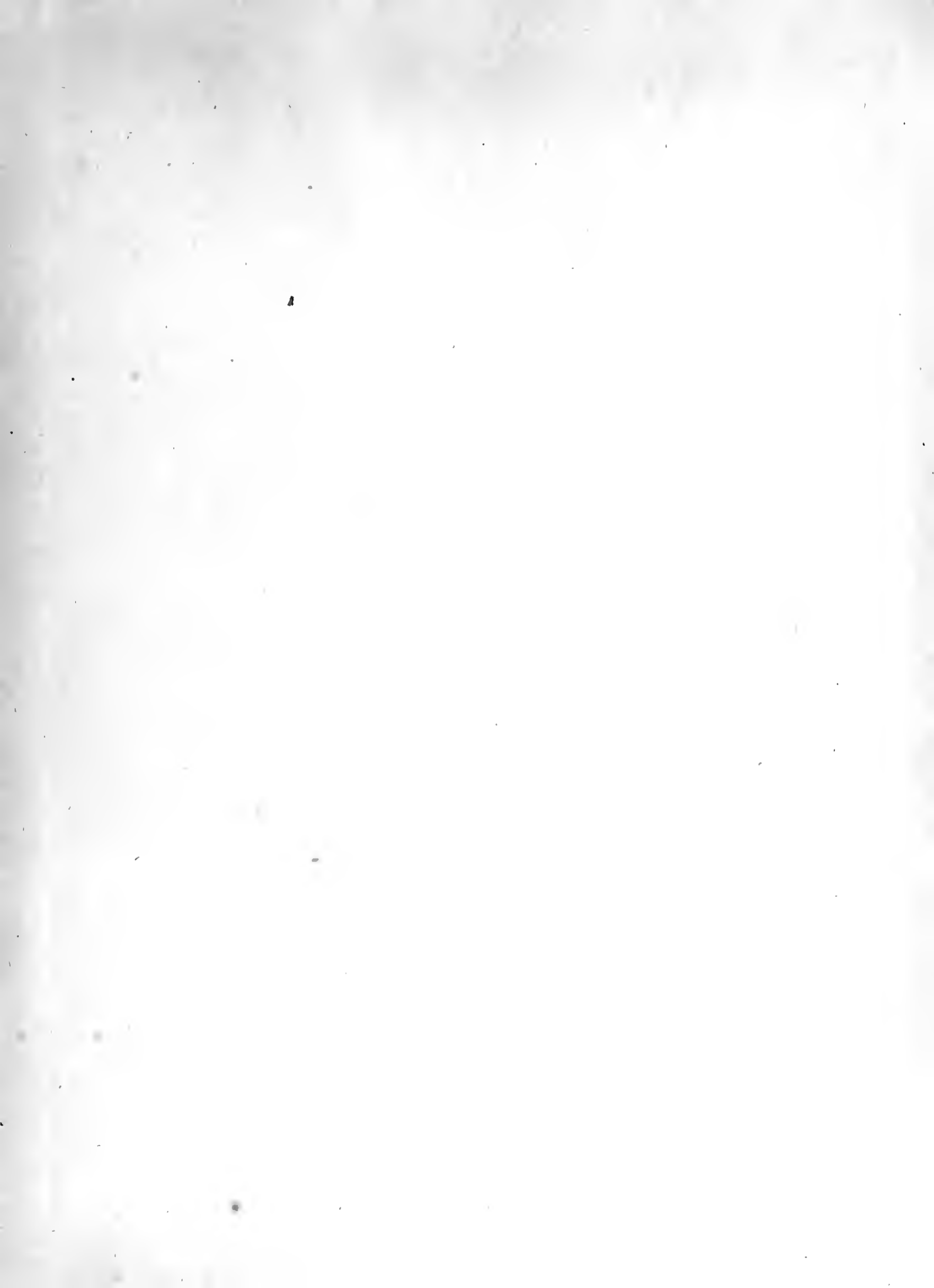

APR 15 1912

LIBRARY OF CONGRESS

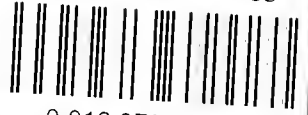

0 013 973 128 1 ●

