

3121P

10.

ANNALS OF BOTANY

VOL. IX



Oxford

PRINTED AT THE CLARENDON PRESS

BY HORACE MART, PRINTER TO THE UNIVERSITY

ANNALS OF BOTANY

EDITED BY

ISAAC BAYLEY BALFOUR, M.A., M.D., F.R.S.

QUEEN'S BOTANIST IN SCOTLAND, PROFESSOR OF BOTANY IN THE UNIVERSITY
AND KEEPER OF THE ROYAL BOTANIC GARDEN, EDINBURGH

SYDNEY HOWARD VINES, M.A., D.Sc., F.R.S.

FELLOW OF MAGDALEN COLLEGE, AND SHERARDIAN PROFESSOR OF BOTANY
IN THE UNIVERSITY OF OXFORD

D. H. SCOTT, M.A., PH.D., F.R.S.

HONORARY KEEPER OF THE JODRELL LABORATORY, ROYAL GARDENS, KEW

AND

WILLIAM GILSON FARLOW, M.D.

PROFESSOR OF CRYPTOGAMIC BOTANY IN HARVARD UNIVERSITY, CAMBRIDGE, MASS., U.S.A.

ASSISTED BY OTHER BOTANISTS

VOLUME IX (Nos. XXXIII—XXXVI)

With XXV Plates, in part coloured, and 13 Woodcuts

London

HENRY FROWDE, AMEN CORNER, E.C.

OXFORD: CLARENDON PRESS DEPOSITORY, 116 HIGH STREET

1895



H. B. 841.

ERRATA.

Page 520, line 6 from bottom, *for* 'little' *read* 'much,' and *for* 'considerable' *read* 'inconsiderable.'

CONTENTS.

No. XXXIII, March, 1895.

	PAGE
MASSEE, G.—A Revision of the Genus <i>Cordyceps</i> . (With Plates I and II)	1
GROOM, P.—On a New Saprophytic Monocotyledon. (With Plate III)	45
KEEBLE, F. W.—The Hanging Foliage of certain Tropical Trees (With Plate IV)	59
HÆCKER, V.—The Reduction of the Chromosomes in the Sexual Cells	95
WORSDELL, W. C.—On the Comparative Anatomy of certain Species of the Genus <i>Christisonia</i> . (With Plates V and VI)	103
BOODLE, L. A.—Spores in a Specimen of <i>Tempskya</i> (Endogenites) (With Woodcut 1)	137
HEMSLEY, W. B.—Descriptions of some New Plants from Eastern Asia. (With Plates VII and VIII)	143
 NOTES.	
JOHNSON, T.—Sporangia of <i>Litosiphon</i> , Harv. : a Correction	161
BLACKMAN, F. F.—Experimental Researches on Vegetable Assimilation and Respiration :—	
(1) On a New Method for Investigating the Carbonic Acid Exchanges of Plants	161
(2) On the Paths of Gaseous Exchange between Aërial Leaves and the Atmosphere	164
BATTERS, E. A. L.—Some New British Algae	168
MASSEE, G.—On an Orchid-Disease	170

No. XXXIV, June, 1895.

O'BRIEN, M.—The Proteids of Wheat	171
WILLIS, J. C. and BURKILL, I. H.—Flowers and Insects in Great Britain. Part I	227
EWART, M. F.—On the Leaf-glands of <i>Ipomoea paniculata</i> . (With Plate IX)	275
PHILLIPS, R. W.—On the Development of the Cystocarp in Rhodomeleaceae. (With Plate X)	289
BATTERS, E. A. L.—On some New British Marine Algae. (With Plate XI)	307
RIDLEY, H. N.—Two New species of <i>Thiamia</i> . (With Plate XII)	323
GROOM, P.—On <i>Thiamia Aseroe</i> (Beccari) and its Mycorrhiza. (With Plates XIII and XIV)	327
 NOTE.	
FARMER, J. B.—Spore-formation and Karyokinesis in Hepaticae	363

	PAGE
No. XXXV, September, 1895.	
TRUE, R. H.—On the Influence of Sudden Changes of Turgor and of Temperature on Growth	365
DIXON, H. H. and JOLY, J.—The Path of the Transpiration-current. (With Woodcuts 2-8)	403
MASSEE, G.—The 'Spot' Disease of Orchids. (With Plate XV)	421
MOORE, J. E. S.—On the Essential Similarity of the Process of Chromosome Reduction in Animals and Plants	431
BEARD, J.—On the Phenomena of Reproduction in Animals and Plants (Antithetic Alternation of Generations)	441
BEARD, J. and MURRAY, J. A.—On the Phenomena of Reproduction in Animals and Plants (Reducing Division in Metazoan Reproduction)	448
BEARD, J.—On the Phenomena of Reproduction in Animals and Plants (the Conjugation of the Infusoria). (With Woodcuts 9-13)	456
FARMER, J. B.—On Spore-formation and Nuclear Division in the Hepaticae. (With Plates XVI, XVII, and XVIII)	469
NOTE.	
WILLIAMSON, W. C. and SCOTT, D. H.—On Lyginodendron and Heterangium	525
No. XXXVI, December, 1895.	
JEFFREY, E. C.—Polyembryony in <i>Erythronium americanum</i> . (With Plate XIX)	537
O'BRIEN, M.—The Proteids of Wheat (II)	543
HANSEN, E. C.—Experimental Studies on the Variation of Yeast-cells	549
HUMPHREY, J. E.—On some Constituents of the Cell. (With Plate XX)	561
CHURCH, A. H.—The Structure of the Thallus of <i>Neomeris dumetosa</i> , Lamour. (With Plates XXI, XXII, and XXIII)	581
TROW, A. H.—The Karyology of <i>Saprolegnia</i> . (With Plates XXIV and XXV)	609
NOTES.	
WARD, H. M.—The Formation of Bacterial Colonies	653
A false Bacterium	657
SOLMS-LAUBACH, H. GRAF ZU.—On a New Form of Fructification in Sphenophylleae	658
WAGER, H.—Preliminary Note upon the Structure of Bacterial Cells	659
SEWARD, A. C.—The Wealden Flora	661
DIXON, H. H.—The Nuclei of <i>Lilium longiflorum</i>	663
Abnormal Nuclei in the Endosperm of <i>Fritillaria imperialis</i>	665
FARMER, J. B.—On Spore-formation in <i>Fegatella conica</i>	666

INDEX.

A. ORIGINAL PAPERS AND NOTES.

	PAGE
BATTERS, E. A. L.	
Some New British Algae	168
On some New British Marine Algae. (With Plate XI)	307
BEARD, J.	
On the Phenomena of Reproduction in Animals and Plants (Antithetic Alternation of Generations)	441
On the Phenomena of Reproduction in Animals and Plants (the Conjugation of the Infusoria). (With Woodcuts 9-13)	456
BEARD, J. and MURRAY, J. A. —On the Phenomena of Reproduction in Animals and Plants (Reducing Division in Metazoan Re- production)	448
BLACKMAN, F. F. —Experimental Researches on Vegetable Assimila- tion and Respiration:—	
(1) On a New Method for Investigating the Carbonic Acid Ex- changes of Plants	161
(2) On the Paths of Gaseous Exchange between Aërial Leaves and the Atmosphere	164
BOODLE, L. A. —Spores in a Specimen of <i>Tempakya</i> (Endogenites). (With Woodcut 1)	137
BURKILL, I. H. —See Willis.	
CHURCH, A. H. —The Structure of the Thallus of <i>Neomeris dumetosa</i> , Lamour. (With Plates XXI, XXII, and XXIII)	581
DIXON, H. H.	
The Nuclei of <i>Lilium longiflorum</i>	663
Abnormal Nuclei in the Endosperm of <i>Fritillaria imperialis</i>	665
DIXON, H. H. and JOLY, J. —The Path of the Transpiration-current. (With Woodcuts 2-8)	403
EWART, M. F. —On the Leaf-glands of <i>Ipomoea paniculata</i> . (With Plate IX)	275
FARMER, J. B.	
Spore-formation and Karyokinesis in Hepaticae	363
On Spore-formation and Nuclear Division in the Hepaticae. (With Plates XVI, XVII, and XVIII)	469
On Spore-formation in <i>Fegatella conica</i>	666
GROOM, P.	
On a New Saprophytic Monocotyledon. (With Plate III)	45
On <i>Thismia Aseroe</i> (Beccari) and its Mycorrhiza. (With Plates XIII and XIV)	327
HAECKER, V. —The Reduction of the Chromosomes in the Sexual Cells	95
HANSEN, E. C. —Experimental Studies on the Variation of Yeast-cells	549
HEMSLEY, W. B. —Descriptions of some New Plants from Eastern Asia. (With Plates VII and VIII)	143
HUMPHREY, J. E. —On some Constituents of the Cell. (With Plate XX)	561
JEFFREY, E. C. —Polyembryony in <i>Erythronium americanum</i> . (With Plate XIX)	537
JOHNSON, T. —Sporangia of <i>Litosiphon</i> , Harv.: a Correction	161

	PAGE
JOLY, J.—See Dixon.	
KEEBLE, F. W.—The Hanging Foliage of certain Tropical Trees. (With Plate IV)	59
MASSEE, G. A Revision of the Genus <i>Cordyceps</i> . (With Plates I and II)	1
On an Orchid-Disease	170
The 'Spot' Disease of Orchids. (With Plate XV)	421
MOORE, J. E. S.—On the Essential Similarity of the Process of Chromosome Reduction in Animals and Plants	431
MURRAY, J. A.—See Beard.	
O'BRIEN, M. The Proteids of Wheat	171
The Proteids of Wheat (II)	543
PHILLIPS, R. W.—On the Development of the Cystocarp in Rhodomelaceae. (With Plate X)	289
RIDLEY, H. N.—Two New Species of <i>Thismia</i> . (With Plate XII)	323
SCOTT, D. H.—See Williamson.	
SEWARD, A. C.—The Wealden Flora	661
SOLMS-LAUBACH, H. GRAF ZU.—On a New Form of Fructification in Sphenophylleae	659
TROW, A. H.—The Karyology of <i>Saprolegnia</i> . (With Plates XXIV and XXV)	609
TRUE, R. H.—On the Influence of Sudden Changes of Turgor and of Temperature on Growth	365
WAGER, H.—Preliminary Note upon the Structure of Bacterial Cells	659
WARD, H. M. The Formation of Bacterial Colonies	653
A false Bacterium	657
WILLIAMSON, W. C. and SCOTT, D. H.—On <i>Lyginodendron</i> and <i>Heterangium</i>	525
WILLIS, J. C. and BURKILL, I. H.—Flowers and Insects in Great Britain. Part I	227
WORSDELL, W. C.—On the Comparative Anatomy of certain Species of the Genus <i>Christisonia</i> . (With Plates V and VI)	103
B. LIST OF ILLUSTRATIONS.	
<i>a. PLATES.</i>	
I, II. <i>Cordyceps</i> (MASSEE).	
III. New Saprophytic Monocotyledon (GROOM).	
IV. Hanging Foliage of Tropical Trees (KEEBLE).	
V, VI. <i>Christisonia</i> (WORSDELL).	
VII, VIII. New Plants from Eastern Asia (HEMSLEY).	
IX. <i>Ipomoea paniculata</i> (EWART).	
X. Cystocarp in Rhodomelaceae (PHILLIPS).	
XI. New British Marine Algae (BATTERS).	
XII. <i>Thismia</i> (RIDLEY).	
XIII, XIV. <i>Thismia Aseroe</i> (GROOM).	
XV. 'Spot' Disease of Orchids (MASSEE).	
XVI, XVII, XVIII. Spore-formation in the Hepaticae (FARMER).	
XIX. <i>Erythronium americanum</i> (JEFFREY).	
XX. Some Constituents of the Cell (HUMPHREY).	
XXI, XXII, XXIII. <i>Neomeris dumetosa</i> , Lamour. (CHURCH).	
XXIV, XXV. Karyology of <i>Saprolegnia</i> (TROW).	
<i>b. WOODCUTS.</i>	
1. Spores in <i>Tempakya</i> (BOODLE)	138
2-8. Transpiration-current (DIXON and JOLY)	406-417
9-13. Reproduction in Animals and Plants (BEARD)	458-463

A Revision of the Genus *Cordyceps*.

BY

GEORGE MASSEE,

Principal Assistant (Cryptogams), Royal Herbarium, Kew.

—♦—
With Plates I and II.
—♦—

THE genus *Cordyceps* is of special interest, alike to the mycologist and entomologist, on account of the species being parasitic on insects. The peculiar combination of plant and animal has attracted attention from early times, and has given origin to some remarkable ideas as to the assumed medicinal value of such unusual productions. The historical and romantic side of the subject has been dealt with quite recently by Dr. Cooke¹. Saccardo² has collected diagnoses of fifty-nine species, including three which are excluded in the present work : of these, seventeen are arranged under *species imperfecte cognitae*, and even in the case of many not included in the imperfectly described batch, the specific characters are too brief to ensure certainty of determination. In the majority of instances, this imperfection is not due to the absence of type or authentic specimens, but to the fact that a considerable number were described

¹ Vegetable wasps and plant worms ; S. P. C. K., London (1892).

² Sylloge Fungorum, Vol. ii, p. 566, and Vol. ix, suppl.

[*Annals of Botany*, Vol. IX. No. XXXIII. March, 1895.]

many years ago, before microscopic detail was considered to be an important factor in the discrimination of species, and up to now, these imperfect diagnoses have not been revised. The determination of a very fine species, recently received from Australia, suggested the necessity of a revision of the genus, and the following is an attempt in this direction, so far as practicable from an examination of the rich collection in the Kew herbarium.

MORPHOLOGY.

A characteristic feature of the genus *Cordyceps* consists in the fact that the ascigerous condition always springs from a sclerotium, formed within the body of the insect on which the fungus is parasitic. In those instances where a conidial form is known, as in *C. militaris*, the sclerotium is present before the ascigerous phase appears, but is not so compact in texture, and has not so completely destroyed the internal organs of the host at this period as when the ascigerous condition is developed. The conidial and ascigerous conditions are not met with at the same period, and it is probable that a considerable interval elapses between the appearance of the two phases; a condition of things that would account for the ascigerous stage not immediately following the formation of conidia in artificial cultures.

When fully developed, the sclerotium has completely destroyed and replaced the internal structure of the larva on which it is parasitic, the skin alone remaining intact; structurally it consists of very compactly interwoven hyaline branched septate hyphae, replete with glycogen and minute oleaginous highly refractive globules; when dry it is very compact and hard, and of a whitish colour.

The ascigerous condition usually emerges from the sclerotium at a point between two segments of the skin of the host, and most frequently in the cervical region; it consists of an erect stem-like sterile portion, composed of a fascicle of irregularly parallel septate hyphae, white internally, the

external or cortical hyphae being usually tinged with colour, and in many species giving off numerous short lateral branches, which form the minutely velvety or downy exterior of the stem. The fertile portion, described in systematic works as the 'head' or 'club,' is usually terminal on the stem-like sterile stroma, and varies in form in different species from globose to clavate or cylindrical; in some few species the fertile portion is situated below the apex of the stem, or several fertile branches spring laterally from the upper portion of the stem. In structure the ascigerous portion, like the stem, may be composed of more or less parallel septate hyphae; not unfrequently the hyphae coalesce laterally and the compound cells are of various lengths, but much of the hyphal origin is still evident; in a few species the coalescence of the hyphae is complete on all sides, and the septa more numerous, so that the component cells present a polygonal outline irrespective of the direction in which the section is taken, and consequently resemble a true parenchymatous tissue.

The perithecia always originate deep in the stroma, and stand side by side, their mouths reaching the surface of the stroma. In form the perithecia are ovate or flask-shaped, and may remain completely immersed, or at maturity be quite superficial, the whole of the perithecium being exposed, and attached to the stroma by the extreme base; transitional stages connect the two extremes. As a rule, when the perithecia are more or less free from the stroma, the surface of the head is rough, whereas when they are completely immersed, it is smooth; but a section is always necessary in cases where the surface of the head is smooth, as in some species where the perithecia are entirely superficial, only very slightly narrowed at the mouth, and closely crowded, they form an almost even surface, as if immersed.

The asci always contain eight spores, are very long and slender, have a slight swelling at the apex, and are hence described as capitate. The function of the capitate apex is to effect dehiscence when the spores are mature; at this

stage the contents of the head become swollen and the wall of the ascus is ruptured at the apex (Pl. I, Fig. 4).

The spores are almost as long as the ascus, and are arranged in a parallel fascicle which is slightly twisted on its axis, hyaline, very slender, multiseptate, rarely with few septa, or continuous; and after escaping from the ascus the multiseptate ones usually break up readily into their component cells.

Paraphyses are entirely absent.

The forms of *Isaria*, included at present in the Hyphomycetes, are supposed to be the conidial stage of species of *Cordyceps*, and in some instances there would appear to be little or no doubt on this point, although it has not been definitely proved by cultures in a single instance. Tulasne¹ has shown, from the evidence afforded by contiguity of development, that *Isaria farinosa*, Fr., is the conidial condition of *Cordyceps militaris*, Link. Atkinson² has recently studied the development of *Isaria farinosa*, Fr., in artificial cultures, and although some very interesting results were obtained, the ascigerous condition was not produced. The author concludes as follows: 'Several cultures on artificial media in culture-tubes have been made, but in no case has anything resulted which shows the perfect or ascigerous stage of the fungus. Upon nutrient agar, nutrient gelatine, and bean-stems, nothing but the cottony or fluffy growth, covered by the farinaceous fructification, appears. On potato this growth first appears, to be succeeded by the characteristic fructification of the *Isaria*-stage. The fact that the *Isaria*-stage will develop readily on various media such as described above, is evidence that it can develop readily as a saprophyte, and is thus more likely to be preserved in greater abundance and in wider distribution than if it were able to propagate itself only on insects.'

¹ Note sur les *Isaria* et *Sphaeria* entomogènes; Ann. Sci. Nat. Bot., sér. iv, Vol. viii, p. 35 (1857); also, *Torrubia militaris*, Sel. Fung. Carpol., Vol. iii, Pl. I, Figs. 19-31 (1865).

² Artificial cultures of an entomogenous fungus; Bot. Gaz., Vol. xix, p. 129, Pl. XIV-XVI (1894).

The fact that *Isaria farinosa* can develop its characteristic fructification as a saprophyte on other than on insect substratum, demolishes the argument that those so-called species of *Isaria* not occurring on insects cannot be the conidial of species of *Cordyceps*.

Numerous species of *Cordyceps* have no correlated conidial form, and on the other hand, still more numerous forms of *Isaria* exist, which at present are not suspected of being connected with any known species of *Cordyceps*. Among the latter may be mentioned more especially *Isaria densa*, Fries, which has been brought into such prominence by the admirable researches of Giard¹. This fungus is parasitic on the larva of the cockchafer, known in different parts of France as *vers blancs*, *turcs*, *mans*, &c., and is well known as one of the most serious of insect scourges with which French agriculturists have to deal. Giard has clearly demonstrated, after years of patient research in the laboratory and in the field, that the conidia of *Isaria densa* can be utilized under certain conditions as an inoculation-medium, resulting in the wholesale destruction of the larvae.

The form-species of *Isaria* which can with the greatest amount of probability be considered as conidial conditions of species of *Cordyceps*, assume different forms of development, as shown by Atkinson and Giard, frequently appearing first as an effused, more or less velvety or cottony layer—the *Botrytis*-form,—and afterwards, influenced by unknown conditions, passing on to the more complex, erect or stipitate form known as *Isaria*; during this phase of development the sclerotium is formed within the body of the host, and finally the ascigerous form appears. Numerous species belonging to the form-genus *Isaria* are only known at present as saprophytes, growing on dead and usually more or less decomposed wood, bark, leaves, flowers, &c.; others are met with on decaying fungi or on dung; on the other hand, some species,

¹ *L'Isaria densa* (Link) Fries, Champignon parasite du Hanneton commun (*Melolontha vulgaris* L.); Bull. Scient. de la France et de la Belg., Tom. XXIV, pp. 1-112, 4 pl. (1893).

as *Isaria fuciformis*, Berk., occur as true parasites under certain conditions, although usually developing as saprophytes, thus leading up to such truly facultative parasites as *Isaria farinosa*, the conidial state of *Cordyceps militaris*, and *Isaria densa*, which Giard has some reason for suspecting to be the conidial condition of *Cordyceps entomorrhiza*.

The genus *Hypocrea*—as understood in the broader sense—may be looked upon as the type of a number of genera, characterized as such more by the amount of facultative parasitism acquired by their respective conidial forms, than by any strictly morphological characters. The majority of species included in the genus *Hypocrea* are undoubtedly true saprophytes throughout the cycle of their development; at the same time, some exotic species, whose life-history is unknown, occur on a vegetable matrix which from appearances suggests parasitism, and in the case of certain species occurring on coriaceous leaves, there appears to be very little room for doubt on this point. *Epichloë*, an allied genus, is mainly characterized by having both the conidial and ascigerous condition developed in the form of a sessile, effused stroma on the culms of living graminaceous plants. In the genus *Claviceps*, parasitic on the fruits of graminaceous plants, we have a higher stage of development; a conidial condition first appears, followed by the formation of a compact, external sclerotium, which after a period of rest, produces the highly differentiated, stipitate ascigerous form of fruit. It remains to be explained why the members of the two genera last mentioned confine their attacks to plants belonging to the order Gramineae. *Cordyceps* differs mainly from the last-named genus in being parasitic on insects, and in the sclerotium being formed within the body of the host; the additional character of the spores breaking up into their component cells, as given by Saccardo¹, being of no value, inasmuch as the spores of some species of *Cordyceps* are continuous, as in *Claviceps*. The ascigerous condition of the

¹ Sylloge Fungorum, Vol. ii, p. 566.

species of *Cordylia* is morphologically identical with that of *Cordyceps*; the generic distinction turns on the absence of a true, compact sclerotium, and in being parasitic on subterranean species of fungi. Finally, the genus *Corallomyces* is in absolute morphological agreement with the ascigerous portion of those species of *Cordyceps* having large superficial perithecia, but differs in the absence of a sclerotium, and in being a true saprophyte.

The numerous forms of *Isaria* having no associated ascigerous stage have not been dealt with.

HOSTS.

As defined in the present work, all the species of *Cordyceps* grow on insects, and have been recorded as occurring on representatives of the following Orders: Hemiptera, Diptera, Lepidoptera, Hymenoptera, and Coleoptera. The larval condition of the insect is the most frequent host, especially such as bury themselves in the ground or amongst moss or vegetable *débris*, but different species occur on every stage of insect development; fewest being known to occur on the adult or imago condition, which however is by no means exempt from attack. Our knowledge respecting the various hosts is very incomplete, owing to their being in many instances beyond certain recognition when the fungus shows itself; and again, until recently it was considered sufficient to state that the fungus was parasitic on a chrysalis, caterpillar, moth, &c.

Gray¹ appears to have been among the first to attempt a determination of the various insects attacked by parasitic fungi, and to his researches we are indebted for the determination of certain hosts given under their respective parasites. The hosts are also enumerated, so far as determinable, in the excellent 'Host-Index' by Farlow and Seymour².

¹ Notices of insects which are known to form the bases of fungoid parasites. A Memoir, privately printed. London (1858).

² A Provisional Host-Index of the Fungi of the United States (1890-91).

The species of *Cordyceps* are spoken of as parasites, because it is known that in several instances the fungus attacks the insect while still alive; and in all probability this condition of things is the rule, although the fruiting stage may not be developed until after the death of the host.

DISTRIBUTION.

The genus is cosmopolitan, being best represented in temperate regions. Taking into consideration only the fifty-one fully described species, their distribution is as follows:—

Old world . . . 27 species.

New world . . . 29 species.

There are 22 species peculiar to the Old World, and 23 species peculiar to the New World, distributed as follows:—

Old World.

Europe, 8 species.

Asia, 5 "

Africa, 1 " (Only 2 species recorded).

Australasia, 6 " (Only 1 additional species recorded.)

East Indies, 2 "

New World.

North America, 9 species. (All from the United States.)

West Indies, 4 "

South America, 8 "

Six species are common to the Old and New World, viz. *C. clavulata*, *C. myrmecophila*, *C. entomorrhiza*, *C. militaris*, *C. sphingum*, *C. armeniaca*: all British except the last named.

C. entomorrhiza has the widest distribution of any known species, being recorded from Europe, Asia, Africa, United States, Australia, and New Zealand.

The Australasian species are remarkable for their gigantic size, as indeed are also the larvae on which they are parasitic. *C. entomorrhiza* is the only species found in this region that is not peculiar to it.

CLASSIFICATION.

From what has already been said relating to the structure and affinities of the genus under consideration, it is evident that two distinct factors—morphological and biological—are available as affording the basis of a systematic arrangement. If grouped from a morphological stand-point, the genera *Cordylia*, *Claviceps*, and *Corallomyces*, at least, would be absorbed in the older genus *Cordyceps*; this would necessitate the formation of subgenera, which are objectionable from every point of view; hence the biological character is here preferred, as limiting *Cordyceps* to those species parasitic on insects, the ascigerous condition arising from a sclerotium formed within the body of the host.

CORDYCEPS, Fries (emended).

Entomogenous. Conidial state forming an effused downy weft, or an erect, clavate, simple or variously branched stroma, consisting of loosely compacted hyphae, which bear the hyaline, continuous, minute conidia at the tips of short branchlets. Ascigerous stage springing from a compact sclerotium formed within the body of the host; stroma differentiated into an erect stem-like, simple or branched, sterile portion, which bears at its apex the fleshy, globose or elongated ascigerous portion; rarely the sterile axis is continued above the ascigerous part, or several elongated fertile branches spring laterally from the erect, sterile stroma. Perithecia ovate or flask-shaped, either entirely immersed in the fleshy stroma, partly immersed, or quite superficial; asci very long, narrowly cylindric-clavate, slightly constricted just below the capitate apex, narrowed downwards into a long, slender base, 8-spored, not becoming blue with iodine; spores almost as long as the ascus, filiform, the apical third often slightly thickest, multiseptate, rarely continuous, hyaline, arranged in a parallel fascicle; more or less flexuous when free, and often breaking up into their component cells; paraphyses absent.

Cordyceps, Fries, Syst. Myc. ii, p. 323 (1823). Used as the name of a tribe of the Pyrenomycetes, including species at present included in the genera *Cordyceps* and *Xylaria*.—Sacc., Syll. vol. ii, p. 566 (excluding the species parasitic on fungi, which constitute the genus *Cordyilia*, suggested by Tulasne—Sel. Fung. Carp. iii, p. 20).

Torrubia, Lév. The first mention of this name appears to be in Ann. Sci. Nat. ser. 3, p. 43, vol. xx (1853), where Tulasne refers to it in a footnote as follows: '*Torrubia*, Lév. (msc. in Herb. Mus. Paris).' The genus is first defined by Tulasne—Sel. Fung. Carp. iii, p. 4 (1865).

* *Perithecia* entirely or partly immersed.

† *Spores* septate.

1. *Cordyceps Barnesii*, Thwaites, Fungi of Ceylon, no. 977, in Linn. Soc. Journ., Bot., vol. xiv, p. 110 (1875); Sacc., Syll. ii, no. 5052. (Plate II, Figs. 19-26.)

Stem cylindrical or slightly thickened at the base, minutely velvety, brown, 3-5 cm. long, 2 mm. thick, often flexuous or angularly crooked, simple or rarely forked; head 1-2 cm. long, 3-4 mm. thick, simple, apex acute, smooth, dotted with the mouths of the densely crowded perithecia when seen under a pocket-lens, 2-3 mm. at the acute apex usually but not always sterile; asci cylindrical, apex capitate, base narrowed into a short pedicel, 8-spored; spores arranged in a parallel fascicle in the ascus, hyaline, filiform, straight or slightly curved when free, 3-septate, $120 \times 2 \mu$, readily breaking up into the four component cells which are slightly rounded at the ends, 30μ long.

Conidial stage. Several of the specimens have the head covered with conidial-bearing branches instead of perithecia; these branches are erumpent, like the perithecia, and towards the base of the head are slender, very irregularly branched, about .5 mm. thick, white, each branchlet bearing at its apex a globose or piriform head, about 1-1.5 mm. across, which is densely covered with minute, hyaline conidia, $2 \times 1 \mu$ diameter. The branches become shorter and less branched higher up the

head, while at the apex they are short and unbranched, bearing a single head at the apex, but this is probably only due to their being younger, the development of the branches being acropetal. The branches consist of very slender hyphae running parallel to the long axis of growth, and expanding like a brush to form the apical head, each hypha bearing a chain of conidia at its tip, the terminal ones becoming free. So far as I can ascertain from the material at hand, the perithecia follow the conidial development on the same head, but on this point I am not certain.

Ceylon (Thwaites, no. 1120 with sketch).

Thwaites' note accompanying the specimens runs as follows. 'Peradeniya, Dec. 1868. Parasitic upon the larvae of a lamellicorn insect (one of the Melolonthidae), which feeds upon the young roots of coffee and other plants. No. 1120. Please call this *Cordyceps Barnesii*, B. and Br., after my friend E. H. Barnes, Esq., who first directed my attention to it.'

The specimen from Ceylon, 'on larvae of some lamellicorn insect at the roots of coffee-trees, Bolagodde,' (Thwaites), and referred by Berkeley to *Cordyceps sobolifera*, Fungi of Ceylon, no. 978, proves to be *Cordyceps Barnesii*; hence there is no proof of the extension of *C. sobolifera* from its Western home to Ceylon.

2. *Cordyceps palustris*, Berk., Journ. Linn. Soc., vol. i, p. 159, tab. 1 (1857); Sacc. Syll. ii, no. 5018; Ellis & Everh., N. Amer. Pyrenom. p. 61. (Plate II, Figs. 1-6.)

Stem 1-3 cm. high, 3-4 mm. thick, simple or divided into 2-4 short branchlets, even, glabrous, brown; ascigerous portion 1-2 cm. long, wider than the stem, obtusely cylindrical-ovate, dull brownish-purple or flesh-colour, minutely rough with the slightly projecting mouths of the perithecia; asci elongated, narrowly cylindrical capitate, tapering below into a long, slender pedicel, 8-spored; spores arranged in a parallel fascicle, slightly curved, filiform, ends narrowed, hyaline, multiguttulate, then multiseptate, septa thick, 100-120 x 1 μ , component cells 1.5 μ long.

On moist, putrid logs, growing singly from the larva of some coleopterous insect. On *Hexapoda*, sp. indet. (Host-Index, p. 182).

Northampton Swamp, S. Carolina, May. (Ravenel, no. 718).

Type specimen, in Herb. Kew., examined.

The perithecia are cylindrical, narrowed at the base when mature, and in reality quite superficial, but owing to being densely crowded and the mouths somewhat obtuse, they appear, when examined with a pocket-lens, to be almost completely immersed in the substance of the stroma. The spores are at first filled with highly refractive oil-globules, and afterwards become multiseptate. I have not seen the spores break up into their component cells, and Berkeley did not intend to convey this idea, as interpreted by Saccardo and Ellis, but meant that the contents became broken up by septa into small parts. Iodine does not colour the asci blue.

3. *Cordyceps insignis*, Cke. and Rav., Grev. vol. 12, p. 38 (1883); Cooke, Veg. Wasps and Plant Worms, p. 170, pl. 1, fig. 3; Sacc., Syll. Suppl. v. ix, no. 4002; Ellis and Everh., N. Amer. Pyren. p. 63.

Stem 3-4 cm. long, $\frac{3}{4}$ cm. thick, equal, pallid, sulcate (obviously due to shrinkage during drying), very minutely velvety at the base; head broadly ovate, livid purple (when dry), 1.5 and 1 cm., very slightly scabrid from the mouths of the narrowly ovate, completely immersed perithecia; asci narrowly cylindrical, slightly constricted below the capitate apex, narrowed below into a slender, stem-like base, 8-spored; spores arranged in a parallel fascicle slightly twisted on its axis, hyaline, filiform, multiseptate, wavy when free, 170-180 \times 1.5 μ , component cells 6-7 μ long, separating readily at maturity.

On larvae buried in the ground. S. Carolina (Ravenel, no. 3251). On *Hexapoda*, sp. indet. (Host-Index, p. 182).

Ravenel's label accompanying the specimen is as follows: 'I found but a single specimen of this and have divided the

stipe and capitulum, retaining half. I send the whole of the large larva. The colour is pretty well preserved. I have seen several insect *Cordyceps* here, but this differs from anything I have seen. On dead larva buried in ground. Seabord of S. C., April 1881. H. W. Ravenel.'

Type specimen in Herb. Kew.

Cooke, in describing the present species, says the asci are $600\ \mu$ long, and the spores $450\ \mu$ long, component cells $12\ \mu$ long. These measurements are wrong, being much too large, and probably due to a mistake as to the objective used during examination. The asci in reality measure $200\text{--}225 \times 7\text{--}8\ \mu$.

4. *Cordyceps Puiggarii*, Speg., Fung. Fueg. no. 304, in Bol. Acad. Nacional Cord. 1888; Sacc., Syll. Suppl., vol. ix, no. 4010.

5. *Cordyceps alutacea*, Quélet, Champ. Jura et Vosges, in Mém. Soc. d'Emulat. de Montbéliard, 1875, p. 57; Sacc., Syll. ii, no. 5023.

Growing among the leaves of *Pinus sylvestris*.

Distrib.—France.

In a footnote Quélet says that in texture and fructification this species closely approaches the genus *Hypocrea*.

6. *Cordyceps sobolifera*, Berk. and Broome, Fungi of Ceylon, no. 978; Sacc., Syll. no. 5021.

Clavaria sobolifera, Hill, Watson and Hill in Phil. Trans., vol. 53, p. 271, tab. 23 (1763).

Sphaeria sobolifera, Berk., Lond. Journ. Bot. vol. ii, p. 207 (1843).

Torrubia sobolifera, Tulasne, Sel. Fung. Carp. iii, p. 10, t. 1, figs. 32, 33.

On the larva of a beetle, probable one of the Melolonthidae.

Distrib.—Dominica; Martinique; Guadeloupe; S. America, with a note on label, as follows: 'On a larva which destroys the cotton crop in S. America.'

7. *Cordyceps sphaecoccephala* (Kl.).

Cordyceps sphaecophila, Berk. and Curt., Fung. Cub. no.

751, in Linn. Soc. Journ., Bot., vol. x, p. 376 (1869); Sacc., Syll. ii, no. 5015.

Torrubia sphaecocephala, Tul., Carpol. iii, p. 16, t. 1, figs. 5-9 (1865).

Sphaeria sphaecocephala, Klotzsch, in Herb. Hook., Kew; this name is adopted by Berkeley—On some Entomogenous Sphaeriae; Lond. Journ. Bot., vol. ii, p. 205 (1843)—with the following explanation: 'The name given to it by Klotzsch with the authority of Künze attached to it, is clearly a wrong transcription of Künze's name in Myc. Hefte, for a somewhat analogous form of *Sp. militaris*; viz. *S. sphaerocephala*. It is, however, so good that I have retained it.'

The word *sphaephila* was introduced by Berkeley in his mention of the species in Fung. Cuben., no. 751, presumably by mistake, and this name has been taken up by Saccardo—Syll. ii, no. 5015.

Exsicc.—Fung. Cubens. Wrightiani, no. 751.

Parasitic on wasps.—species of *Vespa* and *Polybia*.

Distrib.—Jamaica (Dr. Bancroft); Cuba (Wright); St. Vincent, collector not noted; Brazil (Glaziou, no. 18778 a).

8. *Cordyceps myrmecophila*, Cesati, in Klotzsch, Herb. Myc., no. 1033 (1846); Cesati, Comm. Critt. Ital. i, p. 61, t. iv, fig. ii (1861); Nyl., Obs. Pez. Fenn. p. 88, pl. ii, fig. 4 (1868).

Exsicc.—Klotzsch, Herb. Myc. Ed. nova, cura Rabenh. Ed. i, no. 1033; Ed. ii, no. 719; Rab.-Winter, Fung. Eur. no. 3649.

Growing on *Formica rufa*, also on undetermined species belonging to the Coleoptera and Hymenoptera.

Distrib.—Britain; Finland; Italy; Switzerland; U. States; Brazil; Ceylon; Borneo.

9. *Cordyceps curculionum*, Sacc., Mich. i. p. 320 (1879); Syll. ii, no. 5013.

Torrubia curculionum, Tulasne, Carpol. iii, p. 20 (1865).

Parasitic on *Heilipus celsus*, Schoen.

Near Lima, Peru.

10. **Cordyceps Wallaysii**, Westend., Ac. Soc. Bot. Belg., vol. vii, p. 81, fig. 21 (1859); Sacc., Syll. ii, no. 5014.

On the undetermined larva of some insect, attached to grass.

Distrib.—Belgium (Westendorp).

11. **Cordyceps cinerea**, Sacc., Mich. 1, p. 320 (1879), Sacc., Syll. ii, no. 5026.

Torrubia cinerea, Tul. Carpol. i, p. 61 (1861); iii, p. 16, pl. i, fig. 11 (1865).

Exsicc.—Rabenh., Fung. Eur. no. 1010.

On larvae and perfect insects of species of *Carabus*.

Distrib.—France; Germany.

12. **Cordyceps unilateralis**, Sacc., Syll. ii, no. 5027.

Torrubia unilateralis, Tulasne, Carpol. iii, p. 18, pl. 1, figs. 3-4 (1865).

Growing on an ant—*Atta cephalotus*, Fabr.

The specimen described by Tulasne came from Brazil, and a specimen in Kew Herbarium was collected by Professor Trail, F.R.S., in the same country, and growing on the same species of ant.

13. **Cordyceps australis**, Speg., Fung. Arg. Pug. iv, p. 80, no. 208; in Ann. Soc. Cient. Argentina (1880); Sacc. Syll. ii, no. 5028.

Growing on an ant—*Pachycondyla striata*.

Apiahy, Brazil (Dr. Puiggari).

14. **Cordyceps martialis**, Speg., Fung. Puigg., no. 305; in Bol. Acad. Sc. Córdoba (1889), Sacc., Syll. Suppl. vol. ix, no. 4011.

On the larva of some member of the Cerambycidae, near decaying stumps.

Distrib.—Apiahy, Brazil.

15. **Cordyceps goniophora**, Speg., Fung. Puigg., no. 307; in Bol. Acad. Cient. Cord. (1889), Sacc., Syll. Suppl. vol. ix, no. 4012.

On the decayed body of a species of *Mutilla*; among moss.
Distrib.—Aphiahy, Brazil.

16. *Cordyceps Ditmari*, Quélet, Soc. Bot. France, p. 330—xxxviii, pl. vi, fig. 14, séance du 22 Oct. 1877; Sacc., Syll. no. 5024.

On wasps and flies.

Distrib.—France; Germany; Ireland.

Quélet says that the fungus called *Isaria sphecophila*, Ditmar, in Sturm's *Deutschl. Flora*, iii, p. 115, tab. 57, is the conidial form of the present species, and hence called it *Cordyceps Ditmari*. I have received a *Cordyceps* agreeing exactly with Quélet's description, and accompanied by *Isaria sphecophila*, Ditm. from Ireland, collected by Dr. McWeeney. It was growing on the remains of a large bluebottle-like fly.

17. *Cordyceps larvicola*, Quél., Bull. Soc. Bot. France, tom. xxv, p. 292, pl. iii, fig. 1 (1878).

Cordyceps Helopis, Quél., Bull. Soc. Bot. France, tom. xxvi, p. 235 (1879); Sacc., Syll. ii, no. 5025.

On the larva of *Helops caraboides*, Panz.

Distrib.—France.

The present fungus was first described by Quélet as *C. larvicola*, growing on some undetermined larva. The year following this the same fungus was collected by Boudier, and its host determined as *Helops caraboides*, Panz. Thereupon Quélet re-described the fungus, calling it *C. Helopis*, giving *C. larvicola* as a synonym. The oldest name is restored in the present work.

18. *Cordyceps stylophora*, Berk. and Broome, Journ. Linn. Soc., Bot., vol. i, p. 158, pl. i (1857); Sacc., Syll. ii, no. 5017; Ellis and Everh., N. Amer. Pyren. p. 61. (Plate II, Figs. 40-42.)

Exsicc.—Rav., Fung. Car. Exs., Fasc. v, no. 49.

Solitary; entirely tawny when dry; stem 1.5-2.5 cm. high, 1.5-2 mm. thick, straight or flexuous, velvety or sometimes almost strigose at the base, longitudinally wrinkled when dry; head cylindrical, 1-1.5 cm. long, 2.5-3 mm. thick, almost

smooth, marked with minute depressions corresponding to the mouths of the immersed, scattered perithecia; the apex of the head runs out into a slender, pointed, sterile, spine-like prolongation 1-1.5 cm. long; asci cylindrical, very slightly narrowed below the slightly capitate apex, 8-spored; spores arranged in a parallel fascicle in the ascus, hyaline, filiform, slightly curved when free, multiseptate, $125-135 \times 1 \mu$, the component cells about 3.5μ long.

On *Hexapoda*, sp. indet. (Host-Index, p. 182). On larvae buried in rotten logs. South Carolina (Ravenel, no. 1325).

Type specimen in Herb. Kew., examined.

A remarkable species, characterized by the long, slender, sterile apiculus, continuing beyond the apex of the fertile head; or in other words, the fertile portion—head—occupies about the median third of the stem. This character appears to be constant, being present in each of the eight specimens sent by Ravenel to Berkeley, several being fertile and in a fine state of preservation. The specimens in Ravenel's Exsicc. are poor and scanty.

19. *Cordyceps gentilis*, Sacc., Syll. ii, no. 5020.

Torrubia gentilis, Cesati, Myc. Borneo, in Mem. Acad. Neapol. p. 14 (1879).

Growing on a wasp.

Distrib.—Sarawak, Borneo (Beccari).

20. *Cordyceps Hawkesii*, Gray. Notices insect bases of fungi, pl. v, figs. 10-12 (1858); Grev. vol. xix, p. 76; Sacc., Syll. Suppl. vol. ix, no. 4013.

'The caterpillar may be that of a species of *Pielus*, or of some closely allied genus.'

Distrib.—Tasmania (Hawkes).

21. *Cordyceps Forquignoni*, Quél., xvi Suppl. Champ. Jura et Vosges, p. 6, t. 21, fig. 18; Sacc., Syll. Suppl. ix, no 4007.

On *Musca rufa* or *Dasyphora pratorum*.

Distrib.—France.

22. *Cordyceps Barberi*, Giard, Compt. Rendus Soc. de Biol., Paris, séance du 22 Déc. 1894, p. 823. (Plate II, Figs. 34-35.)

Gregarious, most numerous in the cervical region, but springing from every part of the caterpillar, 2-4 cm. high, entirely whitish or tinged with amber upwards; ascigerous portion $\frac{1}{3}$ - $\frac{1}{2}$ the whole length, tip pointed, often curved, 3-4 mm. thick at the widest part, smooth and even, very minutely pitted with the mouths of the completely immersed, ovate perithecia; stem slender, wavy; asci narrowly cylindrical-clavate; very slightly narrowed immediately below the capitate apex, 8-spored; spores hyaline, arranged in a parallel, very slightly twisted fascicle in the ascus, filiform, very slightly thickened above the middle, multiguttulate, then multiseptate, $115-125 \times 1.5 \mu$; component cells about 2.5μ long.

Parasitic on the larvae of *Diatraea saccharalis*, Fab., the perfect state of which is known in the West Indies as the 'moth-borer,' on account of its habit of perforating the culms of sugar-cane, and consequently doing a large amount of injury to the crop.

Distrib.—Barbados; Antigua.

Type specimens in Herb. Kew.

The specimens were sent to Kew by Mr. John R. Bovell, F.C.S., F.L.S., &c., during the autumn of 1894, and were labelled *Cordyceps Bovellii*, but *C. Barberi*, Giard, has been adopted, having priority of publication, and on the assumption that *Isaria Barberi*, Giard, l.c., is the conidial form of the ascigerous condition described above.

The larvae are attacked by the fungus while lying in their burrows in the cane-stems. The fungus springs from every part of the caterpillar, hence the stems vary in length, those originating farthest away from the mouth of the burrow being longest, as all the stems appear to grow towards the opening, and push the ascigerous portion into the air.

23. *Cordyceps Gunnii*, Berk., Decad. Fung. no. 200, in Hook. Journ. Bot., vol. vii, p. 577, pl. xxii (1848); Flor. Tasm. ii, p. 278; Curr., Comp. Sphaer., Trans. Linn. Soc.

vol. xxii, p. 262, t. xlv, figs. 1, 2; Cooke, Veget. Wasps and Plant-worms, p. 143, fig. 30 (a small specimen); Sacc., Syll. vol. ii, no. 5030.

Solitary, springing from the cervical region of the caterpillar on which it is parasitic; very variable in size, but always large; stem 6-30 cm. long, 5-8 mm. thick, sub-cylindrical, almost even, simple or rarely forked, one branch usually being much smaller than the other, whitish, the greater portion buried in the ground and covered, more or less, with minute particles of sand; ascigerous portion cylindrical or lanceolate, apex acute or obtuse, 4-8 cm. long, somewhat thicker than the stem; even, perithecia narrowly ovate, completely immersed, the crowded mouths projecting as minute points above the surface of the club; asci cylindric-clavate, slightly constricted just below the capitate apex, 8-spored; spores arranged in a parallel fascicle in the ascus, hyaline, filiform, upper portion with a very slight tendency to become clavate, at first multiguttulate, then multiseptate, somewhat wavy when free, $155-165 \times 2.5-3 \mu$; component cells 4-5 μ long, readily separating at maturity.

On caterpillars of some *Cossus* or *Hepialis*.

Franklin Village, near Lancaster; Tasmania (Gunn, no. 1800); Melbourne, Victoria (F. Reader); Blue Mountain Range, New South Wales (Rev. D. Wood); Port Philip, Australia (C. French).

Type specimens in Herb. Berk., Kew.

Growing from the neck of a caterpillar buried deeply in sandy ground. Stem with caterpillar five to eighteen inches long, rarely branched, flexuous, rugged below, cylindrical, white, solid, collecting particles of sand by means of a few downy threads. (Gunn in litt.)

24. *Cordyceps flavella*, Berk. & Curt., Fungi Cubenses, no. 748, in Linn. Soc. Journ. vol. x, p. 375 (1869); Sacc., Syll. vol. ii, no. 5022. (Plate II, Figs. 7-10.)

Stems gregarious, 3-5 springing from nearly the same point, 24-30 mm. long, about 1 mm. thick, equal, straight or

slightly flexuous, even, glabrous; head globose, rough with the projecting mouths of the perithecia, 2 mm. diameter, like the stem pale-yellow; asci elongated, narrowly cylindrical, apex capitate, narrowed below into a slender pedicel, 8-spored; spores arranged in a parallel fascicle, slightly flexuous when free, hyaline, filiform, multiseptate, $80 \times 1 \mu$, component cells about 4μ long.

Among leaves on wood, growing from portion of a caterpillar. Cuba (Wright, no. 519).

Perithecia crowded, mouths narrowed and prominent. The entire fungus is pale amber-colour, and the stem is almost translucent when dry.

25. *Cordyceps Lloydii*, Fawcett, Ann. Nat. Hist., 1886, p. 316, with a fig.; Cooke, Veg. Wasps and Plant Worms, p. 36, with fig.; Sacc., Syll. Suppl. vol. ix, no. 4009.

On the body of an ant—*Camponotus atriceps*.

Distrib.—Near the river Púruni, Guiana.

26. *Cordyceps dipterigena*, Berk. & Broome, Fungi of Ceylon, no. 980, in Linn. Soc. Journ., Bot., vol. xi, p. 111 (1871); Sacc., Syll. viii, 5053. (Plate II, Figs. 29-32.)

Gregarious; stems simple, $\frac{1}{3}$ -1 cm. high, 1 mm. thick, cylindrical, smooth and even, pallid, head globose, smooth, pallid, about 3 mm. across; asci cylindrical, narrowed below into a long, slender pedicel, apex capitate, 8-spored; spores arranged in a parallel fascicle in the ascus, hyaline, filiform, multiseptate, slightly constricted at the septa, and apparently always breaking up into the component cells, which are linear-elliptic, ends narrowed, truncate, hyaline, $10 \times 1.5 \mu$, before leaving the ascus.

On dipterous insect. Ceylon (Thwaites).

Type specimen in Herb. Kew., examined.

A very fine and remarkable species, easily recognized by the peculiar structure of the spores. The perithecia are completely immersed in the substance of the stroma, the mouths appearing as very minute depressions on the surface when moist.

27. *Cordyceps biocephala*, Berk., Decades of Fungi, no. 617, in Hook. Journ. Bot., vol. viii, p. 278 (1856); Sacc., Syll. ii, no. 5029. (Plate II, Fig. 16.)

Solitary; stem 5 cm. long, 1 mm. thick, equal, even, slightly curved at the base, very minutely pulverulent under a lens, brown, paler upwards, forked into two equal branches at 1 cm. from the apex, each branch terminated by a pale brown, elliptical, perfectly even, minutely pulverulent head measuring 3×2 mm.; asci cylindrical, narrowed at the base into a long, slender pedicel, apex capitate, 8-spored; spores arranged in a parallel fascicle in the ascus, hyaline, linear, slightly wavy when free, multiseptate, $70 \times 1 \mu$; component cells about 3μ long, not observed to break up at the septa.

Panuré, Rio Negro, S. America (Spruce).

Type specimen in Herb. Kew., examined.

This curious species, of which I have seen a single specimen only, is almost intermediate between *Cordyceps* and *Xylaria*, the latter of which it approaches in substance. The clavate tip of the inner membrane of the ascus, and the filiform sporidia, indicate an affinity with the more noble species of *Cordyceps* (Berk., l. c.).

As stated by Berkeley, the present species closely resembles superficially certain species of *Xylaria*, section *Xylodactyla*; nevertheless it is a genuine *Cordyceps*. The perithecia are somewhat crowded, and completely immersed in the stroma; hence the surface of the head is perfectly smooth and even when dry, the mouths of the perithecia showing as minute depressions when moist. It is not probable that the apical forking of the stem is a constant specific feature, as in other species the branching is often very erratic. Unfortunately no mention is made of its habitat.

28. *Cordyceps velutipes*, Mass. (n. sp.). Solitary, or more frequently gregarious, springing from the under surface of the cervical region of a caterpillar; every part ochraceous-brown when dry; stem simple or forked, 2-4 cm. long, 3-4 mm. thick, usually crooked, lower portion densely villose, becoming

glabrous upwards; head subglobose or broadly ovate, up to 1 cm. long, smooth and even; perithecia completely immersed, elongated, narrowly cylindrical-ovate; asci slender, slightly contracted below the capitate apex, 8-spored; spores arranged in a parallel fascicle in the ascus, multiseptate, $150-160 \times 1 \mu$, not seen free.

'On larva of *Elateridae*.'

Type in Herb. Kew.; comm. Prof. MacOwan. 'Klerksdorp, S. Afr. Republ., E. G. Alston.'

29. *Cordyceps clavulata*, Ellis & Everh., N. Amer. Pyrenomyc. p. 61, pl. xv, figs. 11-13 (1892).

Sphaeria clavulata, Schw., Syn. N. Amer. Fungi, in Trans. Amer. Phil. Soc., vol. iv, n. ser. (1834).

Cordyceps pistillariaeformis, Berk. & Br. no. 969, in Ann. Nat. Hist. ser. iii, vol. 7, p. 13, pl. xvi, fig. 22 (1861); Sacc., Syll. ii, no. 5019.

Torrubia pistillariaeformis, Cooke, Hdbk. no. 2323 (1871).

Ellis, l. c., says, 'The Syn.' *Torrubia cinerea*, Ell. 'in Sacc. Syll. rests on some error.' The error originated as follows. Ellis sent a specimen to Cooke, labelled as follows, '*Torrubia cinerea*, n. s.—on bark louse, on *Clethra alnifolia*. Newfield, N. Y., Oct. 1875, J. B. Ellis.' Cooke observing that the specimens were identical with *Sphaeria clavulata*, Schw., and *Cordyceps pistillariaeformis*, B. & Br., sent a note to that effect to Saccardo for the Sylloge.

Exsicc.—Roumeg., Fung. Sel. Exs. no. 4782 (as *Cordyceps pistillariaeformis*, B. & Br.); Thüm., Myc. Univ. no. 1258 (as *Torrubia clavulata*, Peck).

On dead scale insects (*Lecanium*), on living branches of *Fraxinus* and *Prinos*, N. Y. (Peck). On branches of *Clethra*, Newfield, N. Y., on *Carpinus*, Canada (Dearness) (Ellis & Everh., l. c.).

Berkeley's British specimens, now in Kew Herbarium, are growing on some scale-insect on Wych-elm (*Ulmus montana*), and agree in every detail with the American species.

Distrib.—United States; Canada; Great Britain.

30. *Cordyceps armeniaca*, Berk. & Curt., Journ. Linn. Soc., vol. i, p. 158, tab. i (1857); Sacc., Syll. ii, no. 5016; Ellis and Everh., N. Amer. Pyrenom. p. 60. (Plate II, Fig. 18.)

Stem 5-9 mm. high, up to 1 mm. thick, equal, glabrous, often flexuous and sometimes twisted, pale orange with a tinge of pink; ascigerous portion subglobose, 2-3 mm. diameter, apricot colour, rough with the slightly projecting mouths of the perithecia; asci elongated, narrowly cylindrical-clavate, capitate, tapering below into a long, slender pedicel, 8-spored; spores arranged in a parallel fascicle, slightly curved or flexuous when free, filiform, ends narrowed, hyaline; multi-guttulate, then multiseptate, $80-85 \times 1 \mu$, breaking up into its component cells, which are about 3μ long.

Apparently on the excrement of birds. Society Hill, South Carolina (Ravenel, 3774); Rangoon (Capt. E. S. Berkeley); Ceylon, on coleopterous insect (Thwaites).

Type specimen in Herb. Kew., examined.

The specimens are solitary or 2-3 springing from nearly the same point. Perithecia ovate, densely crowded; ostium narrowed and somewhat elongated when moist, more or less contracted when dry, so that the head is only slightly rough.

31. *Cordyceps calocerooides*, Berk. & Curt., Fungi Cubenses, no. 749, in Linn. Soc. Journ., Bot., vol. x, p. 375 (1869); Sacc., Syll. ii, no. 5050. (Plate II, Figs. 11-13.)

Stem 8-9 cm. high, dividing about half way up into two equal branches, smooth, even, shining, reddish-brown, about $1\frac{1}{4}$ mm. thick below the bifurcation, branches thinner, cylindrical, more or less flexuous, base curved; each branch is terminated by an elongated, narrowly cylindrical, acute head coloured like the stem, and minutely rough with the projecting mouths of the crowded perithecia, 3-5 cm. long; asci narrowly cylindrical, apex slightly capitate, base narrowed into a long slender pedicel, 8-spored; spores arranged in a parallel fascicle in the ascus, hyaline, filiform, slightly curved when free, $75-80 \times 1 \mu$, multiseptate, component cells $4-5 \mu$ long.

On the ground. Cuba (Wright, no. 309).

Type specimen in Herb. Kew., examined.

No mention is made of the habitat, and the base of the stem is quite naked. The perithecia are perfectly superficial, but closely crowded, the narrowed mouths giving the superficial granular appearance to the head when seen under a pocket-lens. The structures of the head and walls of the perithecia are truly parenchymatous.

32. *Cordyceps sinensis*, (Berk.) Sacc., Syll. ii, no. 5051.

Sphaeria sinensis, Berk., Lond. Journ. Bot., vol. ii, p. 207, tab. viii, fig. 1 (1843). (Plate II, Fig. 17.)

Solitary; stem 2.5–5 cm. long, 2–3 mm. thick, almost cylindrical, or sometimes becoming thicker downwards, straight or flexuous, more or less downy at the base, longitudinally wrinkled when dry; head cylindrical, apex pointed and usually—but not always—sterile, 1–2.5 cm. long, 3–4 mm. thick, surface minutely granular with the slightly projecting, obtuse mouths of the ovate, slightly distant perithecia; asci cylindrical, very slightly narrowed just below the capitate apex, base narrowed into a slender pedicel, 8-spored; spores arranged in a parallel fascicle in the ascus, hyaline, filiform, slightly flexuous when free, multiseptate, $85\text{--}90 \times 1.5\mu$, component cells about 4μ long, not observed to separate.

Growing from the head of a caterpillar, which Gray—Notices of Insects which are known to form the bases of Fungoid Parasites, p. 12—considers as belonging to the *Noc-tuidæ*, and probably to the genus *Gortyna*.

China. Also stated to occur in Japan and Thibet.

Type specimen in Herb. Kew., examined.

In one of the specimens figured by Berkeley the head is shown to be compressed and inclined to branch at the apex. The flattening appears, from examination of the specimen, to be due to shrinkage, being immature and soft when collected.

Accounts mostly of historical interest relating to this species, which is highly prized in China on account of its supposed

medicinal virtues, are to be found in the following works, under the titles given :—

Hia Tsao Tom Tchom; Réaumur, Mém. de l'Acad. des Sc., 1726, p. 302, tab. xvi; Rees, Cycl. vol. xvii.

Hia Tsao Tong Tchong; Duhalde, China, vol. iii, p. 490.

Hea Tsaon Taong Chung; Westwood, Ann. Nat. Hist. vol. viii, p. 217.

Chinese Plant Worm; Cooke, 'Vegetable Wasps and Plant Worms,' p. 200.

The following account is given by Berkeley, following the diagnosis of the species :—'This species is a celebrated drug in the Chinese Pharmacopoeia, but from its rarity only used by the Emperor's physician; in its properties it resembles Ginseng, being a strengthener and restorative, but does not like that cause hemorrhage. Father Perennin states that he was raised from a state of extreme weakness by the use of this medicine, which was administered dressed in the body of a duck. The Chinese name refers to the notion that it is a herb in summer and a worm in winter. It is sold in little bundles tied up with silk.'

33. *Cordyceps entomorrhiza*, (Dickson) Fries, Summa Veg. Scand. p. 381 (1846) (name only); Sacc., Syll. ii, no. 5012.

Sphaeria entomorrhiza, Dickson, Fasc. Plant. Crypt. Brit., Fasc. i, p. 22, tab. iii, fig. 3 (1785).

Torrubia entomorrhiza, Tul., Carp. vol. iii, p. 14, pl. i, figs. 12-18 (figures excellent).

Xylaria gracilis, Grev., Scot. Crypt. Fl. p. 86, pl. 86 (1823-1828).

Cordyceps gracilis, Dur. & Mont., Flor. Alg. i, p. 449; figure in atlas, pl. xxv, fig. ii; Sacc., Syll. ii, no. 5011.

Cordyceps menesteridis, Müll. & Berk., Gard. Chron., Decr. 21, 1878, fig. 130.

The fungus grows on different hosts. Gray says that the larva figured by Dickson may probably belong to the Silphidae, while the specimen figured in his own work, pl. iii. fig. 10, he supposes, judging from the caterpillar, to belong

to the *Lithoosidae*. Saccardo—Syll. ii, p. 567—says the fungus occurs on larvae belonging to the genus *Tinea*. The Australian specimens were found on the larvae of *Menesteris laticollis*. On *Hexapoda*, sp. indet. (Host-Index, p. 182). On *Melolontha vulgaris*—Giard, l. c., p. 46.

Examination of a specimen of *Xylaria gracilis* from Greville enables me to reduce that form to the present species. The type of *Cordyceps menesteridis* also examined.

Exsicc.—Cooke, Fung. Brit. Exs., no. 187; Plowright, Sphaer. Brit., Cent. 2, no. i.

Distrib.—Great Britain (Berkeley, Broome, Cooke, Dickson, Greville, Leighton, Plowright); Germany (Auerswald); France (Bernier); Algiers (com. Montagne); Lower Carolina (Ravenel, no. 2613); New Zealand (Colenso, no. 3015); Australia (Mueller); Khasia (Hooker).

34. *Cordyceps herculea*, Sacc., Syll. ii, no. 5055; Ellis & Everh., N. Amer. Pyrenom., p. 63.

Sphaeria herculea, Schw., Syn. Fung. Amer. Bor. no. 1153, in Trans. Amer. Phil. Soc. vol. iv, n. ser. (1834).

On *Hexapoda*, sp. indet. (Host-Index, p. 182).

Distrib.—United States. Salem, N. C. (Schw.); Ohio (Prof. A. P. Morgan).

35. *Cordyceps Langloisii*, Ellis & Everh., N. Amer. Pyrenom. p. 62 (1892).

On dead larvae of 'mason-wasp.'

Distrib.—United States, near St. Martinsville, La. (Langlois, no. 2295).

36. *Cordyceps nutans*, Pat., Bull. Soc. Myc. 1887, p. 127, pl. xi, fig. 5; Sacc., Syll. Suppl. ix, no. 4005.

Springing from between the head and thorax of some adult hemipterous insect.

Distrib.—Japan.

37. *Cordyceps Odyneri*, Quél., Bull. Soc. Mycol. 1886, p. 80; 14th Suppl. Champ. Jura et Vosges, p. 10, pl. xii, fig.

28, in Bull. de l'Assoc. Franç. pour l'avancem. des sc., Congrès de Grenoble, 1885; Sacc., Syll. Suppl. vol. ix, no. 4006.

On the larva of a species of *Odynera*.

Distrib.—France.

38. *Cordyceps Sherringii*, Masee, Annals Bot., vol. v, p. 510, fig. 4 (1890); Cooke, Veget. Wasps and Plant Worms, p. 55, fig. 8 (incorrectly written *Sheeringii*).

Cordyceps Sheeringii, Masee; on an ant.

Growing from a small ant, attached to the living frond of a fern.

Distrib.—Is. of Granada, W. Indies.

†† *Spores continuous.*

39. *Cordyceps albida*, Pat., Bull. Soc. Myc., 1888, p. 116; Sacc., Syll. Suppl. ix, no. 4004.

On a dead, undetermined larva, buried in sand.

Distrib.—Atures, Venezuela.

40. *Cordyceps Doassansii*, Pat., Tab. Analyt. Fung., p. 213, fig. 494 (1885); Sacc., Syll. Suppl. vol. ix, no. 4008.

On chrysalis of Lepidopterous insect.

Distrib.—France.

** *Perithecia superficial.*

† *Spores septate.*

41. *Cordyceps Taylori*, Sacc., Mich., i, p. 320 (1879); Sacc., Syll. ii, no. 5041; W. G. Smith, Gard. Chron. Feb. 26, 1887, p. 288, fig. 62 (excellent); Cooke, Veget. Wasps and Plant Worms, p. 155, fig. 31 (being a portion of the fig. from Gard. Chron.).

Sphaeria Taylori, Berk., Hook. Journ. Bot. vol. ii, p. 209, tab. viii, fig. 2 (1843).

Sphaeria innominata, Taylor, Tasmanian Journal, 1848, p. 308, fig. 2.

Springing from the second joint from the head, stem stout,

entire at the base where it is 1.5–2 cm. thick, soon breaking up into 3–5 almost equal branches 5–9 cm. long and 1 cm. thick, very rugged and irregular, covered with a dense, reddish-brown tomentum, more or less buried in the ground and covered with particles of earth; the apex of each branch is terminated by the ascigerous portion, which takes the form of a stag's antler, branched, compressed, axils rounded, tips acute, 3–6 cm. high, with a spread of 3–4 cm., the broadest branches up to $\frac{3}{4}$ cm. in width; 1–3 such branches spring from the tip of each stem; these branches are at first minutely velvety and wash-leather colour, becoming glabrous, greyish black, and rough with the superficial, broadly ovate, obtuse perithecia; asci narrowly cylindric-clavate, slightly constricted below the capitate apex, narrowed below into a slender pedicel, 8-spored; spores arranged in a parallel, slightly twisted fascicle, flexuous when free, hyaline, cylindric-filiform, ends attenuated, multiseptate, $150\text{--}175 \times 2 \mu$, component cells about 3μ long.

Growing on some undetermined caterpillar, 12–15 cm. long, buried in black, alluvial soil.

Distrib.—Banks of the Murrumbidgee, Australia (Adams; com. Taylor); Victoria (Sir F. von Mueller).

The largest and finest species in the genus; specimens in the Kew Herbarium show that the body of the caterpillar is completely filled with the sclerotium before the fungus bursts through to produce its fructification. The sclerotium is very compact, and when dry is as hard as wood, the hyphae forming it are very slender, rarely exceeding 3μ in thickness, sparsely septate, and very densely interwoven.

42. *Cordyceps Henleyae*, Mass., Ann. Bot. vol. viii, p. 119. (Plate I.)

Solitary, springing from the cervical region of a large caterpillar, stroma or stem erect 18–20 cm. long and about $\frac{3}{8}$ cm. thick, cylindrical, slightly narrowed at the base, pale brown, very minutely velvety under a lens, even when fresh, becoming longitudinally wrinkled when dry; fertile branches

erumpent, springing at intervals from the upper third of the stem, 6-9 in number and arranged in a corymbose manner, 6-10 cm. long, $\frac{1}{2}$ cm. thick at the widest part, attenuated upwards; perithecia superficial, crowded but distinct, flask-shaped with a long mouth, pale brown; asci narrowly clavate, capitate, narrowed below into a slender pedicel, 8-spored; spores arranged in a parallel fascicle in the ascus, the entire fascicle slightly twisted on its axis, hyaline, linear, ends slightly tapering, multiseptate, $125-130 \times 2 \mu$; component cells 2.5μ long, readily separating at maturity.

Parasitic on a large caterpillar, apparently the larva of some species of *Hepialus*.

Owen's River, Victoria, Australia; coll. Miss M. Henley; comm. Sir Ferd. Mueller.

Type specimen in Herb. Kew.

A very distinct and beautiful species, without any near ally. Judging from the presence of numerous particles of sand adhering to the lower portion of the stem, it may be supposed that the caterpillar was buried several centimetres below the surface. The amount of differentiation is more marked in the present than in any other known species, the fertile branches being quite distinct, and erumpent from the upright stroma or stem. The transverse septa of the spores are thick, and when the spores have once become dry, do not thoroughly expand in water, the cell-wall remaining more contracted than the rigid septa, and presenting the appearance shown in Figs. 5 and 7, Pl. II; when treated with dilute potassic hydrate the spores assume their original, normal appearance, Figs. 6 and 8, Pl. II. The skin of the caterpillar bearing the fungus is intact, but the whole of the contents with the exception of traces of the alimentary canal have been replaced by a mass of compactly interwoven, branched, sparsely septate, hyaline hyphae, forming a true sclerotium, white in colour, and of a woody hardness when dry.

No trace of a conidial stage, and no external mycelium is present on the specimens.

43. *Cordyceps Hugelii*, Corda, Anleit. Stud. der Mycol. p. 207, tab. F, fig. 22 (1842); Sacc., Syll. ii, no. 5034.

Sphaeria Hugelii, Corda, Icon. Fung. pt. iv, p. 44, tab. ix, fig. 129.

Sphaeria Robertsii, Hook., Hook. Journ. Bot. vol. ii, p. 209 (1843).

Cordyceps Robertsii, Hook., Flor. New Zealand, vol. ii, p. 202 (1855).

Parasitic on the larva of *Hepialis virescens*, Doubleday.

Distrib.—New Zealand (Colenso; Dr. Berggren; F. Moore).

var. neglecta, Mass. (Plate II, Fig. 33.)

Agreeing with the typical form in general appearance and size, also in occurring on the same host; differing in the superficial perithecia being flask-shaped with a long, slender ostiolum, and in the component cells of the spore measuring $6-7 \times 2 \mu$.

New Zealand (Colenso).

Type in Herb. Kew.

44. *Cordyceps militaris*, Link, Hdbk. iii, p. 347 (1833); Sacc., Syll. ii, no. 5031.

Clavaria militaris, Linn., Sp. Pl., ed. i, p. 1182 (1753); Flor. Dan. tab. 657 (1775).

Torrubia militaris, Tul., Sel. Fung. Carp., iii, p. 6, t. i, figs. 19-31.

(Conidial form) *Ramaria farinosa*, Th. Holm., Nov. Act. Acad. Hafinen., vol. i, p. 299, fig. 6 (1781).

Isaria farinosa, Fries, Syst. Myc. iii, p. 271 (1832).

Exsicc.—Sydow, Myc. March., no. 954; Klotzsch, Herb. Myc. no. 47; Plowright, Cent. iii, no. 1, of Sphaer. Brit; Fuckel, Fung. Rhen. nos. 1067 and 2535; Rabenh., Winter Fung. Eur. no. 3548 (in larvibus et sphingibus emortuis); Roum., Fung. Gall. Exs. no. 3157.

Growing on the chrysalis or larva stage of insects mostly belonging to the Lepidoptera. Gray mentions *Phalera bucephala*, one of the *Notodontidae*, as one of the hosts. On *Lachnosterna quercina* (Thaxter, Host-Index, p. 181).

According to Giard the ordinary habitat of this species is on the caterpillars of Bombyces belonging to the genus *Gastropacha*. Has also occurred on the perfect form of the cockchafer (*Melolontha vulgaris*) according to Roumeguère, Rev. Mycol. vi, p. 150 (1884).

Distrib.—Britain, Germany, France, Italy, Belgium, Norway, Sweden, Finland, Russia, Portugal (Henriquez); United States, South Carolina, Curtis, no. 451; Alabama, Peters, no. 5245; Mt. Eliza, Ceylon (Thwaites, no. 341).

45. *Cordyceps typhulæformis*, Berk. & Cooke, Grev. vol. xii, p. 78 (1883); Sacc., Syll. Suppl., vol. ix, no. 4003. (Plate II, Fig. 14.)

Gregarious, and springing from a dense felt of yellowish mycelium which partly covers the chrysalis on which the fungi are growing, and extends for some distance up the slender stems, which are about 1 cm. long; head cylindrical, obtuse, simple or rarely with 1–2 branchlets, about 1 cm. long and 2 mm. thick, flesh-colour; perithecia ovate, mouth narrowed, free, crowded; asci cylindrical, slightly capitate, base narrowed into a short, slender pedicel, 8-spored; spores hyaline, arranged in a parallel fascicle in the ascus, filiform, very slender, rather flexuous when free, multiseptate, 65–70 \times 8 μ , component cells about 3 μ long, not observed to become detached from each other.

On a chrysalis buried among dead leaves. Java (Kurz).

Type specimen in Herb. Kew., examined.

Remarkable for the gregarious habit, 8 plants springing from a web of mycelium, which spreads over the body of the host. The spores are very slender.

46. *Cordyceps aocularis*, Ravenel, Journ. Linn. Soc. vol. i, p. 159, pl. i (1857); Sacc., Syll. vol. ii, no. 5037; Ellis and Everh., N. Amer. Pyrenom. p. 64. (Plate II, Figs. 27, 28.)

Cordyceps Carolinensis, Berk. & Rav. in Rav. Fung. Carol., no. 29.

Exsicc.—Ravenel, Fung. Carol. no. 29.

Stem simple, elongated, slender, cylindrical, often flexuous or angularly crooked, brown, minutely velvety at the base, glabrous above, 5–8 cm. long, $1\frac{1}{2}$ mm. thick; head cylindrical, acute, 1– $1\frac{1}{2}$ cm. long, 3 mm. thick; perithecia blackish, large, ovate, apex truncate and indented, quite superficial and free from each other at the base; asci subcylindrical, elongated, apex capitate, pedicel short, 8-spored; spores arranged in a parallel fascicle in the ascus, hyaline, cylindrical-filiform, ends very slightly narrowed, straight or curved, multiseptate, $130 \times 2.5 \mu$, component cells about 3.5μ long.

On larvae buried in the ground in damp, shaded woods. S. Carolina (Ravenel, no. 1276). On *Nictobates?* sp. indet. (Host-Index, p. 181).

Type specimen in Herb. Kew., examined.

Ravenel's label accompanying the specimen has '*Sphaeria acicularis* n. sp.?' but the specific diagnosis was drawn up by Berkeley, who accepted Ravenel's MS. name.

The apex of the head is not sterile, but as in other species with superficial perithecia, these fall away readily when mature, and had done so from the apex of the head in the specimen described by Berkeley, but in several other specimens of the same species, the head is completely covered with perithecia. Structure of wall of perithecium truly parenchymatous; external cells irregularly polygonal, pale brown, 8– 12μ diameter.

47. *Cordyceps falcata*, Berk., Decad. Fung. no. 479, in Hook. Journ. Bot. vol. vi, p. 211, pl. viii, fig. 2 (1854); Sacc., Syll. ii, no. 5040. (Plate II, Fig. 15.)

Caespitose; stem $1\frac{1}{2}$ –2 cm. long, about 2 mm. thick, equal, even, glabrous; head elongated, narrowly elliptical; apex acute, slightly curved or falcate, about 2 cm. long, and 4 mm. thick at the widest part; perithecia perfectly superficial, ovate, mouth somewhat narrowed and elongated, crowded; asci cylindrical, apex slightly capitate, base narrowed into a short, slender pedicel, 8-spored; spores arranged in a parallel fascicle in the ascus, slightly curved when free, hyaline, filiform,

multiseptate, $80-90 \times 1 \mu$, component cells 4μ long, readily separating when mature.

On a dead caterpillar. Myrong, Khasia (Hooker and Thompson).

Type specimen in Herb. Kew., examined.

This differs from all known species in the caespitose falcate heads, which are naked at the base on the convex side (Berk., l. c.).

The head is falcate in all the specimens present in the Herbarium, and if constant, will, as stated by Berkeley, furnish a distinctive feature. The remark that the heads are naked at the base on the convex side, only means in reality that the mature perithecia have fallen away. No mention is made of the colour when fresh, and as the specimens were preserved in spirit, this cannot now be ascertained.

48. *Cordyceps Ravenelii*, Berk. & Curtis, Journ. Linn. Soc., vol. i, p. 159, tab. i (1857), (the figures on the plate are not numbered); Sacc., Syll. ii, no. 5035; Ellis and Everh., N. Amer. Pyrenom. p. 62; (Ellis, l. c., says that a good figure of this species is given in vol. i, p. 91 of Journ. N. Y. Microscop. Soc.).

Torrubia elongata, Riley, is according to Farlow and Seymour—Host-Index, p. 181—a synonym of the present species. On the other hand, Giard, l. c., p. 47, considers Riley's species to be identical with *C. Melolonthae*, Tul.

Exsicc.—Ravenel, Fung. Carol. Exs., Fasc. iv, no. 28.

Stem 3-10 cm. long, 1.5-3 mm. thick, almost straight or variously flexuous or crooked, simple or very rarely forked, minutely velvety at first, then almost or quite glabrous, especially upwards, subcylindrical, yellowish-brown, longitudinally wrinkled when dry; head cylindrical, narrowing into the stem at the base, apex more or less acute, 2-5 mm. broad at the widest part, rough with the large, blackish, broadly ovate, perfectly superficial perithecia; asci elongated, narrowly cylindrical, slightly contracted below the capitate apex, tapering below into a slender pedicel, 8-spored; spores

arranged in a parallel fascicle, slightly curved when free, hyaline, linear, multiseptate, $125-135 \times 2 \mu$, component cells $4-5 \mu$ long.

According to Ellis and Everhart, l. c., this fungus grows on larvae of the 'June beetle' (*Lachnosterna fusca*) and other larvae (?) buried in the ground. On *Anchylonyca*, sp. indet. (Host-Index, p. 181).

South Carolina (Ravenel, nos. 1372 and 3080); Texas (Wright, no. 3155); California (Harkness, no. 1220). There is also a specimen in the Herbarium from Gerard, but without locality, although certainly from the United States. The accompanying label is as follows: 'Called the "white grub fungus" in the Western States where found.'

Type in Herb. Kew., examined.

Extremely variable as regards size, some specimens being tall and robust, others extremely slender, and superficially indistinguishable from *C. acicularis*, Rav., the only point of difference furnished by the Kew material being that the spores in the last named are thicker and the component cells slightly shorter than in *C. Ravenelii*, and it is quite probable that even this character might disappear as such, when a sufficient number of species from different localities come to be examined and compared. The Californian specimens from Harkness—as intimated by Cooke in a note on the label—appears somewhat intermediate between the two species as here understood. Finally, it is only doing justice to the keen perception of Ravenel to state that he suspected more than an affinity between *C. acicularis* and *C. Ravenelii*, as proved by the remark on the label of no. 1372 [= *C. Ravenelii*], which reads thus: 'Sphaeria n. sp., spring and summer. On larvae buried in the earth 1-2 inches deep. Looks like a variety of 1276' [= *C. acicularis*].

49. *Cordyceps sphingum*, Sacc., Mich. i, p. 321 (1879); Sacc., Syll. ii, no. 5033; Cooke, Veget. Wasps and Plant-Worms, p. 127, figs. 27 and 28; Ellis and Everh., N. Amer. Pyrenom. p. 64, pl. xv.

Torrubia sphingum, Tul., Sel. Fung. Carp., p. 12, pl. i, figs. 1-2 (1865).

(Conidial stage.) *Isaria sphingum*, Schw., Syn. Fung. Carol., no. 1298 (1822); Cke., Veg. Wasps and Plant-Worms, p. 125, fig. 26.

Isaria sphingophila, Link, Sp. Pl., vol. ii, p. 114 (1824).

Exsicc.—Fung. Cub. Wrightiani, no. 746 (specimen in the Kew copy shows both conidial and ascigerous conditions).

Parasitic on various moths belonging to the Sphingidae. On some small Orthopterous insect, having the ascigerous fruit well developed; this specimen was collected by Dr. Trail in Brazil, along with other specimens on a Lepidopterous insect. Has been recorded as appearing on the pupa of a Dipterous insect from Scotland.

Distrib.—Britain (conidial form); Switzerland; United States; Cuba (Wright); St. Domingo; Brazil (Trail, no. 239 on Orthopterous insect, no. 17 on Lepidopterous insect); Darjeeling (on *Spirama retorta* and a species of *Hypena*).

Great confusion exists in herbaria respecting the determination and distribution of the Entomophilous *Isariae*; everything under the guise of an *Isaria* parasitic on a moth having been called *Isaria sphingum*. Unfortunately, this condition of things cannot be satisfactorily remedied from an examination of herbarium material.

50. *Cordyceps superficialis*, Sacc., Syll. no. 5036; Ellis and Everh., N. Amer. Pyrenom., p. 65.

Torrubia superficialis, Peck, 28th Rep. N. Y. State Mus. p. 70 (1875).

Under hemlock trees, on buried larvae, Northville, N. Y. (Peck); on *Hexapoda*, sp. indet. (Host-Index, p. 182).

Distrib.—United States.

51. *Cordyceps memorabilis*, Cesati, in Comm. della Soc. Crittog. Ital., vol. i. p. 16 (1861); Sacc., Syll. ii, no. 5032.

Racemella memorabilis, Cesati, Comm. della Soc. Crittog. Ital. vol. i, p. 65, pl. iv, fig. 1.

Growing on a beetle—*Staphylinus* sp.

Distrib.—Oropa, N. Italy.

†† *Spores continuous.*

52. *Cordyceps isarioides*, Curtis, MS. (Plate II, Figs. 36–39.)

Gregarious, springing from a dense white mycelium which almost entirely covers the host; stem 4–8 mm. high, about 1.5 mm. thick, cylindrical, almost glabrous, even, ochraceous (when dry), sometimes slightly curved; head 3–6 mm. long, cylindrical, obtuse, axial portion not thicker than the stem; perithecia perfectly superficial, large, flask-shaped, mouth elongated, ochraceous, crowded, spreading on all sides at right angles to the axis; asci narrowly cylindrical, slightly capitate, base narrowed into a slender pedicel, 8-spored; spores cylindric-filiform, continuous, flexuous when free, hyaline, $125-135 \times 1.5 \mu$, arranged in a parallel fascicle in the ascus.

Growing from the remains of a moth. Owing to an unfortunate mistake this species is represented growing on a chrysalis. Curtis, no. 6521. No locality given, but undoubtedly from the United States.

The type specimen is in Herb. Kew.

The specimens, along with numerous other packets that had never been examined by Berkeley, were sent to Kew after his death. The present differs from other known species of *Cordyceps* with free perithecia in the spores being continuous, and as they escaped from the ascus readily when placed in water, it may be assumed that they were mature, and not likely to become multiseptate. In the filiform continuous spores, the species agrees with the genus *Claviceps*, but differs in developing on an insect, and forming a sclerotium in its anterior.

Species imperfectly described.

53. *Cordyceps Sinclairi*, Berk., Flora Nov. Zel., p. 338 (1855); Berk., Intr. Crypt. Bot., p. 73, fig. 17; Sacc., Syll. ii, no. 5054.

Torrubia caespitosa, Tulasne, Carpol. iii, p. 11 (1865).

Cordyceps caespitosa, Sacc., Syll., no. 5043.

Yellowish, from $\frac{3}{4}$ –1 in. high; stems cylindrical, slender, simple or forked, sometimes confluent, $\frac{1}{3}$ inch or more high, divided above into numerous more or less cylindrical, either simply or slightly lobed heads, which are sometimes disposed into a flabelliform mass, clothed with innumerable oblong conidia $\frac{1}{8}$ – $\frac{1}{10}$ of an inch long.

The specimens are unfortunately destitute of perithecia. The pale yellowish tint, inclining to lemon colour, seems characteristic, and forbids, in the first instance, their union with *Cordyceps sobolifera*, a West Indian species, which also occurs on Orthopterous larvae. In that species, however, the normal form seems to be simply clavate, as in *Cordyceps entomorrhiza*, and the divisions are merely proliferous. There does not seem, in the present case, to be any indication of such a primitive form, and, in consequence, I suppose the head to be essentially divided, as in *Cordyceps Taylori*. I have therefore no hesitation in considering it distinct, more especially as the West Indian species is a purely tropical form, and does not ascend as far as the Southern United States, which produce some New Zealand species, but is represented by an allied form still normally simple on the larvae of cockchafers.

Northern Island [New Zealand]; on the larvae of some Orthopterous insect, amongst loose gravelly soil, in the garden of Archdeacon Williams, Tauranga, Poverty Bay.

The above is Berkeley's original account of the species, which unfortunately I am unable to supplement, the species not being present in the Herbarium in a mature condition. Tulasne's species, *Torrubia caespitosa*, was received from the same locality as the above species, with which it is obviously synonymous.

54. *Cordyceps Melolonthae*, Sacc., Mich. i, p. 320 (1879); Sacc., Syll. ii, no. 5044; Ellis and Everh., N. Amer. Pyrenom. p. 66.

Torrubia melolonthae, Tulasne, Sel. Fung. Carpol. iii, p. 12 (1865); *Torrubia elongata*, Riley. According to Giard, l. c. p. 47, this is a synonym of the present species.

On buried larvae of the 'May bug' *Lachnosterna fusca*; on larvae of *Ancyloncha puncticollis* (fide Gray).

Distrib.—Pennsylvania, United States.

A figure is given in Silliman's Journ. vol. viii, pl. iv (1824), giving the general appearance of this species springing from the cervical region of the buried larva of the May bug.

55. *Cordyceps coccigena*, Sacc., Mich. i, p. 320 (1879); Sacc., Syll. ii, no. 5047.

Torrubia coccigena, Tul., Sel. Fung. Carpol. iii, p. 19, t. 1, fig. 10 (1865).

Growing on some Coccus.

Distrib.—Dory, New Guinea (Dumont d'Urville).

56. *Cordyceps gigantea* (Mont.).

Isaria gigantea, Montag., Syll. no. 1079 (1856); Mont., Cub. p. 309.

Cordyceps Montagnei, Berk. & Curt., Fungi Cuben. no. 747, in Linn. Soc. Journ., Bot., vol. x, p. 375 (1869).

On the body and feet of *Mygale cubana*, Walker.

Distrib.—Cuba (Ramon de la Sagra).

The conidial form is alone known at present. Montagne's original specific name has been restored.

57. *Cordyceps cicadae* (Miq.).

Isaria cicadae, Miquel, Bull. Sci. Phys. et Nat. Néerl. vol. i, p. 85, tab. i, fig. A (1838).

Torrubia Miquelii, Tul., Carpol. iii, p. 11 (1865).

Cordyceps Miquelii, Sacc., Mich. i, p. 320 (1879); Sacc., Syll. ii, no. 5046.

On larva of Cicada. Saccardo says also on some lamelli-corn insect in the United States.

Distrib.—Brazil.

Miquel's original specific name has been restored.

58. *Cordyceps Mawleyi*, J. O. Westwood, Gard. Chron. May 2, 1891, p. 553, fig. 115, p. 563 :—

'We describe and figure an interesting example, being the underground caterpillar of a British *Noctua*, or possibly *Hepialus*, of which we received specimens from E. Mawley, Esq., of Rosebank, Berkhamstead, Herts. Several similar specimens were found underground in a border of herbaceous perennials, near a good sized lime-tree; they were all found dead, each with a profusion of filaments from the segments behind the head, which appear to have been injured or crushed. They were generally found about 1 inch below the surface, and the fungoid filaments sometimes emerge from each end of the caterpillar, one being seen in the figure near the extremity of the body. The species may be named after its discoverer *Cordyceps Mawleyi*. J. O. Westwood.'

It can scarcely be hoped to recognize in future the object the author had in view. The figure shows a caterpillar with a mass of Isaria-like filaments and a single, slender, flexuous club about 2.5 cm. long.

59. *Cordyceps albella* (Berk. & Curt.).

Numerous slender stems spring from the under surface of the thorax and abdomen of the host, whitish or tinged yellow, $\frac{1}{2}$ –1 cm. long, 1–2 mm. thick, cylindrical or with an indication of becoming clavate, all immature. The body and legs of the insect are almost covered with a whitish mould.

Cordyceps albidus, Berk. & Curtis, in Herb. The specific name is antedated by Patouillard.

On the perfect form of a member of the Gryllidae.

Cuba (Wright, no. 890).

Apparently the same species—sterile—growing on some Orthopterous insect, was sent from Ceylon by Thwaites.

60. *Cordyceps fuliginosa*, Cesati, Giorn. Inst. Lomb. Milan, 1848, p. 31; Comm. Crittog. Ital. vol. i, p. 67, t. 6, fig. 1 (1861); Sacc., Syll. ii, no. 5042; Cke., Veget. Wasps and Plant Worms, p. 183, pl. i, fig. 5 (after Cesati).

On *Bombyx (Orgyia) antiqua*.

Distrib.—Italy.

61. *Cordyceps* ? *adpropinquans*, Sacc., Syll. ii, no. 5056.

Torrubia adpropinquans, Cesati, Myc. Born., in Mem. Acad. Neapol. (1879).

Host unknown.

Distrib. Sarawak, Borneo.

62. *Cordyceps Humberti*, Robin, in Tul., Carpol. iii, p. 18 ; Sacc., Syll. no. 5045.

On a wasp—*Icaria cincta*.

Distrib.—Senegal.

Excluded Species.

Cordyceps setulosa, Quél., Champ. Jura et Vosges, p. 487, t. 4, fig. 4.

A true species of *Claviceps*. Described as having a sclerotium and springing from the fruit of a species of *Poa*.

Cordyceps racemosa, Berk., Dec. Fung. no. 480, in Hook., Journ. Bot., p. 211, pl. viii, fig. 3 (1854) ; Sacc., Syll. ii, no. 5049.

This proves, on examination, to be a species of *Balanophora*, and is described by Hemsley as *Balanophora Hookeriana*.

Berkeley evidently suspected something of the kind, as he says, 'Except for its place of growth it might easily be passed over as an imperfect *Balanophora*.' Its being in contact with a caterpillar is probably quite accidental.

INDEX OF SPECIES.

(Synonyms are printed in italics.)

- Balanophora** *Hookeriana*, 40.
- Clavaria**, 30.
 — *militaris*, 30.
 — *sobolifera*, 13.
- Claviceps**, 6, 9, 36, 40.
- Corallomyces**, 7, 9.
- Cordyceps**, 1, *passim*, 9.
 — *acicularis*, 31, 34.
 — *adpropinquans*, 40.
 — *albella*, 39.
 — *albida*, 27.
 — *albidus*, 39.
 — *alutacea*, 13.
 — *armeniaca*, 8, 23.
 — *australis*, 15.
 — *Barberi*, 18.
 — *Barnesii*, 10, 11.
 — *bicephala*, 21.
 — *Bovellii*, 18.
 — *caespitosa*, 37.
 — *caloceroides*, 23.
 — *Carolinensis*, 31.
 — *cicadae*, 38.
 — *cinerea*, 15.
 — *coccigena*, 38.
 — *clavulata*, 8, 22.
 — *curculionum*, 14.
 — *dipterigena*, 20.
 — *Ditmari*, 16.
 — *Doassansii*, 27.
 — *entomorrhiza*, 6, 8, 25, 37.
 — *falcata*, 32.
 — *flavella*, 19.
 — *Forquingnoni*, 17.
 — *fuliginosa*, 39.
 — *gentilis*, 17.
 — *gigantea*, 38.
 — *goniophora*, 15.
 — *gracilis*, 25.
 — *Gunnii*, 18.
 — *Hawkesii*, 17.
 — *Helopis*, 16.
 — *Henleyae*, 28.
 — *herculea*, 26.
 — *Humberti*, 40.
 — *Hugelii*, 30.
 — *var. neglecta*, 30.
 — *insignis*, 12.
 — *isarioides*, 36.
 — *Langloisii*, 26.
 — *larvicola*, 16.
 — *Lloydii*, 20.
 — *martialis*, 15.
- Cordyceps**, *Mawleyii*, 38.
 — *melolonthae*, 33, 37.
 — *memorabilis*, 35.
 — *menesteridis*, 25, 26.
 — *militaris*, 2, 4, 8, 30.
 — *Miquelii*, 38.
 — *Montagnei*, 38.
 — *myrmecophila*, 8, 14.
 — *nutans*, 26.
 — *Odyneri*, 26.
 — *palustris*, 11.
 — *pistillariaeformis*, 22.
 — *Puiggarii*, 13.
 — *racemosa*, 40.
 — *Ravenelii*, 33, 34.
 — *Robertsii*, 30.
 — *setulosa*, 40.
 — *Sherringii*, 27.
 — *Sinclairi*, 36.
 — *sinensis*, 24.
 — *sobolifera*, 11, 13, 37.
 — *sphaecocephala*, 13.
 — *sphaecophila*, 13.
 — *sphingum*, 8, 34.
 — *stylophora*, 16.
 — *superficialis*, 35.
 — *Taylori*, 27, 37.
 — *typhulaeformis*, 31.
 — *unilateralis*, 15.
 — *velutipes*, 21.
 — *Wallaysii*, 15.
- Cordylia**, 7, 9, 10.
- Epichloë**, 6.
- Hypocrea**, 6, 13.
- Isaria**, 4, 5, 7.
 — *Barberi*, 18.
 — *cicadae*, 38.
 — *densa*, 5, 6.
 — *farinosa*, 4, 5, 6, 30.
 — *fuciformis*, 6.
 — *gigantea*, 38.
 — *sphaecophila*, 16.
 — *sphingophila*, 35.
 — *sphingum*, 35.
- Racemella**, *memorabilis*, 35.
- Ramaria**, *farinosa*, 30.
- Sphaeria**, 4.
 — *clavulata*, 22.
 — *entomorrhiza*, 25.

Sphaeria, herculea, 26.
 — *Hugelii*, 30.
 — *innominata*, 27.
 — *Robertsii*, 30.
 — *sinensis*, 24.
 — *sobolifera*, 13.
 — *sphaecocephala*, 14.
 — *Taylori*, 27.

Torrubia, 10.
 — *adpropinquans*, 40.
 — *caespitosa*, 37.
 — *cinerea*, 15, 22.
 — *clavulata*, 22.
 — *coccigena*, 38.
 — *curculionum*, 14.

Torrubia, elongata, 33, 38.
 — *entomorrhiza*, 25.
 — *gentilis*, 17.
 — *melolonthae*, 37.
 — *Miquelii*, 38.
 — *militaris*, 4, 30.
 — *pistillariaeformis*, 22.
 — *sobolifera*, 13, 37.
 — *sphaecocephala*, 14.
 — *sphingum*, 35.
 — *superficialis*, 35.
 — *unilateralis*, 15.

Xylaria, 10, 21.
 — *gracilis*, 25.
Xylodaotyla, 21.

INDEX OF HOSTS.

Anchylonyca, 34.
Anchylonyca puncticollis, 38.
 Ant, 15, 20, 27.
Atta cephalotus, 15.
Bombyx antiqua, 39.
Camptonotus atriceps, 20.
 Carabus, 15.
 Cerambycidae, 15.
 Cicada, 38.
 Coccus, 38.
 Cockchafer, 5, 37.
 Coleoptera, 7, 12, 14, 23.
 Cossus, 19.
Dasyphora pratorum, 17.
Diatraea saccharalis, 18.
 Diptera, 7, 20, 35.
 Elateridae, 22.
 Flies, 16.
Formica rufa, 14.
Gastrophaca, 31.
 Gortyna, 24.
 Gryllidae, 39.
Heilipus celsus, 14.
Helops caraboides, 16.
 Hemiptera, 7, 26.
Hepialus, 19, 29, 30, 39.
 — *virescens*, 30.
 Hexapoda, 12, 17, 26, 35.
 Hymenoptera, 7, 14.
Hypena, 35.
Icaria cincta, 40.

Lachnosterna quercina, 30.
 — *fusca*, 34, 38.
 Lecanium, 22.
 Lepidoptera, 7, 27, 30, 35.
 Lithoosidae, 26.
 Mason-wasp, 26.
Melolontha vulgaris, 26, 31.
 Melolonthidae, 11, 13.
Menesteris laticollis, 26.
 Moth-borer, 18.
Musca rufa, 17.
 Mutilla, 16.
Mygale cubana, 38.
Nictobates, 32.
 Noctua, 39.
 Noctuidae, 24.
 Notodontidae, 30.
 Odynera, 27.
 Orthoptera, 35.
Pachycondyla striata, 15.
Phalera bucephala, 30.
 Pielus, 17.
 Polybia, 14.
 Silphidae, 25.
 Sphingidae, 35.
Spirama retorta, 35.
 Staphylinus, 36.
 Tinea, 26.
 Vespa, 14.
 Wasp, 14, 16, 17, 40.

EXPLANATION OF FIGURES IN PLATES
I AND II.

Illustrating Mr. Masee's paper on *Cordyceps*.

PLATE I.

- Fig. 1. *Cordyceps Henleyae*, Mass., growing from the head of a caterpillar. Nat. size.
Fig. 2. Section of portion of a fertile branch, showing the superficial perithecia. $\times 20$.
Fig. 3. Asci in different stages of development. $\times 750$.
Fig. 4. Apex of an ascus, showing the arrangement for effecting dehiscence. $\times 1200$.
Fig. 5. Spore as appearing when placed in water. $\times 750$.
Fig. 6. Spore as appearing when treated with very dilute potassic hydrate. $\times 750$.
Fig. 7. Portion of Fig. 5, more highly \times .
Fig. 8. Portion of Fig. 6, more highly \times .
Fig. 9. Portion of a mature spore breaking up into its component cells. $\times 750$.
Fig. 10. One of the component cells of a spore germinating. $\times 1200$.
Fig. 11. Transverse section through a segment of the caterpillar serving as host to the fungus, showing the interior to be completely filled with densely interwoven hyphae, and forming a hard, compact mass when dry. $\times 2$.
Fig. 12. Portion of the hyphae filling the body of the host-caterpillar. $\times 750$.

PLATE II.

- Fig. 1. *Cordyceps palustris*, Berk. Nat. size.
Fig. 2. Section of portion of head of same, showing the perithecia. $\times 50$.
Fig. 3. Ascus of the same. $\times 350$.
Fig. 4. Spore of same. $\times 350$.
Fig. 5. Portion of spore in young stage, with oil-globules. $\times 750$.
Fig. 6. Portion of mature spore, showing transverse septa. $\times 750$.
Fig. 7. *Cordyceps flavella*, Berk. and Curtis; group of Fungi growing from portion of a caterpillar. Nat. size.
Fig. 8. Section of portion of head of same, showing the perithecia. $\times 50$.
Fig. 9. Ascus. $\times 350$.
Fig. 10. Spore. $\times 350$.
Fig. 11. *Cordyceps caloceroides*, Berk. and Curtis. Nat. size.
Fig. 12. Section of a superficial perithecium and portion of stroma of same, showing the true parenchymatous structure of the tissue. $\times 150$.
Fig. 13. Spore of same. $\times 350$.

- Fig. 14. *Cordyceps typhulaeformis*, Berk. and Cooke. Nat. size.
 Fig. 15. *Cordyceps falcata*, Berk. Nat. size.
 Fig. 16. *Cordyceps bicephala*, Berk. Nat. size.
 Fig. 17. *Cordyceps sinensis*, Berk. Nat. size.
 Fig. 18. *Cordyceps armeniaca*, Berk. Nat. size.
 Fig. 19. *Cordyceps Barnesii*, Thwaites. Nat. size.
 Fig. 20. Section of a superficial perithecium and portion of stroma of same, showing the whole to be composed of densely interwoven hyphae. $\times 150$.
 Fig. 21. Spore. $\times 350$.
 Fig. 22. Spore broken up spontaneously into its four component cells. $\times 350$.
 Fig. 23. Conidia bearing condition of *Cordyceps Barnesii*. Nat. size.
 Fig. 24. Branched conidiophores of same. $\times 80$.
 Fig. 25. Single head of conidia. $\times 350$.
 Fig. 26. Fertile hyphae forming the head, each bearing a chain of conidia at its apex. $\times 750$.
 Fig. 27. *Cordyceps acicularis*, Ravenel. Nat. size.
 Fig. 28. Spore of same. $\times 350$.
 Fig. 29. *Cordyceps dipterigena*, Berk. and Broome. Nat. size.
 Fig. 30. Section of portion of head of same, showing the completely immersed perithecia. $\times 50$.
 Fig. 31. Portion of ascus of same, showing the spores broken up into their component cells. $\times 600$.
 Fig. 32. Component cells of spore of same. $\times 600$.
 Fig. 33. *Cordyceps Hugelii*, var. *neglecta*, Mass. Nat. size.
 Fig. 34. *Cordyceps Barberi*, Giard, growing on the larva of *Diatraea saccharalis*, Fabr., lying in its burrow in a piece of sugar-cane. Nat. size.
 Fig. 35. Ascus of same. $\times 350$.
 Fig. 36. *Cordyceps isarioides*, Curtis. Nat. size.
 Fig. 37. Head of same. $\times 25$.
 Fig. 38. Portion of ascus of same, showing the spores in the act of becoming free. $\times 400$.
 Fig. 39. Free spore of same. $\times 400$.
 Fig. 40. *Cordyceps stylophora*, B. and Br. Nat. size.
 Fig. 41. Head of same. $\times 5$.
 Fig. 42. Spore of same. $\times 350$.

On a New Saprophytic Monocotyledon.

BY

PERCY GROOM, M.A., F.L.S.



With Plate III.



IN 1871 Beccari¹ described a Bornean plant under the name of *Petrosavia stellaris*; he referred the plant to the Melanthaceae, and mentioned that it was parasitic on roots. Later Mr. H. N. Ridley² discovered on the Malay Peninsula a very similar plant, which, without a minute examination of the flowers, seemed to be identical with *Petrosavia*. From his material I gave an account of the seed and embryo³. Recently Mr. Ridley was good enough to send me some more material of this plant with flowers. On investigating the flowers by means of microtome-sections, I found that the floral structure was very different from that assigned to *Petrosavia*. As none of Beccari's plants were available for examination, it seemed improper to assume that his description was imperfect: so a new name has been given to the plant—*Protolirion paradoxum*. Still Beccari's figures of *Petrosavia* agree closely with Mr. Ridley's plant; and if

¹ O. Beccari, *Petrosavia*, Nuovo Genere di Piante Parassite della Famiglia delle Melanthaceae. Nuov. Giorn. Bot. Ital. T. 3, 1871.

² H. N. Ridley, reprint from Proceed. Asiat. Soc. Singapore, Vol. xxiv, p. 170.

³ Percy Groom, Botanical Notes, No. 3, p. 380; Annals of Botany, Vol. vi, 1892.

[Annals of Botany, Vol. IX. No. XXXIII. March, 1895.]

Beccari's description be incorrect, the plant is doubtless merely another species of *Petrosavia*, the characters of which would require emendation. Hence any observations on the morphology and nature of *Petrosavia* are of interest.

Beccari described the plant as parasitic on roots. Now there are many saprophytes, devoid of chlorophyll, amongst Monocotyledons, represented by all the Triuridaceae, nearly all the Burmanniaceae, and many Orchidaceae¹. Dismissing the Corsieae, which are doubtless saprophytes, the remarkable fact becomes apparent that there is but one stated monocotyledonous parasite—*Petrosavia*. However, when it is borne in mind that for a long time botanists had failed to recognize the existence of many holosaprophytes, having assumed that those known were parasites, it would not be surprising to find that the same mistake had been made with regard to *Petrosavia*, especially as Beccari assumed that saprophytic Burmanniaceae and Triuridaceae were parasitic. So I asked Mr. Ridley if he would specially note whether or not the roots of his plant were connected with the roots of any other plants. In response Mr. Ridley pointed out the extreme difficulty in proving a negative when dealing with such fine roots, but he stated that he failed to detect any parasitic connexion. It may be stated at once that the histological evidence afforded by *Protolirion* goes to show that its ally *Petrosavia* is a saprophyte.

Beccari gave a brief description of the histology of the stem of *Petrosavia*. He says, 'Una sezione trasversale del caule presenta esternamente una parte corticale formata da 4-5 strati di cellule assai grandi, poi viene un intiero e largo anello di fibre liberiane che in circa 9 punti, discosti fra di loro, si cambiano in fasci fibrovascolari; il centro è ripieno da tessuto midollare molto lasso.'

¹ Mr. J. G. Baker has kindly directed my attention to a probably saprophytic Iridaceous plant from Madagascar—*Genosiris aphylla*, Baillon. Bull. Linn. Soc. Paris, No. 145.

EXTERNAL MORPHOLOGY.

The plant has a slender subterranean rhizome, closely beset with very small sheathing leaves (Fig. 1). From this rises up the simple scape which bears a corymbose raceme of flowers at its apex. Attached to the rhizome are the lengthened stumps of one or two older scapes; probably, then, *Protolirion* is a perennial. The successive scapes appear to arise in the axils of the lowest scales on the preceding scapes.

As the plant is entirely devoid of chlorophyll, all the leaves are reduced to small scales. On the rhizome and bases of the scapes they are sheathing and completely conceal the axis. Ascending the scape, the scales gradually become separated by longer internodes, lose their sheathing bases, and assume a longer and more slender form (Figs. 1, 2).

Long, delicate roots, very feebly branched, spring from the rhizome, and particularly from the base of the scape. (In Fig. 1 all the roots except the lowest two arise from the flowering axis.)

HISTOLOGY.

I. *The Root.*

I had very few intact roots at my disposal, in fact only some of those shown in Fig. 1. For the most part the terminal portions had been broken off. In the single apex investigated there were remains of a *root-cap*. Although the pieces of uninjured roots were of considerable length, there were *no traces of haustoria*.

(1) The root is clothed externally by a single layer of cells with thin walls which represents the piliferous layer. There are *no root-hairs*. This layer soon becomes disintegrated and replaced functionally by—

(2) The *exodermis*, which takes the form of a single layer of cells with thin suberized walls. No passage-cells were to be seen. This layer is succeeded by—

(3) Four to five layers of cortical parenchyma the cells of which have walls of cellulose. Most of these cells contained *coiled mycorrhizal hyphae*, even so far as the endodermis.

The central cylinder is very small.

(4) The *endodermis* forms a characteristic layer of cells of the C-type with greatly thickened, stratified, and suberized inner walls (Fig. 5). The cells are elongated in the direction of the long axis of the root. There are no passage-cells; and it is obvious that liquids cannot pass easily into the central cylinder from the parenchymatous cortex.

(5) The *pericycle* forms a single well-defined layer of longitudinally elongated cells with lignified walls of average thickness. In longitudinal sections the nuclei are seen not to be elongated longitudinally, but more or less square.

With the meagre supply of material, it was difficult to establish any clear facts as to the arrangement and differentiation of the narrow constituents lying within the pericycle.

(6) *Phloëm* (?). In transverse sections, at about four points, there were minute groups, each including three to four very narrow cells with thin walls of cellulose (Fig. 5, *ph*). They were all elongated longitudinally; and some, at least, possessed very long strap-like nuclei. I did not succeed in detecting sieve-tubes.

Excepting these phloëm-cells (?) all the remaining tissue within the pericycle is lignified.

(7) *Xylem*. There are clearly marked conducting constituents represented by narrow tracheides with oval or slit-like bordered pits, or loose reticulate thickenings. Fig. 5 shows that midway between the supposed groups of phloëm, the cells abutting on the pericycle are smaller and more isodiametral than the cells contiguous to the phloëm (?); they probably represent the small outer extremities of the rudimentary radial groups of xylem: for in longitudinal sections tracheides are seen in direct contact with the pericycle, as are also cells with oval nuclei.

(8) The larger central cells, with lignified, simply pitted walls, have nuclei and are elongated longitudinally and represent the conjunctive tissue.

II. *The Stem—A. The Rhizome.*

(1) The *epidermis* consists of elongated cells with fairly thin walls and a distinct cuticle. *No stomata occur.*

(2) It is succeeded by about four layers of *cortical parenchyma*, the cells of which have thin pitted cellulose-walls. Within lies—

(3) A *general sclerenchyma-sheath* about four cells in thickness. The cells composing it are sclerenchymatous fibres. The outermost layer is tolerably regular and simulates the endodermis of the root. The remaining three layers of cells have evenly thickened pitted walls, and possess only small lumina.

(4) The *vascular bundles* are arranged close within the general sheath and are numerous.

Each full-sized vascular bundle is still small but possesses well-marked phloëm- and xylem-portions (Fig. 6).

The *phloëm* is constituted of narrow sieve-tubes with transverse plates, and elongated parenchyma-cells in which no differentiation of companion-cells was visible.

The *xylem* has long tracheides with transverse pits, fibres, and a protoxylem of a few narrow loose spiral vessels about which lie elongated narrow parenchyma having thin walls, with wide shallow pits. The intercellular spaces around the spiral vessels are very small.

(5) The *pith* consists of broad parenchymatous cells with thin pitted lignified walls. The cells are elongated in the direction of the axis. The conjunctive tissue connecting the pith with the general sheath is constituted of cells which gradually change from the typical pith-cells to sclerenchyma-fibres as they approach the sheath.

B. *The Scape.*

The structure of other parts of the stem is in all essentials identical with that of the rhizome. Ascending the axis, the cells decrease in size and number. The outermost layer of the general sheath loses its likeness to the endodermis, and as the leaves decrease in number the vascular bundles naturally become fewer.

Close under the flowers the axis is triangular in cross-section. The cortical layers are reduced to two or three in number. The general sheath is triangular also in the section, and two to three layers in thickness. Within the three angles of the sheath are three pairs of larger bundles, the bundles lying within the sides of the triangle being smaller.

III. *The Leaf* (Fig. 7).

The leaves are more or less closely pressed against the axis.

Each consists of a lower (outer) and an upper (inner) epidermis, with a certain amount of undifferentiated mesophyll in which runs the single vascular strand which enters the leaf.

The *epidermis* consists of typical cells, and towards the margins its two layers compose the whole thickness of the leaf. *Stomata* occur only in the lower (outer) epidermis, and solely in that portion which covers the midrib.

The *mesophyll* forms a sheath round the vascular strand in the midrib, and suddenly thins off towards each side. So that the greater part of the leaf consists simply of two layers of epidermis with here and there a single or double layer of mesophyll-cells. The walls of all the mesophyll-cells are thin but lignified, excepting in the immediate neighbourhood of the midrib, where the walls consist of cellulose.

The cells in the outer (lower) half of the leaf in this region contain excreta, especially in the form of raphides enclosed in mucilage. The adjacent parts of the axis may be quite devoid of raphides. This recalls the same distribution in

some holosaprophytic Orchids¹, and further suggests that the scales function as excretory organs. The occurrence of stomata also in the same Orchids seems to imply that the leaves function as organs by which any excess of water is excreted.

The *vascular strand* has an incomplete and rudimentary sclerenchymatous sheath which is more strongly developed on the lower (outer) side. It is composed of *phloëm* with sieve-tubes and much parenchyma, and *xylem* with a few narrow spiral tracheides, and a considerable quantity of elongated parenchyma with thin cellulose-walls.

IV. *The Inflorescence and Flowers.*

The flowers are arranged in a corymbose raceme (Fig. 3). In my specimens there were never more than four flowers on one scape. The flowers are actinomorphic, hermaphrodite, and regularly trimerous (Fig. 4).

The *perianth* is composed of two whorls of three segments each. The free portions of the outer three are narrow, and are open in aestivation. The free portions of the inner whorl are much broader and larger, and are valvate in aestivation. The lower portion of the perianth is adnate to the wall of the ovary. In the case of both whorls of the perianth, just below their entirely free portions their margins are distinct and separate from one another, but their inner (upper) faces are fused with the wall of the ovary (Figs. *f, h*). This interesting case is sufficient to prove that, in this instance at any rate, *the wall of the inferior portion of the ovary is partially formed by the perianth*, and that it is not composed simply of the original carpellary tissue together with an adherent excavated receptacle.

The three smaller segments become entirely free at a lower level than do the three broader, and are attached lower down. They therefore represent the outer whorl.

¹ Percy Groom, Contributions to the Knowledge of Monocotyledonous Saprophytes. Read before the Linnæan Society, Dec. 20, 1894.

Androecium. There are two trimerous whorls of stamens, the anthers of which are basifixed, sub-introrse (in the bud condition), and have four pollen-sacs each. Those which represent the *outer whorl* are opposite to the three outer segments of the perianth, and are *inserted on the wall of the ovary*, at a lower level than the *three inner stamens*, which are *inserted on the bases of the inner segments of the perianth* (Figs. *b, c, h, k*).

Gynaecium. The pistil is remarkable in at once showing a transition from an apocarpous to a syncarpous type, and from a free to an adnate ovary. The lower portion of the ovary is inferior, trilocular, with two double rows of horizontal anatropous ovules attached to the axile placentae (Figs. *a-k*).

Above, the ovary separates into three distinct ovuliferous follicle-like portions which gradually pass into three short styles capped by papillose capitate stigmas (Figs. *a, b, c, l*).

Nectaries (Figs. *b, c, e-h*). There are three septal nectaries which open opposite the segments of the inner whorl of the perianth, slightly above the highest point at which the latter are coherent to the wall of the ovary. They are three simple unbranched sacs, extended radially, and reaching down not quite so far as the chambers of the ovary. They are lined by a single layer of palisade-like secreting cells, which have densely staining contents and conspicuous nuclei. The cuticle of these cells is raised even in the bud-condition of the flower. No mechanical cells strengthen the nectariferous tissue.

Fruit. The free portions of the gynaecium dehisce like three follicles, and allow the escape of the seeds from the lower part of the ovary also.

Seeds. These were described under the name of *Petro-savia*¹: they are ribbed, albuminous, and with a very minute undifferentiated embryo.

¹ Percy Groom, loc. cit.

GENERAL REMARKS ON PROTOLIRION.

A. *Vegetative Structure.*

The structure of the roots tends to show that *Protolirion* is not a parasite. No connexion between them and other plants could ever be seen, nor any trace of the existence of haustoria. On the other hand, the root structurally agrees with that of a saprophyte (cp. Burmanniaceae; *Triuris* and some species of *Sciaphila*; Gentianaceae) in the following points: (1) absence of root-hairs, (2) presence of a well-developed cortex, containing endotrophic mycorrhiza, (3) small size of the central cylinder, and the minuteness of the vessels. The whole central cylinder of these relatively long roots is less in size than is one single fair-sized vascular bundle of the rhizome, which suggests, not conduction of nutritive solutions along the cylinder, but a general absorption taking place over the whole surface of the root.

B. *Flowers.*

Beccari gives the following generic characters as characteristic of *Petrosavia*, and I have italicised those which do not agree with *Protolirion*: 'Perigonium trigonum 6-partitum, persistens coloratum, *inferum*, phyllis inaequalibus, 3 exter. minoribus angustioribus basi omnibus connatis. Stamina 6, phyllis opposita et *eorum basi inserta*: filamenta subulata; antherae biloculares apici acutiusculae basi bilobae, basifissae, introrsae. *Ovaria tria*, perigoni phyllis angustioribus opposita, *ex ima basi libera* sessilia follicularia erecta; *stigmata sessilia vix incrassata*, papillosa; ovula horizontalia, anatropa, placentis 2, latis, marginalibus et ventralibus bi-triseriatim adfixa. Fructus trifollicularis, folliculis siccis, horizontalibus, sutura ventrali hiantibus . . . Praefloratio valvaris.' The rest of the description agrees, as far as it goes, with the parts represented in *Protolirion*.

The peculiar transitional state of the gynaecium (apocarpous, adnate-free) is of interest. From this it is impossible to form any idea as to the affinity of the plant. Beccari placed *Petrosavia* amongst the Liliaceae which typically have separate styles and often follicular fruits (old order Melanthaceae). *Protolirion* is still more like such forms as the Veratreae and Tofieldieae, in that the pistil is not completely apocarpous. In the Veratreae there are forms with half-adnate ovaries (*Stenanthium* and *Anticlea*).

The structure of the wall of the adnate portion of the ovary shows that the adnation is in this case caused by actual fusion of the floral whorls with the wall of the originally free ovary. The free basal margins of the adnate portions of the perianth further suggest that the plant is derived from forms with superior ovaries rather than a degenerate type of some family of plants with inferior ovaries.

Protolirion agrees in habit and structure of its seeds with Triuridaceae and Burmanniaceae; and it is interesting to note that it stands midway between them in the character of its gynaecium. This coincidence is the more striking when it is remembered that some systematists (Eichler and others) view the Burmanniaceae as forms lying between the Liliaceae-Amaryllidaceae and the gynandrous family Orchidaceae. In *Protolirion* there is a commencement of the gynandrous condition, for the three outer stamens are attached to the wall of the ovary.

The occurrence of septal glands collaterally throws light on the affinities of *Protolirion*. Such nectaries are known only in the Monocotyledons, and solely in Liliaceae, Haemadoraceae, Iridaceae, Amaryllidaceae, Bromeliaceae, and Scitamineae¹. As we cannot judge the affinities of *Protolirion* by its embryo, and the absence of a cambium might be merely a degenerative change, there would be nothing to prove that *Protolirion* was not a trimerous Dicotyledon. But the presence of septal glands, with monocotyledonous floral characters,

¹ Grassmann, *Flora*, 1884, pp. 113-134.

makes it certain that the plant is a Monocotyledon. Septal glands are not present in the flowers of all the genera in the families mentioned ; as far as observation has gone they are notably absent from those Liliaceae which have three styles or a branched style (Melanthaceae). So the apocarpous condition of the upper portion of the pistil of *Protolirion* may be a partial reversion from syncarpy to apocarpy, associated with the peculiar habit of the plant (cp. modified flowers of parasites amongst Dicotyledons).

Affinities of Protolirion. It is difficult to decide where to place this simple form. On the one hand its incipient gynandry may be but an unimportant and casual factor, which will be found to recur in some other forms which have a half-inferior ovary. Yet it may be of deeper significance in suggesting that the Orchidaceae are more closely allied to plants with a superior ovary than to forms with an inferior ovary—in particular that they were derived rather from the Liliaceae than from the Amaryllidaceae. In habit, structure of the seed (no doubt partially the effect of its saprophytism), and in the partially apocarpous condition of its pistil, *Protolirion* vividly recalls the Triuridaceae. The latter have diclinous flowers, and indefinite one-ovulate separate carpels : but though diclinous, rudiments of the gynaeceum and the stamens are frequently present in the male and female flowers respectively. And dicliny appears in the Liliaceae, particularly in the Veratreae, some of which are polygamous. So no great stress can be laid on this difference. The distinction as regards number of carpels, their structure and ovulation, finds analogies in Ranunculaceae and Nymphaeaceae : and the semi-adnation is repeated in syncarpous Veratreae.

But the flowers, fruits, and seeds of *Protolirion* taken together resemble those of the Veratreae, and particularly the Tofieldieae, more than they do those of any other plants.

So *Protolirion* may be regarded as closely related to the archetype of the Liliaceae, and connecting the modern Liliaceae with the Triuridaceae. The transition between

these two families is even more completely illustrated if *Petrosavia* has indeed an apocarpous pistil; and one would feel inclined, in spite of its monocliny, eumery, and multi-ovulate carpels, to include *Petrosavia* in the Triuridaceae.

This investigation has been carried out in the Botanical Laboratory of the University of Oxford, and I desire to express my appreciation of the facilities which have been placed at my disposal.

Mr. H. N. Ridley has been good enough to prepare the following technical description of the plant, based on observations of his own as well as on mine, and to append a brief note:—

Protolirion, gen. nov.

Herba saprophytica parva perennis, omnino pallide ocreo-flava, rhizomate gracili sublignoso 1-3 pollices longo, 1 mm. crasso. *Caulis* 1-7 laterales erecti graciles teretes saepe flexuosi. *Folia* squamiformia, ad basin caulis congesta, superne remota, inferiora 2 mm. longa, vaginis teretibus oribus integris, laminis lanceolatis obtusis caule appressis, carinatis; superiora vaginis multo brevioribus internodia 5 mm. longa haud tegentibus, laminis angustioribus acuminatis acutis $3\frac{1}{2}$ mm. longis. *Racemus* corymbiformis ad sexflorus. *Flores* parvi flavi patentes, pedicellis 10 mm. longis suberectis. *Bracteae* singulae lanceolatae obtusae bifidae. *Sepala* anguste linearia-lanceolata acuminata parva. *Petala* majora ovata obtusa alterna. *Stamina* 6, tria epigyna, tria epipetala, petalis breviora, filamentis teretibus crassiusculis superne attenuatis, antheris oblongis basifixis loculis ad basin divergentibus, in marginibus dehiscentibus. *Nectaria* tria petalis opposita. *Pistillum* basi inferiore perianthio adnato syncarpo, superne superius liberum, apocarpum, carpellis 3 distinctis patentibus follicularibus in stylis brevibus attenuatis stigmatibus capitatis papillois. *Placentatio* axillaris. *Ovula* in seriebus duabus anatropa. *Capsulae* ovoideae recurvae patentes in margine superiore dehiscentes. *Semina* in carpello utroque 12 elliptico-

oblonga nodulosa brunnea albuminosa, embryone minuta. Alabastra ovoidea, praeformatione valvata.

Sp. unicum, *P. paradoxum*.

Loc., Malay Peninsula, in dry hill woods at an altitude of from 1,000 to 3,000 feet on the Larut Hills, Perak, and on Kedah Peak in Kedah. Coll. H. N. Ridley.

I published a short account of this plant in the Journal of the Straits branch of the Royal Asiatic Society, No. xxiv, pp. 170-2 (dated 1891), under the name of *Petrosavia*, thinking at the time it was identical with the plant described under this name by Beccari. Beccari's plant, however, though in many respects resembling this, is in some most important details very distinct, as shown in the preceding remarks by Mr. Groom. It is very difficult to refer *Protolirion* to any order; possibly it is most nearly allied to Triurideae.

H. N. RIDLEY.

EXPLANATION OF FIGURES IN PLATE III.

Illustrating Mr. Groom's paper on *Protolirion*.

p^1 = outer perianth-segments. p^2 = inner perianth-segments. s^1 = outer stamens. s^2 = inner stamens. sg = stigma.

Fig. 1. Whole plant. ($\times 3$. Winkel.) $m.a.$ = main axis. a'' = axis on $m.a.$ a''' = axis arising on a'' .

Fig. 2. Portion of the scape above ground. ($\times 15$. Winkel.)

Fig. 3. Inflorescence. ($\times 5$. Winkel.)

Fig. 4. Flower, after fertilization of the ovules. ($\times 15$. Winkel.)

Fig. 5. Transverse section of portion of central cylinder of root. (Zeiss $\frac{1}{3}$ immers. Oc. 2). ph = phloëm (?). xy = xylem-rays (?). end = endodermis. pc = pericycle.

Fig. 6. Transverse section of a vascular bundle and portion of the general sheath of rhizome. (Zeiss 3. DD.) $g.s.$ = general sheath. ph = phloëm. px = protoxylem. Arrow points radially inward.

Fig. 7. Transverse section of leaf embracing rhizome. ($\times 9$. Winkel.)

Figs. a, b, c . Longitudinal sections of flower. ($\times 20$. Winkel.)

Figs. $d-l$. Transverse sections of flower. n = nectary.

58 *Groom.—On a New Saprophytic Monocotyledon.*

Fig. *d.* Through the base of flower, showing loculi of ovary. ($\times 25$.)

Fig. *e.* Higher up showing septal glands, loculi of ovary, and vascular bundles. ($\times 25$.)

Fig. *f.* Higher than *e*, shows commencement of outer perianth. ($\times 25$.)

Fig. *g.* Higher than *f*, shows outer perianth free from ovary-wall. ($\times 25$.)

Fig. *h.* Higher than *g*, shows inner perianth, and outer stamens appearing. ($\times 20$.)

Fig. *i.* Higher than *h*, shows both perianth whorls free, outer stamens free, and inner stamens appearing, nectaries disappeared, and carpels commencing to be distinct from one another. ($\times 25$.)

Fig. *l.* Section high up flower, through three styles. ($\times 25$.)

The Hanging Foliage of certain Tropical Trees.

BY

F. W. KEEBLE, B.A.,

Frank Smart Student, Gonville and Caius College, Cambridge.

—♦—

With Plate IV.

—♦—

THE habit whereby the young leaves and branches of certain tropical trees hang vertically downward during the early stages of their existence has been frequently described in recent years¹.

The trees thus characterized belong, with but one exception so far as I have been able to ascertain, to the group Caesalpinieae of the order Leguminosae. Such are *Amherstia nobilis*, various species of *Brownea* (e.g. *B. grandiceps*, *B. coccinea*, *B. hybrida*), *Humboldtia laurifolia*, *Saraca indica*, and *S. declinata*, *Maniltoa gemmipara*, *Cynometra cauliflora* and *Calophyllum bracteatum* (Guttiferae). The last-named is a rare plant peculiar to Ceylon, and no opportunity of specially examining it occurred to me.

The three first-named trees, *Amherstia nobilis*, species of *Brownea*, and *Humboldtia laurifolia*, are those on which experiments and observations were made.

¹ Cf. Figs. 1 and 2.

Treub has well described the appearance which the young branches of such trees present: 'Very young branches, with their not yet green leaves, hang flaccidly down as though they were fallen out of the bud¹.' Haberlandt, in a recent book of travel, describes them as looking as though 'poured out' of the bud².

Treub³ and others have observed how rapidly the elongation of the shoots takes place. The following instance observed by me illustrates this. An unopened bud of *Brownea grandiceps* was ten inches long at six p.m. The next morning at seven o'clock the bud had opened and the petioles of the pinnate leaves which had issued from it were each a foot and a half in length. During the next two days they grew at the rate of little less than a foot a day, and had at the end of that time practically attained their full length.

During this elongation the leaflets are rolled longitudinally on themselves with their upper surface inwards. Similarly in *Amherstia nobilis*, during the short period of elongation, the very small, tender, hanging leaflets are folded on themselves along their midrib so as to include the upper surfaces. At first sight it might be imagined that this folding and rolling are devices for protection of the upper surfaces; but when the transientness of this condition is remembered, and especially the great rate at which the leaflets have been separated by the elongating petiole, it seems more likely that the folding or rolling is rather to be explained by the ordinary laws of vernalion than of special adaptation. In a few days the still hanging leaflets of *Brownea grandiceps* unroll, those of *Amherstia nobilis* unfold; these latter assume a bright red colour by the formation of rosy cell sap; those of the former pass from a pink flecked with white to a greener hue.

Several distinct views as to the significance of the hanging

¹ Treub, M., Jets over Knoppbedekking in die Tropen; Bot. Centralblatt, Vol. xxxv, p. 329.

² Haberlandt, G., Eine botanische Tropenreise, p. 117.

³ Treub, loc. cit.

habit have been put forward by various investigators. Potter, in a paper on bud-protection in the tropics¹, points out that the young leaves, by virtue of their disposition in a vertical plane, escape much of the damaging effect which the powerful perpendicular rays of a tropical sun might produce. In *Amherstia nobilis*, moreover, each pair of leaflets overlaps to a large extent the pair below, so that the surface exposed directly to light is still further reduced. Similarly also, in species of *Brownea*, the massing together of the several branches arising from a bud affords a considerable amount of mutual covering and, if need be, protection to the leaves. Potter, assuming that the extremely thin and delicate young foliage needs normally a protection against the powerful chemical or thermal action of the sun's rays, suggests that protection *is* afforded by the disposition of all the leaves in a vertical plane.

A fuller discussion of this view will be entered into later; it may, however, here be observed that the young secondary *petioles* are so flaccid that the leaflets borne by them hang vertically downward, no matter in what position the branch or the main petiole may be held; so that the hanging of the branch would, on this view, seem superfluous. It is true that later these secondary petioles become more rigid; but in the meantime the leaflets have become tougher and presumably therefore more capable of resisting any ill effects of exposure to direct sunlight. Treub, in a paper already quoted, seems also to see a means of protection in the pendent position. The rapid growth in length of the young branch and of the petioles of its leaves, has been already referred to; but the physiological interest seems rather to centre in the check to this longitudinal growth—in the fact that several weeks after rapid growth in length has ceased it begins again. First the branch raises itself up; then the petiole of the pinnate leaf is lifted up by means of a ventral pulvinar-like swelling (*polster*) at its point of attach-

¹ Journ. Linn. Soc., Vol. xxviii.

ment with the branch; then the leaves also, in a way to be described, take on a generally more horizontal position.

Growth within the tropics is often so rapid—so too in these trees is the elongation of the parts of the shoot—that most observers agree in ascribing to this 'waiting stage' some important biological significance.

Stahl, who has most recently examined these hanging branches, takes this view¹. He, however, rejects Potter's suggestion and sees in the phenomenon a means of protection of the young leaves from the force of rain. He points out that, within the tropics, the rainfall is often far heavier and more violent than in temperate zones, and that rain in the tropics generally falls vertically, owing to the stillness of the atmosphere.

To ascertain whether the young foliage needs the protection from the sun's rays which the pendent position affords, Stahl conducted the following experiments: young leaves of *Mangifera foetida*, *Humboldtia laurifolia*, and *Brownea hybrida* were laid on moist blotting-paper with their stalks in water, and exposed for four and a half hours (from seven till half-past eleven) to the direct rays of the sun (at Buitenzorg). At the end of that time the leaves remained fresh and gave no indication of any destruction of chlorophyll².

Stahl next sought to determine whether the vertically downward position afforded the young leaves any protection against too great transpiration. He found that, under similar conditions of insolation, the fully developed leaves, which had arrived at their ultimate position, dried more quickly than the young hanging leaves (*Amherstia nobilis* and *Brownea coccinea*). He observes that the mature leaves obviously require no special protection against too great transpiration; still less, therefore, do the young leaves, if they wither less readily, require any protection.

These conclusions seemed to me surprising, since, from

¹ E. Stahl, Regenfall und Blattgestalt; Ann. du Jard. Bot. de Buitenzorg, Tome XI. p. 146 et seq.

² Stahl, loc. cit., p. 148.

the older observations of Pringsheim and Wiesner¹, it is known that intense sunlight does, in many cases, cause considerable destruction of chlorophyll within the leaf. More recently also, Johow² thus sums up this view: 'The more likely view as to the destruction of chlorophyll by light is that it acts indirectly . . . and on this it is clear why destruction occurs more readily in shade-loving plants than in typical sun-plants and in young not fully green organs.'

I shall bring evidence to show that these trees, *Brownea* species, &c., are shade-loving trees. Accepting this for the moment, it will be seen that the young leaves of such trees, since they remain tender so long, are just those which might, unless specially protected, be expected to suffer from exposure to intense sunlight.

To test Stahl's results I took a branch bearing young red foliage from a tree of *Amherstia nobilis*. The branch was cut under water and its cut end kept in water during the experiment. It was so adjusted that the leaflets of one side of one of the large pinnate leaves hung vertically downward, those of the other were held each in a horizontal plane. These horizontally disposed leaflets lay on moist blotting paper, and were kept flat by means of bulldog clips. After five to six hours, pieces, each 50 sq. cm., were cut from an equal number of leaflets of the two sets. These were extracted in a mortar with similar quantities of alcohol, and when the extraction was complete the green colour of the two alcoholic solutions of chlorophyll was compared. *That from the leaflets horizontally placed was distinctly of a lighter green than that from those which hung vertically.*

The experiment was repeated with a similar result. So that these results point to a conclusion opposite to that at which Stahl arrives; for it must be inferred from the

¹ Wiesner, Die natürlichen Einrichtungen zum Schutze des Chlorophylls der lebenden Pflanze; Wien, 1876.

² Johow, Ueber die Beziehungen einiger Eigenschaften der Laubblätter zu den Standortsverhältnissen; Pringsheim's Jahrb. der wiss. Bot., Vol. xv, p. 285.

above experiments that thin delicate leaves of *Amherstia nobilis*, in which the chlorophyll-grains are developing, are, when exposed for a long time to the direct rays of the sun, in danger of injury to their green colouring-matter. Therefore, whether or not the hanging position is to be regarded as being a direct adaptation to protect the leaves from such injury, this vertical position, at least incidentally, ensures that such injury is reduced to a minimum.

The second of the conclusions drawn by Stahl was next considered. This was, as already stated, that the hanging position does not signify a need for protection against excessive transpiration, since, of leaves exposed to similar conditions of insolation, he finds that the young and tender wither less readily than the tough mature leaves.

On first testing this, by means of branches of *Amherstia nobilis* cut under water and suspended with their cut ends under water, results similar to Stahl's were obtained. The older leaves withered sooner. On repeating the experiment, however, it was found that, after a time, the young leaves had withered to such an extent that their leaflets were rolled up longitudinally and quite faded, whereas those of the *green mature leaves were still perfectly fresh*. The experiment was repeated. On this occasion one of the two branches cut at the same time bore large red leaves, the other red-brown and therefore older leaves. After some hours the younger leaves were quite withered, the older ones, on the other branch, were still fresh. In the above instances the stems were kept in water. In a third case the cut ends of the stems were not kept under water. Under these still more abnormal conditions the younger leafed branch again withered more rapidly than the older.

In yet another case, two petioles, each bearing two leaflets, were put in the sun; the leaflets of one were bright green, those of the other red-brown and consequently less mature. Other two similar sets, cut at the same time, were protected from the sun. After several hours, the young red-brown leaflets, which had been exposed to the sun, were found to be

withered, the green ones similarly placed were not; nor were either of the two shaded sets of leaflets.

Indeed the experiments were repeated so frequently as to leave no doubt that, under similar conditions of exposure, the thin delicate immature leaves of *Amherstia nobilis* wither more rapidly than the more fully developed leaves; that, as would perhaps be surmised, with increasing toughness and thickness there occurs an increase of resistance to too great a loss of water—together, may be, with increased facility in obtaining water; that under unfavourable conditions the younger leaves are more readily damaged than the older. Since the young leaves of *Amherstia nobilis* are readily injured by exposure to direct sunlight, at all events under the conditions of the above experiments, the opposite conclusion to that at which Stahl arrives might be urged—viz. that such risk of injury indicates a need, on the part of the tender foliage, of special protection, and that the hanging position is an adaptation to this end.

It does not, however, follow that the habit under examination was developed solely as such a means of protection. It is possible at least to suppose that this habit has some other, or, at all events, additional significance. It seemed worth while to compare the rates of transpiration of the mature and immature leaves.

The comparison of the rates of transpiration was generally made by aid of the potometer¹. By this method is measured, not the rate of transpiration, but the rapidity with which water is taken up by the branch.

Branches were cut at 9.30 a.m. and brought to the apparatus. The following numbers give the time in seconds that bubbles took in passing from one mark to the other on the capillary tube of the potometer, the bubbles being made to follow one another as rapidly as possible.

¹ Darwin and Phillips, Cambridge Philosoph. Soc., Vol. v, 1886.

Branch bearing bright green leaves, *Amherstia nobilis*.

10	5	8	5	6
5	5	6	6	5
5	5	6	7	7
5	5	5	6	6
10	6	5	6	6
10	5	5	6	6
5	5	6	6	6
5	6	6	6	6
5	6	5	7	6
5	5	6	7	6
Time in seconds of ascent } 65 53 58 62 60				
of ten bubbles				

Average time of ascent of 10 bubbles = 59 seconds.

Branch bearing red hanging foliage, *Amherstia nobilis*.

10	10	10	10	10
10	10	11	8	10
11	11	11	9	11
10	10	11	11	11
13	10	12	9	9
12	10	10	9	11
12	10	8	10	10
9	9	10	11	9
9	11	10	11	10
11	11	9	10	11
Time in seconds of ascent } 107 102 102 98 102				
of ten bubbles				

Average time of ascent of 10 bubbles = 102 seconds.

Now the number of leaflets on the older branch was ten, on the younger twenty-four; and measurement of surface (by tracing the outlines of the leaflets on thin paper, cutting out these shapes, and weighing), gave the surface of the young leaves equal to twice that of the older. Therefore in this instance the rates of transpiration of equal surfaces of young and old leaves are as 1:4—i.e. the older leaves transpire, roughly speaking, four times as rapidly as the younger hanging leaves.

Another example of a similar experiment may be given. Three branches of *Amherstia nobilis*, of course from the same tree, were taken. On one, the leaves were thin, young, bright red; on another, older, as evidenced by their brown-red colour; on the third, bright green.

The numbers given below were obtained as in the preceding experiment, and represent the average rate in seconds of the passage of ten bubbles between the two marks.

In this case each branch bore ten leaflets and the total areas of the three sets of leaves differed but little from one another.

Average rate of passage of ten bubbles :

Green.	Brown-green.	Red.
123 secs.	165 secs.	204 secs.

Here also, therefore, the green leaves transpire more rapidly than the younger red-brown, and both more quickly than the youngest red leaves.

In yet a third case two branches, one of green leaves, the other of red-brown, were used. The following are the results :

Young green leaves (secondary petioles still flexible) ten leaflets,

Amherstia nobilis.

6	5	4	5	
6	5	4	5	
7	5	4	5	
5	5	5	5	
5	5	5	5	
5	4	4	5	
5	4	4	5	
5	4	4	5	
5	5	3	5	
5	5	3	7	
Time in seconds of passage of air bubble between marks	} 54	} 47	} 40	} 52

Average time in seconds for passage of 10 bubbles = 48.

Red-brown leaves, twelve leaflets. (Since this experiment was used also for another purpose to be mentioned directly, no less than 140 readings were taken.) The times in seconds per ten 'bubbles' passage are in order : 171, 145, 135, 138, 138, 124, 137, 150, 123, 129, 131, 136, 129, 136. The average of these fourteen numbers is the average time of passage of 10 bubbles = 130.

Now the weight of thin paper cut into the shapes of the ten green leaflets was 2.3 g. ; that of similar paper cut in the

shape of the twelve red-brown leaflets was 2.045 g.; therefore the relative areas were

$$\frac{\text{green leaves}}{\text{red leaves}} = \frac{2.3}{2.045}$$

Hence the rates of transpiration of equal surfaces :

$$\frac{\text{green}}{\text{red-brown}} = \frac{130}{\frac{48 \times 2.3}{2.045}} = \frac{130}{54}$$

So that the green leaves transpire more than twice as rapidly as the red-brown. In order to test the reliability of this potometer-method, the results obtained by it were checked by the ordinary method of weighing at intervals the branches under comparison. Thus, in the case just quoted, it was found by the potometer that the relative rates at which the young red-brown leaves and the older green leaves took up water were as 130:54. Their petioles were removed from the potometer, and were again cut under water, so that each now bore six leaflets. These petioles were fitted by means of halved corks into tubes containing water and weighed. They were weighed again after half an hour. The weighings showed the relative loss of water in the green leaf and red-brown leaf respectively to be as 3:1. Conceding that the relative areas of these two sets of six leaflets differ but little from those of the two sets of ten leaflets which the petioles originally bore, the relative areas of the two sets (*vide supra*) are as 2.3 green: 2.045 red. Hence by the weighing method the relative losses of water by *equal* surfaces of red-brown and green leaves =

$$\frac{\text{red-brown}}{\text{green}} = \frac{1}{\frac{3 \times 2.045}{2.3}} = \frac{1}{2.66} = \frac{54}{144}$$

and this agrees sufficiently well with $\frac{54}{130}$ obtained by the potometer.

Since, then, the older, fully-grown leaves of *Amherstia nobilis* transpire much more rapidly than the young hanging red leaves—and yet these latter show, by withering, ill effects

from exposure to the sun so much more readily than the former—it must be inferred that the tougher, more leathery, mature leaves can bear with impunity a loss of water far greater than that which suffices to damage the thin, delicate immature leaves.

The next step was to determine how far this relative lowness of transpiration on the part of the red leaves was due to their mutual overlapping and vertical downward position.

The results given below show a difference—not however so marked as might be expected—between the rates of transpiration of the leaflets in the hanging overlapping (natural) position and when outspread.

The smallness of the difference is probably to be explained by the fact that the experiment was made in a very moist atmosphere and in a room out of direct sunlight.

The experiment was made by taking a healthy hanging branch of *Amherstia nobilis*, bearing a large pinnate leaf with red tender leaflets, and measuring the rate of transpiration, first, whilst the branch and the leaf hung vertically downward, and then when each leaflet was outspread in various convenient positions. The leaflets were spread out by means of papers folded over stretched strings appropriately placed and gummed to the extremities of the long leaf-tips.

The following are the results :

Branch held obliquely up, but the leaf and leaflets allowed to hang and overlap.	Time in seconds of passage of bubbles up capillary tube	Time in seconds of passage of ten bubbles	Average = 139.	Leaflets spread out in various planes no longer overlapping.	Time in seconds of passage of bubbles up capillary tube	Time in seconds of passage of ten bubbles	Average = 130.5.
	15	14	16	16	12	14	
	15	14	13	14	12	14	
	14	12	15	14	12	14	
	15	12	13	13	13	13	
	15	14	13	14	13	13	
	14	12	14	13	13	14	
	14	15	13	13	12	14	
	14	14	12	13	12	13	
	15	13	14	14	13	14	
	14	15	15	14	13	14	
	145	135	138	138	124	137	

Leaf and leaflets allowed to hang downward, overlapping.	Leaflets again spread out in various planes.	Leaflets again allowed to hang vertically downward.
14	10 13	14 15
15	11 14	13 14
15	12 13	13 14
15	12 13	14 13
16	12 13	13 13
15	13 12	14 14
15	13 13	13 14
15	13 13	12 13
15	13 12	13 14
15	14 13	12 12
150	123 129	131 136
Average = 150.	Average = 126.	Average = 133.5.

Transpiration, then, *is increased* when the leaflets are spread out in various planes; so that, bearing in mind the reasons given previously for the small differences in these numbers, it may be said that the young hanging leaves of such trees as *Amherstia nobilis* do gain, by virtue of their position, some protection from the tax of excessive transpiration.

Before, however, drawing definite inferences from any of these experiments, it was determined to test Stahl's conclusions in yet another way. Pairs of leaflets, one young red and one older green, were cut off from leaves whose rates of transpiration had been determined. These pairs were weighed and then exposed to the sun. It was found repeatedly in such cases that the red leaflets lost weight quicker than the green, and withered sooner: that is to say, the supply of water being cut off from the leaves, green and red alike, the thin texture of the latter offers far less resistance to loss of water than does the stouter tissue of the green. If an inference may be drawn from this experiment, in which the leaves are subjected to such unnatural conditions, it is that, as already shown in other ways, the delicate tissue of the young red leaves does stand in need of protection. The conclusions which must therefore be drawn from the various experiments detailed above are:

- (1) The fact that the young red leaves of hanging branches

of *Amherstia nobilis* wither when in water quicker than the green leaves of lifted or partially uplifted branches, shows at least that a protection against excessive transpiration is by no means superfluous.

(2) The fact that the young red leaves of this plant transpire more rapidly when outspread than when hanging vertically, indicates that the hanging habit, whether specially adapted to that end or not, affords some measure of protection.

Of the trees which have hanging branches, not a few possess brightly coloured young foliage.

Reference has been repeatedly made to the red tint of the young leaves of *Amherstia nobilis*. Stahl, in addition to this instance, mentions the following: One variety of *Cynometra cauliflora*—bright rose-colour; *Fonesia reclinata*—golden-green to bright red; *Brownea hybrida* and *Brownea grandiceps*—bright red, freckled with green. To these may be added *Saraca indica*—rose-coloured.

On the other hand, the young leaves borne on hanging branches are white in the following: one variety of *Cynometra cauliflora*, *Cynometra ramiflora*, *Humboldtia lauriflora* (except two small rosy nectaries), *Calophyllum bracteatum*¹. Although, then, the occurrence of coloured sap is not universal among these trees, it seemed nevertheless not unlikely that, in those cases in which it occurs, it might serve as a means of protection against too strong action, either thermal or chemical or both, of the sun's rays.

Wiesner² has already called attention to the possibility of such protection being afforded by coloured saps. Stahl makes the not insignificant remark that the leaves of *Fonesia reclinata* are in shade gold-green, in sun bright red³.

A direct change in leaf-colouration was observed by me

¹ Trimen, Handbook of Flora of Ceylon, Part I, p. 102; Part II, pp. 113, 114.

² Loc. cit.

³ Loc. cit., p. 144.

in a seedling *Brownea grandiceps*. The plant was raised in the diffuse light of a room, and when its leaves had assumed a good green colour it was placed in the open, exposed directly to the sun. The leaves acquired a distinct red tinge, so that probably, in response to the changed conditions of insolation, a new formation of coloured sap took place. Since writing the above I find in Johow's paper already cited¹ the following statement, which seems to show to what an extent the amount of red colour in such leaves as these is the result of exposure to sun: 'That the appearance of red colour in the leaf is determined by light is shown by the fact that in cases where the different leaves are differently illuminated' (referring to *Brownea* and *Acacia* species) 'those leaves most exposed to the light possess an intense red colour, those more shaded a fainter red or even bright green.'

It was sought to determine by a simple experiment whether the coloured cell-sap had any noticeable influence in controlling the temperature of leaves exposed directly to tropical sun. For, although little is known as to the temperatures which leaves in exposed positions, as tree-tops, reach—such an investigation being attended, as the writer found, by too great a personal equation on the part of the coolie employed in climbing the trees—it can hardly be doubted that at times the optimal temperatures for the various processes of the leaf may be exceeded.

It was argued that if the red colour of such leaves as *Amherstia nobilis* has a protective value in mitigating the temperature within the leaf the fact might be demonstrated by the thermometer.

The following experiment was made:

First, red and green leaflets of *Amherstia nobilis* (the green being thicker and tougher) were laid side by side on the grass in the bright sun, and thermometers were placed on either set.

¹ Loc. cit., p. 300.

The thermometers resting on the rows of red and green leaflets respectively gave at intervals the following readings :

Thermometer resting on red leaflets = 32.7° C. 33.4° C. 34.4° C. 34.6° C. 34.4° C.
 „ „ green leaflets = 31.9° C. 32.4° C. 33.2° C. 33.5° C. 33.3° C.

Average temperature registered by thermometers :

On red leaflets = 33.0° C.
 On green leaflets = 32.9° C.

The thermometers were tested by transposing them, and showed their accuracy very distinctly thus :

Thermometer resting on red leaflets = 33.7° C. 34° 34.2° C. 33.1° C.
 „ „ green leaflets = 33.1° C. 33.1° C. 33° 32.1° C.

Average temperature registered by thermometers :

On red leaflets = 33.8° C.
 On green leaflets = 32.8° C.

In the second part of the experiment the thermometers were covered nearly up to the level of the mercury, one by the red, the other by the green leaflets.

The thermometers now gave the following readings :

Thermometer covered by red leaflets = 33.5° C. 33.3 32 31.6 32.3 33.2 32.1
 „ „ green leaflets = 35° C. 34.4 32.9 32.3 34 34.8 33.3

Average temperature registered by the thermometers :

That covered by red leaflets = 32.6° C.
 „ „ green leaflets = 33.8° C.

In short, when young thin red and older tougher green leaves of *Amherstia* are exposed side by side to the direct rays of the sun, the temperature, as registered by the thermometer, is higher to the extent of 1° C. at the upper surface of the red leaves : conversely, of the temperatures registered at the lower surfaces of the leaves (i.e. behind them), that beneath the green is higher than that beneath the red, by a similar amount.

Put in general terms, the surface-layers of the red leaf reflect more heat than those of the green leaf. The green

leaf, conversely, absorbs more of the sun's thermal rays than the red. Now, the two sets of leaves differ in two respects: first, in colour; then in that the green has a thicker, more developed cuticle (and mesophyll) than the red. This might, therefore, be expected to oppose a more solid resistance to the heat-rays than the thin immature cuticle of the red leaf. That such is not the case must be regarded as due to the fact that the different colouring-matters have different powers of reflection and absorption of heat, and that this difference is of such a nature that the red colouring-matter more effectually cuts off heat-rays from the body of the leaf than does the green. That is to say, the red colouring-matter acts as a screen by which the thermal effects of the sun's rays are moderated. That the red colouring-matters of leaves act powerfully in protecting the leaf from too intense action of light has been recently the subject of a research by Pick. This investigator finds that the photometric properties of the red colouring-matter enable it to protect the leaf, especially by cutting off rays which would interfere with the translocation of carbohydrates¹.

In addition, then, to its value as a screen, the red or reddish coloured saps of such trees as *Amherstia nobilis* have the capability of affording to the young leaf, if necessary, a protection against too great *heating* effects of the rays of a tropical sun.

This colouration of the young foliage of trees of low latitudes is of very general occurrence. So general is it that a tropical forest presents at the time of its leaf-renewal an appearance which for beauty of tints rivals that which the trees of temperate climates exhibit in early autumn².

It may be that these coloured saps, occurring often in trees whose leaves are, from their youngest stages, liable to a full

¹ Pick, Bot. Centralblatt, B. XVI, Nos. 9-12.

² After writing the above I find the following remark in the paper by Johow to which reference has already been made, which shows that the prevalence of red saps in young foliage is not underestimated by me: 'All at once' (he is writing of the Lesser Antilles) 'a red tint, due to the young foliage of the trees, appears in the landscape.' Johow, loc. cit. p. 295.

exposure to the sun, serve as the red sap of *Amherstia nobilis* seems to serve—not only as light-screens, but also as heat-screens, whereby the fierceness of the sun's rays is tempered to the young leaf; and although a difference of a degree—that recorded in the case of *Amherstia nobilis*—is not actually much, in times of danger it might mean the difference between life and death, or at all events between impaired or unimpaired functional activity and development.

In the group of trees under consideration this means of protection is not universal; and indeed it is only suggested that it seems to be a minor adaptation, which makes for the security of the young foliage whilst in its limp thin condition. That it does not occur in all by no means destroys this contention, since, to some trees, the production of coloured sap is a more simple task than to others. Thus it would seem to be simple to *Amherstia nobilis*, since the red colour not only characterizes the young foliage, but appears in the flower, the fruit, the buds and the flower-stalk.

In such trees as *Humboldtia laurifolia*, whose hanging foliage is white, it may be that greater thickness of cuticle is earlier arrived at, or that a slightly different habit or habitat renders such a minor adaptation of less importance.

Another factor, which in *Amherstia nobilis* may serve to reduce the temperature of the leaves, is their fugitive hairy covering. It is a curious point that these hairs, which render the young leaves of *Amherstia nobilis* very difficult to wet, disappear in the mature leaves; although, according to Stahl, it is those very mature leaves which need protection against wetting. That these mature leaves need some means whereby rainwater may be rapidly carried away from the leaf Stahl infers from their possession of a very long acuminate apices, to which in such and similar cases he has given the name of 'Träufel-spitzen' (drip-tips). Stahl finds from experiment and observation on many species of plants that these acuminate apices are very useful in carrying away water which falls on the leaf¹.

¹ Cf. also Junger's view, Bot. Centralblatt, 47, No. 12, who suggests a similar function for these acuminate apices.

Were this water not removed, transpiration and perhaps other functions of the leaf would, Stahl holds, be seriously checked.

Although, in experiments which I made, removal of the long apices from the leaves of *Amherstia nobilis* did not seem to impede the rapid drying of the leaf after rain, if it be allowed that some means of protection against prolonged wetting *is* needed, it might have been supposed, in the case of *Amherstia nobilis*, that such a protection would have been afforded in the mature leaf by the permanence of these hairs which, as stated, are present in the young. These, however, disappear. If Stahl's view of the value of these 'Träufelspitzen' be correct, then the hairs present in the young leaf have some other function, viz. protection against light or heat, and are superfluous as a means of protection against wetting.

As an alternative it may be suggested, with due deference to the distinguished author of 'Regenfall und Blattgestalt,' that these mature leaves of *Amherstia nobilis* have no especial need for a means of 'running off' of water from their surfaces. An observation of a detail may be mentioned here as shedding some light on the question of 'Träufelspitzen,' and also on the need for protection of the young leaves of *Amherstia nobilis*.

Three or four specimens of this tree grow, and grow well, in the Botanical Gardens at Perideniya. The longish apices (Träufelspitzen) of the mature leaves are almost without exception withered and dead. Now these apices consist of tissue which has not become so tough or coriaceous as the rest of the leaf. Nevertheless, whilst the leaves hang, the tips remain uninjured; when the leaves rise up and expose themselves to the sun these thin extremities are rapidly killed.

Whether the trees in the Perideniya gardens are growing under conditions similar to those which their ancestors in Tenasserim enjoyed is, of course, open to doubt; still the withering of the tips shows, and no more is urged here, that

the tender leaves are at least safeguarded by their hanging position from damaging effects of sun.

Another noticeable fact with regard to these tips in *Amherstia nobilis* deserves notice. As the leaf passes from its red-brown stage to its full green condition, the tips, which were very long in the former stage, become, by growth of the leaf, less well marked. Now, in the young stage, they cannot, of course, function as 'Träufelspitzen,' since by the young leaf's position no rain falls directly on it, and also, so hairy are the young leaves that a continuous stream of water-drops splashed on them does not wet the surface—each drop rolling off at the nearest possible point. If the acuminate apex is a 'Träufelspitze,' why is the organ better developed at a time when it is useless—in the young stages, before it can be functional—than later, when the plant requires its aid?

In concluding this part of the subject, it may be mentioned here that the trees *Amherstia nobilis*, *Brownea grandiceps*, &c., have not, in the formation of fresh shoots, the exact annual periodicity of most trees of temperate climates. So it happens in Ceylon that young branches arise all the year round, though in far greater numbers during the wet weather of the south-west monsoon. Now Potter points out¹ that in those branches produced during the comparatively dry and hot weather, withering of the young pendent leaves not infrequently occurs. This withering certainly happens frequently in the young branches of the *Amherstia nobilis* trees which grow in the Botanical Gardens at Perideniya. On the view put forward by Potter, that this hanging habit is a direct adaptation to secure protection against the sun's action, this observation certainly shows the need for such protection.

The branches produced in the dry weather hang as long as, or even longer than, those produced during the rains, although, on Stahl's view, there is no reason why they should. If, then, his view be accepted it must be allowed that these trees have

¹ Loc. cit.

so thoroughly acquired the habit of hanging their foliage to avoid rain that they work independently of external conditions, and yet, at the same time, they have not acquired such periodicity as alone renders that habit of constant value.

When the events which occur during the period in which branch and leaf alike hang are examined, some light seems to be thrown on the significance of this habit.

About the time that leaves of *Amherstia nobilis* and *Brownea grandiceps* begin to take on their green colour, a periodic movement occurs in their leaflets. This movement, feeble at first, acquires a gradually increasing range. In these trees it is of such a nature that the leaflets move downwards during the sunny hours of the day, so that their surfaces make smaller angles with the vertical. This movement is continued during the night, so that in *Amherstia nobilis* the pairs of leaflets hang almost vertically downward. So general is this movement, being by no means confined to the young green leaves, that the tree at night has a most curious aspect, suggestive of the sleeping position assumed by many leaves. In the early morning, near sunrise, the leaflets stand well up approximately horizontally. Even in leaflets which show their maturity by their glossy, dark green colour, and their apparently rigid petioles, this diurnal movement occurs, though its range is decreased.

Practically the same movement occurs in the various species of *Brownea*; and, as an opportunity of raising seedlings of *Brownea grandiceps* occurred, I was able to investigate this movement more fully in these.

As in the adult, so in a seedling *Brownea* bearing six or eight healthy leaves, the leaf-movement was similar to that already described. In early morning the leaves stood out more or less horizontally; but frequently, when the plants were growing in a room, the upward movement was continued for some hours after sunrise; in later morning the downward movement began and continued into the night, giving place before daybreak to an upward movement. Thus in one case the angles, which a leaf of a seedling *Brownea grandiceps*

made at different times of the day with the vertical, were observed. The measurement was made by affixing a short glass thread to the leaf, so that it projected about half an inch beyond and in a line with the midrib. This thread, whose point was blackened, played over the flat surface of a vertical semicircular arc of cardboard, whose radius was the distance between the point of insertion of the leaf and tip of the pointer, and which was graduated in degrees ¹.

Plant in room, diffuse light.

At	Time	Day	leaf	Angle	Direction
At	10-50 a.m.	Thursday	leaf	4°	above horizontal.
	2 p.m.	"	"	12.5°	below "
	2-30 "	"	"	15°	" "
	4 "	"	"	17.5°	" "
	5 "	"	"	25°	" "
	6 "	"	"	30°	" "
	8-30 "	"	"	32.5°	" "
	6-15 a.m.	Friday	"	10°	" "
	8 "	"	"	7.5°	" "
²	10-40 "	"	"	4°	" "
	11-10 "	"	"	7.5°	" "
	2-45 p.m.	"	"	24°	" "
	3 "	"	"	27°	" "
	3-55 "	"	"	30°	" "
	6-15 "	"	"	35°	" "
	8-30 "	"	"	40°	" "
	6-30 a.m.	Saturday	"	35°	" "
	8-25 "	"	"	45°	" "
	4-35 p.m.	"	"	50°	" "
	3 "	"	"	57.5°	" "

These numbers show (1) that a leaf makes a larger angle with the horizontal, i.e. is more depressed, when exposed to direct sun than when in diffuse light; (2) that this is brought about, first, by the direct effect of sunlight on the periodic movement, and, secondly, by indirect after-effect, whereby the nocturnal recovery tends, in leaves which have been exposed to direct sunlight, to be inhibited. This latter indirect effect of sunlight explains the fact that young leaves of *Brownea grandiceps* growing in the sun seem to hang permanently downward.

¹ See Darwin, Power of Movement, pp. 330, 331.

² At this point the plant was put in the open, but protected from rain and wind. The day was cloudy with but occasional sunshine.

That bright sunlight brings about a depression was also shown in another way. Six seedling plants of *Brownea grandiceps*, at similar stages of development, were selected from a batch. Of these, two were placed in the open, fully exposed to the direct rays of the sun, the others were left in a room. When so placed there was nothing in the disposition of the leaves of the former to distinguish them from those of the plants which remained in the room. At the end of the first day of exposure it was found, as in the preceding case, that the leaves of the two plants in the open, made far larger angles with the horizontal—were much more depressed—than the leaves of those plants which were in the room. At the end of five days the difference between the two sets was most pronounced—all the leaves of the sun-exposed plants hung vertically down, whilst those of the plants in the room stood out more or less horizontally (cf. Fig. 1 with Fig. 2). Although the effect of exposure to the sun was so great, the daily periodicity of the movement was not destroyed; only the upward movement was greatly reduced. The same plant, when brought back into the diffuse light of the room, gradually recovered itself, so to speak, so that after several days the leaves raised themselves so as to stand horizontally, and once more performed their periodic movement in a way similar to that which obtained before exposure.

In the case of *Amherstia nobilis* it was not possible to directly measure the angles which the leaves made at various times with the vertical, although, as already stated, the general course of the movement can readily be followed without special arrangement. It was possible, however, by a rough method, not only to demonstrate the general course of movement of the leaflets of this plant during the day, but also to observe the relation that movement bears to the amount of insolation.

Fine beeswaxed threads were passed between opposite pairs of leaflets through holes in the basal parts of their laminae, close to the junction of lamina and petiole. The holes were large enough not to cause friction between the

leaflets and thread, and thus not to impede any movement. A knot was made on one side of the thread, which was then gently tightened and an India-ink mark made where the thread passed through the opposite leaflet. By these means the distance between each pair of opposite leaflets, at the commencement of the experiment, was known. Any upward movement, whereby the leaflets approach a more horizontal position, was indicated by a greater length of thread becoming included between the leaflets, a downward movement by a bagging of the thread. The positions occupied by the leaflets, at different times of day and night, could then be compared.

Fourteen pinnate leaves, each two feet or more in length, and each bearing from three to seven threaded pairs of leaflets, were observed. The threads were passed through and marked between 7.30 and 9 o'clock on Monday.

The leaves chosen were mostly young, still more or less pendent, and brilliantly green; some, however—and reference will later be made to these—had reached their mature fixed positions; and in these the petioles of the leaflets seemed to be quite rigid, although, as will be seen, they were still capable of some movement.

Allowing (+) to stand for those leaflets which had become more horizontal (since in so doing they included more thread than between knot and India-ink mark); (=) to denote those whose positions were unchanged; (−) those which came to hang more vertically, the following numbers represent the results obtained :

	(+)	(=)	(−)	
Monday, 1.40 p.m.	31	32	15	= 78 total leaflets observed.
4.30 „ (sunny)	28	25	21	= 74 „ „
8.30 „	all the leaves hanging down, most so that the laminae of opposite leaflets were parallel.			
	(+)	(=)	(−)	
Tuesday, 7.30 a.m.	43	23	7	= 73

These numbers may be arranged in the form of a ratio, thus :

	(-) : (+)
Monday, 1.40 p.m.	15 : 31 = 48 : 100
„ 4.30 „	21 : 28 = 75 : 100
„ 8.30 „	(most hanging downward, i. e. most (-)).
Tuesday, 7.30 a.m.	7 : 43 = 16.3 : 100.

When the roughness of the method is remembered, and also the difficulties attendant on even simple observations in the open, it will probably be conceded that the above statistics bear out what has already been described to be the movement possessed by leaflets of *Amherstia nobilis*. These observations were continued with a view to discovering if the amplitude of the movement in *Amherstia nobilis* was so markedly controlled by the amount of insolation as is the case in *Brownea grandiceps*.

The following results were obtained :

	(+)	(=)	(-)	
Tuesday, 7.30 a.m.	43	23	7 = 73	total number of leaflets observed.
„ 12.40 p.m.	39	32	6 = 77	„ „
„ 4.30 „	39	27	6 = 72	„ „
Wednesday, 7.30 a.m.	52	16	8 = 76	„ „
„ 2.30 p.m.	37	24	15 = 76	„ „
„ 6.30 „	21	21	28 = 70	„ „

The discrepancies in the totals of the last column are due to the fact that it was sometimes impossible, owing to wind, &c., to determine in a particular branch the positions of all the pairs of leaflets ; but for the purpose for which the numbers are quoted these discrepancies are not sufficiently great to matter. The Tuesday was a cloudy, rainy day, with no one hour of continuous sunshine. On Wednesday, on the contrary, the sun shone fairly brightly. It was such a conjunction of circumstances as was wanted for the experiment. The results are noteworthy. On Tuesday, cloudy, no sun : at 4.30 p.m. only six pairs of leaflets were sufficiently depressed to make a difference in the length of thread between the pairs. On Wednesday, sun : at 2.30 p.m., i.e. two hours

earlier, as many as fifteen pairs of leaflets were pendent, and at 6.30 twenty-eight pairs.

Here, then, it may confidently be asserted that, as in *Brownea grandiceps*, the position of the leaflets with respect to the vertical is daily determined by the amount of sunshine ; and that here also, as already demonstrated, in *Brownea grandiceps*, the amount of daily depression ultimately determines the plane taken up by the mature leaflet when, after weeks during which the extent of movement has been gradually waning, this leaflet assumes a fixed position.

The movement described, whereby the leaflets sink downward so as to expose their edges to the light, resembles in purpose that of *Robinia Pseud-acacia* ; in this plant, however, the leaflets remain motile by virtue of their pulvini, whereas in *Amherstia nobilis* and species of *Brownea* the leaflets become ultimately fixed in a position of which the chief determinant is the amount of insolation received.

The movement of the leaflets of *Robinia* is such that during darkness they point downward, in dull light they stand out approximately horizontally ; in intense sunlight they rise up and present their edges to the light¹.

Wiesner showed by direct experiment that this adaptation of the power of leaf-movement, so common throughout the Leguminosae, has, in the case of *Robinia Pseud-acacia*, for its purpose the protection of the chlorophyll from too intense sunlight².

The movements effected by the leaflets of *Averrhoa bilimbi* in response to bright sunlight have probably a similar significance ; and these movements are of exactly the same nature as those which occur in the trees of the genera *Amherstia*, *Brownea* and *Humboldtia*. But *Averrhoa bilimbi* has a periodic movement which results in a hanging of the leaflets toward evening, and a horizontal outspreading of the leaves in the morning ; whereas, as has been described, the leaflets of *Brownea grandiceps*, &c., when growing in the diffuse light of

¹ Darwin, Power of Movement, pp. 355 and 445 ; and Wiesner, loc. cit., p. 27.

² Wiesner, loc. cit. p. 26 et seq.

a room, and therefore exposed to alternating conditions of darkness and of light of medium intensity, tend to assume a more or less horizontal position, from which they do not deviate nearly so much as when exposed directly to the sun: conversely, when growing in very sunny places the leaflets tend to be permanently depressed and to show a periodic movement of much less range than that which they possess when growing in places where the sun has less power.

If any inference may be drawn from the difference in the nature of the movements in *Amherstia nobilis*, &c., on the one hand, and in *Averrhoa bilimbi* on the other, it would seem that, in the former, the movement is more especially adapted—if not solely—to protect the leaf from excessive insolation, in the latter, power of protection, not only from intense sun, but also from night exposure, exists.

Finally, Johow¹ mentions that a protection against sunlight is effected in other of the Leguminosae, e.g. *Pithecolobium trapezifolium*, *Acacia macrantha* and *Cassia spectabilis*, by means of periodic movements.

The daily movement commences in the leaflets of *Amherstia*, whilst the branch and petioles are still in the pendent position, and indeed becomes very vigorous during this stage; so much so that the leaflets, which have become green and stout, rise up under the combined influences of this movement and dia-heliotropism and place their leaves more or less horizontally—the extent to which they become thus outspread being, as already shown, determined by the amount of insolation they individually receive.

On Stahl's view of the meaning of the hanging habit of the shoots, an obvious dilemma presents itself. The branch hangs downward for several weeks to enable the leaves to avoid rain; yet, whilst it thus hangs, the leaflets, which have, it is true, become tougher, rise up and expose themselves to rain. Thus a petiole bearing horizontally disposed leaflets continues for one or two weeks to hang vertically. If it be that the leaflets are become stout enough now to successfully

¹ Loc. cit. p. 295

withstand the shock of falling rain, why, it may fairly be asked, does the branch and leaf as a whole continue to hang so long after its function in so doing is fulfilled? If the leaves are not yet in a condition to withstand the shock of rain, the protective value of the hanging branch is rendered void by the exposed positions the leaflets now take up.

It has already been stated that the periodic movement continues, though with decreasing amplitude, in the leaflets whose petioles seem quite hardened and which are members of a leaf whose petiole has reached its mature uplifted position.

Thus the well-matured leaflets of a leaf which was in its final approximately horizontal position showed the following alterations in position :

		(+)	(=)	(-)
Saturday,	5.30 p.m.	4	2	
Sunday,	9.30 a.m.	4	2	
Monday,	7 "		6	
"	1.40 p.m. (?3)		1	2
"	4.30 "		3	2
Tuesday,	7.30 a.m.		6	
"	12.40 p.m.	1	5	
"	4.30 "	1	5	
Wednesday,	7.30 a.m.	1	4-5	
"	2.30 p.m.		5	1
"	6.30 "		4	2

This daily movement of the leaflets of *Amherstia nobilis* lasts, then, many weeks.

In yet a third tree (*Humboldtia laurifolia*), whose young branches and leaves hang, the ultimate positions assumed by the mature leaves are determined, as in *Amherstia nobilis* and *Brownea grandiceps*, by the extent to which they are exposed to the sun's rays.

One of these trees growing in the gardens is almost bush-like in habit. The bush is so dense that part is completely shaded. Branches of apparently the same age were cut from the external exposed and from the internal shaded parts, and the positions of the paired leaflets of the pinnate leaves estimated. This estimation was effected by placing each pair of leaflets in one of three groups, according as (1) the

plane of the leaflet was vertical (downward), (2) the leaflet made an angle of about 45° with the vertical, (3) the leaflet was disposed in a horizontal plane. The following are the results of thus enumerating the leaves of four branches of *Humboldtia laurifolia*:

	Leaves (1) in vertical plane.	Leaves (2) at 45° .	Leaves (3) in horizontal plane.
Shade branches	8	21	19
Sun branches	27	20	0

there being an average of four pairs of leaflets to each pinnate leaf, the total number of leaflets in the various positions is:—

	Leaflets (1) parallel with vertical.	Leaflets (2) 45° with vertical.	Leaflets (3) in horizontal plane.	Total leaves.
Shade branches	64	168	152	= 384
Sun branches	216	160	0	= 376

or expressed in percentages:

	Leaflets		
	(1)	(2)	(3)
Shade branches %	16.6	43.7	39.6 = 99.9
Sun branches %	57.4	42.5	= 99.9

Hence therefore, what happens in *Amherstia nobilis* and in *Brownea grandiceps* also occurs in *Humboldtia laurifolia*, viz. the mature position of each leaflet is determined by the amount of insolation to which it is exposed: that in all these trees this position is arrived at by the amplitude of the daily variation of the periodic movement being influenced by the amount of light which falls upon the leaves. Intense insolation causes great depression of the leaflets, and this depression is not fully compensated by the uprising which occurs normally during the night. Thus it comes about that leaflets exposed, for example, for many days to a bright sun assume more and more a position in which the apex points downward, and as the inherent power of periodic movement wanes the leaflet becomes fixed in this position. If, on the other hand, the leaflet is produced in dense shade the periodic

movement enables it to rise up daily to a fully horizontal position; and, in the absence of the sun's direct influence, after performing its daily swing, the final plane of the leaflet is horizontal. Thus the shaded leaflet makes the most of its leaf-surface, the sun-exposed leaflet adjusts itself doubtless in that position in respect to the sun in which the various functions of the leaf are best fulfilled; in which transpiration is not too excessive, and quite probably also in which assimilation and translocation in the leaflet are most favourably affected by the sun's light- and heat-rays. For Costerus¹ has quite recently shown, or at least gone far towards showing, that leaves of trees are markedly influenced by the sun's rays, in the rate of their assimilation and translocation. In connexion with the ultimate position assumed by the leaves of *Brownea grandiceps*, another factor which may make itself felt is the *directive influence* of light, for, like other dorsi-ventral leaves, those of this tree are dia-heliotropic. Thus three or four seedlings, which had been grown in the diffuse light and whose leaflets were horizontally disposed, were so placed in a room as to be unilaterally illuminated. At the end of fourteen days the leaflets had all arranged their upper surfaces at right angles to the light. To do this not a few had been compelled to rise up so that their apices pointed *upwards* to such an extent that the plane of the leaf made but a very small angle with the vertical.

The effect of this dia-heliotropism is often well marked in leaves of *Brownea grandiceps* trees growing in shady places. In such cases not only do the petioles of the most shaded pinnate leaves rise up more than those exposed to the light, but the leaflets themselves assume positions quite like those taken up by the leaves of such plants as *Veronica Traversi*, *Lamium album*², &c., viz. each pair of leaflets lies in *one plane* at right angles to the incident light.

Consider now to what conditions of insolation these trees of the genera *Amherstia*, *Brownea*, and *Humboldtia*, whose leaves

¹ Costerus, Ann. Jard. Buitenzorg, XII. 1.

² Cf. Physiology of Plants, Darwin and Acton, Fig. 23.

possess means of such accurate adjustment to light, are naturally exposed.

It is noteworthy that this phenomenon of hanging branches occurs in *small trees*. *Brownea grandiceps*, *Brownea coccinea*, and another species, *Brownea hybrida*, grow well in the gardens. The tallest of these is less than forty feet in height; the others are much less. The genus *Brownea* is described in the Treasury of Botany¹ as 'a genus of small evergreen trees . . . peculiar to Venezuela, New Granada. . . .' *Humboldtia laurifolia*, often more a shrub than a tree, is thus described by Trimen: 'A small tree or shrub with numerous horizontally-spreading or rather drooping branches².' *Cynometra ramiflora* is stated by the same authority to be 'a small, moderately sized, much branched tree³.'

Saraca (Fonesia) indica, 'rather small, much branched, spreading tree⁴'; and of the genus *Fonesia* the Treasury of Botany says, 'They are large shrubs or trees of twenty to forty feet in height⁵.' Kurz, in his Flora of British Burmah, gives the height of *Amherstia nobilis* as forty feet⁶.

The only apparent exception seems to be *Calophyllum bracteatum*, a tree peculiar to Ceylon, and rare. Of it Trimen writes 'a large tree⁷.' I did not see a specimen of this tree—a member of the order Guttiferae. Much interest attaches to it in belonging to so widely separated an order from that (Caesalpinieae) to which most if not all other trees with hanging foliage belong. Whether this species grows to the height reached by other members of the genus, 80 to 100 feet, cannot be stated. At present it must be looked upon as an exception to the otherwise general rule, that the trees whose young branches and leaves hang down are *small and spreading*.

¹ Treasury of Botany, Vol. I, p. 173.

² Dr. H. Trimen, Handbook to the Flora of Ceylon, pp. 2, 115.

³ Ibid., Part I, p. 102.

⁴ Ibid., Part II, pp. 111, 112.

⁵ Loc. cit., Part I, p. 633.

⁶ Kurz, Forest Flora of British Burmah, Vol. i, p. 411.

⁷ Loc. cit., Part I, p. 102.

This spreading habit is markedly characteristic of *Brownea grandiceps*, *Brownea coccinea* and other species, of *Saraca indica*, *Cynometra ramiflora*, and of *Humboldtia laurifolia*. The low spreading habit is due to, or at all events is associated with, the fact that these trees, with possibly one exception, are *shade-loving*. According to Kurz both *Amherstia nobilis* and *Saraca indica* are shade-loving trees¹. I have been assured that the species of *Brownea* common to Venezuela grow deep in the jungles, in which case these too (see later) must be shade-loving plants. Trimen² gives the following characters which point toward similar conclusions in other cases: thus *Calophyllum bracteatum*, 'moist, low country in wet forests: ' *Humboldtia laurifolia*, 'damp places in forests, moist, low country.'

The doubtful case is *Cynometra ramiflora*, which, according to Kurz, is a light-loving tree, though Trimen gives its habitat as forests of low country in dry regions. The latter authority informs me that it is more than probable that two species are confounded in *Cynometra ramiflora*, so that the tree with hanging foliage may after all be only an apparent exception to the general rule that these trees are shade-lovers.

All the trees above enumerated, with one possible exception already noted, are small much-spreading and branching forest-trees, which show a marked preference for the shade.

Now, of all trees growing in forests, those which seek such sheltered positions—which grow under the shadow of loftier trees, whose branches, together with the many climbers thereon, make, in a tropical jungle, such a tangled mass of vegetation—are the very last to require special protection against the force of falling rain. Fall the tropic rain never so heavily, its force is spent, broken by the roofing masses of foliage, before it arrives at this arboreal undergrowth. Hence Stahl's view that the hanging branches are an adaptation against the damaging, rupturing effects of heavy rain, cannot, if acceptance be given to the above arguments and observations, be main-

¹ Loc. cit., Vol. i, pp. 411, 415.

² Loc. cit.

to be rendered doubtful; and, in conclusion, to put forward a somewhat more extended view of the significance of this hanging habit. From the observations of the destruction of chlorophyll, of the rates of transpiration, of the shade-loving habits of the trees, it cannot, I think, be doubted that the young leaves are protected by their hanging position. But in addition to this temporary advantage I would suggest an additional permanent advantage—permanent in the sense that its benefit is felt throughout the life of the branch. Beside affording protection to the young foliage, by this habit the branch and its pendent petioles are able to *wait* in a safe position till the conditions of shade or sun, as far as they are determined by the disposition of the young branches of other shoots, can, to use a figure of speech, be ascertained. At all events, during this delay, a step toward the permanent condition of light or shade is being made by the adjustment of other shoots; so that, on rising up, the branch with its leaves meets conditions more akin to those under which it must live than if it had pushed its way horizontally. But still more important is the fact that the pinnate leaves have a far greater range of positions which they can adopt than if they had grown in the normal way, obliquely outward, their basal parts becoming rapidly rigid, so that only their growing apical parts could adjust themselves to changing conditions of insolation. The petiole has, on rising, the power of assuming any position, from one pointing almost vertically downward to one pointing upward. Such a power of responding to differences of external conditions could not exist in a petiole which arose at a certain definite angle with the stem, and whose basal part became rapidly rigid.

By means of the 'waiting' and the rising up of the branch and the petiole, the shoot may be likened in its behaviour to one of the leaflets borne by the petiole: both adjust themselves to a nicety to the prevailing conditions of insolation.

To state the case in another way: the two movements of the shoot with its leaf and of the leaflets may be likened

to a coarse and fine adjustment—to use a comparison suggested to me by Mr. Francis Darwin. The coarse adjustment is effected by the rising up of the petiole, the fine adjustment by the periodic movement of the leaflets. These latter also have the power of temporary adjustment from day to day before and during the uprising of the petiole.

During the hanging of the leaf, when the permanent conditions to which the branch will be exposed are being arrived at, the power of the leaf to assume any position within a range of nearly 180° is possible; and this enables every leaflet of the tree to arrive at its best possible position with respect to insolation.

In addition, then, to the protective value suggested by previous writers, which has been demonstrated in the foregoing paper, I would suggest that the habit under examination has an additional value of *adjustment*; whereby a greater 'choice' of positions is at the disposal of branch and leaf.

Although hunting for teleological explanations may not in itself be a productive task, yet, in so far as these 'explanations' open up new points of view, they are, I venture to submit, the just objects of biological research: thus I would justify the line of argument employed in this paper.

In conclusion, I wish to acknowledge the great kindness shown to me by the Director of the Royal Botanical Gardens of Ceylon, Dr. Trimen, who granted me permission to make use of the gardens and of the laboratory. I also beg to express my thanks to Mr. Francis Darwin, who has aided me in the writing of this paper with much valuable criticism.

EXPLANATION OF FIGURES IN PLATE IV.

Illustrating Mr. Keeble's paper on the Hanging Foliage of
certain Tropical Trees.

- Fig. 1. *a.* Seedling *Brownea grandiceps* grown in diffuse light of a room.
,, *b.* Pair of leaflets of the same for comparison with Fig. 2 *b.*
Fig. 2. *a.* Seedling *Brownea grandiceps* grown for three days in sun; cf. Fig. 1 *a.*
,, *b.* Pair of leaflets of the same.
Fig. 3 (after Haberlandt, *Eine botanische Tropenreise*, p. 118). A young
hanging shoot of *Amherstia nobilis*.

**The Reduction of the Chromosomes in the
Sexual Cells as described by Botanists:
A reply to Professor Strasburger.**

BY

DR. VALENTIN HAECKER,

Zoological Institute, Freiburg-im-Breisgau.

IN a paper communicated to the British Association (Oxford Meeting, August, 1894)¹ Professor Strasburger attempts, first, to prove that in plants the reduction of the number of the chromosomes takes place at a certain point of the generative cell-cycle; and, secondly, to throw light upon the phylogenetic origin of that phenomenon. Convinced that there must be a close parallelism between animals and plants, Strasburger has extended his conclusions even to zoological territory, and generalized some of his theses in this direction. Undoubtedly such a generalization must be the goal which we strive to reach; but in the first place let us see if the facts brought before us by zoological and botanical observers harmonize when carefully examined. Considering the great interest which is accorded to this subject by English botanists,

¹ Compare: E. Strasburger, The Periodic Reduction of the number of the Chromosomes in the Life-History of Living Organisms, *Ann. of Bot.*, Vol. viii, No. XXXI, 1894; Über periodische Reduktion der Chromosomenzahl im Entwicklungsgang der Organismen, *Biol. Centralbl.*, Vol. xiv, Nos. 23 and 24, 1894.

[*Annals of Botany*, Vol. IX. No. XXXIII. March, 1895.]

one may perhaps be justified in directing their attention to the results attained by German zoologists.

I will confine myself in the following pages to the two questions;—at which point and in what manner the reduction of the number of the chromosomes takes place.

Strasburger attempts to show that in the Angiosperms 'the reduction takes place directly, both in the mother-cells of the pollen and in the mother-cell of the embryo-sac, and in such a manner that the reduced number of chromosomes is at once apparent in the prophase-stage.' The reduced number is retained during the subsequent divisions until the formation of the nucleus of the ovum and of the spermatid nucleus. Then the original number of chromosomes is re-established by the union of both elements.

To give an example, Guignard has shown that in *Lilium*, in all the nuclear divisions which are to be found in the pollen-sac and in the ovule, twenty-four chromosomes are visible. The framework of the resting nucleus of the pollen-mother-cell and of the embryo-sac mother-cell is therefore constructed of twenty-four chromosomes; yet in the next prophase it nevertheless uniformly gives rise to only twelve chromosomes.

How is this reduction accomplished? Strasburger inclines towards the theory of the individuality of the chromosomes—that is to say, he would like to assume that these are 'always the same chromosomes, which make their appearance over and over again in the repeated divisions.' Therefore he assumes, in order to explain the direct 'reduction,' that the diminution of the number of chromosomes by half is due to the fusion into one of two chromosomal individuals.

I believe that by assuming such a fusion the process of reduction is robbed of all theoretical significance, as far as such significance bears upon the theory of heredity. But I will not touch on this question, preferring rather to keep to the main subject.

Strasburger believes it to be proved that also in the mother-cells of the ova and spermatozoa of animals the reduction

is accomplished in the same manner as it seems to him to take place in Phanerogams. The reduction in animals takes place, as he thinks, in the mother-cells, and the chromosomes therefore already appear in the reduced number at the beginning of the two maturation-divisions. Each of the chromosomes undergoes double longitudinal splitting, by which they are prepared *at the same time* for *both* divisions. He believes, however, that there exists a complete homology between the botanical and zoological observations. Strasburger even asserts decidedly that reduction-divisions (*Reduktionstheilungen*) in Weismann's sense do not exist, either in plants or anywhere¹, that is to say, such divisions in which the re-partition of the chromosomes takes place *without* a preceding longitudinal splitting.

The question is, if the matter can be settled in this way or not. With regard to the literature relating to this subject, Strasburger refers us to his work, 'Schwärmosporen, Gameten, pflanzliche Spermatozoiden und das Wesen der Befruchtung.' This work was published in 1892. During the last years, however, a series of papers² have been published which promise a solution of the problem of reduction in a perfectly contrary direction.

In these papers it is partly indirectly concluded from comparison with other processes of division, partly proved by direct observation, that the two maturation-divisions are not introduced by a double longitudinal splitting, but only by

¹ Compare Über periodische Reduktion u. s. w., Biol. Centralbl., xiv. p. 851. In the English translation, Annals of Botany, viii. p. 310, Strasburger more cautiously says, 'Such divisions do not take place among plants.'

² (1) O. vom Rath, Zur Kenntniss der Spermatogenese von *Gryllotalpa vulgaris*, Latr. Arch. f. mikr. An., V. 40, 1892; (2) V. Haecker, Die heterotypische Kerntheilung im Cyklus der generativen Zellen, Ber. Naturf. Ges. Freib., V. 6, 1892; (3) V. Haecker, Das Keimbläschen, seine Elemente und Lageveränderungen I, Arch. f. mikr. An., V. 41, 1893; (4) O. vom Rath, Beiträge zur Kenntniss der Spermatogenese von *Salámandra maculosa*, Zeitschr. f. wiss. Zool., V. 57, 1893; (5) V. Haecker, Über generative und embryonale Mitosen, Arch. f. mikr. An., V. 43, 1894; (6) J. Rückert, Zur Eireifung bei Copepoden, Anat. Hefte, V. 4, 1894; (7) J. Rückert, Die Chromatinreduktion bei der Reifung der Sexualzellen, Ergebn. d. An. und Entw. (Merkel u. Bonnet), V. 3, 1894.

a single one; and, further, that the second division is accomplished in this way—that every two elements, lying *one behind the other* in the original chromatic thread, are distributed in the two nuclei.

I should like to repeat a scheme, of which I have made use in a former paper and which has lately been also accepted by Rückert. If we signify the chromosomes (Idants of Weismann), lying one behind the other in the connecting thread, by a, b, c, d, \dots , the scheme of the longitudinally split thread is written thus:

$$\frac{a\ b\ c\ d\ \dots}{a\ b\ c\ d\ \dots}$$

For example, if the 'normal' number of chromosomes is twenty-four, the scheme is the following:

$$\frac{a\ b\ c\ d\ \dots\ wx}{a\ b\ c\ d\ \dots\ wx}$$

When the generative cell begins the process of division, from this thread are separated the well-known tetrads (*Viererguppen*):

$$\frac{ab}{ab}, \frac{cd}{cd}, \dots, \frac{wx}{wx}$$

In the *first* division they are disjoined in this way:

$$\begin{array}{ccc} \text{I. } ab & cd & wx \text{ (= egg-nucleus)} \\ \updownarrow & \updownarrow & \updownarrow \\ \text{II. } ab & cd & wx \text{ (=first polar body).} \end{array}$$

In the second division the double elements are disjoined into their units (reduction-division). From every pair, therefore, one element passes into the one nucleus, the second into the other. It has not yet been decided if there is a constant rule in the distribution, and I think it will never be decided; but we could assume, for example, that the distribution takes place in this way:

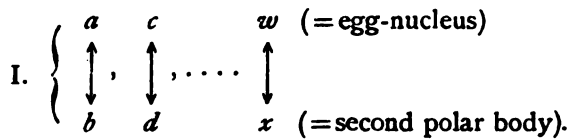

That the formation of the tetrads is accomplished in the manner above mentioned is clearly shown, chiefly by the observations of vom Rath and Rückert. I myself shall shortly be able to demonstrate the process by a specially typical case, and to show that, even if there exist certain variations, the principle of the process remains the same¹.

Thus it is permitted to assume, as a matter of fact, that reduction-divisions exist in the generative cells of animals. It may be even asserted as highly probable that their occurrence in the formation of the ova and spermatozoa of animals is a general phenomenon². Thus it is a fact that at present the observations of the botanists and zoologists do not agree at all, and therefore cannot form a common basis for theoretical conclusions.

In making a generalizing theory, however, one is either obliged to enforce the observations of the one or the other side, or at least to assume incompleteness of observation. The zoologist will propose to himself two questions: first, if perhaps some of the figures given by botanists resemble the processes of reduction observed in animals, so that it may be assumed that the botanists have possibly overlooked certain stages; and, secondly, if the kind of direct diminution of the chromosomes, as described by the botanists, is also to be observed in the generative cells of animals.

With regard to the first question I venture only to make one supposition. The figures which Guignard³ has given for the first division of the pollen-mother-cell (compare Figs. 12,

¹ Compare Die Vorstadien der Eireifung, Arch. f. mikr. An., V. 45, 1895.

² There is at the present day only one observation which directly opposes this generalization. Compare A. Brauer, Zur Kenntniss der Spermatogenese von *Ascaris megaloccephala*, Arch. f. mikr. Anat., V. 42, 1893.

³ L. Guignard, Nouvelles études sur la fécondation, Ann. d. sc. nat., Bot., 1891.

13, 14) and of the embryo-sac-mother-cell (Figs. 50, 52, 54) of *Lilium Martagon*, differ considerably, as every botanist will agree, from the figures shown in other divisions of plant-cells. Every one who has studied the phenomena of maturation in Arthropods, the changes of the chromatin in the germinal vesicle and the processes preparing the formation of the tetrads, thinks involuntarily of these observations while contemplating Guignard's figures¹. And so I believe if a true reduction of the chromosomes takes place anywhere in the generative cell-cycle of plants it must exist there. At all events the zoologist is justified in doubting if all possibility of misinterpretation of the results obtained by the botanists is excluded, as Strasburger believes, at least so long as we are presented only with botanical investigations, which are interpreted without knowledge of the newer zoological facts.

The second question which has been mentioned seems to be already solved. Divisions in which a diminution of the number of the chromosomes takes place during the resting-stage of the nucleus are well known to zoologists, at least they occur in embryonic cells, and chiefly in the generative cell-cycle. But it has been already shown, at least in several cases, that the reduction of the number of chromosomes is only apparent; that is to say, it could be demonstrated that during the prophase pairs of elements remain joined one with the other, and that they are only separated in the later stages. After this phenomenon had been established for special cases, it was easy to regard other divisions also in which half the number of chromosomes appears, chiefly the so-called 'heterotypic' divisions, as 'plurivalent' divisions; that is to say, as divisions in which each element is composed of two normal elements. I made this attempt some time ago, and vom Rath and Rückert have accepted this assumption. Rückert has proposed for such cases the term 'pseudoreduction.' It would be too detailed to prove that assumption

¹ Compare J. Rückert, Zur Eireifung bei Copepoden, tab. XXI-XXII (Ovogenesis in *Cyclops strenuus*).

anew, but it would be, perhaps, interesting if botanists would weigh the possibility of the reductions observed by them being perhaps only 'pseudo-reductions.'

In a former paper¹ Strasburger has pointed out that botanists and zoologists who are studying the processes of cell-division must work together. In regard to the problem of reduction, this relation seems to be lost for the moment ; but I doubt not that a few happy discoveries will suffice to rehabilitate the close parallelism between the animal and vegetable kingdoms.

¹ E. Strasburger, Zu dem jetzigen Stande der Kern- und Zelltheilungsfragen ; *Anat. Anz.*, 1893.

On the Comparative Anatomy of certain Species of the Genus *Christisonia*

BY

W. C. WORSDELI.

—♦—
With Plates V and VI.
—♦—

THREE species of the genus *Christisonia* were investigated: two of these, *C. bicolor*, Gardn., and *C. subacaulis*, Gardn., occur in Ceylon, the third, *C. neilgherrica*, Gardn., in the Neilgherry Mountains of India. They are parasitic plants. As may be inferred from their mode of life, they are of a reduced or modified type of plant-structure, as regards the vegetative parts. These latter consist principally of a branching, subterranean, rhizome-like structure, which is perennial, persisting from year to year in the substratum, and obtaining nourishment by attacking the roots of the Bamboo or *Strobilanthes*, amongst which they penetrate and intertwine. From the underground parts are sent up the short stems at intervals along the surface, which at first bear scale-leaves, and eventually, when mature, a number of flowers at the summit (Fig. 1). The growth of the aerial parts is very rapid: within a fortnight the seeds are shed and the stems and fruits (in *C. subacaulis*, Gardn., at least) decay away in a mass of mucilage.

[Annals of Botany, Vol. IX. No. XXXIII. March, 1895.]

As regards the subterranean parts, it is at first rather difficult to determine what their morphological nature really is, whether they are roots or stems; externally they have very much the appearance of underground stems or rhizomes, and, moreover, the anatomy of this organ in one of the species (*C. subacaulis*, Gardn.) afforded no evidence either way, as, owing to the parasitic habit of the plant, the typical structure had become considerably modified and obscured; many of the apical parts also showed no evidence of any root-cap. It was only by the occurrence of a typical root-structure in the central cylinder of *C. bicolor*, Gardn., and by the discovery, in both species, of a genuine root-cap at the apex, that the real nature of this organ was eventually decided upon. The absence of any foliar appendages also confirms this decision.

These *roots* anastomose together by fusion of adjacent parts so as to form a complex network (Fig. 2). This may be compared with the similar phenomenon in the roots of *Ficus* and *Clusia*, and also in the lower plants, e.g. Fungi; and serves, perhaps, to ensure a better distribution of nutriment throughout the root-system. In *C. subacaulis*, Gardn., tuberous portions of the root occur here and there: they are always the centres of attachment between the parasite and the host, the haustoria arising here (Fig. 3). In *C. bicolor*, Gardn., these tubers are absent, or the root, at corresponding places, only becomes swollen to a slight extent. Where they occur the tubers appear to serve as stores of nutriment and as centres from which root-branches and stems grow out in various directions.

C. bicolor, Gardn.

This plant is parasitic on the roots of a species of *Strobilanthes*. Portions of the parasite are attached as tiny plants here and there on the finer branches of the host-roots, but they may also be found attached to the thicker portions. The long, rhizome-like branches of the root also send out haustoria where they happen to be in contact with a host-root.

This plant is much more slender in all its parts than

C. subacaulis, Gardn., which it more nearly resembles than *C. neilgherrica*, Gardn. It is, however, of a more typical and normal structure than the former species, and for this reason I have chosen to describe it first.

The *roots* anastomose together to form a complex system, but in a less striking degree in this plant than in *C. subacaulis*, Gardn. The tubers, so characteristic of the latter plant, are absent in this species.

The roots may be described as long, wiry, rhizome-like organs, of small diameter, which send out at frequent intervals on the surface round, knob-like structures. These are the young stems. The roots branch freely and grow rapidly in all directions in the substratum.

Anatomy of the Root.

In a transverse section of the root (Fig. 4*b*) the outer layer of cells is seen to consist of small elements with thick outer walls, usually of a brownish colour, with granular matter, probably soil, attached to them.

The *cortex* is built up of rather large cells, which in the outer portion are compactly arranged; the inner portion of the cortex consists of much looser tissue, the rounded cells exhibiting very numerous intercellular spaces. Nearly all the cells of this region have their walls extremely thickened or mucilaginously swollen where they border on an intercellular space, although the thickening may sometimes occur on opposite sides of the common wall of two cells (Fig. 4*b*). These thickenings were found to stain with methylene-blue, Hoffmann's blue, and aniline violet; they are more or less half-moon or crescent-shaped, with a very convex surface towards the cell-cavity. The mycelium of a fungus was seen to occur occasionally in the cortex. The cells are often full of starch-grains.

Closely surrounding the central cylinder is a zone, one to three layers thick, of small *stone-cells*, of which some are considerably larger than the rest; the root, however, exhibits some variation in the number of these elements in this region.

There is a distinct *endodermis* present, which is clearly differentiated on treatment of the section with strong sulphuric acid. It consists of a slightly sinuous layer of small, compactly-arranged cells immediately outside the cylinder.

The *pericycle* is not so clearly distinguishable, and appears as if interrupted here and there by phloëm-elements. It is one layer in thickness. There is considerable variation in different roots in the structure and general appearance of the *central cylinder*. In some roots the typical radial arrangement is very clear; the small protoxylem elements lying at three, four, or five points on the periphery, entirely separating the phloëm into as many groups (Fig. 4 *b*); in others, however, the phloëm-groups show a tendency to unite continuously to form a peripheral ring. The central part of the cylinder is usually occupied by a few xylem-elements and parenchyma; in many roots, however, the entire central part consists of small, compactly-grouped stone-cells, which here, apparently, replace the xylem-elements, the latter having, in these plants, a very rudimentary development. In those roots which are destitute of the central strand of stone-cells, the xylem-elements are fairly numerous; in those in which the stone-cells occur, they are fewer in number and greater in diameter, the phloëm being also much more developed. Another form of root-structure in this plant is that in which the xylem-elements are considerably larger, more conspicuous, and more numerous than in the ordinary type; in such roots the phloëm is developed to a remarkable degree, and occupies, not only the peripheral portion of the cylinder, but also the *entire* central region, where the pith would normally occur. This seems a strange occurrence, but the elements composing the central portion had an appearance identical with those of the periphery, consisting of sieve-tubes and companion-cells¹. The phloëm-elements are, like those of the xylem, much larger and more conspicuous than in the

¹ Cf. Scott and Brebner, *Anatomy and Histogeny of Strychnos*, *Annals of Botany*, Vol. iii., 1889. Also Scott and Sargent, *On the Pitchers of Dischidia rafflesiana* (Wall.), *Annals of Botany*, Vol. vii., 1893.

normal form. The xylem-elements of the root may be either tracheides or vessels; both kinds of elements occur indiscriminately, and are rather difficult to distinguish the one from the other. If the element be a vessel, the perforation may either occupy the whole surface of the terminal wall or the latter may be reticulately thickened, the perforations, which are of varying sizes, occurring between the reticulations. That tracheides, as well as vessels, are present, was inferred from the occasional occurrence of a delicate membrane stretching across the terminal wall, its presence being indicated by the minute granules scattered about on the latter; this was found between two xylem-elements, as well as where one of these abutted on a parenchyma-cell.

The *phloëm* offers nothing specially worthy of remark; it consists of sieve-tubes, companion-cells, and parenchyma.

In longitudinal section the cells of the external layer appear narrow and elongated, and this is also the character of the outer cortical cells. The inner cells of the cortex are shorter and broader, and usually contain starch. Where there are stone-cells surrounding the central cylinder, these are of varied shapes; they are usually short and rather narrow, sometimes quite square and broad, sometimes irregular in shape. The phloëm parenchyma consists of broad, rather long cells, often filled with dense protoplasmic contents with large vacuoles. The sieve-tubes are well developed, their terminal walls are either transverse or slightly oblique; the sieve-plate with its perforations is clearly distinguishable, and there is a well-marked callus-layer below.

The *companion-cells* are numerous: they are either small elements, extending only part of the way along the sieve-tube, or they may be narrow elements, cut off along the whole mature length of the former.

On the periphery of the cylinder are seen the long, spirally thickened protoxylem-elements, which are very narrow in diameter. The later-formed xylem-elements are usually quite short; most of them show some amount of sliding-growth, as the terminal walls are often oblique. As might,

perhaps, be expected from the reduced nature of this tissue, the vertical rows of xylem-elements are frequently interrupted and cut off by parenchyma, the continuity of the series being maintained by an oblique connexion with other elements of a different vertical row—the perforation between the two connecting elements being thus often in their lateral walls. The terminal walls of these elements, usually seen in section, appeared to show in nearly every case evidence of one or more perforations. With the exception of the protoxylem, all the elements are reticulately thickened.

The *stone-cells*, occupying the centre of some roots, are narrow, much elongated elements; being so conspicuously developed here, I, may suggest for them a function, which consists in resisting longitudinal tension-strains set up by the separation, on maturing of the flowering-stems, into distinct plants of the subterranean root-system.

The *apex of the root* (Fig. 11, *C. subacaulis*, Gardn.) shows a differentiation into three layers, viz. plerome, periblem, and a common layer for the dermatogen and root-cap. The apices of some roots examined showed no distinguishable root-cap whatsoever.

Lateral roots arise from the central cylinder, and most probably from the pericycle, though their exact origin from this layer was not ascertained. The youngest stage observed was where the young organ was about two or three layers of cells distant from the cylinder. As the young root gets older its origin becomes more obscure, as its cortical cells, though mostly traceable in radial rows back to the central cylinder, appear at the same time not sharply defined against those of the parent-root; the sharp line of demarcation between the young root and the ground-tissue of its parent extends only a short distance from its tip (Fig. 19) on either side; this gives rise to an appearance as though the lateral root had a cortical origin, instead of a pericyclic one as is probably the case. Fig. 19 shows a section of a lateral root at the stage where it is about to burst through the external layer; it is seen to possess a well-marked root-cap (*rc*) of a single layer of

cells. After the young root has emerged from the cortex of its parent and begins to grow rapidly in thickness nearly all traces of its endogenous origin become obliterated, indeed it is often very difficult to tell at the mature stage whether it is with a case of exogeny or endogeny that one has to deal; it was only after careful scrutiny and the discovery in most, if not all, cases of a short flap of two or three layers of cortical cells (the evidence of rupture), that the typical endogenous origin of these root-branches was determined. In the development of a branch, the cortex of the parent-root often becomes very much bulged out, so that the flap just mentioned comes to lie at some distance along what appears at first sight to be the basal part of the lateral member itself. The place of origin of a rootlet, at the stage shown in Fig. 19, is indicated by minute swellings on the external surface of the root, caused by the raising of the cortex at those points.

The *stem*, as has been stated above, arises from the root. It is of *endogenous* and probably also of pericyclic origin. Like the lateral root, its origin becomes obscured as it advances in age, so that it gives the impression of arising from the second or third layer of the cortex, reckoning from the outside. An examination of Fig. 20, however, which is drawn from two sections of the root of *C. subacaulis*, Gardn., will reveal pretty plainly the real origin of this organ from the region of the central cylinder. It is a much broader outgrowth than the young root, with a flatter and broader apex, which region is seen to be covered by the first two young leaves (*l*). Unlike the root, its sole mode of piercing the cortex is the mechanical one of pushing a path for itself through the surrounding cells. As the stem grows outward and finally bursts the outermost cortical layer, the successive young foliar organs are rapidly produced; these give the rounded, knob-like character to the young stems as they appear scattered on the surface of the root. When the young stem has attained to about one-fourth of an inch in length it often gives rise to adventitious structures, which are roots and arise endogenously; they grow down into the substratum.

As above stated, these plants are *parasites*; they obtain their nourishment, therefore, by means of *haustoria*, which penetrate the living tissues of other plants; the roots serve, not, as in most other plants, for the absorption of water and mineral substances from the substratum, but as store-houses of nutriment, for the production of the flowering-stems, and for the perennation of the plant and the extension of its area from year to year. The stimulation to formation of a haustorium is caused by direct contact of the root with that of the host-plant, which, in this case, is a species of *Strobilanthes*. The external layer of cells at the point of contact divides in places, and the cells for some distance on either side become elongated radially, while they become filled with dense protoplasmic contents, and exhibit conspicuous nuclei; at the same time, the cortical cells immediately below this layer divide rapidly in several directions, while a few divisions occur in those more deeply situated. As a result of this, the initial stage of haustorial formation, the cortex becomes considerably bulged out, as seen in transverse section (Fig. 21). A few of the cells, on either side of the point of contact, grow out into hair-like papillae, which possess a thick cell-wall and dark-brown contents with a prominent nucleus. These grow towards the host-root. The portion of the cortex at the point of contact at length, by repeated divisions in the cells, grows out as the haustorium. This new organ, by the aid of its external layer, dissolves its way by fermentative action into the tissues of the *Strobilanthes*. That portion of the root of the parasite around the point of penetration becomes applied firmly to the surface of the attacked root, the cells in contact being much elongated and more or less contorted in shape, with dense contents. As the haustorium advances inwards towards the centre of the host-root, the effect of its work of absorption of food-substances from the living tissues of the host is shown by the distinct zone of cortical cells extending from the haustorium to the central cylinder of the parasite, which are densely filled with starch-grains (Fig. 22); this zone is best

seen in a section not quite median, which does not pass through the vascular strand; the latter becomes differentiated as the haustorium grows out from the cortex, and eventually, when it reaches the central cylinder of the host, a continuous chain of xylem-elements is laid down, extending from the central cylinder of the root of the parasite, through its tissues and those of the haustorium, to where a direct union is effected between the vascular tissue of the haustorium and that of the central cylinder of the host-root. The main portion of the haustorium is built up of slightly elongated cells, with dense contents and conspicuous, large nuclei. Their function may consist in the conduction and storage of proteid matter. No sieve-tubes were anywhere discovered. The haustorium sometimes occupies almost the entire diameter of the host-root and destroys a large area of its tissues. The haustoria attached to one piece of root were all completely filled with dark *fungus-spores* and hyphae, which also occupied part of the tissues of the host-root, as well as a few of the cortical cells of the root of the parasite; they were sufficiently numerous to interfere with the work of the haustorium in absorbing food from the host.

From the above description of the development of the haustorium, it will be seen that it is of *exogenous* origin (Fig. 22); there is no evidence to show that it arises from any of the internal layers of the cortex; it appears simply to be formed by a direct outgrowth from the surface of the root, as is the case in the roots of *Rhinanthus*, and not in the mode described for *Cuscuta*¹ and others.

Anatomy of the Stem.

A transverse section of the *stem* shows an almost complete ring of vascular tissue; the band is broken at the place of insertion of the leaf-trace bundles, two or three of which

¹ On the Structure of the Haustoria of Phanerogamic Parasites, by G. J. Peirce; Annals of Botany, Vol. vii. No. 27. A Contribution to the Physiology of the Genus *Cuscuta*, by G. J. Peirce, Annals of Botany, Vol. viii. No. 29.

appear rather further on the outside. The vascular tissue is ensheathed, on both inside and outside, by a thick zone of *stone-cells*, which gives a characteristic appearance to the structure. The epidermal cells are small. No stomata were observed. The outer part of the cortex consists of rounded cells exhibiting small intercellular spaces. The bundles of the central cylinder are arranged in close contact one to another, being separated only by a narrow zone of parenchyma. Both xylem and phloëm are fairly well developed. A distinct *cambium* is present, giving rise to slight secondary thickening in the ring. An endodermal layer could not be clearly distinguished; only a few cells here and there showed evidence of having cuticularized radial walls. The cells of the pith are full of starch.

In a longitudinal section the cortical cells appear compactly arranged, with small intercellular spaces between them, in which a fungus, which we shall find to be a constant feature in the root of *C. subcaulis*, Gardn., rather sparingly occurs. The stone-cells of the cortex and the pith are more or less elongated and rectangular, or have pointed ends. The remaining pith-cells are rather elongated and full of starch.

The stems bear *scale-leaves*, which occur either in pairs decussately arranged or alternately; there is nothing special to mention about the anatomy of these.

A few flowers are borne at the extremity of the stem, each in the axil of a bract (Fig. 1).

Structure of the Flower.

The *calyx*, which is pink in colour, is gamosepalous, with five, free, equal segments above; it is considerably shorter than the *corolla*. The latter is gamopetalous, consisting of a tubular portion and five, free, irregular segments above, which go to form a sub-bilabiate structure.

The cells of the *petal* are loosely arranged, and there is evidence of sliding-growth amongst them; the epidermal cells are slightly papillate on both surfaces.

The calyx and corolla both bear short secretory glands. These glands supply the mucilaginous covering to these parts, which serves, perhaps, as a protection against the attacks of crawling animals, which must abound in the neighbourhood of these plants.

The *stamens* are four in number. They are epipetalous. The four *anthers* are united together. A transverse section of the anther shows in the young stage a bilocular construction, each loculus being more or less crescent-shaped, owing to the projection into the cavity of a broad, conical band of sterile tissue from the connective. A single layer of radially-elongated tapetal cells lines the cavity. The pollen-mother-cells divide tetrahedrally to form pollen-grains; occasionally a cruciate division was observed. The external layer of the wall of the anther consists of rounded, thick-walled cells; when the pollen-grains are ripe, the partition-wall between the two loculi breaks away, so that the anther thus becomes unilocular; the soft-celled inner layers of the anther-wall shrivel up, while the external layer of thick-walled cells remains intact, and scarcely ever broke when the anther was cut.

The *stigma* is a wide, expanded surface, covered with papillate, hair-like cells, which are much elongated and pointed; their tips, however, being obtuse and rounded off. The subjacent tissue is quite loose.

The *style* possesses two bundles on opposite sides of a central cavity, which in the upper part of the organ is filled with much-elongated cells whose cavities are widely separated by their mucilaginously-swollen walls.

The *ovary* consists of two carpels, and is unilocular throughout. The placentation is parietal, consisting of two opposite bi-partite placentas expanding into the ovarian cavity and almost filling it. They bear over their surface very numerous anatropous ovules, which are embedded in mucilage and are extremely small.

C. subacaulis, Gardn.

This plant is much more reduced than either of the two other species investigated. It is parasitic on the roots of the *Bamboo*, amongst the thick, tangled masses of which its own roots vegetate in a mutually anastomosing network. The subaërial part is extremely mucilaginous, much more so than either of the other species; at the end of the season this character becomes more marked, till the whole becomes resolved into a decaying, mucilaginous mass. A purple substance occurs throughout the entire plant, especially in those parts active in secreting a ferment.

The general morphology of this plant is similar to that of *C. bicolor*, Gardn., so that I may at once proceed to describe the anatomy.

Anatomy of the Root.

As seen in a transverse section, the external layer of the cortex consists of small cells, usually with conspicuous nuclei, and thick brown walls, both on the inner and outer sides. The main cortical tissue consists, especially in its inner portion, of large, rounded cells, containing, usually, very numerous compound starch-grains. Owing to the loose arrangement of these cortical cells, there is a conspicuous intercellular system; in the spaces thus formed a fungus occurs; it is *constantly* present, as shown by its reappearance in every root or portion of root examined. The exterior surface of the cell-walls are lined with its hyphae, from which conidia-like bodies jut out into the space; these arise from an excessively short stalk, from which two, three, or a larger number of conidia are abstricted off (Fig. 26); these fall on the wall of the cells (Fig. 27). But, besides these smaller bodies thus formed in such numbers, there may be observed larger, spore-like bodies, of a dark brown colour; these appear each on the end of a stalk and inclined to one side of it, that portion of the stalk immediately below it appearing rather swollen. At more advanced stages two of these

neighbouring or even opposite out-growths or stalks are seen to fuse together at the apex, where a rounded body, like those already described, appears, which becomes at length much swollen, and from which, as it eventually disintegrates, short filaments are seen emerging. It is possible that we have here a case of zygospore-formation in the fungus. If the sections are placed overnight in a solution (one per cent.) of gold chloride, then washed, and allowed to remain some time in citric acid in the sunshine, the protoplasm of the fungus stains a dark purple colour. Although the fungus is essentially intercellular in its distribution, hyphae were occasionally observed in some of the cortical cells, and are sometimes seen passing through the pits into a stone-cell.

An *endodermis* could not be distinguished ; it would appear to be more or less interrupted by the aggregation of stone-cells in the region where it is usually sought. On treatment of a section with strong sulphuric acid the whole of the cortex is destroyed with the exception of the stone-cells, two or three of the outermost layers, and the fungus in the intercellular spaces. The cell-walls bordering on these spaces appear also uninjured, as if they were cuticularized ; this they possibly may be, in order to prevent the inroads of the fungus into the cell-cavity.

We come next to the structure of the *central cylinder* ; in this plant its typical radial arrangement is quite obscured, owing to the greater development of the phloëm, which here forms a continuous outer zone, and the reduced and rudimentary state of the xylem, which often consists of only a few elements occupying the centre of the cylinder or scattered irregularly here and there amongst the parenchyma (Fig. 4 a) ; sometimes one or two elements can be traced further out between the phloëm-elements, and these appear to represent the protoxylem, though no elements of small diameter, so characteristic of the protoxylem elsewhere, are present. From this very modified structure it thus becomes difficult or impossible to ascertain what is the real arrangement of the cylinder. The xylem-elements consist of both

tracheides and vessels, the terminal walls having sometimes one or two conspicuous perforations, at other times only a few scattered pits. Parenchyma occurs abundantly around and among these elements. Sieve-tubes, companion-cells, and phloëm-parenchyma are irregularly arranged in large numbers, forming a well-developed tissue.

The *stone-cells*, which constitute a very characteristic tissue in the root of this plant, are of considerable diameter. They are scattered irregularly throughout the cortex; round the cylinder they occur in greater quantity, often in groups of several together; here they may have very thick walls.

A small portion of the root, chiefly some of the outer cortical cells, is often injured or destroyed by the invasion of a fungus, whose dark brown spores fill the cells in large numbers.

In a longitudinal section the cortical cells of some roots appear elongated; in most, however, they are isodiametric. The intercellular spaces are often filled with a brown substance, which is probably connected with the fungus above described.

The sieve-tubes and companion-cells are very abundant; the former are of various sizes; of these the innermost are quite short, and differ from the companion-cells which are cut off from them only in shape; those further to the outside are much longer—they have either transverse or slightly oblique terminal walls, on which are several sieve-plates; there is always a conspicuous callus-layer below the plates, which stains well in aniline-blue and Hoffmann's blue. Sieve plates also occur on the lateral wall between two sieve-tubes; none were observed between the latter and companion-cells. The younger sieve-tubes have protoplasmic contents and a conspicuous nucleus.

The *companion-cells* are cut off from the sieve-tube either in regular, uninterrupted, vertical rows of narrower or broader cells or they may occur isolated, with a curved wall bulging out towards the cavity of the sieve-tube, and having more or less pointed ends. They are either quite small elements

or of considerable size, having usually very dense protoplasmic contents in which occur many large vacuoles. The mode in which they are cut out of the sieve-tube often gives that element a peculiar bent and curved appearance. There is frequently an appearance as if a companion-cell was cut off on each side of the same sieve-tube; in some, these three cells are equal in length, the two lateral ones having denser contents than the middle one; in others, the middle cell is longer and more trumpet-shaped, overtopping the two lateral ones at either end and expanding above them. This suggests that the middle segment of the original procambial cell has grown in length to become the sieve-tube, while the two sister-segments remain behind as companion-cells. The sieve-tubes are often arranged in regular radial rows for some distance.

The parenchyma-cells are wide, elongated elements.

The *xylem-elements* are usually very short, with transverse or sometimes slightly oblique terminal walls; often they are more elongated. They have reticulate thickenings. Their course is the same as that described in the last species. On the outside, nearest the phloëm, are the protoxylem-elements, which are more elongated than the others, while their thickenings are partly spiral, partly reticulate; they are not very typical for protoxylem, but are rather transitional in character between this and the later-formed elements. The perforations in the terminal walls of the vessels are in this plant distinctly seen in sectional view.

The outermost *stone-cells*, scattered in the cortex, are short and more isodiametric in contour, and are isolated. Those immediately surrounding the central cylinder are usually very much elongated, thick walled, and massed together in groups.

In some places the roots show a slight swelling, which is the commencement of the large, thick, tuberous portions of the root which are so common.

These *tubers* occur at frequent intervals in the root and are very characteristic of this species. If a section be made

through one of these tubers so as to pass through the root-cylinder, this latter will be seen in one part of it in either transverse or longitudinal section. The cortex has the same character as that of the root, containing starch-grains, &c. Besides the root-cylinder there will be seen one, two, three, or many bundles, which have a peculiar and striking appearance; they are usually seen in transverse section; in the centre are a few obscure xylem-elements; surrounding these is a small zone of cells with very dense protoplasmic contents and conspicuous, large nuclei. These last-named cells are more or less isodiametric and angular, and when seen in longitudinal section are scarcely elongated; the cells on their immediate outer limit, however, are rather more elongated and have not such dense contents. Outside these, again, is a conspicuous zone of cells with rather larger lumen and much clearer contents, containing much smaller yet distinct nuclei. Then follows an irregular grouping of cells, surrounding the last zone, with prominent dark nuclei and dense proteid contents. The first-described zone of dark-coloured cells, with the central xylem-group, represents the bundle; this is always accompanied, however, by the two zones of cells last described (Fig. 5). These 'proteid-bundles' traverse the tuber in various directions, and may be seen running parallel to the root-cylinder or crosswise and at right angles to the latter. In some tubers all the cells of the ground tissue have very conspicuous nuclei; while in most this is not the case, though the cells of the external layer are always thus characterized. Large agglomerations of stone-cells also occur throughout the cortex.

In every case, when one of these tubers is examined, it will be seen that there is a portion of a Bamboo-root attached to it at some point (Fig. 3). If a series of sections be taken through a tuber, the 'proteid-bundles' can be traced till they eventually bend outward, and, two or more fusing together into one, enter a *haustorium* which is penetrating the host-root. Thus, the haustorial bundle, on entering the tuber, instead of passing directly to the central cylinder, branches,

usually, into two or more diverging bundles, which dip away into the cortex. These 'proteid-bundles,' from the above description of their structure, perhaps act as storehouses for the spoils of the haustorium. By traversing the greatly-enlarged cortex in all directions they aid in distributing the nutriment through the tissue of the tuber so formed, thus supplying the young lateral roots and stems, which so frequently have their birth in this organ, with abundance of food-substances. The xylem of these bundles eventually unites with that of the root-cylinder, which—so filled does the tuber become with the 'proteid-bundles'—is often scarcely distinguishable in some obscure corner. The tuber thus becomes the most important centre of the plant, as the place of origin of the haustorium (which I am about to describe), the storehouse of the food-substances derived by its means, and the birthplace of many young roots and stems.

The *haustorium* is of *exogenous* origin, being formed by a superficial outgrowth from the tuber. The Bamboo-root may be attached for about an inch along the surface of a tuber (Fig. 3), several haustoria being sent into it. Most frequently it was found attached at a single narrow point with a single haustorium attacking it. The cells of the external layer of the root adjacent to the haustorium, or those at all contiguous to the host-root, some of which are produced into papillae, or grow out together to form multicellular protuberances, have, usually, thick outer walls of a dark-brown tinge. They serve to attach the root of the parasite to that of the host.

The lateral and apical cells of the haustorium have purple contents and conspicuous nuclei, and are very active in dissolving the cortical cells of the host; the latter, surrounding the haustorium, are often densely filled with starch-grains; these also occur in numbers in the cortical cells of the haustorium, and also become stored up in the tuber. The xylem of the haustorium consists of slender, narrow, spirally-thickened elements; surrounding these are slightly elongated cells with dense protoplasmic contents and very prominent

nuclei ; no sieve-tubes were ever seen. There is a well-marked cortical region in the haustorium of this species.

Having entered a Bamboo-root, the haustorium may either grow straight through the cortex and penetrate directly, with its apex, the central cylinder (Fig. 6), or, having entered the cortex of the host, may branch, the branches bending at right angles to the cylinder or running parallel to it through the cortex (Fig. 10). As a haustorial branch thus pursues its course through the inner region of the cortex, some of its lateral cortical cells in contact with the central cylinder acquire dark purple contents, and begin to dissolve the cells lying against it ; this fermentative action goes on until a cell, having opened out a cavity in the conducting-tissue of the host, grows out into it as a papilla or sucker ; this cell has fine granular contents, and dark lines in the convex portion of its wall, which look like pits ; by these lateral suckers a large portion of the cylinder becomes destroyed (Figs. 7, 8, 9). In Fig. 6, which represents a haustorium directly penetrating the central cylinder of the host, the xylem-elements and their accompanying proteid-cells are seen to be in contact with and spreading among the conducting elements of the cylinder.

The *lateral roots* are of *endogenous* origin, as indicated by the projecting flap of cortical cells, already referred to, nearly always found on either side of a lateral member. No young stages of lateral roots were seen in this plant. In some instances there is great difficulty in determining whether the branch is of endogenous or exogenous origin, the appearance being greatly in favour of the latter mode. There seems little doubt, however, that the endogeny becomes more or less obscured as the branch advances in age and thickness.

What has been said of the root-apex in describing the last species, applies equally in this case (Fig. 11). I need only mention that some apices appeared to be destitute of a root-cap.

The *anastomosis* of these roots is a curious phenomenon. At the point of contact of two roots the cells of its outermost

layer in each organ behave just as the same cells do when in contact with a Bamboo-root, viz. they become much elongated radially, acquire purple contents, and brown, swollen walls, while a ferment is secreted which destroys the limiting cuticularized wall of each root in places here and there, so that at these points direct fusion between the elements of the two distinct organs takes place. Some of the cells in the neighbourhood of the fusion grow out as papillae which bend round towards the point of attachment. In a section through the point of fusion of two roots, the incompleteness of the union is often seen by the small, often minute, portions of the cell-wall, which formed the boundary between the two roots, still remaining, and between which vascular tissue passes from cylinder to cylinder; but in other cases the fusion is complete.

The roots attach themselves to each other in all directions and at every angle, so that an intricate network is formed, as seen in Fig. 2. In this way, those parts of the root-system distant from a tuber are more readily supplied with the nutriment which they need for their work of extension and the building-up of the flowering-stems.

At places here and there on the roots, as well as on the tubers, young *stems* arise. These are of *endogenous* origin, being derived from the central cylinder of the root, and probably from the pericyclic layer (Fig. 20).

Their origin becomes obscure as they increase in age, so that, like the lateral roots, they appear to be of cortical origin; the external layer of the root remains intact around the apex of the young stem for some time, becoming very much bent and stretched outward; it finally snaps and gets left behind as a flap of a single layer of cells on either side of the young growing stem. Unlike the lateral root, the young stem has no dissolving action on the cells of its parent-root, but simply pushes its way outward through the cortex; its outward course will, therefore, probably be less rapid than that of the former organ. The young stems are in the form of small, conical elevations on the root, which, in their youngest stages, appear as mere dimples on the surface; a median section

through one of these shows four or five leaves arching right over a broad, flat apex of small, often purplish, cells.

The *stem* may attain a length of 6–8 inches, and bear several flowers at its summit. It has usually a very much bent and curved attachment to the root, owing, probably, to the fact of its having originated laterally on that organ, and been forced to bend upward towards the daylight. In its middle portion, about half-way between its attachment to the root and the inflorescence, it sometimes becomes considerably thickened and swollen, tapering off again towards the apex.

Anatomy of the Stem.

In a transverse section of an adult stem are seen a number of bundles scattered irregularly throughout the ground-tissue; they vary in number and in size. So reduced and modified is the stem of this species, that not only are the bundles irregularly distributed, but the orientation of each separate bundle is no longer normal; the xylem is usually in the centre, surrounded entirely by phloëm; the elements composing the bundle are very scattered; there is a considerable amount of parenchymatous tissue present.

No endodermis could be distinguished in this stem.

The cells of the ground-tissue are exceedingly loosely arranged and much rounded off; they are large in contour and contain much starch. More will be said of these elements in treating of the longitudinal section.

No stomata were observed anywhere on the stem, either in transverse, longitudinal, or surface section.

In some stems *stone-cells* appear to be entirely absent; in others they are present, surrounding the bundles or in the ground-tissue; but they are not nearly so well-developed as those of the root, being much thinner-walled.

If successive transverse sections are made in the lower part of the stem, near its junction with the root, it will be seen that the bundles become fewer in number and larger, owing to fusion one with another, and also that they arrange themselves

near the centre of the stem ; four or five of these bundles may fuse into a kind of network near the base of the stem, then separate again into three or so, which almost directly after fuse with the central cylinder of the root which is running at right angles to the stem (Figs. 12, 12*a*).

In a longitudinal section the structure of the bundle can be easily seen. The *xylem-elements* are rather longer and narrower than those in the root ; they also undergo rather more sliding-growth, as their terminal walls are usually oblique, and more so than those of the root. The protoxylem-elements have usually a very loose spiral, which is often entirely separated from the wall and lies as an almost straight thread within the element ; others have annuli, which are rather distant and only just serve to keep the walls from collapsing ; these walls are frequently so thin as scarcely to be perceptible.

The phloëm-elements also undergo more sliding-growth. The *sieve-tubes* have a more oblique terminal wall than those of the root, and have several plates both on the terminal and the lateral walls.

The cells of the ground-tissue are very loosely arranged and more or less contorted in outline, so that wide spaces are left between the cells. The reason for this may perhaps be sought in the fact that a properly-developed intercellular system is necessary to ensure free access of air for respiration, and this may be correlated further with the absence of stomata on the stem ; it may also be to admit of easy and free transpiration during the rapid growth which the plant undergoes in order to mature its flowers. As a result of the sliding-growth and contortion of the cells, the greater part of the common wall which connects any two cells, either laterally or terminally, splits at the middle lamella, and thus the two cells become separated. But some parts of the wall split more easily than others ; the parts which offer greatest resistance, and remain firm without splitting, cause each cell at that point to be drawn out into a tube owing to the rapid growth which each cell is undergoing ; as a result of the stimulus

from the strain thus set up, the wall at the point of contact of the two cells becomes excessively thickened, and when, at length, the final splitting takes place at the middle lamella, the retreating portions of the cell-wall appear like drum-sticks, owing to their great extension and knob-like swelling at the end. The knob often appears as if about to be split off from the rest of the cell-wall. In some sections of older stems the outermost cells are more contorted and show more striking sliding-growth.

In the ground-tissue of some stems examined occur sac-like cells full of dense granular contents.

On the surface of the stem are scattered a large number of mucilage-secreting glands; each has a stalk of one to three cells and a head of secreting-cells about eight in number (Fig. 13).

The stem bears *scale-leaves*, which are few in number and alternately arranged. They are large as compared with the size of the stem on which they are borne, and the uppermost bear flowers in their axils. The epidermis of the scale-leaf is covered with numerous *stomata*. These have a very irregular arrangement, lying in all directions. As seen in surface-view their openings were extremely wide, and their guard-cells long and narrow. The subjacent tissue of this dorsal surface is exceedingly loose; the cells are narrow and contorted, exhibiting extremely large intercellular spaces; the tissue on the ventral side is more compact, with fewer spaces. Mucilage-secreting glands are scattered all over the ventral surface. The venation in these organs is to a great extent parallel. The bundles have the normal orientation.

Structure of the Flower.

The flowers are borne on rather long stalks in the axils of bracts. The *calyx* in this plant is a loose, reduced structure, of no definite shape; it may either terminate in two opposite pointed lobes or it may form a mere sheathing body ending in an acuminate apex. The anatomical structure of the calyx

is similar to that of the scale-leaf. The *corolla* greatly overtops the calyx by its long tubular portion, which terminates in five subequal, roundish lobes which are denticulate at the apex. The colour of the corolla is white, its lobes being edged with deep violet. In shape it is funnel-shaped and curved (Figs. 1, 15, 16). A section of the *petal* reveals a loose ground-tissue, whose cells contain a few starch-grains; some cells are filled with minute fungal spores or conidia whose hyphae are seen in nearly every cell. The epidermal cells have conspicuous nuclei; those of the lower surface are purplish, with dense contents of starch-grains or other granules. Mucilage-glands occur on both surfaces, especially on the outer one, where they produce a thick film of the secretion.

The *stamens* are four in number (Figs. 15, 16, 17). Of these, the two posterior ones have each a peculiar swollen prolongation or spur from the connective, which is equal in length to the anther and deflexed, arising near the attachment of the filament; this spur is of a loose internal structure, with large intercellular spaces, this tissue being traversed by a single small bundle; the structure terminates in a sharp point formed of numerous stone-cells with curious lignified thickenings. Each of the four anthers in this plant is unilocular when mature, though bilocular before the pollen-grains are ripe. According to Wight¹ and Hooker², each of the anthers of the posterior pair of stamens has one imperfect, sterile loculus, which is spurred or appendaged; from my own examination the spur-like appendage appears as a prolongation of the connective.

In a transverse section of the anther it is seen that the cells of the epidermis, and of one or two of the underlying layers, on the dorsal side of the anther, nearest the attachment of the filament, have lignified spiral thickenings; also in the cavity of the suture on the ventral surface, a few cells of the second layer from the outside have similar spiral thickenings. It is possible that these assist in preventing a rupture of the anther-

¹ Wight, *Icones Plantarum Indiae Orientalis*, Vol. iv. p. 5.

² Hooker, *Flora of India*, Vol. iv. p. 321.

wall. The short partition, consisting of narrow thin-walled cells, separating the two cells of the young anther, very easily ruptures, the anther thus becoming unicellular.

When the pollen-grains are ripe, the four anthers become united together on their ventral surfaces (Fig. 17) by a thick mass of mucilage, this being secreted by long-stalked glands which occur in large numbers on the dorsal side in the angle between the anther and the filament, as well as on the ventral suture. The anthers, when thus united, are seen to be unilocular, owing to the rupture of the wall separating the two cells.

In a transverse section of the four anthers at this stage, those of the two anterior stamens appear united face to face by a mass of mucilage, the wall of each being broken in the middle and bent inward; those of the two posterior stamens are laterally in contact with each other, the wall of each being unbroken; their faces adhere by mucilage to the anthers of the anterior stamens; the anther-cells of the posterior stamens are usually much more divaricate than those of the anterior ones.

According to Gardner¹ and others, the dehiscence takes place by an apical pore.

The *stigma* is a large expanded surface, borne on a long style, which in its upper region is contractile; as a result of this, the stigma, when touched by any object, bends back against the roof of the flower. Amongst the pointed, papillate cells of the stigma pollen-grains are sometimes seen germinating.

The *ovary* is *unilocular* throughout. The two bipartite parietal placentas bear a large number of extremely small anatropous ovules, which are embedded in mucilage. The whole tissue of the ovary and its contents are of a deep purple colour.

¹ Gardner, Contributions towards a Flora of Ceylon, being the description of *Christisonia*, a new genus of the tribe *Cyrtandraceae*, in Calcutta Jour. Nat. Hist., Vol. viii. p. 153, 1847.

C. neilgherrica, Gardn.

It is to be regretted that no roots of this species were available for examination, as, owing to the depth at which they grow in the soil, it was found by those who attempted it an almost impossible task to dig them out. As this species is quite distinct from either of the other two, so much so that by some it has been placed in a separate genus, an examination of its root-structure might have been invaluable in helping to elucidate some of the important peculiarities in the other two species.

This plant possesses thick, stout stems of considerable length, viz. about 12 to 16 inches. They usually taper from a narrow base up to a very thick and much swollen portion, gradually tapering again towards the summit, where the flowers are borne. The swollen portion of the stem is thickly clothed with imbricating, suborbicular adpressed scales, which in their lower part are of considerable thickness, tapering, wedge-like, towards the apex; the uppermost scales are much narrower and more concave, and are less adpressed, projecting from the stem. In the axils of these small uppermost scales or bracts are borne large numbers of flowers, which are compactly arranged in a large, roundish head (Fig. 25). They are borne each on a long stalk bearing two opposite lanceolate bracteoles.

Anatomy of the Stem.

In transverse section the ground-tissue consists of cells which are more or less hexagonal or roundish in shape, and pretty compactly placed. They are full of starch-grains. There are cells here and there, especially in the epidermis, which are crammed full of immense numbers of small round bodies, probably fungal spores; in some cells these are exceedingly small, in others large and dark coloured.

The *vascular bundles* form a rather irregular ring; they are arranged side by side in groups, these being separated by

wide spaces in the ground-tissue. In different stems the bundles vary in number and in size; some of them are of considerable proportions, being built up of a large number of elements. Most of them have the normal orientation; some are frequently seen to have a peculiar concentric arrangement whereby the xylem comes to lie on the circumference and the phloëm in the centre; the bundle then becomes circular in outline.

The *xylem-elements* are few and scattered, the small protoxylem-elements lying on the innermost side of the bundle. The *phloëm* is largely developed, the elements being much more numerous than those of the xylem. *Medullary rays* and *parenchyma* are very abundant throughout the bundle, and add greatly to its significance. A distinct *cambium* is present, giving rise to secondary thickening.

In some places a small group of *stone-cells* lies on the outer edge of the phloëm.

Stomata occur here and there on the epidermis. They are characterized, as seen in this section, by the guard-cells being raised above the surface of the stem, the subsidiary cells also being bent upward; the former have usually dark contents.

In longitudinal section the cells of the ground-tissue are seen to be compactly placed, and undergo sliding-growth, but to a very slight extent.

The *xylem-elements* have oblique terminal walls, on which there is always present a round or oval perforation, occasionally two; this shows them to be *vessels* (Fig. 23). They are reticulately thickened and run irregularly down in more or less isolated chains. The protoxylem-elements are much elongated and narrow; the innermost have a very loose reticulate or spiral thickening.

The *sieve-tubes* are short elements, with transversely-placed terminal walls, on which are apparently several plates.

The *companion-cells* are usually of the same length as the sieve-tubes; they are either extremely narrow or broader (Fig. 24).

In the cells of the epidermis a fungus occurs now and then, having a similar appearance to that found in the root of *C. subacaulis*, Gardn.

If surface-sections of the stem are made, the *stomata* are seen to lie in all directions, both longitudinally and transversely; in the latter case the guard-cells have a curious shape, being rounded and as broad as, or broader than, they are long; other stomata have a most peculiar oblique structure, the guard-cells, and consequently the pore, being more or less distorted and altogether abnormal in shape. The guard-cells are filled with dense granular contents, which are sometimes of a brown colour¹.

In a section through the thicker portion of one of the *scales*, which so thickly cover the stem, the cells appear loosely arranged with small intercellular spaces amongst them; their walls are curiously thickened at the corners where they border on an intercellular space. Brown granules occur in many of the epidermal cells. On the dorsal surface of the scale are raised stomata, as in the stem.

The bracts are of a deep orange colour.

Structure of the Flower.

The *calyx* is shorter than the corolla. There are no glands on its surface. It is of a deep orange colour, like the bracts. The internal tissue is not loose, but the cells fit closely together. Stomata occur on both surfaces, though they are very few in number. As regards its form, it consists of a tubular portion terminating in four or five inconspicuous lobes, which are sometimes scarcely distinguishable.

The *corolla* does not much overtop the calyx; it has five equal, spreading lobes. On both surfaces it is thickly covered with very large *glands*; the stalk of the gland is very long, consisting of six or seven elongated cells, with a very small

¹ I have been kindly informed by Mr. Percy Groom that similar distorted stomata occur on the scale-leaves of two saprophytic orchids, viz. *Aphyllorchis pallida* and *Lecanorchis moluccensis*, which were described in his paper, "Contributions to the Knowledge of Monocotyledonous Saprophytes," read before the Linnean Society, December 20, 1894.

head of one or two cells at the top. Within the stalk-cell is a fungus with buckle-joints at intervals in the mycelium, which are either quite large and round or very small. Some of the cells are filled with brown granules; very little mucilage is secreted. The corolla is pale yellow or almost white in colour; its internal tissue is loose, the cells undergoing sliding-growth.

There are four *stamens*, the filaments of which are covered with glands.

The *anthers* are all bilocular when young, becoming, as in the other species, unilocular by the rupture of the wall separating the two loculi. Each anther is curiously pointed at the base; this is owing to a prolongation of the connective, which here occurs at the base of the anther instead of near the insertion of the filament, as in the last species described. As seen in transverse section, before the dividing wall has ruptured, the anther consists of two loculi, which are often extremely narrow, owing to the large conical projection of sterile tissue into the cavity. On the ventral suture of the anther, just outside the dividing wall, occur a few cells with lignified thickenings on the walls; these belong to the second layer of the wall, the outermost layer consisting of small narrow cells.

The anther-cells are rather divaricate. The dehiscence, according to former authors¹, who describe and figure it, takes place by means of a pore at the apex; this may possibly also hold good for the two previous species.

The *stigma* is clavate or cylindric in shape—this portion being in reality the lower of two lobes, of which the upper is dwarfed or abortive—and is drooping, owing to the style being hooked at the apex; its surface is built up of papillate cells with obtuse or rounded ends; the cell-wall at the extremity appears thicker and shows minute markings like pits; the cell contains starch and a granular substance. The ground-tissue of the stigma consists of narrow cells filled with starch-grains.

¹ Wight, loc. cit.; Gardner, loc. cit.

The ovary is *bilocular* in its lower region and *unilocular* above; in the latter case the placentation is parietal. In this plant the basal portions of the two bipartite placentas very nearly meet in the centre. In the lower, bilocular part of the ovary, where the projections have become united to form a dividing wall, the placentation is axile, two placentas, bearing a large number of minute ovules, projecting into each cavity.

COMPARISON OF THE FORMS.

Of the three species belonging to this genus which, in the foregoing pages, have been described, two, viz., *C. bicolor*, Gardn., and *C. subacaulis*, Gardn., are closely allied, while the third, *C. neilgherrica*, Gardn., presents various characters which render it quite distinct from either of the preceding, insomuch that it has been placed by some authors in the separate genus *Campbellia*¹.

I will first discuss the relations between the first two species described. It will have been gathered from the description that *C. bicolor*, Gardn., is much more typical and normal in all parts of its structure than is *C. subacaulis*, Gardn. This is seen, first, in the structure of the root, where the typical radial arrangement of the central cylinder and the presence of a distinct endodermal layer present a marked contrast to what we find in *C. subacaulis*, Gardn., where, owing to the greater reduction of the xylem and the abnormal development of the phloëm, the radial arrangement of the cylinder has become completely obscured, while no endodermal layer can be distinguished on the outside. The latter species is further distinguished by the complete absence of any local mucilaginous thickenings of the cell-wall, which is so conspicuous a feature in the cortical cells of the root of *C. bicolor*, Gardn.

In connexion with the more reduced form and structure of *C. subacaulis*, Gardn., we find the haustorial part of the root-system very strongly developed; in consequence of its para-

¹ Wight, loc. cit.

sitic habit the typical and normal anatomical structure of the roots has become extremely modified; while, as regards mass, these organs have attained a great development compared to that of the subaërial portion of the plant. *C. bicolor*, Gardn., has not such extreme modifications and degradations of structure to suit the parasitic habit as we find in *C. subacaulis*, Gardn. Such phenomena as the development of tubers and the branching and growth of the haustorium in various directions through the tissues of the host-root are apparently unknown in the former species.

The same reduced character is evident when the structure of the subaërial portion of *C. subacaulis*, Gardn., is examined. The stem contains numerous scattered bundles without definite arrangement or orientation—a striking difference to the regular ring of collateral bundles characteristic of the stem of *C. bicolor*, Gardn. No definite endodermis could be seen in either species. In the former plant also the ground-tissue is very loose, with a great amount of sliding-growth and contortion between the elements, constituting a largely-developed intercellular system. In *C. bicolor*, Gardn., this tissue is normal, and the cells compactly arranged, with few intercellular spaces.

Passing on to the appendages of the stem, we see in *C. bicolor*, Gardn., that the scale-leaves have a more regular arrangement than in *C. subacaulis*, Gardn. As regards the floral structure, there are a few points of difference. In the latter plant the calyx is less regularly formed, often having a mere sheath-like appearance; but the rest of the flower is built upon a larger scale; the stamens cohere when ripe, the two posterior anthers being spurred, and the stigma, which consists of a large expanded surface, is irritable—characters which do not appear in the other species.

Coming now to *C. neilgherrica*, Gardn., I will briefly mention the chief points of difference between this and the two former species, as far as the material at my disposal allows. In the reduced nature of its stem-structure, this plant occupies an intermediate position between the others; the bundles are not arranged in a definite ring, but in isolated

portions of it, and have the ordinary collateral arrangement. The scale-leaves here are densely imbricated.

The stems of some plants of *C. neilgherrica*, Gardn., are remarkably swollen in places. In a section this is seen to be due to a great extension of the ground-tissue resulting from continual division of the parenchyma-cells, which at first appears to take place on one side of the stem only throughout its whole diameter. The bundles of the cylinder send branches into the newly-formed tissue; and when this portion of the stem has at length attained a considerable diameter, strands of xylem-elements are seen ramifying in all directions, not only in the outer portion of the ground-tissue, but also between the greatly enlarged bundles and throughout the pith. Thus the structure no longer bears any resemblance to that of the ordinary stem and presents a very peculiar appearance.

One distinguishing feature of this plant is the presence of two opposite bracteoles (prophylls) on the pedicel. The limb of the corolla is more spreading, nor have any of them the curious spur-like prolongation of the connective so characteristic of *C. subacaulis*, Gardn., the connective being here simply produced at the base into a short curved point. An interesting drawing of *C. Stocksii* is given by Sir. W. Hooker¹, showing the structure of the anther, which is of the type here described in its dehiscence, and the character of the spur. The structure of the stigma, again, is of quite a different type: we have seen that it is not an expanded surface, as in the others, but clavate in form, the style, moreover, being hooked at the apex. The *ovary* differs from that of the other species in being bilocular below and unilocular above; in the latter case, the basal part of the placenta projects far further into the cavity.

The presence of bracteoles, the structure of the anther, the stigma, and the ovary, respectively, are the chief characters by which this plant may be distinguished from the other two species. Gardner² states that it differs from the Ceylon

¹ Hooker, *Icones Plantarum*, Vol. ix. tab. 836.

² Gardner, *loc. cit.*

species in the bilabiate calyx, and in the anterior lip of the stigma being oblong, not broadly dilated.

SUMMARY OF RESULTS.

I may now bring forward the chief results accruing from the morphological and anatomical study of these three species.

The chief factor to be dealt with in these plants, and which influences their whole vegetative structure, is their parasitism. In one species, as we have seen, this mode of life has had a most marked effect, not only on the external form, but also on the internal structure of both the root and the stem, both having become adapted, chiefly in a retrogressive direction, to suit the changed habit and conditions of life of the plant.

The chief peculiarities in these plants, which may be considered as the outcome of their parasitic habit, are the following: the branching and anastomosing root-system, from which the flowering-stems are produced; the rhizome-like character of the root, and the absence of root hairs; the development (in one species) of tubers, from which the haustoria and the young lateral roots and stems are produced, and which serve as storehouses for the nutrition of the plant; the modified anatomical structure of the cylinder of the root, in which the xylem has become reduced and the phloëm correspondingly developed; and the reduction of the conducting-tissue of the stem, co-related with the absence of foliage leaves, which are here replaced by scales.

The most abnormal and interesting feature occurring in these plants is presented by the subterranean portion of *C. subacaulis* especially, which, on investigation, is discovered to consist of organs having the character of *roots*, though their morphological nature is well concealed, owing to their extreme modification arising from the parasitic habit.

The *tubers*, which arise at intervals in the root-system of the plant just named, are the most important parts of it, for it is from these that the haustoria are chiefly formed, while they also act as reservoirs of nutriment for the whole plant.

The *haustorium* is interesting as having an *exogenous* origin,

and not an endogenous one, as described for many other parasites; it agrees in this respect with that of *Rhinanthus*.

The young *lateral roots* and *stems* have both a similar origin from the parent-root; they arise *endogenously* and from the central cylinder; as they increase in age, this origin becomes more and more obscure, till it becomes a rather difficult task to determine whether it is a case of endogeny or exogeny.

The degradation of structure in these plants we can trace through the stem and the foliar appendages up to the calyx, with which it ceases. The rest of the flower is chiefly distinguished by the mucilaginous covering of the corolla, the two spurred posterior anthers, and the motile stigma, the first and last characters, however, applying to one of the species only.

This work has been carried out in the Botanical Laboratory of the Royal College of Science, South Kensington. I must express my warmest thanks to Professor J. B. Farmer, who collected the plants in their native habitat, for so kindly placing the material at my disposal for investigation, and also for the great assistance which he has continually afforded me throughout the progress of the work. I am also much indebted to him for the drawings of Figs. 1, 15, 16, and 17.

EXPLANATION OF THE FIGURES IN PLATES

V AND VI.

Illustrating Mr. Worsdell's paper on *Christisonia*.

Fig. 1. Entire plant of *C. subacaulis*, Gardn., showing the disposition of the root, stems, and flowers.

Fig. 2. Portions of the subterranean part of *C. subacaulis*, Gardn., showing the mode in which the roots anastomose together to form a tangled network. $\times 1\frac{1}{2}$.

136 *Worsdell.—On the Genus Christisonia.*

Fig. 3. A tuberous portion (*tb*) of the root of *C. subacaulis*, Gardn., showing its attachment to the root of a Bamboo. $\times 2$.

Fig. 4 *a*. Transverse section through the central cylinder of the root of *C. subacaulis*, Gardn. $\times 75$.

Fig. 4 *b*. Transverse section through the root of *C. bicolor*, Gardn. x = xylem; *ph* = phloëm; *sn* = stone-cells; *ct* = cortex. $\times 75$.

Fig. 5. Transverse section of a 'proteid-bundle' from a tuber of *C. subacaulis*, Gardn. $\times 100$.

Fig. 6. Haustorium of *C. subacaulis*, Gardn., penetrating root of Bamboo. $\times 130$.

Figs. 7, 8, 9. Portions of transverse sections through a branch of a haustorium of *C. subacaulis*, Gardn., showing mode in which suckers grow out from the innermost cells and dissolve their way into the central cylinder (*cc*). $\times 260$.

Fig. 10. Section of a haustorium of *C. subacaulis*, Gardn., which has branched, the branches running parallel to the central cylinder of the host-root. $\times 65$.

Fig. 11. Apex of a root of *C. subacaulis*, Gardn. *rc* = root-cap; *dt* = dermatogen. $\times 100$.

Fig. 12. Longitudinal section of the stem and root of *C. subacaulis*, Gardn., showing the anastomosis of the bundle-system in the two organs (diagrammatic).

Fig. 12 *a*. Transverse section of the root and longitudinal section of the stem, showing the same (diagrammatic).

Fig. 13. Gland from the stem of *C. subacaulis*, Gardn.

Fig. 14. Single stoma in section. $\times 260$.

Fig. 15. Flower of *C. subacaulis*, Gardn., seen from the front with part of the corolla removed, showing stamens and stigma.

Fig. 16. Side view of flower.

Fig. 17. Flower with the floral envelopes removed, showing the coherence of the stamens and the stigma.

Fig. 18. Portion of a root of a species of Strobilanth, showing the attachment of several small plants of *C. bicolor*, Gardn. $\times 2$.

Fig. 19. Part of transverse section of the root of *C. bicolor*, Gardn., showing the origin of a rootlet. *rc* = root-cap; *cc* = central cylinder of parent-root. $\times 65$.

Fig. 20. Longitudinal section of a root of *C. subacaulis*, Gardn., showing the origin of a stem. *l* = first two young foliar organs; *cc* = central cylinder of parent-root. $\times 50$.

Fig. 21. Part of transverse section of a root of *C. bicolor*, Gardn., showing the place of origin of a haustorium (*hr*). $\times 50$.

Fig. 22. Transverse section of the root of *C. bicolor*, Gardn., and root of Strobilanth, showing exogenous mode of origin of haustorium; also the zone of starch-containing cells in cortex of parasite (slightly diagrammatic). $\times 100$.

Fig. 23. Part of a vessel from the stem of *C. neilgherrica*, Gardn. $\times 260$.

Fig. 24. Sieve-tube and companion-cell from the stem of *C. neilgherrica*, Gardn. $\times 260$.

Fig. 25. Stem and inflorescence of *C. neilgherrica*, Gardn.

Fig. 26. Cortical cell from the root of *C. subacaulis*, Gardn., showing the fungus growing on one of its walls. $\times 260$.

Fig. 27. An intercellular space with the fungus forming conidia. $\times 260$.

Spores in a Specimen of *Tempskya* (*Endogenites*).

BY

L. A. BOODLE, A.R.C.S.

Demonstrator in Botany at the Royal College of Science, London.

SPECIMENS of the Wealden fossil known as *Tempskya* *Schimperii*, Cord., or *Endogenites erosa*, Mant., have often very little of their original structure preserved, sometimes a great deal. A striking difference in this respect is shown by sections of some specimens, which I collected near Brightstone (in the Isle of Wight), and at Hastings respectively. Those from the first locality contain numbers of vascular bundles, whose tracheides have their scalariform thickenings perfectly preserved. In those from the second locality the outlines of the roots are distinguishable, but the xylem has entirely disappeared in nearly all cases.

One of these latter specimens, in spite of the general obliteration of structure, contains a group of spores in remarkably good preservation. As spores do not appear to have been seen before in *Tempskya*, it may be worth while to describe them.

A. C. Seward¹ has quite recently published a description of *Tempskya*, with a summary of previous work. It will,

¹ Seward, Catalogue of Mesozoic Plants in Dep. Geol. Brit. Mus. The Wealden Flora, Part I, 1894 (p. 148).

[*Annals of Botany*, Vol. IX. No. XXXIII. March, 1895.]

therefore, only be necessary to mention the general structure shortly, before describing the spores.

The following is the diagnosis as given by Seward¹:—

‘Masses of numerous branched adventitious roots, and a few small ?petioles forming masses, occasionally several

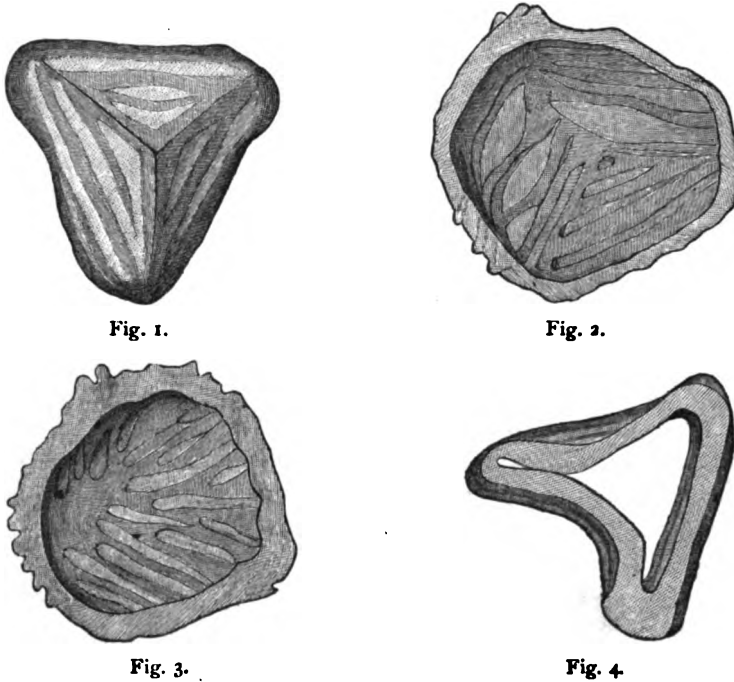

Woodcut 1.

Fig. 1. Exterior of spore, showing the angle upwards. Fig. 2. Spore cut in half, interior view. Fig. 3. Spore similarly cut, but with different markings. Fig. 4. Collapsed spore in section. The figures are slightly diagrammatic, and the spores are drawn as opaque objects, for simplicity. Where the wall of a spore is shown in surface-view, the light areas represent the pits, the darker parts are the thickenings. Figs. all $\times 545$.

feet in length, and in large specimens about one foot in diameter; the transverse section of the mass is often elliptical in shape, no doubt as the result of pressure; the ends of

¹ Loc. cit., p. 151.

the specimens frequently taper to a pointed termination, and the external surface may be covered over with a layer of coaly substance representing carbonised tissue. The roots are of the diarch type, and the petiole structures are characterized by a horseshoe-shaped vascular band. (The central vascular axis possibly of the *Protopteris* form.)¹

The specimen to be described is a water-worn piece, that was picked up below the cliffs just east of Hastings. The vascular bundles of the roots have nearly all disappeared, and their place is mostly represented by a clear area. This consists of quartz¹ surrounding a central cavity, or occasionally without any cavity. There is a certain amount of carbonised material in the cortical region of the roots. It is sometimes arranged so as to give the appearance of the cell-walls in a badly preserved tissue; but comparison of different parts of the section proves that this appearance is often misleading.

In one section there are two or three hundred spores aggregated in a slightly lobed mass which is penetrated by two roots(?); several spores also occur scattered at some distance from it. From their form and structure they are probably fern spores, and their arrangement suggests a large sporangium or a sorus. The spores are yellowish brown in colour, about 65 μ in diameter, and vary in shape from spherical or oval to bluntly tetrahedral (see Figs.). This apparent variation is, of course, partly due to the varying positions of the spores. A considerable number of the spores must have been shrunk before the specimen was mineralised; thus causing irregularities of form, such as Fig. 4 exhibits, where the spore is shown in section. The wall of the spore is in nearly all cases strongly pitted, and the thickenings take the form of bars, which run roughly parallel with one another, and fuse at intervals. There is a good deal of variation in the form of the thickenings, but Fig. 1 may be taken as a typical appearance of the spore when viewed from the

¹ Dr. W. F. Hume has kindly examined a slide and determined that this is secondary quartz, formed in the cavities by subsequent infiltration.

angular side. Figs. 2 and 3 represent internal views of spores in other positions. In some cases the pits and bars run uniformly, and all parallel, right across the spore. One spore is apparently not mature, having a smooth wall. There seems little doubt that the structures described above are spores, but it is as well to regard other possibilities. A group of short detached tracheides, such as one sees in the central region of the old stem of *Isoëtes*, would present an appearance somewhat like that of the spore-mass in question, but the frequency of tetrahedral form is strongly in favour of their being spores, as is also the fact of their being so well preserved in a specimen from which the xylem has disappeared. For, if they were tracheides, they would doubtless be lignified, and as liable to be destroyed as the xylem of the roots; but spores, when strongly cuticularised, would be much more resistant to decay.

Surrounding the group of spores there is a layer consisting of carbonaceous matter in the form of small cylindrical rods placed end to end, and running peripherally. These differ from the carbon masses in other parts of the section, and may possibly represent casts of cells belonging to an indusium, a sporangium-wall, or a tuft of hairs.

Mr. Carruthers kindly pointed out to me the spores of *Trochopteris elegans*¹, as most nearly resembling those described above, among living ferns. The thickenings in the spore-wall are very similar in the two cases. The spores are almost exactly of the same shape, and of the same average size, individual spores varying considerably. Though many spores of *Trochopteris* have their thickenings slightly differently arranged, e.g. more uniformly parallel, twisted at the angles of the spore, or more closely set, still certain spores have their pits and thickenings almost precisely as in *Tempskya*; thus one spore examined was a nearly exact counterpart of that shown in Fig. 1.

¹ Through the kindness of Mr. Carruthers I was enabled to examine the spores of *Trochopteris*, *Ceratopteris*, and other genera in the Herbarium of the British Museum.

This close resemblance in the spores need not, however, point to any near affinity with *Trochopteris*, which belongs to the Schizaeaceae. The spores of *Ceratopteris thalictroides* among the Polypodiaceae or Parkeriaceae have thickenings of a similar but not identical type with *Trochopteris*. Thus, though this type of spore-thickening is uncommon, it occurs in plants that do not seem to be nearly related to one another; and therefore the resemblance to *Trochopteris* in spore-structure is insufficient, without the evidence of any sporangial structure, for referring the fossil spores to the neighbourhood of the Schizaeaceae.

The spores of *Dicksonia*, which has been compared with *Tempskya*, are nearly smooth, with occasional warts or slight ridges.

There is no evidence that the spores in *Tempskya* belong to the same plant as the adjacent roots. Should any spores be found in a specimen containing xylem, it is to be hoped that the sporangium would be preserved, and that the attachment to a leaf-stalk might be determined. I am indebted to Prof. Judd, Prof. Farmer, and Mr. Seward for assisting me with suggestions.

**Descriptions of some New Plants from Eastern
Asia, chiefly from the Island of Formosa,
presented by Dr. Augustine Henry, F.L.S.,
to the Herbarium, Royal Gardens, Kew.**

BY

W. BOTTING HEMSLEY, F.R.S.

Principal Assistant, Herbarium, Royal Gardens, Kew.



With Plates VII and VIII.



IN May of last year Kew received a collection of dried plants from Formosa, presented by Dr. A. Henry, the same gentleman who previously collected so successfully in Hupeh and Szechuen, and who has sent to Kew probably not less than five hundred species previously unknown in the botanical world, and also a considerable number of new genera. Altogether the collection contained about 1500 species, and the following is a selection therefrom, with a few from the mainland of China. It was the wish of the Director of Kew that the whole collection should be elaborated and published, but pressure of other work has prevented this from being done, and in justice to Dr. A. Henry it was decided not to delay any longer the publication of those already described. They were partly collected by Dr. Henry himself in the neighbourhood of Takow, and at the South Cape; partly by a Chinese in the mountains of Bankinsing, in the interior of the southern peninsula; and partly by a Mr. Schmüser,

[*Annals of Botany*, Vol. IX. No. XXXIII. March, 1895.]

a lighthouse keeper at South Cape. Although Ape's Hill, near Takow, had been previously botanised, Dr. Henry succeeded in finding a number of interesting novelties. On a map in the Proceedings of the Royal Geographical Society, vol. vii, 1885, the height of Ape's Hill is given as 1110 feet, and the mountains in the vicinity of Bankinsing as 8050 feet; but Dr. Henry's collector did not reach a greater altitude than 2000 feet, being in constant fear of the native savages. The Orchids are described by my colleague, R. A. Rolfe, A. L. S.

***Hypericum* (*Ancyron*) *trinervium*, Hemsl.**

Frutex undique glaberrimus, ramulis teretibus. *Folia* conferta, subsessilia, chartacea, ovato-oblonga, 1-1½ poll. longa, apice obtusa vel rotundata et simul apiculata, basi subcuneata, a basi trinervia, subtus pallidiora, crebre minuteque pellucido-punctata. *Flores* vix 1 poll. diametro, pedunculis axillaribus 3-6 lineas longis solitariis vel superioribus 2-3-floris nudis; *sepala* leviter inaequalia, ovata vel oblonga, obtusa 1-1½ lin. longa; *petala* valde obliqua, apice rotundata; *stamina* pentadelpa, quam petala breviora; *ovarium* 5-loculare, stylis per totam longitudinem connatis, stigmate parvo clavato. *Capsula* subcylindrica, leviter curvata, circiter semipollicaris, stylo 3-4 lineas longo coronata, demum arcte recurva; *semina* numerosissima, cylindrico-clavata, unilateraliter obscure alata.

Formosa: South Cape, Schmttser (Hb. Henry, 906 and 906 A).

This and the following species belong to a small group inhabiting Eastern Asia, characterized by the styles being consolidated throughout their whole length. *H. trinervium* resembles *H. formosanum*, Maxim. in foliage, but it is readily distinguished by the lateral nerves of the leaves and the much less conspicuous glands. The flowers of the latter, too, are borne on short lateral branchlets or peduncles bearing one or two pairs of leaf-like bracts. The closely reflexed ripe capsules is a striking character this has in common with *H. geminiflorum*. Hemsl.

***Hypericum* (*Ancyron*) *geminiflorum*, Hemsl.**

Frutex tripedalis (fide *A. Henry*) undique glaberrimus, ramulis gracilibus rubescentibus. *Folia* subsessilia, tenuiter chartacea, ovato-oblonga, usque ad 1½ poll. longa, apiculata, pallida, subtus glauca, obscurissime pellucido-punctata. *Flores* in axillis foliorum superiorum

saepissime solitarii, vel supremi supra folia geminatim racemosi (folia cito decidua), pedunculis 3-6 lineas longis; *sepala* leviter inaequalia, ovato-oblonga, obtusa, circiter lineam longa; *petala* . . . *stamina* . . . *Capsula* 5-locularis, cylindrica vel teres, stylo simplice brevi coronata, 4-5 lineas longa, demum insigniter reflexa; *semina* minuta, cylindricoclavata.

Formosa: Ape's Hill, Takow (Hb. Henry, 1155).

The absence of lateral nerves traversing the whole length of the leaves, the very obscure glands, pale leaves and the absence of leaves from the upper part of the branches in the fruiting stage, distinguish this from the preceding.

Capparis membranacea, Gard. et Champ. var.? *angustissima*, Hemsl., foliis usque ad 8 poll. longis et maximis 3 lineas latis.

Formosa: Bankinsing mountains. White-flowered climber (Hb. Henry, 471, 1005).

This appears to be an extreme variety of a very heterophyllous species. Dr. Henry's 410 from the same locality, has somewhat broader leaves; and the specimens from China proper exhibit a considerable variety in shape, though none has them so narrow as those described above.

Capparis (§ *Eucapparis*) *formosana*, Hemsl.

Frutex alte scandens (fide *A. Henry*), ramulis floriferis crassiusculis cinereis pulverulentis. *Folia* distincte petiolata, coriacea, oblonga, ovato-oblonga, vel superiora minora anguste obovata vel oblanceolata, maxima cum petiolo usque ad 7 poll. longa sed saepius breviora, apice obtusissima vel rotundata atque brevissime acuminata, basi rotundata vel cuneata, integerrima, utrinque glaberrima, supra subnitida, subtus pallida, venis primariis lateralibus utrinque circiter 6-8 inter se conspicue anastomosantibus in foliis siccis utrinque sat conspicuis; petiolus 6-10 lineas longus. *Flores* rosei, fragrantissimi (fide *Henry*), circiter 1 poll. diametro, racemoso-fasciculati vel subumbellati cum paucis infra umbellas positi, racemi quam folia breviores, pulverulenti, pedicellis usque ad 1½ poll. longis; *sepala* 4, quorum 2 exteriora pulverulenta, crassa, subcarnosa, valvata, aequalia, alte concava, orbicularia, intus nuda, 2 interiora tenuiora, petaloidea, lata, marginata, uno breviter galeato; *petala* lata, sepala vix aequantia; *stamina* numerosissima, bene evoluta non visa; *ovarium* glabrum, longe graciliterque

stipitatum, placentis 3 et ovulis numerosissimis. *Fructus* lignosus, globosus, circiter 1 poll. diametro (an maturus?), stipite fere bipollicari; *semina* ignota.

Formosa: Bankinsing and Ape's Hill (Hb. A. Henry, 501, 501 A, 501 B, 501 C, 501 D).

***Camellia gracilis*, Hems.**

Frutex 10-pedalis (fide *A. Henry*) ramulis floriferis gracillimis primum parce pilosulis cinereis. *Folia* brevissime petiolata, tenuia, fere membranacea, anguste lanceolata, 2-3 poll. longa, et usque ad 9 lineas lata, caudato-acuminata, simul obtusiuscula, minute apiculato-serrata, concoloria, pallide viridia, subtus secus costam primum parcissime pilosula; petiolus circiter lineam longus, magis pilosus. *Flores* circiter 9 lineas diametro, pseudoterminals, erecti, solitarii, pedunculis 3-4 lineas longis bracteis paucis parvis instructis; *sepala* 5, aequalia, parva, crassa, coriacea, rotundata, pubescentia; *petala* 5, saepius suborbicularia, undulata, breviter unguiculata, mucronulata, extus plus minusve sericea; *stamina* numerosissima, 5-6 interioris exceptis, alte monadelphica, filamentis dense barbatis, filamentis liberibus valde incrassatis clavatis; *ovarium* hirsutum, triloculare; stylus etiam hirsutus stamina excedens, alte trifidus. *Capsula* ignota.

Formosa: Bankinsing mountains (Hb. Henry, 1612).

Closely allied to *C. assimilis*, Champ., and possibly a variety of it, though it has much thinner leaves, erect, smaller flowers, and exhibits other differences; all of which however may be due to local conditions and not permanent.

***Actinidia lanata*, Hems.** Species ex affinitate *A. fulvicomae*, sed magis hirsuta, foliis late ovato-cordatis, pedunculis saepius trifloris, etc.

Frutex ramulis floriferis foliis fructibusque ferrugineo-lanatis vel tomentosus. *Folia* longe petiolata, crassa, chartacea, cum petiolo pollicari usque ad 6 poll. longa et 3½ poll. lata, longe acuminata, basi breviter cordata, aculeolato-ciliata, supra hispidulo-strigillosa, subtus stellato-tomentosa vel lanata. *Pedunculi* petiolos vix excedentes. *Flores* . . . *calycis* fructiferi sepala crassa, lanata, ovata, obtusa, 4-5 lineas longa.

Bacca (immatura tantum visa) villosa, ovoidea, 9-10 lineas longa, stylis numerosissimis coronata.

China: Kwangtung along the North-west river, Mr. C. Ford's native collector; 228 of 1890 collection.

Echinocarpus sinensis, Hemsl. Species quoad fructum *E. murici* simillima sed foliis multo-majoribus oblanceolatis tenuioribus.

Arbor 16-pedalis (*A. Henry*), ramulis fructiferis foliisque glaberrimis. *Folia* graciliter petiolata, tenuia, papyracea, anguste oblanceolata, cum petiolo 4-8 poll. longa, $1\frac{1}{2}$ -2 poll. lata, abrupte acutoque acuminata, deorsum attenuata sed basi obtusa, remote callososerrulata, venis primariis lateralibus utrinque 7-10; petiolus gracilis, 6-12 lineas longus, basi incrassatus, apice geniculatus. *Flores* ignoti. *Capsula* solitaria, pedicellata, pedicellis circiter sesquipollicaribus, lignosa, 4-5 locularis, globosa, $1-1\frac{1}{2}$ poll. diametro, densissime setoso-aculeata, simul tomentosa, setis rectis rigidis semipollicaribus setulosis; *semina* cylindrico-oblonga, arillo ceraceo rubro ad $\frac{3}{4}$ vestita.

China: province of Hupeh, on cliffs (*A. Henry*, 7488).

Zanthoxylum stenophyllum, Hemsl.

Frutex 5-6 pedalis vel scandens (*A. Henry*), fere undique glaber, dense ramosus, ramulis floriferis fructiferisque gracilibus aculeis paucis brevibus rigidis armatis. *Folia* pinnata, rachi gracillima saepius elongata (interdum usque 9 poll. longa) aculeis numerosis rigidis $1\frac{1}{2}$ -3 lin. longis leviter curvatis instructis; foliola 5-9, alterna vel subopposita, breviter petiolulata, subcoriacea, anguste lanceolata vel linear-lanceolata, $1\frac{1}{2}$ -3 poll. longa, sursum longe attenuata, sed vix acuta, basi cuneata vel subrotundata, minute glanduloso-serrata, supra nitida vel subopaca, secus costam primum puberula. *Cymae* corymbosae vel subumbellatae, axillares, brevissime pedunculatae, pauciflorae, fructiferae circiter $1\frac{1}{2}$ poll. longae et latae, pedicellis fructiferis gracilibus angulatis circiter semipollicaribus. *Flores* unisexuales vel polygami, ♀ ignoti, ♂ glabri, vix 2 lineas diametro; *sepala* 4, minuta, oblonga; *petala* 4, ovalia, obtusa, lineam longa; *stamina* 4, antheris magnis cordiformibus; *ovarium* rudimentarium ovoideum, glabrum. *Cocci* sessiles, glabri, glandulosi, oblique-ovoidei, circiter $2\frac{1}{2}$ lin. longi; *semina* nigra, nitida.

China: Hsingshan, province of Hupeh (*A. Henry*, 6466, 6555); South Wushan, province of Szechuen (*A. Henry*, 5560).

Zanthoxylum micranthum, Hemsl.

Arbor usque ad 50 ped. alta sed saepius minor (*A. Henry*), ex affinitate *Z. ailanthoides*, ramis floriferis aculei paucissimis rectis

circiter 2 lineas longis armatis. *Folia* pinnata, 5–10 poll. longa, parce puberula, rachi gracili compresso-tereti supra angustissime canaliculata; foliola 7–11, opposita vel subopposita, distincte petiolulata, coriacea, lanceolata, 3–5 poll. longa, longe acuminata, obtusa atque emarginata, basi saepius oblique rotundata, minutissime glanduloso-dentata, undique parce pellucido-glandulosæ, glabra vel cito glabrescentia, subtus pallidiora, venis primariis inconspicuis. *Cymae* amplissimae usque ad 12 poll. diametro, terminales et axillares, multiflorae, puberulae. *Flores* minuti, breviter pedicellati, sepalis petalis staminibusque saepius 5. *Cocci* maturi non visi, saepissime 3, nudi, punctati, 2-ovulati, stigmatibus sessilibus conniventibus capitatis.

China: Ichang, Nanto and immediate neighbourhood, Hupeh (A. Henry, 2095, 4127, 4127, A. 4538).

This differs from *Z. ailanthoides* in the much less numerous, less conspicuous primary veins of the leaves.

***Zanthoxylum fraxinoides*, Hemsl.**

Frutex 5-pedalis (A. Henry), *Z. undulatifolio* similis sed undique glaberrimus, &c. *Rami* fructiferi rigidi, recti, paucispinosi, cortice nigrescente lenticellato. *Folia* pinnata, 4–6 poll. longa, rachi gracili inermi vel aculeis paucis minutissimis armata supra canaliculata atque angustissime bialata; foliola 5–9, opposita vel inferiora subopposita, papyracea vel demum subcoriacea, pallida, subsessilia, (terminale petiolulatum) inaequalia, deorsum saepius gradatim minora, saepius oblonga, interdum elliptica vel lanceolata, obtusa vel subacuta, 1–2½ poll. longa, basi saepius rotundata, crenato-denticulata, in angulis dentium unipellucido-glandulosa, venis primariis lateralibus utrinque 5–9 prominulis. *Cymae* axillares, subsessiles, subtrichotomo-ramosae, 1–1½ poll. diametro, pedicellis graciliusculis nudis 2–3 lineas longis. *Flores* non visi. *Cocci* 2–4, saepius 2, rubri (A. Henry), ovoidei, compressi, circiter 2½ lineas longi, grosse glandulosi, sessiles, sub insertionem producti; *semina* nigra, nitida.

China: Fang, province of Hupeh (A. Henry, 6903).

***Zanthoxylum undulatifolium*, Hemsl.**

Frutex circiter 10-pedalis valde aculeatus (A. Henry), glabrescens, ramulis fructiferis graciliusculis aculeis paucis brevissimis instructis. *Folia* pinnata, 5–8 poll. longa, rachi gracili, angulata, puberula, inermia vel aculeis paucissimis minutis instructa; foliola 5–9, stricte

opposita, sessilia, vel brevissime petiolulata (terminale graciliter petiolulatum), subcoriacea, lanceolata, $1\frac{1}{2}$ -3 poll. longa, longe acuminata, vix acuta, basi saepius rotundata, insigniter glanduloso-denticulata atque undulata, subtus pallidiora, supra hispidula. *Cymae* axillares, subsessiles, pauciflorae $1\frac{1}{2}$ -2 poll. diametro, pedicellis graciliusculis 3-6 lin. longis puberulis. *Flores* non visi. *Cocci* 2-4, parvi, oblique ovoidei, vix 2 lin. diametro, glabri, grosse glandulosi; *semina* nigra, nitida.

China: Nanto and mountains to the northward, province of Hupeh (A. Henry, 393⁸); South Wushan, province of Szechuen (A. Henry, 5646); above Chungking (Faber, 234).

Zanthoxylum emarginellum, Miq. in Ann. Mus. Bot. Lugd. Bat. iii. p. 22, descript. hic amplif.

Frutex speciosissimus trunco simplice (Ford). *Folia* ampla, glabra, pinnata, fere bipedalia; rachis glauca, teres, crassa, aculeis numerosis rectis complanatis a basi dilatata 2-5 lin. longis armata, parte infra foliola infima circiter 2 poll. longa; foliola speciminis fordiani 27, opposita, subsessilia, tenuia, fere membranacea, oblongo-lanceolata, maxima 5 poll. longa (superiora ac inferiora gradatim minora), sursum attenuata, apice insigniter emarginata, basi leviter obliqua, rotundata, brevissime crenato-denticulata, ad crenas et per totam laminam grosse pellucido-glandulosa. *Cymae* pedunculatae, circiter 2 poll. diametro, densiusculae, pedunculis bipollicaribus aculeatis, pedicellis brevibus. *Flores* . . . *Cocci* sessiles, 2-3 lineas diametro, pallidi, glabri, rugulosi; *semina* nigra, sphaeroidea, circiter $1\frac{1}{2}$ lin. diametro.—*Euonymo adfnis aromatico*, s. *Zanthoxylum spinosissimum*, *Fraxini angustiore folio punctatum*, Pluk. Amalth. Bot. p. 76, et Iconogr. t. 392. f. 1; Bretschneider, Early Researches into Ch. Fl. p. 72; *Zanthoxylum* sp. 13, Hemsl. in Journ. Linn. Soc. xxiii. p. 108.

Island of Chusan, Cunningham, Hb. Sloane, vol. xciv. p. 190 in Hb. Mus. Brit.; Kelung, Formosa, C. Ford, in Hb. Hort. Kew.

Zanthoxylum echinocarpum, Hemsl.

Arbor vel frutex aculeatus, ramulis fructiferis rigidis crassiusculis puberulis. *Folia* imparipinnata, 7-10 poll. longa, rachi graciliuscula puberula, praecipue subtus aculeata, aculeis circiter 1 lin. longis rigidis basi incrassatis recurvis; foliola 5-11, alterna vel interdum suboppo-

sita, breviter petiolulata, coriacea, saepius oblonga, nunc fere elliptica nunc oblanceolata, $1\frac{1}{4}$ – $4\frac{1}{2}$ poll. longa, $\frac{3}{4}$ –2 poll. lata, abrupte obtuseque caudato-acuminata, basi saepissime rotundata, utrinque secus costam primum puberula, margine minute glandulosa excepta eglandulosa, venis primariis lateralibus numerosis furcatis et inter se connexis subtus conspicuis; petioluli puberuli, 1–2 lineas longi. *Flores* dense racemosi, subsessiles, racemis 2–3 poll. longis. *Sepala* 4, oblonga, obtusa, persistentia, ut videtur valvata. *Petala* et stamina non visa. *Cocci* saepissime 4, sessiles, a latere compressi, 3–4 lineas longi, aculeis demum rigidis rectis 3–4 lineas longis armati, dispermi vel abortu monospermi; *semina* matura non visa.

China: Ichang and immediate neighbourhood, Hupeh (A. Henry, 3416 B and D).

Zanthoxylum dimorphophyllum, Hemsl.

Frutex 5–10 pedalis, ramis valde spinosis (A. Henry), ramulis floriferis rigidis minute puberulis inermibus vel aculeis rectis paucissimis armatis. *Folia* 1- vel 3-foliolata, nunc omnia 1-foliolata nunc omnia 3-foliolata et inaequalia, interdum 1- et 3-foliolata intermixta, petiolis $\frac{1}{2}$ – $1\frac{1}{2}$ poll. longis; foliola crassa, coriacea, subsessilia, vel plus minusve (praesertim terminale) distincte petiolulata, circumscriptione variabilia, sed saepissime ovato-oblonga vel ovato-lanceolata, 1–4 poll. longa, sed saepius $1\frac{1}{4}$ – $2\frac{1}{2}$ poll. longa, obtusa, basi rotundata, paucicrenata, glaberrima, vel primum supra secus costam puberula, supra nitida vel subopaca, tota crebre pellucido-glandulosa, glandulis majusculis. *Cymae* axillares, parvae, circiter 5–7-florae, pedicellis crassiusculis hirsutis 2–4 lin. longis. *Flores* unisexuales vel polygami, ♂ non visi, ♀ $2\frac{1}{2}$ –3 lin. diametro, apetalis, vel sepala petalis simillima, 5–9, crassa, basi incrassata, angusta, fere linearia, obtusa, longitudinaliter involuta, intus pilis paucis conspersa. *Carpella* 2–4, saepissime 2, lepidota, stylis crassis recurvis, stigmatibus magno capitato; ovula 2, collateralia, pendula. *Cocci* globosi, circiter 2 lin. diametro; *semina* nigra, nitida.

China: various localities near Ichang in the province of Hupeh (A. Henry, 3902, 4462, 4512, 5512, 7003).

Celastrus hypoglaucus, Hemsl.

Frutex alte scandens (A. Henry) undique glaberrimus, ramulis floriferis graciliusculis, cortice rubescente vel nigrescente. *Folia* graciliter petiolata, papyracea vel vix coriacea, oblongo-ovata,

elliptica vel interdum fere orbicularia, cum petiolo $2\frac{1}{2}$ – $5\frac{1}{2}$ poll. longa, maxima $2\frac{1}{2}$ poll. lata, saepius obtuse acuminata, basi rotundata, obscure denticulata, subtus nunc insigniter glauca nunc quam supra pallidiora. *Flores* flavi, 3–4 lineas diametro, saepius in racemos elongatos 4–9 poll. longos terminales dispositi, interdum cymosi, cymis axillaribus 3–5-floris, pedicellis 3–9 lineas longis; *calycis* lobi deltoidei, obtusissimi; *petala* quam sepala duplo longiora, oblonga vel fere elliptica, crispula, infra medium biauriculata et deorsum attenuata. *Capsula* sphaeroidea, nuda, circiter 3 lineas diametro, valvis 3–4 tenuibus crustaceis.

China: various localities near Ichang, Hupeh (A. Henry, 2837, 6771, 6811); South Wushan, Szechuen (A. Henry, 5887).

***Ventilago elegans*, Hemsl. (Plate VII.)**

Frutex scandens (A. Henry), dense ramosus, ramulis gracillimis flexuosis striato-angulatis puberulis, internodiis quam folia brevioribus. *Folia* disticha, breviter petiolata, subcoriacea, ovali-oblonga vel obovata, 6–12 lin. longa, apiculata, utrinque glabra, supra subnitida, venis primariis lateralibus utrinque saepissime 4 in dentes minutissimos excurrentibus, venis ultimis transversis creberrimis eximiis; petioli circiter 1 lin. longi, puberuli; stipulae minutae, setaeae, deciduae. *Flores* albi (A. Henry), circiter $1\frac{1}{2}$ lin. diametro, glabri, axillares, brevissime pedicellati, solitarii vel 2–3 aggregati; *calycis* lobi crassi, deltoidei, lobo acuti, intus carinati; *petala* quam sepala breviora, 3-lobulata, lobo intermedio multo minore, lateralibus complicatis stamen amplectentibus; ovarium 2-loculare, loculis 1-ovulatis, stylo crasso. *Fructus* glabri ala anguste oblonga, circiter 9 lineas longa; semen unicum, testa membranacea, embryo intense viridis.

Formosa: Ape's Hill (Hb. A. Henry, 489).

***Vitis formosana*, Hemsl. Species *V. umbellatae* similis sed cymis compositis brevissime pedunculatis.**

Frutex alte scandens (A. Henry), omnino glaber, ramulis floriferis graciliusculis angulatis, internodiis quam folia saepe brevioribus. *Folia* trifoliolata, breviter petiolata; foliola brevissime petiolulata, subcarnosa, inaequalia (lateralia minora plus minusve obliqua), oblonga, anguste lanceolata vel interdum fere ovata, 1– $2\frac{1}{2}$ poll. longa, subacuta, obtusa vel rotundata, basi saepe cuneata, interdum rotundata, obscure paucidentata, venis subtus (in foliis siccis) prominulis; petiolus $\frac{1}{2}$ –1 poll.

longus. *Cymae* axillares, compositae, umbelliformes, densae, brevissime pedunculatae, circiter 1 poll. diametro, pedicellis 1–2 lin. longis gracilibus. *Sepala* minuta, dentiformia; *petala* ovato-oblonga, vix acuta, vix 1 lin. longa, patentia, demum reflexa. *Bacca* ignota.

Formosa: Takow, Playfair, 203; same locality (Hb. Henry, 745).

Desmodium (§ *Eudesmodium*) *gracillimum*, Hemsl.

Herba vel suffrutex debilis, ramulis elongatis fere filiformibus radicantibus parce albo-strigillosis. *Folia* unifoliolata, longe graciliterque petiolata, tenuissima, pallide viridia, cordiformia, absque petiolo $\frac{1}{2}$ – $1\frac{1}{2}$ poll. longa, obtusa vel rotundata, utrinque parcissime strigillosa; petiolus gracillimus, 4–9 lin. longus; stipulae ac stipellae minutae, setuliformes. *Flores* perfecti non visi, parvi (circiter 2 lin. longi), albo-caerulei (*Henry*) pauci, in racemos laxos terminales dispositi. *Legumen* maturum non visum, breviter stipitatum, pubescens, angustum, rectum, circiter pollicare, articulis circiter 4 oblongis.

Formosa: Summit of Ape's Hill, Takow (Hb. Henry, 1160).

Crotalaria *similis*, Hemsl. Species *C. perpusillae*, Coll. et Hemsl. (Journ. Linn. Soc. xxviii. p. 37. t. 5) simillima sed foliis angustioribus &c.

Herba ramosissima, procumbens, undique dense longeque strigilloso-villosa, ramis gracilibus 2–4 poll. longis. *Folia* simplicia, subdisticha, conferta, brevissime petiolata, papyracea, ovato-oblonga vel obovata, $2\frac{1}{2}$ –3 lin. longa, apiculata, supra demum glabrescentia, punctulata. *Flores* pauci, ad apices ramorum conferti, breviter pedicellati, 3–4 lin. longi, bracteolis minutis lanceolatis calycis tubo adnatis; *calyx* dense villosus, distincte bilabiatus, labio antico alte trilobo, lobis angustis acutissimis declinato-curvatis, labio postico erecto vix ad medium bifido lobis latis apice oblique rotundatis; *petala* calycem vix excedentia, brevissime unguiculata, striata, vexillo orbiculari circiter 3 lin. diametro extus medio apicem versus strigilloso, alis late oblongis apice rotundatis, carina e basi lata curvato-acuminata; ovarium glabrum, circiter 12-ovulatum, stylo curvato gracili. *Legumen* oblongum, 4–5 lin. longum et 2 – $2\frac{1}{2}$ lin. latum, oligospermum; semina parva, nitida, compressa, reniformia.

Formosa: South Cape, Schmüser (Hb. Henry, 252).

Prunus (§ *Laurocerasus*) *xerocarpa*, Hemsl.

Arbor 10-pedalis (*A. Henry*) fere omnino glabra, ramulis floriferis

gracilibus primum minute puberulis vel pulverulentis rubescentibus. *Folia* petiolata, ut videtur persistentia, subcoriacea, lanceolata, cum petiolo 3-5 poll. longa, caudato-acuminata, obtusa, basi saepe subcuneata, integerrima, subtus pallidiora, rubro-punctata; stipulae cito deciduae non visae. *Flores* albi, circiter 4 lineas diametro, simpliciter racemosi vel racemoso-paniculati, paniculis folia aequantibus vel excedentibus, ramulis pedicellisque gracillimis; *calycis* tubus intus villosus; calycis lobi minuti, petaloidei, rotundati, crispulati; *petala* fere orbicularia, circiter $1\frac{1}{2}$ lin. diametro, crispulata; *stamina* circa 20; ovarium glabrum. *Fructus* exsuccus, pisiformis, globosus, 3-4 lin. diametro, epicarpio ut videtur tenuissimo, endocarpio crustaceo.

Formosa: Bankinsing mountains (Hb. Henry, 1656, 1658, 1658, A).

Photinia (§ *Eriobotrya*) *deflexa*, Hemsl. *Eriobotryae Hookerianae* proxime affinis, sed foliis longe petiolatis insigniter deflexis et grosse serratis.

Arbor 30-pedalis (*A. Henry*) ramulis fructiferis crassis puberulis. *Folia* longe petiolata, crassa, coriacea, deflexa, oblongo-lanceolata, pedalia, grosse irregulariterque serrata, serris curvatis obtusis, utrinque glabra, venis primariis lateralibus numerosis utrinque conspicuis in serras excurrentibus; petiolus $1\frac{1}{2}$ - $2\frac{1}{2}$ poll. longus, basi incassatus; stipulae deciduae non visae. Inflorescentia terminalis, cymoso-corymbosa, ramulis crassis, pedicellis brevissimis. *Flores* ignoti. *Fructus* ovoideus, 6-8 lin. longus, lignoso-suberosus, calycis lobis oblongis obtusis lanatis coronatus; *semina* ovoidea.

Formosa: Bankinsing (Hb. A. Henry, 498).

Itea parviflora, Hemsl.

Frutex glaber vel glabrescens, ramulis floriferis gracilibus, internodiis quam folia multo brevioribus. *Folia* distincte petiolata, tenuia, papyracea, glabra, anguste lanceolata vel oblongo-lanceolata, 2-4 poll. longa, acuminata, obtusa simul apiculata, basi cuneata, sursum plus minusve crenato-serrulata et subundulata, subtus pallidiora, venis primariis lateralibus utrinque saepius 5 vel 6 arcuatis subtus sat conspicuis, venis ultimis transversis pulchre reticulatis; petiolus gracilis, 3-6 lin. longus. *Racemi* axillares, gracillimi, 1-3 poll. longi, multiflori, interdum puberuli, pedicellis gracillimis 1-2 lin. longis. *Flores* albi, circiter lineam longi, conferti; *calycis* dentes elongato-

deltoidi, vix acuti, quam petala dimidio breviores, tubo intus hirtello; *petala* anguste ovato-lanceolata, vix acuta, medio indistincte carinata, persistentia. *Capsula* 2-3 lin. longa, saepius puberula, polysperma; *semina* elongata, gracilia, fusiformia.

Formosa: South Cape, Schmüser (Hb. A. Henry, 965, 1263, 1322).

Most nearly related to *I. chinensis*, differing in its narrow, thin leaves, smaller flowers, relatively broad petals, and puberulous capsule.

***Diospyros utilis*, Hemsl.**

Arbor magna (*A. Henry*), ramulis fructiferis crassis sericeo-hirsutis. *Folia* alterna, breviter petiolata, crassa, coriacea, oblonga vel lanceolata, 5-8 poll. longa, maxima 3 poll. lata, acute acuminata, basi biauriculata vel superiora minora interdum rotundata vel cuneata, undulata, supra glabra, costa impressa, subtus albida, dense arcte appresseque sericeo-strigillosa, costa elevata; petiolus crassus, teres, 3-4 lin. longus. *Flores* . . . *Fructus* edulis (*A. Henry*) subsessilis, depresso-globosus, fere 2 poll. diametro, tomentosus, saepius 8-locularis, sepalis amplis crassis sericeo-tomentosis fere orbicularibus persistentibus subtendus; *semina* oblonga, compressa, testa nigra nitida crassissima dura, albumine non ruminato.

Formosa: Bankinsing mountains (Hb. Henry, 815).

Dr. Henry describes this as a large tree furnishing a good wood, used for making axles, and an edible fruit called *mao-shih*, that is, hairy persimmon.

***Behmannia Oldhami*, Hemsl.** in Journ. Linn. Soc. xxvi, p. 194; descriptio hic amplificata.

Perenne, undique albo-hirsutum, caulibus saepius simplicibus gracilibus maximis cum inflorescentia 3-pedalibus sed saepius brevioribus. *Folia* distincte petiolata, membranacea, opposita, subopposita, vel inferiora saepe alterna, saepe obliqua, ovata vel obovata, maxima cum petiolo 9 poll. longa, sed saepius breviora, grosse et inaequaliter serrata, utrinque strigilloso-hirsuta. *Racemi* simplices vel interdum ramosi saepe valde elongati et gracillimi,*supra medium proliferi, corporibus minutis carnosis fasciculatis instructi; pedicelli demum circiter semi-pollicares. *Flores* flavi (*A. Henry*), maculati, 1¼-1½ poll. longi; *calycis* segmenta lineari-lanceolata, acutissima, 4-5 lin.

longa; *corolla* anguste ventricoso-tubulosa, limbo obliquo lobis brevibus rotundatis; *stamina* 4, inclusa, antheris per paria cohaerentibus. *Capsula* ovoidea, calyce inclusa, in valvas 4 placenticide dehiscens; *semina* minuta linearia vel cylindrica, breviter funiculata, in utroque termino cristata.

Formosa: Ape's Hill, Takow, on the sides of cliffs in dry, shaded situations (Hb. A. Henry, 1052).

There is now no doubt that this plant belongs to the genus *Rehmannia*; and there is also little doubt that this genus would be better placed in the Cyrtandreae.

***Mesona procumbens*, Hemsl. (Plate VII.)**

Herba procumbens, radicans, caulibus elongatis 2-3-pedalibus graciliusculis pilis paucis debilibus instructis vel demum glabrescentibus. *Folia* distincte petiolata, tenuia, fere membranacea, ovata vel ovato-lanceolata, cum petiolo gracili 1-2 poll. longa, acuta, basi rotundata vel subcuneata, grossiuscule calloso-serrata, praecipue subtus pilis paucis tenuissimis conspersa, venis primariis lateralibus utrinque saepius 6; petiolus 3-6 lineas longus. *Verticillastri* dense racemosi, racemis densis terminalibus vel axillaribus cum pedunculo 2-3-pollicaribus, pedicellis brevissimis; bractee rotundatae, ciliatae, subito caudato-acuminatae, cauda demum sub laminam arcte recurva. *Flores* minuti, cum staminibus exsertis circiter 2 lineas longi, setulosi; *calyx* fructifer auctus, circiter 1½ lin. longus, scariosus, longitudinaliter 10-costatus et insigniter transverse multicostatus, irregulariter bilabiatus, demum clausus, tubo leviter inflato, labio antico oblongo integro apice rotundato, labio postico inaequaliter tridentato dentibus omnibus acutis; *corolla* alte bilabiata, hians, tubo brevissimo, labio antico concavo cymbiformi extus parce villosus, labio postico lato breviter tridentato, dente intermedio obscure emarginato; *stamina* longe exserta, declinata, filamentis staminum duorum posteriorum basi appendiculatis, appendiculis oblongis hirsutis. *Nuculae* anguste ellipsoideae, glabrae.

Formosa: South Cape: collected by Schmüser (Hb. Henry, 1317).

This is a very distinct species, and markedly so in its much elongated procumbent stems. It seems evident that Wallich's genus *Geniosporum* must be reduced to *Mesona*; the only difference given being the presence or absence of appendages at the base of the posterior filaments; but these are often very minute and easily

overlooked where they do occur, and scarcely furnish a character of generic importance. Comparing our figure of *Mesona procumbens* with that of *Geniosporum strobiliferum*, Wall. in Hooker's 'Icones Plantarum' t. 462, the resemblances, it will be seen, are very strong.

Helictia formosana, Hems. in Journ. Linn. Soc. xxvi, p. 394. Descriptio hic amplificata (Plate VIII).

Folia maxima fere pedalia et $4\frac{1}{2}$ poll. lata, interdum grosse serrato-dentata. Racemi circiter 6 poll. longi. *Fructus* depresso-globosus, $1-1\frac{1}{4}$ diametro: semen unicum, cotyledonibus hemisphaericis.

Formosa: Bankinsing mountains, near watercourses (Hb. Henry, 805).

Liparis macrantha, Rolfe.

Caulis erectus, subcarnosus, subelongatus. *Folia* membranacea, petiolata; limbus elliptico-ovatus, breviter acuminatus, basi obliquus, $4-4\frac{1}{2}$ poll. longus, $2-2\frac{1}{2}$ poll. latus; petiolus latus, $1\frac{1}{4}-1\frac{3}{4}$ poll. longus, basi laxe tubuloso-vaginatus, membranaceus. *Scapus* $\frac{3}{4}-1$ ped. altus, multiflorus. *Bractea* parvae, triangulo-ovatae, acutae, reflexae, vix 1 lin. longae. *Pedicelli* 9 lin. longi. *Sepalum* posticum lanceolatum; lateralia falcato-lanceolata, subobtusata, $5\frac{1}{2}-6$ lin. longa, $1\frac{1}{2}$ lin. lata. *Petala* angustissima, 7 lin. longa. *Labelium* obcordatum, apiculatum, denticulatum, $5\frac{1}{2}$ lin. longum, 5 lin. latum, basi bituberculatum. *Columna* $2\frac{1}{2}$ in. longa.

Formosa: Tamsui (Hb. A. Henry, 1695 l).

A remarkable species with dark purple flowers an inch in diameter.

Phreatia formosana, Rolfe.

Planta caespitosa. *Folia* linearia obtusa, basi paullo attenuata, 3-6 poll. longa, 2-3 lin. lata. *Scapi* graciles, elongati, multiflorae, 6-7 poll. longae. *Bractea* lanceolatae, acutae, $1-1\frac{1}{2}$ lin. longae. *Pedicelli* $\frac{3}{4}$ lin. longi. *Sepala* ovata, subacuta, $\frac{3}{4}$ lin. longa. *Petala* ovata, subacuta, sepalis paullo minora. *Labelium* breviter unguiculatum; limbus late trulliformi-cordatus, subobtusus, $\frac{3}{8}$ lin. latus. *Columna* brevissima.

Formosa: South Cape (Hb. A. Henry, 1349).

Allied to *P. elegans*, Lindl., but the lip more distinctly trulliform.

Agrostophyllum formosanum, Rolfe.

Caules erecti, 9-10 poll. longi, subcompressi, distichophylli. *Folia* lineari-oblonga, obtusa 4-6 lin. longa, 9-11 lin. lata, vaginae conduplicatae, imbricatae. *Capitulum* subsessile, densiflorum, 16 lin. latum. *Bractae* lanceolato-oblongae, obtusae, striatae, 2 lin. longae. *Sepala* ovata, subacuta, lateralia carinata, concava, $1\frac{1}{2}$ lin. longa. *Petala* linearia, obtusa, torta, $1\frac{1}{2}$ lin. longa. *Labellum* 2 lin. longum, hypochilio subhemisphaerico-saccato, epichilio reniformi-ovato obtuso. *Columna* crassa, 1 lin. longa.

Formosa: South Cape (Hb. A. Henry, 1350).

Allied to *Agrostophyllum majus*, Hook. f., from Perak.

Calanthe formosana, Rolfe.

Folia petiolata, lanceolata, acuta, 12-14 poll. longa, $1\frac{1}{2}$ - $2\frac{1}{2}$ poll. lata; petiolus 6-7 poll. longus. *Scapus* 10-12 poll. altus; vaginae spathaceae, basi tubulosae, $1\frac{1}{2}$ - $1\frac{3}{4}$ poll. longae. *Bractae* lineari-lanceolatae, acutae, $1-1\frac{1}{2}$ poll. longae, $2\frac{1}{2}$ -3 lin. latae. *Sepala* lanceolata, acuminata, 5 lin. longa, $1\frac{3}{4}$ -2 lin. lata. *Petala* lanceolata, breviter acuminata, subobliqua, uninervia, membranacea, $4\frac{1}{2}$ lin. longa, $1\frac{3}{4}$ lin. lata. *Labellum* supra medium columnae adnatum, trilobum, 3 lin. longum, lobis lateralibus rotundatis, intermedio oblongo apiculato, disco laevi, calcare gracili, $2\frac{1}{2}$ lin. longo. *Columna* 2 lin. longa, apice dilatata.

Formosa: South Cape (Hb. A. Henry, 1347).

Allied to the Indian *C. clavata*, Lindl., but with a differently shaped lip, and the spur not clavate. The bracts much resemble those of *C. densiflora*, Lindl., belonging to another group. The buds are not expanded, and probably the flowers exceed the dimensions here given.

Geodorum formosanum, Rolfe.

Folia oblongo-lanceolata, acuta, $\frac{1}{2}$ -1 ped. longa, $1\frac{1}{2}$ - $2\frac{1}{2}$ poll. lata. *Scapi* 6-10 poll. longi, apice nutante, basi laxae vaginati. *Bractae* lineari-lanceolatae, 5-6 lin. longae. *Pedicelli* graciles 2- $2\frac{1}{2}$ lin. longae. *Sepala* et petala oblonga vel spathulato-oblonga, obtusa, $4\frac{1}{2}$ lin. longa. *Labellum* ovato-oblongum, obtusum, obscure bilobum, basi saccatum, 5 lin. longum, $3\frac{1}{2}$ lin. latum, disco medio incrassato obscure tricarinato. *Columna* clavata, 2 lin. longa.

Formosa: Takow (Hb. A. Henry, 1137), South Cape (Hb. A. Henry, 1375). I am unable to identify this with any Indian species.

Tropidia formosana, Rolfe.

Herba erecta, 1 ped. alta. *Folia* late lanceolata, acuta, membranacea, 4-5 poll. longa, $\frac{3}{4}$ -1 $\frac{1}{4}$ poll. lata, vaginis laxis. *Racemi* abbreviati, subcapitati, 6-7 lin. lati. *Bracteae* lanceolatae, acutae, striatae, 2 lin. longae. *Pedicelli* 1 $\frac{1}{2}$ lin. longi. *Sepala* oblonga, acuta, 3-3 $\frac{1}{2}$ lin. longa, 1 lin. lata, mento saccato. *Petala* oblongo-lanceolata, subobtusata, sepalis subaequalia, nervo medio incrassata. *Labellum* oblongum, subobtusum, basi saccatum, sepalis subaequale. *Columna* clavata, 1 $\frac{1}{2}$ lin. longa.

Formosa: Bankinsing (Hb. A. Henry, 1573).

Allied to the Philippine *T. septemnervis*, Rchb. f.

Zeuxine formosana, Rolfe.

Caules subrepentes. *Folia* petiolata, ovata, apiculata, limbus 1 $\frac{1}{4}$ -1 $\frac{3}{4}$ poll. longa, 6-11 lin. lata; petiolus 6 lin. longus, infra medium tubuloso-vaginatus. *Scapus* 10-14 poll. altus, pubescens. *Bracteae* ovato-lanceolatae, acuminatae, 4-5 lin. longae, pubescentes. *Sepalum* posticum ovatum, subobtusum, concavum, 2 $\frac{1}{2}$ lin. longum; lateralia oblonga, subobtusata, 3 lin. longa. *Petala* oblique semiovata, subobtusata, 2 $\frac{1}{2}$ lin. longa. *Labellum* 3 lin. longum, basi cymbiforme, bicallosum, medio constrictum, angustum, apice dilatato-bilobum, lobis suborbicularibus. *Columna* lata, apice bibrachiata, 1 $\frac{1}{2}$ lin. longa.

Formosa: South Cape (Hb. A. Henry, 644).

This species somewhat resembles *Zeuxine flava*, Benth., in habit, but the flowers are fully twice as large.

Cheirostylis chinensis, Rolfe.

Rhizoma repens. *Folia* breviter petiolata, late ovata, acuta vel apiculata, puberula, 5-8 lin. longa, 3-6 lin. lata; petiolus 2-2 $\frac{1}{2}$ lin. longus, basi dilatatus, breviter tubuloso-vaginatus. *Scapus* gracilis, 3-5 poll. altus, pubescens, paucivaginatus, pauciflorus. *Bracteae* elliptico-oblongae, obtusae, submembranaceae, 1 $\frac{1}{2}$ lin. longae. *Perianthium* subhemisphaericum, 1 $\frac{1}{2}$ lin. longum. *Petala* elliptico-oblonga. *Labellum* unguiculatum, limbo flabellato bifido grosse dentato 3 lin. lato. *Columna* brevis, appendicibus subulatis.

Formosa: South of island (A. Hance, 390), Summit of Ape's Hill, Takow (Hb. A. Henry, 320); Hongkong (Ford, 130).

Allied to the Indian *C. flabellata*, Wight.

Goodyera formosana, Rolfe.

Herba elata, $2\frac{1}{2}$ -3 ped. alta. *Folia* elliptico-lanceolata vel oblonga, acuta vel subacuminata, 6-7 poll. longa, $2-2\frac{1}{2}$ poll. lata. *Scapus* pubescens, vaginis lanceolatis, numerosis. *Racemus* elongatus, multiflorus, 1 ped. longus. *Bractea*e lanceolatae, acuminatae, 3-5 lin. longae. *Sepala* ovato-lanceolata, subacuta, pubescentia, $3\frac{1}{2}$ -4 lin. longa. *Petala* spatulato-lanceolata, subacuta, $3\frac{1}{2}$ -4 lin. longa. *Labellum* $3-3\frac{1}{2}$ lin. longum, basi concavo-saccatum, venis fimbriato-villosis, medio abrupte contractum, dein lineari-subulatum, apice reflexum. *Columna* clavata, 2 lin. longa.

Formosa: Bankings mountains (Hb. A. Henry, 409). 'Flowers whitish.'

This species has the habit of *G. fumata*, Thw., of Ceylon, to which it is most nearly allied.

EXPLANATION OF THE FIGURES IN
PLATES VII AND VIII.

Illustrating Mr. Hemsley's paper on New Plants from Eastern Asia.

PLATE VII.

- A.* Flowering and fruiting branches of *Ventilago elegans*. Natural size.
Fig. 1. A leaf, slightly enlarged to show the transverse venation.
Fig. 2. Vertical section of a flower.
Fig. 3. A petal spread open and stamen.
Fig. 4. The same in its natural position with the stamen drawn forward.
Fig. 5. Front view of an anther.
Fig. 6. Back view of an anther.
Fig. 7. A fruit.
Fig. 8. Vertical section of the same.
Fig. 9. Embryo, showing the large, almost terete cotyledons.
All the figures enlarged except *A*.

- B.* Flowering and fruiting stem of *Mesona procumbens*. Natural size.
Fig. 10. A verticillaster, with bract; all the flowers except one removed.
Fig. 11. A corolla laid open, showing the appendaged filaments.
Fig. 12. Back view of an anther.
Fig. 13. Pistil.
Fig. 14. Calyx in the fruiting stage.
Fig. 15. Fruit.
All the figures enlarged, except *B*.

PLATE VIII.

- C.* Flowering branch of *Helicia formosana*. Natural size.
Fig. 16. An expanded flower.
Fig. 17. Upper part of a segment of the perianth with stamen attached.
Fig. 18. Back view of anther.
Fig. 19. Pistil and disk; upper part of style removed.
Fig. 20. Vertical section of ovary.
Fig. 21. A fruit.
Fig. 22. A seed from which the membranous outer testa has begun to disappear.
Fig. 23. The same wholly removed, revealing the dimorphic inner testa, the upper half of which is rugose, the lower smooth.
Fig. 24. One of the hemispherical cotyledons and minute radicle.
Figures 16 to 20 enlarged; 21 to 24 natural size.

NOTES.

SPORANGIA OF LITOSIPHON, HARV.—A CORRECTION.

—I regret that I fell into error in stating (Annals of Botany, Vol. VIII, p. 459) that the plurilocular sporangia of *Litosiphon* are unknown. Dr. Bornet has called my attention to the following paragraph (which I ought to have remembered) in the *Etudes Phycologiques* of Thuret and Bornet, p. 15: 'A côté du *Punctaria* se place le *Litosiphon*, Harv., dont la fructification est tout à fait semblable. Dans les deux genres les sporanges uniloculaires sont globuleux, irrégulièrement épars sur la fronde, à la surface de laquelle ils ne font qu'une légère saillie. De part et d'autre les sporanges pluriloculaires sont disposés en groupes, et résultent de la division des cellules de la couche corticale. . . Les cellules corticales se divisent simplement, sans que leur forme soit modifiée, en quatre ou huit logettes dont chacune renferme un gros zoospore.' As the same error is made in Reinke's Atlas deutscher Meeresalgen (II. 3-5, S. 61) its correction is the more necessary.

T. JOHNSON, Dublin.

EXPERIMENTAL RESEARCHES ON VEGETABLE ASSIMILATION AND RESPIRATION. NO. 1. ON A NEW METHOD FOR INVESTIGATING THE CARBONIC ACID EXCHANGES OF PLANTS¹. By F. F. BLACKMAN, B.Sc., Demonstrator of Botany in the University of Cambridge.—All the processes hitherto available for the estimation of carbon dioxide in its biological relations are open to serious objections, either on the score of the amount of time involved in their performance or of their inadaptability to the estimation of small quantities of carbon dioxide when slowly evolved.

The present communication describes an apparatus in which, as a result of two years' work, I have succeeded in combining a high degree of chemical accuracy with special adaptability to biological research.

¹ Abstract of a paper read before the Royal Society.

Thus by its aid the evolution of CO_2 by a single germinating seed or by a small area of a foliage leaf, can be accurately estimated from hour to hour without a break for any desired time, while for the same area of leaf the more active absorption of CO_2 in assimilation can be easily determined for such short periods of time as fifteen minutes, and that at the same time separately for the two surfaces of one and the same leaf area. Further, for the purposes of this assimilation, a current of air containing any desired proportion of CO_2 , however small, can be supplied continuously to the tissue under investigation, while, if desired, estimations of the CO_2 evolved in respiration by some other part can be carried on simultaneously in a separate current of air freed from CO_2 . This is made possible by the apparatus being practically in duplicate; strictly comparative experiments can thus be carried out.

The actual estimation of the CO_2 is accomplished by the well-known method of absorption by baryta solution and titration with hydrochloric acid. The novelty consists in this—that only a very small quantity of baryta solution (under 15 c.c.) is employed in each experiment, and that after the absorption the whole of this is titrated with acid in the tube in which the absorption has taken place. Further, the burettes containing the standard solution are always in air-tight connexion with this absorption chamber, and no air beyond the current under investigation is ever admitted to the chamber, except such as has been carefully freed from CO_2 . The special arrangements for stirring and emptying, by means of this air freed from CO_2 , and stored under pressure, cannot be entered into here.

The two currents of air passing continuously through the apparatus are generated by two aspirators of a special type, which, worked on the principle of Mariotte's bottle, give a practically constant outflow in drops, whatever the level of the water within them, and are adapted to work steadily with small rates of flow (50 to 100 c.c. per hour). These currents enter the apparatus, either through an arrangement for removing the CO_2 when working on respiration or when working on assimilation through one for adding CO_2 . Both these are so constructed that the current never has to bubble through a layer of liquid, and so is supplied to the plant at strictly atmospheric pressure, thus avoiding any risk of drawing gases mechanically out of the part under investigation. The remover of CO_2 is a 'tower' full of beads, over which a stream of strong potash

flows continuously, and through which the air is drawn. The CO_2 generator is constructed on a new principle, and consists of a tall tube containing fragments of marble, through which the air current passes at a constant rate, while very dilute HCl trickles down it at an extremely slow rate, which is made constant and independent of external variations of temperature by special arrangements. Thus a constant amount of CO_2 is being continually generated, and is carried off by the air current. The amount of CO_2 formed can be controlled by the strength of the acid employed. When generating amounts below 2 per cent. of the air current this arrangement works very constantly. From the CO_2 generator or remover, as the case may be, the current of air passes to the receivers, in which the parts of the plant under investigation are situated. These receivers are of various forms, according to the material experimented on, but are all constructed on the cardinal principle of making them as small as possible consistent with the well-being of the part, in order that changes in the composition of the gas shall, as soon as possible, be felt by the current which passes thence through narrow tubes to the absorption chambers. When titrations are being made, and the air current can no longer be allowed to pass through the absorption chambers, it passes through a column of water equal in its resistance to that of the baryta solution in the absorption chamber. This enables the rate of flow to be kept constant between, as well as during, the actual experiments. Numerous other details, such as the special method of refilling the burettes, &c., and above all those small points by which constancy is, as far as possible, attained, many of which have involved weeks of special experiment, cannot be described here.

Simplification of technique by complication of apparatus has been the guiding principle, and the result is that, although the whole consists of at least eight separate pieces of apparatus, many being further in duplicate, and all connected together by a plexus of tubes, yet the working is so automatically arranged that the operator, beyond reading the burettes and occasionally working a finger bellows, has nothing to do but turn stopcocks.

If only one series of estimations is being made, these can be kept absolutely consecutive, the current being led through one of the absorption chambers, while the solution in the other one is being titrated and renewed, and so on alternately. When two series of comparative estimations are being made at once, a small interval

must be allowed after each double estimation, during which the titrations are performed; the currents of air in connexion with the plants then pass through bye-paths, still at their previous rate. This interval, in which a double titration, emptying and refilling of the absorption chambers, is accomplished can be reduced to ten minutes.

Delicacy of estimation sufficient for present work is obtained by the use of half-decinormal, $N/20$, standard solutions. Phenolphthalein is used as indicator, and specially delicate end-reactions can be obtained, since atmospheric CO_2 is excluded, and moreover the burettes containing *both* the solutions can be drawn upon.

The burettes, narrow and graduated in $1/10$ c.c., are read to $1/100$ c.c., with a simple arrangement for avoiding parallax. All other usual precautions are taken, and series of control titrations, with an error of observation of not more than 0.1 per cent., are often obtained. This corresponds to $1/200$ c.c. CO_2 .

In experiments of short duration, $1/50$ c.c. CO_2 is found to be sufficient for a trustworthy estimation from which definite conclusions may be drawn.

The communication immediately following the present one, illustrates the applicability of this apparatus to the investigation of minute quantities of carbon dioxide.

EXPERIMENTAL RESEARCHES ON VEGETABLE ASSIMILATION AND RESPIRATION. NO. 2. ON THE PATHS OF GASEOUS EXCHANGE BETWEEN AERIAL LEAVES AND THE ATMOSPHERE¹. By F. F. BLACKMAN, B.Sc., Demonstrator of Botany in the University of Cambridge.—On the question of the path by which carbonic acid passes out of the leaf in respiration and into it in assimilation, whether this takes place by the stomatal openings or through the continuous surface of the cuticle, all possible extreme and intermediate views have been expressed in recent textbooks of botany. On account of the smallness of the quantities of gas involved practically no attempt has hitherto been made to determine this question by direct estimation. The existing experimental evidence is all of an indirect nature, and tends rather to support the view that the exchange is a cuticular phenomenon.

An ingenious synthesis of Graham's observations on the com-

¹ Abstract of a paper read before the Royal Society.

parative readiness with which CO_2 osmoses through thin films of caoutchouc, with observations by Frémy and others on the similarity between cuticle and caoutchouc in chemical composition, first led Barthélemy (1868) to put forward the view that the cuticle was specially adapted for transmitting CO_2 from the external air to the assimilating cells beneath it. This view he supported by experiments on the artificial osmosis of gases through leaves. About the same time Boussingault performed experiments that seemed to definitely show that in assimilation the CO_2 taken up by the leaf entered it through the upper surface, devoid of stomata, to which the assimilating cells are adjacent, rather than through the more distant stomatal openings. These experiments have hitherto been generally accepted, but I shall show later that the conclusions drawn from them are entirely fallacious. In support of the view that stomata form the paths of gaseous exchange, besides isolated inductions by various workers, we have the conclusion arrived at in 1888 by Mangin, from diffusion experiments on isolated cuticle, that this diffusion is insufficient to account for the whole gaseous exchange of the leaf.

By the aid of the apparatus described in a previous paper the author has been able to successfully attack the problem directly by estimating the amounts of CO_2 given out or taken in by the two surfaces of the same leaf, under the same conditions. For this purpose shallow capsules, 10 sq. cm. in area, consisting of a glass plate with a metal rim, through which tubes for the circulation of the air current pass, are employed. Two of them are affixed to a leaf on opposite sides of the same area in air-tight union by means of soft wax. Then, in the way described previously, two continuous currents of air can be kept up over the two surfaces, and the CO_2 produced or taken in during a given time by each of them be determined.

Numerous experiments on the respiration of a variety of leaves, thick and thin, with the stomata all on the one side or with stomata variously distributed on the two sides, agree in showing that the stomata are the site of the exhalation of this gas. When no stomata are present on the upper surface of a leaf then practically no CO_2 is exhaled from that surface, at least not more than falls within the working error of the apparatus under these conditions, while more than thirty times as much may be given off from the lower stomatiferous surface. When stomata occur on both surfaces the relative

amounts of CO₂ exhaled closely follow the ratios of the numbers of stomata.

A few examples in illustration of this may be given.

	A.	B.	C.
<i>Ampelopsis hederacea</i>	$\frac{0}{8}$	$\frac{0.003}{0.100}$ c.c. CO ₂ per hour and 10 sq. cm.	$\frac{3}{100}$
<i>Alisma plantago</i>	$\frac{135}{100}$	$\frac{0.030}{0.025}$ " " " 10 sq. cm.	$\frac{120}{100}$
<i>Iris germanica</i>	$\frac{100}{100}$	$\frac{0.029}{0.026}$ " " " 10 sq. cm.	$\frac{110}{100}$
<i>Ricinus communis</i> ...	$\frac{100}{250}$	$\frac{0.015}{0.037}$ " " " 10 sq. cm.	$\frac{100}{260}$

Column A gives the proportionate number of stomata on the two surfaces; B the amounts of CO₂ exhaled by these; C the ratios of these amounts. Each experiment lasted about fifteen hours.

Experiments on the absorption of CO₂ during assimilation showed the same close relation to the distribution of stomata. For these experiments a constant fixed amount of CO₂ must be introduced into the air stream supplied to the leaf, which makes the experiments much more complicated.

As hitherto carried out, direct sunshine, continuous for several hours, has been essential for the success of these experiments. They are, consequently, but few in number, though perfectly clear in their interpretation.

In an experiment on the leaf of *Ampelopsis hederacea* with no stomata on the upper surface, air containing 1.6 per cent. CO₂ was supplied to both surfaces at the rate of 22 c.c. for every fifteen minutes; of the 0.37 c.c. of CO₂ entering the capsule on the lower surface 0.14 c.c. was absorbed in, while none at all was absorbed by the upper surface. With a leaf of *Alisma*, on the contrary, the whole of the CO₂—0.15 c.c.—supplied in fifteen minutes to the upper surface was absorbed, and 0.11 c.c. of that supplied to the lower. In this leaf the stomata are in the ratio of 135 above to 100 below, to which ratio the absorption numbers closely correspond. A very

simple experiment will show that stomata are practically the sole path of entry of CO_2 for assimilation. If part of the lower stomatic surface of any leaf with no stomata on its upper surface (*Sparmannia* gives very clear results) be coated with wax so as to mechanically block the stomata, no starch can be formed in that area, while the adjacent areas become rich in starch. I performed this experiment in 1893, and showed it to some botanists; recently it has been published by Stahl¹.

As stated previously, the theory of 'cuticular exchange' has hitherto found its strongest support in the experiments of Boussingault, in which, under similar conditions, leaves of *Nerium Oleander* assimilated less when the upper stomatiferous surface had been coated with an unguent than when the lower stomatiferous surface had been so coated. From this he drew the obvious conclusion that the CO_2 of assimilation normally passes into the leaf through the cuticle of the upper surface. Exposure of the interesting experimental fallacy here concealed, however, quite reverses the interpretation of these experiments. Boussingault experimented with leaves in an atmosphere containing 30 per cent. CO_2 . Now the optimum percentage of CO_2 for assimilation is very low for this leaf, and the real interpretation of the result is that the diminished decomposition of CO_2 in the leaf with open stomata is due to its obtaining not *less* CO_2 but *more* CO_2 . In fact, there penetrates into it so much CO_2 that its assimilatory activity is lessened and falls below that of the other leaf into which, owing to the blocking of the stomata, the CO_2 only diffuses very slowly, and cannot exceed the optimal strength. This view has been conclusively proved by a series of experiments in different strengths of CO_2 . In a small percentage the leaf with its stomata open decomposes more CO_2 than the leaf with its stomata blocked—a result just the reverse of Boussingault's.

Further evidence on the possible paths of gaseous exchange has been obtained by investigating the degree to which diffusion of CO_2 can be artificially produced through the living leaf. Strong mixtures of CO_2 are led continuously across one surface of a leaf, and the amount which diffuses through is estimated. On supplying 31 per cent. CO_2 to the lower surface of a leaf of *Nerium* only 0.035 per cent. appears by diffusion in a slow current of air kept continually

¹ Botanische Zeitung, July, 1894.

passing over the upper surface of the leaf. Other experiments on the respiration of rejected leaves support the view that the stomatal openings, in spite of their minuteness, offer a very much easier path from the atmosphere to the interior of the leaf than does the cuticle.

Conclusions.—1. Under normal conditions practically the sole pathway for CO_2 into or out of the leaf is by the stomata. Since oxygen diffuses more readily than CO_2 through fine openings, the same probably holds for oxygen and the whole of the gas-exchange.

2. Under abnormal conditions, when the stomata or intercellular spaces are blocked and the surrounding tension of CO_2 is great enough, passage of CO_2 by osmosis through the cuticle may take place.

3. That such closure of stomata as is held to take place in darkness does not prevent the distribution of gas-exchange closely agreeing with that of the stomata.

4. That the exhalation of CO_2 in bright light by a leafy shoot in Garreau's well-known experiment is not the expression of any physiological truth, but only due to the imperfections of the conditions. Isolated green leaves fully illuminated allow no CO_2 to escape from them.

SOME NEW BRITISH ALGAE.—While collecting at Weymouth in September, 1892, I found some Algae which do not appear to have been previously described. Full descriptions and figures of these will appear in an early number of the *Annals of Botany*. In the meantime, as I have distributed specimens of the plants amongst my friends under manuscript names, it may not be out of place to give very short descriptions of them now.

Among the most interesting was a little epiphyte on *Castagnea Griffithsiana*, J. Ag., which proved to be the type of a new genus which I have called after my friend Mr. T. H. Buffham.

The genus **Buffhamia** belongs to the Chordariaceae, and may be described as follows: Fronds simple, cylindrical, solid, composed of an inner layer of large angular-roundish colourless cells and a cortical layer of closely-packed small coloured cells, from which at maturity arise short, jointed assimilating filaments (paraphyses), plurilocular sporangia and colourless hairs. Plurilocular sporangia, the only form of reproductive organs at present known, linear-oblong with obtuse or slightly pointed apices, stalked.

Buffhamia speciosa, nov. sp. A small plant from a quarter to one and a quarter inch in length and about 1 mm. in breadth. Characters the same as those of the genus.

Tellamia.—A new genus of Chlorophyceae named in honour of Mr. R. V. Tellam, of Bodmin. Thallus yellow- or brownish-green, or more rarely a clear grass-green, minute; composed of radiating branched jointed threads with tun-shaped or oval cells very much constricted at the joints. At first the filaments are rolled up into an almost spherical ball, afterwards they spread out and branch in all directions. Reproduction by zoospores formed in the swollen cells, which frequently become nearly globular. The species of this genus grow in the periostracum of the common yellow periwinkle (*Littorina obtusata*, L.).

Tellamia contorta, nov. sp. Filaments closely interwoven, much branched in an irregular manner, branches curled and twisted, frequently falcate, cells oval, 3-10 μ in diameter, usually 6-9 μ long but sometimes much longer. Irregular swellings are not uncommon in this species.

Tellamia intricata, nov. sp. Fronds slender, much branched, branches opposite or alternate, patent, seldom falcate or recurved. Cells oval or oblong, 2.5-4 μ in diameter, 4-24 μ long. The two species frequently grow side by side, but are easily distinguishable, the filaments of *T. contorta* being much darker coloured than those of *T. intricata*.

Myriotrichia densa, nov. sp. In the Journal of Botany for November, 1891, Mr. T. H. Buffham describes and figures the plurilocular sporangia of a *Myriotrichia* which he refers to *M. clavaeformis*, Harv., at the same time expressing surprise that the form of this species bearing plurilocular sporangia should be so different from that bearing the unilocular. Since the publication of that paper I have found the plant figured by Mr. Buffham, at Arran, Cumbrae, and Weymouth, but with both unilocular and plurilocular sporangia. Both forms are exactly alike outwardly. Frequently both forms of reproductive organs occur on the same individual. The plant appears to me quite distinct from any described species of *Myriotrichia*; I have therefore named it *M. densa*.

E. A. L. BATTERS.

ON AN ORCHID-DISEASE. — The common Orchid-disease known as 'spot,' characterized by the formation of brown spots on the leaves, proves to be due to the presence of a species of *Plasmodiophora*, which will be known as *Plasmodiophora Orchidis*. A detailed account of its life-history will be given in this Journal at a later date.

G. MASSEE.

The Proteids of Wheat.

BY

M. O'BRIEN, B.Sc.,

Scholar of the 1851 Exhibition.

[The small reference figures throughout the Article refer to the numbers in the Bibliography given at the end.]

I.

NOWADAYS we are so accustomed to think of definite grains as the normal form of nitrogenous reserves in seeds, that we look on the occurrence of gluten in wheat as exceptional. Curiously enough, however, it seems to have been the first form investigated, so that we find physiological chemists at the beginning of this century trying to identify the nitrogenous organic substances of other seeds with the gluten of wheat. The same idea is embodied in the name *Klebermehl*, given by Hartig (1855^{16a}) to what are known as aleuron-grains, and in the term *Aleuron* itself which he introduced (1856^{16b}) for the nitrogenous crystalloid parts of these grains.

This however was nearly a hundred years after the death of Beccari¹ (1766), who first investigated and isolated the tenacious substance to be obtained from wheat-flour by washing; and named it *gluten*. It probably soon attracted attention, but its characteristics cannot have been very fully studied last century, for we find Einhof stating in 1805 that chemists deny its solubility in alcohol. (Reference is given to Cadet² as one of these.)

[Annals of Botany, Vol. IX. No. XXXIV. June, 1895.]

Einhof's³ researches seem to have been chiefly concerned with rye and barley, among the cereals; but incidentally he describes some of the properties of the gluten of wheat. By washing rye-flour a tough gluten-like mass is at first obtained, but on continuing the washing this mass breaks down to a crumbly substance—a fact which he attributes to the sugar and *Pflanzenschleim* present. His results may be thus tabulated:—

N. matter soluble in water	{	coagulated on boiling	(1) Pflanzenweiss.
		not coagulated	(2) Honey-like residue on evaporation.

The residue (2) may be resolved by treatment with alcohol into—

i. Kleber	Soluble in alcohol.
ii. Pflanzenschleim	Soluble only in water.

The 'Schleim' he seems to consider capable of being transformed into sugar^{3b}, and therefore of the nature of a gum or carbo-hydrate; it is, however, probably nitrogenous in character, giving a precipitate with tannic acid (cf. Ritt-hausen's Mucedin; Einhof's *Schleim*, however, is precipitated by alcohol). The *Kleber* he identifies with the gluten of wheat, which, likewise, he describes as soluble in alcohol. Wheat-gluten, he says, though insoluble in the cold, dissolves on boiling with alcohol: whence we might conclude that it entirely did so, but for his statement that not so much of gluten dissolves when separated as is the case when it is still mixed with the other constituents of flour. His attempt to identify gluten with the albumin (*Pflanzeneiweiss*) is interesting, but it had to be abandoned because albumin is precipitated by alcohol, whilst gluten is to some extent soluble in it. Though his work is but little quoted, there is surely justice in his claim, 'zu fernern Untersuchungen wenigstens die Bahn gebrochen zu haben.'

Taddei⁴ however is usually credited with having, in 1819, first divided gluten into two substances by means of alcohol:

Gluten	{	soluble in boiling alcohol	gliadin.
		residue, insoluble in alcohol	zymom.

Gliadin is described as being partly deposited on cooling ; as soluble in boiling water, to a frothy liquid ; soluble in alkalis, only slightly soluble in acids, and insoluble in cold water. It forms a transparent, straw-yellow, sweetish mass, which on warming gives the smell of baked apples. (This I have not seen mentioned by any other writer, nor have I noticed it in the alcohol-extract from gluten. It is very marked, however, in a similar extract from bran—probably showing form-aldehyde. Nitric acid added to this solution is violently decomposed with evolution of red fumes.) The residue, *Zymom*, received its name (*ζύμη*, ferment) from its power of causing fermentation ; it does not, however, itself ferment. It is soluble in acids, forms a kind of soap with alkalis, and is hardened by limewater and alkaline carbonates. It forms one-third of the volume of moist gluten, and is said to occur in many other vegetable bodies.

Though the name has not been adopted, I shall for the sake of clearness use the term *Zymom**, as introduced by Taddei, to signify the part of gluten insoluble in boiling alcohol. Gliadin (*γλοία*, glue) having been variously used by later writers, I shall employ the word *Glian* * for the whole of the alcohol-soluble part of gluten.

Berzelius⁶ carried the analysis by means of alcohol a step further, resolving glian into—

- (1) Pflanzenleim soluble in cold as well as in hot alcohol [glutine*].
 (2) Schleimige Stoffe precipitated from alcohol solution on cooling [myxon*].

For the former we may at once adopt the term proposed for it by De Saussure⁷ in 1833, *Glutine* *. The latter substance appears later both as Fibrin and as Casein according to the theory of the writer : so for the sake of distinction we must find some name which commits us to neither view. I shall therefore designate as *Myxon* * (*μύξα*, slime) that part of gluten which is precipitated on cooling from solution in hot alcohol.

To these constituents of gluten a fourth was added by De Saussure⁷, *Mucine* *. This name may be retained (as it

* See table, p. 194.

has not been otherwise used with reference to plants) to denote that portion of the alcohol-soluble part of gluten (glian) which is soluble in cold water. As De Saussure was mainly concerned to find the constituent of gluten which effects the conversion of starch into sugar, and as he thought that mucine was the active substance, it was to this that he gave his chief attention, not distinguishing between glutine and myxon, as is shown in the following table—

Gluten	{	Insoluble in alcohol	Eiweiss [zymom].
		Soluble in alcohol, insoluble in water	Glutine [glutine and myxon].
		Soluble in alcohol and in water	Mucine.

From his omission of any distinct mention of what I have called myxon, later writers have identified his mucine with it : but as myxon represents about two-thirds of the dry weight of gluten, and mucine only 1%, this is an impossible interpretation of his results.

Almost simultaneously with De Saussure's work, that of Payen and Persoz resulted in the discovery of diastase. Doubtless to the mixture of this ferment with gluten is due the action on starch which Kirchof (1813) attributed to gluten itself, De Saussure to mucine. A solution prepared as he prepared mucine, by constant reprecipitation by water of the glutine in the glian-extract, would contain diastase ; but it is difficult to believe that it could retain its diastatic power if the first part of the preparation had been effected by boiling.

Boussingault⁸ in 1837 made a further step by the chemical analysis of crude gluten, of alcohol-soluble gluten (glian), and of pure gluten obtained by the solution of gluten in acetic acid and its precipitation by ammonium carbonate. He likewise noted that gluten does not constitute the whole of the nitrogenous matter of flour, extracting from the washings of gluten 1% of an albumin coagulating at 80° C. [Cf. Einhof's Pflanzeneiweiss from rye^{3a}; and an albumin described by M. Henri in the washings of gluten, 1822.] The amount of nitrogen found in pure gluten was large, 18.9%, agreeing closely with that in the albumin, 18.4%.

Mulder⁹ likewise analysed both albumin and myxon from

wheat. But his work is noteworthy rather for his elucidation of the similarity of animal and vegetable proteids than as regards our special subject. To him we owe not only the name 'proteid,' but also the xanthoproteic reaction.

Liebig¹¹ and his school working at vegetable proteids gave considerable attention to the proteids of wheat, in which they distinguish an albumin and gluten. In the separation of gluten into its constituent parts Liebig does not proceed further than to zymom and glian (fibrin and *Pflanzenleim*); he does not consider it necessary to isolate mucine, for the two substances described agree so closely in chemical composition with crude gluten that the presence of a third, essentially different, substance is improbable.

Both albumin and *Pflanzenleim* (glian) are described by him as practically identical with egg-albumin; zymom only differs in its greater insolubility and is for the first time clearly identified with animal fibrin. Animal casein is not represented in wheat, but replaces gluten in leguminous and in oily seeds.

Wheat Proteids	{	Albumin		Other seeds	{	Albumin
		Gluten	{	Fibrin [zymom]	{	Casein(Legumin)
				<i>Pflanzenleim</i> [glian]	}	

About the same time the French chemists, Dumas and Cahours¹³, were also working out the identity of animal and vegetable albuminous substances, and investigated the albumin and gluten of wheat very fully. They recognised in gluten the three constituents described by Berzelius; but the names they give indicate the more advanced, i. e. the comparative, stage which the inquiry had now reached.

Wheat Proteids	{	Albumine		Fibrine [zymom]
		Gluten	{	[glian] {
				Caseine [myxon]
				Glutine

Zymom, they, too, describe as fibrin; and, like Mulder and Liebig, connect it closely with albumin, but point out that it is somewhat richer in nitrogen. The coagulated form of it however, with a smaller percentage of nitrogen, closely

corresponds to the albumin both of blood-serum and of white of egg. It is in fact suggested that fibrin, existing in the plant in a soluble state, may be the mother-substance which gives rise to albumin as a secondary product. Though glutine and myxon are described as isomeric, yet the former is placed with the vitelline of egg-yolk outside the group of true proteids; whilst myxon is named caseine. So closely however is it also allied to albumin that the question arises, 'Is it indeed true casein, or a modification of albumin which has some of the properties of casein?' There is here an important difference from Liebig, according to whom casein is represented in the vegetable kingdom by legumin, and does not occur in wheat. We may notice that Dumas considers legumin as a mixture of casein and albumin with a third substance richer in nitrogen; whilst Ritthausen later classifies legumin as a vegetable casein, with zymom (gluten-casein), and not with any part of the alcohol-soluble proteid of gluten (glian).

Thus more than fifty years ago some of the problems of modern vegetable physiology were at least clearly stated: and though perhaps the outlines of the classification of proteids may be for the present considered settled, yet the position of the characteristic proteids of wheat is no better defined than it was half a century ago, and the questions then raised as to the possible transformation of one form into another are still without satisfactory answer.

No further addition seems to have been made to the knowledge of gluten till about 1860, when we come to the work of Von Bibra, Günsberg, and Ritthausen. Although in the interval an important step in the investigation of the proteids of the blood had been made by Denis, the advance in animal physiology did not affect the methods of vegetable physiology till nearly 1870.

Von Bibra¹⁸, writing in 1860, seems (as quoted by Ritthausen) to have kept to the subdivisions of Berzelius and Dumas, viz., fibrin [zymom], Pflanzenleim [glutin], casein [myxon].

Günsberg¹⁹ (1862) comments severely on the confusion of

terminology in the subject and goes back to the position in which the matter was left by Taddei, gluten being resolved into zymom and gliadin [glian]. Though he rejects myxon as a distinct body, considering it but a mixture of *Pflanzenleim* and gluten-particles, yet he does not consider gliadin to be a single substance. Its separation he effects by means of boiling water into: (1) a 'leimartig' substance, soluble in boiling water, and (2) a residue soluble only in alcohol. The former is richer in nitrogen (17.78%) than gliadin (15.88%), the residue is poorer (14.10%). The latter seems very like what I have described as myxon; the former seems to consist of glutine and mucine, for a part of it is soluble even in cold water. The important point seems to me to be this, that by the use of boiling water instead of boiling alcohol the division line between the soluble and insoluble parts of glian (never a hard and fast one) is now drawn at a different place. Unfortunately, in this as in many other cases, no account is given of the proportion in which these different constituents appear in gluten.

Ritthausen²² may next be mentioned, for his researches go back beyond 1860, though his complete results were only published in 1872. He thus classifies the proteids of seeds:

1. Plant-Albumin.
2. Plant-Casein
 - a. Legumin.
 - b. Gluten-casein [Zymom].
 - c. Conglutin.
3. Plant-Gelatine (*Pflanzenleim*) or Gluten-proteids.
 - a. Gliadin or *Pflanzenleim* [Glutine].
 - b. Mucedin [Mucine].
 - c. Gluten-fibrin [Myxon].

Whence it will be seen that he ignores the work of animal physiologists and hardly attempts to bring vegetable proteids into line with those of the animal kingdom: a position which he defends later (1877²⁴), insisting on the differences of ultimate chemical composition between the various vegetable proteids as well as between these and animal proteids.

The proteids he obtains from wheat are as follows :

Wheat proteids	{	Soluble proteids	{	Albumin (N = 17.60%)
				Non-coagulable proteid
		Gluten	{	Gluten-casein [zymom] (N = 17.14%)
				Gluten-fibrin [myxon] (16.89)
				[glian] {
				Gliadin [glutine] (18.01)
				Mucedin [mucine] (16.63).

The albumin has a percentage of nitrogen (17.60) higher than that obtained by any of the older chemists except Boussingault (18.4). The composition of the albumin is very similar to that of zymom (gluten-casein, N = 17.14%). Though the amounts of nitrogen differ, a similar relation is seen in the results of Liebig¹¹ and Mulder; whilst Dumas and Cahours¹³ make their zymom slightly the richer of the two in nitrogen. In gluten the four constituents already described are recognised; not more than three of them had yet been distinguished by any one writer (except perhaps Günsberg).

Ritthausen's change of name of zymom from fibrin to casein, and the reverse change for myxon, depends rather on the identity of the former with legumin (vegetable casein) than with animal casein. His analyses, however, seem to point to the same conclusion as those of the earlier investigators. Thus he finds zymom richer in nitrogen than myxon (*see table*); and recent analyses give for fibrin about 17% of nitrogen (Hammarsten, 16.91), for casein not quite 16% (Chittenden and Painter, 15.91; Hammarsten 15.70; Ritthausen 15.46). This is the same relationship as is shown by the results of Dumas: animal fibrin, 16.598, animal casein, 15.85; zymom, 16.41, myxon, 16.04. The change of name is also based on the results of decomposition with sulphuric acid, and on the greater solubility in dilute acids of the alcohol-soluble proteids. But zymom seems, from Ritthausen's own figures, to be at least as near to the glian-proteids as to the vegetable caseins in the preponderance of glutamic over aspartic acid;

	Veg. Caseins.		Zymom.	Glian.	Mucedin.
Glutamic acid (per cent.)	1.5	4.0	5.33	8.8	25
Aspartic " "	3.5	2.0	0.33	1.1	1 :

whilst as regards solubility in dilute acids I shall show that this is not great in the alcohol-soluble proteids.

In one or two physical points, moreover, myxon behaves somewhat like the casein of milk; which may more readily than fibrin be made to dissolve in part in dilute alcohol, and which forms a skin on the exposed surface of a solution cooling in the air. So characteristic of Ritthausen's gluten-fibrin (myxon) is such skin-formation that it is used to distinguish it from gliadin and mucedin.

A full account is given of the preparation and of the properties of these four substances: I can only point out that they are by no means sharply marked off from each other. Thus myxon is soluble in alcohol 80-90% in the cold, in alcohol 30-70% only on heating. Gliadin [glutine] is most soluble in alcohol 70-75% and is slightly soluble in water; mucedin is somewhat more soluble in water, but is precipitated in the cold by 90-95% alcohol. In chemical composition zymom is hardly distinguishable from mucedin; as regards solubility they are at the extremes of the series. The proportion in which these bodies occur is said to vary in the gluten of different wheats: and no estimate is given beyond an instance in which zymom formed 28% of the dry weight of gluten. Gliadin [glutine] is specially variable—on it is said to depend the tenacity and elasticity of gluten.

While these investigators were thus elaborating the knowledge of the constituents of gluten and the composition of particular proteids, others were determining the more general characters of proteid bodies and their relation to each other.

Denis¹² as early as 1840 had found the value of neutral salts in the separation of proteids. Though his special work was on the blood¹⁷, yet he described a substance found in peas, beans, almonds and wheat, soluble in dilute solution of sodium chloride, and precipitated from it by excess. This he named 'glutine,' believing that there was one vegetable proteid which appeared under the varying forms of legumin, amandin, gluten, vegetable albumin, casein and fibrin.

Kühne²⁰ (1864) investigated the composition of animal

muscle and isolated its characteristic proteid, which he named myosin.

Hoppe-Seyler systematised the work of these and other observers and introduced a simple classification and nomenclature for proteids. The term 'globulin' introduced by Berzelius¹⁰ for the coagulable proteid of the red blood-corpuscles had been used by Denis in a wider sense. It did not appear in the classification adopted by Hoppe-Seyler in the second edition of his *Handbuch*^{21a} (1865), but in the third^{21b} (1870) it is used as a generic term for those proteids which are soluble in dilute solutions of neutral salts. Myosin and vitellin are described as subdivisions of it: the former name only dates from 1865 (Kühne), the latter was in use at least as long ago as 1842¹³. Like Mulder, Dumas, and Liebig, but on surer grounds than had been before possible, he comes to the conclusion that there is no reason for regarding vegetable proteids as in any essential way different from animal.

Weyl²³, carrying out the ideas of Hoppe-Seyler as regards vegetable proteids, published in 1877 a paper which called forth vigorous opposition from Ritthausen. In it he claims to have proved the complete identity in chemical behaviour of vegetable and animal proteids. He finds that globulins constantly occur in plants, and suggests that the legumin and casein hitherto described are derivatives formed from these by the reagents (alkalies or acids) used in their extraction. His chief generalisations are that (1) the globulins of plants (vitellin and myosin) show the reactions of animal globulins; (2) no albuminates occur in fresh seeds, plant-caseins being secondary products in the seed or artificially produced in manipulation; (3) that by the action of water, acids, and alkalies, all globulins become first albuminates, then coagulated proteids. From seeds formerly described as containing casein, he extracts vitellin (oats, maize, peas, almonds, white mustard, Brazil nuts), or myosin (wheat, peas, oats, white clover, almonds).

To the list of proteids common to plants and animals—globulins, albuminates, and coagulated proteids—Professor

Vines^{26, 31} (1878–80) added the albumoses, which, as well as globulins, he investigated in the aleuron-grains of many seeds.

The methods and results of Hoppe-Seyler and his school were at first severely criticised by Ritthausen²⁴, who noticing only a preliminary account of Weyl's paper, charged him with insufficient observations, and these on a part only of the proteid of the seed. For as the vegetable caseins are insoluble in salt-solution, Weyl must, he contends, have worked only with the substances in the wash-fluids.

The fuller publication of the researches of Weyl left no ground for this argument; and in 1878 Barbieri²⁵ made the important announcement that the substances obtained by the methods of Ritthausen and of Weyl are identical in ultimate chemical composition. His work was a careful comparison of different analyses of the proteid of pumpkin seeds, which may be described as casein or vitellin, according to its method of preparation.

This conclusion was accepted by Ritthausen, and both methods were adopted by him in his later investigation²⁷ on the proteids of oily seeds. He however rejected the idea that there was any need to change his original nomenclature.

The views of Hoppe-Seyler and his principles of classification seem now universally accepted, at least such is the case in England, where they are followed by, among others, Foster, Haliburton, Sheridan Lea, Vines, Green, and Martin. The task of modern botanists is thus simplified; such a scheme of classification being recognised, their work is to bring into line with it all the proteids newly investigated or already described. This is gradually being done for one substance after another; but the attempts to co-ordinate the proteids of gluten with other vegetable proteids hardly seem as yet to have been successful. And if I am unable to assign them to their true position, it may not be quite without use to have indicated that this is still to be done.

An investigation, in 1880, of the origin of gluten was undertaken by Weyl²⁸, in conjunction with Bischoff, which does not seem to have been so successful as his former work. It led

him to the conclusion that gluten is formed by the action of a ferment on the myosin which he had already described as the chief proteid of wheat. This theory is based on the observations that flour extracted with salt-solution (NaCl) yielded no gluten, and that flour kept for some time at a temperature of 60°C. likewise lost its gluten-forming power. At the same time the authors admit that no ferment can be isolated, and that the addition of fresh flour to that injured by heating to 60°C. does not improve the yield of gluten, as should be the case were it dependent only on the presence of a ferment. Moreover they themselves suggest that coagulation of the myosin, not the destruction of a ferment, may be the cause of the non-formation of gluten after the heating of flour.

Johanssen³⁸, treating of gluten in 1888, proposes to himself the following questions: (1) How does gluten form in the washing operation? (2) What tissues of the grain take part? In reply to the former he states that he finds the ferment theory unnecessary, and seems to imply that gluten occurs as such in a finely divided state among the other remains of the inner endosperm-cells. The answer to the second emphasises what Schenk (III. 6) from another point of view had stated in 1872, that the so-called 'Kleberzellen' contain only aleuron-grains and not the gluten (*Kleber*) itself. Johanssen finds (1) that a temperature of 60°C. does not injure the gluten-forming power of flour; (2) that an artificial flour formed by mixing powdered gluten and starch behaves in every way like ordinary flour. Hence it is probable that gluten exists as such in flour. The retarding effect of cold and of salt-solutions is ascribed to the less perfect moistening of the gluten-particles, the favourable effect of heat to the greater cohesiveness of the particles, while its inhibitory effect at a high temperature is due to coagulation.

Kjeldahl's³⁷ results I can only state as quoted by Johanssen. A minimum and a maximum temperature may be determined, limits beyond which no gluten-formation occurs; 40°C. is the optimum. There is a close correspondence between these temperatures and the minimum, optimum and maximum for

fermentation. Mercuric chloride fixes the proteid of flour and so prevents gluten-formation, whilst it is promoted in poor flour or even in barley-meal by the addition of a small quantity of good flour.

Martin³⁵ (1886) at once supports the ferment-theory, and, following up Weyl's researches, tries to bring the proteids of wheat into line with the more typical proteids—two propositions which are by no means dependent on each other. Finding in an extract of flour made with water or 10% salt-solution, (1) an albumose, (2) myosin, he considers these as the precursors respectively of (1) the insoluble phytalbumose (glian) and (2) the fibrin (myxon), which together constitute gluten. The two latter substances differ from the former in their insolubility in cold water and salt-solutions, and the solubility in alcohol acquired by the albumose.

Balland's³² long series of observations (1883-93) on wheat-flour gives results differing from many of those used in support of the ferment-theory. Thus he finds that gluten may be made from flour which has been kept for some time at 80° or even at 100°C.; that it may be obtained at 2°C. from flour previously kept at -8°C.; and that its formation is in some cases actually promoted by the use of salt-solutions. He concludes his last paper, written in 1893⁴², with the words: *Le gluten préexiste dans le blé.*

The opinion current among practical bakers may be gathered from the statement of Jago³⁴, that gluten exists in flour as a fine powder, swelling up on addition of water into the well-known tenacious mass.

On the one hand, therefore, is the theory of gluten-formation by ferment-action, supported by Weyl and Bischoff, Kjeldahl and Martin: on the other hand, the pre-existence of gluten in flour is maintained, on apparently sufficient grounds, by Johanssen and Balland. The question, then, of the origin and formation of gluten, like that of the nature of its proteids, is one which has not yet received a final answer.

II.

My own observations on the proteids of flour may be described under the following headings :

A. Action of water on flour.

- i. Globulins.
- ii. Proteose.
- iii. Gluten.

Substances derived from gluten : zymom ; glian, including myxon, glutine, mucine.

*B. Action of solutions of salt (NaCl).**C. Action of Alcohol.*

Albuminate.

*D. Relation between gluten and the albuminate.**A. Action of Water on Flour.*

The addition to wheat-flour of about half its bulk of water causes, as is well known, the formation of a thick tenacious paste whose characteristic properties are due to gluten, a nitrogenous elastic substance in which the starch, cell-walls, and other parts of the inner endosperm of the wheat-grain are at first embedded. So coherent, however, is the gluten-mass that by prolonged washing in water these other substances may be almost entirely removed, crude gluten remaining behind. Fat and colouring-matter may be removed by ether ; but it is impossible to get rid of the last traces of starch.

Gluten, however, does not constitute the whole of the nitrogenous matter of the flour ; the washings of gluten also give proteid reactions, and two kinds of proteid may be distinguished. When the slightly acid liquid thus obtained by washing is neutralised, no appreciable precipitate is formed : therefore no acid-albuminate is present. On boiling, however, coagulation occurs, indicating either globulin or albumin ; on removal of this by filtering, the solution still gives proteid reactions, so that a proteose or a peptone must also be present. As the whole of the proteid matter originally present in the washings is precipitated by saturation of the solution with magnesium sulphate, the presence of albumin and

of peptone is precluded: the proteids present must therefore be globulin and proteose respectively.

Thus, as obtained by water, the proteids of wheat are:

{ Soluble in water	{	ppt ^d . by boiling	i. globulin
		remaining in solution	ii. proteose
} Insoluble in water			iii. gluten.

However, these apparently simple facts by no means explain the whole matter, since the amount of gluten obtainable from even the same flour seems to vary with varying conditions. Thus we are told that the yield of gluten is increased by allowing the paste to stand for some time before washing it (Bénard and Girardin²⁹, Balland³²); or by the use of 'hard' rather than of pure water (Ritthausen²²): whilst heating of the flour to 60°C., or extraction of it with salt-solution (NaCl 15%) (Weyl and Bischoff³⁰), or with ether (Peligot¹⁵), are alike said to prevent the subsequent formation of gluten on addition of water.

1. *Globulin of Flour.* In order to allow the water equal access to every particle of flour, so as to obtain the greatest possible amount of water-soluble proteid, the flour was carefully sifted through muslin into the water. Even with this precaution gluten formed instantaneously, but it could readily be removed from the liquid by filtration after the starch had been allowed to settle to the bottom. Globulin was obtained by coagulation of the filtrate by heat as a flocculent white precipitate, drying to a brownish, brittle, semi-transparent, horny mass; or, if the boiling has been prolonged, to a greyish-white, powdery substance. It swells up on the addition of water or alcohol (75%) to a somewhat viscid mass. It is difficult to collect and estimate, but seems to form about 1% of the weight of the flour: 1.10% was the amount obtained by extraction with water, 1.01% by extraction with NaCl.

The coagulation by heat is accomplished in two stages: about 55°C. a milkiness or cloudiness appears, indicating myosin; when this is removed by filtering, the solution may be kept at 60°C. for some hours without further coagulation

occurring. On gradually raising the temperature, coagulation is found to begin again at from 75–80°C., and a dense flocculent coagulum is obtained: heat, however, of nearly of 100°C. is necessary for complete coagulation. This plainly indicates (the absence of albumin having been shown by the complete precipitation with $MgSO_4$) that vitellin is present in addition to myosin. This is further shown by the fact that saturated salt-solution extracts a globulin from flour; and perhaps by the tendency to form crystals (see later). Where an estimate was made, I found myosin .19%, vitellin .819%; total globulin 1.009% (cf. total globulin extracted by salt, 1.01%).

It may be noticed that oats likewise contain both myosin and vitellin (Weyl), as do also mustard-seed and peas (Weyl) and maize (Chittenden and Osborne). In fact the distinction between the two classes of globulins, though a natural one in animal physiology, seems by no means well marked in plants. Thus Martin⁸³ describes a myosin of papaw-juice coagulating at 74°; and states that the myosin of wheat may become insoluble even at 35°–40°C. Vines suggests the possibility of one form of globulin passing over into the other, i. e. of plant-vitellin becoming myosin. A third and still more soluble form of globulin is described in maize by Chittenden and Osborne. Vitellin is, in solubility, a connecting link between globulins and albumins; like the former, it is insoluble in pure water; like the latter, it is not precipitated by saturation with NaCl, but it is precipitated by $MgSO_4$, while they are not. These typical degrees of solubility are shown by the globulins of wheat (cf. following table, to which albumin is added for the sake of comparison):

NaCl (dilute)	Albumin. soluble	Vitellin. soluble	Myosin. soluble
NaCl (saturated)	} soluble	} soluble	} insol.
NaCl (dil., at 60°C.)			
$MgSO_4$ (saturated)	soluble	insol.	insol.
$(NH_4)_2SO_4$	insol.	insol.	insol.

The globulin of wheat is obtainable also in a crystalline

form, but as yet I have only been able to prepare it on a very small scale. The globulin is precipitated from its salt-solution by alcohol, filtered, washed with dilute alcohol, and re-dissolved in salt-solution (NaCl). The process of crystallisation can then be watched under the microscope in a drop of this solution. As the water evaporates, the proteid is first deposited on the surface of the slide in hexagonal plates. Usually three of the angles are formed, and then two parallel sides are continued for some time; many of these forms occur side by side, springing from an irregular mass of proteid—a perfectly regular hexagonal plate is rare. Occasionally a large, well-defined, double hexagonal pyramid is seen, or what appears to be a dodecahedron with triangular faces. As evaporation proceeds, the salt is also deposited, either independently in large crystals or else in tiny cubic crystals covering the hexagonal areas laid down, and rendering their outline less distinct. Addition of water of course causes the proteid crystals to dissolve in the re-formed salt-solution; but it is, with care, possible to fix them and so show their proteid nature. Fixing with alcohol was not successful—probably it was not allowed to act for a sufficient time. But if the slide with proteid and salt-crystals is placed in a concentrated solution of tannic acid, the salt dissolves whilst the proteid is fixed. After careful washing the hexagonal proteid plates remain on the slide, and the pyramidal crystals retain their outline though with a slightly contracted and collapsed appearance. With a saturated solution of picric acid similar results may be obtained, though with greater difficulty, as much care is required in washing away the excess of picric acid. Similar proteid crystals were incidentally observed on a slide on which a section of barley had been left in salt-solution.

The tendency to crystallisation seems strong. Precipitated by alcohol, globulin separates in minute, irregular, flake-like forms, from which, by treatment with NaCl on a slide or in a watch-glass, crystalline forms may be obtained. Coagulated by boiling, globulin settles out in spheres embedded in a more

or less homogenous net-like matrix ; in addition to the spheres there are many rhombohedra, and apparently transitional forms between these and the spheres, the six faces becoming less distinct and the angles disappearing. These octahedral forms and spheroids seem similar to the crystallised proteids described by Osborne : octahedra occurring in the proteids of Brazil-nut, hemp-seed and oat-kernel, associated with the rhomboid form, with spheroids, and occasionally with hexagonal plates—a form to be expected in association with the others.

ii. *Protease of Flour.*—In the watery extract of flour, as well as in an extract made with NaCl solution, a proteid remains in the filtrate after removal of the globulins by boiling. It is not precipitated by saturation with NaCl, but is precipitated by $MgSO_4$ and also by HNO_3 in the cold ; the latter precipitate disappears on heating to reappear on cooling. This indicates a protease ; but the biuret reaction was not satisfactory. A drop of dilute solution of $CuSO_4$ caused a precipitate in the protease solution, but this did not dissolve in KOH to the typical red solution ; instead, a turbid yellow liquid results, from which a yellowish orange precipitate settles out, perhaps due to reduction by the sugar sometimes present in flour. The protease was not further isolated ; it appears to be present only in small quantities. As it readily gives the characteristic reaction with nitric acid, and is precipitated by copper sulphate, it is probably one of the primary albumoses (proto- or hetero- of Kühne and Chittenden).

Ritthausen and earlier writers had mentioned a non-coagulable proteid obtained in the washings of gluten ; it was first described by Martin³⁵, who considers it the precursor of the insoluble phytalbumose (? glian) of gluten. Such a transformation seems hardly probable ; for the proteases are themselves probably hydrolysed products of the albumins and globulins, with a smaller molecule ; one would expect that further hydrolysis would continue the process towards greater solubility. The corresponding small amount discovered by Osborne in the oat and in the maize-kernel he

considers secondary, and this may well be the case here likewise.

iii. *Gluten*.—This may be formed in fine strands on a slide under the microscope by adding a drop of water to a few grains of flour and moving the cover-glass over it. These strands give the usual proteid reactions and stain sharply with various aniline-dyes, e. g. methyl-violet and saffranin. The only at all characteristic stain that I can find is aniline-blue (*Wasserblau*) or Hoffmann's blue. On addition of either of these, freshly dissolved in water, the gluten-strand gradually colours and swells up, losing its sharp contour—probably owing to the acid nature of the reagent. These strands are otherwise singularly stable, being apparently unaffected by irrigation with solutions of sodium chloride, sodium phosphate, sodium carbonate, and even for some time with dilute potash. In acetic acid they swell up, but on washing or neutralisation appear as fine and complete as before: this is likewise the case with hydrochloric acid; sulphuric acid acts more strongly, the gluten at first appearing fixed but soon dissolving, in the dilute acid or in concentrated.

In obtaining gluten for quantitative estimation, my method was to add water at 30° C. to 10–15 grams of flour, till a stiff paste was formed. This was left to stand for an hour, and was then washed by moving it gently with a glass rod on a piece of muslin loosely stretched and dipping into a beaker of water at 30° C.; there is thus no need to allow any particles of gluten to become isolated from the mass. The chief danger of loss is in the particles of gluten which necessarily adhere to the dish in which the paste is formed: they are best collected and washed, at first, independently of the rest. As the starch is removed, the gluten becomes sufficiently coherent to be held in the fingers, and may at this stage be washed under the tap. In a short time the gluten contracts to a tough mass; in fact throughout the process it is becoming less viscid and elastic. Washing should be continued till the mass of damp gluten pressed on a slide leaves no starch-grains in a drop of water. The prepared Hungarian flour

which I used yielded about 10% of crude gluten as dried in bulk at 100° C., when treated according to the above method of washing. I found however that with a little care, even under what are usually described as unfavourable circumstances, I could obtain the same amount from it, as the following experiments indicate.

(1) Flour was sifted carefully through muslin into a beaker of water; the intention being to dissolve as much as possible of whatever proteid in it was soluble in water. Gluten, however, seemed to form instantaneously; as when the starch had sunk to the bottom, a drop of the supernatant fluid showed strands of gluten under the microscope. This could be collected by filtering: and the whole mass, having been left on the filter during the night, yielded, on washing out the starch in the usual way, .516 gram gluten from 5 grams flour (10.32%). Hence it follows that (a) water removes nothing essential to the formation of gluten; and (b) if a ferment is present it must be ubiquitous.

(2) Similarly, to 10 grams of flour saturated salt-solution (NaCl) was added; a stiff non-tenacious paste was the result, indicating that gluten had not been formed. On further addition of salt-solution some proteid was extracted (Vitellin, .0819 gram = .819%). Water was then added so as to produce a dilute salt-solution (about 10% NaCl), and now gluten was recognisable in the liquid; this was collected as before, and a total of 1.113 grs. was ultimately obtained (Gluten = 11.13%). Myosin (.019 gr., = .19%) was obtained from the dilute salt-extract, by coagulation. Hence the formation of gluten from a globulin in the flour is precluded; for, under these circumstances specially favourable to its collection, only the normal amount (1.009%) was obtained.

(3) The fact that gluten was obtained in the usual quantity by forming the paste and conducting the earlier stages of washing entirely with a 10% salt-solution, further proves its independence of globulin:—10 grams flour yielded 1.075 gram gluten, i. e. 10.75%.

(4) Whilst Weyl and Bischoff²⁸ found that heating flour at

60° C. destroyed its gluten-forming power, Johanssen³⁸ and Balland³⁹ consider it unaffected. I found that flour, kept at 100° C. for thirteen hours in all on two successive days, yielded gluten in the slightly diminished quantity of 9.91%; another result with flour kept at 100° C. for two hours, on two successive days, was 11.53%; whilst a third result after three hours was the normal amount of 10.625%.

(5) I found that even when boiling water was added to flour at 100° C. gluten formed apparently to the usual extent; but owing to the impossibility of readily separating it from the starch-paste simultaneously formed, the weight was not determined. This surely precludes the possibility either of the origin of gluten from globulin, or of ferment-action.

(6) Nor do extremely low temperatures seem to much affect the formation of gluten. Flour was extracted with a mixture of salt and snow, which removed globulin as at ordinary temperatures. On placing the residue on a filter and adding water to remove the excess of salt, a coherent paste formed showing the presence of gluten, and this at a temperature only just above 0° C. The paste was, it is true, less tenacious than gluten at ordinary temperatures; but this in turn is less elastic than gluten at 30° C.

(7) Gluten was obtained from flour which had been about twenty-four hours in absolute alcohol, as well as from flour which had been moistened with ether or with 75% alcohol, when these had evaporated. It is to be noticed however that it could not be obtained when the part of the flour which is soluble in 75% alcohol was extracted; though, as has been already mentioned, it could be readily obtained when the constituents soluble in salt-solution were removed.

When dried, gluten is semi-transparent, yellowish-brown, and glue-like in appearance; of an opaque whitish-yellow when moist. When dried in a mass of about 1 gram at 100° C., it loses above 50% of its weight: so that where it has been necessary to calculate I have used 44% as the amount of dry gluten in the crude moist mass (unless the percentage had been separately determined for the gluten in question). The

relative accuracy of this is confirmed by adding the amount of zymom (28.3) and glian (15.32) obtained from moist gluten: they give 43.6% for the dry weight. Probably not more than 40% is pure gluten, for further loss of water may be effected by drying in a finely powdered state; and starch and other impurities are present. It may be dried at 100° C., and be kept for months without losing its power of becoming tough and elastic with water—as I found contrary to what is frequently stated. On dehydration with absolute alcohol it becomes a white powdery mass, which resumes the typical characteristics of gluten on being moistened.

The solubility of gluten has been fully described by Ritt-hausen. It is soluble in dilute acids and alkalis—but for complete solution especially in acids I found that considerable time was needed even at ordinary temperatures: at the low temperatures employed by Ritthausen it seems to have taken place fairly readily. I found that gluten, though less readily soluble in sulphuric than in other acids, was ultimately attacked by it. A .5% solution of sodium carbonate acts so slowly that one can use it for making the paste and also for washing for some time before the gluten is attacked.

In water, gluten is insoluble—as one would expect from its mode of preparation: all the proteid soluble at ordinary temperatures being removed by the water used in washing. The same is true for a solution of sodium chloride. The fact that water in which gluten has stood for three or four days gives an albumose reaction simply indicates the gradual formation of this from gluten.

In boiling water, however, gluten is to some extent soluble; as pointed out by Günsberg¹⁹ and by Martin³⁵. The latter describes the part soluble in boiling water as 'insoluble phyt-albumose,' and makes it coincide with the part of gluten soluble in alcohol [glian]. According to Günsberg, however, although the part soluble in water is completely soluble in alcohol, the converse is not true. This I likewise find to be the case: and it may be proved in the three following ways. (1) If the clear alcohol-extract of gluten [glian] be poured

boiling into even a large quantity of boiling water some of it is at once precipitated: nor can it in any way be made to dissolve. (2) If an extract of gluten is made with boiling water and cooled, the 'insoluble phytalbumose' appears as a cloudy precipitate: this may be readily dissolved in the cold by the gradual addition of alcohol to form a dilute alcoholic solution. Thus whilst the 'phytalbumose' is entirely soluble in dilute alcohol, glian is only partially soluble in boiling water. (3) The following method was employed to determine the actual amount of gluten soluble in boiling water and in alcohol respectively, i. e. the quantities of 'phytalbumose' and of glian to be obtained. A piece of freshly prepared gluten was divided into three parts, each consisting of about 2 grams. One part was dried, in order to show the proportion of gluten in the moist mass. Another part was cut into small pieces, exhausted with alcohol, and the residue dried and weighed. The third part was likewise cut into small pieces; these were dropped into a large amount of water (about 1 litre) at 100° C., and were almost immediately collected on a filter and washed with boiling water till no more proteid was extracted. The residue obtained in this way could not consist of any part once dissolved and then coagulated. The difference between the residue and the dry weight of the gluten employed in each case was calculated: it represents the amount which had passed into solution as glian and phytalbumose respectively.

Phytalbumose	6.2%	Glian	26.6%
„	7.84%	„	35.06%

The phytalbumose-solution gives the general proteid reactions, and, as Martin has described, those characteristic of an albumose. A part of it [mucin] remains in solution even in the cold, and is described, under the name of mucedin, by Ritthausen, as one of the essential constituents of gluten. But as it cannot be extracted from gluten in the first place by water at ordinary temperatures it is probably a secondary product resulting from the action of boiling water. Water

is afforded by the fact that the amount obtainable of any one of them may be made to vary by varying treatment of the gluten.

a. Zymom.—Zymom is most simply prepared by boiling gluten in alcohol; but thus obtained it may have passed into the coagulated state, and may moreover contain some of the glian which has become coagulated. To avoid this it may be prepared by carefully washing gluten at ordinary temperatures with alcohol: at first of about 60%, then of 65%, and so on up to 90% (Ritthausen). Even as thus obtained, its solubility is less than that of gluten as a whole; especially is it less soluble in acids, which points to its having undergone some change in the process of separation. The estimates given of its amount differ: Ritthausen states it as 28.3% of pure, dry gluten; Von Bibra as 70% of crude gluten, probably corresponding to about 62% of pure, dry gluten; Taddei's zymom represents one-third of the volume of moist gluten. The following estimates agree on the whole with those of Von Bibra. The process of exhaustion with alcohol was effected by means of the condensing apparatus to be described later, the gluten being cut into small pieces. Moist gluten was used, so that the proportion of dry gluten has had to be calculated, either by taking this as present to the extent of 44%, or by determining it separately for the gluten in question. Zymom prepared as above would contain all the solid impurities of crude gluten, so that about 20% has been allowed for this to give the results of the third column—the calculated proportion of zymom in pure dry gluten.

Percentage of Zymom in Gluten.

1. Moist.	2. Crude dry.	3. Pure dry.
28.9	64.89	56
32.14	70.31	64
35.26	78.35	74
27.5	64.94	56

The results vary considerably; roughly speaking, about 70% of crude, 50–60% of pure dry gluten, is insoluble in alcohol, i.e. consists of zymom. Differences to the above extent might have been expected, because of the difficulty of weighing

moist gluten in the same state in each case; also because different specimens of gluten must contain different proportions of impurity, and a different degree of hydration may have been attained in the washing of each.

More important, however, than the actual amount of zymom present, is the fact that the amount may be made to increase by placing gluten in circumstances favourable for hydration: as in water or dilute sulphuric acid. Absolute alcohol is practically without effect; prolonged action of dilute sulphuric finally causes a dissolution of the zymom already formed. The results are shown in the following table, the columns indicating, as above, the percentage of zymom in (1) moist, (2) dry, crude, (3) pure, dry gluten. The results, *A*, were obtained from equal weights (about 2 grams) of the same gluten; *B*, similarly, from gluten prepared at another time.

<i>A.</i> Zymom prepared immediately	(1) 28.9%	(2) 64.89	(3) 58
After 3 days in H ₂ SO ₄ (.5%)	38.8	88.98	86
" 4 " " distilled water	42.05	96.37	95
<i>B.</i> Prepared immediately	35.26	78.35	74
After 15 days in absolute alcohol	34.98	77.73	73
" 8 " " distilled water	39.78	88.40	86
(" 7 " " H ₂ SO ₄ (.5%)	26.71	59.3	49)
<i>C.</i> Prepared from unwashed gluten		28.6	15

That the 70% of zymom found in crude gluten which has been washed for some hours in the usual way, is in excess of that originally present, is shown in the result *C*; the amount of zymom present in just-formed gluten being estimated as follows. Five grams of flour were made into a paste in the usual way for gluten-formation; but the paste, instead of being washed with water to remove starch, was extracted with alcohol, and the glian was collected, dried, and weighed. From the flour employed, 10.5% of crude gluten was obtainable, of which about 70% consists of zymom. From the .5 gram of gluten thus present in the 5 grams of flour employed, .357 gram glian was extracted, leaving .143 gram zymom, or 28.6%, corresponding to 15% of the pure gluten present.

Hence, during the process of washing, the amount of zymom

increases from 15% to 70%, and by continuing the process further the amount may be increased to as much as 95%. There is thus no hard and fast line between zymom and the alcohol-soluble constituents of gluten. In this connexion we may consider the fact mentioned by many writers on gluten^{29, 32}, that by allowing the paste to stand for some time before washing, considerably more gluten may be obtained than by at once proceeding to wash it; this may be due to the process of hydration having meanwhile gone on and diminished the danger of loss in washing.

Thus the identification of the more insoluble part of gluten (zymom) with any simple proteid seems impossible; it being, as is obvious from the above results, a secondary product. In the first place it is derived from the mother-proteid as it occurs in flour by the addition of water; later, and more slowly, in the process of washing, by further hydration of this proteid (or its first-formed derivate). Its identification, as 'gluten-casein,' with the 'caseins' of leguminous seeds (legumin) and almonds (conglutin) is extremely doubtful. Although, as prepared from alkaline solution, these caseins are insoluble in salt-solutions, yet in the native state they are extremely soluble, conglutin dissolving readily even in water: admittedly, however, zymom is the most insoluble part of gluten, itself a rather insoluble form of proteid!

b. Myxon is described by Ritthausen as hard to estimate: he finds 2-3%, but suggests that the amount is probably larger; von Bibra finds 8.8%. As the amount present seemed to me to vary with every change in temperature, and in the strength of the alcohol, I have not tried to estimate it. It is described by Ritthausen, under the name of 'gluten-fibrin,' as hard, brittle, and transparent, as soluble in 90% alcohol in the cold, and as losing part of this solubility on drying in the air at ordinary temperatures (a change which might equally well be described as a partial transformation into zymom). It is characterised as being the only constituent of glian which forms a skin on the surface on the cooling of an alcoholic solution, and is said to diminish the softness and

tenacity of gluten; but after being washed, and dried even at 100°C ., it seems to me to possess a considerable amount of elasticity, and though as precipitated from a solution which has boiled for some time it is less sticky, yet it still coheres on drying.

An alcoholic extract of gluten (i. e. a solution of glian), even when perfectly clear, may become cloudy on standing in the cold; on heating, the precipitate thus formed disappears, to reappear on cooling: hence myxon, not originally present, has formed on standing. This process may be repeated several times, the myxon precipitated each time on cooling being filtered off, more is formed on standing. It seems impossible, even by cooling to 0°C ., to separate between the part which is soluble in the cold in alcohol and that which is not, viz. myxon. Prolonged boiling, too, even when the solution is kept at the strength of about 80% alcohol, converts more and more of the glian into myxon: this is not a case of ordinary coagulation, which takes place most readily when there is a large excess of water. All this surely points, not to the definite presence of myxon as a constituent of gluten, but to a gradual change in the solubility of the proteid (glian) at first soluble in alcohol: for if the precipitate first described were merely due to loss of alcohol by evaporation, it should disappear on replacing the loss by addition of alcohol, but this is not the case; again, if the precipitate on cooling is simply due to change of temperature it should disappear on warming, but this is only partially the case. More and more glian is converted into myxon, and the myxon finally becomes coagulated, and no longer capable of dissolving even by means of heat. The first part of the change, however, i. e. into myxon, is not coagulation, for myxon is still soluble in dilute potash (5%), although with its loss of solubility in alcohol in the cold it has lost likewise its solubility in acetic acid.

I must, however, admit that I did not succeed in making all the glian pass over into the myxon form, even by keeping it boiling for some hours each day for more than a week.

c. Glutine.—This originally constitutes the greater part, if not the whole, of glian; and, as shown under zymom, glian constitutes in the first place about 85% of gluten. In gluten prepared in the usual way, however, only 30% of glian is present; and of further hydrated gluten only 5% is soluble in alcohol. Glutine is the most important constituent of gluten, and on the proportion in which it is present depends the tenacity and elasticity of gluten—in fact, its value from a commercial point of view. It is, too, the constituent richest in nitrogen (Ritthausen, N=18.01%) approaching in this the conglutin (casein) of almonds, as indicated by Ritthausen in the name of the latter, although, as we have seen, it was the part of gluten insoluble in alcohol (zymom) which he called gluten-casein. This richness in nitrogen is not so evident in the results of other analysts; and the smaller percentage in the other derivatives of gluten may be due rather to their having taken up a small amount of water than to an originally different composition.

It is soluble in alcohol of about 75% strength, and is not completely soluble in water. Ritthausen found that the part soluble in water contained 17.7% nitrogen, the insoluble part 16.6%. (These results being obtained from glutine with 18.13% N, may support the remarks just made as to the diminution in the percentage of nitrogen; whilst that the soluble part had on drying lost its solubility in alcohol and in acetic acid may also be noted.) I find, however, that a solution from which as much myxon as possible has been separated, gives but a slight precipitate on adding to a large quantity of boiling water; that is, that all the glian has passed over either into the myxon form or has become of an albumose nature. Glutine is not easily coagulated; but if a freshly prepared solution be poured into a large quantity of boiling water large clots may form on boiling. From a solution of glutine, therefore, we may obtain (1) a less soluble form of proteid, myxon, by boiling with alcohol; or, (2) a completely coagulated form by boiling with a large quantity of water.

The term glutine comes in this way to include a good deal

of what I have for the sake of convenience called myxon, what Ritthausen distinguished as gluten-fibrin and earlier writers as gluten-casein, which is ultimately insoluble, but which at first, as I have shown, possesses the solubility in alcohol in the cold which is typical of glutine. And it must be remembered that even the first precipitated part of myxon, not less than glutine, is soluble in cold alcohol, if of the right strength, i.e. 90%, though in alcohol of 60-70% heat is necessary for its solution—so that between it and the myxon later produced by standing or heating, the difference is only one of degree. Hence the term glutine comes ultimately to include all of myxon, and is really co-extensive with 'glian' in signification.

The chemical properties of glutine, or of a freshly-prepared glian-solution, are those of a proteid. With Millon's reagent, however, the precipitate or coagulum never becomes deep red, remaining somewhat salmon-coloured. The tint of the potash solution of the copper sulphate precipitate, being reddish rather than violet, indicates something of an albumose nature, as does also the greater solubility in hot than in cold alcohol. The solution also gives the reactions described by Osborne⁴¹, as characteristic of 'Zein' (see p. 203).

d. Mucin has already been partly considered in treating of the solubility of gluten in water; and the impossibility of its existing as such in gluten was inferred from its non-extractability by cold water. In composition it approaches myxon (Ritt.), and has in fact the typical average composition of pure gluten. Its solution gives the characteristic reactions of a primary albumose, and it resembles glutine except in its non-coagulability.

These are the chief facts gathered from the study of gluten. Collected they seem to indicate :—

- (1) That the differently described alcohol-soluble derivatives of gluten merge into one another;
- (2) That the alcohol-soluble portion may be made to pass over into the insoluble stage;
- (3) That a proteose is readily formed as a secondary product from gluten.

It is next to be considered whether the treatment of flour with other reagents than water throws light on the composition of gluten. Dilute potash hardly seemed likely to do so: for it would have no discriminating power between gluten and the globulin and proteose of flour; all of which it would dissolve as well as such other parts of the cell-protoplasm as might still persist. Salt-solution (NaCl) and dilute alcohol seemed more likely, and were therefore used, with the following results.

B. *Action of Salt-Solutions.*

Weyl²³ had found in 1877 that by solution of salt (NaCl, 10–15%) a globulin (myosin) is extracted from flour. In 1880²⁸ he tried to trace the connexion of this with gluten, and, failing to obtain gluten from flour after extraction with salt-solution, he concluded that myosin is the mother-substance of gluten.

I found, however, that salt-solution extracted exactly the same proteids as water, and these in exactly the same amount, about 1%—an amount quite out of proportion to the amount of gluten. As mentioned (page 190) in describing the formation of gluten (2), the salt-solution was added in the way considered most likely to prevent gluten-formation.

1. Flour treated with a 10% salt-solution behaves in the same way as when treated with water. That is, gluten is formed in about the same quantity, and a globulin and a proteose occur in the washings.

2. If a concentrated salt-solution be added to flour, no gluten at first forms, and a small amount of globulin (vitellin) may be extracted. On dilution of such a mixture, or on addition of water to the residue after the salt-solution is poured off, gluten forms in the usual quantity and more globulin (myosin) passes into solution.

The proteids extracted by salt are the same in nature and amount as those extracted by means of water; and after exhaustion of flour by water, salt-solution extracted nothing further. In both cases, however, alcohol 75% subsequently

extracted the proteid to be described later as the albuminate ; or more properly, it extracted glian from the gluten which must in each case have formed.

No information is thus directly added as to the nature of gluten, but some facts about its origin are made clear, which will be considered later.

C. Action of Alcohol.

If gluten existed as such in flour, we should expect it to yield its glian-elements to alcohol ; finding that alcohol (76–80%) yielded only fat, Martin³⁵ concluded that not gluten, but some precursor of it, exists in flour. Ritthausen, however, found that with alcohol he could extract proteids of his third class (gluten-proteids) from flour. The amount extracted was from 4.3 to 5.1% of the dry weight of flour. My results were somewhat higher.

Alcohol (75%) forms with flour a smooth paste whose want of elasticity indicates the non-formation of gluten. A larger quantity of alcohol extracts a proteid and leaves a residue which gives no gluten and no globulin. The absence of gluten in the residue is the result of the removal of the proteid, not of any inhibitive action of alcohol ; for flour moistened with 75% alcohol, which was allowed to slowly evaporate, ultimately yielded the normal amount of gluten. The want of globulin is probably due to the coagulating effect of the alcohol, for the process of extraction is always a lengthy one. That the globulin is not extracted as such in the alcoholic solution is seen in the absence of any coagulum on heating. Salt-solution subsequently extracts a small amount of proteid ; it is precipitated by ammonium sulphate, but not by saturation with salt (NaCl) or by heat—agreeing with the proteose originally extracted by salt-solution or by water.

The alcohol-extract contains a proteid, giving the xanthoproteic and Piotrowski's reactions, and with Millon's reagent a strongly coagulated precipitate which, like that in glian, does not colour deeply on heating. The proteid is not coagulated by heat ; it is precipitated by alcohol or water, but passes

again into solution when water or alcohol is added till the previous proportion is approximately restored. Towards dilute salt-solution it behaves as towards water, a precipitate being formed which disappears on slight addition of alcohol. It is precipitated by ether, but the precipitate disappears on dilution with water or on evaporation of the ether. These are all obviously phenomena due to successive hydration and dehydration.

The solution is slightly acid, and on neutralisation with potash a precipitate is formed. This is of a different character from the hydration precipitates already mentioned, for it redissolves, not on addition of alcohol to the original strength, but on further addition of potash. This solution may be precipitated by dilute acid: the precipitate thus formed is, however, not soluble in dilute acid, but redissolves in 75% alcohol. That is, dilute alkali (KOH, .5%) can convert the proteid into an alkali-albuminate, whilst dilute acid (HCl, .5%) cannot transform it to an acid-albumin. May this be taken to indicate that it is of itself acid in character, and thus incapable of playing the part of a base to other acids? The explanation offered by Chittenden and Osborne⁴¹ of the somewhat similar behaviour of zein (from maize) is that a true albuminate is not formed; the proof being in the insolubility of the precipitate in excess of acid, whilst it is soluble in 75% alcohol. The characteristic tests for zein were applied to the alcohol-soluble proteid with the result that exact agreement of behaviour was shown. It was examined (1) as precipitated by ether, (2) by absolute alcohol, (3) after evaporation to dryness, with the same results. HCl (1%), HNO₃ (dilute), do not dissolve it; KOH (1%) and Na₂CO₃ (5%) dissolve it, and it is precipitated unchanged from the alkaline solution by acetic or hydrochloric acid, i.e. the precipitate is soluble as before in 75% alcohol, in dilute alkalis, but not in dilute acids. The process may be several times repeated. Strong alkali, or prolonged heating with dilute, destroys the solubility in alcohol, and renders solution in acids possible.

This proteid resembles the proteoses in many points. It

is more soluble in hot water than in cold ; if precipitated by standing from its alcoholic solution, it, at first, disappears on heating. It gives the proteose reaction with nitric acid ; but the biuret reaction is doubtful, a violet tinge being always present. As it exists in the alcoholic solution, it is, however, obviously a hydrated proteid, which may be readily dehydrated by addition of alcohol or ether ; it cannot, therefore, have reached the proteose stage. It corresponds rather to an albuminate, using the word in the sense suggested by Weyl²³ and adopted by Osborne^{33a}, i.e. to a primary proteid hydrated by means either of water, acid, or alkali. Here the hydration is by means of the water in the dilute alcohol ; for if the acid present were sufficient to form an acid-albumin, this would be extracted from flour by water, which is not the case. A further degree of hydration is reached if the albuminate is allowed to stand with a large amount of water ; a degree of hydration which seems to correspond to that of gluten, as will be further discussed later. Finally, by boiling, the stage of coagulation is reached, and all but an inappreciable part may be made to coagulate (as is likewise the case with the ultimate constituents of gluten). Or the insoluble stage may be reached by evaporation in the cold and re-resolution in dilute alcohol of as much of the proteid as will dissolve—a constantly diminishing quantity. In this, as in chemical behaviour, it resembles zein, which can be similarly made to pass into an insoluble form, in which it is unchanged in ultimate chemical composition (Chittenden and Osborne⁴¹).

The proteid extracted by 75% alcohol, when dried at ordinary temperatures, forms a clear brittle glue-like mass. This is sometimes the case on drying at 100° C., but if a large amount of liquid has been used, the process is long enough for coagulation to occur in the watery solution towards the end of evaporation. During evaporation a sticky layer is deposited on the sides and bottom of the dish, and a pellicle forms on the surface (indicating the presence of myxon). The dried substance takes up water readily, forming a transparent, viscid mass somewhat resembling gluten : it is, however, more sticky,

and may be drawn out into elastic strands giving under the microscope the aniline-blue reaction mentioned under gluten.

When the alcoholic solution is precipitated with water before evaporation and water added during the process, the physical properties of the albuminate obtained are considerably changed. It forms a tough opaque, rather than a clear viscid mass; in fact, it is now almost indistinguishable from gluten prepared in the usual way. This form likewise exactly resembles gluten in its behaviour to alcohol.

50% alcohol extracts a similar albuminate, but not so completely, since gluten-strands form in the residue. Also, though globulin cannot be dissolved out from the residue, it may be found as minute spherical particles in suspension on addition of water. Besides this globulin, only a trace of proteid is obtained by subsequent addition of water; magnesium sulphate giving only a slight precipitate, and heat causing only the faintest milkiness.

80% alcohol extracts an albuminate of exactly the same nature as that extracted by alcohol 75%.

90% alcohol extracts it in smaller quantity.

Absolute alcohol seems to extract a proteid, forming a deep yellow solution. A precipitate forms in it on dilution, not on heating; a precipitate is thrown down by nitric acid, soluble in excess, and also in dilute potash.

For quantitative purposes the albuminate was usually extracted by means of a simple condensing apparatus, which allowed the same alcohol to repeatedly wash a small quantity of flour (3–5 grams) placed in a funnel at the mouth of the flask in which the alcohol was kept boiling. Alcohol of about 60% was used (50 cc. water and 100 cc. methylated spirit), and was first allowed to drain through the flour into the flask in the cold. From this the condensed vapour passing over has at first a strength of over 90% alcohol, but as loss takes place the liquid in the flask becomes more watery, and the vapour represents a somewhat more dilute alcohol. At the end of from 3–5 hours it is found that all the alcohol-soluble proteid has been extracted. Fat and colouring-matter are

present in the proteid as thus collected, and may be removed by ether: but the amounts given usually represent the crude albuminate (dried at 100° C.). Three separate amounts of the flour used for gluten-estimation, each weighing 3 grams, gave albuminate representing 8.18%, 8.85%, 8.025% respectively; a fourth amount of 5 grams yielded 8.13%: average 8.29%. A similar amount (8.358%) was obtained from flour which had been kept for some time at 100° C.

In what form the albuminate exists in flour it is impossible to say, for no 'mother-substance' has yet been extracted; manifestly globulin is not the precursor, for it could then be extracted by salt-solution. Perhaps the suggestion³⁹ of a 'mother-substance' in oats, antecedent to globulin, may here be applicable—a substance whence, according to the conditions of hydration, gluten or an albuminate may be formed.

D. Relation between Gluten and the Albuminate.

The question arises, what is the relation between the glian of gluten and the albuminate of flour? Are they identical?

Obviously they are alike, in the first place, as regards their solubility in alcohol: and just as the solubility of glian in this has been shown to vary, so that of the albuminate may be made to vary in the same way.

If a solution of albuminate in 75% alcohol be precipitated with water and allowed to stand for some time, the character of the albuminate left on evaporation is found to be changed: as already mentioned, it is less sticky, more tough and tenacious, and in physical properties resembles gluten. The residue obtained by the evaporation of an alcoholic solution may be treated with water with the same result. The substance thus obtained behaves towards alcohol in the same way as does gluten: it is no longer all soluble, and from the extract made with hot alcohol a precipitate is obtained on cooling. That is, zymom and myxon are formed from it; and a substance soluble in water (mucin) may be obtained in

the same way as from the glian-solution from gluten. The derivatives most characteristic of gluten are thus to be similarly obtained from the albuminate.

On the other hand, the alcohol-extract of gluten gives the reactions most characteristic of the albuminate, i.e. the zein reactions, showing that in each case the proteid has passed over into the same state, in which it is still soluble in alkalies, but refuses to dissolve in dilute acids. These reactions also show the connexions of the wheat-proteids with those of other cereals, the zein of maize (Gorham⁵, Ritthausen, Osborne), and the avenine of oats (Norton¹⁴, Osborne). By analogy we might name the albuminate the *triticin* of wheat, or *glian*, as it may similarly be obtained from gluten. The amount of gluten obtainable from flour is, however, greater than the amount of glian ever obtainable from the gluten of the same quantity of flour. This has already been explained as showing that some of the gluten, even in the moment of formation, is of the insoluble zymom form.

I have already tried to show that glian is ultimately a term co-extensive with gluten (zymom being a secondary product); and have now tried to prove the identity of glian with the albuminate, whence should follow the ultimate identification of the albuminate with gluten itself. An apparently serious discrepancy, however, shows itself in the amount of gluten, about 10.5%, obtained from flour which yielded only 8.3% of the albuminate: the albuminate representing only 80% of the gluten, and this although no opportunity of zymom-formation has been permitted. This 20% however of the dry weight is not more than can be easily accounted for by the method of preparation of crude gluten: for it contains, as well as pure gluten, most of the fat of the flour and some starch and cellulose which cannot be removed by washing. The amount of fat present in flour is variously stated, and probably nearly all passes into the gluten. If we take the estimate of Peligot, who finds that the fat does not vary much from 1% for flour, we shall have 10% of gluten consisting of fat. On the other hand, the albuminate, extracted in the way employed, usually

carried down a small amount of fat (? half), while the rest was left in the flour in the funnel: so that perhaps an excess of 5-6% of fat in gluten over that in the albuminate may be counted on. Von Bibra gives 5.85%, Ritthausen 6%, as the fat present in gluten. The residue of starch will vary with the nature of the gluten and the method of washing:—Ritthausen found 16% in one sample, in one case I found about 12%. Add to these facts, the difficulty of thoroughly drying gluten in masses, even of the size in question (about 1 gram), and the probable retention of a small amount of water; and the 20% difference between gluten and the albuminate will be fully accounted for.

Hence the 10.5% of crude gluten may be considered as thus constituted at the time of formation:—

Glian	7.14 grams (cf. C. p. 196)	}	8.3	} 10.5
Zymom	1.2	„			
Impurities		2.2	

The glian and zymom together constitute what an earlier application of alcohol to the flour would have extracted as the 8.3 grams of albuminate.

This may seem but a rough and ready way of working; but, considering the rapidity with which these substances change during manipulation, and the difficulty in isolating them, it seems preferable to elaborate extractions with ether, and repeated solution in and reprecipitation from acid and alkaline solution. Even with all these at his command Ritthausen was only able to account for 70.3% of his crude gluten as the pure substance (the rest being fat, 6%; starch, &c., 16%; loss, 7.7%). A confirmation of the approximate accuracy of their estimated composition is seen in the total proteid of the flour.

The total nitrogen in the flour used (as estimated by Mr. Manley, of the Magdalen College Laboratory) is 1.761%, representing probably not more than 10.566% proteid. (This is obtained by using 6 as the co-efficient: the large amount of nitrogen in the proteids would according to Ritthausen justify

a still lower estimate.) This proteid may be thus accounted for:—

Gluten (pure)	8.3	}	10.566
Globulin	1.1		
Proteose and proteid not accounted for	1.166		

The total nitrogen of 100 grams of flour, 1.761, may be similarly apportioned: Ritthausen gives 17.6% N in the wheat-globulin (albumin, R); Mr. Manley found 14.45% N in the crude gluten, dried at 100° C.:

Gluten (10%)	1.445	}	1.761
Globulin (1%)	.176		
Proteose, &c.	.14		

Obviously, the albuminate, forming 8.3% of the dry weight of flour, must, if not identical with the 8.3% of pure gluten, be largely coincident with it.

These figures seem to warrant the conclusion that the substance extracted by alcohol is the precursor of gluten: and it has been to some extent shown that the process of gluten-formation is one of gradual hydration. The assumption that ferment-action is necessary to explain the process is precluded by the facts already mentioned: viz. :—

- (1) Gluten is obtainable from flour which has been kept for some time at 100° C.;
- (2) It is obtainable from such flour even when boiling water is employed to make the dough;
- (3) It is obtainable even at 0° C.

Moreover if a ferment be necessary it must be as widely spread as the substance on which it acts: for not the smallest particle of flour apparently (unless indeed a starch-grain) can be moistened under the microscope without showing gluten-formation: the same is seen in experiments (1) and (2) on gluten-formation (p. 190).

The origin of gluten from the globulins of flour seems disproved. The formation of gluten by washing as well with salt-solution as with water, would be impossible on that assumption (cf. also (1) and (2) under gluten-formation). Moreover, the inferences from the numerous analyses published by Jago³⁴

by no means fit in with the globulin-theory. He estimated the amount of soluble albuminoids (i. e. globulin and proteose) and that of gluten from the most varied wheats, and there is no relation to be observed in his tabulated results: e. g.:—

No.	g has	.9% sol. abuminoid	8.09% gluten
38	„	.91	5.00
16	„	1.69	6.25
17	„	1.69	8.21
42	„	2.03	8.54
32	„	2.84	5.54

A proportion between gluten and albuminate is much more traceable, as the following figures show:—

Albuminate	8.3%	gluten	10.5%
„	8.08	„	9.89
„	8.23	„	10.68
„	8.24	„	12.8
„	7.06	„	10.7

Moreover after removal of the albuminate by alcohol no gluten can be obtained from flour.

There must, then, be an extremely close connexion between gluten and the albuminate: so close as to justify us in saying that the substance which appears as the former as the result of hydration, appears as the latter on the exhaustion of flour by alcohol. As yet there is not much evidence as to the form in which it exists in flour. That it does not exist as gluten is clear—for in that case we should obtain from a given weight of flour the same amount of alcohol-soluble proteid, whether we at once extract the flour with the alcohol directly, or treat with alcohol the gluten obtained from the given weight of flour. The former amount is the larger, showing that the precursor of gluten is more soluble in alcohol than is gluten itself. And though the proteid extracted with alcohol from flour cannot be very far removed from the mother-substance of gluten (for it still has the power of gluten-formation), yet we cannot extract from it a proteid exactly in the state in which the gluten-precursor exists in flour. The residue which we obtain by evaporation is somewhat less soluble in acids than the mother-substance, which may be entirely dissolved in

acids. The precipitate which we obtain by water resembles gluten; that obtained by means of ether resembles the residue on evaporation. No attempt to isolate the mother-substance by any other means has been successful. Dilute potash and hydrochloric acid alike remove it, but this is necessarily in the derived form of an alkali-albuminate or acid-albumin.

Therefore of the proteids *as they exist* in wheat we can as yet affirm nothing definitely: but we must now add to those already described as extracted (namely, myosin and proteose); another globulin, vitellin; and a fourth which readily passes into the hydrated state, the mother-substance of gluten—homologous with the zein of maize and Osborne's alcohol-soluble proteid of oats, in its solubility in alcohol, but distinguished from them by its physical properties dependent on its capacity for hydration.

III.

The endosperm of wheat comprises not only the central starch-containing cells which constitute the greater part of flour, but a peripheral layer of cells, rich in oil and containing numerous small aleuron-grains. The contents of these cells have long been known to be very rich in nitrogen, causing the percentage of nitrogen in bran to far exceed that in flour. An account of the proteids of wheat must therefore include some descriptions of the aleuron-cells and their contents.

There is no necessity to refer to the general literature of the subject of aleuron-grains: references to the earlier part are given fully by Pfeffer⁵, and are brought down to a recent date by Lüdtké¹². I need therefore only mention what has special reference to the aleuron-grains of the Gramineae.

Maschke³ (1859) recognised them and their localisation in the outer layers of rye, but gave no special account of them.

Sachs⁴ (1862) described the outer endosperm-layer of wheat as being rich in nitrogenous substances and containing oil.

Pfeffer⁵ gave some attention to them in his work on proteid-grains (1872), but it is somewhat difficult to know whether his remarks actually refer to what we now know

as the aleuron-grains of the Gramineae. Thus he describes the grains as small and apparently without enclosures, but goes on to say that one can hardly speak of them as aleuron-grains, the albuminous material simply drying to a granular mass between the starch-grains. Whilst recognising that the one or two outer layers of the endosperm in Grasses are free from the starch, he does not localise in them the grains described.

In the same year, however, Schenk, finding the not unnatural error of considering the aleuron-layer (*Kleberzellen*) as the seat of gluten (*Kleber*, used in the narrower sense) fairly widespread, clearly pointed out that the aleuron-cells do not contain gluten. The large amount of nitrogen to be found in bran seemed to confirm the popular view; but Schenk showed that this large percentage of nitrogen is due (1) to the presence of a nitrogenous substance not proteid in nature; (2) to the adherent parts of the endosperm, its outer layers, which are the parts richest in gluten. He first described in detail the reactions of the aleuron-layer. Millon's reagent, he found, did not affect the aleuron-cells; iodine stained them deeply, but as it also stained the testa and pericarp he did not consider this as any proof of the presence of proteid. Digestion with dilute hydrochloric acid, with alcohol, ether, or even with potash, he found to be without effect on the cells or their contents; whilst concentrated sulphuric acid gave a blackish colour. Hence he considered himself justified in supporting previous writers who had insisted on the low nutritive value of the nitrogen of bran. The difference between his negative results and those to be mentioned later as to the solubility of the contents of the aleuron-cells, is probably due to the comparative imperviousness of these cells when intact, the uninjured contents having probably never been reached by the reagent.

For some time no important addition was made to the knowledge of aleuron-grains. About 1878, however, the aleuron-grains of many groups were described by Professor Vines⁷, and their chemical nature investigated; but no

account of the Gramineae is given, and their aleuron-grains were still practically unknown. Thus Godfrin (1884), describing the albumen of *Zea Mays*, states that the endosperm-cells contain starch only, the epidermis (presumably the aleuron-layer) being filled with a granular protoplasm.

Johanssen¹⁰ (1888) once more emphasised the fact that the starchy endosperm, and not the aleuron-layer, is the seat of gluten; a fact which, he tells us, was stated by Payen as early as 1846. As for the peripheral cells of the endosperm (the aleuron-cells)—‘they contain tiny grains of an extremely slight resistance, nitrogenous in substance, which are embedded in a soft protoplasmic mass rich in fatty matter:’ a description very different from that of Schenk. Of the more intimate structure of the grains no details are given.

Haberlandt¹¹, however, in 1890, found that the aleuron-grains of Gramineae show no essential difference from those of other plants. In particular he describes those of Rye; they contain 1-4 globoids in a ground-substance which is soluble in water.

Lüdtke¹² in 1890 published a comparative account of the aleuron-grains of four groups of plants; and for the first time those of the Gramineae are adequately dealt with. His general conclusion is that Gramineae, Leguminosae, Umbelliferae and Euphorbiaceae form an ascending series as regards the development of the aleuron-grains. He finds that in the Gramineae aleuron-grains, as known in other plants, have not yet been differentiated. Here they usually consist of a homogeneous central mass which should correspond to the globoid, and a surrounding membrane; of which Wheat affords a typical case. His observations as to their ready solubility agree with those of Johanssen rather than of Schenk. These grains, small and without enclosures, are in fact not real aleuron-grains, but similar structures, occurring in a ground-substance with a fatty oil mixed in its molecules. In what the similarity consists, or how it may be stated in terms of their chemical composition, is not shown.

Groom¹⁴ in 1893 took up this part of the subject, and

found that these grains contain the double phosphate of calcium and magnesium, characteristic of globoids. He therefore considered that the aleuron-grains of Gramineae are in every respect normal, consisting of a small peripheral layer of proteid, and an exceptionally large globoid. Of the proteid substance he does not treat, beyond mentioning the observation that it dissolves in potash, setting free the globoid.

The following work was undertaken in 1893, at the suggestion of Professor Vines, in order to try to complete our knowledge of the aleuron-grains of the Gramineae with some account of their proteid constituents. It will be seen that my observations chiefly agree with those of Lüdtkke, in part combining his results with those of Mr. Groom.

The Aleuron-Layer of Wheat.

The constitution of the aleuron-layer of the Gramineae has been frequently described. Whilst in most starch-containing seeds starch and aleuron-grains occur together throughout the endosperm, the aleuron-grains are here confined to its specialised outer layers, starch to its central mass.

In Wheat the aleuron-layer is in most places but one cell thick, and is protected externally by a strongly cuticularised layer of the testa. The continuity of protoplasm from cell to cell may easily be seen in a thickish section without other preparation than careful staining in Hoffmann's blue and mounting in glycerine. On treating a section with absolute alcohol, and then with concentrated sulphuric acid, a persistent pink protoplasmic network shows continuity between the aleuron-layer and the rest of the endosperm. The immediately underlying cells are specially rich in proteid matter (gluten); their starch-grains are somewhat larger than the aleuron-grains and are fairly regular in size. Most of the endosperm-cells, however, contain large circular flattened starch-grains, the interstices between which are so densely packed with minute, often angular starch-grains, that the proportion of gluten is small.

The aleuron-layer comes into close relationship with the embryo in two ways: (1) Its cells are continued over the external surface of the edge of the scutellum where it reaches the convex side of the grain; and here the aleuron-cells of the two seem continuous. This fact is the more noticeable because the cells of the scutellum bordering on the endosperm proper are glandular, whilst those forming its boundary towards the plumule are cuticularised. The aleuron-layer seems also to be continued over the rest of the embryo externally. (2) Beneath the well-marked furrow of the grain of Wheat the aleuron-cells pass inwards, the layer from one side meeting that from the other, both then sinking for some way into the endosperm proper. Thus, towards the base of the seed, they come into direct contact with the glandular face of the scutellum. Hence, the 'ringing' experiments in which it is attempted to destroy the connexion between embryo and aleuron-layer by an incision round the margin of the scutellum are not decisive, the second means of possible communication remaining intact.

The Aleuron-Cells.—Each cell of the aleuron-layer is polygonal in outline in surface view, with walls normal to the surface of the seed. Its protoplasm is continuous with that of adjoining aleuron-cells and that of the underlying endosperm; it encloses a large nucleus, and forms a firm close network embracing the aleuron-grains. Much oil is present, and perhaps some carbohydrate; this seems the explanation of the effect of the addition of concentrated sulphuric acid—the protoplasm being immediately fixed and assuming a deep rosy tint. (Cf. the black colour observed by Schenk on addition of strong sulphuric acid.)

The Aleuron-Grains.—Each aleuron-grain, as observed on the first addition of water or glycerine, or in oil or almost any mounting medium, is seen to be a spherical or somewhat angular body. It is seen also to consist of a central core surrounded by an outer layer. The core is a refracting body, more or less soluble in water, salt-solutions, dilute acids, and alkalies; it does not readily stain. The outer layer, on the

contrary, stains with iodine, hæmatoxylin, and aniline-stains, and does not dissolve in any of the above-mentioned reagents. Therefore, as compared with an ordinary aleuron-grain, the peripheral layer corresponds to the membrane, whilst the core unites in itself the characters of globoid and proteid ground-substance.

The degree of the solubility of the core differs considerably with the reagent employed, and various characteristic reactions occur. For observation I used sections cut dry, and at first treated them with ether to remove oil; the presence of oil, however, does not with most reagents interfere with one's observations after a little experience. My method was therefore simply to lay the section of the grain of Wheat on a slide under a cover-glass; to then run in a drop of absolute alcohol, in order to get a particular cell or aleuron-grain under observation, under the microscope; and, lastly, to irrigate the section with the reagent in question. In some cases, where solution for more than a few hours was necessary, the sections were kept in the reagent in a watch-glass. On running in the more slowly acting reagents the same results could be observed by using perfectly dry sections.

Water.—The core at once appears more distinct, and within five or ten minutes seems to be dissolving from the outside; dissolution may also proceed from the centre or may be irregular. The process is slow, and may not be completed till after one or two days, especially in those cells of the aleuron-layer which are still intact. Dissolution is assisted by slightly heating the slide. Finally only the peripheral part is left, a hollow sphere—this is quite unattacked by water even after six days.

Salt-Solution (NaCl 10%).—At first this acts more energetically than water, and in free-lying grains dissolution may be completed in less than an hour. Solution usually takes place in much the same way as in water; sometimes the core breaks up into three or four smaller spheres. Ultimately the process is less rapid, owing probably to the greater difficulty with which the solvent penetrates the protoplasmic

network. The membrane persists, sometimes in a contracted form, which can, however, be made to resume its former dimensions by the use of caustic potash. A 20% salt-solution at first attacks the grains more readily, but it cannot cause complete dissolution; whilst in a weaker solution (1-5%) the process is regular and frequently takes place from within, when the core itself appears as a hollow sphere. Statements as to the insolubility of these aleuron-grains in water and salt-solutions seem to be due to the persistence of the peripheral layer or membrane, which may be mistaken for the intact grain. Confirmation of their having passed into solution is afforded by the fact that a drop of the water or salt-solution employed gave a calcium reaction, forming insoluble crystals of calcium oxalate when evaporated on a slide with an ammoniacal solution of ammonium oxalate and chloride. I did not think it necessary to test similarly in each case for magnesium and phosphates.

In *Alcohol* (50%) the core of the aleuron-grain seems to dissolve from within, somewhat more rapidly than in water. The effect of absolute alcohol (2 months) is to render it insoluble in water and salt-solution, and only soluble in potash on standing for twelve hours.

Ammonium chloride dissolves the core at once from without, and the membrane also rapidly dissolves, though it is sometimes the last thing to disappear.

Sodium phosphate (Na_2HPO_4) dissolves both core and membrane, thus showing that the former is not of the nature of a crystalloid, this being left untouched by this reagent (Lüdtke¹²). If this salt is added in ammoniacal solution of ammonium chloride, crystals of ammonium and magnesium phosphate prove the presence of magnesium.

Caustic potash (1%) acts violently on the cell-protoplasm, which swells up and sets free the grains. The core slowly dissolves, usually from without; a small central mass may often persist for some time, but it finally disappears. The membrane becomes transparent, but does not dissolve, as is evident after addition of water or on neutralisation, especially

on staining with iodine. Even after five days in dilute potash the membrane persists; it may, however, be dissolved by a concentrated solution.

It is this comparatively easy solution in caustic potash (as well as in water and salt-solutions) which distinguishes the core of the aleuron-grains of Wheat (and probably of the Gramineae in general) from the globoids of other aleuron-grains, and which probably indicates the presence of some proteid body.

Other alkaline solutions, e. g. sodium and ammonium carbonates, give similar results; so also does calcium hydrate if a concentrated solution is used.

Acetic acid (1%) gradually dissolves the core from within, and finally the membrane also.

Hydrochloric acid (whether 1% or 10%) immediately dissolves both membrane and core.

Sulphuric acid (1% or 10%) immediately dissolves the whole grain. The concentrated acid dissolves the core first, then the membrane; though it occasionally appears to fix the latter, which then persists for some time. The last remnant of the core, too, frequently persists as a minute dark spot, indicating perhaps the presence of oil or a carbohydrate, or the fixation of the proteid constituent of the core by the strong acid. The simultaneous formation of monoclinic crystals (CaSO_4) in the cells and their immediate neighbourhood shows the presence of calcium: this may be confirmed by adding to a dry section a solution of ammonium oxalate and chloride, in ammonia, when the aleuron-grains are seen to dissolve and octahedral crystals to appear, which are insoluble in acetic acid and are, therefore, presumably of calcium oxalate. Especially when the section has been previously treated with absolute alcohol, the characteristic pink proteid reaction already mentioned may be observed with concentrated sulphuric acid.

Nitric acid (concentrated) does not precipitate the proteids, but dissolves the grains at once, the cytoplasm a few seconds later.

Tannic acid (conc.), osmic (10%) and picric (conc.) acids dissolve the core, leaving the membrane.

The Proteids of the Aleuron-Layer.—The colour-reactions and staining properties of the membrane of the aleuron-grain show its proteid nature. But it is improbable that the large amount of nitrogenous matter shown by analysis to occur in bran is confined to the peripheral parts of the aleuron-grains and the protoplasmic network. A partially proteid composition of the core of the aleuron-grain has been suggested by its solubility, as already mentioned; it is further supported by the composition and behaviour of an extract made from bran by water—it being remembered that water dissolves the core and not the membrane, and that it leaves the greater part, if not the whole, of the cytoplasm untouched.

The watery extract of bran seems to contain two proteids, giving Millon's, Piotrowski's, and the xanthoproteic reactions: (1) a coagulable proteid, probably a globulin dissolved in presence of the mineral salts; (2) a proteose which may be precipitated by concentrated salt-solutions from the filtrate from (1) after its coagulation by heat. Evaporated to dryness, the extract yields a gelatinous substance, yellow in bulk, and semi-transparent, separating out in part in small round spheres. These spheres are interesting as being, I believe, artificial aleuron-grains; they give all the reactions of those embedded in the cell-protoplasm. It may be specially noted that their outer layer partially resembles the membrane of the natural aleuron-grains, dissolving in water and even in potash only after some hours' treatment.

Bran extracted with alcohol (50%) yields a solution containing proteid, which agrees in its reactions with the extract made from flour.

Examination of the flakes of bran after treatment with water shows the core of the grains to have dissolved; but the process is slow in unbroken cells, and the small amount of matter in solution obtained from bran by short treatment with water depends on the difficulty with which this penetrates to the grains. This has also been proved by Jago's results, the

amount of soluble matter yielded by bran depending on the fineness to which it is ground. Thus the nutritive value of bread containing bran must depend, not on the absolute amount of nitrogenous matter present, but on the degree in which it is accessible to the action of liquids. For though the nitrogenous matter is not ordinarily available for nutrition, there is no reason to suppose that it is, in its nature, useless for this purpose, as has been urged (Poggiale² and others).

The Aleuron-Layer during Germination.—After being soaked in water for two days, wheat was sown, and later, examined at intervals. After one day the grains in the aleuron-layer did not seem to be affected, nor did those on the convex side of the grain after four days; whilst those from the grooved face showed greater solubility than the former, and in some cases seemed already dissolving from within.

After eight days, when the plumule is above ground and long adventitious roots are present, the aleuron-grains still persist; but by the nineteenth only the membranes of the grains persist, and no mineral (Ca) is present in the aleuron-cells. At this time only a small part of the endosperm seems to have been used, but the starch-grains immediately under the aleuron-layer are much corroded.

Function of the Aleuron-Layer.—(1) The aleuron-layer is frequently considered chiefly as a part of the reserve store for the embryo.

(2) A conducting function (of diastase from the embryo) has also been suggested.

(3) It is usually considered to be concerned in the diastatic solution of starch (Johanssen¹⁰), whether by actual secretion of diastase (Haberlandt¹¹, &c.) or, as just mentioned, by conduction. This is also the general opinion among bakers, the aleuron-layer of bran (cerealins-cells) being supposed to exert a diastatic action on flour, shown in 'softening' of the dough⁹.

(4) The presence of a gluten-transforming ferment is suggested by Balland⁸.

The diastatic function of the aleuron-layer has been denied

by Brown and Morris¹³, but their experiments do not seem exclusive of the possibility of some such function of the aleuron-layer, accessory to the scutellar epithelium. For, as already shown, there is no necessity for a stimulus from the embryo (if such be needed) to traverse the lifeless endosperm to reach the aleuron-layer, since the two are in contact below the furrow, towards the base of the grain. Nor does a decreased diastatic activity of the aleuron-layer after the embryo is detached necessarily prove that the enzyme comes from the embryo. Again, though in Barley the course of starch-dissolution may be independent of the aleuron-layer, this does not seem to be the case in Wheat. For while towards the tip of a germinating grain (four days) the starch-grains in the centre of the endosperm are intact, those in the cells immediately underlying the aleuron-layer have already begun to undergo dissolution, showing the characteristic radial pittings—and this both on the dorsal and the central face of the seed. But I have given no special attention to the question of the function of the aleuron-layer.

However, it rests with those who consider the aleuron-layer merely as a specialised reserve store to explain why it consists of apparently living cells with a large and perfect nucleus, whilst the rest of the endosperm-cells, as shown by Brown and Morris, are lifeless. In any case, it seems to me that cultivated grain, with a much larger proportion of starchy endosperm than that naturally present in the Gramineae, is hardly the best material from which to form an opinion as to the normal functions of the aleuron-layer.

The Aleuron-Layer of other Cereals.

Oats.—The aleuron-layer is one cell thick as in Wheat; and the grains show much the same degree of solubility.

Zea Mays.—The aleuron-grains are smaller and less regular than those of Wheat. They appear to contain a small globoid, or more than one, which is surrounded by a peripheral mass of proteid too thick to be considered a membrane, and which

is soluble in 1% potash. They, therefore, nearly resemble ordinary aleuron-grains; but the enclosure being soluble in dilute potash, and in salt-solution on standing, is not a true globoid, but resembles the core of the aleuron-grain of Wheat.

Barley is exceptional in having an aleuron-layer several cells in thickness. The aleuron-grains resemble those of Wheat in form and behaviour; but the membrane is more soluble in potash, and the core less sharply defined.

Rye.—The aleuron-grains show considerable variation in size, and resemble those of *Zea* in the large proportion of proteid present. Haberlandt¹¹ mentions the occurrence of as many as four globoids.

From the preceding observations it would appear that the aleuron-grains of the Gramineae do not present that degree of differentiation in which the mineral matters are sharply separated off, as a globoid, from the proteid constituents of the grain. Only the membrane, consisting usually of coagulated or at least of very insoluble proteid, is here differentiated. Within this, the substance of the aleuron-grain contains, as has been proved by Mr. Groom, the phosphates of magnesium and calcium, like the globoids of typical aleuron-grains. But that it likewise consists of some nitrogenous substance seems the conclusion separately drawn by Johanssen and Lütke from their different observations, and the present results confirm this view. Hence it seems to me that the aleuron-grains of Wheat, within a membrane of coagulated proteid, contain a sphere of a homogeneous substance combining the proteid (globulin and proteose) and mineral matters, differentiated in other plants into ground-substance and globoid. Thus the various apparently conflicting theories as to the aleuron-grains of the Gramineae may be harmonised.

Finally, I wish to express my indebtedness to Professor Vines for the suggestions he has made, and my thanks for the kind interest he has taken in my work.

BOTANICAL LABORATORY, OXFORD,

March, 1895.

Since writing the foregoing pages, my attention has been drawn by Prof. Green's article in 'Science Progress' for March, 1895, to some work on the proteids of wheat (Amer. Chem. Journ., 1893; Journ. of the Amer. Chem. Soc., 1894) by Messrs. Osborne and Voorhees, with which I was unacquainted. This work to some extent covers the same ground as my own, but our results are not altogether concordant.

I find, however, that I am in agreement with these authors in my conclusions as to the ferment-theory of gluten-formation, and as to the supposed origin of gluten from the globulin of flour.

Apart from gluten, they find three proteids in flour which seem to correspond to those which I have described under somewhat different names, as indicated in the following table:

Globulin [edestin] .6--7%	} 1%	corresponding to Vitellin	} Globulin
Albumin [leucosin] .3--4%	}	,, ,, Myosin	1%
Proteose	}	,, ,, Proteose.	

Leucosin is described as an albumin with the exceptional characters (1) of being precipitated on saturation with ammonium or magnesium sulphates, and (2) of coagulating at the low temperature of 52°C.; whereas the conclusion at which I have arrived is that this proteid is a globulin of the myosin-class.

These authors describe the proteids of gluten as follows:

Sol. in dilute alcohol	:	Gliadin 4%.
,, only in dilute acids or alkalies	:	Glutenin 4%.

They thus return to the view of Taddei, and in part to his terminology. Whilst they reject his term 'zymom,' as implying ferment-action, they retain 'gliadin' for the substance which I have termed 'glian' on account of the varying sense in which the term 'gliadin' has been used by different writers, having been applied sometimes to the whole, sometimes to a part only, of the alcohol-soluble constituents of gluten. Moreover, the view which they adopt as to the mutual relation of these two substances differs essentially from that which my observations seem to suggest. They

consider, namely, that the constituents of gluten (gliadin and glutenin) exist in flour in the same proportions as in gluten; and that, therefore, gluten may be said to exist as such in flour. I find, on the contrary, that these substances may be extracted from gluten in varying proportions, according to the method employed; this suggests that the one may be derived from the other; and it is probably the less soluble substance (zymom) that is derived from the more soluble (glian): hence the alcohol-soluble substance (glian) is ultimately co-extensive with gluten. I was, in fact, able to extract about 8% of this substance from flour; but whilst I must admit that the method of extraction was likely to bring with the albuminate or glian a certain proportion of other substances, it seems to be highly improbable that the quantity of these impurities could be such as to reduce the amount of pure glian to the 4% indicated by Osborne and Voorhees. Although in most cases the larger quantities of flour with which they worked would enhance the value of their results as compared with mine obtained from small quantities, yet in this particular instance the repeated washing of the smaller quantity of flour may have been more thorough than could be possible with a larger quantity.

The facts seem to me to indicate the existence of one mother-substance in flour, which readily undergoes hydration, giving rise to gluten. For we can, as it were, intercept the hydration at any point, and obtain, consequently, a larger or a smaller amount of alcohol-soluble substance (glian), by extracting gluten with alcohol at an earlier or later stage in its progress to almost complete insolubility. Moreover, it seems almost impossible to completely extract from flour the whole of the alcohol-soluble proteid with 75% alcohol in the cold; this again is suggestive of a gradual hydration of a mother-substance.

BIBLIOGRAPHY.

I and II.

1. Beccari (quoted by Ritthausen): *Commen. Bonon.* I. 1, 122.
2. Cadet (quoted by Einhof): *Scherer's Jahrb.*, Bd. ix. S. 569.
- 3a. Einhof (1805): *Gehlen's J. der Chemie*, Bd. iv. S. 315; *Analyse der Erdäpfel.*
- 3b. Einhof (1805): *Ibid.* Bd. v. S. 131, *Analyse des Roggens*; S. 62, *der Gerste*; S. 115, *der Erbsen u. der reifen Saubohnen.*
4. Taddei (1819): *Summary in Schweigger's J. f. Chem. und Physik*, xxix. 1820; also in *Berz. Jahresb. d. Ch.* i. 1822.
5. Gorham (1822): *Berz. Jahresb.* ii. S. 124; *Zelne.*
6. Berzelius (1828): *Jahresb.* vii. S. 231; *Pflanzenleim und Pflanzeneiweiss.*
7. De Saussure (1833): *Summary in Jahrb. d. Chem. und Physik*, S. 188; *Bildung des Zuckers beim Keimen des Waitzens.*
8. Boussingault (1837): *Ann. de Ch. et de Physique*, lxxv; *La quantité de gluten, &c.*
- 9a. Mulder (1839): *J. f. prakt. Ch.*; *Die Zusammensetzung einiger thierischen Substanzen.*
- 9b. Mulder (1840): *Summary in Berz. Jahresb. d. Ch.* xix; *Bestandtheile des Bluts.*
10. Berzelius (1840): *Jahresb.* xix. S. 637; *Bestandtheile des Bluts.*
11. Liebig (1840): *Ann. de Ch. et de Pharm.* xxxix. S. 126; *Die stickstoffhaltigen Nahrungsmittel des Pflanzenreichs.*
12. Denis (1840, quoted by Scherer): *J. de Ch.-Méd. Sc. Sér.* iv.
13. Dumas et Cahours (1842): *Ann. de Ch. et de Physique*, Sér. iii. No. 6; *Les matières azotées neutres de l'organisation.*
14. Norton (1848): *Am. J. of Sci.* Ser. II, 5; *Protein Bodies of Peas, &c.*
15. Peligot (1850): *Ann. de Ch. et de Pharm.* Sér. III, xxix; *Sur la composition du blé.*
- 16a. Hartig (1855): *Bot. Zeit.* S. 881; *Ueber das Klebermehl.*
- 16b. Hartig (1856): *Ibid.* S. 257, *Weitere Mittheilungen das Klebermehl betreffend.*
17. Denis (1859) (quoted by Hoppe-Seyler): *Mémoire sur le Sang*, Paris.
18. Von Bibra (1860) (quoted by Ritthausen): *Die Getreidearten und das Brod*, Nürnberg.
19. Günsberg (1862): *J. f. prakt. Ch.* lxxxv. S. 213; *Im Wasser lösliche Bestandtheile des Klebers.*
20. Kühne (1864): *Das Protoplasma, &c.*, Leipzig.
- 21a. Hoppe-Seyler (1865): *Handbuch d. phys. und path. chem. Analyse*, 2te Aufl.
- 21b. Hoppe-Seyler (1865-70): *Med.-chem. Untersuchungen.*
- 21c. Hoppe-Seyler (1870): *Handbuch*, 3te Aufl.
22. Ritthausen (1872): *Die Eiweisskörper der Getreidearten*, Bonn.
23. Weyl (1877): *Zeitschr. f. Phys. Chem.* i; *Die thierischen und pflanzlichen Eiweisskörper.*
24. Ritthausen (1877): *Pflüger's Arch. f. Phys.* xv. S. 269; *Die Eiweisskörper der Pflanzensamen.*

25. Barbieri (1878): *J. f. prakt. Chem.* xviii. S. 108; *Eiweisssubstanz der Kürbissamen.*
- 26*a.* Vines (1878): *Proc. Roy. Soc.* xxviii. p. 218.
- 26*b.* Vines (1880): *Ibid.* xxx. p. 387.
- 26*c.* Vines (1880): *Ibid.* xxxi. p. 62; *Chem. Composition of Aleurone Grains.*
27. Ritthausen (1880): *Pflüger's Arch.* S. 81; *Die Eiweisskörper der Oelsamen.*
28. Weyl und Bischoff (1880): *Ber. deutsch. Chem. Ges.* S. 367; *Ueber den Kleber.*
29. Bénard et Girardin (1881): *J. de Pharm. et de Chim. Sér. 5. T. iv.* p. 127; *Le dosage du gluten.*
30. Hoppe-Seyler (1881): *Physiologische Chemie, Berlin.*
31. Vines (1882): *J. of Physiol.* iii; *Proteid substances in Seeds.*
- 32*a.* Balland (1883): *J. de Pharm. et de Chim. Sér. 5. T. viii.* p. 347; *Mémoire sur les farines.*
- 32*b.* Balland (1884): *Ibid.* T. x. p. 266; *Second Mémoire.*
33. Martin (1885): *J. of Phys.* vi. p. 336; *Papain.*
34. Jago (1886): *Chemistry of Wheat, &c., Brighton.*
35. Martin (1886): *Brit. Med. J.* ii. p. 104; *Gluten and Proteids of Flour.*
36. Martin (1887): *J. of Physiol.* viii; *Vegetable Globulins.*
37. Kjeldahl (quoted by Johanssen): *Compte-rendu de Carlsberg, T. i.*
38. Johanssen (1888): *Ibid.* vol. ii. livr. 5; *Sur le gluten, &c.*
- 39*a.* Osborne (1890): *Am. Chem. J.* xiv. 3; *Proteids of the Oat Kernel.*
- 39*b.* Osborne: *Ibid.* xiv. 8; *Crystallised Proteids.*
41. Chittenden and Osborne (1891-2): *Am. Chem. J.*; *Proteids of Maize Kernel.*
42. Balland (1893): *J. de Pharm. et de Ch., Sér. 5. xxvii.* p. 258; *Sur la pré-existence du gluten dans le blé.*
- See also* Haliburton: *Chemical Physiology and Pathology*, chap. x.: *Article, 'Proteids,' in Watts' Dict. of Chem.* (1894).
- Sheridan Lea (1892): *Chemical Basis of the Animal Body.*
- Hoppe-Seyler (1893): *Handbuch der phys. und path. chem. Analyse, Berlin.*

III.

1. Mège-Mouriès (1853): quoted by Schenk 6.
2. Poggiale (1853): quoted by Schenk 6.
3. Maschke (1859): *Bot. Ztg.*; *Die Kleberbläschen in Bertholletia, &c.*
4. Sachs (1862): *Bot. Ztg.*; *Zur Keimungsgeschichte der Gräser.*
5. Pfeffer (1872): *Pringsheim's Jahrb.* viii.; *Proteinkörner.*
6. Schenk (1872): *Untersuchungen, Wien*: *Ueb. die Vertheilung des Klebers.*
7. Vines (1878): see I. 26, 31.
8. Balland (1883-5): see I. 32.
9. Jago (1886): see I. 34.
10. Johanssen (1888): see I. 34.
11. Haberlandt (1890): *Ber. deutsch. Bot. Ges.* viii.; *Die Kleberschicht des Gras-Endosperms, &c.*
12. Lüdtké (1890): *Pringsheim's Jahrb.* xxi.; *Die Aleuronkörner.*
13. Brown & Morris (1890): *J. of Chem. Soc.*; *Germination of some of the Gramineae.*
14. Groom (1893): *Ann. of Botany*, vii.; *The Aleurone-Layer of the Seeds of Grasses.*

Flowers and Insects in Great Britain.

PART I.

BY

J. C. WILLIS, M.A.,

*Senior Assistant in Botany, Glasgow University, and Lecturer in
Botany in Queen Margaret College.*

AND

I. H. BURKILL, M.A.,

Assistant Curator of the University Herbarium, Cambridge.

THE observations detailed in this first part of our paper refer, with a few exceptions, to lowland plants growing not more than 1,000 feet (305 metres) above sea level. They were made during 1892-93-94 in several places, viz. Cambridge, Scarborough, Mid-Wales (Plynlimmon district of Cardiganshire), and Auchencairn (South Scotland). The observations at each place are given separately; one of us is entirely responsible for those made at Scarborough, the other for those at Auchencairn. A few high-level visitors in Wales are given here. We have also made observations in the Grampian mountains, which (together with the general results) we hope to give in a second portion of this paper at some future period.

We desire to express our gratitude to the following entomologists, who have most generously named for us a very considerable number of insects which we could not ourselves

[*Annals of Botany*, Vol. IX. No. XXXIV. June, 1895.]

identify, thus rendering this paper far more accurate and complete than it could otherwise have been made.

DR. D. SHARP, F.R.S. (Coleoptera and many others).

G. H. VERRALL, ESQ., F.E.S. (Diptera).

R. C. L. PERKINS, ESQ., M.A. (Hymenoptera Aculeata).

In addition to naming our Coleoptera, &c., Dr. Sharp has given us several valuable suggestions and criticisms, for which we desire to express our thanks.

I. INTRODUCTORY.

The first person to emphasize the need of studying the insects that visit flowers, as well as the flowers themselves, was H. Müller. In his classical books he gives descriptions of the mechanisms of many flowers, and also full lists of their insect-visitors. From these it is easily seen that there are degrees of specialization in the flowers—more effectual shelter of pollen and honey, more conspicuousness, scent, &c.—and corresponding degrees of specialization in their insect-visitors—greater adaptation of mouth-parts to procuring pollen and honey, greater cleverness in finding concealed honey, preference for certain colours or scents, &c. Müller himself was the first to put these facts into shape, as the ‘Theory of Flowers’ which is enunciated in his ‘Alpenblumen’ (1881; it was partly, however, set forth in earlier papers). Entomophilous flowers are there divided into several classes; beginning with the lowest, these are:—

1. Pollen-flowers (Po) of simple type, offering pollen only to their visitors; examples are *Helianthemum vulgare*, *Spiraea Ulmaria*.
2. Flowers with freely exposed honey (A); Umbelliferae, *Parnassia*.
3. Flowers with partially concealed honey (AB); Cruciferae, *Potentilla*.
4. Flowers with fully concealed honey (B); *Mentha*, *Calluna*.
5. Capitula with fully concealed honey (B’); Compositae, *Phyteuma*.

[6. Flowers specially adapted to Diptera (D); *Veratrum album*, *Saxifraga umbrosa*¹.]

7. Flowers specially adapted to Bees (H); most Labiatae, *Echium*, *Gentiana*.

8. Flowers specially adapted to Lepidoptera (F); *Silene acaulis*, *Gymnadenia*.

Similarly the insects visiting the flowers are divided into classes according to their degrees of specialization for flower-visiting. The chief groups are:—

1. Neuroptera, Orthoptera, Hemiptera, Thysanoptera.
2. Coleoptera.
3. Long-tongued Diptera (Syrphidae, Conopidae, Bombylidae, Empis).
4. Short-tongued Diptera (all others).
5. Long-tongued Bees (*Apis*, *Bombus*, &c.).
6. Short-tongued Bees (*Prosopis*, *Andrena*, &c.).
7. Other Hymenoptera.
8. Lepidoptera.

Arranging these in order of specialization to floral diet, we should have first groups 8 and 5, then 6 and 3, and lastly 7, 4, 2, and 1.

Tables are given showing the numbers of species of insects of each kind that visit the different floral groups, and it is at once seen that the bulk of the visitors to the higher types of flowers are insects of high degree of specialization, e. g. in the Alps, to 100 flowers of class H, the visitors were:—Lepidoptera, 39.1 per cent.; long-tongued bees, 48.8 per cent.; and all other insects together, 12.1 per cent. On the other hand, of the visitors to flowers of class A, the Lepidoptera and bees form only 14.2 per cent.

Loew (292 *b*) observed the visitors to exotic plants in the Berlin Botanic Garden, and the results thus obtained were in accord with Müller's theory, and gave it great support. Since that time many observations have been made in various parts

¹ Class 6 is not usually considered a separate class.

of the world, all tending to support the same general view. An excellent review of the whole has recently been published by MacLeod (18 in literature list, below).

At the same time, great variation occurs in the case of any single flower between the results obtained in various places. The composition of the list of visitors varies much, though their type remains comparatively the same; so also there are variations in the floral mechanism itself and in the amount of vegetative reproduction, &c. This being so, it becomes of interest to study various flowers in many different parts of their distribution areas, as we may thus obtain some information of value with regard to geographical distribution, variation, effect of environment, &c. Loew's recent work (4) contains an abstract and literature list of all the work done in this direction upon the European flora since 1883, but from the regions studied, our own country is conspicuously absent. The present paper (with the second portion to follow) is an attempt to fill some small portion of this gap. The literature relating to our British flora is small, and chiefly contained in out-of-the-way journals (see list). The only paper of any importance is that of Scott-Elliot, but the observations are fragmentary, and no conclusions are drawn from them. One of us (6) has drawn attention to the great preponderance of flies over other visitors in certain cases, but no general conclusion has been drawn, extending over the whole flora.

LITERATURE.

I. *Bibliographies.*

- a. To 1882, in Müller's *Fert. of Flrs.*, Eng. ed. Numbers such as 158 a, &c., refer to this.
- b. To 1889. Macleod, *Lijst van Boeken.* (Bot. Jaarboek, Gent, II. 1890.) Referred to thus: 158 b, &c.
- c. To 1894, in Loew, *Blütenbiol. Floristik.*

II. *Books and papers.*

1. H. MÜLLER: *Fertilization of Flowers*, English edition. (London, 1883.)

2. H. MÜLLER: Alpenblumen. (Leipzig, 1881.)
3. ———: Weitere Beobachtungen (590 a).
4. LOEW, E.: Blütenbiologische Floristik. (Stuttgart, 1894.)
5. BRIQUET: Monographie du genre Galeopsis. (Mém. cour. Acad. roy. Belg. 1893.)
6. BURKILL: On the fertilization of some spec. of Medicago in England. (Proc. Camb. Phil. Soc. VIII. 1894, p. 142.)
7. EKSTAM: Zur Kenntniss d. Blütenbestäubung auf Novaia Semlja. (Ofv. af Kongl. Vet. Ak. Förhandl. Stockholm, 1894, p. 79.)
8. HEINSIUS: Eenige waarnemingen en beschouwingen over de bestuiving van bloemen der Nederlandsche flora door insecten. (Bot. Jaarboek, Gent, IV. 1892, p. 54.)
9. KERNER: Pflanzenleben. Vol. II. (Leipzig, 1891.)
10. KIRCHNER: Beitr. z. Biol. d. Blüten. (Progr. d. 72. Jahresfeier d. Kgl. Württemb. landwirthsch. Akad. Hohenheim. Stuttgart, 1890.)
11. KNUTH: Blütenbiol. Herbstbeobachtungen. (Bot. Centralbl. 49, 1892.)
12. ———: Vergl. Beob. ü. d. Insektenbesuch an Pfl. d. Sylter Haide u. d. Schleswigischen Festlandshaide. (Bot. Jaarb. Gent, IV. 1892, p. 27.)
13. ———: Die Blüteneinrichtungen von *Corydalis claviculata* DC. (Bot. Centralbl. 52, 1892, p. 1.)
14. ———: Blumen u. Insekten auf d. Nordfriesischen Inseln. (Kiel, 1893.)
- *14. ———: Nachunt. d. Blüteneinr. von *Lonicera Periclymenum*. (Bot. Centr. 60, 1894, p. 41.)
15. ———: Blumen u. Insekten auf d. Halligen. (Bot. Jaarb. vi. 1894.)
16. LOEW: Beitr. z. Blütenbiol. Statistik. (Abh. Bot. Ver. Brandenburg, xxxi. 1890.) See also No. 4.
17. MACLEOD: De Pyreneeënbloemen en hare bevruchting door Insecten. (Bot. Jaarb. Gent, III. 1891, p. 260.)
18. ———: Over de bevrucht. d. bloemen in het Kempisch gedeelte van Vlaanderen. (Ditto V. 1893 and VI. 1894.)
19. ROBERTSON: Flowers and Insects; Labiatae. (Trans. Acad. Sci. St. Louis, VI. 1892, p. 101.)
20. ROTHNEY, G.: Notes on flowers avoided by bees. (Proc. Entom. Soc. London, 1890.)

21. SCHULZ, A.: Beitr. z. K. d. Bestäubungseinrichtungen u. d. Geschlechtsvertheilungen bei den Pfl. (Biblioth. Bot. X and XVII. Cassel, 1889-90.)
22. SCOTT-ELLIOT: Notes on fertilization, chiefly on British Cruciferae. (Trans. and Proc. Bot. Soc. Edinb. xix. 1891-2, p. 237.)
23. ———: Flora of Dumfriesshire. Pt. I. London, 1891. Pt. II in Trans. Dumfries and Galloway N. H. Soc. 1891-92. (Gives lists of insect visitors.)
24. VERHOEFF: Biol. Beob. auf d. Insel Norderney. (Abh. naturw. Ver. Bremen, XII. 1891, p. 65.)
25. ———: Blumen u. Insekten auf d. Insel Norderney. (Nova Acta d. Kais. Leop. Carol. Deutsch. Akad. d. Naturf. Leipzig, 1894.)
26. WILLIS: Gynodioecism in the Labiatae. (Proc. Camb. Phil. Soc. 1892-93. Three papers.)
27. ———: Contributions to the Nat. Hist. of the Flower. II. (Linn. Soc. Journ. XXX. 1894, p. 284.)
28. ENGLER UND PRANTL: Die natürlichen Pflanzenfamilien, contains general description of the biology of each order.

2. OBSERVATIONS AT AUCHENCAIRN, 1894,

BY J. C. WILLIS.

Auchencairn is a small village about two miles from the sea, on the southern coast of Scotland. It lies in lat. 54° 50' N. (corresponding to Schleswig-Holstein), and has an approximate mean annual temperature of 9°. To the west is the Ben Gairn range of hills (highest point 1,250 feet), and to the east a small bay, dry except at high water. The conditions for vegetable growth are all very favourable, and there is a rich flora. The writer stayed in Auchencairn from August 15 to September 15, 1894, and the weather being favourable throughout, succeeded in determining, with some completeness, the visitors of almost all the plants which formed, at that period of the year, important features in the flora. Great care was taken to watch each plant at all the different

hours of the day, and to record only *genuine* visitors; notes were made of what each insect was doing upon the flowers. The whole of the observations (one moth excepted) were made within three miles of Auchencairn, and a brief description of the 'hunting-grounds' will now be given.

A. *Forest Hill* (F. H.), an open moor, on the east side of Ben Gairn, covered with *Calluna* and *Erica* (*cinerea* and *Tetralix*), *Calluna* being far more abundant. Amongst the heather occur *Potentilla Tormentilla*, and *Polygala*.

B. *Forest Hill Road* (F. H. Rd.), the road to A from Auchencairn. By the side of it are masses of *Hypericum perforatum*, *Spiraea*, *Lychnis*, *Rubus*, *Leontodon*, *Centaurea*, *Digitalis*, and *Scabiosa*.

C. *The beach of Auchencairn Bay* (A. B.), a grassy expanse covered with *Aster* and (less common by far) *Statice*, up to the extreme high water mark; above this occur *Senecio Jacobaea*, *Centaurea*, *Ononis*, *Rubus*.

D. *Rascarrel beach* (Ras.). Rascarrel Bay is on the open sea and faces SE. The western end has lofty cliffs, but the eastern end has a large extent of flat beach above the high water mark, and this rises inland by a slope of about 30° to a height of 100 feet. The slope is covered at the top with *Erica*, *Calluna*, and *Helianthemum*; further down chiefly with *Teucrium*; while its lowest parts and the flat beach are covered with a tangled mass of vegetation, in which the chief flowers are *Rubus*, *Lonicera*, *Senecio Jacobaea*, *Angelica*, *Pimpinella Saxifraga*, *Mentha aquatica*, *Geranium Robertianum*, *Scutellaria galericulata*, *Lycopus europaeus*, *Centaurea nigra*, *Achillea Millefolium*, *Scabiosa succisa*, *Campanula rotundifolia*, *Prunella vulgaris*, *Matricaria inodora*. Facing south, and well sheltered, this part of the bay forms an excellent place for insect observations and a great deal of time was spent here.

E. *Road from Auchencairn to Rascarrel* (Rasc. Rd.). Along the road are masses of *Senecio Jacobaea*, *Calluna*, *Leontodon*, *Stachys palustris*, *Galeopsis Tetrahit*, &c.

F. Road from Auchencairn to Collin (Cl.). About a mile from the village this road has broad green sides, covered with masses of *Angelica*, *Pimpinella*, *Spiraea*, *Leontodon*, &c.

The flowers will now be treated of in systematic order, giving lists of visitors and references to previous papers. In the lists of Diptera, the Syrphidae are placed first as being long-tongued.

Abbreviations:—s. h. = sucking honey; c. p. = collecting pollen; f. p. = feeding on pollen; ab. = abundant; freq. = frequent; do. = ditto. F. H., Cl., &c. are explained above. The date of observation is given.

COMPOSITAE: 1. *Leontodon autumnalis* L. [Class B'. See Literature, 1, 2, 3, 4, 11, 14, 15, 17, 18, 25, 48 b.] This flower abounds in the district, and is very abundantly visited by short-tongued flies; one at least, and often as many as six or eight, may usually be seen on every head. They feed upon pollen, manipulating the anther-tube with their forelegs and proboscis. Though so numerous they are comparatively of little importance in the work of fertilization.

Visitors. Lepidoptera. Rhopalocera: (1) *Lycaena icarus* Rott., s. h. F. H. Rd. 6. 9. 94. Heterocera: *Tortricidae*: (2) *Simaëthis fabriciana* L., do. *Crambidae*: (3) *Crambus* sp.?, 5. 9. 94. **Hymenoptera.** Aculeata: *Acutilingues*: (4) *Bombus terrestris* L., s. h. Rasc. Rd. 7. 9. 94. (5) *B. muscorum* L., do., 5. 9. 94. (6) *Halictus rubicundus* Chr., s. h. freq. Terebrantia: *Chalcididae*: (7) one sp. **Diptera.** *Syrphidae*: (8) *Platychirus manicatus* Mg., f. p. freq. Cl. 3. 9. 94. (9) *Syrphus ribesii* L., s. h. and f. p. freq. 3-10. 9. 94. (10) *Sphaerophoria scripta* L., f. p. freq. Cl. 3. 9. 94. (11) *S.* sp.?, do. (12) *Brachyopa bicolor* Fln., s. h. F. H. Rd. 6. 9. 94. (13) *Sericomyia borealis* Fln., f. p., do., 11. 9. 94. (14) *Eristalis aeneus* Scop., f. p. Cl. 3. 9. 94. (15) *E. tenax* L., f. p. F. H. Rd. 11. 9. 94. (16) *E. pertinax* Scop., do. *Mycetophilidae*: (17) *Sciara* sp.? f. p.? *Anthomyiidae*: (18) *Trichophthicus cunctans* Mg., f. p. Cl. 3. 9. 94. (19) *Anthomyia radicum* L., do. (20) *A.* sp.?, do. *Ephydriidae*: (21) *Hydrellia griseola* Fln., do. **Coleoptera**: (22) *Sitones puncticolis* Steph., do. **Hemiptera**: (23) *Calocoris fulvo-maculatus* De G., Cl. 3. 9. 94. (24) C.

bipunctatus F. (?), do. (25) *Miris laevigatus* L., do. (26) *Acocephalus* sp.?, do.

2. *Centaurea nigra* L. [Class B', Lit. 8, 10, 17.] This plant is everywhere abundant, and was in full flower throughout the time.

Visitors. **Lepidoptera.** Rhopalocera: (1) *Argynnis aglaia* L., s. h. near F. H. 30. 8. 94. (2) *A. sp.* (? *paphia* L.), s. h. F. H. Rd. 12. 9. 94. (3) *Epinephele janira* L., s. h. Rasc. 29. 8., F. H. 30. 8., Cl. 3. 9. 94. (4) *Pieris napi* L., s. h. freq. at all stations 24. 8. to 8. 9. 94. (5) *P. rapae* L., s. h. Rasc. 29. 8., Cl. 3. 9. 94. (6) *Polyommatus phloeas* L., s. h. freq. Rasc. &c. 3-12. 9. 94. (7) *Vanessa urticae* L., s. h. F. H. 30. 8., Cl. 10. 9. 94. Heterocera: *Crambidae*: (8) *Crambus* sp.? s. h. freq. Cl. 29. 8., Rasc. 3-12. 9. 94. **Hymenoptera.** Aculeata: *Acutilingues*: (9) *Apis mellifica* L., s. h. Cl. 8. 9. 94. (10) *Bombus hortorum* L., s. h. freq. at all stations 24. 8. to 10. 9. 94. (11) *B. lapidarius* L., s. h. freq. Cl. and A. B. 27. 8. to 10. 9. 94. (12) *B. muscorum* L., s. h. ab. at all stations except Rasc. 24. 8. to 12. 9. 94. (13) *B. terrestris* L., s. h. ab. everywhere, do. (14) *B. scrimshirani* Kirb., s. h. freq. Cl. 27. 8. 94. (15) *B. pratorum* L., s. h. A. B. 2. 9. 94. (16) *Anthidium manicatum* L., s. h. Rasc. 29. 8. and freq. F. H. Rd. 6. 9. 94. **Diptera.** *Syrphidae*: (17) *Platychirus manicatus* Mg., f. p. Cl. 31. 8. and 3. 9. 94. (18) *P. albimanus* F., f. p. freq. Cl. 31. 8. 94. (19) *Syrphus balteatus* Deg., do. (20) *Sphaerophoria scripta* L., s. h. Cl. 27. 8. 94. (21) *Rhingia rostrata* L., s. h. and f. p. freq. Cl. &c. 24. 8. to 1. 9. 94. (22) *Eristalis aeneus* Scop., s. h. freq. Rasc. 5. 9. 94. (23) *E. tenax* L., s. h. A. B. 2. 9. 94. (24) *E. pertinax* Scop., f. p. Rasc. Rd. 24. 8. 94. *Anthomyiidae*: (25) *Trichophthicus cunctans* Mg., s. h.? Rasc. 23. 8. 94. (26) *Hylemyia strigosa* F., do. 27. 8. 94. (27) *Anthomyia radicum* L., f. p. Rasc. 23 and 31. 8. 94. (28) *A. sp.*?, freq. Rasc. 23-31. 8. 94. **Coleoptera**: (29) *Crepidodera ferruginea* Scop., in copulâ, F. H. Rd. 6. 9. 94. (30) *Meligethes viridescens* F., f. p. very ab. 23. 8. to 12. 9. 94. **Hemiptera**: (31) *Calocoris bipunctatus* F., Cl. 31. 8. 94. (32) *C. fulvo-maculatus* De G., Rasc. Rd. 30. 8. 94. (33) *Anthocoris* sp.?, ab. F. H. Rd. 27-28. 8. 94.

3. *Senecio Jacobaea* L. [Class B', Lit. 1, 3, 4, 11, 14, 17, 18.] This is by far the most conspicuous plant in the district

in late summer, excepting *Calluna* and *Erica* upon the moors. Enormous masses of it, visible half a mile away, occur on Rascarrel beach, and it is common everywhere. It was in full bloom during the period of these observations, and was visited on fine days by countless insects.

Visitors. Lepidoptera. Rhopalocera: (1) *Epinephele janira* L., s. h. Rasc. 29. 8. 94. (2) *Pieris rapae* L., do. (3) *Polyommatus phloreas* L., s. h. ab. Rasc. &c. 24. 8. to 12. 9. 94. Heterocera: *Noctuidae*: (4) *Charaëas graminis* L., s. h. F. H. 30. 8. and 12. 9. Rasc. 4. 9. 94. *Tortricidae*: (5) *Simaëthis fabriciana* L., s. h.? freq. on the flowers 1-9. 9. 94. (6) *Choreutis myllerana* F., s. h. Rasc. 29. 8. 94. *Tineidae*: (7) *Plutella cruciferarum* Zel., s. h. Rasc. 29. 8. Cl. 1. 9. 94. *Crambidae*: (8) *Crambus* sp.? s. h. freq. 21. 8. to 10. 9. 94. *Hymenoptera.* Aculeata: *Acutilingues*: (9) *Apis mellifica* L., s. h. ab. Rasc. 23 to 29. 8. 94. (10) *Bombus lapidarius* L., s. h. Rasc. 28. 8. to 10. 9. 94. (11) *B. cognatus* Steph., s. h. freq. Rasc. 29. 8. 94. (12) *B. pratorum* L., s. h. ab. Rasc. 23-29. 8. 94. (13) *B. hortorum* L., s. h. ab. Rasc. Rd. 31. 8. 94. (14) *B. muscorum* L., s. h. ab. Rasc. 28. 8. to 10. 9. 94. (15) *Psithyrus quadricolor* Lep., s. h. ab. Rasc. Rd. 23-30. 8. 94. (16) *Andrena nigriceps* Kirb., s. h. ab. Rasc. 29. 8. 94. (17) *Halictus rubicundus* Chr., s. h. ab. A. B. 21. 8., Rasc. 29. 8. 94. (18) *H. albipes* Kirb., s. h. ab. Rasc. 29-31. 8. 94. *Eumenidae*: (19) *Odynerus pictus* Curt., s. h. Rasc. 4. 9. 94. *Myrmicidae*: (20) *Myrmica rubra* L., freq. trying to suck honey. Terebrantia: *Ichneumonidae*: (21) one sp. *Chalcididae*: (22) one sp., both Rasc. 29-31. 8. 94. *Diptera.* *Syrphidae*: (23) *Chilosia* sp.?, s. h. Rasc. 29. 8. 94. (24) *Syrphus balteatus* Deg., f. p. F. H. Rd. do. (25) *S. ribesii* L., f. p. Rasc. Rd. 31. 8. 94. (26) *S. topiarius* Mg., s. h. do. (27) *Sphaerophoria scripta* L., s. h. and f. p. Rasc. 29-31. 8. 94. (28) *Arctophila mussitans* F., s. h. Cl. 3. 9. 94. (29) *Eristalis aeneus* Scop., s. h. and f. p. ab. Rasc. &c. 21. 8. to 4. 9. 94. (30) *E. pertinax* Mg., do. (31) *E. horticola* Deg., do. (32) *Helophilus pendulus* L., s. h. ab. Rasc. 29. 8. 94. *Bibionidae*: (33) *Dilophus* sp.?, s. h. Rasc. Rd. 29. 8. 94. (34) *Bibio pomonae* F., s. h. freq. do. *Tachinidae*: (35) *Olivieria lateralis* F., s. h. ab. Rasc. 29. 8. 94. *Sarcophagidae*: (36) *Sarcophaga carnaria* L., s. h. Rasc. 8. 9. 94. *Muscidae*: (37) *Lucilia caesar* L., s. h. ab. Rasc. Rd. 23. 8. 94. (38) *L. sericata* Mg., do. (39) *Calliphora erythrocephala* Mg., s. h. Rasc. Rd. 23. 8. 94.

(40) *Morellia* sp.?, s. h. Rasc. 5. 9. 94. *Anthomyiidae*: (41) *Hyetodesia incana* W., s. h. Cl. 10. 9. 94. (42) *Mydaea* sp.?, s. h. and f. p. freq. Rasc. &c. 22-31. 8. 94. (43) *Trichophthicus cunctans* Mg., s. h. Rasc. Rd. 18-28. 8. 94. (44) *Anthomyia radicum* L., s. h. and f. p. freq. Rasc. and A. B. 18-24. 8. 94. (45) *A.* sp.?, do. *Cordyluridae*: (46) *Scatophaga stercoraria* L., s. h. freq. A. B. 21. 8. 94. *Phytomyzidae*: (47) *Phytomyza geniculata* Macq., f. p. F. H. Rd. 27. 8. 94. **Coleoptera**: (48) *Antherophagus nigricornis* F., f. p. Rasc. Rd. 28. 8. 94. (49) *Meligethes* sp.?, f. p. ab. 18. 8. to 12. 9. 94. **Hemiptera**: (50) *Calocoris bipunctatus* F., freq. Rasc. 29. 8. 94. (51) *Anthocoris* sp.?, freq. Rasc. 23. 8. to 1. 9. 94. (52) *Accephalus* sp.?, Rasc. Rd. 28. 8. 94.

4. *Matricaria inodora* L. (? var. *maritima* Linn.). [Class B', Lit. 1, 3, 4, 11, 14, 18, &c.] Abundant on Rascarrel beach, and visited by great numbers of short-tongued flies. All observations were made there.

Visitors. **Lepidoptera.** *Rhopalocera*: (1) *Polyommatus phloea* L., s. h. freq. 7-14. 9. 94. *Heterocera*: *Tortricidae*: (2) *Choreutis myllerana* F., s. h. 7. 9. 94. (3) *Simaethis fabriciana* L., do. **Hymenoptera.** *Aculeata*: *Acutilingues*: (4) *Bombus lapidarius* L., 12. 9. 94; one insect visited two heads, s. h., and then went away. (5) *Halictus cylindricus* F., s. h. 5. 9. 94. (6) *H. rubicundus* Chr., s. h. ab. 7. 9. 94. (7) *Sphcodes affinis* v. Hag., s. h. freq. 5. 9. 94. *Obtusilingues*: (8) *Prosopis brevicornis* Nyl., s. h. 7-12. 9. 94. *Eumenedidae*: (9) *Odynerus pictus* Curt., s. h. freq. 5. 9. 94. **Diptera.** *Syrphidae*: (10) *Ascia podagrica* F., s. h. freq. 5-7. 9. 94. (11) *Eristalis tenax* L., s. h. 7. 9. 94. (12) *E. pertinax* Scop., do. (13) *Sphaerophoria scripta* L., do. *Mycetophilidae*: (14) *Sciara* sp.?, s. h. ab. 7. 9. 94. *Bibionidae*: (15) *Scatopse brevicornis* Mg., do. *Muscidae*: (16) *Lucilia sericata* Mg., do. *Anthomyiidae*: (17) *Spilogaster communis* Dsv., s. h. 7. 9. 94. (18) *Anthomyia radicum* L., s. h. and f. p. very ab. 5-12. 9. 94. (19) *A.* sp.?, f. p. 7. 9. 94. *Sepsidae*: (20) *Themira minor* Hal., s. h. freq. 7. 9. 94. *Ephydriidae*: (21) *Hydrellia griseola* Fln., s. h. and f. p. ab. 5-7. 9. 94. *Drosophilidae*: (22) *Scaptomyza graminum* Fln., s. h. freq. 7. 9. 94. *Chloropidae*: (23) *Oscinis frit* L., f. p. freq. 7. 9. 94. **Coleoptera**: (24) *Anthonomus rubi* Herbst, freq. 7. 9. 94. **Hemiptera**: (25) *Calocoris bipunctatus* F., do. (26) *C. fulvo-maculatus* De G., do.

5. *Achillea Millefolium* L. [Class B', Lit. 1, 2, 3, 4, 8, 11, 12, 14, 17, 18, 24, 287 b, 610 b, &c.] Abundant in the district. It is visited chiefly by flies, but great numbers of Microlepidoptera are often to be seen on the heads. Some of these, e.g. *Simaëthis*, are very like in colour to the withered flowers and are not easily noticed at a little distance. As many as seven specimens of this moth have been seen at once on a single tuft of flowers. The idea suggested itself that they might be there for protection, as often they stayed motionless for a long time.

Visitors. **Lepidoptera.** Rhopalocera: (1) *Pieris rapae* L., s. h. Cl. 3. 9. 94. (2) *P. napi* L., s. h. Rasc. 4. 9. 94. (3) *Polyommatus phloreas* L., s. h. F. H. 30. 8., Rasc. 14. 9. 94. **Heterocera:** *Noctuidae*: (4) *Hydraecia nictitans* L., s. h. Dundrennan Abbey (5 miles from Auchencairn) 13. 9. 94. *Tortricidae*: (5) *Simaëthis fabriciana* L., s. h. or sitting on the heads, very ab. Cl., F. H. Rd., Rasc. 30. 8-14. 9. 94. (6) *Choreutis myllerana* F., s. h. Rasc. 8. 9. 94. **Diptera.** *Syrphidae*: (7) *Syrphus balteatus* Deg., s. h. Rasc. 4. 9. 94. (8) *Sphaerophoria scripta* L., s. h. freq. 24. 8-10. 9. Rasc. &c. (9) *Eristalis tenax* L., s. h. Cl. 3 and 10. 9. 94. (10) *E. pertinax* Scop., f. p. Rasc. Rd. 24. 8. 94. (11) *Syritta pipiens* L., s. h. Rasc. Rd. 30. 8. *Chironomidae*: (12) *Cricotopus* sp.?, f. p. Cl. 1. 9. 94. *Tachinidae*: (13) *Olivieria lateralis* F., s. h. Rasc. Rd. 30. 8. *Muscidae*: (14) *Lucilia sericata* Mg., s. h. and f. p. Rasc. 24-29. 8. *Anthomyiidae*: (15) *Hyetodesia incana* W., s. h. Cl. 3. 9. (16) *Spilogaster communis* Dsv., s. h. Rasc. Rd. 30. 8. 94. (17) *Anthomyia radicum* L., s. h. and f. p. freq. Rasc. &c. 24. 8-10. 9. 94. (18) *A.* sp.?, do. (19) *Phorbia floccosa* Mcq., f. p. Rasc. Rd. 24. 8. *Cordyluridae*: (20) *Scatophaga stercoraria* L., f. p.? Cl. 27. 8. *Ephydriidae*: (21) *Hydrellia griseola* Fln., f. p. Cl. 1. 9. 94. **Coleoptera**: (22) *Quedius boops* Grav., do. (23) *Cercus rufilabris* Latr., f. p. very ab. Rasc. Rd. 23. 8. 94. **Hemiptera**: (24) *Calocoris bipunctatus* F., s. h. Rasc. Rd. 30. 8. (25) *C. fulvomaculatus* De G., s. h. freq. Cl. and Rasc. 7-10. 9. 94. (26) *Anthocoris* sp.?, s. h. freq. Rasc. 4. 9. 94.

6. *Aster Tripolium* L. [Class B', Lit. 4, 11, 14, 15, 24, 339 b.] Abundant on the beach of Auchencairn bay, where its only competitors (except *Statice*) were at some distance

away (see above). During the spring tides the flowers were covered twice daily by the sea, but it did not seem to do them any harm. All were fully fertile; autogamy probably often occurs. The flowers were visited by great numbers of Syrphidae and by a good many bees.

Visitors. **Lepidoptera.** Rhopalocera: (1) *Polyommatus phloas* L., s. h. 18. 8. 94. **Hymenoptera.** Aculeata: *Acutilingues*: (2) *Apis mellifica* L., do. (3) *Bombus lapidarius* L., s. h. 18-23. 8. 94. (4) *B. muscorum* L., do. (5) *B. pratorum* L., do. (6) *B. terrestris* L., do. **Diptera.** *Syrphidae*: (7) *Platychirus manicatus* Mg., s. h. 18. 8. 94. (8) *Eristalis aeneus* Scop., s. h. freq. do. (9) *E. tenax* L., do. (10) *E. horticola* Deg., do. *Muscidae*: (11) *Lucilia cornicina* F., do. (12) *Calliphora sepulchralis* Mg., s. h. 21. 8. 94. *Anthomyiidae*: (13) *Hyetodesia incana* W., s. h. and f. p. freq. 18. 8. 94. (14) *Anthomyia radicum* L., s. h. and f. p. freq. 18-21. 8. (15) *A. sp.?*, s. h. 21. 8. *Cordyluridae*: (16) *Scatophaga stercoraria* L., s. h. freq. 18. 8. *Tripetidae*: (17) *Tephritis vespertina* Lw., s. h. 21. 8. 94. **Coleoptera**: (18) *Meligethes aeneus* F., s. h. and f. p. ab.

CAMPANULACEAE: 7. *Jasione montana* L. [Class B', Lit. 1, 3, 4, 11, 12, 14, 17, 18, 48 b. See also below, No. 44.] Only occasional plants were to be met with in the neighbourhood.

Visitor. **Lepidoptera.** Rhopalocera: (1) *Pieris napi* L., s. h. Rasc. 4. 9. 94.

8. *Campanula rotundifolia* L. [Class H, Lit. 1, 2, 3, 4, 11, 14, 17, 18, 287 b.] Abundant, but not much visited except by small insects which shelter and feed in the flowers.

Visitors. **Lepidoptera.** Rhopalocera: (1) *Vanessa urticae* L., s. h. Rasc. Rd. 10. 9. 94. **Hymenoptera.** Aculeata: *Acutilingues*: (2) *Bombus terrestris* L., s. h. freq. Rasc. 29. 8. 94. **Diptera.** *Anthomyiidae*: (3) *Anthomyia radicum* L., s. h., freq. 24-29. 8. 94. **Coleoptera**: (4) *Meligethes sp.?*, s. h. ab., do. **Thysanoptera**: (5) *Thrips sp.?*, do.

DIPSACEAE: 9. *Scabiosa succisa* L. [Class B', Lit. 1, 3, 8, 14, 18; see also articles 36, 46, below.] Thinly scattered over the district.

Visitors. **Lepidoptera.** Rhopalocera: (1) *Pieris napi* L., s. h. Rasc. 4. 9., F. H. Rd. 10. 9. 94. **Hymenoptera.** Aculeata: *Acutilingues*: (2) *Bombus muscorum* L., s. h. ab. Rasc. and F. H. Rd. 7-12. 9. 94. (3) *B. pratorum* L., s. h. freq. F. H. Rd. 12. 9. 94. (4) *B. terrestris* L., s. h. freq. Cl. 10. 9. 94. (5) *Psithyrus campestris* Pz., s. h. Rasc. 7. 9. 94. (6) *Halictus rubicundus* Chr., s. h. Cl. 10. 9. 94. (7) *H. cylindricus* F., s. h. ab. F. H. Rd. 5. 9. 94. **Diptera.** *Syrphidae*: (8) *Melanostoma scalare* F., f. p. freq. F. H. Rd. 12. 9. 94. (9) *Syrphus balteatus* Deg., s. h. Cl. 10. 9. and f. p. F. H. Rd. 12. 9. 94. (10) *Eristalis intricarius* L., s. h. Cl. 10. 9. 94. (11) *E. tenax* L., do. (12) *Helophilus pendulus* L., do. **Anthomyiidae**: (13) *Mydaea* sp.?, do. (14) *Anthomyia* sp.?, do.

CAPRIFOLIACEAE: 10. *Lonicera Periclymenum* L. [Class F, Lit. 1, 8, 11, 14, 14*, 18, 131 b.] Abundant at Rascarrel. It was not watched at night and no Lepidoptera were seen upon it in the day time.

Visitor. **Hymenoptera.** Aculeata: *Acutilingues*: (1) *Bombus hortorum* L., s. h. freq. Rasc. 29. 8. to 10. 9. 94.

SCROPHULARIACEAE: 11. *Digitalis purpurea* L. [Class H, Lit. 1, 4, 9, 244 b, 316 b, 518 b.] Frequent, but not abundant.

Visitors. **Lepidoptera.** Rhopalocera: (1) *Pieris* sp.?, s. h. Rasc. 14. 9. 94. **Hymenoptera.** Aculeata: *Acutilingues*: (2) *Bombus muscorum* L., s. h. Rasc. 8-12. 9. 94. (3) *B. terrestris* L., s. h. Rasc. 4-12. 9. 94. (4) *B. hortorum* L., do. **Coleoptera**: (5) *Meligethes* sp.?, ab. The bees alone were of use in fertilization.

LABIATAE: 12. *Mentha aquatica* L. [Class B, Lit. 1, 14, 18, 21, 410 b. See also No. 37, below.] Abounds on Rascarrel beach and was studied there. It was in full flower about Sept. 4, 1894.

Visitors. **Lepidoptera.** Rhopalocera: (1) *Pieris napi* L., s. h. 5. 9. (2) *Vanessa urticae* L., s. h. 14. 9. (3) *Polyommatus phloea* L., s. h. 4. 9. 94. **Hymenoptera.** Aculeata: *Acutilingues*: (4) *Bombus muscorum* L., s. h. ab. 5-10. 9. (5) *Psithyrus campestris* Pz., s. h.

5. 9. (6) *Halictus rubicundus* Chr., do. **Diptera. Syrphidae:** (7) *Volucella pellucens* L., s. h. 4. 9. (8) *Eristalis aeneus* Scop., freq. s. h. 5. 9. (9) *E. tenax* L., do. (10) *E. horticola* Deg., do. **Empidae:** (11) *Rhamphomyia* sp.?, s. h. 10. 9. **Anthomyiidae:** (12) *Mydaea* sp.?, f. p. 12. 9. (13) *Trichophthicus cunctans* Mg., s. h. freq. 5. 9. (14) *Anthomyia radicum* L., s. h. and f. p. 5-12. 9. (15) *A.* sp.?, do. **Coleoptera:** (16) *Crepidodera ferruginea* Scop., ab. (freq. in copulâ) f. p. and devouring the anthers 5-12. 9. (17) *Meligethes* sp.?, freq. f. p. and s. h.

13. *Stachys palustris* L. [Class H, Lit. 1, 4, 8, 14, 18, 19.] This plant abounds in one place on the Rascarel Road and was watched there; it occurs, however, in several other places in the district. The number of individual visits of humble-bees was probably ten times as many as those of all other insects put together. It does not seem to fertilize itself at all, or very little, but the number of visits received ensures a fair amount of seed being set. On one spike examined, 21 flowers had set 54 seeds.

Visitors. Hymenoptera. Aculeata: Acutilingues: (1) *Bombus muscorum* L., s. h. very ab. 24-31. 8. 94. (2) *B. hortorum* L., do. (3) *B. terrestris* L., do. (4) *Anthidium manicatum* L., s. h. 23. 8. 94. **Diptera. Syrphidae:** (5) *Melanostoma scalare* F., f. p. 31. 8. 94. (6) *Platychirus albimanus* F., s. h. (?) ab. f. p. 24-31. 8. 94. (7) *P. manicatus* Mg., f. p. 31. 8. 94. (8) *Rhingia rostrata* L., s. h. and f. p. ab. 24-31. 8. 94. **Anthomyiidae:** (9) *Anthomyia radicum* L., f. p. freq. 24-30. 8. 94. **Coleoptera:** (10) *Meligethes* sp.?, f. p. ab. 23-31. 8. 94. **Hemiptera:** (11) *Anthocoris* sp.?, 28. 8. 94.

14. *Galeopsis Tetrahit* L. [Class H, Lit. 1, 2, 4, 5, 17, 18.] Frequent in the district. It varies considerably in colour from red to pure white.

Visitors. Hymenoptera. Aculeata: Acutilingues: (1) *Bombus muscorum* L., s. h. Rasc. Rd. 5. 9. 94. (2) *B. terrestris* L., s. h. freq. Rasc. Rd. 31. 8. 94.

Five of the eight visitors observed by Müller in Low Germany, and all of those recorded by other observers, were humble-bees.

15. *Prunella vulgaris* L. [Class H, Lit. 1, 2, 4, 9, 11, 14,

17, 18, 19, 21, 332 a, 258 b, 339 b.] Common in the district, but somewhat past its best flowering season. The female form was not observed.

Visitors. **Lepidoptera.** Rhopalocera: (1) *Pieris napi* L., s. h. Rasc. 24. 8. and 14. 9. 94. **Hymenoptera.** Aculeata: *Acutilingues*: (2) *Bombus muscorum* L., s. h. ab. 27. 8. to 14. 9. 94. (3) *B. terrestris* L., freq., do.

16. **Teucrium Scorodonia** L. [Class H, Lit. 1, 4, 9, 17, 18, 337 b, 338 b, 342 b.] Abundant on Rascarrel beach and frequent elsewhere.

Visitors. **Hymenoptera.** Aculeata: *Acutilingues*: (1) *Bombus muscorum* L., s. h. ab. 24. 8 to 10. 9. 94. (2) *B. hortorum* L., do. (3) *B. terrestris* L., s. h. freq., do. (4) *Psithyrus campestris* Pz., s. h. Rasc. 10. 9. 94.

PLUMBAGINACEAE: 17. **Statice Limonium** L. [Class B, Lit. 4, 14, 15, 339 b.] Frequent on the shore of Auchencairn bay, but being placed in competition with a much larger mass of flowers of *Aster* (see above) it was practically left unvisited. Self-fertilization seemed to occur in some specimens examined. During the spring tides in August, 1894, the flowers, like those of *Aster*, were submerged twice daily.

Visitors. **Hymenoptera.** Aculeata: *Acutilingues*: (1) *Bombus hortorum* L., s. h. 23. 8. 94. **Coleoptera.** (2) *Meligethes* sp.?, f. p., do.

ERICACEAE: 18. **Calluna vulgaris** Salisb. [Class B, Lit. 1, 2, 4, 9, 11, 14, 17, 18, 25, and see No. 48, below.] This species abounds in the district, there being numerous moors covered with it. It was in full flower when studied. An important point, apparently only noticed by one previous observer (Kerner), is the *anemophily* of this plant. It possesses the characteristic 'loose-pollen' mechanism of *Erica*; but whilst in the latter the flower hangs almost vertically downwards and has a deep tubular corolla almost covering the stigma and quite covering the anthers, in *Calluna* the flower stands out more nearly horizontally, and has an open

mouthed corolla, so that the stamens and stigma are freely exposed. To anyone accustomed to the Scottish moors, the dust that rises from the heather when one walks through it on a hot day, more especially if it has been calm beforehand, is a familiar phenomenon. On examination, this dust is found to be the pollen of the *Calluna*; it often rises in dense clouds after a few days of warm still weather, when one shakes the plants by walking through them. If after such weather a breeze spring up, the pollen blows about from flower to flower on a large scale, and the freely exposed and rather large stigmas will be, almost certainly, pollinated. This anemophily of the heather combined with its social growth, must be of considerable importance to it, and probably as much cross fertilization takes place in this way as by insect aid.

Visitors. **Lepidoptera.** Rhopalocera: (1) *Polyommatus phloea* L., s. h. Rasc. 7 and 14. 9. 94 [also at Scarborough]. Heterocera: *Tortricidae*: (2) *Peronea aspersana* Hub., s. h. Rasc. 31. 8. 94. **Hymenoptera.** Aculeata: *Acutilingues*: (3) *Bombus muscorum* L., s. h. ab. F. H. 6 and 7. 9. 94. (4) *B. pratorum* L., s. h. Rasc. 31. 8. 94. (5) *B. scrimshirani* Kirb., s. h. F. H. 7. 9. 94. (6) *B. terrestris* L., s. h. ab. 30. 8 to 7. 9. 94. (7) *Apis mellifica* L., s. h. very ab., F. H., Rasc., and on summit of Screele (1,120 ft.), 30. 8 to 7. 9. 94. **Diptera.** *Syrphidae*: (8) *Sericomyia borealis* Fln., f. p., freq. F. H. 6 and 7. 9. 94. (9) *Platychirus albimanus* F., s. h. and f. p. freq. Rasc. 31. 8 and F. H. 6. 9. 94. (10) *P. manicatus* Mg., s. h. freq. F. H. 6. 9. 94. *Anthomyiidae*: (11) *Limnophora* sp.?, f. p. Rasc. Rd. 31. 8. 94. (12) *Anthomyia radicum* L., s. h., do. (13) *A.* sp.?, f. p. do. *Cordyluridae*: (14) *Scatophaga stercoraria* L., f. p. freq. F. H. 6. 9. 94. *Sepsidae*: (15) *Themira minor* Hal., s. h. ab., do.

10. *Erica cinerea* L. [Class H, Lit. 1, 4, 18, 21, 633 a, 467 b, 478 b. See also Art. 49, below.] Abundant on the moors, though not equal to *Calluna*. The base of the corolla was often found to be perforated (presumably by Bombi). On the summit of Screele (1,120 ft.) nearly all the flowers were in this condition, but were being visited by great numbers of *Apis*, sucking honey in the proper manner.

Visitors. **Lepidoptera.** Rhopalocera: (1) *Epinephele janira* L., s. h. freq. F. H. 22-24. 8. 94. **Hymenoptera.** Aculeata: *Acutilingues*: (2) *Apis mellifica* L., s. h. very ab. F. H. and Rasc. 22. 8. to 6. 9. 94. (3) *Bombus lapidarius* L., s. h. ab. F. H. and Rasc. 22. 8. to 14. 9. 94. (4) *B. muscorum* L., s. h. very ab. F. H. and Rasc. 22. 8. to 10. 9. 94. (5) *B. terrestris* L., s. h. ab. F. H. 22. 8. to 6. 9. 94. (6) *B. pratorum* L., s. h. freq. F. H. 22. 8. 94. (7) *B. latreillellus* Kirb. var. *distinguendus* Mor., s. h. F. H. 12. 9. 94. (8) *Psithyrus campestris* Pz., s. h. Rasc. 10. 9. 94. **Diptera.** *Syrphidae*: (9) *Platychirus albimanus* F., s. h. F. H. 22. 8. 94. *Anthomyiidae*: (10) *Trichophthicus cunctans* Mg., f. p.?, do.

20. E. Tetralix L. [Class H, Lit. 1, 4, 11, 12, 14, 17, 21. See also Art. 50, below.] Common on the moors, but less so than *E. cinerea*. The corolla was frequently found perforated.

Visitors. **Hymenoptera.** Aculeata: *Acutilingues*: (1) *Apis mellifica* L., s. h. ab. F. H. 6. 9. 94. (2) *Bombus muscorum* L., s. h. very ab. F. H. 6-12. 9. 94. (3) *B. hortorum* L., s. h. freq., do.

UMBELLIFERAE: 21. Caucalis Anthriscus Huds. [Class A, Lit. 1, 2, 4, 21.] Common in all parts of the district except Rascarrel beach. It was in full flower during the time of these observations, but was not very much visited.

Visitors. **Lepidoptera.** Rhopalocera: (1) *Epinephele janira* L., s. h. A. B. 2. 9. 94. **Heterocera:** *Noctuidae*: (2) a moth (? *Plusia gamma* L.), s. h. F. H. Rd. 8. 9. 94. *Tortricidae*: (3) *Simaëthis fabriciana* L., s. h. F. H. Rd. 7. 9. 94. **Hymenoptera.** Aculeata: *Acutilingues*: (4) *Halictus* sp.?, s. h. Rasc. Rd. 10. 9. 94. **Terebrantia:** *Ichneumonidae*: (5) to (7) three unnamed species, freq. Sept. 94. *Proctotrupidae*: (8) one unnamed species, do. **Diptera.** *Syrphidae*: (9) *Platychirus albimanus* F., s. h. Cl. 31. 8. 94. *Muscidae*: (10) *Stomoxys calcitrans* L., s. h. F. H. Rd. 6. 9. 94. *Anthomyiidae*: (11) *Hylemyia strigosa* F., s. h. Rasc. Rd. 31. 8. and Cl. 1. 9. 94. (12) *Anthomyia radicum* L., s. h. F. H. Rd. 9. 9. 94. (13) *Phorbia floccosa* Mcq., do. *Agromyzidae*: (14) *Agromyza flaveola* Fln., do. **Hemiptera**: (15) *Anthocoris* sp.?, do.

22. Angelica sylvestris L. [Class A, Lit. 1, 2, 4, 8, 17, 288 b.] Abundant in the district, and in full flower.

Visitors. **Lepidoptera.** Rhopalocera: (1) *Polyommatus phloea* L., s. h. Cl. 3. 9. 94. **Hymenoptera.** Aculeata: *Acutilingues*: (2) *Bombus terrestris* L., s. h. twice Rasc. 5 and 10. 9. 94. (3) *Halictus rubicundus* Chr., s. h. Rasc. 4. 9. 94. *Obtusilingues*: (4) *Prosopis brevicornis* Nyl., do. *Vespidae*: (5) *Vespa sylvestris* Scop., s. h. ab. Rasc. 4. 9. 94. Terebrantia: *Tenthredinidae*: (6) *Selandria serva* F., s. h. ? Rasc. 1. and 4. 9. 94. *Ichneumonidae*: (7) to (13) seven unnamed species, freq. Rasc. 1-10. 9. 94. *Proctotrupidae*: (14) one unnamed species, do. **Diptera.** *Syrphidae*: (15) *Chilosia oestracea* L., s. h. Cl. 3. 9. 94. (16) *Platychirus peltatus* Mg., s. h. Rasc. 4. 9. (17) *Syrphus topiarius* Mg., s. h. F. H. Rd. 13. 9. 94. (18) *Eristalis pertinax* Scop., s. h. freq. Cl. 3. Rasc. 4. 9. 94. (19) *E. horticola* Deg., s. h. Cl. 3. 9. 94. *Mycetophilidae*: (20) *Sceptonia nigra* Mg., do., 2. 9. (21) *Glaphyoptera fasciola* Mg.?, do. *Chironomidae*: (22) *Chironomus* sp.?, s. h. Cl. 3. 9. 94. (23) *Cricotopus tremulus* L., s. h. Cl. 2. 9. *Tachinidae*: (24) *Myobia inanis* Fln., s. h. Rasc. 4. 4. 94. *Sarcophagidae*: (25) *Sarcophaga* sp.?, do. *Muscidae*: (26) *Lucilia caesar* L., s. h. ab. Cl. 3. Rasc. 4. and 5. 9. 94. (27) *L. sericata* Mg., s. h. freq. Cl. 3. 9. (28) *Morellia curvipes* Mcq., s. h. freq. Cl. 3. 9., Rasc. 4. 9. *Anthomyiidae*: (29) *Hyetodesia lucorum* Fln., s. h. Rasc. 4. 9. (30) *H. incana* W., s. h. Cl. 3. 9. (31) *Mydaea* sp.?, s. h. Rasc. 4. 9. (32) *Spilogaster communis* Dsv., s. h. Rasc. 10. 9. (33) *Anthomyia radicum* L., s. h. Rasc. 4. 9. (34) *A.* sp.?, s. h. Cl. 3. 9. 94. (35) *Caricea tigrina* F., s. h. Rasc. 10. 9. *Cordyluridae*: (36) *Scatophaga stercoraria* L., s. h. Cl. 3. Rasc. 4. 9. 94. *Phoridae*: (37) *Phora* sp.?, s. h. Cl. 3. 9. 94. **Hemiptera**: (38) *Calocoris fulvo-maculatus* De G., s. h. Cl. 1. 9. (39) *Anthocoris* sp., s. h. Rasc. 4. 9. 94.

23. Pimpinella Saxifraga L. [Class A, Lit. 1, 4, 12, 14, 17, 21, 160 b, 288 b.] Abundant, and in full flower.

Visitors. **Lepidoptera.** Rhopalocera: (1) *Pieris napi* L., s. h. Cl. 31. 8. 94. **Hymenoptera.** Terebrantia: *Ichneumonidae*: (2) to (5) four unnamed species. *Braconidae*: (6) to (8) three species. *Chalcididae*: (9) one species. *Proctotrupidae*: (10) one species; all freq. **Diptera.** *Syrphidae*: (11) *Orhoneura nobilis* Fln., s. h. Cl. 10. 9. 94. (12) *Chrysogaster splendida* Mg., do. (13) *Chilosia* sp.?, do. (14) *Syrphus ribesii* L., s. h. freq. Cl. 10. 9. 94. (15) *Sphaerophoria scripta* L., s. h. Cl. 1. and 10. 9. 94. (16) *Eristalis tenax* L., s. h. Cl. 10. 9. 94. (17) *E. aeneus* Scop., s. h. freq. Cl. 10. 9. 94. (18) *E. horticola* Deg.,

do. (19) *Syritta pipiens* L., s. h. Cl. 1. 9. 94. *Mycetophilidae*: (20) *Sciara* sp.?, s. h. ab. Cl. 10. 9. 94. (21) *Sceptonia nigra* Mg., s. h. F. H. Rd. 8. 9. 94. (22) *Boletina* sp.?, do. *Empidae*: (23) *Rhamphomyia tenuirostris* Fln., s. h. Cl. 1. 9. 94. *Muscidae*: (24) *Lucilia caesar* L., s. h. Cl. 10. 9. 94. (25) *Morellia curvipes* Mcq., do. *Anthomyiidae*: (26) *Hyetodesia incana* W., do. (27) *Trichophticus cunctans* Mg., s. h. Cl. 1. 9. (28) *T.* sp.?, s. h. Rasc. 4. 9. 94. (29) *Anthomyia radicum* L., s. h. freq. Cl. and Rasc. 1-10. 9. 94. (30) *A.* sp.?, s. h. Cl. 10. 9. 94. (31) *Phorbia floccosa* Mcq., do. *Sepsidae*: (32) *Themira minor* Hal., freq. s. h. Cl. 1-10. 9. 94. *Drosophilidae*: (33) *Scaptomyza graminum* Fln., s. h. Cl. 10. 9. 94. *Phoridae*: (34) *Phora* sp.?, do. *Coleoptera*. (35) *Rhagonycha fulva* Scop., s. h. Cl. 1. 9. 94. (36) *Epuraea melina* Er., do. (37) *Meligethes* sp.?, do., ab. **Hemiptera**. (38) *Anthocoris* sp.?, s. h. F. H. Rd. 8. 9. and Cl. 10. 9. 94.

CISTACEAE: 24. *Helianthemum vulgare* Gaertn. [Class Po, Lit. 1, 2, 4, 11, 17.] Very abundant on the tops of the cliffs along this coast, but its flowering season was nearly over and but few flowers were out.

Visitor. Diptera. Anthomyiidae: (1) *Anthomyia radicum* L., f. p. very ab. Rasc. 4-10. 9. 94.

HYPERICACEAE: 25. *Hypericum perforatum* L. [Class Po, Lit. 1, 4, 11, 14, 17.] Frequent in the district: large masses on the Forest Hill Road, where all the observations were made.

Visitors. Hymenoptera. Aculeata: Acutilingues: (1) *Bombus muscorum* L., 28 and 29. 8. 94. Three times this bee visited and probed several flowers for honey, and finding none in any, flew off to other flowers. *Terebrantia*: (2) 1 sp. of *Braconidae*, 28. 8. 94. **Diptera. Syrphidae**: (3) *Platychirus albimanus* F., f. p. 28. 8. 94. (4) *P. peltatus* Mg., freq. do. (5) *Syrphus balteatus* Deg., do. 28 and 29. 8. 94. (6) *S. toparius* Mg., f. p. 28. 8. 94. (7) *Eristalis pertinax* Scop., f. p. freq. 24. 8. to 13. 9. 94. (8) *Syritta pipiens* L., f. p. freq. 31. 8. to 10. 9. 94. *Empidae*: (9) *Tachydromia* sp.?, f. p. 28. 8. 94. (10) *T.* sp.?, f. p. 30. 8. 94. *Muscidae*: (11) *Calliphora erythrocephala* Mg.,

f. p. 31. 8. 94. (12) *C. vomitoria* L., f. p. 13. 9. 94. (13) *Morellia* sp.?, f. p. 6. 9. 94. (14) *Stomoxys calcitrans* L., do. *Anthomyiidae*: (15) *Mydaea* sp.?, f. p. freq. 24-31. 8. 94. (16) *Anthomyia radicum* L., f. p. very ab. 24. 8. to 13. 9. 94. (17) *A.* sp.?, f. p. 28. 8. 94. **Coleoptera**: (18) *Meligethes aeneus* F., f. p. ab. 24. 8. to 13. 9. 94. **Hemiptera**: (19) One species.

GERANIACEAE: 26. ***Geranium Robertianum* L.** [Class B, Lit. 1, 3, 4, 11, 17, 21.] Abundant on open stony places on Rascarrel beach.

Visitors. **Lepidoptera.** Rhopalocera: (1) *Pieris napi* L., s. h. 28. 8. 94. **Hymenoptera.** Aculeata: *Acutilingues*: (2) *Bombus muscorum* L., s. h. ab. 2-12. 9. 94. **Diptera.** *Syrphidae*: (3) *Syrphus* sp.?, s. h. 5. 9. 94.

LEGUMINOSAE: 27. ***Ononis arvensis* L.** [Class H, Lit. 1, 4, 9, 11, 14, 17, 258 b.] Frequent, but rarely visited. Small flies were often seen sunning themselves on the flowers.

Visitor. **Hymenoptera.** Aculeata: *Acutilingues*: (1) *Apis mellifica* L., (twice) A. B. 18. 8. 94.

28. ***Lotus major* Sm.** [Class H, Lit. 1, 2, 3, 4, 9, 12, 14, 17, 258 b.] This plant abounds in the district, but, apparently from the competition of other plants, receives very few visits indeed.

Visitor. **Hymenoptera.** Aculeata: *Acutilingues*: (1) *Bombus muscorum* L., s. h. A. B. 2. 9. 94.

ROSACEAE: 29. ***Potentilla Tormentilla* Sibth.** [Class A B, Lit. 1, 2, 4, 21.] Everywhere common: the flowers are larger and more rich in pollen at low levels and in sheltered places.

Visitors. **Diptera.** *Syrphidae*: (1) *Sphaerophoria scripta* L., f. p. Rasc. 5. 9. 94. (2) *Syrpitta pipiens* L., do. **Muscidae**: (3) *Morellia curvipes* Mcq., s. h. Rasc. Rd. 31. 8. 94. *Anthomyiidae*: (4) *Hylemyia lasciva* Ztt., f. p., do. (5) *Anthomyia radicum* L., s. h. and f. p. very ab. Rasc., &c. 31. 8. to 6. 9. 94. *Ephydriidae*: (6) *Hydrellia griseola*

Fln., f. p. Rasc. Rd. 31. 8. 94. *Chloropidae*: (7) *Oscinis frit* L., do. *Aphodius contaminans* Herbst. (Coleoptera) was observed settled on the flowers in one case.

30. *Rubus fruticosus* L. [Class B, Lit. 1, 2, 3, 4, 11, 339 b, &c.] Abundant everywhere, but the flowering season was nearly over. It was still, however, largely visited.

Visitors. Lepidoptera. Rhopalocera: (1) *Pieris napi* L., s. h. freq. 24. 8 to 12. 9. 94. Rasc. F. H. Rd. &c. Heterocera: *Tortricidae*: (2) *Simaëthis fabriciana* L., s. h. freq. F. H. Rd. 29. 8. and 6. 9. Rasc. Rd. 12. 9. 94. *Hymenoptera.* Aculeata: *Acutilingues*: (3) *Bombus muscorum* L., s. h. ab. 24. 8 to 10. 9. 94. all stations. (4) *B. hortorum* L.?, s. h. ab. 24. 8. 94. F. H. Rd. *Diptera.* *Syrphidae*: (5) *Platychirus albimanus* F., s. h. A. B. 2. 9. 94. (6) *Syrphus balteatus* Deg., f. p. F. H. Rd. 29. 8. 94. (7) *S. toparius* Mg., s. h. F. H. Rd. 12. 9. 94. (8) *Eristalis pertinax* Scop., s. h. freq. 24. 8. 94. *Anthomyiidae*: (9) *Anthomyia radicum* L., freq. 29. 8 to 12. 9. 94. *Coleoptera*: (10) *Meligethes viridescens* F., s. h. and f. p. ab., do.

31. *Spiraea Ulmaria* L. [Class Po, Lit. 1, 2, 3, 4, 8, 9, 11, 17, 21, 288 b.] Abundant on Forest Hill Road and Collin Road, but past its best season.

Visitors. Diptera. Syrphidae: (1) *Melanostoma scalare* F., f. p. F. H. Rd. 29. 8. 94. (2) *Eristalis aeneus* Scop., f. p. Cl. 3. 9. 94. (3) *E. tenax* L., do. (4) *E. horticola* Deg., do. *Chironomidae*: (5) *Corynoneura* sp.?, f. p. F. H. Rd. 28. 8. 94. *Anthomyiidae*: (6) *Mydaea* sp.?, do. (7) *Trichophthicus hirsutulus* Ztt., do. (8) *Anthomyia radicum* L., very ab., do. *Coleoptera*: (9) *Epuraea melina* Er., f. p. F. H. Rd. 30. 8. 94. (10) *Meligethes viridescens* F., f. p. ab. 24. 8 to 10. 9. 94. (11) *M. aeneus* F., do.

PAPAVERACEAE: **32. *Corydalis claviculata* DC.** [Class H, Lit. 4, 9, 13.] Abundant on the Rascarrel Road. The flowers are visited only by bees.

Visitors. Hymenoptera. Aculeata, *Acutilingues*: (1) *Bombus muscorum* L., s. h. ab. 31. 8 to 5. 9. 94. (2) *B. terrestris* L., s. h. 31. 8. 94. Both these effect fertilization. Every flower seems to set seed.

CARYOPHYLLACEAE: 33. *Lychnis diurna* Sibth. [Class F, Lit. 1, 2, 4, 9, 11, 14, 117 b, 288 b.] Common in the district, but its flowering season was getting over.

Visitors. Hymenoptera. Aculeata: Acutilingues: (1) *Bombus terrestris* L., s. h. freq. 31. 8 to 13. 9. 94. *Diptera. Syrphidae:* (2) *Platychirus albimanus* F., f. p. Cl. 31. 8. 94, and so only going to male flowers.

As the above observations are all made at one period and place, and cover the important flowers of the local flora, it will be best to sum them up independently of those which follow.

Summing up first of all the total number of visits received by each class of flower, we get the following table:—

TABLE I.

Class.	No. of Flowers.	Lepidoptera.	Long-tongued Bees.	Short-tongued Bees.	Other Hymenoptera.	Long-tongued Flies.	Short-tongued Flies.	Coleoptera.	Other insects.	Total.
Po	3	—	1	—	1	10	14	4	1	31
A	3	5	1	3	23	15	38	3	4	92
AB	1	—	—	—	—	2	5	—	—	7
B	5	8	11	1	—	12	11	4	—	47
B'	31	27	10	6	—	45	53	9	15	196
H	11	4	30	—	—	5	3	3	2	47
F	2	—	2	—	—	1	—	—	—	3
Total	33	48	72	14	30	90	124	23	22	423
% of Total		11.3	17.0	3.3	7.1	21.2	29.3	5.4	5.4	

Next, adopting the percentage method, and using as a reference line the percentage number of visits of *all* insects to each class of flower (see 341 b), we get this table:—

TABLE II.

Class.	Per cent. of total visits.	Per cent. of Lepidoptera visits.	Per cent. of Long-tongued Bees.	Per cent. of Short-tongued Bees.	Per cent. of other Hymenoptera.	Per cent. of Long-tongued Flies.	Per cent. of Short-tongued Flies.	Per cent. of Coleoptera.	Per cent. of others
Po	7.32	—	1.4	—	3.33	11.11	11.29	17.39	4.54
A	21.74	10.4	1.4	21.43	76.66	16.66	30.64	13.04	18.18
AB	1.05	—	—	—	—	2.22	4.03	—	—
B	11.11	16.66	15.28	7.14	—	13.33	8.87	17.39	—
B'	46.33	64.6	37.5	71.43	20.0	50.0	42.74	39.12	68.18
H	11.11	8.33	41.66	—	—	5.55	2.42	13.04	9.09
F	.71	—	2.8	—	—	1.11	—	—	—

These two tables at once show the enormous share of visits obtained by class B', which is practically the order Compositae. The figures will be seen to support the Müllerian theory of flowers very well. Taking first the Lepidoptera, they show a very great preference¹ (64.6-46.33) for Class B', which is the usual result shown in similar statistical tables (see Lit. 341 b). They do not appear to visit their own special class F, but these flowers were not watched at night, when the long-tongued moths, to which they are specially adapted, are on the wing. The only other class to which they show any preference is B. Most other observers have found them rather to avoid this class. They avoid, more or less, all the remaining classes. The long-tongued bees, as usual, show a very marked preference (41.66-11.11) for class H, and a small avoidance of B'. The short-tongued bees prefer especially B'. The long-tongued flies show very slight preferences for B', B, Po; they rather avoid A, a result at variance with those of other workers. The short-tongued

¹ Preference of a particular class of flowers, X, by a particular group of insects, Y, is shown by the per cent. of Y visiting X exceeding the per cent. number of the total insect visitors to X.

flies give results agreeing with previous ones, except that the avoidance of Class B' is very slight, instead of, as usual, very great.

Taken as a whole, then, we may say that these results support the Müllerian theory of flowers very well. Further facts in support of it may be obtained by taking note of the flowers visited by each particular insect. One or two cases may be given. Among the butterflies *Pieris napi* was the most frequent visitor, going to 10 flowers, all but one (*Pimpinella*) in Classes B, B', H. *Polyommatus phloea*s, the next commonest, went to 7 flowers in these classes, and 1 other (*Angelica*). These two, with *Epinephele janira*, *Pieris rapae*, and *Vanessa urticae*, were the only butterflies common in the district.

Taking next the long-tongued bees, of which there are 12 species—*Apis mellifica*, *Anthidium manicatum*, and 10 *Bombi* (incl. *Psithyrus*)—the bulk of the visits were made by the humble-bees (62 out of 72). *Bombus muscorum* L. was the commonest bee, and visited, usually in abundance, 19 flowers, all but one (*Hypericum*) in the higher classes (B, B', H). *B. terrestris* was nearly as common (16 flowers), whilst *B. latreillellus* var. *distinguendus*, *B. cognatus*, and *Psithyrus quadricolor* were seen only on 1 flower each. The hive bee offers an interesting list. The district is famous for its honey, and in the small village of Auchencairn there are over 100 hives. The heather was then in full bloom (*Calluna* and two species of *Erica*) and attracted very nearly all the bees, which were abundant on it, even up to the highest hill-tops in the district (Ben Gairn, 1,250 feet). The only other plant that received any particular attention from them was *Senecio Jacobaea*, the most conspicuous and abundant plant, next to the heather. On this they were usually to be seen, especially in dull or cold weather, when they seemed disinclined to go to the moors.

The short-tongued bees—6 species : 3 of *Halictus*, 1 each of *Andrena*, *Prosopis*, *Sphcodes*—paid nearly all their visits to Class B'. On the *Senecio* they abounded, but they are

distinctly scarce in the district. It must be remembered that, as Macleod has shown (18), they become less numerous as the season advances. Of the other Hymenoptera, *Vespa sylvestris* was abundant on *Angelica*, but was never seen on any other plant. The Ichneumonidae and their allies were found in great numbers on the Umbellifers, and on *Senecio*, &c. Whether or not they visit the flowers for floral food they must be of some importance in fertilization.

Of the Syrphidae, 25 species were observed, making 89 (species-) visits. The commonest were (in order) *Eristalis tenax* (on 9 flowers), *E. pertinax* (8), *Platychirus albimanus* (8). *Rhingia rostrata* was abundant on *Centaurea* and *Stachys*, but was never seen on any other flower. Altogether the number of visits made by these flies forms more than a fifth of the total, but it is known that they increase in (proportionate) number in late summer (see 341 b and 18).

The short-tongued flies number 50 species with 124 visits (the largest number for any group). The commonest species belong to the genera *Lucilia* (esp. *L. sericata*), *Trichophthicus*, *Anthomyia* (*A. radicum* on 22 flowers), *Hyetodesia*, *Mydaea*, *Scatophaga*. No species of any other genus was seen on more than 4 flowers. In individuals, these flies far outnumber the other groups, and must be of considerable importance in fertilization.

Of the Coleoptera (11 species, 23 visits) the only common ones are species of *Meligethes* (abundant in nearly every flower) and *Crepidodera ferruginea*. Of the Hemiptera (6 species, 22 visits) *Anthocoris* was common.

If we compare the percentages of visitors of each class of insects (foot of Table 1) with those given by Müller (Fert. of Flrs. p. 654), it will be seen that considerable differences exist between the composition of the flower-visiting insect fauna in Germany and in South Scotland, as shown in the figures. The Lepidoptera (11.3 per cent. against 6.9 per cent.), Syrphidae (21.2 to 19.6), other Diptera (29.3 to 10.9) and miscellaneous insects (Hemiptera, &c.) (5.4 to 0.9) are more numerous *in proportion* in Scotland, whilst the long-tongued

bees (17.0 to 23.1), short-tongued bees (3.3 to 18.0), other Hymenoptera (7.1 to 10.6) and Coleoptera (5.4 to 8.9) are proportionately less numerous.

Allowing for the season of the year at which the Scotch observations were made (late summer, when Lepidoptera and Syrphidae are more numerous, short-tongued bees and flies less numerous in proportion than earlier in the year), we may perhaps conclude that as regards the composition of the flower-visiting fauna, there is in Scotland, as compared with Low Germany, a great proportionate preponderance of short-tongued flies, compensated for by a diminution of the Hymenoptera (more especially the short-tongued bees). This fact of the greater proportion of flies in Britain is, of course, already known to entomologists, but it is still worthy of mention here, as it comes out in a different way and gives a quantitative result for comparisons. From the great preponderance of flies in the country it does not follow that the composition of the group of visitors to flowers of high type (Classes B, B', H) will necessarily be correspondingly altered; we might rather expect to find a greater proportionate number of flowers of low type (Classes Po, A, AB), whilst those of higher type would have fewer visitors than in Germany, and perhaps have more self-fertilization or vegetative reproduction. This, however, hardly seems to be the case. (It will be discussed in full in Part II.)

3. OBSERVATIONS AT SCARBOROUGH, 1893-4,

BY I. H. BURKILL.

Though further south, Scarborough, being on the east coast, has a rather colder climate than Auchencairn, and as the insect observations were made chiefly upon the cliffs, exposed to the east winds and not receiving much sun, these facts must be borne in mind in comparing the two places.

COMPOSITAE: 34. *Eupatorium cannabinum* L. [Class

B', Lit. 1, 2, 3, 4, 9, 11, 17, 18.] Observed Aug. 27 to Sept. 26, 1894.

Visitors. **Lepidoptera.** Rhopalocera: (1) *Vanessa urticae* L., s. h. **Hymenoptera.** Aculeata: *Acutilingues*: (2) *Bombus lapidarius* L., s. h. *Myrmicidae*: (3) *Myrmica rubra* L., running about on heads. **Diptera.** *Syrphidae*: (4) *Platychirus manicatus* Mg. (5) *Syrphus ribesii* L. (6) *Sphaerophoria scripta* L. (7) *Eristalis tenax* L., s. h. (8) *E. pertinax* Scop., s. h. (9) *E. horticola* Deg., s. h. (10) *Syritta pipiens* L. *Tachinidae*: (11) *Siphona geniculata* Deg. *Muscidae*: (12) *Lucilia cornicina* F., s. h. (13) *Calliphora erythrocephala* Mg., s. h. (14) *C. sepulchralis* Mg. *Anthomyiidae*: (15) *Anthomyia radicum* L., s. h. and f. p. (16) *A. brevicornis* Ztt., f. p. *Cordyluridae*: (17) *Scatophaga stercoraria* L. *Phoridae*: (18) *Phora* sp.? **Coleoptera**: (19) *Meligethes picipes* Sturm, f. p.

35. *Inula dysenterica* L. [Class B', Lit. 1, 2, 3, 4, 9, 11, 18, 163 b.] Observed Sept. 20 to Sept. 30, 1893, and Aug. 27 to Sept. 26, 1894.

Visitors. **Lepidoptera.** Heterocera: *Tortricidae*: (1) *Simaëthis fabriciana* L., s. h. *Tineidae*: (2) *Plutella cruciferarum* Zel., s. h. **Hymenoptera.** Aculeata: *Acutilingues*: (3) *Bombus lapidarius* L., s. h. Terebrantia: *Ichneumonidae*: (4) one species. *Braconidae*: (5) one species. **Diptera.** *Syrphidae*: (6) *Platychirus manicatus* Mg. (7) *P. albimanus* F. (8) *Syrphus ribesii* L. (9) *Sphaerophoria scripta* L. (10) *Eristalis tenax* L., s. h. (11) *E. arbustorum* L. (12) *E. pertinax* Scop., s. h. (13) *Syritta pipiens* L. *Tachinidae*: (14) *Siphona geniculata* Deg., ab. s. h. and f. p. *Muscidae*: (15) *Lucilia cornicina* F. (16) *Calliphora erythrocephala* Mg. (17) *Morellia* sp.? *Anthomyiidae*: (18) *Drymia hamata* Fln., f. p. and s. h. (19) *Hylemyia strigosa* F. (20) *Anthomyia radicum* L., very ab. f. p. (21) *A. brevicornis* Ztt., f. p. (22) *Phorbia lactucae* Bouché, f. p. *Cordyluridae*: (23) *Scatophaga stercoraria* L. *Phycodromidae*: (24) *Coelopa* sp.?, f. p. **Coleoptera**: (25) *Meligethes picipes* Sturm. (26) *M. obscurus* Er. (27) *M. viridescens* F., devouring pollen and almost covered with it. (28) *M. aeneus* F., do., f. p. • **Thysanoptera**: (29) *Thrips* sp.

DIPSACEAE: 36. *Scabiosa succisa* L. [See No. 9, Auchencairn.] Observed Aug. 27 to Sept. 26, 1894. The species was observed to be gynodioecious.

Visitors. **Lepidoptera.** Heterocera: *Noctuidae*: (1) *Plusia gamma* L., s. h. **Hymenoptera.** Aculeata: *Acutilingues*: (2) *Bombus lapidarius* L., s. h. and c. p. (3) *B. muscorum* L., s. h. and c. p. very ab. (4) *B. hortorum* L., s. h. *Myrmicidae*: (5) *Myrmica rubra* L., s. h. **Diptera.** *Syrphidae*: (6) *Melanostoma scalare* F. (7) *Platychirus manicatus* Mg. (8) *Syrphus balteatus* Deg. (9) *S. ribesii* L., s. h. (10) *Sphaerophoria scripta* L. (11) *Eristalis tenax* L., s. h. *Tachinidae*: (12) *Siphona geniculata* Deg., s. h. *Muscidae*: (13) *Lucilia cornicina* F., s. h. (14) *Calliphora erythrocephala* Mg., s. h. *Anthomyiidae*: (15) *Anthomyia radicum* L., f. p. (16) *A. brevicornis* Ztt., s. h. *Cordyluridae*: (17) *Scatophaga stercoraria* L., s. h. **Coleoptera**: (18) *Crepidodera ferruginea* Scop., s. h. (19) *Meligethes picipes* Sturm, s. h. (20) *M. viridescens* F., s. h.

LABIATAE: 37. *Mentha aquatica* L. [See No. 12, Auchencairn.] Observed Sept. 20 to Oct. 7, 1893. This species is largely visited on the Scarborough cliffs. It is gynodioecious, the two forms occurring in almost equal numbers and both freely visited. [In the list of visitors, the letters in brackets denote the form visited; H = hermaphrodite, F = female.] In the dusk, *Plusia gamma* was observed seeking for flowers on a flowerless plant, and so had probably been attracted thither by the smell. If this be so, the diminished conspicuousness of the female flowers may not be much of a disadvantage. The style in these flowers lies close under the upper lip, scarcely being touched by insects until mature. The flowers are protandrous. *Thrips* and small parasitic Hymenoptera are common, lounging in the flowers. The larva of *Eupithecia centaureata* S. V. was observed destroying a large number of flowers by devouring the style and stamens.

Visitors. **Lepidoptera.** Rhopalocera: (1) *Vanessa urticae* L., s. h. (H). Heterocera: *Noctuidae*: (2) *Plusia gamma* L., s. h. (H). *Crambidae*: (3) *Chilo furcatellus* Ztt., s. h. (H). *Pterophoridae*: (4) *Pterophorus fuscus* Retz., s. h. (H, F). *Tineidae*: (5) *Plutella cruciferarum* Zel., s. h. (H, F). **Hymenoptera.** Aculeata: *Acutilingues*: (6) *Bombus hortorum* L., s. h. (H). (7) *B. lapidarius* L., s. h. (H). (8) *B. muscorum* L., s. h. (H). Terebrantia: *Ichneumonidae*: (9) one

species. *Braconidae*: (10) to (12) three species. *Chalcididae*: (13) to (16) four species. *Proctotrupidae*: (17) to (20) four species. All these parasites wandering from flower to flower (H and F equally) and often remaining long inside the tubes. **Diptera.** *Syrphidae*: (21) *Platychirus manicatus* Mg. (H, F). (22) *P. albimanus* F. (H). (23) *P. scutatus* Mg., s. h. (H). (24) *Syrphus balteatus* Deg. (H). (25) *S. corollae* F. (H, F). (26) *S. ribesii* L. (H). (27) *Arctophila mussitans* F., s. h. (H). (28) *Eristalis tenax* L., s. h. (H, F). (29) *E. pertinax* Scop., s. h. (H, F). (30) *E. arbustorum* L., s. h. (H). (31) *E. horticola* Deg., s. h. (H, F). (32) *Helophilus pendulus* L., s. h. (H). (33) *Syritta pipiens* L., s. h. (H). *Mycetophilidae*: (34) *Sciara* sp.? (H). *Bibionidae*: (35) *Scatopse brevicornis* Mg., s. h. et in copulâ (H, F). (36) *Bibio lepidus* Lw. (H). *Psychodidae*: (37) *Pericoma* sp.? (F). *Culicidae*: (38) *Anopheles* sp.?, four times, seemingly s. h. (F). *Lonchopteridae*: (39) *Lonchoptera* sp.? (F). *Tachinidae*: (40) *Siphona geniculata* Deg., s. h. and f. p. (H, F, most often on latter). *Sarcophagidae*: (41) *Sarcophaga carnaria* L., s. h. (H). (42) *S.* sp.?, s. h. (H). *Muscidae*: (43) *Lucilia cornicina* F., s. h. and f. p. (H, F). (44) *Calliphora erythrocephala* Mg., s. h. (H). (45) *Morellia importunata* Hal., s. h. (H). (46) *Stomoxys calcitrans* L., f. p. and s. h. (H, F). *Anthomyiidae*: (47) *Anthomyia radicum* L., f. p. and s. h. (H, F). (48) *A. brevicornis* Ztt., s. h. (H, F). *Cordyluridae*: (49) *Scatophaga stercoraria* L. (H). *Phycodromidae*: (50) *Coelopa* sp.?, s. h.? and f. p. (H, F). *Trypetidae*: (51) *Ensina sonchi* L. (H). *Sepsidae*: (52) *Sepsis cynipsea* L. (H). *Chloropidae*: (53) *Oscinis frit* L., s. h. (H, F). *Phoridae*: (54) *Phora* sp.? (H). **Coleoptera**: (55) *Meligethes picipes* Sturm, (H). (56) *M. aeneus* F., s. h. (H, F) (57) *Pria dulcamarae* Scop., s. h. (H, F). (58) *Cercus rufilabris* Latr., s. h. (F). **Hemiptera**: (59) *Heterocordylus* sp.?, freq. running about the heads. **Thysanoptera**: (60) *Thrips* sp.?, very ab. (H, F).

UMBELLIFERAE: 38. *Daucus Carota* L. [Class A, Lit. 1, 2, 3, 4, 8, 11, 14, 17, 21, 50 b, 365 b, 528 b, &c.] Observed Aug. 27 to Sept. 26, 1894. The flowers are often thronged with ants or parasitic Hymenoptera, as many as 35 of the latter having been seen together on a single umbel. The single visit of *Bombus* was of very short duration.

Visitors. **Hymenoptera.** Aculeata: *Acutilingues*: (1) *Bombus*

hortorum L., s. h., once. *Pompilidae*: (2) *Priocnemis pusillus* Schiödt, 31. 8. 94. *Formicidae*: (3) *Formica fusca* L., s. h. *Myrmicidae*: (4) *Myrmica rubra* L., s. h. Terebrantia: *Tenthredinidae*: (5) *Allantus arcuatus* Fors., s. h. *Ichneumonidae*: (6) to (11) six species. *Braconidae*: (12) to (20) nine species. *Chalcididae*: (21) to (29) nine species. *Proctotrupidae*: (30) one species. **Diptera.** *Syrphidae*: (31) *Paragus* sp.? (32) *Melanostoma scalare* F. (33) *Platychirus albimanus* F. (34) *Syrphus barbifrons* Fln. (35) *S. ribesii* L., s. h. (36) *Sphaerophoria scripta* L. (37) *Eristalis tenax* L., s. h. (38) *E. arbustorum* L., s. h. (39) *E. pertinax* Scop., s. h. (40) *Syrtrita pipiens* L., s. h. *Mycetophilidae*: (41) *Sciara* sp., freq. *Chironomidae*: (42) *Ceratopogon niger* Wimm. *Psychodidae*: (43) *Pericoma* sp.? *Sarcophagidae*: (44) and (45) *Sarcophaga*, two species. *Muscidae*: (46) *Lucilia cornicina* F. (47) *L. sylvarum* Mg. (48) *L. splendida* Mg. (49) *Calliphora erythrocephala* Mg., s. h. (50) *C. vomitoria* L., s. h. (51) *Pollenia rudis* F. (52) *Morellia* sp.? *Anthomyiidae*: (53) *Anthomyia radicum* L., very ab. (54) *A. brevicornis* Ztt. *Cordyluridae*: (55) *Scatophaga stercoraria* L., s. h. *Sepsidae*: (56) *Sepsis cynipsea* L. *Ephydriidae*: (57) *Hydrellia griseola* Fln. *Drosophilidae*: (58) *Scaptomyza graminum* Fln. *Chloropidae*: (59) *Oscinis frit* L. *Phoridae*: (60) *Phora* sp.? **Coleoptera**: (61) *Tachyporus obtusus* L. (62) *Cercus rufilabris* Latr. (63) *Meligethes picipes* Sturm. (64) *Crepidodera ferruginea* Scop.

SAXIFRAGACEAE: 30. *Parnassia palustris* L. [Class A, Lit. 1, 2, 4, 9, 14, 17, 25, 48 b, 244 b, 287 b, &c.] Abundant on Scarborough cliffs. Observed Aug. 27 to Sept. 26, 1894.

Visitors. Hymenoptera. Aculeata: *Formicidae*: (1) *Formica fusca* L., s. h. *Myrmicidae*: (2) *Myrmica rubra* L., s. h. Terebrantia: *Chalcididae*: (3) and (4) two species. *Proctotrupidae*: (5) one species. **Diptera.** *Syrphidae*: (6) *Melanostoma scalare* F. (7) *Platychirus albimanus* F. (8) *Sphaerophoria scripta* L., s. h. (9) *Eristalis tenax* L. (10) *Helophilus pendulus* L., s. h. *Mycetophilidae*: (11) *Sciara* sp.? *Bibionidae*: (12) *Scatopse brevicornis* Mg. *Sarcophagidae*: (13) *Sarcophaga* sp.? *Muscidae*: (14) *Calliphora erythrocephala* Mg., s. h. *Anthomyiidae*: (15) *Anthomyia radicum* L., freq. s. h. (16) *A. brevicornis* Ztt., f. p. *Phycodromidae*: (17) *Coelopa* sp.? f. p. *Sepsidae*: (18) *Sepsis cynipsea* L. *Ephydriidae*:

(19) *Hydrellia griseola* Fln. *Phytomyzidae*: (20) *Phytomyza* sp.? *Phoridae*: (21) *Phora* sp.? **Coleoptera**: (22) *Meligethes picipes* Sturm, s. h. **Hemiptera**: (23) one sp.,? probing nectary.

Summing up as before we have:—

TABLE III.

Class.	No. of Flowers.	Lepidoptera.	Long-tongued Bees.	Short-tongued Bees.	Other Hymenoptera.	Long-tongued Flies.	Short-tongued Flies.	Coleoptera.	Other Insects.	Total.
A	2	—	1	—	34	15	31	5	1	87
B	1	5	3	—	12	13	21	4	2	60
B'	3	4	5	—	4	21	25	8	1	68
Total	6	9	9	—	50	49	77	17	4	215
Low Ger.	6	22	12	25	25 +	62	21	20	4	191 +

The percentage method cannot be employed here, as the figures are too small, and the observations do not cover the whole flora of the district (though they do cover most of the conspicuous part of the flora of the cliffs). In the bottom line of the table are given the totals of visitors to the same plants observed in Low Germany by Müller, and it is at once seen that, as at Auchencairn, the proportion of short-tongued flies is much larger at Scarborough, whilst that of the bees is smaller. The figures agree pretty well with those obtained from Scotland, except for Lepidoptera, which form here only 4·3 per cent. of the total, and thus fall below the proportion for Germany. The same result appears if we compare the lists of visitors to *Mentha* and *Scabiosa*, examined both at Auchencairn and Scarborough.

An attempt was made to determine, for each flower, during one month (see dates above), the proportionate number of

individuals of each insect group that visited the flowers. This gives :—

TABLE IV.

	Lepidoptera.	Hymenoptera.					Diptera.		Coleoptera.	Hemiptera.	Total.
		Acutilingues (Bees) (long-tongued only)	Formicidae & Myrmicidae.	Fossore.	Phytophaga (Tenthredinidae).	Entomophaga.	Syrphidae.	Short-tongued Flies.			
Parnassia.....	—	—	38	—	—	5	13	124	7	2	189
Daucus	—	1	27	1	16	184	45	378	13	—	765
Mentha	44	6	—	—	—	51	272	900	15	2	1290
Scabiosa	1	182	1	—	—	—	50	92	3	—	329
Inula	17	3	—	—	—	2	10	272	6	—	310
Eupatorium ..	1	1	—	—	—	1	47	64	2	—	116
Total	63	193	166	1	16	243	437	1830	46	4	2999
Percentage	2.10	6.43	5.53	0.03	0.53	8.10	14.57	61.0	1.53	0.13	—

Thrips is not included.

This table is of course only a very rough approximation, but it serves to show, approximately, the relative numbers of visits received by the different flowers, or paid by the different groups of insects. It brings out, even better than the preceding tables, the enormous preponderance in Britain of short-tongued flies. Even in *Scabiosa*, the flower of highest type in the above list, they form a large proportion of the total visitors. We must remember also that the efficacy in cross-fertilization of a group of insects depends, for any locality, much more on the number of individuals visiting than on the number of species.

The list is also of interest as showing the choices made by the various insect groups in an extremely limited flora (note e.g. the bees).

4. OBSERVATIONS AT CAMBRIDGE, 1892-4.

I. H. B. AND J. C. W.

Only four flowers were carefully watched, and their visitors are noted below.

LABIATAE: 40. *Origanum vulgare* L. [Class B, Lit. 1, 2, 3, 4, 17, 18, 21, 26, &c.] A great mass of this plant was growing in the Botanic Garden (for the experiments described in 26) and the insects visiting it were noted, during the years 1892-3-4 (middle of July to about Aug. 20).

Visitors. Lepidoptera. Rhopalocera: (1) *Pieris brassicae* L., s. h. freq. (2) *P. napi* L., do. (3) *P. rapae* L., do. (4) *Vanessa urticae* L., do. (5) *Polyommatus phloea* L., do. *Heterocera: Pyralidae:* (6) *Pyrausta ostrinalis* Hb., s. h. *Hymenoptera. Aculeata: Acutilingues:* (7) *Apis mellifica* L., s. h. ab. (8) *Bombus hortorum* L., do. (9) *B. pratorum* L., do. (10) *B. terrestris* L., do. (11) *Psithyrus vestalis* Fourc., s. h. (12) *P. quadricolor* Lep., s. h. (13) *Andrena* sp.?, s. h. (14) *Halictus minutissimus* Kirby, s. h. *Eumenidae:* (15) *Odynerus* sp.?, s. h. *Diptera. Syrphidae:* (16) *Syrphus balteatus* Deg. (17) *S. ribesii* L. (18) *S. vitripennis* Mg. (19) *Eristalis tenax* L. (20) *E. pertinax* Scop. (21) *E. horticola* Deg. (22) *Myiatropa florea* L. *Tachinidae:* (23) *Siphona geniculata* Deg. *Anthomyiidae:* (24) *Anthomyia* sp.? (25) *Homalomyia canicularis* L. *Cordyluridae:* (26) *Scatophaga stercoraria* L. *Coleoptera:* (27) *Meligethes aeneus* F., f. p. *Hemiptera:* (28) *Calocoris bipunctatus* F. (29) *Anthocoris* sp.? (30) *A. sp?*

41. *Ballota nigra* L. [Class H, Lit. 1, 3, 4, 11, 17, 18, 21, &c.] Abounds in the district. The observations were mostly made at Grantchester, in Aug. 1893.

Visitors. Lepidoptera. Rhopalocera: (1) *Pieris rapae* L., s. h. *Heterocera: Noctuidae:* (2) *Plusia gamma* L., s. h. Shelford, Oct. 7, 1894. *Hymenoptera. Aculeata: Acutilingues:* (3) *Bombus cognatus* Steph., s. h. (4) *B. muscorum* L., s. h. (5) *B. latreillellus* Kirb., s. h. (6) *Halictus* sp.?, s. h. *Diptera. Syrphidae:* (7)

Syrphus sp.?, s. h. (8) *Rhingia rostrata* L., s. h. (9) *Syritta pipiens* L., s. h.

VERBENACEAE: 42. *Verbena officinalis* L. [Class B, Lit. 1, 2, 3, 4, 11, 17, 18, &c.] Observed in the Botanic Garden, on a mass of plants growing wild beside the marjoram, July, 1892-3.

Visitors. **Lepidoptera.** Rhopalocera: (1) *Lycaena icarus* Rott., s. h. freq. **Hymenoptera.** Aculeata: *Acutilingues*: (2) *Apis mellifica* L., s. h. freq. (3) *Bombus muscorum* L., s. h. freq. **Diptera.** *Syrphidae*: (4) *Syrphus* sp.?, s. h. (5) *Platychirus* sp.?, s. h.

ARALIACEAE: 43. *Hedera Helix* L. [Class A, Lit. 1, 3, 4, 10, 11, 18, 258 b, 471 a, 599 A b, &c.] Observed in the Botanic Garden, on a large bed of ivy, and at Grantchester, Nov. 1894.

Visitors. **Lepidoptera.** Heterocera: *Tortricidae*: (1) one spec. unnamed. **Hymenoptera.** Aculeata: *Vespidae*: *Vespa vulgaris* L., s. h. ab. Terebrantia: (3) to (7) five species. **Diptera.** *Syrphidae*: (8) *Eristalis tenax* L., s. h. freq. *Mycetophilidae*: (9) *Sciara* sp.? (10) *Bolitophila fusca* Mg. *Chironomidae*: (11) *Orthocladus* sp.? (12) *Metriocnemus* sp.? *Tachinidae*: (13) *Siphona geniculata* Deg., s. h. *Muscidae*: (14) *Lucilia* sp.?, s. h. (15) *Calliphora erythrocephala* Mg., very ab., s. h. (16) *C. sepulchralis* Mg., s. h. (17) *Pollenia rudis* F., ab. s. h. *Anthomyiidae*: (18) *Polistes lardaria* F. (19) *Hyetodesia lucorum* Fln. (20) *Limnophora* sp.? (21) *Trichophthicus cunctans* Mg. (22) and (23) *Anthomyia*, two sp. *Cordyluridae*: (24) *Scatophaga stercoraria* L., s. h. *Ephydriidae*: (25) *Hydrellia griseola* Fln. *Drosophilidae*: (26) *Scaptomyza graminum* Fln. *Chloropidae*: (27) *Chloropisca ornata* Mg. *Phytomyzidae*: (28) *Phytomyza* sp.?

To these visitors may be added those of *Medicago sativa*, *falcata*, and *lupulina*, determined by one of us at Cambridge (Literat. No. 6). We thus obtain the following table:—

TABLE V.

Class.	No. of Flowers.	Lepidoptera.	Long-tongued Bees.	Short-tongued Bees.	Other Hymenoptera.	Long-tongued Flies.	Short-tongued Flies.	Coleoptera.	Other Insecta.	Total.
A	1	1	—	—	6	1	20	—	—	28
B	2	7	8	2	1	9	4	1	3	35
H	4	13	12	5	4	22	18	1	2	77
Total	7	21	20	7	11	32	42	2	5	140
Low Ger.	7	35	47	25	6	31	9	1	—	154

As before, Müller's totals are given for comparison; the result is much the same as for the Scarborough observations, but the Lepidoptera are in larger proportion.

5. OBSERVATIONS IN MID WALES, 1893.

I. H. B. AND J. C. W.

These were made during a residence of three weeks in the uplands of NE. Cardiganshire (Plynlimmon district), from Aug. 26 to Sept. 16, 1893. A full description of the flora of this wild and barren district will be found in our paper upon it¹. Observations were made both at alpine and sub-alpine levels. We have taken as a dividing line for this purpose the upper limit of cultivation (about 1,100 feet above sea-level). *Pteris aquilina* ceases at about 1,250 feet. The highest point in the district is the summit of Plynlimmon (2,460 feet).

¹ 'Botanical Notes from North Cardiganshire.' Journ. of Bot., 1894, Jan., Feb.

CAMPANULACEAE: 44. *Jasione montana* L. (See No. 7, Auchencairn.) This plant is common up to 1,000 feet.

Visitors. **Lepidoptera.** (1) *Pieris rapae* L., 800 ft. 3. 9. 93. (2) *Polyommatus phloea* L., 750 ft. 30. 8. 93; 600 ft. 10. 9. **Hymenoptera.** *Aculeata: Acutilingues:* (3) *Bombus terrestris* L., s. h. 500 ft. 30. 8. 93. (4) *B. muscorum* L., s. h. 600 ft. 5. 9. 93. *Formicidae:* (5) *Formica fusca* L., do., 4. 9. 93. **Diptera.** *Syrphidae:* (6) *Melanostoma scalare* F., s. h. 800 ft. 6. 9. 93. (7) *Platychirus manicatus* Mg., 800 ft. 2. 9. 93. (9) *Eristalis tenax* L., s. h. 800 ft. 5. 9. 93. (8) *Helophilus pendulus* L., 700-800 ft. 3. 9. 93. *Muscidae:* (10) *Lucilia cornicina* F., f. p.?, do. *Anthomyiidae:* (11) *Anthomyia radicum* L., do., abund. (12) *A. sp.?* freq., do. *Cordyluridae:* (13) *Scatophaga stercoraria* L., s. h. 800 ft. 3. 9. 93. *Chloropidae:* (14) *Oscinis sp.?*, 700 ft. 3. 9. 93. **Coleoptera:** (15) *Meligethes viridescens* F., f. p. 800 ft. 2. 9. 93.

45. *Wahlenbergia hederacea* Rchb. [4, p. 268.] The flower faces vertically upwards. The tubular-campanulate corolla is about 10 mm. deep and 3 or 4 mm. wide at the mouth. The corolla is pale blue, veined with deep blue, and there is no scent. The stamens do not possess the broad flat base and narrow filament characteristic of *Campanula*, but widen gradually downwards, and are hairy below. The mechanism is much the same as in *Campanula*, but only the anthers wither after the pollen is shed upon the style; the filaments remain standing up as a cage over the honey. The flower has a chance of cross-fertilization and is occasionally visited, but the stigmas always ultimately bend so far back that they touch the pollen on their own style and so effect autogamy.

Visitors. **Diptera.** *Muscidae:* (1 and 2) two species, unnamed, s. h.; one was just large enough to touch the style as it entered. **Thysanoptera:** (3) *Thrips sp.* very ab. s. h. **Hemiptera:** (4) One species, creeping about in the flowers.

DIPSACEAE: 46. *Scabiosa succisa* L. [See No. 9, Auchencairn, and No. 36, Scarborough.] Abundant up to 1,200 feet (reaches a height of 1,640), and largely visited.

Visitors. **Lepidoptera.** Rhopalocera: (1) *Pieris rapae* L., s. h. 700 ft. 5. 9. 93. (2) *Vanessa C-album* L., s. h. 700 ft. 3 and 5. 9. (3) *V. atalanta* L., s. h. 700 ft. 12. 9. 93. (4) *V. urticae* L., s. h. freq. 700-1,150 ft. 28. 8 to 5. 9. 93. (5) *Coenonympha pamphilus* L., s. h. 700-900 ft. 3 to 5. 9. 93. (6) *Polyommatus phloea* L., s. h. 700 ft. 30. 8.-3. 9. 93. (7) *Lycaena icarus* Esp. do. **Heterocera:** *Noctuidae*: (8) *Plusia gamma* L., s. h. 800 ft. 5. 9. 93. (9) *Celaena haworthii* Cuc., do. (10) *Charaearas graminis* L., s. h. 800 to 1,000 ft. 31. 8. 93. **Hymenoptera.** Aculeata: *Acutilingues*: (11) *Bombus terrestris* L., s. h. 500-1,100 ft. 28. 8 to 6. 9. 93. (12) *B. lapidarius* L., s. h. freq. 700 ft. 28. 8 to 5. 9. 93. (13) *B. hortorum* L., s. h. 700 ft. 28. 8. 93. (14) *B. pratorum* L., s. h. 700 ft. 3. 9. 93, on *Plym-limmon*. (15) *B. scrimshirani* Kirby, s. h. 700 ft. Hafod. 31. 8. 93. (16) *B. muscorum* L., s. h. ab. 300-1,100 ft. 27. 8 to 15. 9. **Diptera.** *Syrphidae*: (17) *Melanostoma scalare* F., 700-1,100 ft. 31. 8 to 2. 9. 93. (18) *Platychirus manicatus* Mg., s. h. 700 ft. 5. 9. 93. (19) *Volucella pellucens* L., s. h. 500 ft. 30. 8. (20) *Sericomyia borealis* Flin., s. h. 800-1,100 ft. 21-31. 8. 93. (21) *Helophilus pendulus* L., s. h. 700 ft. 28. 8 to 5. 9. (22) *Eristalis tenax* L., s. h. very ab. 300-1,100 ft. 27. 8 to 8. 9. 93. (23) *E. intricarius* L., 30. 8. 93. (24) *E. rupium* F., s. h. 700 ft. 27. 8. 93. (25) *E. pertinax* Scop., do. 30. 8. 93. (26) *E. horticola* Deg., s. h. 800 ft. 3. 9. 93. *Empidae*: (27) *Rhamphomyia* sp.?, f. p., do. (28) *Pachymeria palparis* Egg., 630-1,000 ft. 3. 9. 93. *Tachinidae*: (29) *Siphona geniculata* Deg., ab. 700-1,000 ft. 8 and 9. 93. *Muscidae*: (30) *Lucilia cornicina* F., f. p. 700 ft. 5. 9. 93. *Anthomyiidae*: (31) *Hyetodesia incana* W., ab. 300-1,000 ft. 30. 8 to 8. 9. 93. (32) *Trichophthicus cunctans* Mg., freq. 600 ft. 30. 8. 93. (33) *Hylemyia lasciva* Ztt., 600 ft. 8. 9. 93. (34) *H. strigosa* F., freq. 900 ft. 31. 8. 93. (35) *Anthomyia* sp.?, s. h.? 800 ft. 8. 9. 93. *Cordyluridae*: (36) *Scatophaga stercoraria* L., s. h. 1,100 ft. 31. 8. 93. **Coleoptera**: (37) *Meligethes viridescens* F., freq. 500-800 ft. 28. 8 to 4. 9. **Thysanoptera**: (38) *Thrips*, sp. ab. 800 ft. 5. 9. 93.

Of these visitors, the only ones found at alpine levels were Nos. 4, 11, 16, 17, 20, 22, 36. All of these, except the last, were also observed at lower levels.

PLANTAGINACEAE: 47. *Littorella lacustris* L. [Anemophilous, Lit. 4, 14, 18.] This plant is abundant on the shores

of the many small lakes in the district. It was never found more than a few yards back from the edge of the water, and consequently it must often become submerged, in which case, as is well known, it ceases to bear flowers and propagates itself extensively by runners, at the same time producing a new type of leaf. The flowers are in groups of three, a male in the centre, on the end of a peduncle, and two sessile female flowers at the base of it. The stamens are long and flexible with large versatile anthers, and the stigmas long and brush-like. The flowers are anemophilous, and the female flowers come out before the male to which they are attached, thus hindering self-fertilization. Nearly all the specimens we examined had set a full complement of seed. No insect visitors were seen.

ERICACEAE: 48. *Calluna vulgaris* Salisb. [See No. 18, Auchencairn.] Frequent in the drier parts of the hills, but not abundant in the district.

Visitors. Lepidoptera. Rhopalocera: (1) *Coenonympha pamphilus* L., s. h. 800–1,050 ft. (on Plynlimmon) 28. 8 to 5. 9. (2) *Polyommatus phloea* L., s. h. 800 ft. 30. 8 to 10. 9. 93. (3) *Lycaena icarus* Rt., s. h. 700 ft. 30. 8. 94. (4) *Vanessa urticae* L., s. h. 800–1,150 ft. 28. 8 to 10. 9. 93. Heterocera: (5) Moth unnamed, s. h. 1,050 ft. 28. 8. 93. **Hymenoptera. Aculeata: Acutilingues:** (6) *Bombus terrestris* L., s. h. freq. 300–1,100 ft. 28. 8 to 5. 9. 93. (7) *B. lapidarius* L., s. h. 600–1,800 ft. 28. 8. 93. (8) *B. lapponicus* F., s. h. 1,800 ft. 29. 8. 93. (9) *B. scrimshirani* Kirby, s. h. 800 ft. 10. 9. 93. (10) *B. hortorum* L., s. h. 600–1,800 ft. 28. 8 to 4. 9. 93. (11) *B. muscorum* L., s. h. 300–800 ft. do. *Vespidae:* (12) *Vespa vulgaris* L., s. h. 400 ft. 1. 9. 93. *Formicidae:* (13) *Formica fusca* L., do. **Diptera. Syrphidae.** (14) *Melanostoma scalare* F., s. h. 300 ft. 30. 8. 93. (15) *Platychirus manicatus* Mg., 700 ft., do. (16) *Sericomyia borealis* Fln., s. h. 200 ft. 30. 8 to 1. 9. 93. (17) *Eristalis tenax* L., s. h. freq. 600 ft. Aug. **Muscidae:** (18) *Lucilia cornicina* F., freq. 800–1,800 ft. 28. 8 to 10. 9. 93. (19) *Calliphora erythrocephala* Mg. (20) *C. cognata* Mg. (21) *C. sepulchralis* Mg., 800–1,000 ft. 9. 93. (22) *Pollenia rudis* F., 700 ft. 30. 8. 93.

Of these visitors, Nos. 4, 6, 7, 8, 10, 18, occur at alpine levels (No. 8 only observed at 1,800 ft.).

49. Erica cinerea L. [See No. 19, Auchencairn.] Frequent in the drier regions.

Visitors. Lepidoptera. Rhopalocera: (1) *Vanessa urticae* L., s. h. 800 ft. 10. 9. 93. (2) *Polyommatus phloea* L., do. *Hymenoptera.* Aculeata: *Acutilingues*: (3) *Bombus muscorum* L., do. 4 to 10. 9. 93. (4) *B. terrestris* L., do. 27. 8 to 7. 9. 93. No alpine observations could be made, as the higher parts of the mountains are too boggy for the growth of heather.

50. E. Tetralix L. [See No. 20, Auchencairn.] Frequent.

Visitors. Lepidoptera. Rhopalocera: (1) *Coenonympha pamphilus* L., s. h. 800 ft. 28. 8. 93. *Hymenoptera.* Aculeata: *Acutilingues*: (2) *Bombus lapidarius* L., s. h. 600 ft. 26. 8. 93. (3) *B. muscorum* L., s. h. 500–1000 ft. 26. 8 to 5. 9. 93. (4) *B. terrestris* L., s. h. 900 ft. 4. 9. 93. No alpine observations.

51. Vaccinium Myrtillus L. [Class H, Lit. 1, 2, 3, 4, 17, 18, &c.] Frequent in the hills, but the flowering season nearly over.

Visitors. Hymenoptera. Aculeata: *Acutilingues*: (1) *Bombus muscorum* L., s. h. ab. 900 ft. 3. 9. 93. (2) *B. terrestris* L., do.

LYTHRACEAE: **52. Peplis Portula L.** [Lit. 330 a, 264 b, 4, 9, 14, 28.] Abundant near Pont Erwyd, both on land and in shallow running water. The flower is small (3 mm. diam.) sessile and very inconspicuous; the 6 minute white petals are very fugacious. The stigma is ripe a little before the stamens; these are bent inwards in the opening flower and pollinate it. All the flowers set their full complement of seed. No insect visitors were observed.

VIOLACEAE: **53. Viola lutea** Huds. [Class H.] Abundant in the hills (except *Potentilla*, almost the only flower).

Visitors. Diptera. Tachinidae: (1) *Siphona geniculata* Deg., s. h.? 800 ft. 15. 9. 93. *Anthomyiidae*: (2) *Hylemyia lasciva* Ztt., do. 5. 9. 93. (3) *Anthomyia* sp.? do. 29. 8. 93. No visitors seen at alpine levels.

ROSACEAE: **54. Potentilla Tormentilla L.** [See No. 20, Auchencairn.] This plant abounds on all the hills, reaching

a height of 2380 feet on Plynlimmon. It is almost the only plant to be seen in flower in late summer above 1200 feet, the Ericaceae being rare on account of the very boggy soil.

Visitors. **Lepidoptera.** Rhopalocera: (1) *Polyommatus phloea* L., s. h. 600 ft. 10. 9. 93. **Diptera.** *Syrphidae*: (2) *Sphaerophoria scripta* L., do. 5. 9. 93. (3) *Eristalis horticola* L., s. h. 800 ft. 3. 9. 93. *Tachinidae*: (4) *Siphona geniculata* Deg., s. h. 800 ft. 3. 9. 93. *Muscidae*: (5) *Lucilia cornicina* F., do. *Anthomyiidae*: (6) *Anthomyia radicum* L., do. (7) *A. sp.?* do. to 1000 ft.

RANUNCULACEAE: 55. *Ranunculus hederaceus* L. [Lit. 4, 14.] Abundant in the district. The flowers are very small (5 mm. diam.) and inconspicuous; no insects were observed to visit them. The stamens are few in number, the carpels fairly numerous with well-marked stigmas. The tissue at the base of the petals, where the nectary is usually found in this genus, is glandular-looking, but no free honey could be found. The anthers dehisce while the flower is opening and cover themselves all round with pollen, at the same time pollinating the stigmas. The stamens move outwards after dehiscence. The peduncle bends downwards after flowering, to ripen the fruit. All flowers examined were fully productive.

LILIACEAE: 56. *Narthecium ossifragum* Huds. [Class Po, Lit. 3, 14, 18.] Abundant up to 1200 feet. The mechanism agrees with Knuth's description (14), but frequently we found autogamy occurring by the flower opening so late that the anthers had already dehisced and pollinated the stigma. The fact of the plant being near the end of its flowering season may have had something to do with this (27). The tissue at the base of the stamens is juicy and may perhaps be pierced by bees, if they visit the flower (cf. *Brodiaea*, in No. 27).

Visitors. **Hymenoptera.** Aculeata: *Myrmicidae*: (1) *Myrmica rubra* L., f. p. 800 ft. 5. 9. 93. Terebrantia: *Chalcididae*: (2) One species, 800 ft. 3. 9. 93. **Diptera.** *Syrphidae*: (3) *Platychirus manicatus* Mg., f. p. 600 ft. 15. 9. 93. *Anthomyiidae*: (4) *Hylemyia lasciva* Ztt., f. p. freq. 800 ft. 5. 9. (5) *Anthomyia radicum* L., do., ab. (6) *Anth. sp.?* do. *Ephydridae*: (7) *Hydrellia griseola* Fln., do. freq. **Hemiptera.**

(8) One species, do., rare. **Thysanoptera.** (9) Thrips sp. freq. No alpine observations.

The above are almost the only flowers which form any conspicuous part of the flora above 650 feet, in September. We rarely went into lower levels, and generally were at high ones (1000–2000 feet). The following flowers were, however, present in noteworthy numbers besides those described: *Brassica Sinapis*, Visiani (common in fields), *Polygala serpyllacea*, Weihe (on the hills, frequent), *Cerastium glomeratum*, Thuill., *Hypericum quadrangulum*, *H. pulchrum*, *Lotus corniculatus*, *Rubus fruticosus* (nearly over), *Circaea lutetiana*, *Pimpinella Saxifraga*, *Solidago Virgaurea*, *Achillea Millefolium*, *Chrysanthemum Segetum* (abundant in fields and in full flower), *Cnicus palustris*, *Hieracium Pilosella*, *Euphrasia officinalis*, besides other wind-fertilized or very inconspicuous flowers. These plants must have affected the numbers (though probably not the proportions) of visitors to the flowers we have considered. Only rarely did any of them occur above the limit of the Bracken (*Pteris*).

Summing up as before the subalpine visitors, we get:—

TABLE VI.

Class.	No. of Flowers.	Lepidoptera.	Long-tongued Bees.	Short-tongued Bees.	Other Hymenoptera.	Long-tongued Flies.	Short-tongued Flies.	Coleoptera.	Other insects.	Total.
Po	1	—	—	—	2	1	4	—	2	9
AB	1	1	—	—	—	2	4	—	—	7
B	2	5	5	—	2	4	7	—	2	25
B'	2	12	8	—	1	14	14	2	1	52
H	4	3	7	—	—	—	3	—	—	13
Total	10	21	20	—	5	21	32	2	5	106
%		19.8	18.8	—	4.7	19.8	30.19	1.88	4.7	—

Ranunculus, Peplis, and Littorella, are not included.

The percentages are much the same as at Auchencairn, but the Lepidoptera show a large rise (from 11.3 to 19.8). This result is similar, but not so marked, to that found by Müller in comparing the Alps with Low Germany; but no stress at all can be laid upon it here, considering (1) the very small total of visitors; (2) the fact that the observations were made in late summer; (3) the great heat of the summer of 1893; and (4) the general favourableness of the year to Lepidoptera. Müller gives no list of visitors to *Wahlenbergia*, *Viola*, or *Erica cinerea*. If we subtract these from our list, the comparison gives

	Lepidoptera.	Long-tongued Bees.	Short-tongued Bees.	Other Hymenoptera.	Long-tongued Flies.	Short-tongued Flies.	Coleoptera.	Other insects.	Total.
Wales	19	18	—	5	21	27	2	3	95
Germany ..	17	38	62	23	48	11	5	2	206

This shows a great preponderance in Wales of Lepidoptera and short-tongued-flies, a total lack of short-tongued bees (note the season of the year, however), and a great deficiency in the other short-tongued Hymenoptera. The long-tongued bees and the long-tongued flies are as usual about equal.

Above the cultivation limit, the Plynlimmon district is exceedingly desolate. Almost the only flowers in late summer on the open mountain sides are *Potentilla Tormentilla* and *Viola lutea*, with occasional small patches of the various Ericaceae, and almost the only insects to be seen are various *Bombi*, a few flies, and an occasional butterfly or moth. The bulk of our time in the district (3 weeks) was spent at high levels, and the weather was fine throughout (and had been so since April), but the only visitors observed were those given above, 13 in all, on *Scabiosa* and *Calluna*. These insects are *Vanessa urticae* (to 1150 feet, not above

the limit of *Pteris*), *Bombus terrestris* (common to 1100 feet, and was seen at higher levels, though not visiting), *B. lapidarius* (to 1800 feet), *B. hortorum* (do.), *B. muscorum* (freq. at 1100 feet), *B. lapponicus* (1800 feet on *Calluna*, the only record of this insect visiting flowers in Britain, that we possess), *Melanostoma scalare* (1100 feet), *Sericomyia borealis* (do.), *Eristalis tenax* (do.), *Lucilia cornicina* (to 1800 feet), and *Scatophaga stercoraria* (1100 feet). With the exception of *Lucilia* and the humble bees, none of these insects were noted above the limit of *Pteris* (1270 feet). So far, therefore, as these observations go, the flower-visiting insect fauna of our British hill-districts at alpine levels resembles rather that of northern Scandinavia and Arctic countries than that of corresponding zones in the mountains of central Europe. This side of the subject we hope to consider in detail in Part II. The flowers too seem on the whole to resemble those of Arctic regions in their great development both of autogamy and vegetative reproduction.

6. SUMMARY.

The chief conclusions to be drawn from this work have been already given at the ends of the different sections, but we may add a few notes here.

In all, 51 species of the British flora are treated of (including the three species of *Medicago* at Cambridge). Several figure more than once, viz. *Fasione* (Auch. Cardig.), *Scabiosa* (Auch. Scarb. Card.), *Mentha* (Auch. Scarb.), *Calluna* (Auch. Card.), *Erica cinerea* (do.), *E. Tetralix* (do.), *Potentilla* (do.). If each of these be counted separately the total amounts to 59. Three of these (*Littorella*, *Ranunculus*, *Peplis*) have no insect visitors recorded. Adding up those of the remaining 56 (counting the plants named above as often as they occur), we get:—

TABLE VII.

Class.	No. of Flowers.	Lepidoptera.	Long-tongued Bees.	Short-tongued Bees.	Other Hymenoptera.	Long-tongued Diptera.	Short-tongued Diptera.	Coleoptera.	Other insects.	Total.	%
Po	4	—	1	—	3	11	18	4	3	40	4.52
A	6	6	2	3	63	31	89	8	5	207	23.10
AB	2	1	—	—	—	4	9	—	—	14	1.58
B	10	25	27	3	15	38	43	9	7	167	18.89
B'	13	47	40	10	11	80	92	19	17	316	35.75
H	19	20	49	5	4	27	24	4	4	137	15.50
F	2	—	2	—	—	1	—	—	—	3	0.34
Total	56	99	121	21	96	192	275	44	36	884	
%		11.20	13.69	2.37	10.86	21.72	31.11	4.98	4.0		
% Low Germany		6.9	23.1	18.0	10.6	19.6	10.9	8.9	0.9		

Müller's total recorded visits in Low Germany (Fert. of Flrs. p. 654) amount to 5231, almost six times as many as ours, and cover the whole flower season. Ours are chiefly made in August and September (a few in July at Cambridge, and *Hedera* in November). Allowing, however, for the effect of this factor, it is still evident from these figures as well as from those given previously that in the British flower-visiting insect fauna we have, as compared with Low Germany.

(1) A larger *proportion* of *Lepidoptera* (especially in the west) and *short-tongued Diptera*, especially the latter.

(2) A smaller *proportion* of *Hymenoptera*, especially the short-tongued bees and other short-lipped species (other than the Ichneumonidae and their allies).

Scott-Elliot's observations (22, 23) support these conclusions. They are rather fragmentary, as the insects are not always named or the exact number of species given, and are as yet not all published. On about 76 flowers, chiefly Ranunculaceae, Cruciferae, Caryophyllaceae, Geraniaceae, &c. (and thus mainly of the lower flower classes), about 200

visitors in a total of about 425 are short-tongued flies, a proportion even greater than in our lists.

As regards actual number of species of each group, our lists are very small as compared with Müller's. E.g. of Lepidoptera we have 26 species (against 79), of bees 22 (against 205), of Syrphidae 35 (against 89), of other flies 75 (against 164), of Coleoptera 13 (against 129). Of these species many occur in all four districts studied, others in only one or two. We have made up an index of insects, from the tables given here, which we shall be happy to lend to any one interested in the distribution of insects in Britain. Our observations are not nearly sufficient to enable us to draw any conclusions upon this subject.

Neither is it possible from these few data to make any comparison in detail with other European countries; a reference to the literature will show what has been done in this direction (see especially 4 and 18). It may be noted, however, that the composition of the flower-visiting insect fauna in Schleswig-Holstein (Knuth) and in Flanders (Macleod) is far more like that of Low Germany than like our own as here presented. The nearest resemblance is found in Norway (Lindman) [and also in New Zealand, it may be observed (Thomson, 720 a)]. The figures, &c., given in this paper afford, however, a rough test of the composition of the flower-visiting insect fauna of the lowland districts, which will serve as data for further work in this direction and for comparison with observations at alpine levels. In the second portion of this paper we hope to discuss the plants of the Grampians and their biological characters, with especial reference to those more strictly alpine or arctic species which are cut off by large areas of lowland from all other plants of the same species. We hope also to give a more general discussion of the British flora as a whole, and a comparison of its general biological characters with those of the continental flora.

ADDENDUM.

SINCE the above paper was finished, one of us (I. H. B.) has made observations upon the early spring flowers near Scarborough—from March 15 to April 11, 1895. Details cannot here be given, but the following table shows the total number of species of insects visiting each class of flower. All the open flowers (thirty-seven in number) in the district were studied. To five anemophilous plants and to three of the class A B no visitors were observed ; the other twenty-nine flowers were visited as follows :—

TABLE VIII.

Class.	No. of Flowers.	Lepidoptera.	Long-tongued Bees.	Short-tongued Bees.	Other Hymenoptera.	Long-tongued Flies.	Short-tongued Flies.	Coleoptera.	Other Insects.	Total.
Anemoph.	1	—	—	—	—	1	—	—	—	1
Po	1	—	1	—	—	1	2	—	—	4
A	6	1	2	4	4	6	41	3	7	68
AB	7	1	1	4	8	4	22	3	5	48
B	2	1	—	3	2	—	4	1	2	13
B'	6	2	3	6	4	10	28	4	4	61
H	6	1	—	2	—	1	6	3	5	18
Total	29	6	7	19	18	23	103	14	23	213
% of total		2.81	3.29	8.92	8.45	10.80	48.36	6.57	10.80	

A comparison of these numbers with those given in the other tables may be made. We may call attention to the increased proportion of short-tongued bees and flies.

In addition to those entomologists whose services have been acknowledged earlier, we desire to thank also Messrs. Edward Saunders and C. Warburton for their very kind assistance.

On the Leaf-glands of *Ipomoea paniculata*.

BY

MARY FRANCES EWART, B.Sc.,

University College, London.

—♦—

With Plate IX.

—♦—

IN fully developed leaves of *Ipomoea paniculata*, at the top of the petiole immediately below the blade of the leaf, are two small depressions, one on either side. Each of these is covered with a thin colourless fluid secreted by a gland hidden within the tissues of the leaf. If the depressed region be examined more closely with a hand-lens, a small papilla is seen projecting from the centre; at the apex of the papilla is a wide mouth, from which the secretion of the gland beneath is poured over the surrounding concave surface.

These glands, originally discovered by Mr. Walter Gardiner, F.R.S., are altogether peculiar and belong to a type but rarely encountered amongst plants. Till the appearance of Macfarlane's observations upon the pitcher-plants (to be alluded to hereafter), there was, so far as I have been able to ascertain, no description of glands of the present type in the literature of Botany. Adequate living material for an investigation into their nature and development was accessible to me in the hot-house attached to the Botanical Department of University College, and upon this the results here recorded were obtained;

[*Annals of Botany*, Vol. IX. No. XXXIV. June, 1895.]

most of them, however, have been confirmed on material from other sources.

I made use of young vigorous shoots of *Ipomoea paniculata*. The younger leaves were detached and the glandular region was cut away from the rest of the blade and petiole and put at once into absolute alcohol. The axillary buds which had been carefully left untouched on the stem were removed in succession at various stages.

Description of Gland. The under side of the leaf-blade is traversed by five prominent veins which diverge from the top of the petiole, the midrib passing up the centre of the leaf, with two smaller veins on either side. The tissue covering these smaller veins expands at their point of union on the under surface of the leaf into a projecting cushion (*c.* Fig. 1) which overhangs the glandular region. Below the cushion is the slight concavity holding the fluid secretion, and from its centre, in the plane passing midway between the two veins, rises the papilla with its crater-like mouth. The papilla has a darker colour than the rest of the leaf, owing to a purple pigment in its sub-epidermal cells; it is elongated more or less horizontally, i.e. in a direction at right angles to the long axis of the petiole (*p.* Fig. 1). The duct which traverses it is short and straight, and passes horizontally inwards (perpendicular to the surface of the petiole), to widen out in the gland below. A tangential section of the papilla presents the appearance shown in Fig. 4. Occasionally, instead of forming a long straight narrow slit (*d*), it has the appearance of a Y in transverse section. Its lining-membrane is strongly cuticularized, and the cells immediately surrounding it are marked off from the neighbouring parenchyma by their smaller size and more compact setting (Fig. 4 *p*). It is the multiplication of these smaller cells which gives rise to the papilla on the surface, i.e. to the tiny perforated cone. The cushion of tissue overhanging the gland serves to deepen the depression in which it lies, and so allows a considerable amount of secretion to accumulate there before falling.

The internal orifice of the duct widens out into the lumen

of the gland (see Fig. 5). The gland itself can be plainly seen with the naked eye if the petiole is cut through horizontally, being distinguished in a fresh leaf from the surrounding green tissue by its lighter colour and greater opacity. It has very much the form of a flask rather flattened on the side opposite the insertion of the duct. This flattened side is parallel with the vascular cylinder of the petiole, and in large glands is only separated by four or five rows of cells from the common starch-sheath of the bundles.

The inner walls of the gland are folded into deep crypts lined by secretory epithelium. This is supported on a mass of small-celled parenchyma, from which it is cut off by a basal layer of cuticularized cells which appear to wall it in (Fig. 5, *bas*¹). The roof of the gland (*r*), round the exit of the duct, is non-glandular and composed of the small-celled tissue which forms the papilla and walls of the duct; the cell-walls which border the lumen of the gland (like their continuation, the lining of the duct itself) in this region are thick and cuticularized.

The whole gland is about as long as broad, and Fig. 5, which represents a radial section through the gland, might serve equally well for one taken horizontally, except that the duct in this case would be rather wider.

In examining a number of leaves I occasionally found one in which two glands were present on one side, the other side of the petiole containing but one. In these cases there were two distinct papillae, rather smaller than the normal single one on the opposite side, sunk in a common depression (Fig. 2), and usually the ducts were flattened in somewhat different directions. The glands into which the ducts led were wholly distinct and quite normal.

Structure of the Secretory Epithelium. The secretory epithelium in an active mature gland (taken from a leaf whose blade measured 10 cm. in length) is arranged in compact bundles of narrow prismatic cells set on end, the number of cells in each bundle varying from ten to twenty (see Fig. 16). Each entire bundle is supported on a single flattened polygonal cell, the upper wall of which is slightly convex.

These basal polygonal cells fit closely one to another, and their side-walls are thickened and slightly cuticularized, staining a deep orange-brown with iodine and with chlor-zinc-iodide.

Fig. 17 represents a tangential section (parallel to the secreting surface) across a bundle of secretory cells, and Fig. 18 a similar section at a lower level, across the polygonal cells.

Immediately below each polygonal cell is another cell (Fig. 16, *bas*²), having much thinner walls of cellulose, not flattened, but nearly as deep as broad; and adjoining this deeper layer (*bas*²) is the small-celled parenchyma forming the 'packing' of the gland, which gradually merges, after two or three layers, into the large loose ground-tissue of the leaf. The walls of all the parenchymatous cells are marked by numerous large simple pits.

The cells of the secretory epithelium are partly filled with granular protoplasm, which contains large vacuoles; in the fresh leaf they have a swollen appearance (*s.e.*, Fig. 16). The nuclei are large and fairly distinct, often showing a nucleolus. The outer walls of the cells are very thin. Each bundle of secretory cells is conical, the narrow base resting on the single basal cell, while the wider free extremity fits closely with its neighbours over the rounded curves of the much-folded gland. Transverse septa occur here and there in some of the older epithelial cells, but the majority appear to be undivided.

The two basal layers of cells (*bas*¹, *bas*², Fig. 16) present a great contrast to the bundles of cells above them; they contain comparatively little protoplasm, and very large vacuoles, and a distinct nucleus. They have a clear transparent appearance, especially those of the upper row (*bas*¹), whose walls are so much cuticularized that they seemed in section to form a firm hard wall shutting off the secretory epithelium from the cells beneath. The lower cell-walls of the second, deeper row are thin and cellulose in character, and communicate by pits with the small-celled parenchyma below.

Since examining these glands of *Ipomoea*, my attention was called to Macfarlane's description of the secreting glands of

Nepenthes. In some of these, more especially the 'alluring stem- and leaf-glands,' the analogy of the general structure is very noticeable; and as the author points out, it closely resembles that of animal glands. Speaking of the alluring leaf-glands he says¹, 'when placed on the outer surface of the lid or pitcher they much resemble attractive lid-glands, with the addition that a covering flap of epidermal tissue varying in extent grows over them, or more commonly even, like certain attractive lid-glands (*N. Lowii*, *N. laevis*, *N. Pervillei*), they are so encircled and closed in by the epidermal covering that the gland becomes "perithecioid," and the sugary secretion exudes from a small circular orifice of the epidermis. On tendrils and on the under surface of the lamina the perithecioid form is characteristic, and it attains its most gigantic proportions on the tendril of *N. bicalcarata*, where, owing to rapid growth of the tendril, the gland-orifice becomes slit-like, and the gland-tissue may be one-eighth of an inch in length and one-sixteenth of an inch in width.' In the glands of the stem, 'the three layers of gland-cells all show clear finely-granular protoplasm, and a vascular diverticulum ends beneath. But in all cases the diverticulum is separated from the gland-tissue by two layers of bead-like cells, which in position and function seems to correspond to the *membrana propria* of animal glands. The similarity of this to a simple animal gland in shape, structure, excretion, and vascular supply is obvious, and need not further be dwelt on. The resemblance, however, is even more striking in the pedicel-gland of *N. bicalcarata*, . . . where a tendency to branching of the gland-tissue occurs.' Here, then, we have the two layers of clear cells which Macfarlane compares to the *membrana propria*, the vascular diverticulum just below the gland, the covering epidermal flap and perithecioid arrangement, and the branching of the gland-tissue, just as in the gland of *Ipomoea*.

Development of the Gland. In order to investigate the origin of the gland and its subsequent development, sections

¹ Observations on Pitchered Insectivorous Plants (Part II). *Annals of Botany*, Vol. vii. p. 429.

were cut from leaves of various ages. But the gland was already considerably advanced in leaves whose blade measured only 6 mm. in length; and it was found necessary to imbed the minute leaves of the axillary buds in paraffin, after staining in bulk with haematoxylin. In this way a complete series of the successive stages was obtained. I frequently found that the lowest (oldest) leaf of a bud exhibited no trace of a gland, and in cases where the bud was allowed to develop, this leaf often remained stunted, and more rounded in outline, partaking probably of the nature of a bud-scale.

In its earliest stages the gland commences as a simple invagination or pit of the epidermis. It appears at about the same level on the two sides of the base of a leaf, at the junction of the lamina with the very short petiole. The lamina of so young a leaf is only about 1 mm. long. A diagrammatic representation of a transverse section through the glandular region is given in Fig. 6, the gland itself in Fig. 7. The simple tube, which subsequently becomes the duct of the gland, dilates into a spherical cavity at its inner end, which may be traced through five or six successive sections.

In the next leaf of the bud, whose lamina had attained a length of 2.5 mm. from base to apex, the dilatation at the end of the duct had become wider, and the epidermal cells which line it were sharply marked off from those which formed the walls of the duct (see Fig. 8 *s. e.*). The epidermal cells at the mouth of the duct were also dividing and proliferating by septa parallel to the surface as well as perpendicular to it. Fig. 9 represents a longitudinal section through the other gland of the same leaf. The lumen of the gland can at this stage be traced through ten or eleven successive sections, either longitudinal or transverse.

The lamina of the third youngest leaf of the bud had attained a length of about 5 mm.; and the gland had reached a stage practically the same as that in one of the youngest leaves on the main shoot; a transverse section through the gland of the latter is shown in Fig. 10. The duct has become wider, and the epidermal cells lining it have undergone

tangential and radial divisions, especially in the region of the internal orifice. This results in a thick cuticular rim or cushion of tissue, which projects into the lumen of the gland (r). The tissue so formed by the proliferation of the epidermis can easily be distinguished from the underlying parenchymatous ground-tissue by the layer of thickened membrane which separates them, and is continuous at the mouth of the duct with that dividing the epidermis of the leaf-surface from the sub-epidermal tissue.

The inner wall of the glandular dilatation is no longer concave; the floor is raised into a rounded projection in the centre in consequence of the multiplication of the cells beneath; and the surrounding concavity is filled up from above by the projecting cushion of tissue (r) derived from the epidermis at the insertion of the duct. The epidermal cells lining the gland have also increased by radial divisions, so that the lumen, although flattened, is now wider than before and measures about $\frac{1}{2}$ mm. from side to side.

The gland has now attained its characteristic form, and in successively older leaves, whose blades measure 1.1, 1.5, 3.8, 6.0, and 8.0 cms. respectively, the main changes consist, (1) in the formation of numerous folds and pits in the walls of the gland, caused by the repeated radial divisions of the lining (secretory) epithelium and the unequal proliferation of the small-celled parenchyma below; (2) in the increased thickening of the tissue derived from the epidermal lining of the duct, giving rise to the roof of the gland, on the one hand, at the inner extremity, and on the other hand to the projecting papilla at whose apex the duct opens on the surface of the leaf; and (3) changes in the nature of the secretory epithelium itself, which will be described below. Fig. 5 represents a vertical section through a fairly advanced gland, whose walls, however, have not yet become very much folded. The lamina of the leaf from which this section was taken measured 8 cm., and the gland itself measured $\frac{3}{4}$ mm. from side to side, and $\frac{5}{8}$ mm. deep, including the duct.

In the development of the gland of *Ipomoea* we have again a

close similarity with the glands of *Nepenthes*. Macfarlane states¹ that 'in the formation of the alluring perithecioid glands of leaves, and in similarly shaped glands of some lids, an evident epidermal depression in the region of the future gland appears about the time that division in its cells is beginning. Owing partly to rapid division and growth of the marginal gland-cells, but specially to similar activity in the surrounding epidermal cells, these last rise up round the central gland-mass and cover it in until only a small circular or elliptic aperture is left in the middle of the covering-in cells.' And again, 'there is a decided tendency in many species to sinking and infolding of the gland with restriction of the exposed surface, but in *N. Pervillei* this is carried to such an extent that each gland opens by a very narrow elongated orifice.'

Development of the Secretory Epithelium. In the earliest stages of the gland (Fig. 6) the lumen is lined with ordinary merismatic epidermal cells, which, however, are crowded closely together and have conspicuous nuclei. Fig. 7 represents the left-hand gland and duct of Fig. 6 more highly magnified; and Fig. 11 a small portion of the epithelium at this stage. Its cells are full of granular protoplasm which stains darkly with haematoxylin, yellow with iodine, and brown with chlor.-zinc-iod. There are no vacuoles and the nuclei, which show distinct nucleoli, are near the basal cell-walls.

In an older gland, but before the walls have become at all folded, the cells present the appearance shown in Fig. 12. They are more elongated perpendicularly to the surface, and the protoplasm, still granular, is collected near the free walls, carrying with it the nuclei, which are now very conspicuous. The basal half of the cell is occupied by a large clear vacuole.

In the next stage (see Figs. 10 and 13) some of the cells near the centre of the gland-wall have divided tangentially by a single transverse septum. Most of the protoplasm is cut off in the upper cell. The formation of the transverse

¹ Observations on Pitchered Insectivorous Plants (Part II). Ann. Bot., Vol. vii. p. 435.

wall spreads centrifugally through the gland, and then the central cells undergo a further tangential division, a second cell being cut off from the upper one which borders the lumen. This cell usually has a large vacuole and a clear appearance, while the upper one contains very granular protoplasm and a large nucleus and nucleolus about the middle of the cell.

Finally, two or three of the surface-cells in the very centre of the gland undergo radial divisions (perpendicular to the surface), so that we now have four or five elongated cells (*s.e.*), supported on one basal polygonal cell (*bas*¹), and below this another cell (*bas*²), which has thin walls,—all these being derived from one original epidermal cell. A single section through a young gland would show all these stages, since the development does not take place simultaneously throughout. (See Fig. 13.)

The two lower cells derived from the epidermis remain clear and contain vacuoles; the lateral walls of the uppermost one (*bas*¹), adjoining the true secretory cells, become thickened and cuticularized, and the cell itself becomes one of the polygonal layers already mentioned (see Fig. 18).

In the next oldest leaf on the shoot, whose blade was 11 mm. in length, the multiplication of the surface-cells of the gland by vertical divisions had continued, and now we have as many as ten or twelve secretory cells supported on one basal polygonal cell (Fig. 14). These secretory cells are full of protoplasm, which, however, is not quite so granular in appearance as before, and the large nuclei are usually in the upper third of the cell.

The next oldest leaf (blade 15 mm. long) had a gland whose secretory epithelium exhibited the same general structure as the previous one (see Fig. 15). The secretory cells have become longer and narrower, and are crowded closely together; and it is not easy to distinguish the various groups of cells from one another. The protoplasm is not so granular, and small vacuoles are beginning to appear.

When the secretory epithelium has become fully developed it presents the appearance shown in Fig. 16. This drawing

was taken from a section of a fresh leaf which had not been in alcohol, but had been simply cut and mounted in water. The whole gland was very similar to that shown in Fig. 5. Some transverse walls had appeared at intervals in the secretory cells, but the majority of them were undivided, and very long and narrow. The nuclei, still large but not so conspicuous, occupied various positions in the cells, but for the most part were situated in the basal or middle portions.

The protoplasm had become much vacuolated, and this gave the cells a lighter, somewhat swollen, appearance. The two supporting cells below each group of secreting cells contained little protoplasm, and the lateral walls were thickened and cuticularized to a considerable extent, especially in the upper (*bas*¹). Fig. 17 represents a section taken across a group of epithelium-cells.

While cutting some of the smaller leaves, I noticed a large number of small apparently sessile glands scattered over the surface both of petiole and blade (*gl.* Fig. 6). Examination under a higher power showed that each was in reality shortly stipitate, being supported on a single cell. The epidermal cell below this stalk was slightly depressed, so that the cluster of four or five cells constituting the gland proper appeared to rest on the epidermis (Fig. 19).

In rather older leaves the glands were separated by wider intervals, and the depression of the epidermis round each gland was more marked (Fig. 20).

The secretory cells had multiplied by divisions vertical to the surface, but the stalk-cell had undergone very little alteration. The wall dividing it from the epidermal cell immediately below had become thickened and cuticularized, and now the resemblance to an early stage of a single bundle of secretory epithelial cells from the large glands already described, with its two basal cells, became obvious. Even in the youngest leaves, before there was any trace of the invagination to form the future large gland, these small surface-glands were partially formed, and consisted usually of epidermal cell (*bas*¹), stalk-cell (*bas*²), and group of two

or four secretory cells on the surface. Here and there, however, was an epidermal cell projecting, which had only undergone transverse division, and would probably have proceeded to form a gland later.

It would seem that the secretory epithelium lining the large gland of the leaf is homologous with an aggregation of these small surface-glands, the only difference being that the development of the epidermal cells which form the invagination in the earliest stages of the gland has been retarded, and that when they do become differentiated, *each* cell gives rise to a small gland; these are consequently crowded thickly together in a curved surface, and so give rise to the complicated secretory epithelium above described (compare Fig. 20 with Fig. 15). This view obtains additional support from the reactions of the glands with certain staining reagents. The secretions of the large gland and of the small superficial glands appear to be identical also.

Nature of the Secretion. In mature leaves the secretion of the glands accumulates in a large drop projecting from the depression in which the mouth of the gland lies. I was able to get a considerable quantity of it by cutting off some large leaves and putting the cut ends of the petioles in water. They were covered over with a bell-jar to prevent evaporation, and in this way I was able to remove the secretion at intervals as it was renewed. It consists of a thin, clear, transparent fluid, having a taste like dilute saccharine. After placing some on a slide with Fehling's solution and heating, an abundant reduction of the copper occurred, demonstrating the presence of a sugar. Tannin was also present in considerable quantity.

Thick sections were cut in the hope of finding some of the secretion in the duct, but the result was always disappointing because of its extreme solubility. Nor were the results afforded by the secretory cells themselves much more satisfactory. At an early stage many granules were present in the protoplasm which stained in dilute haematoxylin, were coloured brown by iodine, and were presumably proteid in

nature. But at no stage could I find starch-granules in the cells; and therefore I conclude, as sugar in some form is present in the secretion, it is, as Acton says¹, 'not formed by hydrolysis of a carbohydrate.' He compares its formation with that of cellulose from microsomata, and starch from amyloplasts in its general nature, but mentions that this is not capable of direct proof, on account of the solubility of the sugar.

Treatment with ferrous sulphate, &c., gave an abundant tannin-reaction, and with one per cent. osmic acid solution the cells became a dark blue colour. But since the cells were also darkened with osmic acid after remaining some time in ether, it would appear that the coloration is due to the presence of tannin, and not of oil. This was confirmed by negative results with alkannin. With an ammoniacal solution of Cu SO_4 the whole of the secretory cells became bright lemon-yellow, and the same result was obtained with cold Fehling's solution. On heating the slide, or dropping boiling Fehling's solution on to the sections, no alteration could be obtained in the colour; and since tannins will also reduce Cu SO_4 and Fehling's solution, I was unable to conclusively prove the presence of sugar *in the cells*. With chlor.-zinc-iod. the whole of the gland-cells became a bright yellow, the lateral walls of the polygonal cells below the secretory epithelium staining a dark orange, and the outer cell-walls of the epidermal lips of the duct also showing a marked cuticularization. The free cell-walls of the secretory epithelium were very thin, but appeared to have a yellow, not a violet reaction.

I could find no rupture of the outer cell-walls bordering the gland-cavity, and no breaking down into mucilage, and therefore conclude that the secretion is forced through the cell-wall in some way by the protoplasm of the cell itself. The parenchymatous cells surrounding the gland are furnished with very large pits in their cellulose walls, and only five

¹ On the formation of sugars in the septal glands of *Narcissus*. *Annals of Botany*, Vol. ii. No. V. 1888.

or six layers of cells in the narrowest part separate the glandular epithelium from the starch-sheath of the vascular cylinder; but no starch could be detected in the intervening cells. When the leaf shows signs of decay and begins to turn yellow, sections of the gland show that the epithelial cells undergo degenerative changes, and become filled with oil-globules. Oil is also found then in the surrounding parenchyma.

EXPLANATION OF FIGURES IN PLATE IX.

Illustrating Miss Ewart's paper on the Leaf-glands of *Ipomoea*.

Fig. 1. View of glandular region of mature leaf whose lamina measured 10 cm. from base to apex. Drawn from lower surface, right-hand side. *m*, midrib; *ε*, margin of leaf-lamina; *c*, projecting cushion of tissue; *p*, papilla; *d*, aperture of duct; *s*, petiole.

Fig. 2. Do. left-hand side, to show two papillae, *p*.

Fig. 3. Left-hand glandular region of younger leaf, whose blade measured 8 cm. from base to apex.

Fig. 4. Tangential section of papilla, near surface, from leaf whose lamina measured 1.5 cm. *d*, duct; *p*, small cells forming papilla and walls of duct, derived from epidermis; *t*, surrounding leaf-parenchyma, derived from ground-tissue.

Fig. 5. Longitudinal section of mature gland whose external surface is represented in Fig. 3.

In this and the following figures the lettering has the same significance. *d*, mouth of duct; *p*, tissue forming papilla, derived from epidermis; *s. ε*, secretory epithelium; *bas*¹, supporting cell on which the secretory epithelium rests, derived from epidermis; *bas*², second supporting cell, below *bas*¹, derived from epidermis; *t*, small-celled parenchyma, forming the 'packing' of the gland, derived from ground-tissue; *r*, roof of gland, formed by proliferation of epidermal cells lining duct; *l*, lumen of gland; *n*, nucleus.

Fig. 6. Diagrammatic transverse section of very young leaf of axillary bud, whose blade was about 1 mm. in length, through glandular region. *gl*, small surface-glands; *vb*, vascular bundles.

Fig. 7. Do. left glandular invagination more highly magnified.

Fig. 8. Transverse section through gland of older leaf of bud (blade equals 2.5 mm. long).

Fig. 9. Longitudinal section through the other gland of same leaf.

288 *Ewart.*—*On Leaf-glands of Ipomoea paniculata.*

Fig. 10. Transverse section through leaf whose lamina measured 6 mm. from base to apex.

Fig. 11. Secretory epithelium at stage represented in Fig. 6.

Fig. 12. Do. in leaf whose lamina was 5 mm. long.

Fig. 13. Same section as shown in Fig. 10, under higher power, to show various stages of development in the secretory epithelium. The cells included by the lines which meet at *x* show the line of development.

Fig. 14. Secretory epithelium at older stage, from leaf whose lamina was 11 mm. long.

Fig. 15. Do. from leaf whose lamina was 15 mm. long.

Fig. 16. Do. from fully formed gland.

Fig. 17. Tangential section across surface of glandular epithelium to show grouping of cells.

Fig. 18. Do. at lower level, to show the lateral walls of the supporting cells, *bar*¹.

Fig. 19. Transverse section of very young leaf to show early stage of small surface-gland (*gl*, in Fig. 6).

Fig. 20. Do. from mature leaf.

On the Development of the Cystocarp in Rhodomelaceae.

BY

REGINALD W. PHILLIPS, M.A., B.Sc.,

Professor of Botany in the University College of North Wales, Bangor.

—♦—
With Plate X.
—♦—

THE Rhodomelaceae constitute one of the most natural of all the families of the Red Seaweeds. They are characterized among other things by the globular, oval, or urceolate fructification, opening by a terminal pore, and usually standing out from the thallus, a condition which is familiar to us in the 'ceramidium' of the genus *Polysiphonia*. Agardh, surveying the group once more in his recent *Analecta Algologica* (1), says:—'Those characters which long ago (2) seemed to me to belong to this group: the polysiphonous thallus, the form and structure of the cystocarp, the nucleus consisting of sporiferous free threads, giving rise to pyriform spores in their terminal clavate joints, and finally sphaerospores evolved in the pericentral cells, and arranged in a fixed order; these seem to me to-day to mark out a family distinct from all others.' And although Schmitz has shown (3) that the mode of development of the cystocarp should be an important consideration in the taxonomy of the Florideae, it

[*Annals of Botany*, Vol. IX. No. XXXIV. June, 1895.]

is probable that the Rhodomelaceae will be less disturbed by the introduction of this new criterion than almost any other family. So far, the most important rearrangements proposed by Schmitz and Falkenberg (4) consist in the transference of four of Agardh's list of thirty-nine genera to the Delesseriaceae; and the removal from Agardh's Chondrieae into the Rhodomelaceae, of *Laurencia* and certain later allied genera. The limits of the family are thus not seriously changed, and it remains one of the largest and best-defined of all the Floridean groups.

Our knowledge of the minute structure of the cystocarp in the Rhodomelaceae, as in the rest of the Florideae, received a new impulse upon the publication, in 1883, of Schmitz's researches upon the process of fertilization. For the first time the study of the development of the cystocarp in detail, brought up our knowledge of the morphology of the female reproductive organ of the Florideae, to the level which it had long before reached in other groups of plants. The discoveries of Schmitz are a worthy continuation of those of Bornet and Thuret, and Janczewski. As a result of his investigations, Schmitz conceived the luminous idea that the thallus of all Florideae (in the narrower sense in which he uses the term, i. e. excluding the Bangiaceae) consists of branched filaments; that these filaments grow by means of an apical cell; and that no segment is subsequently divided by a transverse septum, or by a longitudinal septum which passes through the organic axis. Though this theory has since been found by Johnson (5) and by Schmitz himself (6) not to hold good for the Nitophylleae, a single tribe of the Delesseriaceae, it is probably of very general application in the Florideae, and certainly throughout all the Rhodomelaceae. It was when this theory was applied to the study of the developing cystocarp of this family, and the cell-connexions traced by means of the characteristic Floridean pit, that a clue was first obtained to its inner structure.

My own attention was directed to the study of this organ by the account given by the author of aberrations presented

by *Chondria tenuissima*, Ag., in the process of the maturation of the cystocarp. This plant differed in some important details from the other members of the family which he had examined, and Schmitz entertained a belief that similar departures would be found elsewhere. I therefore examined such suitable material as I could collect, and have now investigated the earlier stages of the cystocarp in several species of the genera *Rhodomela* and *Polysiphonia*, four of them with some detail. As might have been expected perhaps from the narrow limits covered by the species, no considerable variation of structure has been observed; it is rather the uniformity which is the more remarkable. Some of the results which have been obtained, it may, however, be of interest to publish, more especially as the monograph on the Florideae upon which Schmitz, in collaboration with Falkenberg for the Rhodomelaceae, has long been engaged, is not likely to appear for some time yet.

The account of the formation of the cystocarp in Rhodomelaceae in the paper already referred to, is necessarily somewhat meagre, as the communication was avowedly of a preliminary nature, and covered the whole of the Florideae. A supplementary description (7) has since appeared, adding the result of later investigation. The earlier account is accompanied by only one figure illustrating the group under consideration. Excellent figures of *Chondria tenuissima* have been given by Janczewski (8) and again by Bornet and Thuret in the *Études phycologiques* (9); but in both works the description fails at the point which Schmitz has since made so interesting. The figures of *Polysiphonia variegata*, Zanard., in Schenck's *Handbuch* (10) would now have to be revised by Falkenberg in the light of the researches of his colleague. The description given by Van Tieghem in the latest edition of the *Traité de Botanique* (11) of the structure of the cystocarp in *Polysiphonia* errs in the same particulars as do Falkenberg's description and figures, which is the more remarkable as this author has embodied in the same work the classification which Schmitz founds upon his researches.

No other writers, as far as I am aware, describe the structure in detail. As *Polysiphonia* is the genus oftenest selected for examination as a convenient type of the Florideae, it is an additional reason for submitting a more detailed description of the procarps than has yet appeared.

Rhodomela subfusca (Woodw.), Ag.

Figs. 1, 2, 3, 4.

This Alga is recorded in Holmes and Batter's list (12) as occurring in all the fourteen districts into which they mark out the British coast. The specimens which I have examined were collected on the south coast of Anglesey, where the plant presents a peculiarity of habit to which Harvey makes no reference, but which reminds one of the description given by Kjellman (13) for his new species *Rhodomela virgata*. It is a perennial plant, but is severely cut down in the autumn to a few of its main axes, chiefly I believe owing to the depredations of molluscs which seem to find its finer ramifications an agreeable food. Early in the spring plants thus reduced bud out irregularly a large number of new branches, reminding one of the behaviour of a polled or, rather, a severely-pruned willow or lime. These branches invariably bear in their earlier stages reproductive organs, and I have collected specimens with cystocarps, antheridia, and tetraspores respectively. The branches bearing cystocarps are minute corymbose tufts, densely covered with procarps in all stages of development. While yet the branch is hardly a millimetre in length and breadth, the lower cystocarps are apparently mature, containing a few well-developed carpospores. Most of these procarps, as may be thought, do not become fertilized, and the procarpal branches then proliferate into vegetative shoots of the ordinary pattern. Larger branches bearing cystocarps, as figured by Harvey, I have not yet collected. These small branches afford excellent material for the study of the development of the cystocarp, and it is from an examination of them that the following description was obtained.

The branch destined to bear the cystocarp consists of from eight to twelve joints. The first becomes the stalk of the cystocarp. The second is the reproductive joint proper, giving rise to the greater part of the pericarp, and the whole of its contents. The third is included in the cystocarp with the products of the second joint, but has no further history. All the remaining cells of the filament wither off when fertilization has taken place, leaving eventually no mark of their presence.

The first joint forming the stalk cuts off from the central cell five pericentral cells. Other cells are derived later from these, giving rise to a cortex, similar to that which characterizes the vegetative parts. Some cells of this number contribute to form the inferior part of the pericarp.

The second joint is that from which springs the carpogonial branch. Five pericentral cells are here also cut off from a central cell. The last formed is ventral, i. e. in the median position above. The two pericentral cells on the dorsal side divide but slightly. The two cells right and left of these divide rapidly (Fig. 10), forming two plates of cells protruding ventrally so as to enclose as a rudimentary pericarp the fifth pericentral cell. The two lateral convex plates thus arising and leaving a median gap above and below have been compared to the paired valves of a bi-valve shell-fish. Later on this two-sidedness disappears, the wall becoming globular by the filling up of the median gaps. The fifth pericentral cell, enclosed as thus described, gives rise to the carpogonial branch. It forms, moreover, two other branches, a one-celled branch in the median position below, and another two-celled branch directed laterally upward. The carpogonial filament is lateral also, facing the second of the two branches referred to above. It consists of four cells and is directed upward. The end cell is the carpogonium and is prolonged into a trichogyne which passes out medianly above in the gap of the pericarp, which is as yet bi-valve (Fig. 1). The carpogonial branch is curved into a crescent in a plane which is not quite median, but the long trichogyne usually lies parallel to

the terminal filament (Figs. 2, 3, 5, 7). The curvature of the carpogonial branch is such that, as has been described by Schmitz, the carpogonium itself lies medianly above and close to the pericentral cell, from which the carpogonial branch arose. This pericentral cell was first regarded by Schmitz as the auxiliary cell, but he now regards a later derivative of it, which had previously escaped his notice, as the true auxiliary cell (7). There is, however, some reason for adhering to his first statement, and I will return to this point again, describing the pericentral cell as the auxiliary for the present. The carpogonial branch does not occupy a definite position in the young cystocarp right or left of the two-celled lateral branch, from which it may be inferred, I think, that this lateral branch is the morphological equivalent of the carpogonial branch.

The derivatives of the pericentral (auxiliary) cell at this stage consist therefore of the following:—

- (a) A four-celled carpogonial branch, ending in the carpogonium with its trichogyne;
- (b) A two-celled sterile lateral branch facing it;
- (c) A one-celled sterile inferior branch.

In the majority of the numerous procarps which are crowded on the tufted branches of this plant, no fertilization takes place. The procarps do not, however, thereupon atrophy and disappear, but, as before stated, are gradually metamorphosed into vegetative shoots. The plant thus offers a convenient opportunity of sharply distinguishing between the condition of the procarp before fertilization and the developments which are consequent upon fertilization. With regard to the proliferation itself, it is not clear how it is effected, what cell for example of the former procarp becomes the leading-cell of the branch. Two points are clear, however. First, that no cell of the axial row becomes the apical cell, so that the proliferated branch is a sympodium; secondly, that all the cells of the former procarp become active, living, cells of the branch, excepting only the four cells of the carpogonial branch. The carpogonium itself on the failure of fertilization becomes ill-

defined and cannot be traced ; but the three other cells of the branch remain imbedded among the cortical cells of the new branch as a row of diminutive cells,—dead and deeply stained with their own colouring matter. I have seen one instance of a similar proliferated appendage with an atrophied carpogonial branch in *Chondria tenuissima*.

When fertilization, however, occurs, immediate changes ensue in the procarpial structures. Cases where the spermatorium is still adhering to the trichogyne may be observed commonly ; but I was unable by the closest observation to discover the conjugation-process or ooblastema, by which the carpogonium and the auxiliary cell are put into communication with each other. One cannot, however, doubt but that, as Schmitz affirms, such a fusion of the contents of the carpogonium with those of an auxiliary cell, whether the pericentral cell or a derivative, does take place. The comparative study of other Floridean groups, and the subsequent history of the procarpial cells, combine to render the fact almost certain. In the absence of direct ocular proof of the phenomenon in this group Schmitz is led to wonder whether the process may not be one of fertilization rather than conjugation, i. e. one in which there is a transference of nuclear matter through fine pores, rather than an emptying of the whole or greater part of the contents through a relatively large pit. It is certain that the carpogonium remains distinguishable even after the formation of spores, which seems to tell in favour of a process of fertilization properly so called. It has occurred to me that the actual fusion may take place in the night, as is well known to be the case with some of the Green Algae. The fact remains that, up to the present, no trace of the ooblastema-thread from the fertilized carpogonium has been observed. In *Rhodomela subfusca*, the consequences of fertilization are three-fold, First, the auxiliary cell itself shuts off a large cell from its upper part, just the region, it may be noted, with which conjugation must have been effected. At first it might seem that the auxiliary cell had divided into two almost equal parts. Close examination, however, shows that all four pit-connexions,

which belong to the auxiliary cell, that with the central cell, and those with all three of its branches, remain with the inferior cell. The auxiliary cell has in fact given rise to a new branch consisting of one cell, and it is this derived cell which Schmitz in his later account considers the true auxiliary cell. From it the sporogenous filaments—meta-ooblastemata as Schmitz has called them—arise. These meta-ooblastemata branch freely in a sub-dichotomous fashion, and form the close-set mass of filaments known formerly as the 'nucleus,' the terminal cells of which ultimately discharge the densely-coloured pyriform carpospores.

The effect of the formation of the 'nucleus' upon the cells of the carogonial branch is to detach them from their pit-connexion with the auxiliary cell, and to push them outward towards the pore, where, thus shunted, they may still be detected at a late stage as a row of shrunken cells (Figs. 4, 6, 14).

The second effect of fertilization is that upon the two sterile branches. The inferior one-celled branch adds a new cell, while each of the two cells of the two-celled branch buds off a new cell; so that the sterile products of the auxiliary cell now number six cells. Beyond this the development does not go; but as the cystocarp becomes filled with carpospores it becomes difficult to trace the changes in the sterile tissue. The six sterile cells may still be seen at a late stage of spore-formation (Fig. 4).

A third effect of fertilization is the branching of the central cell itself laterally, into two cells which branch again and again, forming at length about twelve filaments which line the whole cavity of the cystocarp extending as far as the pore (Fig. 9). The wall of the cystocarp is properly only one cell thick, but the existence of this layer gives it the appearance of being two cells thick. The cells of the lining do not, however, form a pseudo-parenchyma as do those of the pericarp, but retain their filamentous character to the end, separated laterally by a wide interval, circumstances which render them easy of identification. These cells are no doubt the *paranemata* of

Agardh (14) (Figs. 8, 9), which he states he observed in *Polysiphonia violacea* and other species of *Polysiphonia*, and also in *Vidalia*. They may be observed to become more and more attenuated and inconspicuous with the maturation of the carpospores, and it has occurred to me that a possible function is the supply of the plentiful mucilage which is found in the cystocarp when mature and which carries out the ripe spores with it as it escapes through the pore. That they play the rôle of a tapetum, and contribute to the nutrition of the spores, is hardly probable. Whatever the function of these paranemata, it is clear that they do not arise from the auxiliary cell, but from the subjacent central cell itself. They cannot therefore be regarded as sterile elements of the 'nucleus'; they have an origin quite distinct.

Polysiphonia nigrescens, Grev.

Figs. 7, 8, 10, 11, 12.

This species is common everywhere on the British coast. It belongs to that subdivision of the genus which Holmes and Batters describe as 'Polysiphoniae ecorticatae.' The apical region is in spring densely clothed with leaves, as the monosiphonous, freely-branched, hairlike appendages have been called, and it is modifications of these that bear antheridia and procarps. While it would be out of place here to discuss the external morphology of the Rhodomelaceae, it may be pointed out that Nägeli and later writers have distinguished between two kinds of appendages in Florideae, leaves and branches; and Kny (15) has further discovered that, in some cases, in *Chondria tenuissima* for example, the same relationship exists between these appendages as exists in the higher plants. In *Rhodomela subfusca* these leaf-like appendages do occur, though not on the tufted procarp-bearing branches which I have described, where the procarps proliferate into ordinary branches, and would thus seem to be their morphological

equivalents. In *Polysiphonia nigrescens* the antheridia and procarps are modified leaves branching beyond the fertile region in the same manner as the ordinary leaves branch.

The formation of the cystocarp corresponds in every essential particular to that already described for *Rhodomela subfusca*. The cell-divisions constituting the pericarp may be followed with greater ease in this species than in *Rhodomela subfusca*. Speaking generally, it may be said that the ecorticated species of Rhodomelaceae have a more simply-formed pericarp than have the corticated species. The origin of the paranemata in a pair of cells derived laterally from the central cell may be clearly traced; though I believe I have seen that, in the median line below, a row of paranematal cells is derived from a pericentral cell of the first joint, forming the stalk of the cystocarp. The subdivision of the auxiliary cell after fertilization into a superior sporogenous and an inferior sterile cell, I have only been able to see rarely. The difficulty arises from the fact that a much larger number of carpospores is formed in this species than in *Rhodomela subfusca*. This dense 'nucleus' consisting of from ten to twenty times as many spores as occur in *Rhodomela*, obscures the changes taking place at the core of the fructification. The greater drain upon the resources of the sporogenous cell due to the formation of a large number of carpospores, probably accounts for a phenomenon which distinguishes this species from the other. I refer to the apparent retrogressive absorption by the sporogenous cell of the auxiliary cell and later, of all its sterile derivatives, leaving in its place a large multipolar, multinucleate sporogenous mass, which may be occasionally squeezed out from nearly ripe cystocarps, and two of which I figure (Figs. 11, 12). I have never been able to see such absorption in *Rhodomela subfusca*, and it is certain that in that species the auxiliary cell and all its sterile derivatives remain at a relatively late period of spore-formation. In *Polysiphonia nigrescens*, on the other hand, I have failed to trace the sterile elements when once spore-formation has well set in.

Polysiphonia fastigiata (Roth), Grev.

Fig. 9.

This species is readily identified as a common epiphyte on *Ascophyllum nodosum*, Le Jol., and is probably on this account usually selected for description as a type of the Florideae. It comes very near *P. nigrescens* by general consent, but differs from that species in the total absence of leaves. The development of the cystocarp is closely comparable with that of *P. nigrescens*, but is somewhat more difficult to follow on account of the greater compactness of the procarp. When the sporogenous cell has been segmented off, the first sporiferous filament consisting of two cells appears in line with the sporogenous and the auxiliary cells, presenting the appearance of three equivalent sporogenous cells. The whole contents of the procarp may readily be squeezed out by gentle pressure in this species, and as the cells are held together by the pit-connexions, it is possible to make out the relationship, though the disturbance makes it occasionally puzzling. It is the pit-connexion with the central cell which gives way on this treatment. When from a fertilized procarp more than eight cells are thus squeezed out, in addition to the remains of the carpogonial branch, it is due I believe to the inclusion of rudimentary sporiferous filaments.

I have been unable to trace the sterile cells in maturer cystocarps. They probably undergo absorption by the sporogenous cells during the spore-formation.

The paranemata are very clear and may be noticed even after the discharge of the spores.

During the enlargement of the cystocarp, the parietal cells bud to form an imperfect cortex, closely encased in the old cuticle, but the pericarp cannot be said to be two cells thick continuously.

Polysiphonia violacea (Roth), Grev.

Figs. 5, 6.

P. violacea differs from those already described in the possession of four siphons, the smallest number known in the genus. The siphons of *P. fastigiata* reach as many as twenty in parts, and those of *P. nigrescens* a larger number still, but both are free from the so-called cortex of *Rhodomela subfusca*. Rosenvinge (16) in his paper on the morphology of the genus regards *P. nigrescens*, *fastigiata*, and *violacea* as types of as many groups within the genus, and to these species he largely devotes his attention. It is therefore interesting to find that in all essential respects the structure of the cystocarp in *Polysiphonia violacea* is cell for cell comparable with that of the three species already enumerated.

The only point of difference arises when the history of the sporogenous derivative of the auxiliary cell is traced subsequent to spore-formation. Under *P. nigrescens* it has been stated that the sporogenous cell seems to absorb the cell from which it sprang, and even the sterile derivatives of that cell. In *P. violacea* the process of fusion goes even farther, to the inclusion, that is to say, of the central cell itself. Here again I cannot say whether the cells of the sterile branches, more especially the peripheral cells, are absorbed or atrophy; they cannot, however, be traced in the maturer cystocarps, where a large multinucleate mass confluent with the central cell may be observed. There can be no doubt, however, that the earlier carpospores are derived directly from the sporogenous derivative of the auxiliary cell, and we may fairly infer that when fusion with other cells occurs later, it is daughter-nuclei of this cell, or perhaps daughter-nuclei of the auxiliary cell, which furnish the nuclei of the carpospores.

Conclusions.

It is clear from what has been said that the four species examined present a remarkable uniformity in the structure of the procarp at the moment of fertilization ; the fifth and last-formed pericentral cell facing the axis giving rise to three branches :—

- (a) A four-celled lateral carpogonial branch ;
- (b) A two-celled lateral sterile branch ;
- (c) A one-celled inferior sterile branch.

After fertilization there is also complete correspondence up to the formation of carpospores :—

- (a) The carpogonial branch is shunted off and withers.
- (b) The two-celled lateral sterile branch branches again and becomes four-celled.
- (c) The one-celled inferior branch adds a cell.
- (d) The fifth pericentral cell, now the auxiliary cell, shuts off a superior sporogenous cell.
- (e) The central cell gives off laterally two cells from which numerous (about twelve) paranematal filaments are derived, converging to the pore, and forming an imperfect lining.

The divergences come in when spore-formation has proceeded to some length :—

- (a) In *Rhodomela subfusca* no absorption of neighbouring cells by the sporogenous cell takes place at a late period in the formation of spores, if at all.
- (b) In *Polysiphonia nigrescens* and *P. fastigiata* such absorption does take place, extending to the auxiliary cell and the sterile branches.
- (c) In *P. violacea* the absorption extends to the central cell.

The paranematal layer is probably constant in Rhodomelaceae. I have seen it in *Polysiphonia sertularioides*, *P. byssoides*, *P. urceolata*, and *Chondria tenuissima*, in addition to the species mentioned above.

To revert now to the comparison of these species with

the somewhat aberrant condition described by Schmitz for *Chondria tenuissima*. Here also it would seem that two sterile branches are formed in the procarp, but in this case they are 'luxuriantly ramified.' After fertilization, conjugation takes place between the auxiliary cell and the nearest cells of these branches, leaving numerous peripheral filaments unabsorbed, and this takes place before spore-formation begins. Finally, from the multinucleate mass resulting from conjugation a superior portion is segmented off, and from this the spore-bearing filaments arise.

The most important difference is clearly the wholesale conjugation before spore-formation, and the subsequent differentiation of a sporogenous portion from the resulting mass.

The absorption which takes place in *Polysiphonia*, I am inclined to regard as of little value for taxonomic purposes. It is a physiological process, varying probably with the varying demands made upon the sporogenous cell during spore-formation, a process analogous to the absorption occurring in certain of the higher plants when cells of the suspensor prey upon surrounding tissue for the nutrition of the embryo (11). Such departures are clearly only valuable for classificatory purpose within narrow limits. A conjugation preliminary to spore-formation indicates, however, greater morphological fixity, and must be differently regarded. No one of the species here described can therefore be appropriately compared with *Chondria tenuissima* in the more characteristic features of the development of the cystocarp.

With regard to the opinion which I have already expressed, that the pericentral cell is to be regarded as the auxiliary cell, rather than its derivative formed subsequently to fertilization which I have called the sporogenous cell, it is clear that the matter cannot be determined until the conjugation of the carpogonium with an auxiliary cell has been observed. Schmitz's success in observing the corresponding process in Ceramiaceae leads one to expect that this may soon be done. Should conjugation be found to take place with the pericentral cell, before the sporogenous cell is shut off, then the

pericentral cell is the auxiliary cell ; if with the sporogenous cell, after it has been cut off, then that cell is the auxiliary cell, as is contended by Schmitz. In default of this evidence there is, however, this difficulty in regarding the derivative cell as the auxiliary cell, that it is not cut off when fertilization does not take place ; and if it be separated in consequence of fertilization, but before conjugation with the carpogonium, it is necessary to assume the transference of the effect of fertilization in some indirect manner, which, while it is not inconceivable, is still an unnecessary assumption, in this case. For division of the auxiliary cell into a sporogenous portion and a sterile portion is found by Schmitz to take place in *Callithamnion*, and the same statement is made for the carpogonium itself in *Nemalion multifidum*.

Method.

The method which I have found most convenient for observations on procarps is that which has been recommended by several others, viz. prolonged treatment with strong glycerine after staining, preferably with Hoffmann's blue. No stain is required in many cases. This treatment causes the transparent cell-wall to swell greatly, and the interior of the procarp is observed through the gaps between the opaque cell-contents. While this method does not involve any change in the relative positions of cells, it must be remembered that all the figures accompanying this paper are drawn by means of the camera lucida from preparations in which the cells are much farther apart than they are in nature. The outlines of the cells are the limits of the opaque contents. The pit-connexions characteristic of the Florideae are an invaluable indication of the genetic relationship of the cells.

Bibliography.

1. *Analecta algologica*; J. G. Agardh. Lundae, 1892, p. 129.
2. *Species, genera, et ordines algarum*; J. G. Agardh. Lundae, 1848-76.
3. *Untersuchungen über die Befruchtung der Florideen*; Fr. Schmitz, Sitzungsber. der Berliner Akad. der Wissensch. Berlin, 1883. English translation, W. S. Dallas; *Annals and Magazine of Natural History*, 1884.
4. *Systematische Übersicht der bisher bekannten Gattungen der Florideen*; Fr. Schmitz, *Flora*, Heft 5, 1889. Marburg, 1889.
5. *Callosities on Nitophyllum versicolor*; Johnson, *Proc. of R. Dublin Soc. N. S.*, Vol. vii. p. 155.
6. *Kleinere Beiträge zur Kenntniss der Florideen, I*; Schmitz, *La Nuova Notarisia. Series III*, 1892, p. 111; *Series IV*, 1893, p. 226.
7. *Ibid.*, *Series III*, 1892, p. 117.
8. *Notes sur le Développement du Cystocarpe dans les Floridées*; Ed. de Janczewski, *Mém. de la Soc. Nat. de Cherbourg*, 1876.
9. *Études phycologiques*; Bornet et Thuret. Paris, 1878.
10. *Algen im weitesten Sinne*; P. Falkenberg in *Schenck's Handbuch*. Breslau, 1891, p. 192.
11. *Traité de Botanique*; Ph. Van Tieghem. Paris, 1891, p. 1321, p. 912.
12. *A revised list of British Marine Algae*; E. M. Holmes and E. A. L. Batters. *Annals of Botany*, Vol. V, p. 93, 1890.
13. *The Algae of the Arctic Sea*; F. R. Kjellman. Stockholm, 1883, p. 110, Pl. 7.
14. *Florideernes Morphologi*; J. G. Agardh. Stockholm, 1879, p. 150. *Morphologia Floridearum*; J. G. Agardh. Lundae, 1880, p. 273.
15. *Üler Axillarknospen bei Florideen*; Kny, *Festschr. Ges. Naturforsch. Freunde zu Berlin*. Berlin, 1893.
16. *Bidrag til Polysiphonia's Morphologi*; Rosenvinge, *Bot. Tidsskrift*, Copenhagen, 1884.

Postscript.—This paper had already left my hands before the sad news of Professor Schmitz's death at Greifswald reached me. It is difficult to exaggerate the loss which algological science has sustained by the death of so able and untiring an investigator.

EXPLANATION OF FIGURES IN PLATE X.

Illustrating Professor Phillips' paper on the Development of the
Cystocarp in Rhodomelaceae.

- Figs. 1, 2, 3, 4. *Rhodomela subfusca*, fresh material.
Figs. 5, 6. *Polysiphonia violacea*, alcohol and glycerine.
Figs. 7, 8, 10, 11, 12. *Polysiphonia nigrescens*, alcohol and glycerine.
Fig. 9. *Polysiphonia fastigiata*, alcohol and glycerine.

Abbreviations: *aux. c.* auxiliary cell; *c. c.* central cell; *cp. br.* carpogonial branch; *carp.* carposonium; *cp. sp.* carpospore; *conj. m.* mass resulting from conjugation; *in. st. br.* inferior sterile branch; *l. st. br.* lateral sterile branch; *pc. c.* pericentral cell; *pcp.* pericarp; *pn.* paranema; *st. br.* sterile branches; *tr.* trichogyne.

- Fig. 1. $\times 800$. Surface view of unfertilized procarp, showing the bivalve character.
Fig. 2. $\times 800$. Median view of unfertilized procarp, showing the carpogonial branch shaded black, and the sterile branches shaded red.
Fig. 3. $\times 1200$. Median view of contents of procarp, just after fertilization. The sterile branches have developed and the auxiliary cell divided. No spores are yet formed.
Fig. 4. $\times 600$. The cystocarp after spore-formation. The spores are seen to radiate from the sporogenous cell. The sterile branches are intact. The carpogonial branch, from which the carposonium has disappeared, is shunted near the pore.
Fig. 5. $\times 800$. Median view of unfertilized procarp from behind. The lateral position of the carpogonial branch is seen, with a sterile branch facing it. The trichogyne is bent where it leaves the procarp.
Fig. 6. $\times 800$. Contents of procarp somewhat later than Fig. 3. Spores are seen arising from the sporogenous cell.
Fig. 7. $\times 800$. Median view of procarp just after fertilization, showing origin of the paranemata.
Fig. 8. $\times 400$. Median view of a nearly mature cystocarp, showing development of paranemata.
Fig. 9. $\times 800$. Lateral view of the product of one of the two cells giving rise to the paranemata (dotted). The auxiliary cell, sporogenous cell, and carpogonial branch are shown. The sterile branches and spores are omitted.
Fig. 10. $\times 800$. Surface view of procarp, showing the origin of one of the valves of the pericarp in a single pericentral cell.
Figs. 11 and 12. Masses squeezed out from nearly mature cystocarps, showing pit-connexions with sporiferous filaments.
Figs. 13 and 14. Diagrammatic representations of the contents of a procarp before and after fertilization respectively.

On some New British Marine Algae.

BY

E. A. L. BATTERS, B.A., LL.B., F.L.S.

—•—

With Plate XI.

—•—

DURING the last few months a large number of species have been added to the Marine Flora of Britain, and I propose in the present paper to give descriptions of such of them as have either never been previously described or have only been described in my preliminary note on a previous page of this volume¹.

Buffhamia speciosa, Batt. l. c.

I found this species, which I have named after Mr. T. H. Buffham who has done so much to increase our knowledge of the reproductive organs of the Florideae, at Weymouth in 1892. In September of that year I gathered a considerable quantity of *Castagnea Griffithsiana*, J. Ag., in the hope of finding plurilocular sporangia, which up to the present time have not been found on that species, the systematic position of which must in consequence remain doubtful. Although I did not succeed in finding the gametangia of the *Castagnea*, my labour was not thrown away, as most of the specimens I then gathered were more or less covered with epiphytic

¹ Annals of Botany, Vol. ix, p. 168, 1895.

[Annals of Botany, Vol. IX. No. XXXIV. June, 1895.]

Algae, amongst which *Microcoryne ocellata*, Strömf.—an Alga up to that time known only from a single Norwegian locality, and, I believe, only once found there by the late Dr. Strömfelt, the founder of the genus—and *Buffhamia speciosa* are especially worthy of mention. I found these two species frequently growing side by side on the same branch of *Castagnea Griffithsiana*, and I think it worth noticing that, whilst in the host-plant the asexual unilocular sporangia are the only reproductive organs known, in both the epiphytes plurilocular sporangia are alone found. In substance and colour, and more or less in structure, the fertile fronds of *Buffhamia* resemble the simple branches of the host-plant, and at first I thought I had really found the long-looked-for gametangia of *Castagnea Griffithsiana*; but a closer examination at once undeceived me, the junction between host and epiphyte being clearly marked, to say nothing of the entirely different development of the two plants. I may here mention that, whilst I have seen *Microcoryne ocellata* on a variety of other hosts, e.g. *Chorda Filum*, the original host-plant on which Dr. Strömfelt found it, *Rhodymenia palmata*, *Zostera marina*, &c., I have up to the present found *Buffhamia* only on *Castagnea Griffithsiana*, although I have carefully searched for it on the other plants which usually accompany that species.

Buffhamia speciosa occurs either in single isolated specimens or, much more frequently, in groups of from one or two to fifty or a hundred individuals, the epiphyte often covering a branch of the host-plant for the distance of an inch or more with a thick fringe of its tiny fronds. The olive-brown cylindrical fronds are always perfectly simple, and taper more or less to both base and apex. They vary in length from a quarter to an inch and a half in length, and are generally about 1 mm. in breadth. As has been already said, when mature and fertile they resemble the branches of the host-plant in some respects, though when young the fronds in no way resemble a *Castagnea*, but are much more like sterile specimens of *Asperococcus* or *Scytosiphon* in general appear-

ance. At first the young frond consists of a single row of cells which, by transverse and longitudinal division, very soon forms a solid axis of large, hyaline, more or less angular roundish cells surrounded by a cortical layer of much smaller cells furnished with numerous small disc-shaped chromatophores. When the fronds have reached a few lines in length, the cortical filaments first make their appearance, commencing at the apex of the frond and gradually spreading downwards till the entire frond, with the exception of the basal portion, is covered. The base of the frond always remains slender, often consisting of a single row of cells, and is thickly covered with descending rhizoidal filaments, which, creeping between the cortical filaments of the host-plant, securely anchor the epiphyte in position. Hyaline hairs of the usual type are plentifully scattered between the cortical filaments. The slender assimilatory filaments are either simple or forked and are slightly clavate; they generally consist of from three to seven cells about 9μ in diameter. The cells vary in length from $10-18\mu$, the longer being mixed with the shorter ones without any apparent regard to position, the terminal cell being either longer than the rest or slightly shorter than those immediately below it.

Plurilocular sporangia are borne among the cortical filaments, and are either linear-oblong or spindle-shaped, obtuse or pointed, and always more or less evidently stalked; sporangia consisting of a single row of superimposed cells are frequently met with. In length the sporangia vary from $50-75\mu$ or even longer; the diameter is usually about 15μ . In some specimens the sporangia are as long as the cortical filaments, whilst in others they are rather shorter.

Growth is basal. Very young specimens usually terminate in one or two hyaline hairs.

Relying on the structure of the mature frond, I have, in the note above referred to, placed *Buffhamia* in the Chordariaceae: but, taking the development into consideration, I should probably have done better had I made it the type of a new family, Buffhamiaceae.

In typical members of the Chordariaceae, e.g. *Castagnea virescens*, *C. Zosteræ*, *Microcoryne ocellata* (and according to Farlow, *Chordaria divaricata*), the frond at first appears as a roundish spot, composed of a single layer of cells, from which a tuft of vertical filaments, ending in hairs, arises. These vertical filaments generally produce clusters of moniliform coloured filaments only on one side—that most distant from the centre of the tuft—while on the side turned to the centre of the tuft, at a later period, rhizoidal filaments are formed which bind the separate individual filaments of which the tuft is composed into a compound frond. The frond of such a plant as *Castagnea virescens* is therefore a collection of originally independent filaments which have become twisted together and partially united by means of the rhizoidal filaments, the second groups of moniliform filaments forming what appears to be a distinct cortical layer. In *Buffhamia*, on the other hand, the frond is not in any sense of the word compound. As has been shown, the young frond consists of a few superimposed cells, ending in a hair; by transverse and longitudinal division a solid axis is formed, surrounded by a layer of smaller cells, from which, at a later period, the cortical filaments arise. It will, therefore, be seen that although *Buffhamia* in its mature state closely resembles the members of the Chordariaceae, in its earlier stages it shows a closer relationship with Asperococcaceae, or, through *Myriotrichia densa*, with the Myriotrichaceae. It appears, therefore, best to regard it as the type of a distinct family, which may be thus characterized.

BUFFHAMIACEAE, Nov. Fam.

Fronds cylindrical, simple, more or less gelatinous, with an axis of large colourless cells surrounded by smaller coloured cells, from which arise colourless hairs, and, at maturity, numerous short, simple or forked, jointed assimilatory filaments (paraphyses), densely covering the whole surface of the frond, with the exception of the basal portion; plurilocular sporangia linear-oblong or spindle-shaped, borne between the

assimilatory filaments: chromatophores numerous, small, disc-shaped: growth basal.

Buffhamia, Batt. Characters of the family.

Buffhamia speciosa, Batt. Fronds olive-brown, solitary or gregarious, attached to the host-plant by rhizoidal filaments, more or less gelatinous and lubricous, from a quarter to one and a quarter inch long, and about 1 mm. in diameter, filiform, tapering to both base and apex, solid; assimilatory filaments (paraphyses) few-celled, cylindrical or slightly club-shaped; plurilocular sporangia linear-oblong or spindle-shaped, stalked, as long as or rather shorter than the assimilatory filaments, frequently composed of a single row of cells.

Epiphytic on the fronds of *Castagnea Griffithsiana* near low-water mark; Weymouth. Fructification in Autumn.

Myriotrichia densa, Batt. l. c.

This species appears to be widely distributed along the coasts of Britain, for I have found it at Lamlash and Cumbrae in the North and Weymouth and Swanage in the South, and I believe it to be not uncommon, at any rate in certain seasons, all along the South coast.

In general appearance *Myriotrichia densa* more resembles *Litosiphon pusillus* than *M. clavaeformis*, Harv., and I have no doubt that it has often been mistaken for that species. The mature fronds are cylindrical in outline, and are of almost the same diameter from base to apex, with the exception of a very small space near the base which is usually bare of branches.

As in the other species of *Myriotrichia*, the fronds are at first composed of a single row of cells which by transverse and longitudinal division form a solid axis from which the short horizontal branches arise. The branches bear closely set, erect, dichotomous or secund ramuli. In a section of the frond these radiating branches are seen to be closely branched, the divisions erect and level-topped, giving to the axis the appearance of being surrounded by closely set stalked groups of peripheral filaments.

There is a variety of *M. clavaeformis*, which I have called var. *subcylindrica*, which outwardly closely resembles *M. densa*, but in this variety the branches are either perfectly simple or bear only one or two short patent secondary branches. In *M. densa* the plurilocular sporangia are either isolated or collected into little groups of from two to four, they are stalked, about 40 or 50 μ long and from 6–10 μ wide; they usually contain but a single row of cells. In the other two British species of *Myriotrichia*, the plurilocular sporangia are usually sessile and conical, containing three or four tiers of cells, and the unilocular sporangia are always sessile; while in *M. densa* the plurilocular sporangia are stalked, elongated, and frequently contain as many as a dozen tiers, and the unilocular sporangia are stalked; the radiating branches, moreover, are much more evidently moniliform in *M. densa* than in the other species. The British species of *Myriotrichia*, with their principal varieties, may be grouped thus:—

A. Axis clothed throughout with radiating branches; plurilocular sporangia conical or elongated, not collected into dense masses.

I. Upper branches longer than lower and bearing a few patent secondary branches.

a. Branches few and scattered; plant small, from $\frac{1}{8}$ – $\frac{1}{4}$ inch long. *M. clavaeformis*, Harv. var. *minima*, Holm. et Batt.

β . Branches numerous, closely set; plant from $\frac{1}{4}$ to $1\frac{1}{2}$ inch long. *M. clavaeformis*, Harv. var. *typica*.

II. Branches of nearly equal length throughout the entire length of the frond.

a. Horizontal branches bearing closely dichotomous, or second level-topped secondary branches; sporangia stalked, gametangia elongated. *M. densa*.

β . Horizontal branches simple or bearing only one or two patent secondary branches; sporangia sessile, gametangia conical. *M. clavaeformis* var. *subcylindrica*.

B. Axis clothed only at intervals with short simple

branches; plurilocular sporangia broadly conical or ovoid, surrounding the axis with dense cushion-like masses. *M. filiformis*, Harv.

I propose to characterize *M. densa* as follows:—

Fronds dark olive-brown, almost black, cylindrical in outline, slightly attenuated at the base, from half an inch to an inch and a half in length and from 200–250 μ in diameter, axis densely clothed throughout with short dichotomous or secund level-topped more or less moniliform secondary branches, hyaline hairs few or altogether wanting; unilocular sporangia stalked, spherical or ovoid, about 50 μ in diameter; plurilocular sporangia cylindrical or lanceolate, 25–60 μ long and 6–10 μ in diameter, containing one or two rows of cells.

Thickly fringing the old fronds of *Zostera marina*. Weymouth, Cumbrae, Arran, E. A. B.; Swanage, T. H. Buffham.

***Tellamia contorta*, Batt. l. c.**

At almost any station along our coasts shells of the common yellow periwinkle (*Littorina obtusata*, L.) may be found which have assumed a more or less deep olive-green colour. On examination with the microscope it will be found that this discoloration is caused by the presence of filiform Algae which penetrate the periostracum of the shell, but so far as I have been able to ascertain do not enter the calcareous portion of it. Although these Algae are usually found in abundance in shells inhabited by the living molluscs, where of course the periostracum is more or less perfect, I have not found them in dead shells, where it has been entirely worn away, so that I feel the more confident that these Algae confine their attacks to the periostracum, although they usually make their appearance, and no doubt find an entrance, where that membrane has been more or less eroded at the umbo. The presence of the Algae seems in no way to injure the shell, and may be of direct advantage to the mollusc, as the affected shells are much less conspicuous amongst the dark olive Fuci on which they are usually found than the bright yellow and consequently very noticeable healthy ones.

When a piece of the periostracum of a periwinkle which has been attacked by the Alga is examined under the microscope, it appears to be almost entirely composed of the oval cells of the *Tellamia*, the filaments of which are contained within the membrane, the horizontal filaments creeping either just below the external surface of the periostracum or just above the surface of the chalky portion of the shell. In the former case very numerous short vertical branches, ending in a pointed apical cell, push their way downwards towards the interior of the shell, and, passing completely through the outer membrane, are stopped by the chalky shell, or, turning again at right angles, grow for a short distance parallel to the primary filaments. In the other case, i. e. where the primary filaments are situated nearer the interior surface of the periostracum than the exterior, the vertical branches are pushed upwards and terminate at the exterior surface of the membrane, which becomes quite rough and irregular, owing to its being pierced by the very numerous branches of the parasite. These vertical branches are frequently so close together that they appear to form a more or less parenchymatous membrane.

The branching of *Tellamia contorta* is so irregular as to defy description, appearing to run in all directions, and so closely are the various individual plants packed together and their branches so interwoven that it is almost impossible to say to which individual a particular branch belongs, the branches in many cases apparently, and perhaps really, anastomosing. In addition to the ordinary cells, which are usually 3–6 μ in diameter and either oval or roundish, very much enlarged cells occur at irregular intervals in the moniliform filaments. These enlarged cells are either solitary or from two to a dozen or more together, and are always of a darker colour than the ordinary cells near them. These swollen cells do not appear to have any connexion with the reproduction of the plant, and are in all probability analogous to the enlarged cells in *Ostreobium Quicketti*. They vary a good deal in shape, but are usually oval or elongated, and are sometimes 40 μ long by

15 μ in diameter. Very frequently the filaments which contain these abnormal cells are curved in a falcate manner or even rolled up into a nearly spherical mass.

The zoospores are formed in slightly enlarged cells hardly differing in appearance from the ordinary vegetative cells. When the young plant first appears it is generally rolled up in a ball; at a later period the end of the filament grows out at a tangent, and branches are then given off in all directions. The endochrome appears to be applied to the walls of the cells in an almost unbroken layer.

In my note¹ on the genus *Tellamia*, I have referred to this genus, under the name *Tellamia intricata*, another Alga that usually accompanies *Tellamia contorta* and appears to be equally common. This plant, which is perhaps more closely related to *Endoderma* than to *Tellamia*, is much more slender than the plant above described, being seldom more than 3.5 μ in diameter, and is never interwoven into such compact masses as that species. The filaments are branched in a rather irregular way, opposite alternate or secund. In nearly every case the cells are longer than broad, but they vary very much in length; generally they are from 3-15 μ long, but longer cells are not uncommon; the diameter of the filaments varies from 2.5-4.5 μ , occasionally the branches anastomose. No enlarged cells like those of *Tellamia contorta* were observed. Zoospores are formed in enlarged cells about 6 μ in diameter. In this species the chromatophore nearly fills the entire cell, and is composed of an irregularly shaped layer broken here and there, and contains a single pyrenoid. The colour of the plant is yellowish green often almost brown. The genus *Tellamia* belongs to the Chaetophoraceae, and must be placed near the genus *Endoderma*. The genus may be thus characterised.

Tellamia. Thallus minute, consisting of radiating, irregularly branched, jointed, creeping filaments, living in the periostracum of mollusca; cells of the filaments often swollen and distorted. Zoospores formed in slightly enlarged cells.

¹ Annals of Botany, Vol. ix, p. 169.

Tellamia contorta. Filaments yellowish green or brown, very irregularly branched, branching both lateral and dorso-ventral; horizontal branches frequently falcate or coiled into a nearly spherical mass, sometimes anastomosing; vertical branches close together often united laterally, ending in a sharply pointed cell; cells 6–9 μ long, 3–10 μ in diameter; enlarged dark coloured cells 20 μ or more in diameter not infrequent.

Probably common all round our shores. Cumbrae, Weymouth, E. A. B.; Padstow, Falmouth, R. V. Tellam; Berwick, J. B.

Tellamia (Endoderma?) intricata. Filaments yellowish green, slender, branches long and slender, cells 2.5–4.5 μ in diameter, 4–24 μ in length. Chromatophores parietal, each containing a single pyrenoid.

Probably common. Cumbrae and Weymouth, E. A. B.; Padstow and Falmouth, R. V. Tellam.

I have named this genus in honour of Mr. R. V. Tellam, of Bodmin, who has done much to increase our knowledge of the Flora of Cornwall and Devon.

Calloolax neglectus. Schmitz MSS. in Holmes, Alg. Brit. Exsicc. On page 229 of the second volume of his Flora of Berwick-upon-Tweed, published in 1831, Dr. Geo. Johnston, speaking of *Callophyllis*, or as it was then called *Halymenia laciniata*, remarks, 'I have a specimen of this species, in which there are scattered irregularly over the frond small circular clusters of papillary tubercles about a line in height. The papillae contain minute oval granules, and each cluster or tuft is composed of about twenty papillae. It is a sort of fructification unnoticed by Dr. Greville, and perhaps affords a proof that characters drawn from the parts of fructification in the classification of the Algae, are only of subsidiary value.'

In the autumn of 1884, when collecting at Berwick, and since then on several occasions, I have found similar specimens to the one described by Dr. Johnston. About two years ago, or rather more, the late Dr. F. Schmitz, who was then in

England, told me he had found a new parasitic Floridean on *Callophyllis laciniata*: I then called his attention to the passage above quoted, and he told me that he felt sure the 'papillae' referred to by Johnston were really the fronds of his new parasite, which he proposed to call *Callocolax*. I showed my specimens to Mr. Holmes, and he has since found the plant in the south of England and has distributed specimens, though hardly very characteristic ones, in his excellent *Algae Britannicae rariores exsiccatae*. I may also mention that specimens of *Buffhamia speciosa* and *Tellamia intricata* have also been distributed in the same publication.

The fronds of this tiny parasite occur either in solitary specimens or in groups composed of from three or four to a dozen or more individuals, and are situated on any part of the host-plant. The fronds are from 2-4 mm. in diameter and are rather irregular in shape, being either quite simple, or lobed, or palmate. The connexion between host and parasite is very intimate, the cells of the one blending almost imperceptibly with those of the other. Like *Ricardia*, *Fanczewskia*, *Gonimophyllum*, and so many other parasitic Florideae, *Callocolax* belongs to the same family as the host on which it grows; and no doubt this fact has caused it to be often overlooked, as the structure of the cystocarp is exactly like that of *Callophyllis*, and the dividing line between host and parasite very difficult to see. When, however, as often happens, the host bears cystocarps and the parasite tetraspores or vice versa, it is not so easy for the parasite to escape observation. In some cases the fronds of the *Callocolax* are darker coloured than those of the *Callophyllis*, and I have found this is usually the case when the former bears cystocarps and the latter tetraspores; in the converse case the fronds of the *Callocolax* are the lighter coloured. I have received from Mr. T. H. Buffham tetrasporic specimens of this species plentifully scattered amongst the cystocarps, which they hardly exceed in size, of the host-plant; they are situated either on the edge or surface of the frond, and are

easily recognisable even to the naked eye by their pale colour. The genus may be described thus.

Callocolax, Schmitz in Holmes Alg. Brit. rar. exsicc. vii. Minute parasitic Floridean growing on the fronds of *Callophyllis*, connexion between host and parasite very intimate, the cells of the one more or less blending with those of the other. Fructification as in *Callophyllis*.

Callocolax neglectus, Schmitz l. c.

Fronds minute, solitary or gregarious, parasitic on *Callophyllis laciniata* situated either on the edge or the surface of its fronds and frequently prominent on both sides of it, bilobed, palmate or irregular in shape, 2–4 mm. in height; and about the same in breadth; tetraspores cruciate 18–20 μ in diameter; cystocarps like those of *Callophyllis*, large, occupying almost the entire frond which then assumes a nearly globular shape; Antheridia unknown.

Berwick, 1831, Dr. Johnston; 1884, &c., E. A. B.; Arran, Miss E. Barton, 1892; Paignton, 1894, and Falmouth, 1893, T. H. Buffham; Weymouth, 1893, E. M. Holmes; Swanage, E. A. B. Summer and autumn.

Hymenoclonium, nov. gen.

In 1859 the brothers Couan described¹, under the name *Callithamnion serpens*, a minute but interesting little Alga which they had found on bits of broken glass brought up by the dredge in Brest roads. They only obtained two specimens, and, so far as I am aware, until last winter the plant had not been again found. In December, 1894, Mr. E. M. Holmes showed me a specimen of an Alga he had received from Plymouth, which in many respects differed from any known British Alga, and appeared to belong to an entirely new genus. Mr. Holmes very kindly gave me a portion of his specimen for examination, and requested me, if the plant were new, to describe it. I had intended to name the species after Mr. Holmes, but a careful examination of the description

¹ Ann. Sc. Nat. 4th Ser. Vol. xii, p. 296, Pl. 22, Fig. I. 41–43

and plate of *Callithamnion serpens* given by the Crouans leads me to the belief that the plant found at Plymouth belongs to the same species. There can be no doubt, however, that the plant does not belong to the genus *Callithamnion*, and I propose to make a new genus *Hymenoclonium* for its reception.

This pretty little species creeps over the surface of the stone, or whatever it grows on, and adheres by its entire under surface, there being no rhizoids or anything of the sort. It is of a beautiful pink colour; and being branched like a *Callithamnion* or *Ptilota*, with the branches united by a hyaline membrane, it looks like a pink fern in miniature. The branches are all opposite, and either anastomose or fit between each other so as to form a nearly parenchymatous expansion, which retains its fern-like outline, however. There are no erect branches. Sometimes the main stem extends beyond the others and is bare of branches. According to the Crouans, tetraspores are formed from the contents of some of the cells of the main branches, but these I have not seen. The new genus may be described thus—

Hymenoclonium, nov. gen.

Fronds minute, adhering by the entire under surface; branches opposite, frequently anastomosing, united by a hyaline membrane into a pseudo-parenchymatous expansion; tetraspores (according to the Crouans) cruciate, formed from the cells of the main stem.

Hymenoclonium serpens (Crn.) = *Callithamnion serpens*, Crn. Ann. Sc. Nat., fourth ser., vol. xii, p. 296, pl. 22, I, Figs. 41-43; Florule du Finistère, p. 135.

Fronds minute, 2-4 mm. in length, rose red or pink, adhering to the substratum by their whole under-surface, bi-pinnate, branches opposite united by a hyaline membrane into an irregular pseudo-parenchymatous expansion, upper portion of the main branches often naked; cells of the main stems 35-40 μ long and 10-12 μ in diameter, those of the secondary branches 10-20 μ long, 8-10 μ or more wide;

apical cells of the main stems rounded, those of the secondary branches often pointed: chromatophores small, oval, many in each cell. According to the Crouans the cruciate tetraspores are situated in the continuity of the main stems.

Dredged from deep water in Plymouth Bay, December, 1894.

EXPLANATION OF FIGURES IN
PLATE XI.

Illustrating Mr. Batters' paper on New British Marine Algae.

Buffhamia speciosa, Batt. Figs. 1-10.

- Fig. 1. Plant natural size in situ.
 Fig. 2. A very young plant. $\times 200$.
 Fig. 2*b*. Apex of young plant. $\times 500$.
 Fig. 3. Apex of young frond ending in two hyaline hairs. $\times 500$.
 Fig. 4. Surface of sterile frond showing chromatophores. $\times 500$.
 Fig. 5. Section of frond before the appearance of the assimilatory filaments. $\times 250$.
 Fig. 6. Base of frond showing the rhizoidal filaments. $\times 600$.
 Fig. 7. Apex of young fertile frond. $\times 100$.
 Fig. 8. Transverse section of fertile frond showing sporangia, assimilatory filaments, and hyaline hairs. $\times 400$.
 Fig. 9. Longitudinal section of fertile frond. $\times 200$.
 Fig. 10. Branched sporangium and assimilatory filaments. $\times 500$.

Myriotrichia densa, Batt. Figs. 11-13.

- Fig. 11. Tuft of peripheral branches with empty plurilocular sporangia. $\times 300$.
 Fig. 12. Tuft with both full and empty plurilocular sporangia and an unilocular sporangium. $\times 300$.
 Fig. 13. Portion of peripheral branch with a branched plurilocular sporangium. $\times 300$.

Myriotrichia claviformis, Harv. var. *subcylindrica*, Batt.

- Fig. 14. Three of the peripheral branches with unilocular sporangium. $\times 300$.

Tellamia intricata, Batt. Figs. 15-17.

Fig. 15. Young plant showing the mode of branching. $\times 600$.

Fig. 16. Fertile frond. $\times 1500$.

Fig. 17. Section of the periostracum of *Littorina obtusata*, L. with *Tellamia intricata* filaments. $\times 500$.

Tellamia contorta, Batt. Figs. 18-24.

Fig. 18. Early stages in the development of *T. contorta*. $\times 150$.

Figs. 19-21. Stages in the development. $\times 500$.

Fig. 22. Portion of periostracum of *Littorina* with *T. contorta* seen from above. $\times 300$.

Fig. 23. Portion of the frond showing the horizontal branching and the enlarged cells. $\times 500$.

Fig. 24. Section of the periostracum of *Littorina* with *T. contorta* filaments. $\times 500$.

Callocolax neglectus, Schmitz. Figs. 25-29.

Fig. 25. Plant natural size in situ.

Fig. 26. Tetrasporic frond in situ. $\times 20$.

Fig. 27. Portion of the same. $\times 100$.

Fig. 28. Transverse section of a cystocarp. $\times 20$.

Fig. 29. Section through frond where it is united with the host-plant. $\times 200$.

Hymenoclonium serpens, Batt. Figs. 30, 31.

Fig. 30. Portion of a frond seen from above. $\times 100$.

Fig. 31. Tip of a frond showing chromatophores. $\times 700$.

Two new species of *Thismia*.

BY

H. N. RIDLEY, M.A., F.L.S.

Director of the Botanic Garden, Singapore.



With Plate XII.



THE following two species of *Thismia* were collected in the Malay peninsula, and are very distinct from any previously described.

Th. chrysops, n. sp.

Herba saprophytica ramosa, 3 pollicēs alta erecta vel suberecta. Folia lanceolata acuta parva pauca remota. Bracteae similes singulae. Flores singuli vel plures, pedicellis brevibus crassiusculis, atrobrunneis. Perianthii tubus flexus oblongus dilatatus $\frac{1}{4}$ pollicis longus atrobrunneus, lobis sex aequalibus tenuibus, basibus paullo dilatatis in apicibus filiformibus attenuatis rufobrunneis, ciliatis; corona oris integra elevata flava. Stamina 6, oblonga, apicibus latis connatis, processibus 2 clavatis ad apices, pluribus rectis brevioribus subtus. Antherae loculi parvi paralleli longitudinaliter dehiscentes. Stylus breviusculus, stigmata 3 incurva lineari-oblonga apicibus bifidis. Ovarium turbinatum, longitudinaliter rugosum roseum. Capsula similis major. Semina plura fusiformia, testa ad apices producta, rugosa.

On rotten logs, woods on the slopes of Mount Ophir, Malacca, alt. 2,000 feet.

This is a very charming little species, with the usual pallid stem three inches or more tall, sometimes branched, with a tuft of roots at the base. The bract-like leaves are lanceolate acute. The flowers are about as large as those of *Th. Aseroe*, Becc.; the tube is hardly dilated upwards, it is bent at an angle with the ovary. The very short pedicel is black, the ovary rose-colour, and the tube of the perianth is very dark sepia brown. The petals and sepals are quite similar, with a lanceolate base, and filiform apices of a bright sienna brown, and during life I could perceive that there were fine cilia on them. The ring surrounding the mouth is of a bright yellow, and but little raised. The stamens are broad and adnate for most of their length. At each corner of their broad truncate apices is a clubshaped process, and a few shorter processes project from the under side. The very small anther-cells are elliptic and parallel; the style is short and stout; the three stigmas are flat and broad with bifid ends. The capsule is cup-shaped, with papillose longitudinal ridges.

***Th. grandiflora*, n. sp.**

Herba saprophytica, caule suberecto $1\frac{1}{2}$ pollicis alta, uniflora. Folia et bracteae lanceolatae acuminatae appressae trichomatibus glandulosis tectae. Flos majusculus, terminalis. Ovarium breve. Perianthii tubus pollicem longus latum urceolatum, pallide roseum, striis obscurioribus, lobis basibus latis ovatis $\frac{1}{2}$ pollicis longis, apicibus filiformibus $\frac{1}{2}$ pollicis longis e dorsis productis, omnibus aequilongis brunneis, corona oris paullo elevata brunnea. Staminum connectivae quadratae connatae, processibus filiformibus breviusculis 3 in medio multo longioribus, pluribus brevibus subtus e margine elevato. Antherae loculi subparalleli, approximati parvi. Stylus pro genere longiusculus. Stigmata 3 oblonga lanceolata obtusa integra papillosa. Capsula non visa.

Johore, near Tana Abang at the mouth of the river Sembrong, where a single plant was collected by Mr. H. J. Kelsall, who also made a coloured sketch of it.

This species is allied to *Th. Ophiurus*, Becc., a native of Borneo; but that is described as having yellow flowers, the

bracts are figured as smooth and wanting the glandular hairs of *Th. grandiflora*, and the broader dilate base of the perianthlobes is much shorter in proportion to the filiform tails. The androecium and pistil of *Th. Ophiurus* are not described. *Th. grandiflora* is remarkable for the large urn-shaped perianth tapering to the ovary at the base. It is of a dull rose-pink, with numerous longitudinal striae. The corona, which is more distinctly elevated than in the preceding species, is brownish. The androecium resembles that of the *Th. chrysops*, except in having three processes on the edge of each connective, one of which is much longer than the two outer ones; and there is also a distinct inner margin behind the front edge, which bears a number of low papilla-like processes. The form of the connectives of the anthers and the amount of connation will probably be found to be the best means of classifying the various species of the genus. The stigmatic lobes are rounded and blunt, and quite entire.

Of the Asiatic species at present known, the two Indian species, *Th. Brunoniana*, Griff., from Tenasserim, and *Th. Gardneriana*, from Ceylon, are separated from those of the Malayan region by having caudate sepals and short ovate dissimilar petals; while in the Malay species, *Th. Aseroe*, Becc., *Th. fumida*, Ridl., *Th. chrysops*, Ridl., *Th. grandiflora*, Ridl., *Th. Ophiurus*, Becc., the petals and sepals are quite similar. *Th. Neptunis*, Becc., a very remarkable species from Borneo, has also dissimilar petals and sepals.

EXPLANATION OF FIGURES IN PLATE XII.

Illustrating Mr. Ridley's paper on two new species of *Thismia*.

- Fig. 1. *Thismia chrysoys* (nat. size).
- Fig. 2. *Thismia chrysoys*, in fruit.
- Fig. 3. Perianth-tube laid open (enlarged).
- Fig. 4. Stamens (enlarged).
- Fig. 5. Stamen reflected (enlarged).
- Fig. 6. Pistil (enlarged).
- Fig. 7. Stigmas expanded (enlarged).
- Fig. 8. Capsule after dehiscent (enlarged).
- Fig. 9. Seed (magnified).
- Fig. 10. *Th. grandiflora* (nat. size).
- Fig. 11. Bract (enlarged).
- Fig. 12. Perianth-lobe, front view (enlarged).
- Fig. 13. Perianth-lobe, side view.
- Fig. 14. Upper part of tube with corona-lobes reflexed.
- Fig. 15. Stamen.
- Fig. 16. Stamen reflected.
- Fig. 17. Style and stigmas.

On *Thismia Aseroe* (Beccari) and its Mycorrhiza.

BY

PERCY GROOM, M.A., F.L.S.



With Plates XIII and XIV.



A. MORPHOLOGY.

A NUMBER of holosaprophytic forms found in the tropics of the old and new worlds, constitute the Burmanniaceous genus *Thismia*. The species here described, *T. Aseroe*, is Malayan, and was discovered and first described by Beccari¹.

The plant consists of a system of branching, cylindrical, leafless, axial structures, which will be hereafter alluded to under the name of absorbing organs. These organs extend horizontally over a substratum of decaying leaves to which they are attached². When the plant is in the flowering condition, an erect scale-bearing inflorescence-axis rises up from the creeping absorbing organ. This axis was tentatively described by Beccari as simple, and terminating in a solitary flower; but frequently it is branched. In my specimens a second flower was always visible in the axil of

¹ Beccari, Malesia.

² Mr. H. N. Ridley informs me that the plant lives in damp shady spots of the forest, and that the habit and habitat are as above described.

one of the three scales forming an involucre beneath the terminal one: but there may be as many as three flowers in the inflorescence (Fig. 19). As is often the case with saprophytes devoid of chlorophyll, the general body of the plant is not white: in this instance it is pink.

Morphology of the Flower. (Fig. 20.)

The flower is orange-yellow in colour. The perianth forms a trumpet-like tube with six linear segments radiating from its summit like rays of a star. The six stamens are opposite the perianth-segments; they are inserted on the perianth-tube near the top, and are partially shaded by the thickened rim of the tube. The stamens hang down, and their connectives are dilated and, continuing below the anthers, cohere to form a tube. In fact the stamens are fused except at their points of insertion and at the apices of the connectives. Thus a tube is formed lying within the perianth-tube and open at both ends. This staminal tube is perforated at the top by six window-like narrow openings which are the gaps between the separately inserted stamens. The structure of the stamens is complicated and requires full description. Their structure on the face towards the centre of the flower is simple; they form a tube (with the above gaps) which has a plain surface merely rendered papillose by numerous blunt short hairs. This condition persists right down to the median free tooth which terminates the connective below. Looking through the tube from the inside not far below their point of attachment, the six anthers may be seen, and lower down, on radii alternating with the anthers, are six discoid opaque bodies—the nectaries. These last were seen and figured by Griffiths in *T. Brunonis*, but their nature was not understood by him. Both the anthers and the nectaries open towards the exterior, not towards the centre of the tube. Hence the anthers are really introrse though they open away from the centre of the flower. The structure of the stamens on their outer faces is complex.

Above is the short membranous filament which is attached both above and at its sides to the top of the tube of the perianth. So the filaments form six little dome-like chambers which stand over the six anthers. A transverse section taken through this region would show that there are two wings to the filament which already denote the method of formation of the staminal tube. Lower down, these wings meet and form a tube, and the pollen-sacs opening outwards (towards the perianth-tube) are visible. Below the anthers the fused wings continue, and form six furrows between the thickened ridges which are continued down from the anthers. In the middle of the furrows are long hairs which, I imagine, serve to catch the pollen. Descending lower the ridges become winged, and the two wings of the adjacent ridges tend to arch over the furrows. Below this the wings increase in size, and form six small tunnels in which lie the six nectaries. Each discoid nectary consists of a single layer of palisade-like, deeply-staining cells. Half of the disk belongs to one stamen and half to an adjacent one, and the line of fusion of the two stamens is recognizable, as is the distinct curvature of the nectariferous cells (Fig. 18). At the upper end of the tunnel the wings have long hairs which help to roof in the cavities in which the nectaries lie. Lower down the nectaries are replaced by hairs in the middle of the furrows, and the staminal ridges become much changed. They form curved plate-like outgrowths, attached above and at the sides, so that six little flattened dome-like chambers are formed closed above but open below. The median free part of this curved plate-like outgrowth hangs down and is rolled slightly inward and has conspicuous long hairs at its margins. Continuing downwards, only the lateral walls of this open chamber persist. The staminal tube therefore exhibits at this point twelve little channels, the broader ones representing inter-staminal radii, and the narrow ones the staminal radii. Below the connectives separate, and the lateral walls already mentioned end in conspicuous strong teeth or pegs. The median portion of the connective persists lower and tapers to a fine

tooth. The ovary is inferior, unilocular with three parietal placentae. The ovules have long filaments and develop very late. The style surmounted by three-segmented stigma is short, reaching up to the point of the terminal teeth of the connectives. The flower is proterandrous. It will be seen that both the pollen and nectaries are very completely hidden and protected. The structure of the flower suggests that it is cross-pollinated by means of small flies. I imagine that they crawl down the staminal tube, go on to the stigma as a landing place at which to turn round in order to crawl up to the nectaries. It seems probable that they then walk up the nectar-tunnels, and being unable to turn round continue up and emerge through one of the six windows in the top of the staminal tube, accidentally taking, en route, some pollen either from the pollen-sacs or from the hairs on the furrows.

It is usually stated that the perianth-tube and the top of the ovary fall off together when the fruit is ripe. Such is not the case. The perianth wholly severs its connexion with the ovary before the fruit ripens, and subsequently the lid of the ovary separates as an operculum. (See Fig. 19.)

Histology of the Inflorescence-axis.

The inflorescence-axis at its base bears a few very small scale-leaves crowded together; higher up the scales increase in size and are separated by distinct internodes till close under the terminal flower there is an involucre of three relatively large scales.

The axis itself is not terete, but is more or less winged.

At the growing-point a *dermatogen* is visible, but in mature parts there is no definite regular epidermis preserved; a number of the cells have peeled off. The superficial cells have only a very delicate cuticle on their outer walls. They are narrow and elongated longitudinally. Fungal hyphae run over the surface but do not penetrate.

The cortex is composed of about ten layers of parenchymatous cells with not very small intercellular spaces. Amongst these cells are some raphide-mucilage sacs. At the base

where the axis is inserted on the absorbing organ, straight hyphae run longitudinally in the cortex and are continuous with the mycorrhizal hyphae; they stretch only a short distance up the inflorescence-axis.

The *endodermal* cells are uneven in size: they have thin suberised walls; the lateral walls have the dots (which however are not invariably on walls actually radial).

The *stèle* is considerably larger than in the absorbing organ. There is a single somewhat irregular layer representing the pericycle. Within are three collateral bundles and a parenchymatous pith.

The *phloëm* is tangentially extended, and consists of sieve-tubes with terminal plates, companion-cells, and less protoplasmic parenchymatous cells.

The *xylem* is better developed than in the absorbing organ. The protoxylem, represented by narrow disintegrating spiral and annular vessels, is not exactly radially internal to, but slightly on the side of the mass of xylem. Besides these vessels there are in each bundle 4-8 (in transverse section) broader intact spiral and annular tracheae, the segments of which are long and tapering.

Histology of the Scales.

The scales are simple in structure. An epidermis with thin cuticle and devoid of stomata covers a mesophyll consisting of two layers of large parenchymatous cells including small intercellular spaces. A single vascular bundle with xylem and phloëm runs up the middle of the scale. The only point of interest in the leaves is that they contain amongst the mesophyll-cells many raphide-mucilage cells, as is often the case with scales on the flowering axes of holosaprophytes.

Structure of the Absorbing Organs.

On a relatively main axis there are borne tufts of smaller branches, which are lateral absorbing organs, and young buds

of inflorescence-axes. The mode of growth is represented by Fig. 1. The axis grows by means of an apical growing-point, and on it arise, in acropetal succession, similar lateral branches. But at the points of insertion of these secondary axes, other branches arise subsequently on the side towards the apex of the main axis: so the false appearance is produced of a number of tertiary axes in the axils of the secondary. Of these tertiary axes one at least is a bud of an inflorescence-axis. As a rule the tertiary absorbing organs grow more rapidly than the buds; consequently distinct tufts of small absorbing organs are visible at regular intervals on the main axis. The main axis decays from behind, and it seems probable that its lateral absorbing organs thus become separate individuals.

Taking sections through a mature but not too old portion of a vegetative axis, the following structure is revealed (Figs. 2, 3, 4, 5 *a*, 5 *b*).

(1) *Sheath*.—There is no definite regular layer of cells clothing the surface. Some of the external cells are elongated at right angles to the surface and form short *hair-like outgrowths*. But often a delusive appearance of hair-production is caused by the cells, which are elongated longitudinally, partially separating from the subjacent cells and the free portion protruding outwards. A very feeble cuticle coats the outer walls of the superficial cells. Within succeed about 2–3 layers of cells with small intercellular spaces. They are elongated longitudinally. These and the cells exposed to the surface agree in being parenchymatous cells with thin cellulose-walls, having a delicate protoplasmic lining and a large amount of cell-sap, but no starch; in fact they might be described as constituting an aqueous tissue. They may be collectively referred to under the name of the *sheath*. Amongst the sheath-cells are raphide-mucilage cells. The most striking feature about this tissue is that *straight fungal hyphae* (mycorrhizal) *run through some of the cells*. These hyphae traverse the centres of the cells running in a longitudinal direction with wonderful straightness. Here and there they

send off straight branches which run obliquely outwards or obliquely inwards (Fig. 2). There are in addition minute, blunt, nearly solid protuberances on the sides of the hyphae: these are arrested branches. The hyphae are mostly unseptate inside the sheath, but some of the older hyphae are divided by transverse walls. They are continuous with septate hyphae outside the plants and also with the hyphae occupying the deeper layers of the organ.

(2) *Exocortex*.—Within the innermost layer of sheath-cells a sudden and remarkable change in the tissue takes place. There succeeds a single unbroken and very regular layer of cells, with no intercellular spaces and having a quite different shape and strikingly different contents. These cells vary in form from narrow palisade-like cells elongated radially, to more or less square cells: but in any case they are much broader radially than the sheath-cells. They have thin cellulose-walls. But in their contents they form the greatest contrast to the sheath. *Every cell is almost filled with a coiled mycelium consisting of swollen irregular moniliform mycorrhizal hyphae with densely staining protoplasm.* The protoplasm of the host-cell coats these hyphae and lines the wall; there is a conspicuous nucleus, and a relatively small amount of cell-sap. I pointed out that in the absorbing axes (root or stems) of holosaprophytic Orchids some of the outer tissue entertains living coiled mycorrhizal mycelia, and that this tissue is sometimes differentiated even in the growing-point before the hyphae have reached it: to it I gave tentatively the name *exocortex*¹, and the same term may be employed to describe this single layer in the absorbing organ of *Thismia*. Very rarely one of the cells of this layer in *Thismia* is changed into a raphide-mucilage cell. No starch is found in the mature cells.

(3) *Limiting Layer*.—Within the exocortex a layer succeeds which again sharply contrasts with it. The cells are parenchymatous, radially flattened, smaller than the preceding,

¹ Percy Groom, Contributions to the Knowledge of Monocotyledonous Saprophytes, Journ., Linn. Soc. read Dec. 20, 1894.

slightly elongated longitudinally; they include no intercellular spaces. They have thin walls of cellulose, and protoplasm lining the walls and coating the hyphae. The latter are widely different from those of the preceding layer; they consist of *very slender hyphae, often spirally twisted, which suddenly swell out into conspicuous intercalary bladder-like bodies often filled with densely staining protoplasm.* Usually there is only one, or at most two bladders, in one cell. The hyphae may be traced from the exocortex and from the deeper layers of cortex into this limiting layer.

(4) *Mediocortex*.—The next two layers of cells lying within are much larger, and are more or less isodiametral and hexagonal, or the inner slightly elongated longitudinally. The intercellular spaces are small. They contain *conspicuous dead yellow mycelial masses, consisting of portions of defunct hyphae which are connected by slender portions of hyphae with one another.* In addition these cells may contain large quantities of starch. Here it may be mentioned that the starch throughout the plant assumes a red colour with iodine, as is often the case with starch in holosaprophytes. In this region of the cortex there are a considerable number of large raphide-mucilage sacs. In accordance with the terminology before suggested, these two layers constitute the *mediocortex*, characterized by containing inert refractive fungal masses. In parts of the axis these layers are immediately succeeded by the endodermis; in other thicker portions there is a third layer of parenchyma with cellulose-walls; but in this third layer the cells are markedly elongated longitudinally, and as a rule they are utterly devoid of hyphae though often rich in starch.

(5) *Endodermis* consists of a somewhat irregular single layer of feebly protoplasmic cells with thin suberised walls displaying the radial dots. The cells are elongated in a longitudinal direction, but they are considerably smaller than the cortical cells outside them.

Central Cylinder.—The stele is very narrow in comparison with the well-developed layers of parenchyma constituting

the sheath and cortex. It commences with a single tolerably regular and typical *pericycle*, the cells of which are elongated longitudinally and are narrow.

Phloëm.—There are about 6–8 minute bundles of phloëm lying against the pericycle. Each group consists of 1–3 extremely delicate sieve-tubes with terminal plates, and 1–3 slightly wider protoplasmic cells representing companion cells (in transverse section).

The different bundles of phloëm are separated by parenchymatous conjunctive tissue, which also bounds them on their inner sides.

The *xylem* is reduced to a single axial strand of very narrow annular and spiral vessels, and slightly broader, more central, reticulate-scalariform tracheae. In transverse section the strand may exhibit as few as three vessels, but never more than eight.

The structure of the growing-point of this organ at once reveals the fact that the vegetative axis of *Thismia* is absolutely unique.

The *sheath* is continuous over the apex, and the actual tip of the organ ends in a collection of sheath-cells protruding as conspicuous hairs¹. The meristem lies internally (Fig. 4), and though it is impossible to certainly distinguish the initial cells sufficiently clearly to conclude that there are three distinct histogens, still one can recognize that in the apical meristem three distinct tissues are differentiated very early—the *sheath*, the tissue extending from and including the exocortex to the endodermis, and the central cylinder. In fact the apex suggests that of an ordinary succulent monocotyledonous root, in which the absolute distinction into calyptragen, periblem, and plerome is not obvious at the extreme merismatic limit. Thus the *vegetative axis is possibly a root in which the root-cap is preserved throughout life as a living and absorbing layer* which further acts as an aqueous tissue and entertains the symbiotic fungus. Some of its cells do, however, peel off and die, but the majority persist. If this interpretation

¹ Compare a haustorium.

be correct, then the *exocortex*, inasmuch as it is the outermost layer which soonest ceases undergoing periclinal divisions and becomes earliest sharply marked off from the cells produced by the calyptragen, is the *original piliferous layer* (epiblema). Undoubtedly the cells which produce it also give rise to the layers as far as the endodermis, but it was impossible to see whether the initials of this layer and the cortex are absolutely distinct from those forming the sheath. The *limiting layer* then corresponds with the *exodermis*. The rest of the cortex is equivalent to the remaining cortical layers of an ordinary root. The section figured suggests that the plerome has initials of its own (Fig. 4). The structure of the central cylinder favours the view that this vegetative axis is a root. There is in other saprophytic roots, and in Burmanniaceae in particular, a tendency for the xylem-bundles to be developed towards the centre of the cylinder; and there is the further fact that the spiral and annular vessels tend to lie outside the scalariform-reticulate tracheides.

But another interpretation is possible, namely, that the vegetative axis is a rhizome in which the leaves are congenitally fused with the stem. This view may be illustrated by some examples which offer stages towards this process of fusion. On the tuberous rhizome of *Epipogum nutans*, the leaves are well developed but without vascular bundles, and their inner (upper) faces are so closely adherent to the axis that they have in sections to be separated by chemical means¹. In addition the lower (outer) surface of the leaves is provided with numerous absorbing hairs. If we imagine this state in the ancestor of *Thismia*, and that gradually the leaves have become congenitally fused with the axis, the present structure would result. In this case the sheath represents the leaf-tissue, the exocortex represents the epidermis of the axis, the tissue within corresponds to the cortex and stele of the stem. This view is supported by the fact stated by Johow², that in

¹ Percy Groom, loc. cit.

² Johow, Die Chlorophyllfreien Humuspflanzen, &c. Prings. Jahrb. xx, P. 475.

Dictyostega orobanchoides (Burmanniaceae) the leaves of the rhizome do produce absorbing hairs and form the absorptive organs of the plant.

There is a third possibility, namely, that the vegetative axis is a rhizome in which the leaves have been completely suppressed. I have already shown that in a hemisaprophytic Orchid (*Corysanthes*) there is an atrophy in the leaves of the absorbing rhizome. In a later paper I shall show that the same atrophy has taken place in the green Burmanniaceae to such an extent that the leaves are mere microscopical scales (cp. *Psilotum*). Further, the structure of the stele in absorbing rhizome-axes of hemi- and holo-saprophytes is frequently remarkably like that of a root (*Corysanthes*, *Burmannia*, *Corallorhiza*), so the root-like nature of the stele of the absorbing organ is no proof of its root-nature. Nor is the position of the spiral and annular vessels absolute testimony that it is a root, for even in the inflorescence-axis of *Thismia* the protoxylem is not accurately radially within the phloem and later wood; and in indubitably absorbing stems of saprophytes, the protoxylem often does not stand radially within the later formed xylem.

The fact that in some other Burmanniaceae the rhizome develops as an absorbing organ, is not of the slightest value as evidence that the absorbing vegetative axis of *Thismia* is really a rhizome. For amongst the Orchidaceae in some forms the root-system is entirely absent and the rhizome greatly developed as an absorbing and vegetative organ (*Epipogum*, *Corallorhiza*), whereas in other Orchids the roots are greatly developed and act as absorbing organs (*Galeola javanica*, *Neottia*, &c.).

But the structure of the growing-point, taken together with that of the stele, seems to me to point rather to the absorbing organ being a root, and not, as hitherto assumed, a rhizome¹. However, it seems safer to call it a thallus.

¹ See Engler, Burmanniaceae, in Engler & Prantl's Pflanzenfamilien.

Origin of Lateral Members on the Vegetative Axis.

I did not succeed in finding any sufficiently early stages of the lateral absorbing organs, but their structure and attachment to the main axis suggest that they arise endogenously in that they arise from tissue lying deeper than the sheath. The scapes develop from cells which lie deeper than the sheath (Fig. 3). Beyond making this statement I can say nothing. The very young scape could be identified as such by the feeble lobes representing the primordia of the scales. Even when the scales were clearly differentiated the young buds could be seen covered with layers of cells belonging to some external tissues.

Development of the Mycorrhizal Mycelium, and the Relations between it and the Nuclei of the Infected Cells of Thismia.

In view of the all-important functions ascribed to the nucleus of a cell, the question naturally arises as to the relation between the nucleus of the host-cell and the hyphae of the symbiotic Fungus. If the host-cells and the fungal hyphae do actually work in harmony, and if the nucleus be the guiding centre of a cell, we should expect that some intimate relations would exist between the host's nuclei and the guest's hyphae, and that possibly such relations would be reflected in the histological details of the symbionts. In the thallus of *Thismia* the coarseness of the hyphae, and their long persistence as distinct filaments, render investigation of this question simple.

The mycorrhizal hyphae in the different layers of the thallus of *Thismia* may be traced to the apex as separate living hyphae which reach nearly as far as the dividing merismatic cells. *The hypha, then, does not enter a cell till the latter has finished dividing and already possesses a nucleus clothed with a distinct permanent membrane. Thus there is no evidence of any exchange of living nuclear material between guest and host.* My material was not fixed in such a manner as to enable me to assert or deny any protoplasmic continuity

between the cytoplasm of the host and that of the Fungus, but there never was any indication of such a connexion, though each hypha is externally coated from first to last by a sheath of cytoplasm.

The *differentiation of the definite layers of the thallus is not directly caused by the mycorrhizal organism*, for the distinction of the various layers (sheath, exocortex, limiting layer, rest of cortex, and stele) appears in young portions of the apex before the hyphae have reached the cells of that region.

I did not trace the mode of entrance of the hyphae into the sheath-cells, but in all the deeper infected tissue the *Fungus enters the cell as a single slender hypha which at once grows directly towards the nucleus of the host-cell* (Figs. 6, 16). That it is not the nucleus which travels towards the hypha is shown by the fact that the nucleus preserves its original central position before and for some time after the hypha has reached it.

The later career of the mycelium represented by this single hypha depends on the position of the host-cell. As the subsequent changes are most clearly traceable in the inner layers of the cortex (mediocortex) an account will be given first of the development of the mycorrhizal Fungus in this region.

Development and Fate of the Mycelia in the Mediocortex
(Figs. 6-11).

With the penetration of the embryonic hypha, the starch-grains of the cell disappear never to return, or to reappear only when the hyphae are dead or dying. When treated with Gram's method (methyl violet) and cleared with oil of cloves containing eosin, the protoplasm of the hypha stains blue, and its numerous minute nuclei become deep blue; the cytoplasm of the cell and the main body of the cell-nucleus colour pink, but the nucleolus and some large granules in the nucleus stain deep blue. *The hypha having reached the nucleus commences to form a local pear-like or oval swelling against the nucleus.* This young bladder is really intercalary,

but as the hypertrophy is particularly on the side towards the nucleus, the thin continuation of the original hypha (i.e. the apical part) appears to spring from the young bladder at a point close to the insertion of the original slender portion of the hypha. The bladder gradually assumes a spherical form. At first it is filled with a densely pink-staining mass of cytoplasm with many nuclei. But as it attains larger dimensions vacuolation sets in. The bladder is now mature, and the further changes in it are associated with its waning vitality and death. Either the natural movements of the cell's protoplasm, or movements associated with the local hypertrophy of the hypha, cause the host's nucleus to shift its position in the cell. The young slender continuation of the original hypha now bends towards the cell-nucleus, and applying itself to the latter proceeds to form a second bladder. In the meanwhile great changes are taking place in the first bladder. Its protoplasm loses its staining intensity, diminishes in amount, and at the same time there is deposited in it a homogeneous yellow substance in which are rod-like bodies, which remind one of the regular rod-like 'bacteroids' in leguminous tubercles. This deposit appears always to commence at the proximal part of the bladder, and is not a product of the metamorphosis of the cell-wall, though it lies close within the wall and sooner or later is absolutely in contact with it. This substance gradually increases in size, the walls of the bladder collapse, and finally nothing remains but a shrunken wall covering a mass of homogeneous substance coloured by a yellow oil-like liquid, and containing numerous rod-like bodies. The older thin portion of the hypha shrinks too, and the yellow substance seems to block the connexion between its lumen and the thin portions of the hypha. So it is altogether inconceivable that any considerable conduction of liquids can take place along these thin portions of the hyphae. The second bladder soon passes through the same changes as the first, and a third bladder, or even a fourth and fifth, may be formed and repeat the process. But sooner or later the hypha passes through the cell-wall and enters

an adjoining cell which lies nearer the apex or is situated nearer the centre of the root. This young hypha again repeats the same history as in the preceding cell. Hence in the cells of the mediocortex, the youngest bladder is always to be found lying against the nucleus, although the nucleus does not preserve its original central position. In an old cell in which all the bladders are dead, the main mass of the cytoplasm, as also the nucleus and its bubble-like nucleolus, stain pink, but minute granules in the nucleus still stain blue, when treated with Gram's method as already described. No hyphae enter the raphide-mucilage sacs.

The Mycelia in the Sheath-layers.

The hyphae in the sheath behave very differently. The hypha runs straight through the middle of the cell in a longitudinal direction. The nucleus of the host-cell may be often seen lying close against this hypha. The hypha undergoes no local hypertrophies; it increases evenly in volume, so that an old hypha is merely stouter than a young one, and its contents do not stain so intensely blue. The mycelium in these sheath-layers is very long-lived, so that in old parts of the thallus it is still living and protoplasmic. There is at most a feeble deposit of excreta as represented by a more or less faint yellow colouration and minute yellow granular clumps in the protoplasm of the old hyphae.

The Mycelium of the Exocortical Layer (Figs. 12-15).

The hyphae of the characteristic exocortical layer are intermediate in behaviour between those of the sheath and those of the mediocortex. The slender hypha on reaching the nucleus does not at first undergo considerable local hypertrophy; it grows rapidly and coils about in the cell, and the older parts increase at first tolerably regularly in volume. It seems probable that the youngest part of the hypha always tends to follow the host's nucleus. For in sections one often sees this youngest part close to the nucleus, and frequently fails to find a young slender hypha distant

from the nucleus unless it be leaving the cell altogether. Eventually, however, distinct localized enlargements form on the hyphae, which thus assume bloated irregular moniliform shapes. The hyphae branch but feebly in these cells. The hyphae usually pass on to younger cells of the same layer, i.e. the hyphae tend to run longitudinally, but occasionally they send branches into the cells lying within, namely, the limiting layer. The mycelia live much longer than those of the mediocortex, and in old parts they may be found with deeply staining protoplasmic contents. When they do die, which is earlier than is the case with the mycelia in the sheath, there is little or no deposit of excreta, and all that remains of them is a shrunken clump of thin hyphal walls.

The Mycelia in the Limiting Layer (Figs. 15, 16).

The mycelia in the limiting layer in every way form a transitional stage between those of the exocortex and those of the mediocortex. The hyphae curve sharply, swell irregularly into one or two bladders which are formed only in contact with the nucleus of the host-cell; the unswollen portions retain their embryonic slender calibre. The bladders are not so regularly spherical as those of the mediocortex, but often the primitive egg-like form characteristic of their early state in the mediocortex persists. Furthermore these bladders preserve their protoplasmic contents much longer than do those of the deeper cortical layers; and often in old parts these densely protoplasmic bladders at first sight look like large single spores.

Previous Records of Formation of Intercalary Bladders on Hyphae of Mycorrhiza.

The first record of intercalary hypertrophies of mycorrhizal hyphae is that of Mollberg¹, who found them in *Platanthera bifolia* and *Epipactis latifolia*. He wrote: 'Es waren intercalare und auch terminale knopfförmige, aber auch lange

¹ Mollberg. Quoted in Wahrlich's paper.

keulige Auftreibungen, die auf den ersten Blick wie beginnende Sporenbildungen aussahen. Diese Gebilde traten auch kettenförmig hinter einander auf, waren reicher an Protoplasma als die Fadentheile und besaßen grosse Vacuolen. In der Kultur wuchsen sie wieder zu gewöhnlichen Fäden aus, ohne sich zu Reproductionsorganen auszubilden.' W. Wahrlich¹ investigated other Orchids, and the first stage he found in the cortical parenchyma of the fungal clumps was a sac-like swelling of a hypha which soon gave off numerous branches. These latter finally form a close system of fine hyphae concealing the original sac. Kühn² showed that in the mycorrhiza of Marattiaceae mycelial clumps occur with a central bladder-like sac; in fact are just like those described by Wahrlich. Kühn figures a cell from the mycorrhiza of *Angiopteris evecta* as containing a bladder, also a hypha dilating into a terminal spherical body which is rich in protoplasm and possesses a large nucleus. This last he terms a spore with a large nucleus. But I have no doubt that the nucleus (as its size indicates) was really lying outside the spherical body and was the nucleus of the host-cell, and the sphere itself was nothing else than a young bladder. So it seems likely that in *Angiopteris*, too, the bladders form first in contact with the nucleus of the host-cell.

B. PHYSIOLOGY.

Discussion of the Behaviour of the Mycorrhizal Mycelia.

The first prominent fact with reference to the mycelia of *Thismia* is that a young hypha on entering a cell grows directly towards the nucleus of the latter. There are two possible explanations of this phenomenon. It may be that the hypha grows in that direction for purely mechanical

¹ W. Wahrlich, Beitrag zur Kenntniss der Orchideenwurzelpilze. Bot. Zeit. 1886, p. 480.

² R. Kühn, Untersuchungen über die Anatomie der Marattiaceae und anderer Gefässkryptogamen. Flora, 1889, pp. 491-497.

reasons, because the currents in the cell set most vigorously towards the nucleus, and the hypha is carried with them, much as, in flowing water, a slender submerged stem has its young parts pointed down stream. The other possible explanation is that the hypha seeks the nucleus in virtue of its chemotropism, the chemotropically active substances being manufactured or accumulated in greatest quantities nearest the nucleus of the infected cell¹. This second explanation appears to be the correct one, as will be seen from the following considerations. (i) The distribution of the endotrophic mycorrhizal hyphae in a holosaprophyte suggests that we are dealing with a chemotropic phenomenon². The coiled hyphae occur in some cells, but are absent from others equally accessible. They enter into cells of absorbing organs—roots, leaves, or stems—but avoid cells of organs which are not absorbing, whatever their morphological nature. And even in the absorbing organs the hyphae are absent from some cells (raphide-mucilage cells) though present in the contiguous one. (ii) Miyoshi³ has shown that certain chemical bodies do exercise a directive influence on the hyphae of Fungi. (iii) There is evidence that absorption of plastic substances from the host-cell by the hypha takes place most vigorously near the nucleus of the cell. For in the mediocortex and limiting layer the bladders, at first full of protoplasm, form only in contact with the host's nuclei. We cannot explain this local hypertrophy of the hyphae as due to a stoppage of substances conducted inside and along the hyphae; because of the slender nature of the portions of the hyphae connecting the bladders with one another, and because of the early death and probably the complete occlusion of those portions. So we are compelled

¹ Of course it is equally conceivable that in one cell the hypha moves towards the nucleus in virtue of a repellent action of a substance which is consumed most rapidly near the nucleus. But, as will be seen later, this view would involve a number of complicated assumptions for which there is no evidence.

² Percy Groom, loc. cit.

³ M. Miyoshi, Über Chemotropismus der Pilze. Bot. Zeit. 1894.

to conclude that the bladders are formed near the nucleus of the host-cell because it is at this point that the hypha is absorbing plastic substances most vigorously, and working them up into protoplasm more rapidly than they are conducted along the hypha. There is no indication of the wall of the hypha at this region being different in nature to the wall in the narrow portions of the hypha. (iv) Again, if the chemotropism of the hypha explains its growth in the direction of the nucleus, we may hope to find the same condition in other cases in which the Fungus is indubitably absorbing from the infected cell, i. e. in parasites. Rosen¹ observed in the parasitic *Puccinia asarina* that the haustorium nearly always grew towards the nucleus of the attacked cell, and becoming closely applied to it caused deformations of the nucleus, and even pushed deep into it, driving in the nuclear membrane. Professor Marshall Ward informs me that in *Hemileia* (of the coffee-disease) 'the haustoria often apply themselves to the nuclei of the host's cells.' The *growth of the hypha towards the nucleus of the infected cell in mycorhiza, then, is not any evidence that the relation between Fungus and host is friendly and symbiotic, but is rather an indication that the hypha is absorbing food from the cell in which it lies.* Still the apparent directive influence of the host's nucleus has been observed in other symbiotic forms. Professor Marshall Ward tells me that in the leguminous tubercles he found the hyphae (?) growing toward the nuclei. Schlicht² states that the mycorhizal hyphae in *Paris quadri-folia* often penetrate the nucleus. In Orchids it is easy to see that in mature cells the hyphae usually form a coiled mycelium around the nucleus, and Frank has pointed out that often the first trace of the mycelium is to be seen near the nucleus of the infected cell.

. Thus a hypha enters a cell because it is attracted thither by a chemotropically active substance, and goes towards the

¹ Rosen, Beitr. zur Kenntniss der Pflanzenzelle. Habil.-Schrift, 1892.

² Schlicht, Beitrag zur Kenntniss der Verbreitung und Bedeutung der Mycorhiza. Inaug. Diss. 1889.

nucleus because that substance is present there in the optimum proportion in that cell. Miyoshi showed that the attractive action of a solution varies with its concentration, there being an optimum strength, but the repellent action of a solution which attracted when dilute only sets in at high concentrations. The question arises as to the source of this chemotropically active substance in *Thismia*. Obviously it is not conducted along the hyphae themselves, so it must be absorbed from the cell in which the hypha lies. It must therefore be either derived from cells lying outside, or be manufactured in the cell in which the hypha actually lies. I shall endeavour to show that the latter is the case. In the first place, if the substance came from cells lying exterior to the mediocortex or even exterior to the exocortex, we can conceive of no reason why the hyphae should penetrate these deeper tissues at all. On the other hand, we should expect to find the cells outside would be most richly supplied with hyphae and the deeper cells successively poorer in hyphae. The reverse is actually the case; every cell (excepting raphide-mucilage cells) from the exocortex to the inmost limit of the mediocortex contains hyphae, whereas comparatively few cells of the sheath have hyphae. Thus the chemotropic action of the *cells* is weakest in the sheath and strongest in the cortex. In the second place, inside a single cell the chemotropism towards the *nucleus*, as judged by the curvature of the hyphae towards the nucleus, is weakest in the sheath, and strongest in the mediocortex, whilst the exocortex forms a layer transitional in this respect. In the third place, it would be apparently contrary to the laws of osmosis that a liquid absorbed from outside a cell should accumulate in greatest concentration in the neighbourhood of the nucleus. But this is not a conclusive argument, because in plants we often find liquids distributed in a manner apparently in opposition to physical laws (e.g. sugar in nerve-parenchyma of leaves).

Thus we are driven to conclude that the *chemotropically active substance attracts the hyphae, and is manufactured in the cell infected, and particularly in the vicinity of the nucleus of*

that cell ; and that this substance is constructed most feebly in the sheath, and most vigorously in the mediocortex.

But the influence of the nucleus of the host-cell is marked in another direction. Near it, in the mediocortex and exocortex, the bladders with their rich proteid contents form ; that is, there is abnormal thickening of the hyphae. Miyoshi, in the paper already quoted, shows that increasing the concentration of the nutritive liquid (which also acted chemotropically) causes a corresponding increase in the thickness of the hyphae. This at once rouses the obvious suggestion that in the mediocortex the protoplasmic bladders form near the nucleus of the cell, because it is at that point that the essential nutritive solution is most concentrated. Comparing the cells of the mediocortex and of the sheath, the effect of the position of the nucleus on the thickening of the hypha is greatest in the former and least in the latter. And in the mediocortex there is evidence that the substance absorbed from the host-cell, leading to the formation of protoplasm, is present in largest quantity in the mediocortex, and in smallest quantity in the sheath ; for the hypha in the sheath does not branch and scarcely thickens, but in the mediocortex great absorption and thickening of the hyphae take place. Hence, adopting the same line of argument as was used with reference to the chemotropically active substance, the conclusion is reached that *for their thickening and the manufacture of protoplasm the hyphae are dependent upon supplies of a nutritive substance manufactured by the infected cell, and particularly in the vicinity of the nucleus of that cell ; and that this substance is constructed most feebly in the sheath, and most vigorously in the mediocortex.* In this respect, too, the exocortex is transitional between the sheath and mediocortex in that a hypha, having entered the cell, does not at once pass out, nor does it describe sharp curves, but forms broad sweeps and slow curves round the nucleus, and in addition to undergoing general thickening (contrast mediocortex) it exhibits slight local dilatations (contrast sheath). These last are formed presumably at points which once were actually nearer the cell's nucleus, or physiologically so

in virtue of being the points at which the cytoplasmic strands connecting the hypha and nucleus attached themselves to the former.

It will be seen that the chemotropically active substance and the substance which is absorbed as food by the hyphae have the same distribution, and are both manufactured in precisely the same spots and in the same proportion. This at once suggests that the two are identical, that one substance causes both effects. However this may be, the theory here given of the behaviour of the hyphae leads to the conclusion that the cortex and the sheath are strongly contrasted as regards their metabolic processes; that in particular the cortical cells manufacture certain substances, or a substance, lacking nearly or entirely in the sheath. This contrast is indeed a matter of fact. For the young cortical cells contain a rich store of starch which only disappears when the hyphae enter, and which may reappear when the hyphae die: whilst the sheath-cells are always devoid of starch; or occasionally some of the cells of the innermost layer of the sheath possesses starch; and, precisely corresponding with this fact, it is not rare to find some of these innermost cells of the sheath possessing hyphae exactly like those of the exocortex, in which case the nuclei of these cells are larger and more deeply staining than the cells with only straight hyphae. Again, the sheath-cells are poor in protoplasm, but the cortical cells have an ordinary amount.

The behaviour of the mycelia, then, strengthens the view that *the nucleus of a cell is the centre of certain metabolic changes*; and, conversely, any observations tending to prove this action of the nucleus render the explanation above given more worthy of credence. Klebs' observations, though not confirmed as of general significance by Palla and Acqua, show that the manufacture of one carbohydrate—the cell-wall—is influenced by the nucleus. Further, he demonstrated that in the leaves of *Funaria hygrometrica* pieces of protoplasm devoid of a nucleus did not make starch, though they were capable of assimilating. In young cells of higher plants the chromato-

phores seem always to aggregate round the nucleus, and starch therefore frequently appears first in this circumnuclear region. So there is evidence that in plant-cells the manufacture of solid carbohydrates is influenced by the nucleus. But Demoor, by the use of chemical substances (chloroform) and by intense cold, succeeded in producing in *Spirogyra* a peculiar condition of the cell, in which the nucleus divided, but the cell-wall was not formed between the two nuclei. However this observation does not prove that the nucleus was the only active part of the protoplasm, nor does it necessarily imply, on the other hand, that we must ascribe to cytoplasmic activity any initiatory share in the formation of the cell-wall. Haberlandt showed as a matter of fact that the nucleus of plant-cells often wanders towards that part of the cell-wall at which irregular thickening is taking place; and this observation seems of more value than those in which the protoplasm was brought into a pathological condition by excision of the nucleus or use of abnormal stimuli. Animal physiologists have also conducted observations which have led them to conclude that the nucleus influences, or even controls, the metabolism of a cell in some directions (processes of secretion of calcium carbonate, mucilage, and animal cuticle ¹).

To sum up: *the distribution, form, and mode of development of the mycorrhizal hyphae of Thismia are dependent on their constant chemotropic character, on the location of the cell infected, and on the metabolic processes taking place in that cell, particularly near its nucleus.*

And doubtless this generalization holds, at any rate for orchids and Marattiaceae. For in the mediocortex the mycelia only differs from those in *Thismia* in that numerous slender hyphae grow out from the primary bladder, and in the subsequent changes said to occur in these hyphae.

¹ Max Verworn, *Allgemeine Physiologie*, contains references to all the papers quoted. M. Verworn puts forward the view that the nucleus influences the metabolism of a cell in a manner analogous to a chloroplast. See his article *Die Physiologische Bedeutung des Zellkerns*, Pflügers Archiv, Bd. li. pp. 1-118.

In most saprophytes the hyphae of the endotrophic mycorrhiza do not enter parts of the shoot which are not absorbing. This is presumably because the chemotropically active substance, if present at all, is only extremely dilute and rapidly consumed by the host. If this view be correct we might expect in *Thismia* that any mycorrhizal hyphae entering the inflorescence-axis would assume the form of the sheath-hyphae. This is in fact the case, as was mentioned earlier in the paper. Further, in Fig. 3, it can be seen that, as the cortex of the thallus approaches continuity with the parenchyma of the primordium of the inflorescence-axis, the hyphae in the limiting layer of the former assume the characters of the exocortical hyphae: and the hyphae in the exocortex become straight. Employing a high-power objective it could be further seen that at the base of this primordium of the bud, in the cells continuous with the medicortex, the hyphal-bladders became fewer and the hyphae more uniform. These facts, I think, dismiss the suggestion which might be made, that the different behaviour of the hyphae in the various layers of the thallus is due, not to any distinction in the metabolism of the cells, but to the circumstance that, as the hyphae penetrate the deeper tissues, they may become more irritable to chemotropic stimuli.

Physiological Significance of Endotrophic Mycorrhiza.

The precise source of the foods of guest and host in mycorrhiza has hitherto not been ascertained, neither has proof been given of any reciprocal interchange of nutritive substances between the two. The large dimensions of the hyphae in *Thismia* and their feeble branching in a cell rendered them peculiarly suited for such observations. Hence some comments on the physiological significance of mycorrhiza may be of interest, particularly as the conclusions drawn differ considerably from those taught by Frank, who has recently devoted much attention to the subject.

Frank gives two entirely different interpretations of the significance of the two forms of mycorrhiza—ectotrophic and

endotrophic. With regard to the ectotrophic mycorrhiza, he appropriates Kamienski's theory that the Fungus prepares food for the host; and in particular supposes that the Fungus assimilates, partly for the benefit of the host, humous compounds. But the endotrophic Fungus he regards as a living organism captured by the host. He says¹, 'Denn der Pilz ist hier gleichsam in den Wurzelzellen gefangen, wo er als sichere Beute zuletzt von der Pflanze aufgezehrt wird. Die Erscheinung entspricht, mutatis mutandis, genau dem Insectenfang der sogenannten insectenfressenden Pflanzen, und wir können daher die endotrophen Mycorrhizen als *Pilzfallen* und die betreffenden Pflanzen als *pilzverdauende Pflanzen* bezeichnen.' He then goes on to say that it is probable that the hyphae receive the whole of their nutriment directly from the external substratum, not from the host. His theory, or rather definite statement, is based upon observations made on roots of *Orchis*. He states that in the cortex the protoplasm of the hyphal clumps is drained out of the hyphae, and all the proteids resulting pass into the cells of the host; and that finally the hyphal clump consists solely of the walls of the hyphae. His evidence for these statements is that with increasing age the hyphal clumps gradually lose their power of staining with anilin-blue. Admitting this diminution of staining power and that it is due to a disappearance of proteid, still Frank fails to exclude the possibility that the proteid might be converted into cell-wall or into additional yellow excretion; nor does he show that the proteid in older parts might not have been conducted away along the slender portions of the hyphae to younger hyphae, as is often the case with the hyphae of any ordinary mycelium. Still it is quite possible that Frank may be correct in his assumption, though not in the dogmatic expression of it as a proven fact. But with regard to his analogy of endotrophic mycorrhiza with an insectivorous plant some remarks are called for. A captured insect derives all its food from the outside world

¹ Frank, Lehrbuch, p. 267. See literature given also.

and none from its captor; and further it is entirely consumed by the latter, nor has it a chance afforded of propagating its species after capture. Do these two conditions hold for the endotrophic Fungus?

With reference to the absorption of food, it has been shown earlier in this paper that the *hyphae absorb food manufactured by the cortical cells in the mycorrhiza of Thismia*, and that this absorption by the hyphae is accompanied by a large increase in their protoplasm. Now the hypertrophied hyphae (in the cortex, and occasionally in the inner cells of the sheath) are only found in cells which, before the hyphae entered, contained starch. When the hyphae penetrate these cells the starch disappears, and does not reappear in them till there is evidence that the hyphae cease, or almost cease, manufacturing protoplasm. In the mediocortex, as bladder after bladder forms in a cell, starch remains absent, but when the formation of new bladders stops and the hyphae all die, starch may reappear¹. These facts tend to show that the *starch disappears and remains absent because the carbohydrates are being consumed in the production of proteids*, and not because the cell ceases to be able to manufacture carbohydrates. But this does not imply that the soluble carbohydrate (sugar) is absorbed as such by the hypha. It may be that the hypha merely causes more vigorous osmotic currents to the cell which entertains it, and thus brings a larger supply of nutritive material, which with the carbohydrate forms proteid in the cell. Or it is possible that the sugar is directly absorbed by the hypha, and the proteid built up in the hypha. Both soluble carbohydrates and soluble proteids act chemotropically on fungal hyphae. But whether it be proteid or simply carbohydrate (sugar) which is manufactured near the host's nucleus and is then absorbed by the hypha, the co-operation of the cell and hypha has three effects. First, as evidenced by the increased size and staining

¹ I have noted the same fact in orchidaceous mycorrhiza, that starch appears in the old cells of the mediocortex when the hyphal clumps are dead. So Frank is incorrect in saying that starch is not present in cells containing the fungal hyphae.

powers of the nucleus of the cell¹, there is an *increase in the metabolic activity of that cell*. Secondly, there is a sudden *rise in the assimilation of nitrogen which exhibits itself in the rapid synthesis of proteids*. Thirdly, the *carbohydrate manufactured by the host is concerned in the formation of proteid in the mycelium*.

After a time the protoplasm of the hypertrophied bladder in the mediocortex diminishes in amount; and, *pari passu*, there is a deposition in the bladder of a yellow mass with rod-like bodies. This yellow mass with the bodies is absolutely useless to the host; for, as the mycorhiza decays, these masses remain unaltered though the protoplasm of the dying host-cells is conducted away, and at the exposed and disintegrated surface of the decayed mediocortex the yellow masses may be recognized. Hence the *protoplasm of the hyphae in the mediocortex is partially broken down into resistant excreta absolutely useless to Thismia*. As the protoplasm of the bladder is vanishing and the yellow mass appearing, the bladder shrinks and its wall collapses. A liquid therefore leaves the bladder. Now evidence has been given earlier in this paper that the liquid is not conducted away along the slender portions of the hyphae, because they die soon and are occluded, and because they always are slender in calibre. Hence it must be concluded that the *moribund mycelium pours a liquid into the host-cell*. As to the nature of this liquid one cannot do more than guess.

Thus it is established that in the mediocortex of *Thismia* there is an interchange of material between Fungus and host, and that that material is manufactured by the two symbionts respectively. In the Orchidaceae, in *Paris*, Marattiaceae, &c., doubtless there is likewise an absorption on the part of the hyphae of substance manufactured by the host; for there are indications of the effect of the nucleus of the cell on the

¹ Compare the researches of animal physiologists in showing that the size and staining power of a nucleus is a good index of the metabolic activity of that cell (Heidenhain on secretory cells, Hodge and G. Mann on nerve-cells).

growth of the hyphae, as there are indubitable proofs of the influence of the hyphae in leading to an increase in the size and staining powers of the nuclei. So there is no reason to doubt that the symbiosis in the medicortex of these plants has the same significance as in *Thismia*.

To sum up, then. *Although the hyphae of endotrophic mycorrhiza in the medicortex die soon, the root (or rhizome) cannot be said to act like the digestive organ of an insectivorous plant, because the protoplasm of the hyphae is manufactured partly at the expense and through the agency of the host; and, further, there is, at present, no direct evidence that the hypha renders its proteid contents to the host.*

The second point with reference to Frank's analogy may be now considered. Is the organism (Fungus) completely killed by the host (root or rhizome)? The evidence all seems to point in the other direction. In all the Orchidaceae and Burmanniaceae I have examined, in all the cases of orchidaceous saprophytes investigated by others, and in endotrophic mycorrhiza generally, it appears that there are in the outer layers of the absorbing organ hyphae which live as long as the organ itself. They are many of them continuous with hyphae entirely outside the host, and extending out into the substratum. The number and development of these hyphae extending outside the plant varies much in different plants, often being inconsiderable (*Thismia* and some Orchids). It seems probable, therefore, that Frank is correct in regarding these free hyphae as not of supreme importance in supplying nutriment to the mycorrhiza, though they often ramify closely over dead vegetable fragments (*Thismia*). In *Thismia*, in particular, the whole surface of the thallus appears capable of absorbing liquids; and here also the existence of a sheath renders possible the observation that *frequently the free hyphae are deserting the host, not entering it, a fact which seems to give the key to the puzzle.* In all the cases of saprophytes with endotrophic mycorrhiza which I have observed, the free external hyphae can be traced continuously from the substratum into cells capable of manufacturing

starch. In *Thismia* they continue from the exterior into the exocortex with undiminished general calibre. From this layer no plastic material can be conducted along and inside the hyphae to the dead mediocortical hyphae. On the other hand, food can easily be transported along the wide hyphae towards the exterior. Plastic material is undoubtedly being continuously absorbed from the host by the exocortical hyphae, for starch does not appear in the infected cells (though it frequently is found in the limiting layer cells, in which the bladders still have their dense protoplasmic contents). Hence it is safe to assume that *the exocortical hyphae act as haustoria for the benefit of the hyphae lying in cells outside them*. These external hyphae, then, derive from the host a considerable amount of nutriment, which enables further growth into the substratum outside the host. This method of regarding the significance of the hyphae of the sheath and exocortex is strongly supported by additional facts referring to *Thismia*. As was before stated, the old end of a thallus gradually decays. As the parts die the cells lose their turgidity and collapse, so that the whole organ, in that region, shrivels to a mere thread. In such disintegrating parts proteid contents may be seen in the exocortical hyphae, even after the death of the cells which entertain them, and subsequent to the complete disappearance of the proteid contents of those cells. But these hyphae eventually die and their walls become thick and glistening. The hyphae of the sheath die still later, and in dead parts of the thallus living hyphae may be traced continuously from them to the outside of the plant. In these dying and dead parts I found numerous cells, particularly superficial cells, crowded with fungal spores produced by hyphae which could be traced into the deeper layers of the sheath, and also were continuous with hyphae ramifying over the surface of the organ. These hyphae were indistinguishable from the normal mycorrhizal hyphae, excepting that they did not run straight in a longitudinal or longitudinal-oblique direction in the sheath. In spite of the fact that my sections showed the two sets of hyphae coming close together, I could

not actually establish their continuity. Hence I cannot positively assert that the spore-producing hyphae belonged to the mycorrhizal Fungus, yet there seems little doubt that such was the case. If the sporogenous hyphae were really a part of the mycorrhizal mycelium, their irregular direction of growth must be attributed to the removal of the directive influence of the host-cells and to the breaking down of the protoplasm of the latter. If, on the other hand, the sporogenous hyphae belong to some other Fungus which could not enter the thallus as a parasite till the latter had already lost some of its vitality and the mycorrhizal hyphae were already weakened, then the obvious analogy between the symbiosis of mycorrhiza of *Thismia* and phagocytosis becomes still more marked. In *Galeola javanica* I further saw some of the superficial cells packed with similar spores. Wahrlich observed and figured spores, just like those in *Thismia*, in the velamen of Orchids infected with mycorrhizal hyphae; and further was able to prove that they were produced by segmentation of the hyphae and rounding off of the cells (i. e. this represented the oidium-stage of life-history), as I also believe was the case in *Thismia*. But Wahrlich makes no definite statement that he actually observed the continuity between the mycorrhizal hyphae and these spore-producing hyphae, though one reading his paper would gather that he had seen such a connexion. Mollberg also saw similar spores in the mycorrhiza of *Platanthera* and *Epipactis*. Kühn detected, inside Marattiaceous mycorrhiza, some thick-walled spores. Schacht, Reissek, and Wahrlich obtained *Fusisporium*-spores from cultures of orchid-mycorrhiza; and I saw these *Fusisporium*-spores on every thallus of *Thismia*. However, apart from this suggestive, though not conclusive, evidence of spore-production by the mycorrhizal hyphae, there is quite sufficient proof that the *endotrophic Fungus is not wholly destroyed, but on the contrary there is strong reason for believing that in the outer layers of the absorbing organ it actually profits by the symbiosis.*

Hence there is no justification for giving the misleading name of fungus-trap (*Pilzfalle*) to mycorrhiza, or for referring

to the host as a fungus-digesting plant (*pilsverdauende Pflanze*).

Having dismissed the first part of Frank's view as to the biological significance of endotrophic mycorrhiza, the second question arises, 'Is there any sufficient reason for his assumption that the physiological meaning of the endotrophic is different from that of the ectotrophic mycorrhiza?' Three series of facts all point in the same direction in answer. First, all known holosaprophytes (with one exception?) possess mycorrhiza; but it may be either ectotrophic (*Monotropa*, &c.), or endotrophic (Orchids, &c.). Secondly, in Ericaceae, Epacridaceae, &c., though the mycorrhiza is endotrophic, the hyphae do not penetrate deeper than the superficial cells of the root. This type may be regarded as affording a transition-stage between the complete endotrophism of Orchids and *Thismia*, and the ectotrophic condition of *Monotropa*, forest-trees, &c. Thirdly, in endotrophic mycorrhiza it is often the case that many hyphae radiate out into the substratum; on the other hand, in the ectotrophic mycorrhiza, hyphae frequently penetrate the superficial cells of the host's root (at any rate in older parts of the root); and in the ectotrophic mycorrhiza of *Pinus* roots, which is occasioned by *Polysaccum*¹, some of the hyphae actually dip deep into the tissue of the root, at the same time absorbing so vigorously as to play havoc with the infected tissues. Thus in ectotrophic mycorrhiza the hyphae are not always epiphytic, nor in endotrophic mycorrhiza are they exclusively endophytic.

Hence the distribution of the two forms of mycorrhiza and the occurrence of transition-stages between their extreme forms militate against the view that the physiological significance is not the same in both. They both probably work in one general constant manner. Mycorrhiza is, then, either a highly adapted and symbiotic community beneficial to both symbionts, or it is a pure matter of infection of a plant by a Fungus, and there is a constant struggle between host and the would-be parasite.

¹ E. Bruns, Beitrag zur Kenntniss der Gattung *Polysaccum*. Flora, 1894, pp. 67-75.

At present the weight of evidence seems to lie on the side of the symbiotic view. In favour of it are Frank's rough observations on forest-trees deprived of the Fungus, and the facts given with reference to *Thismia* showing that there is a mutual interchange of material. The distribution of the hyphae, however, might as readily be explained on the infection-view as on the symbiotic theory, now that it has been shown, at any rate in endotrophic mycorrhiza, to be as largely a matter of chemotropism.

Viewing the mycorrhiza of *Thismia* as a case of symbiosis between host and Fungus, it will be seen that there is one point of strong similarity to the symbiosis between low Algae and nitrogen-fixing Bacteria, and to the relation between the Fungus of leguminous tubercles and the host, namely, that there is an increased assimilation of nitrogen and manufacture of proteids. In his beautiful piece of work on a nitrogen-fixing Bacterium, Winogradski showed that the amount of nitrogen fixed was proportional to the amount of dextrose supplied. Transferring this idea to the case in which Bacteria and Algae together fix free nitrogen, it seems fair to conclude that the Alga supplies the carbohydrate. Again, leguminous plants may be cultivated in ordinary water-cultures and tubercles develop. Here the carbohydrate is indubitably supplied by the host, and Professor Vines' experiments showing that adequate illumination was essential to ensure the development of tubercles are thus explicable¹. With regard to ectotrophic mycorrhiza on green plants, there is no evidence that the Fungus absorbs carbohydrates from the host, though there is the collateral evidence in green Orchids that in endotrophic mycorrhiza carbohydrates are absorbed (cp. remarks on *Thismia*). It is easy to comprehend the advantage of this arrangement accruing to a mycorrhizal Fungus on a green plant which can assimilate carbon dioxide. But does the

¹ Professor Vines informs me that he has found that when Beans are germinated and grown in the dark, tubercles are developed on the roots of the seedlings: it would appear that, in this case, the necessary carbohydrate is supplied from the reserves in the cotyledons.

same hold for hosts which have no chlorophyll? Now Acton¹ has shown that certain carbohydrates and bodies like carbohydrates, including extract of humus, can be absorbed by roots of ordinary green flowering-plants and assimilated. Combining Acton's results with those of Boehm and Meyer, we assume that this assimilation is absolutely independent of light or chlorophyll. So it is *a priori* probable that flowering-plants devoid of chlorophyll can also utilize such organic compounds to supply themselves with carbohydrates, and in particular to build up starch. In this paper I show that the Fungus in the holosaprophytic *Thismia*, in fact, does derive its carbohydrate, largely and possibly entirely, from its host. Altogether there is much to indicate the probability that in all cases of symbiosis between a Fungus (including Bacteria) and another plant, the Fungus receives carbohydrates from its symbiont.

Again, we know that Fungi (including Bacteria) can readily utilize unoxidized or feebly oxidized compounds of nitrogen (NH_3 , HNO_2) and sulphur (H_2SO_3 , $\text{H}_2\text{S}_2\text{O}_3$), which are less easily, or not at all, assimilable by green plants; and on the other hand that Fungi wholly or partially lack the power of employing nitrates, or to less degree sulphates, as food. In the cases of symbiosis of Bacteria and Algae, and in the leguminous tubercles, there is, despite of Frank's researches, sufficient reason for the belief that the fixation of free nitrogen does not take place in the absence of the Bacterium or Fungus. This fact, together with the sudden increase of assimilation of nitrogen as shown in *Thismia*, suggests that in symbiosis the Fungus always absorbs, for the benefit of the community, unoxidized or feebly oxidized nitrogenous bodies which are not easily worked up by the host. This would explain the utility of mycorrhiza to plants growing in the shade of the forest or devoid of chlorophyll, and with their absorbing organs dipping in humus. Fresh humous bodies are characterized by their poverty in nitrogen of any sort; and what is

¹ Acton, The Assimilation of Carbon by Green Plants from certain Organic Compounds: Proc. Roy. Soc., vol. xlvi, p. 118, 1889.

present is in the form of ammonia and feebly oxidized organic compounds. And, again, Schimper's¹ observations show that the reduction of nitrates, sulphates, and possibly phosphates, by higher plants is dependent on the co-operation of light and chlorophyll. Further, the suggestion that the Fungus is supplied direct from the substratum with its nitrogen in the form of feebly oxidized nitrogenous bodies finds support, I think, from Professor Vines'² observations showing that the development of tubercles in the Leguminosae is inversely proportional to the amount of nitrate supplied to the plants. Here the nitrate is easily assimilated by the well-lighted leguminous plant itself, and is rapidly conducted away from the roots, whereas it is probable that the Fungus, like a typical Fungus, does not readily accept nitrates as food³.

But I hope soon to publish some experimental results confirming or disproving these hypotheses.

In conclusion I desire to express my thanks to Mr. H. N. Ridley for the material used in this investigation, and for the coloured illustration of the whole plant, which was drawn by the Singapore artist De Alwis; also to Professor Vines for the continued hospitality which permitted the carrying out of this research in the Botanical Laboratory of the University of Oxford.

¹ A. F. W. Schimper, Zur Frage der Assimilation der Mineralsalze durch die grüne Pflanze. *Flora*, 1890, p. 207.

² S. H. Vines, On the Relation between the Formation of Tubercles on the Roots of Leguminosae and the Presence of Nitrogen in the Soil. *Annals of Botany*, 1888, p. 386.

³ Lawes & Gilbert suggest, too, that ectotrophic mycorrhizal hyphae enable the plant infected to acquire nitrogen otherwise not easily assimilated by the plant.

EXPLANATION OF FIGURES IN PLATES XIII AND XIV.

Illustrating Mr. Groom's paper on *Thismia Aserae* (Beccari) and its Mycorrhiza.

Abbreviations.—*e.c.* = exocortex. *en.c.* = endocortex. *end.* = endodermis. *l.l.* = limiting layer. *m.c.* = mediocortex. *p.c.* = pericycle. *ph.* = phloem. *ph.s.* = sieve-tubes.

Figs. 1-16. Illustrations of the structure of the thallus, or absorbing organ.

Fig. 1. Showing base of inflorescence-axis (*f.a.*) $\times 4$.

Fig. 2. Longit. section rendered slightly diagrammatic. (Zeiss A. Oc. 4, then reduced to $\frac{1}{2}$.)

Fig. 3. Trans. sect. showing endogenous origin of inflorescence-axis rendered slightly diagrammatic. (Zeiss Apo. 16 mm. Comp. Oc. 4.)

Fig. 4. Longit. median section of growing-point. (Zeiss Apo. 8 mm. Comp. Oc. 8, then reduced to $\frac{1}{2}$.)

Fig. 5 *a.* Trans. sect. of central cylinder. (Zeiss D. 3, then reduced to $\frac{1}{2}$.)

Fig. 5 *b.* Trans. sect. of portion of 5 *a.* (Zeiss D. 3.)

Figs. 6-11. Successive stages of development of hyphae in cells of mediocortex : longit. sect. (Fig. 9. Zeiss D. 3, all the rest Zeiss $\frac{1}{4}$ oil. Oc. 2.)

Fig. 12. Cell of exocortex before entrance of hypha : longit. sect. (Zeiss $\frac{1}{4}$ oil. Oc. 2.)

Fig. 13. Ditto shortly after penetration of hypha. (Magn. ditto.)

Fig. 14. Longit. sect. of 2 cells of exocortex representing the third and fourth stages of development of the hyphae. (Zeiss $\frac{1}{4}$ oil. Oc. 2.)

Fig. 15. Longit. sect. showing a cell of exocortex with hyphae not far from maturity, and two cells of the limiting layer representing the third and fourth stages of the hyphae. (Zeiss $\frac{1}{4}$ oil. Oc. 2.)

Fig. 16. Longit. sect. showing the first and second stages of development of the hyphae in two cells of the limiting layer. (Magnification !)

Fig. 17. Trans. sect. of the central cylinder of the inflorescence-axis. (Zeiss D. 3, and subsequently reduced to $\frac{1}{2}$.)

Fig. 18. Trans. sect. of part of staminal tube, showing lobes forming an arch over a nectary.

Fig. 19. Whole plant, showing its habit and the substratum of decaying leaves. (Nat. size. Drawn by De Alwis.)

Fig. 20. View of the staminal tube from the outside after the removal of the perianth-tube. (Magnified. Drawn by Mr. A. H. Church.)



NOTE.

SPORE-FORMATION AND KARYOKINESIS IN HEPATICAE.—In pursuing a series of investigations on spore-formation in the Hepaticae, I find the existence of a quadripolar spindle in the early stages of the division of the spore-mother-cell to be a more widely spread occurrence than I had previously supposed when writing on *Pallavicinia*¹.

Two species of *Fossombronia* exhibit this curious spindle in a marked degree. The first sign of the division of the nucleus of the cell in question does not occur until the latter has assumed the lobed character which is common to the *Jungermannia*-series of Liverworts. The initial phase of mitosis is marked by the appearance, on the periphery of the nucleus, of four beautiful centrospheres with their attendant radiations. Thus a four-armed spindle arises. But the division of the nucleus is not a simultaneous partition into four daughter-nuclei; *two* daughter-nuclei are first formed, and each of these again divides once more. Essentially the same process takes place in *Aneura*. In *Pellia* a well-marked cell-wall is formed during the first of the two mitoses, but otherwise there is a substantial agreement between the three forms just mentioned.

In those *foliose* Jungermannieae in which I have succeeded in following out the details of spore-formation, I have seen a quadripolar spindle in a few instances; a normal double division in any case takes place. There exists a considerable range of variation amongst the various forms, as to the degree of rapidity with which the two mitoses follow on each other.

In the alliances of the Marchantieae and Riccieae, the form of division of the spore-mother-cells differs considerably from the corresponding process in those Jungermannieae, both foliose and frondose, which I have examined. The cell never becomes four-lobed, and a rapid

¹ Annals of Botany, Vol. ix, p. 35, 1894.

double division of the nucleus occurs within it, with no attendant formation of cell-walls. The four nuclei which have arisen in this way take up equidistant points near the periphery, and a tetrahedral division of the entire cell then occurs. The original spherical (*Riccia*, *Riella*, *Targionia*, *Marchantia*, *Plagiochasma*) or flattened (*Fegatella*) contour of the spore-mother-cell is retained until the spores separate.

There are two specially important features which are characteristic of the karyokinesis of the spore-mother-cell. First, that the number of chromosomes is in every case reduced to one half, as compared with the antecedent mitoses in the sporophyte; and that this reduced number is thenceforth retained in at any rate all those mitoses in the gametophyte which I have been able to feel confident about. Secondly, that the mitosis resulting in the formation of the spores differs from all the archesporial and vegetative mitoses in its character, and conforms to that type which Flemming distinguished as 'Heterotypic.'

A third feature of some interest, and which in practice is specially noticeable, is that, just at the period of the spore-formation, it becomes exceedingly difficult to fix the cells without contraction. This is the more remarkable, since the nuclei which may happen to be dividing in either earlier or in later stages, present not the slightest difficulty. Moreover the cytoplasm also stains deeply with most nuclear stains, and everything points to the conclusion that there is something going on in the cell during this so-called 'reduction-division,' which is not met with at any other period, whether in resting or dividing cells.

The above points are only intended to indicate the general results at present obtained during these researches. The details, together with a general discussion on them, will shortly be published *in extenso* in this periodical.

J. BRET LAND FARMER.

ROYAL COLLEGE OF SCIENCE,
LONDON.

On the Influence of Sudden Changes of Turgor and of Temperature on Growth.

BY

RODNEY H. TRUE, B.S., M.S.

ALTHOUGH growth, as influenced by external conditions, has received much attention from plant-physiologists, a detailed study of the effects called forth by sudden change in these conditions has not yet been made.

The object of the investigation yielding the results given in the following pages was to ascertain more accurately the effects on growth brought about by sudden changes of turgor and of temperature. For the sake of convenience, the subjects will be treated separately.

I. THE EFFECT OF SUDDEN TURGOR CHANGES.

Historical.

Cohn¹ seems to have first called attention to the effect of sudden changes of the concentration of the substratum upon organisms living in it. He found that either too rapid an increase or decrease of the concentration of the medium injured or killed Infusoria present, and he regarded the source of the injury to be the endosmotic processes taking place in the bodies of the animals.

Strasburger² noted a very similar action in the case of swarm-spores.

¹ F. Cohn, *Entwicklungsgeschichte der microscopischen Algen und Pilze*. Nova Acta Akad. Caes. Leopold. Bd. XXIV (1854), Th. i, p. 132.

² E. Strasburger, *Wirkung des Lichtes und der Wärme auf Schwarmsporen*. Jenaische Zeitschrift für Naturwissenschaften, Bd. XII (1878), p. 66.

[*Annals of Botany*, Vol. IX. No. XXXV. September, 1895.

In experiments with plasmodia of *Aethalium septicum*, Stahl found that sudden changes of medium involving even as slight a difference as 0.25 - 0.5 per cent. sugar were sufficient to fatally affect those parts of the plasmodia which were in contact with the solution. Stahl¹ regarded the results seen as complicated phenomena of protoplasmic irritability.

Experiments involving similar changes of substratum have been made with Algae.

In studying the effects of a rapid increase or decrease of the salt-contents of the medium on marine Siphoneae, Noll² found that the turgor-change in a *mechanical* way could even endanger the life of the organism. By suitable change of concentration, he found that the turgor-increase could be sufficient to rupture the cell-membrane.

When *Fucus* was treated in a similar manner, Oltmanns³ found that internal injury was produced, the medium becoming discoloured, probably by the colouring matter from the cells of the Alga. If the plants were not fatally injured, accommodation to the new medium took place, followed, after a time, by the return of normal growth.

Richter⁴ extended the study to fresh-water Algae, and obtained essentially like results.

Very similar results were earlier obtained by Eschenhagen⁵ in experiments made with moulds. A sudden transfer from one solution to another of sufficiently different sugar-content proved fatal, the bursting of the hyphal lips occurring as in the Siphoneae observed by Noll. If a less violent action took place, the hyphae assumed abnormal forms, but as accommodation became complete the usual shape and growth

¹ E. Stahl, Zur Biologie der Myxomyceten, Bot. Zeit., 1884, p. 145.

² F. Noll, Beitrag zur Kenntnis der physikalischen Vorgänge, &c. Arb. d. bot. Inst. in Würzburg, Bd. III (1888), p. 496.

³ F. Oltmanns, Ueber die Bedeutung der Konzentrationsänderung des Meerwassers für das Leben der Algen. Sitzb. d. Königl. preuss. Akad. d. Wissensch. zu Berlin, 1891, p. 193.

⁴ A. Richter, Ueber die Anpassung der Süßwasseralgen an Kochsalzlösungen, Flora, 1892, p. 4.

⁵ F. Eschenhagen, Ueber den Einfluss von Lösungen verschiedener Concentration auf das Wachsthum von Schimmelpilzen. Dissertation, Stolp, 1889.

were resumed. The causes here active receive further mention below.

Regarding the results of investigations made with higher plants, we find it noted by de Vries¹ that the growth of roots of seedlings and of stems in a 3 per cent. solution of NaCl was greater during the first twenty-four hours than during the like period immediately following. He further observed that the effect of a sudden change of turgor in the cells of certain flower stalks was similar to that noted in the Siphonaeae and in the moulds. Upon washing out the tissues under the microscope, after five hours in a 7 per cent. KNO₃ solution, many of the protoplasts were seen to burst before coming into contact with the cell-wall.

Stange² observed that sudden changes of medium were fatal to roots of *Vicia Faba*, *Pisum sativum*, and *Lupinus albus* when the extremes of concentration involved were sufficiently removed from one another. Root-hairs were burst as a result of turgor-change.

From the observations cited, it appears that the condition of protoplasm and its rate of growth are more or less affected by a sudden change of the concentration of the substratum. In the cellular plants, as a result of the withdrawal of water from the cell-sap by an external solution of greater osmotic activity, the turgescence of the cells is diminished, and for mechanical reasons growth is either reduced or is stopped. On the other hand, a sudden increase of the water supply to a plant that has accommodated itself to a high concentration, causes the cells to take up water from the more dilute medium until an equilibrium is established. Thus the turgor pressure is increased, and an elongation due to this mechanical cause takes place, or tends to take place. It follows that the change of concentration must involve a certain minimum of difference, in order to call forth a noticeable change of length. The

¹ H. de Vries, Untersuchungen über die mechanischen Ursachen der Zellstreckung. Leipzig, 1877, p. 58.

² B. Stange, Beziehung zwischen Substratconcentration, Turgor und Wachstum bei einigen phanerogamen Pflanzen. Bot. Zeit. 1902, p. 253.

magnitude of this minimal difference varies according to the properties of the membrane and of the protoplast.

From the above cited investigations, it seems that two kinds of results have been found to follow sudden changes of concentration. In the rupture of cell-membranes seen in the moulds and Algae, we have extreme cases of the mechanical effect of a sudden increase of turgor.

In the Myxomycetes, in which those tensions arising from the presence of a cell-membrane are done away with, we find the protoplasm free to respond by means of irritation movements. That, in the cellular plants, also, results due to the irritable nature of the protoplasm may likewise be present, but obscured more or less by the striking physical phenomena, is not to be forgotten. It would, indeed, seem probable that such is the case. It would, furthermore, be expected that these irritation-modifications would, in one way or another, find expression in the growth-rate, since this is the resultant of so many factors, and is, in so many directions, open to change-producing influences. The evidence bearing on this point is very incomplete. Oltmanns¹ and Eschenhagen² found a decreased rate of growth to follow sudden changes of the concentration of the substratum, but no systematic measurements show the extent or duration of such retardation.

Materials and Methods.

For the purposes of this investigation, the radicles of young seedlings were selected as the most desirable objects; and, owing to their superior ability to withstand the hard conditions necessarily offered in these experiments, those of *Vicia Faba* were generally used. *Pisum sativum* and *Lupinus albus* were used as objects for comparison. The seeds were soaked in water until swelled, and for further germination were placed in sawdust and kept at the ordinary room-temperature. After 40 to 45 hours, when the radicles were from 17 to 35 mm. long, they were ready for use. In the investi-

¹ Oltmanns, loc. cit., p. 194.

² Eschenhagen, loc. cit., p. 35.

gation only those specimens were used which, by at least an average growth, indicated a normal condition.

As the osmotically active agent, potassium nitrate in accurate solutions was used. By means of pieces of cork, to which the seedlings were fastened with iron pins or rubber bands, the plants were brought in perpendicular position into glass vessels containing the desired medium. Care was taken that the cotyledons were held above the surface and were kept sufficiently moist. Except at times of measurement, the vessels containing the seedlings were placed in a dark compartment, in which the temperature remained fairly constant or made very gradual changes. If not especially stated, the range of variation in 24 hours may be assumed to be between 17° and 20° C.

To obtain the general features of the curve, the growth and its distribution were measured in the usual manner by means of marks of India ink and a scale. The more detailed study of parts of the growth-curve was made with the horizontal microscope¹. Two methods were used: (1) measurements were made from point to point, as described by Pfeffer², and (2) by the movement of the root-tip on the ocular micrometer. A discussion of these methods is given by Pfeffer (as cited), Askenasy³, and Francis Darwin⁴.

As the transfer from water to the saltpetre solution frequently caused a more or less complete obliteration of the ink marks, the latter method was here usually applied.

Some of the sources of error may here receive attention. As a *sudden* change of medium was necessary, experiments were conducted only in aqueous solutions with control-experiments in water. The evident advantages of this method seemed to justify its use in face of the fact that the growth-

¹ Pfeffer, Pflanzenphysiologie. Leipzig, Bd. II, p. 84 (1881).

² Pfeffer, Physiologische Untersuchungen. Leipzig, 1873, p. 27, also Druck und Arbeitsleistung durch wachsende Pflanzen. Abb. d. Königl. Sächs. Gesellsch. d. Wissensch. Bd. XX (1893), Heft 3, p. 293, Leipzig.

³ E. Askenasy, Ueber einige Beziehungen zwischen Wachstum und Temperatur. Ber. d. deutsch. bot. Gesellsch. VIII (1890), p. 61.

⁴ F. Darwin, Arb. d. bot. Institut. in Würzburg, Bd. II, p. 521.

rate was thereby considerably reduced when compared with that made in soil or sawdust¹.

As pointed out by Askenasy², the handling of roots incidental to measurement causes a decided disturbance of the growth. By quick and careful handling, it was sought to reduce this to a minimum. As all roots used were as nearly alike as was practicable to choose them, and as the method of handling was as nearly the same in all cases as possible, the results may be regarded as comparable. Because of this fact, and because of the relative nature of the question under discussion, the above errors may the more easily be neglected.

Experimental.

Turning now to the experimental part of our subject, it seems well at the beginning to notice briefly the growth observed under normal conditions.

In the following experiment the growth of four roots of *Vicia Faba* was observed for a period of approximately 12 days. The temperature varied between 18° and 20° C. The average total length of the roots at the beginning of the experiment was about 20 mm.

Table I shows a summary of the results.

In the left column, designated 'Period,' is indicated the duration of time in hours and minutes elapsing between measurements. In the middle column is shown the rate of growth in *millimetres per hour*, found to prevail during the given periods. At the right, the medium used is noted, here water during the entire experiment. The first line of the table, therefore, shows that during the period of 1½ hours after the beginning of the experiment, the average growth-rate per hour was 0.50 mm. in water as a medium.

The very flat curve rises irregularly to a maximum indicating a growth-rate of about 1 mm. per hour. By an average temperature of 19° C. it is attained in from 130 to 150 hours after

¹ J. Sachs, *Gesammelte Abhandlungen über Pflanzenphysiologie*, Bd. II, p. 796.

² Askenasy, *loc. cit.*

the swelled seeds are placed in the sawdust. About one day before the maximum is reached, protuberances indicate the internal formation of lateral roots, which burst through and begin a rapid growth, the oldest attaining an average length of about 10 mm. by the time the primary root has reached its maximum rate. From this time on, the demands of the laterals cause the curve to fall.

TABLE I.

Period.		Growth per hr.	Medium.
Hours.	Min.		
1	45	0.50 mm.	Water
17	00	0.75 "	"
6	00	0.65 "	"
17	15	0.65 "	"
23	15	0.80 "	"
24	00	0.97 "	"
25	30	0.98 "	"
47	30	0.72 "	"
24	30	0.56 "	"
47	45	0.58 "	"
50	00	0.59 "	"

Passing now to the consideration of the effect of changes of concentration of the medium on growth, it may be said, *a priori*, that two factors enter into the question; (1) the length of time during which the objects are exposed to the action of the various culture-mediums, and (2) the degree of concentration of the same.

In order to roughly determine what degree of concentration could be endured, and for how long, seedlings of *Vicia Faba* were brought into saltpetre solutions of 3.0, 1.5, 1.0, and 0.25 per cent. respectively. Three per cent. was found to be speedily fatal in its action. If the exposure in 1.5 per cent. was for a short time only, the transfer to water was followed tardily by returning growth; if the exposure was prolonged,

372 True.—On the Influence of Sudden Changes of

the root-tips died. In solutions of a 1.0 per cent. concentration or less, accommodation and further growth took place.

That, by a gradual increase of concentration, growth in mediums which here proved fatal could take place, is certain¹.

Pisum sativum and *Lupinus albus* were found to be more sensitive than *Vicia Faba*. Indeed, *Lupinus* was more strongly affected by a 0.25 per cent. solution than *Vicia Faba* by one of 1.0 per cent. KNO_3 content.

Table II shows the average growth of six roots of *Vicia Faba* in a 1.0 per cent. saltpetre solution for 4 days. Temperature 17.0° to 18.9° C.

TABLE II.

Period.		Growth per hr.	Medium.
Hours.	Min.	*0.2 mm.	KNO_3 (1%)
	30		
3	05	0.48 "	"
3	10	0.63 "	"
17	00	0.62 "	"
23	15	0.52 "	"
24	15	0.55 "	"
23	45	0.49 "	"

* Estimated average contraction.

In order to obtain approximately the extent of the contraction due to the turgor-reducing action of the KNO_3 solution, a measurement was made 30 minutes after the transfer to the medium. Although decimal parts less than 0.5 mm. are questionably near the limit of accuracy with the scale, still the average contraction has been given as estimated. It seemed to me that the estimates were nearer the truth than either the nearest unit or half unit. A further discussion of this feature is reserved for a later part of this paper, where the results of measurement with the horizontal microscope receive attention.

¹ Stange, loc. cit.

A comparison of the curve of growth here found with that of normal growth in water brings forth one striking difference. In the 1 per cent. solution, the curve does not rise to the usual maximum. The process of accommodation takes place quickly, after 3½ hours at most, the rate of growth being plainly equal to the normal. As remarked by de Vries¹, however, in similar experiments, the growth of the second day is reduced. During the remainder of the experiment, the curve rises at no time to a higher point than that reached immediately after the accommodation to the new medium had taken place. The resulting total growth is, therefore, decidedly smaller than that characteristic for the control in water for a like length of time.

TABLE III.

Period.		Growth per hr	Medium
Hours.	Min.	0-10 mm.	0-25 % KNO ₃
	30		
2	30	0-45 "	" "
2	30	0-70 "	" "
15	45	0-73 "	" "
23	45	0-54 "	" "
27	00	0-30 "	" "
20	15	0-16 "	" "
24	45	0-05 "	" "
29	00	0-00 "	" "

* Estimated average contraction.

For comparison, Table III, showing the average growth-rates of a series of four radicles of *Lupinus albus* in a 0-25 per cent. KNO₃ solution, is here given. Temperature 17-0 to 19-5° C.

The same general course seen in the last experiment is here repeated. A rather rapid accommodation, approximately normal growth for nearly a day, then a gradual and continued decrease with a much reduced total growth, are the features to be noticed.

¹ De Vries, loc. cit., p. 58.

374 *True.*—*On the Influence of Sudden Changes of*

That the radicles were strongly affected by the solution is seen in the forms they assumed. Swellings appeared near the tips, and the ends tapered suddenly to sharp points. On the other hand, the growth in thickness was much greater than normal, the radicles above the swellings reaching the size of large radicles of *Vicia Faba* of the same length.

A similar but very much more decided effect is noted by Wieler¹ in radicles of *Phaseolus multiflorus* grown in glycerine.

Stange² also mentions similar appearances in radicles grown in a medium containing glycerine.

Roots of *Vicia Faba* grown in a 0.25 per cent. solution of KNO_3 gave a practically normal growth-curve.

We will now turn to the experiments bearing on the question as to the effect of sudden turgor-changes on growth. Seedlings taken from the sawdust were marked and placed in water for a short time, perhaps one or two hours. This gave an opportunity for such changes as might arise from the modified conditions of water³ and oxygen supply to take place. The roots were then measured, and transferred directly to the desired medium. Those placed in saltpetre solutions were allowed to remain for various lengths of time, from 1 to 72 hours. At the expiration of these periods of exposure, the return to water was suddenly made. Care was always taken that the same temperature prevailed in the different mediums. About 30 minutes after a change of substratum, measurements were made to ascertain the amount of elastic contraction or elongation due to turgor-change. Further measurements were made at suitable intervals to obtain growth-rates.

Those experiments involving the most decided changes are considered first.

In Table IV are given the average growth-rates of a series of roots of *Vicia Faba* during an exposure of 72 hours to

¹ Wieler, Ueber Anlage und Ausbildung von Librifasern in Abhängigkeit von äusseren Verhältnissen, Bot. Zeit. 1889, p. 250.

² Stange, loc. cit.

³ Compare Duhamel, Naturgeschichte der Bäume, Bd. I (1764), p. 107. Sachs, Gesammelte Abhandlungen, Bd. II, p. 785.

Turgor and of Temperature on Growth. 375

a 1.0 per cent. KNO_3 solution, and during the 9 days following the sudden transfer to water. The averages are drawn from but three specimens, one showing pathological symptoms after the transfer to water being excluded.

TABLE IV.

Period.		Growth per hr.	Medium.	Temperature.
<i>Hours.</i>	<i>Min.</i>			
	30	*0.30 mm.	1% KNO_3	18.0 C.
3	00	0.05 "	" "	18.2 "
2	45	0.65 "	" "	17.5 "
17	00	0.55 "	" "	17.0 "
26	00	0.50 "	" "	17.2 "
22	15	0.40 "	" "	17.2 "
	30	†0.20 "	Water	17.8 "
3	30	0.40 "	"	17.8 "
2	45	0.20 "	"	17.8 "
16	45	0.50 "	"	17.5 "
23	45	0.75 "	"	16.5 "
24	00	0.55 "	"	16.4 "
25	30	0.70 "	"	16.5 "
22	30	0.70 "	"	16.5 "
24	00	0.70 "	"	17.2 "
23	30	0.80 "	"	17.5 "
24	15	0.55 "	"	18.0 "
23	30	0.40 "	"	18.0 "

* Estimated average contraction.

† Estimated average elongation.

As before remarked, the elastic elongation and contraction due to turgor-changes are here only estimated, and conclusions regarding these features of the experiment are to be drawn only from measurements made by means of the horizontal microscope.

The transfer to the KNO_3 solution is here again followed by a short period of depression, which gives way to a normal growth-rate after about three hours. As seen in Tables I and

376 True.—On the Influence of Sudden Changes of

II, so here, this normal rate is only temporary, the curve again beginning to sink. The transfer to water is seen to be followed, not immediately by a growth-rate characteristic of this medium, but by a retarded growth. Only after about 20 hours has the normal rate been established. Indeed, the roots seem to have been permanently affected, since the maximum rate reached is considerably less than in normal roots grown in water.

In a duplicate experiment with roots of *Pisum sativum*, the curve ran parallel to the preceding until the change to water

TABLE V.

Period.		Growth per hr.	Medium.	Temperature.
Hours.	Min.			
	30	0.00 mm.	1% KNO ₃	19.5° C.
3	30	0.20 "	" "	19.6 "
2	30	0.65 "	" "	19.7 "
16	30	0.70 "	" "	19.2 "
22	45	0.65 "	" "	18.6 "
	30	†0.25 "	Water	19.0 "
2	15	0.10 "	"	19.0 "
5	00	0.25 "	"	19.0 "
16	30	0.60 "	"	18.0 "
24	30	0.90 "	"	18.0 "
24	00	1.05 "	"	17.5 "
26	00	1.05 "	"	16.8 "
22	00	1.10 "	"	17.2 "
24	00	0.95 "	"	16.5 "
24	15	0.75 "	"	16.2 "

† Estimated average elongation.

was made. Recovery in water was not possible, and after five days of about one-fourth normal growth, the curve sank to the minimum.

In Table V are given the growth-rates of a series of roots of *Vicia Faba* during and following an exposure of 46 hours to a 1 per cent. solution of the usual salt. The series, origin-

ally consisting of four radicles, was reduced to two by the appearance of abnormalities shortly after the transfer to water. The roots made the sharp curves characteristic of injury, and in aggravated cases, groups of dead cells could be distinguished on the concave side. The cause of this lies probably in the local inability of the surface-tissues to accommodate themselves to the sudden change of conditions. As the remaining radicles agreed very closely in their behaviour, the results are here given.

No measurable contraction was here seen to follow the

TABLE VI.

Period.		Growth per hr.	Medium.	Temperature.
<i>Hours.</i>	<i>Min.</i>			
	35	*0.25 mm.	1% KNO ₃	18.0° C.
1	10	0.32 "	" "	18.0 "
17	00	0.55 "	" "	18.0 "
	35	†0.37 "	Water	18.0 "
2	30	0.25 "	"	18.0 "
2	45	0.31 "	"	17.5 "
17	15	0.48 "	"	17.0 "
23	15	0.68 "	"	17.5 "
24	00	1.10 "	"	18.0 "
25	30	1.15 "	"	18.0 "
47	30	1.02 "	"	18.5 "
24	30	0.80 "	"	18.8 "
47	30	0.80 "	"	18.5 "
50	00	0.73 "	"	18.0 "

* Estimated average contraction.

† Estimated average elongation.

transfer to the salt solution. It was occasionally noticed that in very strongly growing roots, simply a check of the growth occurred. In such cases, the resultant of the growth and of the opposing action of the salt was nearly zero. Except in this particular, the results resemble those of the preceding experiment. The accommodation to water is more readily

378 True.—On the Influence of Sudden Changes of

made, and no permanent injury is to be seen. After 8 hours in water, the normal growth-rate is re-established, and recovery is complete. Indeed, the maximum rate is greater than that of the average control-experiment in water.

Table VI shows the course of the growth of the four *Vicia Faba* roots during and after an exposure of 19 hours in the usual solution.

A comparison with Table V shows that in both cases the course of the growth-curve offers no essential difference from the preceding. The growth of the average control is here again exceeded at the maximum period.

TABLE VII.

Period.		Growth per hr.	Medium.	Temperature.
Hours.	Min.			
1	00	0.00 mm.	1% KNO ₃	18.7° C.
	30	†0.30 „	Water.	19.0 „
3	00	0.26 „	„	19.8 „
2	30	0.48 „	„	19.8 „
17	30	0.70 „	„	18.6 „
27	00	0.68 „	„	20.8 „
20	00	0.81 „	„	19.0 „

† Estimated average elongation.

In order to obtain an idea of the minimum period of exposure sufficient to produce a retardation of the growth-rate following the sudden return to water, experiments were made in which the roots were placed in the saltpetre solution for a short period.

A series of roots of *Vicia Faba* was placed in a 1 per cent. solution one hour, then suddenly transferred to water. No manifest retardation was observed. When, however, a concentration of 1.5 per cent. was used for the same length of time, a decidedly reduced growth-rate was seen to follow the transfer to water. Only after several hours was the normal growth-rate restored.

Owing to its greater sensitiveness, a series of radicles of *Lupinus albus* gave a decided reaction after one hour in a 1 per cent. solution.

In Table VII are shown the details. The averages are drawn from 4 specimens.

During the hour spent in the KNO_3 solution, the operative factors give as a resultant no measurable change of length. The mechanical contraction due to the turgor-change is approximately balanced by the slight growth following. The return to water is seen to be followed by a decided reaction.

It seems hardly probable that here we have, indeed, the simple result of the change from KNO_3 to water. In view

TABLE VIII.

Period	Growth.	Medium.
11-11.30	18 units of scale	Water
11.30-12	10 " "	"
12-2.30	*16 " "	"
2.30-3	26 " "	"
3-3.30	18 " "	"
3.30-4	22 " "	"
4-4.30	25 " "	"
4.30-5	21 " "	"
5-5.30	24 " "	"
5.30-6	25 " "	"
6-6.30	24 " "	"
6.30-7	26 " "	"

* Rate of growth per half hour. 1 unit of scale = 0.0169 mm.

of the short time elapsing after the transfer to the KNO_3 solution, it is likely that before recovery from this shock has taken place, the second change of substratum occurs, and the retardation observed is probably the reaction to both stimuli. An analysis into the components was not attempted.

It appears, as would be expected, that the stimulus can be so reduced that no measurable reaction can be detected by measurements made with the scale.

380 True.—On the Influence of Sudden Changes of

Passing to the experiments involving the use of the horizontal microscope, attention is first called to the normal growth as observed in control-experiments in water.

In Table VIII are shown the increments of growth made by a root of *Vicia Faba*, as determined by half-hourly observations. The total length of the root at the beginning of the experiment was 23 mm. Temperature, 20.0°–23.0° C.

As was above suggested, if a root growing in sawdust be brought into water, a slight elongation is usually seen to occur, due to the swelling of the cell-membranes and to a slight increase of turgor-pressure in case the object was not already fully turgescient. This elongation is usually followed by a

TABLE IX.

Period.	Growth.	Medium.
11-11.30	16.0 units of scale	Water
11.30-12	17.0 " "	"
12-12.30	3.5 " "	1% KNO ₃
12.30-1	7.5 " "	"
1-2.30	*13.0 " "	"
2.30-3	17.0 " "	"
3-3.30	23.0 " "	"
3.30-4	27.0 " "	"
4-4.30	45.0 " "	Water
4.30-5	26.0 " "	"

* Rate per half-hour. 1 unit of scale = 0.0169 mm.

somewhat retarded rate of growth, arising probably as an irritative response to the changed conditions of water and of oxygen-supply. After an hour or two, the normal rate is generally restored.

It may also be mentioned here that the transfer of a root from the sawdust to the observation vessel involves a great change in the conditions of illumination. Whether roots are in any considerable degree sensitive to sudden changes of this nature seems to be a question that has not yet received attention.

In Table IX is shown the course of growth of a root of

TABLE VIII. *Vicia faba*. (continued)

Vicia faba in water and in 1 per cent. KNO_3 . Total length, 21 mm. Temperature, 20°-23° C.

The transfer to the salt solution is here followed by an immediate contraction, the growth is suspended, and the gradual recovery of growth in the salt solution is complete in about 24 hours. The return to water is immediately followed by the elastic elongation due to the increased turgor pressure. Of the 27 units of increased length seen to be added during the 10 minutes following the change, seeming, therefore, to be, for the most part, due to the elastic extension

TABLE X.

Period.	Growth.	Medium.
10:30-11	15.0 units of scale	Water
11-11:30	13.0 " "	"
11:30-12	16.0 " "	"
12-12:30	14.0 " "	"
12:30-1	-8.0 " "	1% KNO_3
1-1:30	6.0 " "	"
1:30-2	5.5 " "	"
2-2:30	4.0 " "	"
2:30-3	3.0 " "	"
3-3:30	3.0 " "	"
3:30-4	2.0 " "	"
4-4:30	2.0 " "	"
4:30-5	2.0 " "	"
5-5:30	2.0 " "	"
5:30-6	2.0 " "	"
6-6:30	2.0 " "	Water
6:30-7	2.0 " "	"
7-7:30	2.0 " "	"

* Rate per half-hour. 1 unit of scale = 2.0003 mm.

caused by turgor. During the hour following the return to water, no retardation of the growth-rate is seen. That it may have occurred later had the experiment been prolonged is of course possible.

For comparison with the above, the record of a root of *Vicia faba* very similarly handled is given in Table X. Total length of root, 21 mm. Temperature, 20°-23° C.

The contraction following the transfer to the solution of KNO_3 is here plainly marked. Indeed, it has an approxi-

382 True.—*On the Influence of Sudden Changes of*

mately average magnitude, and in the manner of its occurrence is quite typical. In order to show more exactly the time-relations involved, measurements taken at short intervals during the first half-hour after the transfer to the salt-solution are shown in Table XI.

The contraction is seen to begin immediately, and to be

TABLE XI.

Period.	Change in length.	Medium.
2.30-2.33	-8.0 units of scale	1% KNO ₃
2.33-2.36	-1.0 " "	"
2.36-2.40	-1.0 " "	"
2.40-2.45	-0.5 " "	"
2.45-2.50	0.0 " "	"
2.50-2.55	1.0 " "	"
2.55-3	2.0 " "	"

1 unit of scale = 0.0182 mm.

finished very soon. After a short period of equilibrium, growth begins at a slow rate, but fails to recover the normal speed before the change to water takes place. The return of the radicle to water is followed by the usual elastic elongation. In the following table, the time-relations are shown more in detail.

TABLE XII.

Period.	Growth.	Medium.
6.30-6.35	10.0 units of scale	Water
6.35-6.40	6.0 " "	"
6.40-6.45	4.0 " "	"
6.45-6.50	2.0 " "	"
6.50-6.55	1.5 " "	"
6.55-7	1.5 " "	"

1 unit of scale = 0.0182 mm.

The elastic elongation takes place very soon after the change to water, and is of short duration.

The study of these elastic changes of length was made under differing conditions, and the essential features were found not to vary from the foregoing. The contraction observed to accompany the transfer to the KNO_3 solution was always of less magnitude than the elongation seen to follow the return to water.

It must not be forgotten that in each case we have to do with more than a simple turgor-change. The growth prevailing at the time of such change of medium enters as a complicating factor. If we transfer a root from water to a saltpetre solution, we cannot regard the growth-rate as instantaneously adjusting itself to the new medium. The former speed gives a certain impulse that must be overcome before the new conditions can produce their characteristic effect. It will still operate for a short time in the new medium. We would not expect, therefore, the entire work resulting from the change of turgor to find expression in the altered length of the root, a part being expended in working against the prevailing impetus of growth. We see as a contraction only the resultant of the two factors, the larger of which is the elastic change due to turgor.

In the case of the transfer from the saltpetre solution to water, we have the same two factors present, but here they work in the same direction, and the alteration in length is equal to the sum of the two factors. The contraction is the sudden halt called forth by the substratum, the elastic elongation is the push given by it. To resolve the resultants above found into their numerical components is here not attempted.

As may be seen in the experiments above detailed, a transfer from water to a saltpetre solution is followed by a more or less prolonged period of retarded growth¹. A reduced growth-rate is likewise seen to follow very regularly the reverse change of medium, although a quite rapid rate of growth may prevail in the KNO_3 solution immediately prior to the transfer to water. Thus a depression of growth

¹ In Tables II to VII, all radicles were placed in water and allowed to assume a normal growth-rate before being brought into the KNO_3 solution.

is the result of a change of medium as well when this change calls forth an *increased*, as when it calls forth a decreased turgor-pressure. The conclusion follows that here the rate of growth stands in no direct proportion to the turgor-pressure. This is in accordance with the fact lately demonstrated by Pfeffer¹, that turgor is not necessary for the growth of the cell-membrane.

To point out the causes of this is no simple task. For greater clearness, let us consider the two cases separately.

In the case of a change from a saltpetre solution to water, it is plainly impossible that the diminished growth-rate should have for its cause a lack of turgor-pressure. Abundant evidence from other sources shows that a reduced growth-rate can accompany an increasing turgor-pressure. Wieler², Stange³, and Eschenhagen⁴ may be cited in this connexion. Hegler⁵ found that a mechanical pull in the direction of the long axis of a plant caused a diminished rate of growth and an increased turgor.

It seems that we have here a plain exhibition of protoplasmic irritability. The change of concentration acts as a stimulus, which calls forth a reaction in the form of a diminished rate of growth.

A number of possible causes of the diminished growth-rate succeeding the sudden change from water to the salt-solution suggest themselves.

(1) Perhaps the return of full growth is delayed until a necessary minimum turgor-pressure is established. The period of retarded growth, as seen in roots of *Vicia Faba*, suddenly brought into a 1 per cent. solution of KNO_3 , lasts usually from $2\frac{1}{2}$ to $3\frac{1}{2}$ hours. Whether such a period is necessary for the turgor-adjustment does not appear, the time relations of this change not having received especial attention

¹ Pfeffer, Druck u. Arbeitsleistung, p. 429.

² Wieler, Plasmolytische Versuche mit unverletzten Phanerogamen, Ber. d. deutsch. bot. Gesellsch. 1887, p. 375.

³ Stange, loc. cit.

⁴ Eschenhagen, loc. cit.

⁵ R. Hegler, Ueber den Einfluss des mechanischen Zuges auf das Wachstum der Pflanzen. Cohn's Beitr. z. Biol. d. Pflz., Bd. VI, Heft 3, p. 1.

as yet. The few experiments bearing on this point give a very incomplete view of details. De Vries¹ states that out of 0.35 molecules of glycerine, 0.03 pass into the cell in one hour. Janse² found plasmolyzing substances in the cell-sap of *Spirogyra* after 30 minutes in either dilute or concentrated solutions. Eschenhagen³ found that the hyphae of moulds, transferred suddenly from a 10 per cent. to a 40 per cent. sugar-solution, after 6 hours were plasmolyzed by a 30 per cent. sugar-solution, not yet having reached the concentration of the new medium. It is here to be noticed, however, that the increase in osmotically active substances is brought about, not by penetration of the sugar, but by metabolic activity in the cells themselves, and a different action may result.

It seems entirely possible in the case under consideration that an interval equal to the retardation-period found, might be necessary for an adjustment of the turgor-pressure. If this should be the case, it would not be unexpected were the rate of growth during this period to show more or less disturbance.

(2) In view of the exhibition of irritation seen to follow the reverse change of medium, it would seem highly probable that here a similar phenomenon might be present.

(3) It seems possible that the medium may exert a specific chemical effect on the seedlings placed in it. Evidence supporting such a supposition is afforded only by roots that were left in the saltpetre solution for long periods of time.

Recapitulation.

Bringing together the most important results following from the experiments above presented, it appears (1) that a sudden and decided increase of the concentration of the liquid medium calls forth in growing roots a change of turgor-pressure, producing, or tending to produce, a mechanical contraction, also

¹ De Vries, cited by Stange, loc. cit.

² Janse, Plasmolytische Versuche an Algen, Bot. Centralbl. XXXII (1887), Th. I, p. 21.

³ Eschenhagen, loc. cit., p. 35.

a more or less prolonged period of retardation of the growth-rate. The cause of the retardation was not demonstrated, but is probably due, in part, to decrease of the turgor-pressure, and, in part, to a sensitive reaction following the irritation of the living organisms.

(2) A sudden and decided decrease of the concentration of the medium causes a change of turgor-pressure producing a mechanical elongation, also a more or less prolonged period of retardation of growth. The cause of the retardation is found in a sensitive reaction of the living organisms to the change of medium. Since a reduction of growth is found to accompany both an increase and a decrease of turgor-pressure, it follows that growth and turgor-pressure here stand in no directly proportional relation to each other.

II. THE EFFECT OF SUDDEN CHANGES OF TEMPERATURE.

Historical.

Although a number of earlier investigators¹ had studied the effects of sudden temperature changes on the streaming of protoplasm, Koeppen² first investigated the effect exerted on plant-growth. He concluded that the act of change brought about a reduction of growth in radicles of various seedlings.

Sachs³, from observations on the growth of certain etiolated stems, was unable to confirm this view.

Pedersen's⁴ results led him also to take exception to Koeppen's generalization. He exposed roots of seedlings of

¹ Max Schultze, *Protoplasma der Rhizopoden und der Pflanzenzelle*, 1863, p. 63. Dutrochet, *Comptes Rendus*, 1837, T. V, p. 777 ff. Hofmeister, *Pflanzenzelle*, 1867, pp. 47 and 53. See also Sachs, *Handbuch der Experimental-Physiologie der Pflanzen*, 1865, p. 69.

² Koeppen, *Wärme und Pflanzenwachstum*. Dissertation, Moskau, 1870, pp. 20 and 22.

³ Sachs, *Ueber den Einfluss der Lufttemperatur und des Tageslichts auf die stündlichen und täglichen Änderungen des Längenwachstums der Internodien*. *Arb. d. bot. Inst. in Würzburg*, 1872, Hef. II, p. 164. Also, *Gesammelte Abhandlungen über Pflanzenphysiologie*, Bd. II, p. 677.

⁴ Pedersen, *Haben Temperaturschwankungen einen ungünstigen Einfluss auf das Wachstum?* *Arb. d. bot. Inst. in Würzburg*, Bd. I (1874), p. 563.

Vicia Faba to both sudden and to gradual changes of temperature between 10° and 20° R., and found the growth-rate to depend solely on the absolute temperature, the act of change being entirely without influence.

Askenasy¹, with a more accurate method of measurement, found that the influence due to a sudden change of temperature depended on the position of the lower limit. When the minimum temperature used still permitted growth, the change to the higher degree was followed by an immediate assumption of the rate of growth characteristic for the new temperature. When, however, the minimum temperature was near the zero point, the transfer to the higher temperature was followed by a more or less tardy assumption of the normal growth-rate. Pfeffer² noted a similar gradual return of growth after roots which had been in a temperature of 0.5° C. for 12 hours were brought into a warmer medium.

Godlewski³ saw very similar results in the case of epicotyls of *Phaseolus vulgaris*, when they were exposed to sudden changes of the temperature of the surrounding air. Whether the temperature was raised or lowered, a temporary decrease of growth-rate followed.

Pfeffer⁴ found that changes of temperature caused the opening and closing of flowers of *Crocus* and of *Tulipa* by bringing about unequal growth in antagonistic parts of the perianth-members. A rising temperature caused a more rapid growth of the upper part, and opening followed; a falling temperature, on the other hand, caused a more rapid growth of the under part, and thus the closing of the flower. The same author⁵ observed that changes of temperature act as

¹ Askenasy, Ueber einige Beziehungen zwischen Wachstum und Temperatur. Ber. d. deutsch. bot. Gesellsch., Bd. VIII (1890), p. 75.

² Pfeffer, Druck und Arbeitsleistung durch wachsende Pflanzen. Abh. d. Königl. Sächs. Gesellsch. f. Wissensch., Bd. XX, Heft III, pp. 893, 354.

³ Godlewski, Ueber die Beeinflussung des Wachstums der Pflanzen durch äussere Faktoren. Anz. d. Akad. d. Wissensch. in Krakau, 1890, p. 166.

⁴ Pfeffer, Physiologische Untersuchungen. Leipzig, 1873, p. 194.

⁵ Pfeffer, Die periodischen Bewegungen der Blattorgane. Leipzig, 1875, p. 135.

388 True.—*On the Influence of Sudden Changes of*

weak stimuli in inducing leaf-movements of *Oxalis Acetosella* and of *Mimosa pudica*¹.

Materials and Methods.

As far as here applicable, the materials and methods used were like those already described in the first part of this paper. Radicles of the same species were germinated in the same manner. Measurements were made with the scale and the horizontal microscope. Owing to the liability of disturbance by the expansion and contraction of parts of the apparatus, the measurements with the horizontal microscope were usually made from point to point. The results thus obtained differed, however, but very slightly from those yielded by the measurement of the movement of the tip on the ocular micrometer.

To obtain the desired temperatures, resort was had to a number of devices. As the experiments demanding low temperatures were made in winter, it was found easy, by the use of a cold room and ice, to obtain the desired result. The higher temperatures were found in rooms provided with automatic heat-regulators. For the limited time occupied by the experiments involving the use of the horizontal microscope, it was found practicable, with a room-temperature of 19° C. to obtain the desired temperatures by the use of a microburner or of small pieces of ice added at regular intervals.

Because of the obvious advantages, experiments were usually made with roots in water. Comparison experiments were made in sawdust.

Experimental.

In order to gain a general view of the effects accompanying extreme changes, several series of roots of *Vicia Faba* were exposed to a temperature near the zero point for various periods of time, and were then suddenly brought into a temperature of about 24° C.

Four roots of *Vicia Faba* seedlings were exposed for 220 hours to a temperature varying between 0.40 and 2.5° C.,

¹ Pfeffer, Pflanzenphysiologic, 1881, Bd. II, p. 231.

Turgor and of Temperature on Growth. 389

making during this time an average growth of 0.7 mm. per 24 hours. They were quickly transferred to a temperature of 23° C., and the further growth measured at suitable intervals. As one showed abnormal symptoms, the following table shows averages drawn from but three specimens.

The feature here to be noted is the long period of retarded growth following the change to the higher temperature. The roots seem during the exposure to the cold to have gone into

TABLE XIII.

Period.		Growth per hr.	Temperature.
<i>Hours.</i>	<i>Min.</i>		
3	30	0.28 mm.	24.2° C.
2	45	0.24 "	23.6 "
16	45	0.27 "	22.4 "
24	00	0.03 "	23.5 "
23	30	0.37 "	23.6 "
24	30	1.06 "	23.6 "
24	00	0.90 "	23.9 "
48	30	0.69 "	23.8 "
24	00	0.60 "	23.8 "
23	30	0.37 "	23.9 "

a state of torpor, from which an awakening to full activity takes place but slowly. The course of the growth-curve seems to be permanently affected. The maximum lies lower than is normally the case in this temperature, and the descending limb falls more abruptly than in the normal curve. Unless a correlative change, giving a longer-growth period than usual, takes place, the total growth here suffers a diminution.

Table XIV gives the average growth-rates of four roots of *Vicia Faba* during and after a stay of 48 hours in a temperature varying between 2.5° and 6.0° C.

The period of retarded growth here seen to follow the temperature-change is very much less marked than in Table XIII.

Although the lower temperature limit is here somewhat higher, it can hardly be regarded as accounting for the speedy return of the normal growth-rate, since a parallel experiment with

TABLE XIV.

Period.		Growth per hr.	Temperature.
Hours.	Min.		
1	00	0.00 mm.	2.5° C.
7	00	0.00 "	3.2 "
17	00	0.05 "	6.0 "
23	00	0.07 "	4.8 "
2	00	0.40 "	19.2 "
21	00	0.65 "	18.0 "
23	00	0.75 "	18.5 "

the lower limit between 0.4° and 0.6° C. gives no longer period of retardation.

In Table XV are given the average growth-rates drawn

TABLE XV.

Period.		Growth per hr.	Temperature.
Hours.	Min.		
2	00	0.25 mm.	6.0° C.
15	45	0.02 "	2.0 "
1	30	0.50 "	22.4 "
2	45	1.22 "	23.0 "
3	00	1.08 "	23.0 "
20	15	1.16 "	23.0 "
21	00	1.06 "	22.5 "

from four roots of *Vicia Faba* during and after a stay of about 18 hours in a low temperature.

Here a slight retardation is seen, which is quickly superseded by a fully normal growth-rate.

It was found in further experiments here not detailed, that

by shortening the period of exposure to the low temperature, the change to the higher degree was followed by no retardation that could be detected by measurements with the scale; the normal growth seemed to be immediately assumed.

It was noticed in comparative experiments with roots cultivated in sawdust, that a somewhat longer period of exposure to the cold was necessary in order to produce a retardation than in cultures in water. A recovery of the normal growth took place more rapidly in the former case.

In order to study more accurately the results following temperature-changes, the horizontal microscope was again brought into use. Plainly this method of measurement is suited only to experiments occupying shorter periods of time,

TABLE XVI.

Period	Growth in scale units	Temperature.
10.10-10.40	16.0 units	18.5° C.
10.40-11.10	5.0 "	18.6 "
11.10-11.40	2.0 "	18.7 "
11.40-3.10	2.0 units per ½ hr.	18.8-19.7 "
3.10-3.40	3.0 "	19.7 "
3.40-4.10	2.5 "	19.8 "
4.10-4.40	2.5 "	19.8 "
4.40-6.10	2.0 "	19.8-20.0 "

1 unit = 0.0182 mm.

and is, therefore, not well adapted to the study of long-continued reactions following prolonged exposure to low temperatures. Only those phenomena which occur soon after a change can be here most profitably followed. When the exposure to low temperatures is short, and the normal growth soon returns, this instrument is also called into use.

Before passing to the latter class of experiments, we will briefly notice the results seen to immediately follow the return to a higher temperature after a prolonged exposure to cold.

In Table XVI is shown the record of a *Vicia Faba* radicle

392 *True.*—*On the Influence of Sudden Changes of*

following the transfer from 0.5° – 2.0° C., to 18.5° – 19.8° C. The time spent in the lower temperature was 94 hours.

The striking feature of this experiment is the slight elongation occurring promptly after the change, and the subsequent rapid fall of the curve.

A measurement made at 11.25, 15 minutes after the transfer from the cold, showed that 11 of the 16 units of elongation were made during the first quarter of an hour. That this is in part due to a turgor-change will appear from further considerations.

Table XVII gives the increments of elongation shown by measurements made every 15 minutes seen in a root of *Pisum sativum* under very similar circumstances. The root was exposed 48 hours to a temperature of 0.5 – 0.8° C., and was then suddenly brought into a temperature of 19.4° C.

TABLE XVII.

Period.	Growth in scale units.	Temperature.
11.30–11.45	19.0 units	19.5° C.
11.45–12	5.0 „	19.6 „
12–12.15	4.0 „	19.6 „
12.15–12.30	4.0 „	19.6 „

1 unit = 0.0182 mm.

Essentially the same result is here repeated. A fuller consideration of this phenomenon is reserved for another place.

A number of experiments were made to ascertain the effect of a short exposure to a low temperature. To this end the growth-rate at the room-temperature was first obtained, then the radicle was transferred to a low temperature, and the growth was observed for a given time. The transfer to the original temperature was then made, and the further growth noted.

In Table XVIII is shown the record made by a root of *Vicia Faba* observed before, during and after an exposure for two hours to a temperature of 1.2° to 2.0° C.

The transfer to the lower temperature causes not merely a sudden checking of the growth, but, in fact, a slight contraction. In this case measurements at shorter intervals

TABLE XVIII.

Period.	Growth.	Temperature.
12.55-1.25	16.0 units	18.9° C.
1.25-1.55	17.0 "	19.0 "
1.55-2.25	14.0 "	19.0 "
2.25-2.55	-1.0 "	1.8 "
2.55-3.25	1.5 "	1.6 "
3.25-3.55	0.5 "	1.4 "
3.55-4.25	1.0 "	1.2 "
4.25-4.55	10.0 "	19.3 "
4.55-5.25	11.5 "	19.6 "
5.25-5.55	10.0 "	19.7 "

1 unit = 0.0183 mm.

brought out the fact that the contraction took place during the first five minutes after the temperature-change, the growth during the remainder of the half-hour being at a complete standstill. It then begins at a very slow rate and continues

TABLE XIX.

Period.	Growth.	Temperature.
2.35-3.5	11.5 units	20.0° C.
3.5-3.35	-1.0 "	0.7 "
3.35-4.5	-2.5 "	0.8 "
4.5-4.35	5.5 "	20.4 "
4.35-5.5	7.5 "	20.4 "
5.5-5.35	12.0 "	20.5 "

1 unit = 0.0183 mm.

rather irregularly until the change to the higher temperature takes place. This change is marked by the immediate assumption of a rate of elongation that is maintained with little change

394 True.—On the Influence of Sudden Changes of

during the remainder of the experiment. This rate, however, is but about two-thirds as great as that seen in this temperature at the beginning of the experiment.

For comparison with the above is given in Table XIX the result of a somewhat similar experiment with a root of *Pisum sativum*.

The prolonged contraction here following the transfer to the lower temperature was seldom seen. The return of the normal growth here takes place in a gradual manner.

In Table XX is shown the record made by a radicle of *Lupinus albus* exposed for 30 minutes to a temperature of 0.5° C.

TABLE XX.

Period.	Growth.	Temperature.
3.30-4	11.5 units	19.2° C.
4.4-30	-0.5 "	0.5 "
4.30-5	11.5 "	19.3 "
5-5.30	10.0 "	20.0 "

1 unit = 0.0182 mm.

The rate of elongation following the return to the usual temperature is equal to the growth-rate prevailing before the exposure.

In the experiments thus far considered, we find that a minimum period of exposure to a low temperature exists, following which no reaction can be detected with the scale; we find also in experiments involving microscopic measurements that the retardation or reaction may be reduced by decreasing the period of exposure to the low temperature. A certain duration of the application of the stimulus is necessary to call forth a plain reaction.

In the preceding experiments, the lower temperature limit was near the minimum for growth. Those following deal with the effects arising from changes between limits that are plainly useful for plant-growth.

No experiments involving measurements with the scale were made, since, from the foregoing, it would seem highly improbable that the stimulus given would produce a reaction sufficiently great to be detected by this means.

The experiments of Pedersen¹ tend to confirm this view. Roots of *Vicia Faba* exposed to sudden and to gradual changes of temperature between 10° and 20° R. gave no evidence of any retardation of growth that could be detected with the scale.

TABLE XXI.

Period.	Growth per ¼ hr.	Temperature.
10.25-11.25	2.8 units	30.0-30.2°C.
11.25-11.40	4.5 "	30.1 "
11.40-11.55	3.0 "	30.0 "
11.55-12.10	1.5 "	18.0 "
12.10-12.25	1.0 "	18.1 "
12.25-2.25	2.1 "	17.9-18.2 "
2.25-2.40	1.5 "	18.2 "
2.40-2.55	2.5 "	18.2 "
2.55-3.10	6.0 "	30.2 "
3.10-3.25	4.5 "	30.2-30.0 "
3.25-3.55	4.0 "	30.0 "
3.55-4.10	5.5 "	30.0 "
4.10-4.25	1.5 "	18.2 "
4.25-4.40	3.0 "	18.0 "
4.40-4.55	2.0 "	18.0 "

1 unit = 0.0429 mm.

An attempt to secure the simple effect of temperature-change, as such, was made in the following manner. By reference to a table² of growth-rates at various temperatures, two points were selected, one above the optimum and one below it, at which the growth-rates were approximately equal. As such for *Vicia Faba* 18° and 30° C. were selected. On transferring

¹ Pedersen, loc. cit.

² Koeppen, loc. cit., p. 40. Also Pfeffer, Pflanzenphysiologie, Bd. II, p. 129.

a radicle from one of these temperatures to the other, the growth-rate at both being assumed to be the same, any change regularly accompanying such transfer would be regarded as referable to this change for its cause. It would be expected *a priori* that such growth-changes would be slight and possibly less conspicuous than those due to internal stimuli. It is well known that normal growth from time to time makes very considerable changes of rate. Hence, as in this experiment, where the factors are so nearly balanced, the one evidence that a given change in the rate of growth is due to the

TABLE XXII.

Period.	Growth per $\frac{1}{2}$ hr.	Temperature.
10.30-11.30	1.0 units	17.9-18.2° C.
11.30-11.45	1.0 "	18.2° C.
11.45-12	0.5 "	18.0 "
12-12.15	2.5 "	30.0 "
12.15-12.30	1.0 "	30.2 "
12.30-2.30	2.7 "	29.9-30.1 "
2.30-2.45	2.5 "	30.0 "
2.45-3	1.5 "	18.2 "
3-3.15	2.5 "	18.2 "
3.15-3.45	1.8 "	18.3 "

1 unit = 0.0429 mm.

temperature-change, is the constancy with which the variation of temperature is accompanied by the change of growth-rate. This, however, may not always apply, especially when internal, spontaneous stimuli act in opposition. The growth-rate then seen would indicate the resultant.

Under the conditions above described, a root of *Vicia Faba* about 30.0 mm. long made the record shown in Table XXI.

Table XXII gives the record of a similar experiment with a root of *Vicia Faba*.

Inspection of Tables XXI and XXII shows that every change from 30° to 18° is followed by a reduction of the growth-rate

during the ensuing quarter hour. Further effects plainly due to the change are not to be traced in the later growth. It increases or diminishes according to the internal conditions prevailing. The transfer from 18° to 30° is always followed by an increased amount of elongation during the ensuing 15 minutes. As before, the growth-rate gives no further evidence of being influenced by the temperature-change. In both cases, the traceable effects of the change disappear within 15 minutes.

By subtracting the growth made during the period following a temperature-change from that made during the period preceding the change, we get the amount of retardation or of elongation due to the change. To be sure, an uncertain factor in every case is the possible change in the rate of growth due to internal stimuli, and the results obtained can perhaps hardly be regarded as the pure effect of the act of temperature-change. This source of error is, however, not to be avoided. The amount of retardation so calculated, following the sudden transfer from 30° to 18° , is rather variable, as would, indeed, be expected, and depends somewhat on the rate of growth prevailing at the time of the change. The average retardation calculated from a number of experiments is 0.08 mm. The growth during the following period is usually equal to the average found at the temperature in question. On making the reverse change, the acceleration of the rate of elongation called forth during the period following is likewise rather variable, but averages 0.11 mm. Here again the succeeding growth is usually characteristic for the higher temperature. In both cases the growth-rate of the new temperature seems to be immediately assumed. This receives further attention below.

The phenomena of contraction and of elongation seen immediately after a sudden temperature-change between extremes more widely separated, as well also as the succeeding retardation of the growth, seem to call for a closer examination.

A sudden fall of temperature, as we have seen, produces

398 True.—*On the Influence of Sudden Changes of*

under different circumstances apparently different results. If the lower extreme be near the zero point, and the intervening number of degrees be sufficient (18° C. usually in the above experiments), a *shortening* of the radicle is generally seen to take place within five minutes. If the lower extreme, however, be at a medium temperature (18°) and the fall of temperature be but 12° C., no such shortening is seen. Instead, however, an immediate retardation of growth invariably takes place. A change in the reverse direction gives an immediate elongation or an increased rate of *apparent* growth. Roughly speaking, the greater the number of degrees of temperature increase, the greater is the elongation. This statement is made only for temperatures used in these experiments.

That the location of the minimum point, as such, has no decided influence, is shown by a computation from the averages drawn from the above experiments, and from others not detailed in this paper. The average elongation in the first fifteen minutes following the transfer from 0.40 to 19.0° C. is found to be 0.18 mm. or 0.01 mm. per degree. The corresponding elongation following the transfer from 18.0° C. to 30° C. is 0.095 mm. or 0.009 mm. per degree. The elongation was obtained by subtracting the number of units of growth made during the fifteen minutes' period preceding the transfer, from the number of units of apparent growth made during the like period following the change. The absolute elongation due to the change of temperature seems, therefore, within the limits here given, to vary according to the number of degrees intervening.

Whether the maximum-temperature limit, as such, has any peculiar influence, does not appear from experiments here made. There seems to be no reason to expect such.

With these conclusions may be compared the results of G. Kraus'¹ experiments on tissues of internodes. Judging from the elongation and the contraction of isolated tissues, he found the tensions to change but slightly by variations of

¹ G. Kraus, Bot. Zeit. 1867, p. 124. Compare also Pfeffer, Zur Kenntniss der Plasmahaut und der Vacuolen, &c. Leipzig, 1890, p. 309 (163).

temperature between 14° and 38° C., whereas a considerable decrease occurred by a reduction below 7° or 8° C.

What causes produce these promptly occurring but quickly passing changes?

A number of possible factors suggest themselves.

First, the root as a mass of matter contracts or expands when exposed to changes of temperature in a manner entirely analogous to the changes in length of an iron rod when heated or cooled. Determinations of the coefficient of expansion of tissues like those here concerned seem to be lacking, but judging from those made from wood¹, this factor is so small as to certainly fall within the range of error, and can be entirely neglected.

Second, changes of temperature cause changes of turgor-pressure. From experiments made by Pfeffer², it has been shown³ that turgor-pressure is influenced by temperature-changes in the same manner as gas-pressure. That is, the osmotic pressure increases proportionally to the absolute temperature.

Taking as the coefficient of expansion per degree centigrade 0.00367, or approximately $\frac{1}{273}$, a turgor-pressure of 100 by a temperature increase of 10° C. becomes 103.67⁴. If normal roots of *Vicia Faba* 20 mm. in length be deprived of turgor-pressure⁵ by the action for 30 minutes of a 3 per cent. KNO₃ solution, an average contraction of about 2.0 mm. (drawn from 8 specimens) takes place. If similar radicles be exposed to a sudden change of temperature from 19° to 1° C. the turgor-reduction would theoretically be $\frac{9}{273}$ mm. or 0.132 mm. The average contraction actually found under these conditions was 0.035 mm. It is thus plain that the turgor-changes due to temperature variations are of sufficient

¹ Villari, *Annal. d. Physik u. Chemie*, Bd. CXXXIII (1868), pp. 412, 417. Pfeffer, *Pflanzenphysiologie*, Bd. II, p. 41.

² Pfeffer, *Osmotische Untersuchungen*, 1877, p. 83.

³ Van't Hoff, *Zeitschr. f. physik. Chemie*, Bd. I (1887), p. 486.

⁴ Pfeffer, *Zur Kenntniss der Plasmahaut u. Vacuolen, &c.* *Abh. d. Königl. Sächs. Gesellsch. d. Wissensch.*, Bd. XVI (1890), Heft II, p. 308.

⁵ Pfeffer, *Druck u. Arbeitsleistung*, p. 297.

magnitude to fully account for the transitory changes of length under consideration.

That the change of turgor-pressure finds in the radicle observed an *unmodified* expression is hardly to be expected. The conditions of growth prevailing at the time of a change of temperature seem to modify the extent of the elongation and of the contraction, or, in case no contraction is seen, of the following growth-rate, in much the same way as is noted above (p. 383). The resolution of the resultants into their factors is a problem hardly soluble from the data at hand.

That the sudden temperature-changes may act as stimuli which release growth influencing factors seems not unlikely. If such factors enter, their magnitude is a matter of uncertainty. It seems, in view of these possibilities, justified to regard the changes of length under discussion as due to variations of turgor-pressure modified to a greater or less extent by factors having their origin in the organisms.

It remains to notice the period of depression of growth seen to follow changes of temperature. As has been pointed out in connexion with the individual experiments, this depression varies in duration with the different conditions offered. Plainly a transfer from 20.0° to 1.0° C. can be followed by no recovery, since, at the lower temperature, activity is practically suspended. A transfer in the reverse direction, however, is usually followed by a more or less marked depression of growth. This depression-period may vary in length from a few minutes to days, and, as has been seen in cases, the normal growth may not be regained.

The duration of this phenomenon depends (1) on the location of the lower temperature-limit to which the objects are exposed, and (2) on the duration of this exposure.

In a general way, it may be said that the lower the temperature-limit lies, the shorter the exposure sufficient to produce a depressed growth upon the return to the higher temperature. By shortening the period of exposure sufficiently, the depression may be so far reduced that its presence is not to be detected. Otherwise stated, a certain minimum

exposure is necessary to induce a depression. The duration of this depression increases roughly with the increased period of exposure.

The character of this occurrence seems to suggest a cause that one would regard as probably present. It seems plain that in the depression-period we have the reaction of the living organisms to a stimulus, here represented by the exposure to the low temperature and the shock of the sudden change.

It is not to be forgotten that a prolonged stay in a low temperature may induce in the plants a sort of pathological condition, and that we are then no longer dealing with normal objects¹.

When changes were made between 18° and 30° C. as extremes, evidence of retardation following was not to be detected. The modified rate of elongation following a change of temperature would be fully accounted for by the changes of turgor-pressure having their origin in the differences of temperature. The irritable response to change, if present, is lost in the accidental irregularities of growth. In this case, we must agree with Pedersen², that temperature-change as such has no perceivable effect on plant-growth.

Recapitulation.

The most important results of the second part of this paper are here briefly summed up.

Following a sudden fall or a sudden rise of the temperature between 18.0°–21.0° and 0.5°–1.5° C. as extremes, the first effect seen is a slight turgor-change due to physical causes, producing, or tending to produce, a shortening in length if the temperature be lowered; or, in case the temperature be raised, producing an elongation.

Following this mechanical action, a period of depressed growth usually follows. The duration of the depression-period depends on the position of the lower temperature-limit and

¹ Pfeffer, *Druck und Arbeitsleistung*, p. 354.

² Pedersen, *loc. cit.*

on the length of time of exposure to this temperature. The depression is regarded as the irritable response to the stimulus furnished by the exposure to the low temperature followed by the sudden change to the higher degree. The duration of the depression may be increased by lowering the minimum temperature-limit and by lengthening the period of exposure. An exposure to the lower temperature for less than a certain period of time is followed by no noticeable depression.

Changes of temperature between 18° and 30° C. as extremes seem to be followed by turgor-changes only. That no momentary depression of the growth-rate takes place is hardly to be asserted. Indeed, it is likely that such takes place, but by reason of the slowness of amplitude becomes lost in the more striking spontaneous changes. It is also to be borne in mind that a slight uncontrolled interval follows the change of temperature. That in this interval a slight effect might have escaped observation is also not out of the question.

In conclusion, I wish to express my sincere gratitude to Professor Pfeffer, and to his assistants, especially to Dr. Paul Klemm, for many kind suggestions and helpful criticisms; also for free access to the rich resources of the Institute.

BOTANICAL INSTITUTE, LEIPSIK,
December, 1894.

The Path of the Transpiration-Current.

BY

HENRY H. DIXON, B.A.,

Assistant to the Professor of Botany, Trinity College, Dublin,

AND

J. JOLY, D.Sc., F.R.S.,

Trinity College, Dublin.

—♦—

With Woodcuts 2-8.

—♦—

IN some recent investigations on the ascent of sap, we had occasion to reconsider the question as to whether the transpiration-current is transmitted through the lumina, or, as the supporters of the Imbibition-hypothesis maintain, through the walls of the conducting wood. Although, undoubtedly, the weight of recent experimental work on this question is in favour of the view that the sap moves in the lumina, yet as some of the methods adopted in these experiments were not, as it appeared to us, entirely free from error, we did not consider it superfluous to repeat some of the older experiments, eliminating, as far as possible, sources of error, as well as to add some new ones of our own. The present paper is occupied with an account of these experiments.

*Tracing the course of the Transpiration-Current by means of
Precipitates.*

The first of the older experiments which we will discuss are those in which cut branches are supplied with a salt-solution,

[*Annals of Botany*, Vol. IX. No. XXXV. September, 1895.]

and after this has been drawn up by transpiration, pieces of the conducting tissues are treated with a second solution which forms a precipitate with the first. Examination is then made to ascertain whether the precipitate is confined to the lumen or to the wall. The recorded results of these experiments have been that the precipitate is confined to the lumen, and it is concluded that therefore the first solution has moved in the lumen only. It appeared to us that these experiments involve a full investigation of the question as to whether in any case it is possible for the precipitate to form in appreciable quantities in the wall; for if it cannot, they tell us nothing as to what went on in the wall. The following experiments show the validity of this objection. Thin sections (longitudinal and transverse) of *Taxus baccata*, first soaked for some hours in a strong solution of potassium ferrocyanide or of ferric chloride, were either dried on the surfaces with filter-paper or quickly washed in water, and then treated respectively with ferric chloride or potassium ferrocyanide. On subsequent microscopic examination in no case could any more than a faint blue coloration be observed in the woody walls (perhaps in part only apparent and due to a thin film of precipitate on the cut surfaces of the section), while the lumen was choked with the precipitate. On the other hand, the cellulose walls of the bast, cortex, and medullary rays were deeply coloured, as well as the torus of the closing membrane of the bordered pits. In order to obtain denser precipitates in the lumina, the sections may be transferred several times from one of the mutually reacting solutions to the other. That the walls of the tracheides were thoroughly imbibed with the solutions there can be no doubt, seeing that the sections were very thin. Where the walls were tinted at all, the faint coloration was almost completely limited to the tertiary thickening layers, just as Strasburger has already observed in a branch of *Taxus baccata*, which stood for some days in a solution of potassium ferrocyanide, and was afterwards treated in pieces with iron sulphate¹.

¹ Leitungsbahnen, p. 628.

In order to compare the behaviour of another colloid with that of the woody cell-wall, some gelatine was dissolved in a strong solution of potassium ferrocyanide, so as to form when cool a very stiff jelly. A drop of this when melted was placed on a microscopic slip and covered with a circular cover-glass. When the gelatine had set the slip was transferred into a solution of ferric chloride, which slowly diffused through the gelatine. On microscopic examination no precipitate, if we except a faint coloration, could be detected in the gelatine. The precipitate was limited to the surface of the gelatine at the edge of the cover-glass and to the dendritic cracks formed within the gelatine by contraction under the cover-glass. In the substance of the gelatine itself $\frac{1}{8}$ Leitz failed to show precipitated particles.

As a modification of this experiment thin pieces of solid gelatine were steeped for twenty-four hours in one or other of the salt-solutions, and after their surfaces were dried with filter-paper, so as to avoid carrying any of the first solution which was not contained in the gelatine, they were transferred into the reacting solution. While in the latter a film of dense blue precipitate formed over the surface, and sections of the gelatine showed that ultimately after long steeping in the second solution a pale blue coloration penetrated the colloid.

In view of these results we think the experiments on plants cannot be relied on to prove that the salts did not in part move in the walls, although they certainly support the idea of a ready and free passage in the lumen.

Choking the Lumen by the Introduction of Foreign Substances.

Experiments in which flagging of the branch occurs upon artificial stoppage of the lumen have been relied on as strong evidence in favour of the lumen as the water-way in the tracheal tissue. It was objected to Elfving's experiments that cocoa-butter was of too greasy a nature and might enter the wall, and gelatine was substituted by Errera and Strasburger. We confess that we would have had less appre-

hension of a greasy substance entering the water-saturated wall than a substance miscible in the water such as gelatin and which, even if entering the wall in minute quantities, might be very injurious. Its extreme dilution with water material of the wall might render its detection by the microscope impossible.

We made experiments to test this last possibility. We can only quote some of these. We may observe, however, that all our results agreed in showing the passage of diluted gelatine from cell to cell—possibly taking place in some cases only through the closing membranes of the pits, and consequently possibly altering the permeability of the wall for transpiration of water.

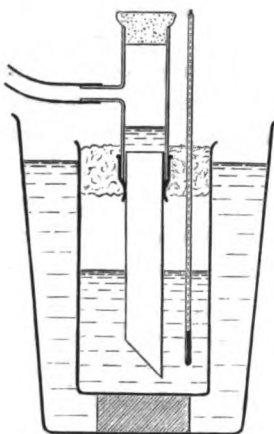

Woodcut 2.

A length of 10 cm. stick was cut and free from side branches. It was cut from a branch of *Taxus ba* the mean diameter being 2.5 cm. This was deprived of its bark and affixed by an india-rubber ring at one end to a glass tube communicating with an air-pump; a quantity of water in the tube covered the lower end of the wood. Woodcut 2 shows the arrangements.) On exhausting the tube, bubbles rose from the surface of the wood. This could be stopped by simply immersing the lower end in mercury. Hence it is to be concluded that continuous air-passages exist in this piece of wood which must be stopped before any tests can be made as to its permeability by gelatine. Accordingly the lower end of the wood was dipped in melted paraffin at about 70° C., the melting-point of the paraffin being 56°, and the whole length of the stick was submerged in water which was maintained at 70° for 45 minutes, a vacuum being preserved in the tube attached to its upper end during this time. Finally the stick was cooled slowly from a

downwards by lowering the water-bath to allow of the contraction of the paraffin being made good by supply from below. When all was cold, the end was pared to expose lumina free from paraffin. The stick now drew up water freely, 3 or 4 cc. in 15 minutes, but let up no air, nor would it suffer mercury to pass up. The water pumped through was next tested by a solution of tannin, but remained perfectly clear. We conclude therefore that no direct air-passages remain open, and that the wood of the Yew itself will give no obscuring reaction with tannin.

Some gelatine which had been cut up into fine threads and soaked in repeatedly changed water for two days was now melted and made very dilute, so that it set weakly at 13°. At a temperature of 30° to 40° this was supplied to the lower end of the Yew, the latter as before being kept warm throughout its entire length by a water-jacket which was never raised above 40°. At the expiration of four hours the liquid within the vacuous tube had risen by about 5 cc. The experiment was then stopped, and the contents of the tube tested with tannin. There was an opalescent precipitate. Comparison with the solution below showed that much of the gelatine had been held back by the wood.

Starting the experiment a second time with the same piece of Yew it transmitted 3.5 cc. in four hours; the liquid drawn up affording this time a much denser precipitate. A final test showed the wood to be still impervious to air when a vacuum was maintained in the tube.

A similar experiment with the wood of *Pinus austriaca* gave a like result. It was observable that if the dilute gelatine was not raised some few degrees above its melting-point—i. e. till the solution almost ceases to be opalescent—its passage was much less marked; indeed in some experiments only traces were transmitted through the wood. This appears to be due to the fact that in solutions presenting an opalescent or milky appearance the gelatine is probably still in the solid or gelatinous state; the heterogeneous distribution and difference of refractive index giving rise to the milky colour. In

all cases a considerable quantity of the gelatine is held back. One quantitative experiment on *Taxus* gave the percentage of gelatine in the transmitted liquid as only half that in the original solution.

In one experiment we stained the gelatine with Kleinenberg's haematoxylin. The gelatine was made of such strength as to set at about 20°, and was supplied at 40° to the wood of *Taxus baccata*. It passed out colourless into the glass tube, about 1 cc. in two hours, the length of the wood traversed being 2.5 cm., and its cross-section 2.2 sq. cm. This wood had not been treated with paraffin, as it revealed no direct air-passages upon trial. As the haematoxylin does not stain wood, this experiment points to a mechanical separation from the gelatine owing to the passage of the latter through membranes or walls. It is possible, however, that some of the stain was taken up by the cellulose walls of the medullary rays and the tori of the pit-membranes.

Microscopical examination of branches choked with gelatine mixed with Indian ink, after the manner of Errera and Strasburger, showed that the closing membranes of the pit had exerted a straining action, accumulating Indian ink upon the one side, so that the pits were very sharply picked out as black objects. This straining action is suggestive of the passage of the medium carrying the precipitate; and although, so far as this observation is concerned, there might have been straining of the gelatine from the water in which it was dissolved, still taken in conjunction with the other observations, we think it supports the view led to by those observations, i. e. that dilute melted gelatine can pass through the substance of the closing membranes, and if so is very probably capable of penetrating into the cell-wall, or otherwise we must suppose perforations to exist in the pit-membrane or its torus.

We decided to try the effect of using paraffin wax of low melting-point as the material for choking the lumina, comparing the effects with those of gelatine. Four similar branches of Lime, *Tilia europaea*, were cut (May 9) as far as

possible under water, and put standing for twenty minutes in water at 50° C., immersed to a depth of about 20 cms. We call these A, B, C, D.

A is preserved in water at 50°.

B is transferred to melted paraffin at 50° (melting-point 48°).

C " " gelatine coloured with Indian ink at 50°.

D " " " " " haematoxylin at 50°.

Each being immersed to a depth of 20 cm. and placed in bright light, the air temperature being 16°. At the expiration of forty minutes all were transferred to water at 13°, when the end of each was thinly pared, and at 5.30 p.m. all were left finally standing in water at 13°. At 6.30 all were still fresh. At 11 a.m. on the 10th, i.e. after 15½ hours,

A was still quite fresh.

B " very much flagged.

C " less flagged than B.

D " " " " B, but more flagged than C.

All were now transferred to a strong solution of saffranine, and put in full sunshine for 1½ hours, when they were washed and sections made for microscopical examination. So far as C and D were concerned, it is only necessary to observe that they revealed that only some of the lumina were actually stopped with gelatine. The walls of many of the gelatine-filled vessels were found stained with saffranine, which attained to 26 cm. in C, and to 5 cm. in D. The gelatine in the lumina had become stained with the saffranine.

Transverse sections of B close to the base showed all lumina choked with paraffin, while the walls between were deeply stained with the saffranine.

In polarized light with crossed nicols the appearance was very striking, the crystalline paraffin showing out strongly. Transverse sections, 2 cms. from the end, showed the large vessels still filled with paraffin. In some places neighbouring vessels apparently quite filled with paraffin had the intervening walls deeply stained; at this level, however, where the vessels were filled with paraffin the wall-staining was not quite so dark

as elsewhere, but still strongly coloured. The paraffin finally attained a height of 12 cm. in one or two vessels. In no case was there any visible appearance of shrinkage of the paraffin from the wall, although in some sections, as might be expected, the action of the razor was to compress it from the cell-wall upon the one side over the section.

Similar experiments were made on Elm and Lime, with the added precaution of removing the paraffin or gelatine at the ends without cutting or removing any of the wood. This was effected by careful use of the razor, the object being to avoid as far as possible laying open the lumina of conduits whose terminal walls might lie upon the surface of the section. In the case of Elm and Lime again, sections taken about half a millimetre from the end showed areas over which the filling with paraffin was complete, and yet also deep staining of the intervening walls. Longitudinal sections near the end confirm this appearance; the lumina seemed quite filled. In these cases the removal of the branches from the hot paraffin was effected gradually, to secure as far as possible that solidification and shrinkage should proceed slowly from above downwards, and thus guard against shrinkage leading to the withdrawal of the paraffin out of contact with the wall. Again, the branches of Lime treated for comparison with gelatine revealed areas in the cross sections completely injected with gelatine and yet having the walls deeply stained. Thus we see that both in those experiments in which the lumina were choked with paraffin and with gelatine there was at least a feeble upward motion of the solution of saffranine in the walls. Lime-branches treated with paraffin, in some places close to the cut surface, showed the penetration of this into the protoplasm-filled cells, permeating their contents. High up, only the larger vessels were filled with paraffin.

The result of these experiments may be summed up as follows:—

The stoppage of the lumina and the freedom of the cell-wall is preserved both by the use of gelatine and paraffin.

The flagging of the leaves appears to be the more rapid

the more completely the closing of the lumina has been effected.

When the lumen is closed there is still an upward passage of liquid maintained in the wall, but which is probably much too feeble to meet the wants of the leaves.

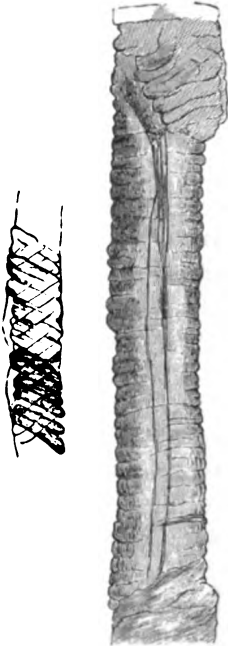

Woodcut 3.—Cast of Lime.

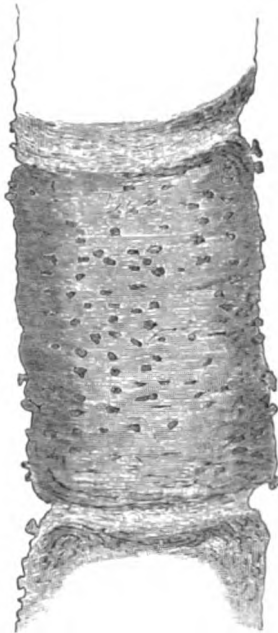

Woodcut 4.—Cast of Lime.

Owing probably to its extreme mobility the penetration of the paraffin is very complete in these experiments, We found it easy by its means to demonstrate the continuity of the tracheal elements forming the vessels in Lime, Sycamore and Elm. We experimented up to lengths of 35 cm. by removing with sulphuric acid the wood of branches injected as above. It is necessary to anchor the branch by a leaden weight in a deep vessel of the acid. A single night suffices in many cases to remove the wood and leave the paraffin casts of the



vessels streaming upwards from below like a sheaf of fine white threads. The examination of these threads under the microscope reveals many features of interest. Woodcuts 3-5 represent portions of some of these casts.

Some further experiments were made bearing upon the ascent of water in the wall. All confirm the fact that an appreciable quantity of water ascends in branches most carefully choked with paraffin.

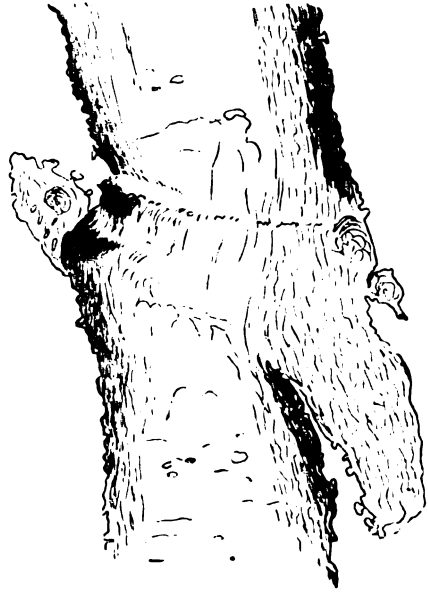

Woodcut 5.—Cast of Elm.

Thus while flagging will inevitably overtake a paraffined branch left furnished with the same number of leaves as it bore upon the tree, yet if the greater number of these are removed the remaining leaves will generally hold out fairly well. This experiment was tried with a control paraffined branch upon which all the leaves were left standing.

If after injection we remove part of the branch at a fork

and, keeping the one part which retains the paraffined extremity in water, insert the extremity of the other through a cork into a dry vessel, the latter will flag much the more rapidly. Still more direct is the following: a paraffin-injected branch of *Tilia europaea* with nine leaves was put standing, from 4.15 p.m. May 11th till noon on the 12th, in a vessel of water which had been carefully weighed and so closely corked round the stem as to preclude possibility of loss by evaporation at its surface. In this period of nearly twenty hours the branch drew up 1.005 grammes of water. This same flagged branch, now put out into breeze and intermittent sunshine from noon till 3.30 p.m., drew up 0.161 grammes.

Again of two paraffin-injected Lime-branches, one just scraped to free the surface and placed in water, the other left closed with its cap of solid paraffin; the latter flagged much more quickly, although it bore a smaller number of leaves. In two days the latter was, indeed, dry and shrivelled, while the former had preserved much of the freshness of its leaves.

Bearing on this same point—the partial passage of water through the walls—the following experiments were next carried out, in which it was sought to replace the paraffin or gelatine by a gas developed in the plant. Thus a cut branch first supplied from a solution of tartaric acid and subsequently of sodium bicarbonate will have carbon dioxide evolved in the lumina of its conducting tissues in consequence of the reaction of the salts.

A preliminary experiment upon a Lime-branch (*Tilia europaea*) which had stood for two hours in a solution of tartaric acid and then one hour in sodium bicarbonate, before finally being transferred to pure water, showed rapid flagging of its leaves and soft shoots as the result. But as this was possibly a direct consequence of the action of the salts and not of the evolved gas, a more careful experiment was carried out upon five branches of Elm cut from the same tree with similar precautions and as far as possible of like dimensions.

A and B were placed in sodium bicarbonate solution.

C and D were placed in tartaric acid solution.

E was placed in mixed solution of tartaric acid and sodium bicarbonate which had ceased effervescing.

After 1½ hours A and C were interchanged in the solutions; thus, in these two only was CO₂ developed. B served as a control regarding the effects of sodium bicarbonate alone, D ditto for tartaric acid, E ditto for the effect of the mixed solution without development of gas. In five hours A and C were very much and about equally flagged, while the rest remained fresh. Next morning, however, all were drooped, showing that prolonged treatment with any or both of these salts is injurious in any case. It was evident also that the stoppage of the lumina by the gas had greatly accelerated the flagging.

It is not probable that the check upon aeration of the tissues involved in all of the foregoing experiments wherein the lumen is choked could account for so rapid a flagging of the soft parts. However, to set this doubt at rest, we inserted branches in water which had been boiled and cooled in vacuo and coated with oil after the insertion of the branch. These, however, remained perfectly fresh, indeed they seemed in no way affected.

Choking the Lumen by means of Ice or Water Vapour.

In order to investigate this subject more fully an additional series of experiments were devised and carried out upon the passage of water through the wood of *Taxus* at very low and at very high temperatures. For it was very certain that in the one case the formation of ice, and in the other the formation of steam, would occur in the lumen before occurring in the wall, rendering the former non-conducting without the introduction of any foreign substance.

It was necessary to determine first of all the freezing-point of water in the lumen by direct microscopic observation. To effect this we used a form of cold stage which possesses certain advantages which induce us to add the accompanying figure (Woodcut 6) showing its construction. In this stage the object

under examination is completely surrounded by the cooling liquid, which also flows round the bulb of the thermometer. The temperature is therefore very accurately known. The bottom of the cell is of glass; a ring screwing out upon the top serves to permit the lifting of a cover-glass acting as a water-tight window, this being luted on the edge with a little white lead. The object is luted between two cover-glasses and carried upon an open support within. It is necessary to protect the upper window from moisture precipitated from the atmosphere; this is done by the loose metal ring surrounding the object-glass and packed round with a little cotton wool. The thermometer enters by a

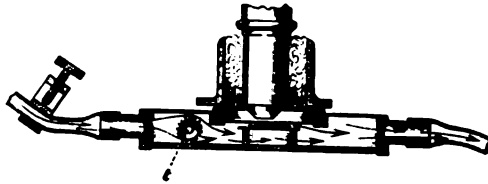

Woodcut 6.

tubulure in front; its bulb appears in cross-section at *t* in the Woodcut. The regulation of the temperature is very simply effected by retarding or accelerating the current of cold liquid (brine) by means of the pinch-cock.

The section of *Taxus* is cut with as little addition of moisture as possible, so that when luted up between cover-glasses it is surrounded by air while containing water within its substance. The close proximity of the section to the upper window, some 1.5 millimeters, allows of considerable magnification.

The cold cell, after the introduction into it of the section sealed up between the cover-glasses, is placed on the stage of a microscope, and then, by the arrangement already described, the temperature is caused to fall gradually, while the water within the section is carefully observed.

The phenomena attending freezing were perfectly definite,

the clear liquid in the lumina assuming the aspect of solid paraffin. In two experiments in which the reduction of temperature was effected very gradually the freezing-point was found to lie between -10° and -11° C. Freezing spread with great rapidity all over the field in both wide and narrow lumina. Air-bubbles present exhibited immediate reduction of volume and often distortions of shape, and it was important to observe that an exudation of sap occurred upon bare cell-walls which appearing in drops instantly turned to rough-shaped ice-crystals.

Thawing occurred at a higher temperature than freezing, no signs of melting being exhibited till -4° or -5° were reached. This specimen of wood was removed from a branch

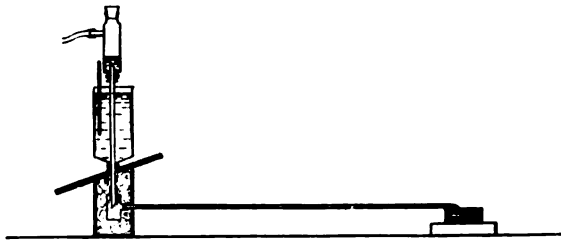

Woodcut 7.

which had been standing some days in water. A freshly cut branch of *Taxus* afforded 14.5° as the freezing-point; showing that the state of the sap appears to affect the freezing-point considerably.

Owing to the pressure-effect of the ice upon the wall visibly shown by the forcible expression of drops, there appeared some doubt whether this method would afford any result of value. However, the experiments were persisted in, and a length of 22 cm. by 6 mm. in diameter of a *Taxus*-twig, carefully washed, was attached to the apparatus shown in Woodcut 7, in which the passage of liquid through the vertically placed stick (due to a diminished air-pressure in the vessel above) is shown by the movement of mercury in the horizontal capillary tube.

The rate of transmission of water was observed while the temperature of the jacket was varied. The general results were as follows:—

In *cooling*, the current had almost ceased at -7° and completely at -11° ; in *warming*, it recommences feebly at -5° . It was impossible to fix upon any temperature as the actual freezing temperature in the lumina from the observations, but as all current had ceased at -11° , at which temperature the water in the walls was almost certainly not frozen, we must

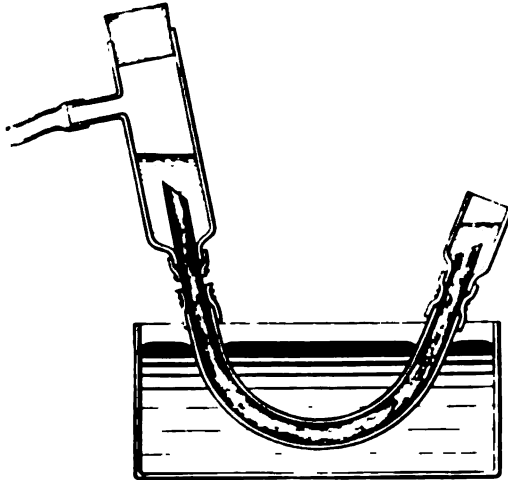

Woodcut 8.

conclude that these observations reveal no current in the walls even of the feeblest intensity, for the method of observation is very delicate. However, the method is beset by the doubt involved in the evident ice-pressure upon the walls.

Experiments in which the wood of *Taxus* was exposed to high temperatures—above 100° C.—appear to show that coloured water can be drawn through the wood when this is at a temperature so high as 125° , and very certainly filled with water-vapour everywhere in its lumina.

Woodcut 8 shows and explains the arrangement of the

experiment. The vessel into which the branch dips contains mercury heated from beneath. A glass tube surrounds the branch, the space between branch and glass being filled with mercury. To resist the tension of the vapour evolved from the surface of the wood at this temperature it was necessary to bind the stick into the tube with air-tight rubber rings overlaid with wire. The following experiment was made:—

A small branch of *Taxus baccata*, 24 cm. long, having a woody cylinder of 5–6 mm. in diameter and being composed of nine annual rings, was kept jacketed with mercury at 125°–130° for eight minutes, while its basal end was attached to an air-pump so that the atmospheric pressure acted from the distal end through the branch. The water was then replaced by a strong solution of eosin, and the whole, still kept at 125°–130°, was left for two hours. Then the experiment was broken off. The eosin being first removed, the surface to which it had been applied was re-cut and dried. The branch was then detached from the air-pump and allowed to cool. On microscopic examination it was found that the eosin-solution had passed 22 cm. up the stick, and at this height was seen in cross-section as two irregular patches occupying quadrants in the seventh and eighth rings. The walls of these were uniformly coloured. At the level of the mercury jacket and throughout the 7 cm., where the branch was immersed in mercury, the colouring was most intense in the limiting membranes. At the end where the eosin was applied the walls were scarcely coloured except those adjoining the medullary rays and immediately round the bordered pits.

The simplest interpretation of these results is that the coloured water moved in the wall while the lumen was occupied with vapour; the intenser colouration of the limiting membrane is strongly in support of this view, for it is very probable that for some distance from its surface the wall was so far choked with vapour as to impede the motion of a liquid.

These experiments then, so far as they go, are in perfect agreement with the previous set in which the lumina are

choked by the introduction of foreign substances (cocoa-butter, gelatine, air, in the experiments of other authors, or by paraffin and CO₂ in our own), and show that the freedom of lumina is necessary for the rapid transmission of water, yet that a slow current may pass through the wood even when the lumina are completely blocked.

The Water transmitted in the Lumen is not in the Form of Vapour.

There appeared the possibility that the flagging of the branches having closed lumina might be due to the stoppage of them as vapour-conduits, and not as water-conduits; that is, the experiments were not yet conclusive as to the actual function of the lumina, although showing clearly that the freedom of them is essential to preserve the turgescence of the leaves. The well-known phenomenon of the equilibrium vapour-tension varying with the curvature of the meniscus suggested the possibility that a transport of vapour of considerable importance might occur in the conduits, the meniscuses high up in the trees possessing a lower equilibrium vapour-tension than the meniscuses lower down. By successive condensations beneath and evaporations above the pit-membranes, this current might be maintained throughout the conduits unoccupied by liquid water.

This idea led to experiments in which cut branches were fed entirely upon water-vapour in the following manner:— The branch had its cut extremity fixed in a short glass vessel containing water at the bottom; the cut surface of the wood (which is cut at a sharp angle in order to expose the larger surface) being some 5 or 7 cm. raised above the surface of the water. A side tubulure to the vessel enables a vacuum to be maintained within by means of a Sprengel pump. The vacuum was so complete that ebullition occurred upon placing the hand round the lower part of the vessel. Such experiments were made upon Elm and Lime, using

420 *Dixon and Joly.—The Transpiration-Current.*

control branches some of which were simply left with their cut surfaces exposed to the air, others with their ends sealed into tubes containing air but no liquid water. In no case was any result obtained going to show that the vapour-fed branch possessed any advantage over the others.

The 'Spot' Disease of Orchids.

BY

GEORGE MASSEE, F.L.S.,

A Principal Assistant, Royal Herbarium, Kew.



With Plate XV.



THE disease known as 'spot,' which appears under the form of brown spots or blotches on the living leaves of orchids, is unfortunately too familiar to cultivators and admirers of these plants, and although the health of the plant is not materially affected, except when the spots are unusually numerous, nevertheless the unsightly blotches on the leaves detract greatly from a full appreciation of the beauty of orchids when in bloom.

The disease first appears under the form of minute pale spots, one to two millimetres in diameter, on the upper surface of the leaf, which vary considerably in number and arrangement, being in some instances numerous and crowded, in others few in number and scattered. Every portion of the leaf is equally susceptible to the disease, and the fact that very young leaves of diseased plants frequently show 'spot' has been considered by some as strong evidence in favour of the disease being due to some parasitic organism; this, however, is not the true explanation, the disease proving conclusively to be of a non-parasitic nature, and with proper

precautions to be entirely under the control of the cultivator. My previous note¹ announcing that 'spot' was due to the presence of an organism called *Plasmodiophora orchidis*, was based upon the absolute agreement with the microscopic details of two diseases of vine leaves described by Viala and Sauvageau², and attributed to the presence of two organisms called *Plasmodiophora vitis* and *Plasmodiophora californica* respectively. Returning to the orchid disease; the minute pale spots already alluded to, which, it may be remarked, are not at all conspicuous, and are likely to escape observation unless specially looked for, soon assume a pale brown colour and gradually increase in size, retaining an irregularly circular outline, until they attain a diameter varying from four to eight millimetres. When the spots are numerous and near together they frequently run into each other, forming irregular blotches of variable size and form. As the disease progresses the spots become darker in colour, and owing to the collapse of diseased cells beneath the epidermis, the surface of the spot becomes depressed below the level of the surface of the leaf (Fig. 1). In many instances the disease passes completely through the leaf, forming a corresponding brown depressed spot on the under surface.

Microscopic examination shows the following details. The first indication of disorganization is plasmolysis, followed by the complete disappearance of the chloroplasts from the palisade-cells of the leaf, hence the pale colour of the spots during the first stage of the disease. This is immediately followed by the appearance of a highly refringent, hyaline, oleaginous looking sphere in each cell. During the early period of formation, the centre of the sphere presents a granular appearance, and when broken up and treated with a solution of iodine, the granules prove to be minute starch grains, which were liberated from the disintegrated chlorophyll grains, and engulfed during the formation of the sphere

¹ *Annals of Bot.*, Vol. ix, p. 170 (1895).

² *La Brunissure et la Maladie de Californie.* *Journ. de Bot.*, Tom. vi, pp. 355 and 378, Pl. XII (1892).

(Fig. 2 b). Within three days from the first appearance of the spheres, the enclosed starch grains have become completely dissolved and their substance added to the common mass. If at this stage a section through a diseased spot be placed in water and examined under the microscope, the spheres will be seen to undergo vacuolation, gradually changing from the previous solid condition into hollow vesicles, the walls of which become irregularly perforated or reticulated, the configuration of the network slowly and constantly changing after the fashion of the movements presented by the vegetative phase of *Plasmodiophora Brassicae*, but differing in the movements being of a purely physical nature, the perfectly homogeneous membrane becoming thinner in proportion as the vesicle increases in size, and in constantly retaining a rounded, even contour. Increase of size usually continues until the vesicle fills the cell in which it is contained (Figs. 2 c, and 4). Vacuolation takes place exactly as stated above when sections are placed in a one per cent. solution of osmic acid instead of water, which, taken alone, is sufficient proof that the spheres in question are not of an amoeboid nature. In some instances, instead of one, several spheres are formed in a cell, each undergoing vacuolation, but remaining comparatively small in size.

The composition of the spheres is proved by the action of reagents to be complex, and although I have sometimes spoken of them as tannin-vesicles, it must be clearly understood that I do not intend to convey the idea that they consist entirely of tannin, although agreeing in many respects with the structures called tannin-vesicles by Klercker¹.

That tannin is present is shown by the following reactions. Potassium bichromate produces a bright brown precipitate, insoluble in water; an aqueous solution of cupric acetate causes a dingy brown colour, which changes to green when subsequently treated with an aqueous solution of ferrous sulphate; a 1 per cent. solution of osmic acid blackens the spheres, but as previously stated, does not prevent vacuolation. Finally,

¹ Studien über die Gerbstoffvakuolen. Tübinger Inaugur.-Dissert. 1868.

the accumulation of methylene blue by tannin-bearing cells, as pointed out by Pfeffer¹, held good, the vesicles becoming stained deep blue after remaining in an exceedingly dilute aqueous solution of methylene blue for twenty-four hours; iodine-green may be substituted for methylene blue with good results. All the above reactions are most decided before vacuolation takes place; in fact, when the vesicles are fully distended, but little colouration is produced by any of the reagents mentioned. On the other hand, the presence of proteids in the spheres is suggested by the rapid staining of the mass, on the application of such reagents as eosin, carmine, iodine, &c. Carbohydrates are also in all probability present.

The spheres originate in the cell-sap, and their presence depends entirely on plasmolysis of the cells, which occurs during the earliest phase of the disease.

Contemporaneously with the formation of the tannin-vesicles the cytoplasm becomes turbid, the primordial utricle at the same time becoming tinged brown, and undergoing important changes. In some cases the inner surface of the latter becomes uniformly covered with minute, spherical masses, and in this condition resembles, superficially, cells filled with the spores of a *Plasmodiophora*; here, however, the resemblance ends, as the minute spheres are found to form only a single layer lining the primordial utricle, and not completely filling the cell, as in *Plasmodiophora*; furthermore, reagents show that the spheres consist of tannin, and not protoplasm (Fig. 7 *b*). In other cases the inside of the epiplasm, and sometimes also the cell-wall—which, along with the other parts, undergoes disintegration—is covered with tubes or variously branched, very slender rods of a brown colour. Usually, however, the epiplasm or primordial utricle becomes entirely disorganized, drops of tannin accumulate at various points in its substance, accompanied in many instances by minute crystal-like bodies. These eventually disappear,

¹ Ueber Aufnahme von Anilinfarben in lebenden Zellen, Unters. a. d. bot. Institut. zu Tübingen, Bd. II, p. 179.

leaving holes in the membrane, which, along with others previously present, produce an irregular reticulation, the whole being of a brown colour (Fig. 7 *a*). The nucleus of the cell frequently remains unchanged throughout the entire cycle of disease, as shown in Fig. 7 *a*, *x*.

In Viala and Sauvageau's account of the vine disease previously alluded to, vacuolated tannin-vesicles and the reticulated primordial utricle have been respectively interpreted as constituting the vegetative phase of their supposed *Plasmodiophora vitis*; Figs. 2 and 4 illustrating their monograph representing the former, and Fig. 1 the latter.

The investigation of the disease under consideration was at first pursued along lines suggested by the preconceived idea that a fungus was the cause of the mischief, and it was only after numerous and varied experiments had failed to demonstrate the existence of the hypothetical fungus, that a search was made for bacteria, but with a like result. Finally, failing to induce the disease in healthy plants by inoculation with the expressed juice from diseased spots, even when introduced under the epidermis, thus proving the absence of an enzyme or organic ferment, which would have been due to the presence of fungi or bacteria, this was accepted as corroborative evidence of the absence of these organisms.

At this stage Mr. W. Watson, Assistant Curator, Royal Gardens, Kew, whom I take this opportunity of thanking for numerous practical hints during this investigation, suggested a sudden chilling of the plants as a probable cause of the disease. Acting on this suggestion, the following somewhat drastic experiment was undertaken.

A young healthy plant of *Habenaria Susannae*, R. Br., perfectly free from 'spot,' and which up to the date of the experiment had been growing in a house having a temperature ranging between 75 and 80° F., was selected for experiment. Minute particles of ice were placed at intervals on the uninjured epidermis of the upper surface of the leaves, the plant—along with the pot in which it grew—was then placed in a sink and covered with a bell-jar, and cold water

from a tap allowed to flow over the bell-jar for twelve hours, during which time the temperature inside the jar ranged between 41 and 45° F. Twenty-four hours after the experiment, the points on the surface of the leaves originally covered by particles of ice were pale in colour, and on examination under the microscope, plasmolysis of the cells of the palisade-tissue, and degeneration of the chloroplasts were found to have taken place. The remaining spots were examined at intervals, and within four days every phase of the disease was observed, agreeing in every respect with the features already described.

The foregoing experiment showed that a sudden fall of 30° of temperature could not induce 'spot' on the dry surface of the leaf, but only at those points where it had been moistened by the melted ice. That the chill caused by contact with the ice itself was not necessary for the formation of 'spot' was proved by a second experiment with the same species of plant, all the conditions being as nearly as possible counterparts of those in the first experiment, excepting that minute drops of water at a temperature of 45° F. were placed on the leaves instead of particles of ice. A diseased spot appeared at each point previously occupied by a drop of water, and showed all the microscopic characteristics of true 'spot.' Numerous additional experiments, with the object of determining the minimum depression of temperature necessary to produce the disease, showed that the formation of 'spot' could not be induced by a fall of less than 9° F. from the average temperature in which the plant had been previously growing. One other point in regard to temperature was clearly demonstrated by the experiments, viz. that plants which had previously grown in a high temperature became diseased at a much smaller reduction of temperature than plants previously accustomed to a comparatively low temperature.

In conducting the experiments described above, irregularity in the appearance of the spots in different specimens of the same species, even when conducted under precisely similar

conditions as to temperature, showed that some other undetermined factor exercised an influence. After repeated experiments this proved to be the relative amount of moisture present in the plant. After a pseudo-bulb with its accompanying leaf had been removed from a plant and allowed to remain for three days in a dry place, it was found impossible to produce spot by the method mentioned above, whereas with a similar specimen removed from the same plant, and having the pseudo-bulb placed in water at once, fully developed 'spot' could be produced in four days. Similar results were obtained when experiments were made with entire plants; those copiously supplied with water at the root, and grown in a high temperature, 'spotting' readily; whereas plants in a resting condition, scantily supplied with water and kept in a low temperature, usually resist all attempts to produce 'spot' artificially.

It may be mentioned that, other conditions being equal, 'spot' can be produced with the greatest certainty, and in the shortest amount of time, when the experiment is conducted in an atmosphere saturated with moisture. This agrees with the experience of gardeners, who state that 'spot' is most prevalent in foggy weather.

Experiments show that 'brunissure,' or browning of vine leaves, when the plants are grown in the open air, can be caused by the following combination of meteoric conditions. A copious deposition of dew and rapid fall of temperature, following heavy rain. Similar conditions produce the disease in the leaves of tomatoes, which has been described by Abbey¹ as due to an organism named by him *Plasmodiophora tomati*.

SUMMARY.

The orchid disease known as 'spot' is of non-parasitic origin; the initial cause being the presence of minute drops of water on the surface of the leaves at a time when

¹ The 'drooping' disease in Tomatoes. *Journ. Hort.*, Ser. 3, Vol. xxx, p. 360 (April 25, 1895).

the temperature is exceptionally low, and the roots copiously supplied with water.

The effect of the chill produced by the drops of water under the above-mentioned conditions, is to cause plasmolysis of the cells of the leaf underlying the drops; this is followed by the precipitation of tannin and other substances, and eventually the complete disintegration of the cells.

'Spot' in the broadest sense of the term, which would include the effects of exceptional meteoric conditions on the living parts of plants, more especially the leaves, when growing in a state of nature, is, in the case of cultivated orchids, mainly if not entirely caused by the three following conditions:— (1) too high a temperature; (2) too much water, and not sufficient air in contact with the roots; (3) watering or spraying with a falling instead of a rising temperature.

EXPLANATION OF FIGURES IN PLATE XV.

Illustrating Mr. Massee's paper on the 'spot' disease of orchids.

Fig. 1. Leaf of *Eria rosea* showing the appearance produced by the 'spot' disease. Nat. size.

Fig. 2. Section through portion of a diseased spot on the leaf of *Eria rosea*. The cells at the periphery of the diseased spot have the protoplasm only slightly tinged brown, and the tannin-vesicles are still small and not at all vacuolated, as at *a*; at *b*, the tannin-vesicles are larger, granular at the centre, and appear as if radially striate, due to the commencement of a fine-meshed vacuolation. At *c*, the tannin-vesicles have reached the extreme stage of vacuolation, their substance being reduced to a thin film which soon collapses. In the preparation, owing to being mounted in water containing only a trace of glycerine, the brown protoplasmic contents of the cells, which were plasmolysed and free from the walls, have in many instances become again expanded so as to fill the cells. The tannin-vesicles are stained with a saturated aqueous solution of potassium bichromate. $\times 450$ diam.

Fig. 3. Tannin-vesicles in various stages of development in leaf of *Eria rosea*. The other cell-contents are omitted. $\times 450$.

Fig. 4. Tannin-vesicles in cells of leaf of *Masdevallia Reichenbachiana*; at *a* the vesicles are small and not much vacuolated, hence take the stain readily; at *b* the vesicles have become much vacuolated, and nearly fill the cell, hence the membrane is very thin and does not stain, or very slightly. The other cell-contents are not shown. $\times 450$.

Fig. 5. A cell from a diseased 'spot' from the leaf of *Eria rosea* showing the primordial utricle or epiplasm containing drops of tannin, stained with potassium bichromate; the small angular dark patches consist of some substance soluble in water, and when these and the tannin drops disappear, the perforated epiplasm has been mistaken for the plasmodium of *Plasmodiophora*. $\times 450$.

Fig. 6. Section through portion of a 'spot' in the leaf of *Bulbophyllum Carey-anum* showing the primordial utricle presenting the appearance of the plasmodium of *Plasmodiophora*. $\times 450$.

Fig. 7. Section through portion of a 'spot' in leaf of *Eria rosea*; at *a* the epiplasm has contracted, become brown, and presents the appearance that has been mistaken for the plasmodium of *Plasmodiophora*; *x*, the nucleus of the cell. At *b*, the epiplasm is completely covered with minute, uniform globules of tannin, which superficially resemble the spores of *Plasmodiophora*. $\times 450$.

On the Essential Similarity of the Process of Chromosome Reduction in Animals and Plants.

BY

J. E. S. MOORE, A.R.C.S.

IN his recent and adverse criticism of Prof. Strasburger's¹ suggestion that the process of chromosome reduction is probably similar in both animals and plants, Dr. Haecker² appears to rely exclusively on the zoological observations relative to this subject which are contained in the works of Rückert, vom Rath, and himself.

It should, however, be remembered that in the work entitled *Befruchtung*, published in the *Ergebnisse* for 1891, Boveri³ concludes the paragraphs which deal critically with some of the very papers on which Dr. Haecker has attempted to rest his plea for the universal existence of the 'Reductionstheilung,' in the following words: 'Durch die vorstehenden Erörterungen glaube ich gezeigt zu haben, dass zwar gewisse Vorgänge beschrieben worden sind, die vielleicht mit der Chromosomenreduction in Zusammenhang stehen, dass uns aber eine wirkliche Einsicht in diesen Vorgang bis jetzt fehlt. Es bleibt weiteren Forschungen vorbehalten, dieses Dunkel aufzuklären.' It is obvious that the eminent cytologist of Munich does not view the universal existence of a 'Reductionstheilung' as any-

¹ *Ann. of Bot.*, Vol. viii, 1894, p. 281.

² The reduction of the Chromosomes in the sexual cells as described by botanists. *Ann. of Bot.*, Vol. ix, 1895, p. 95.

³ *Ergebnisse der Anat. und Entwicklungsgeschichte*, Bd. I. 1891, pp. 425, 467.

thing like so certain as Dr. Haecker's statements would lead one to suppose. In fact, when the whole of the current observations relative to the maturation of the sexual elements of animals are taken into account, it is quite clear that Dr. Haecker speaks more or less entirely for himself and the supporters of the particular theory of heredity which he adopts.

This is rendered the more obvious from the contents of the foot-note on page 99, in which he says that 'there is at the present day only *one* observation which directly opposes this generalization (the universality of the 'Reductionstheilung'). Compare Brauer, *Archiv für Mikr. Anat.*, V, 42, 1893, although I had, as a matter of fact, previously published accounts of the maturation of the male sexual element in Mammals¹ and Elasmobranchs², which, in agreeing with the corresponding processes of plants, were quite as much opposed to the hypothesis in question as any observations made by Brauer.

The conception of a 'Reductionstheilung' is claimed as a necessary consequence arising from the premises of Weismann's theory of Heredity, and is defined as a division in which half the nuclear elements, idants, or chromosomes, pass unsplit into each daughter-cell. As Weismann³ says—'the reducing division does not consist in the idants becoming split longitudinally, and in their resulting halves being

¹ Mammalian spermatogenesis, *Anat. Anz.* VIII, 1893, p. 683. In this paper the course of the spermatogenesis was summarized as follows: 'There is in the Rat, (1) a period of indifferent cell-formation, terminated by a mitosis with apparently sixteen chromosomes both in the primary and daughter-cells; (2) a period of growth, during which the sixteen elements are converted into eight, and terminated by a mitosis in which the daughter-nuclei still retain the number eight; (3) a period during which the spermatids are converted into spermatozoa.' There is obviously no 'Reductionstheilung,' but the process of maturation of the sexual cells is exactly comparable to that which occurs among the higher plants.

² On the germinal Blastema, and the nature of the 'so-called' reduction division in the cartilaginous fishes, *Anat. Anzeig.* IX, 1894, p. 548. In this paper I fell into the error of supposing that a reduction occurred in the rest between the two last divisions; this is not the case, and my mistake was due to want of optical power and successful preservation. With this correction the spermatogenesis of Elasmobranchs is exactly comparable to that of mammals, except that two generations follow the great spermatid heterotype, instead of one. The last division is a heterotypic one.

³ The Germ-plasm, Parker's translation, p. 236.

distributed equally amongst the two daughter-nuclei as in ordinary nuclear division, but in one half of the entire number of rods passing into one daughter-nucleus, and the other half into the other.'

In 1890 O. Hertwig¹ described the last mitosis in the spermatogenesis of *Ascaris* as possessed of this peculiar character, and the announcement was at once greeted by the supporters of Weismann's theory, as a demonstration of their leader's views. 'Reductionstheilungen' were immediately described in many forms, and Ischikawa² was so much impressed with the similarity between the last spermatogenic and oogenic divisions in *Diaptomus* and those described by Hertwig, as to say when speaking of the latter's paper, 'In this work is given for the first time a clear insight into the exact parallelism existing between the egg and sperm-cells—every point in which corresponds so exactly with the descriptions given in this paper, that it seems almost superfluous to have published them.'

But in spite of this, the difficulties of getting the original conception of the process to fit in with spermatogenic and oogenesis (like that of *Branchipus* described by Brauer³ for example), have evidently led Dr. Haecker to have recourse to the 'schema' given on page 98, and to hypothetical arrangements of the chromosomes, by which (if they exist) something equivalent to a 'Reductionstheilung' may occur. All this is an ingenious piece of dialectic fencing, but at the same time quite sufficient in itself to show that the Reductionstheilung as a base on which to build a theory of heredity is not likely to be worth much now.

In 1893, however, Brauer⁴ published another and more elaborate account of the spermatogenesis of *Ascaris*, which

¹ Vergleich der Ei- und Samenbildung bei Nematoden, Arch. für Mikr. Anat., Bd. XXVI, 1890, p. 1.

² Spermatogenesis, oogenesis, and fertilization in *Diaptomus*, Journ. Sc. Coll. Tokayo, Vol. v, p. 22.

³ Über das Ei von *Branchipus Gmeli* var. *Dyb.* von der Bildung bis zur Ablage, Anhang z. d. Abhandl. d. Kgl. Preuss. Acad. d. Wissensch. Berlin, 1892.

⁴ Arch. für Mikr. Anat., Vol. xliii, 1893, p. 153.

in respect to the last division of the spermatogenesis differed entirely from that given by Hertwig¹; in fact, the phenomena as described by Brauer come, as we shall see, exactly into line with the corresponding processes in plants.

Now it is extremely unlikely that Brauer would criticize this point in Hertwig's work, unless he were quite sure that the process of maturation in the sexual cells of *Ascaris* went forward in the manner he describes, but if it is true that it does, it is also tolerably obvious that the modern work which is said to have supported the universal existence of a 'Reductionstheilung,' rests on a false foundation.

Contemporaneously with Brauer², I had been working on the same phenomena in mammals, and although fully expecting to confirm the existence of a 'Reductionstheilung,' the more I became acquainted with the maturation of these cells, the more I was convinced that no reduction of this kind really occurs.

If there is one histological feature of mammalian spermatogenesis more marked than the rest, it is the division terminating the individual existence of the 'growing cells,' which are known under several different names in the literature dealing with them. Now the division of these cells is, as I have shown, a normal mitosis, and is carried out in the peculiar manner for which Flemming used the name of 'heterotypic.' Further, there are peculiarities in the prophase of this division which, together with the great size of the cells, and the fact, that among Mammals, just as in Amphibia, Elasmobranchs, and Birds, it is invariably preceded by a more or less extended series of 'homotype' divisions, render it evident that throughout the above enumerated types, the advent of the great heterotype division constitutes a corresponding and homologous stage in the development of their respective sexual cells.

In the spermatogenesis of these animals, the heterotype division forms, so to speak, a landmark which is common

¹ Loc. cit.

² Loc. cit.

to them all, just in the same way that the formation and division of *spore mother-cells* marks a corresponding stage in the evolution of the reproductive elements in various forms of plants. It can, in fact, be used as a point from which to reckon the whole course of the spermatogenesis, just in the same way that we may speak in plants of the generations before and after the formation of the spore mother-cells.

Now one of the most remarkable features of the spermatic heterotype in animals lies in the fact that the number of the chromosomes (i. e. separate chromatic elements) appearing in its prophase is always half that of the preceding homotypes. In like manner the number of the chromosomes in the division of the spore mother-cells of plants is always half that in the preceding cellular generations; and this number, in animals as in plants, seems generally to be retained throughout any subsequent mitosis that may occur after the heterotype has been introduced.

From all this it will be evident, that there are known to exist changes in the reproductive cells of many animals which are sufficient in themselves to fulfil any physiological requirements arising from the facts that the number of the chromosomes is specifically fixed, and that it is necessary to halve this number before fertilization can occur.

It will further have been seen that this halving of the number of the chromosomes is not brought about by any division at all, but occurs in the *resting* condition of the cells, before the prophase of the great heterotype begins. Now these changes which lead up to the prophase of this division, in which the reduced number of the chromosomes first appears, are marked in all those forms with which I am acquainted, by a peculiarly contracted condition of the nuclear chromatin, which will at once be recognized by any botanist who has paid attention to the corresponding changes before the division of the spore mother-cells in plants.

To this very singular appearance in the early prophase of the heterotype in animals, I have applied the term Synapsis, from the Greek *σύνapsis*, and we may thus speak of any

spermatogenic cellular generation as being pre- or post-synaptic, as the case may be.

Now the fundamental argument contained in Professor Strasburger's paper is, that there exists a similar *synapsis* or rolling together of the chromosomes in the case of plants, and that this alone fulfils the physiological necessities of the case, the 'Reductionstheilung,' if it exists anywhere, being an adaptation or an abnormality.

As I have already pointed out, however, not only the existence, but the universal existence of the 'Reductionstheilung,' as something superadded to the *synapsis*, or reduction in rest, is claimed by the author of the Germ-plasm as a logical necessity, arising from the premises of his theory. In fact, the 'Reductionstheilung' is a *sine quâ non* in this theory, and enables us to understand why Dr. Haecker should speak of the reduction occurring in the prophase of heterotype divisions, as a pseudo-reduction, and why, on page 100, while referring to the similar processes in plants, he should say, 'I believe that by assuming such a fusion, the process of reduction is robbed of all theoretical significance, as far as such significance bears upon the theory of heredity,' since by this he can only mean that the 'Reductionstheilung,' as such, is presupposed by the theory of heredity, and that any observations which discredit its universality are therefore probably unsound.

The question immediately waiting solution then, is, does the 'Reductionstheilung' exist universally as a final stage in the formation of the sexual cells of plants and animals, or not?

According to vom Rath's description of the 'Reductionstheilung' in Salamander (which, so far as I know, is the only case in which the process has hitherto been described in vertebrates), it is said to occur among those generations of spermatic cells which in amphibia follow the great spermatic heterotype division. It is, in fact, relegated to those singular and well-known mitoses with tetrapartite chromosomes, which were figured and described by Flemming¹, as probably abnor-

¹ Arch. für Mikr. Anat., Bd. XXIX, p. 445, and Taf. XXV, Figs. 46-50.

malities with a *tendency* towards the formation of *tripolar spindles*.

Now there cannot exist a shadow of a doubt that the great heterotype division of Amphibia corresponds to the great heterotype in Mammalia, Elasmobranchs, and Birds, any more than it is possible to doubt that the synaptic change corresponds among varieties of plants.

But the number of cellular generations which follow the synapsis and the heterotype, appears by no means constant, either among animals or plants. In some mammals which I have examined, the great heterotype division is the last in the whole spermatogenetic series, as indeed the researches of Brown, Ebner, Fürst, and Hermann had already unconsciously sufficed to show; and it consequently follows that the particular part of the spermatogenesis, in which, according to vom Rath, the 'Reductionstheilung' exists in Salamander, may be altogether wanting among mammals. In mammals as in Elasmobranchs the synaptic reduction does really appear to accomplish all that is done in that direction. But in Elasmobranchs two generations and one division follow the heterotype, and the last division is a heterotype also, with the same number of chromosomes as the first. I do not see how in the face of these facts the universality of the 'Reductionstheilung' in animals is to be maintained.

Turning to the case of plants, Dr. Haecker is evidently himself impressed with the fact that the peculiar division occurring at the end of the vegetable synapsis is superficially similar to the heterotype, accompanying the corresponding stage in the development of animal reproductive cells, for he says on page 100 that a numerical reduction is known sometimes to accompany the heterotype division of animals, and then goes on to imply that the synapsis, or reduction in rest, hitherto described in plants, may be followed by divisions having the nature of a true 'Reductionstheilung.' All those botanists, however, who have paid the most attention to this subject, universally declare that no such divisions exist, and we are left with no other alternative than to conclude that

Weismann's conception of the universality of the 'Reductionstheilung' has broken down, and apart from the universality once claimed for it, the 'Reductionstheilung' is, as Dr. Haecker says himself, not of much theoretical importance.

With respect to the similarity between the synopsis among animals and plants, it was shown some time ago by Farmer¹ and Belajeff², that the chromosomes formed during the division of the spore mother-cells of lilies had not the structural character which had hitherto been assigned to them, and the suggestion was thrown out by Professor Farmer that this mitosis probably partook of the nature of a heterotype.

The extremely interesting conclusions which must follow from the establishment of something more than a mere resemblance between the synaptic changes in the reproductive cycles of animals and plants, induced Professor Farmer and myself to institute a joint comparison between the great spermatic heterotype in Tritons and the division of the pollen mother-cells of lilies³.

Our results are briefly these: (1) That the division of the pollen mother-cells in lilies is a heterotype. (2) That during the synaptic rest which precedes it, in both animals and plants, the chromatin of the nuclei is always more or less contracted, either to the centre or to one side, just as in the corresponding stage in the spermatogenesis of *Ascaris* described by Brauer. This condition of the nucleus in plants has already been figured and described by Strasburger, but it has been generally believed by botanists to be an artificial product, caused by the preservative reagents used.

Our observations, however, seem to show that it is in reality nothing of the kind, and that the better the general preservation of the cells, the more marked is the appearance of nuclear

¹ Ueber Kernteilung in *Lilium*-Antheren, besonders in Bezug auf die Centrosomenfrage. *Flora*, Heft I, 1895.

² Zur Kenntniss der Karyokinese bei den Pflanzen. *Flora*, Ergänzungsband, 1894.

³ Farmer and Moore, On variations in the genesis and structure of the chromosomes in plants and animals. *Anat. Anzeiger* in the hands of the publisher.

contraction. Moreover it can be distinctly seen in the case of some animals while the cells are still alive.

(3) That the division which closes the synaptic rest in lilies, being a true heterotype, like that in Tritons, the nuclear chromatine, during the chromosome-formation, pursues a course of evolution essentially similar in both.

(4) That there are certain specific types of variation in the formation of the chromosomes, which repeat themselves with curious exactitude in both the animals and plants which we examined.

Now these last points of correspondence in the variations the chromosomes may undergo, are in reality by far the most important observations we have made, because they show that the heterotype divisions of animals and plants correspond not only in the gross, but in the most minute details. They constitute, in fact, a series of phenomena from which it is legitimate to conclude that the heterotype mitoses in the reproductive cycles of animals and plants are intimately related to each other. They must arise in these reproductive cycles, either as the expression of identical physiological conditions, or be representative of a common ancestral stage in the phylogenetic history of both.

In either case, these phenomena are of the most profound importance to the zoologist and botanist alike as the universal existence of the 'Reductionstheilung' does not, as we have seen, appear to be supported by the facts as at present known, its retention as a theoretical necessity can only continue to obscure the essential similarity which really exists between the reproductive cell-cycles of animals and plants.



On the Phenomena of Reproduction in Animals and Plants.

Antithetic Alternation of Generations.

BY

J. BEARD, D.Sc.

Lecturer on Comparative Embryology, University of Edinburgh.

A RECENT number of the *Annals of Botany* contains Strasburger's conclusions on 'the periodic reduction of the chromosomes in living organisms'¹. The paper, though largely based on facts of plant-morphology, is not without its special significance to the zoologist and animal morphologist. In the zoological world Strasburger's statements appear to have created more unrest than satisfaction, and they have already led to an elaborate and somewhat ingenious criticism² from the pen of V. Haecker³. And naturally so, even though it should subsequently become apparent that in this, as in so many other cases, Strasburger was mainly in the right in his

¹ *Ann. of Botany*, Vol. viii, 1894, pp. 281-316.

² Haecker, V., The reduction of the chromosomes in the sexual cells, *Ann. of Botany*, Vol. ix, 1895, pp. 95-101.

³ Haecker's objections are certainly weighty ones, and are only rendered in some respects nugatory by the acceptance of a very different view of the nature of animal development from that hitherto adopted.

contentions so far as these relate to plants. How could it be otherwise? Is not the zoologist as such concerned with processes in which an antithetic alternation of generations is only conspicuous by its absence? How then shall he of all men accept an explanation of the meaning and nature of a process in plants, when to what is, to all appearance, the corresponding phenomenon in animal reproduction the interpretation offered would seem totally incapable of application?

The zoologist in general, having as little belief in the occurrence of spore-formation in animals as in an antithetic alternation of generations, and being limited by a blind acceptance of recapitulation with 'direct development' or by a simple negation of any such theory, is hardly to be expected to admit that the botanists may have obtained a deeper insight into the phenomena of plant-development than he believes himself to have of those of animal-reproduction.

Haecker speaks in his behalf with no uncertain note. An explanation which does not fit in with the zoological facts is to Haecker's mind possibly dependent on a 'misinterpretation of the results obtained by the botanists,' and he seems to think it more fitting that these investigators should set their house in order in the light of the newer zoological facts. Apparently it does not occur to him that the something lacking to complete agreement might lie at the door of the zoologist himself.

The fundamental laws and principles of animal reproduction are practically assumed to be less open to emendation and repeal than those of plant-development. But is this really the case? What we are taught when we begin our zoological studies, provided it be contained in the text-books as well as in the professor's lectures, becomes almost of the nature of a superstition, and the essence of such is, as Huxley has, I think, remarked, that it is accepted on faith without evidence.

In zoological research there is also a fatal tendency to look upon all previous results, in so far as they are of general

import and not directly treating of the particular form under examination, as though based on revelation and not to be impugned. Thus the facts and factors pointing to heterodox conclusions are liable to be ignored, and the total of new knowledge gleaned falls readily into line with previous beliefs.

So opposed to tradition does a new view seem that, when the deciding fact in its favour is finally discovered, the whole thing is looked upon as little short of a miracle. There are plenty of apparently meaningless facts in the possession of zoological science; but the most insignificant fact has some meaning, and it may often happen that the explanation of it is not to be directly got at. Many ways lead to Rome, some directly, others by circuitous paths.

When some seven years ago I began to follow the history of a few insignificant ganglion-cells in *Lepidosteus* and other oviparous Ichthyopsida it never seemed in the least likely that the end of the chapter would be found in the processes which occur during oogenesis, spermatogenesis, and conjugation. Any connection with spore-formation and an antithetic alternation of generations, such as that found in the Metaphyta, would at that time, and long afterwards, have appeared to me to be utterly absurd and chimerical. The track from the start almost to the finish has been a complex and puzzling one. Often it has been dark and ill-defined, and the goal has kept itself concealed until well-nigh the journey's end.

When the 'supposed law of Metazoan development'¹ was written, the recognition of any very close similarity in the laws governing animal- and plant-development seemed somewhat remote. All along the desire has been to study the facts, to ignore none, and not to be biased by theoretical considerations. For a long time no decisive facts were unearthed; but, ultimately, putting together various facts concerning larvae and their fate, their morphology, and their

¹ Beard, J., On a supposed Law of Metazoan development. *Anat. Anz.* 1892.

transformations in allied forms, observations on the appearance of sexual characters in the vertebrate the attainment of the adult form of body, the formation of the definitive nervous system in the fish-embryo, and comparing the appearance of these latter factors with that of commencing degeneration of the transient nervous system, it became evident that the initiation of degeneration was in association with a number of phenomena which might be nothing other than a metamorphosis. And it then dawned upon me that the development of a lower Vertebrate was in reality an alternation of generations in which the sexual form began to be formed upon an asexual form at a very early period. It was then recognized that the two could only co-exist as long as the sexual generation was so to speak, merely dormant upon the asexual one, and as soon as the former began to manifest active development, these led without fail to the suppression of the latter. Owing to complete want of homology between the parts of the two generations, as proved by their dissimilar nervous systems, and as further manifested by the different types with larval development among the Invertebrates, it became obvious that Metazoan development was really made up with an *antithetic* alternation of generations. The standpoint reached when I became acquainted with Bower's researches and results on Apospory in ferns, and many things found their natural interpretation, for I had once recognized that the conclusions previously arrived at pointed to a sort of Apospory in animal development. At the same time the problem of the nature of the division intruded itself, thanks to a presidential address by Prof. Bower's² in which Strasburger's conclusions were discussed.

It seemed necessary to find the explanation of the phenomena in animals, if, as was more than suspected, there existed

¹ Bower, F. O., On Apospory and allied phenomena. *Trans. Linn. Soc. Bot.*, Vol. ii, Pt. 14, 1887.

² Botanical Society, Edinburgh. Nov. 1894.

deep fundamental similarity between the modes of reproduction and development of animals and of plants.

Although regarding Metazoan development as a sort of apospory, I did not at first foresee the obvious result of a suppression of spore-formation, and it is due to my pupil, Mr. J. A. Murray, B.Sc., to state that it was he who first recognized how the omission of a spore-formation in animal (i.e. Metazoan) reproduction would affect the position where a reducing division could take place. All that had been done in upwards of seven years was needful before this final comparison of animal- and plant-reproduction could be drawn, and the possibility of its accomplishment appears to me to form the crowning point which proves the edifice to be fairly complete. Not only that; the sequel will, I venture to think, show the foundation on which so much labour and time have been expended to be correctly laid. The main point, at which attack may appear to be still possible, will undoubtedly be the evidence on which the occurrence of an antithetic alternation of generations in animals is based.

Those who think no sort of proof is possible may perhaps be astonished to find how mistaken was their belief, when all the evidences are laid before them. In one paper, or indeed in half a dozen, this cannot be satisfactorily done. Life is too short and time too limited for the individual, overwhelmed with other duties, to entertain any hope of being able, from his own observations, to demonstrate such an alternation in every group of the animal kingdom.

My own investigations¹ have hitherto been almost exclusively limited to the group with which I am most familiar, and in which, as it happens, the evidences in current embryology are least apparent, viz. the Vertebrata. For other forms, in the meantime, recourse must be had to the work of others, and this, if too often deficient from my point of view, is the more valuable in that such observations as do

¹ A memoir, many of whose results and conclusions are assumed in the present paper, is now in the press.

appear to possess direct bearings on the problem have almost all been made without any idea that they tended in any such direction.

There is no wish to disparage the labours of authors of embryological text-books by the remark that such books have hitherto been more concerned with organogeny than with the development of animal organisms, and it is only rarely that the reader of them has his attention called to anything but the germinal layers and the structures which arise from these. Observations treating of degenerations and disappearances of structures during development, like those of my friend R. S. Bergh¹ on *Aulostoma*, are liable to obtain an incredulous reception and to be covered with ridicule because they do not conform to the Germ-layer theory, or because they furnish enigmas to the embryologist in quest of a theory of the mesoderm.

It would be possible to write a book on Comparative Embryology in which the modes of development of organisms as opposed to organs should form the main theme of the work. This I know to be so from lecturing experiences.

However, this is all wide of the subject to be treated of here. The object of the present writing is a totally different one. The problem for consideration is, assuming an antithetic alternation of generations to take place in Metazoan development with 'aposporous' formation of the sexual generation in most if not in all cases, to show what bearings such a conception may have on the interpretation of certain phenomena that occur in the maturation of the sexual products, and, as a corollary to all this, it has been deemed necessary to enquire into the nature of the processes involved in the conjugation of the Protozoa.

The sequel has culminated in a most surprising result, i. e. in the recognition of the prevalence of one primitive mode of reproduction for the whole of organic nature, and this is of such a character that an alternation of generations

¹ Bergh, R. S., Die Metamorphose von *Aulostoma gulo*. Arbeiten a. d. Zool.-Zootom. Inst. zu Würzburg, Bd. VII, 1885.

becomes absolutely essential to its being carried out. *A priori* it seemed quite hopeless to expect that our knowledge of the processes of conjugation in the Infusoria, which we owe so largely to the brilliant labours of Richard Hertwig and E. Maupas, would confirm the suspicion that existed of the occurrence of a spore-formation with reduction of the number of chromosomes after a conjugation or antecedent to a new one in this group, but, as will subsequently appear, the known facts readily allow of such an interpretation.

On the Phenomena of Reproduction in Animals and Plants.

Reducing Division in Metazoan Reproduction.

BY

J. BEARD & J. A. MURRAY, B.Sc.

A REDUCING division in itself, apart from the previous history of the cell in which it occurs, or of the ancestors of that cell, is of course unintelligible. It is needful to enquire in both animal and plant how from this past history the reduction was rendered imperative. It is, as Strasburger has insisted, 'a return to the original generation from which, after it had attained sexual differentiation, offspring was developed having a double number of chromosomes¹.' Theoretically it is the undoing of the displacement of balance among the 'organs' of a cell due to duplication at a previous conjugation².

In the researches of recent years on the mode in which the reduction takes place in oogenesis and spermatogenesis the burning question has been whether it was by a longitudinal, or by a transverse, fission of chromosomes. A longitudinal division is proved to be incapable of effecting this, because it is the mode in which any ordinary cell-division is brought to pass. And the failure of the chromosomes to

¹ Loc. cit., p. 289.

² The term 'conjugation' is used to represent generally the union of two nuclei whether in Protozoan or Metazoan. The final act of union is fundamentally the same in both cases, as will appear subsequently.

unite after the conjugation, until the first division of the zygote shall have happened, is again an indication that a longitudinal splitting does not bring about a reduction. When actual union of chromosomes after conjugation is effected, this is obtained by the union of the chromosomes from an individual A with a corresponding number of chromosomes of an individual B; the chromosomes must, as others have often enough insisted, retain their identity and they only become disunited for the purposes of a cell-division.

Ultimately it becomes necessary to finally undo the linking, in order to prevent a duplication of the number which would increase it to fourfold what it originally was. This can only be effected by a transverse splitting. In other words, chromosomes may be considered as possessing two axes, along one of which (the longitudinal) they may divide, along the other (the transverse) they may unite with other chromosomes. It is along the latter—that along which union takes place—that the reduction must be effected. A reduction is nothing more than an undoing of the union effected at a previous conjugation, but by this it must not be concluded that there is any intention of supposing it to be a separation of all the male-parental chromosomes from all the female-parental ones. The facts of heredity, as Weismann has proved, go to show that the process is more complicated, and an excellent discussion and explanation of it have been furnished by Haecker in his reply to Strasburger and elsewhere. The theoretical mode of the undoing has quite recently been proved by an able investigator in the case of the Copepoda¹.

Rückert has shown that in this group the reduced number is brought about by a transverse division of what seemed to be half the normal number of chromosomes, and that in the ripening of the egg this takes place in the formation of the second polar body. He states² that the reduction in the number of chromosomes before fertilization is attained by the

¹ Rückert, J., Die Chromatinreduction bei der Reifung der Sexualzellen. *Ergebnisse der Anat. und Entwicklungsgesch.*, Bd. III, 1893, pp. 517-583.

² Summary on p. 582.

which action of two processes. It is initiated before the maturing periods at a very early period, by the suppression of a transverse division of the chromatin loop, in consequence of which the chromosomes remain attached in pairs or couples. It is accomplished in the second division of the ripening by the passage of the chromosomes of each pair to opposite poles. He goes on to say that the first process alone leads only to a pseudo-reduction, the true number of chromosomes persisting, being only masked, and therefore capable of reappearing. The process, however, appears necessary in order that the subsequent reduction should be effected. A theoretical explanation of this has been attempted above.

It may at this juncture be useful to consider what must have been the general result of the initiation of conjugation between unicellular organisms in past ages. When conjugation between pairs of similar cells arose among the primeval Protozoa (or Protophyta) the original form of this process was bound to result in the 'creation' of two different generations. These were characterized primarily by a difference in the number of chromosomes. The one generation with double chromosomes was itself never capable of conjugation, it could only give rise to new forms by fission, and it, or its progeny so produced, could only bring about a new conjugation by first producing (spore-formation) a generation in which the number of chromosomes was reduced in each individual product to the original one, which obtained antecedent to a conjugation.

¹ It is worthy of notice that Farmer has recently stated the following facts concerning the reduction in plants:—Two features characterise the karyokinesis of the spore mother-cell in Hepaticae. The first of these is that the number of chromosomes is reduced to one half as compared with antecedent mitoses in the sporophyte, and this reduced number is apparently retained in the gametophyte. The second point is that the spore-forming mitoses are what Fleming has termed 'heterotypic' in character. (J. B. Farmer, Spore-formation and Karyokinesis in Hepaticae. *Annals of Botany*, Vol. ix, June, 1895, pp. 363-364.) These facts appear to agree absolutely with what Rückert found in Copepods, but of course in the one case (animals) the reduction occurs at the 'ripening' of the sex-products, in the other (plants) at the spore-formation.

Notwithstanding all those facts of Protozoan modes¹ of reproduction which may appear to tell against this, notwithstanding all the botanists believe about the secondary nature of alternation of generations, it must be insisted that a simple antithetic alternation of generations was obligatory from the very nature of the original conjugation.

All subsequent higher developments must be considered as effected by further specializations on the original 'plan.'

The Protozoan stage might be improved upon by the one generation or the other, or by both. The conjugating generation may have become Metazoan, or the spore-producing one, or both together may have undergone the higher evolution². It is probable that there were originally variations here, and some of these still persist. In plants the amplification of the zygote stage has given rise to the sporophyte, which is sharply separated from the sexual generation or gametophyte by a one-celled stage (the spore) and a reducing division. The whole of the cells of the gametophyte must be looked upon as morphologically aequivalent, some becoming differentiated as vegetative organs by sterility, others retaining the primitive character of becoming conjugating gametes. Bower³ has attempted with some success to derive the members of the sporophyte by a similar sterilization of sporogenous tissue. The standpoint here taken up is, in fact, an application of his method to the other generation. Indeed, it may be regarded as certain that what Weismann terms somatic cells in both kingdoms owe their origin in all cases to sterilization.

When one seeks in the higher animals for an equivalent of the alternation of generations in plants in the light of recent work on the reducing division of spore-formation, such a mor-

¹ In the sequel an attempt will be made to show, by concrete instances which have been thoroughly investigated by other observers, that many of these are secondary in nature.

² This must be held as true for the plant kingdom also.

³ Bower, F. O., *Studies in the Morphology of Spore-producing Members*. Phil. Trans. 1894, B.

phological mark would only be found in the maturation of the egg and in spermatogenesis. If the process were here a spore-formation, the whole Metazoan body, in which it took place, would represent the asexual generation, and any apparent alternation of generations in the life-cycle would be homologous¹ in character, not antithetic. But the total lack of homology between the organs of certain larvae and those of the adults which arise upon them,—as well as other facts and factors in course of publication elsewhere—leads to a suspicion that here we have a real antithetic alternation of generations masked by omission of the spore (apospory), and a consequent delay of the reducing division. Such a delay might easily arise as a result of the close association of the two generations observable in the development by substitution so characteristic of animals. In fact the frequency of substitution is one of the most striking differences between animal and plant development.

As before stated, it is not intended in this place to attempt any proof that Metazoan development is a form of antithetic alternation of generations with apospory. That must be assumed, and the consideration of the evidences in favour of it be reserved for another place.

On this supposition a comparison of Metaphytic and Metazoan modes of reproduction would be as shown in the table on the next page.

It is thus apparent that the life-cycles of a higher Metaphyte and of a Metazoan exhibit close correspondence, if animal development be a form of antithetic alternation of generations masked by aposporous formation of the sexual generation or gametozoid. The omission of a spore-formation has, as one of its results, the delaying of that reduction of the chromosome-number which must take place before the next conjugation. It thus happens that the cells of both generations contain a similar, i. e. duplicated, number

¹ As a matter of fact such a homologous alternation may become intercalated, and there is no intention of denying its existence alongside an antithetic one in many instances, such as *Trematoda*, *Ascidia*, &c.

of chromosomes, and the reduction itself is necessarily deferred until the last possible moment, i. e. to the period of ripening of the sexual elements. 'Necessarily deferred' is undoubtedly the term to describe the fact, and the explanation of the why and wherefore of this affords an opportunity of considering a very obvious objection to the view here adopted.

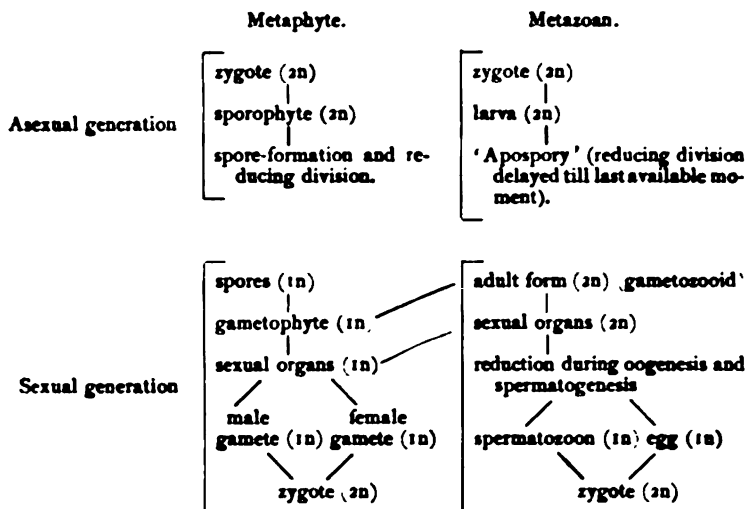

In the above table n equals the number of chromosomes prior to the duplication ($2n$) at conjugation.

It may be urged that, if the fact of the occurrence of an antithetic alternation in animal development were admitted, the reason for an aposporous formation of the gametozooid would not be at all obvious. Spore-formation with the necessary reduction might none the less occur at the proper juncture, and the gametozooid might, directly or indirectly, arise from one of these spores; whilst the remainder, whatever number of them there were, might be abortive. As a matter of fact, as will be presently demonstrated, something of this sort is the course of events in the conjugation of the Infusoria. It does not hold for Metazoa for the following reasons:—(1) Generally speaking, only one gametozooid makes its appearance on the larva, there are no traces of

abortive spores, and the formation of one true spore alone appears to be out of the question; for, in order that cells with the reduced number of chromosomes, i. e. spores, should arise, four of them at least must be formed. (2) That there is no spore-formation is, of course, also proved by the circumstance that there is no reduction before the origin of the gametozoid, and as previously shown, the primary object of spore-formation is to effect a reduction.

The modifications in development which this asexual alternation brings about are far too numerous and too varied to admit of treatment here. It would be necessary, even with the facts already available, to write a treatise on animal development from this standpoint, in order to display them.

But it may be of interest to indicate one or two developmental facts, which clearly have their natural interpretation in an asexual formation of the sexual generation in the Metazoa.

The marine Annelida with an obvious larval development admit readily of inclusion in such a scheme as that suggested. Kleinenberg¹, in his brilliant *Lopadorhynchus* memoir, has amply demonstrated such an alternation as that here recognised, while just failing to draw the manifest conclusion. By way of parenthesis it may be remarked how marvellously close on a recognition of this 'law of development' Kleinenberg's meditations, along with those of Johannes Müller and Von Baer, really verge.

A Chactopod origin of the group of *Hirudinea* is commonly admitted, and in them R. S. Bergh has demonstrated facts in his memoirs furnishing as valuable confirmation of the views here advocated as could be wished.

Passing next to the group of the *Oligochaeta*, we are apparently brought to a standstill in our further search for confirmation. But not really so. When we take up the researches of E. B. Wilson², these at first sight seem hope-

¹ *Zeitschrift f. Wiss. Zool.*, Bd. XI. IV, 1886.

² Wilson, E. B., 'The Germ-bands of *Lumbricus*.' *Journ. of Morphology*, Vol. I, 1887.

lessly at variance with any such idea as that of alternation of generations with apospory. It was long ago foreseen that here obstacles seemed to block the way. However, when looked at in the light of spore-formation, Wilson's lines of cells, mesoblasts, neuroblasts, &c. readily admit of interpretation, not as due to an actual spore-formation, but as an early modification of this, which has already led some distance along the path of apospory; really as a step in advance from the former formation of the sexual generation, or gametozoid, from a spore-mother-cell, in the direction of its origin from a few cells. Carry the process still further, and we obtain the counterpart of the primitive streak of the Vertebrata. It is very interesting to note that, altogether apart from theoretical considerations, Assheton points out how in the embryology of the frog and rabbit the first attempts at development result in products formed in a totally different direction from that subsequently adopted.

Assheton¹ has really proved that the embryo (i. e. the sexual generation) is not formed by the segmentation of the egg, but by a proliferation in a totally different direction, i. e. in a zone which gradually grows backwards whilst proliferating in front. In other words, his researches may be explained as showing how the gametozoid arises from an aposporous tissue within a larval or asexual generation resulting from the segmentation of the egg—from the so-called 'primitive streak.'

The pole-mesoderm-cells of Hatschek may also be mentioned, and it may be suggested that a possible interpretation of them would be that they might represent spore-mother-cells, which had of course undergone no reduction.

¹ Assheton, R., The Growth in length of the Frog Embryo. *Quart. Journ. of Microsc. Sci.*, Vol. xxxvii, N.S. pp. 223-243.

On the Phenomena of Reproduction in Animals and Plants.

The Conjugation of the Infusoria and the Meaning of the
Processes Involved.

BY

J. BEARD.

—♦—
With Woodcuts 9-13.
—♦—

IT has been specially interesting to study the conjugation-processes of this group in the light of experiences formed elsewhere. As is well known, the facts have not been gleaned without the arduous labours of many distinguished investigators. The processes appear to be difficult of observation, but, thanks to the brilliant work of R. Hertwig¹ and E. Maupas², our knowledge of them has advanced enormously in recent years.

It may appear presumptuous to offer an explanation of the meaning of the very complicated process, but, if apology be called for, it may rest on the ground that it appeared necessary to put the theoretical 'law of reproduction' to the test in this case also. If it sufficed as an explanation of the facts, so much the better; if it were found wanting, so much the worse.

¹ Hertwig, R., Ueber die Conjugation der Infusorien. Abhandl. d. bayr. Akad. d. Wiss., II. Cl., Bd. XVII, 1889.

² Maupas, E., Le rajeunissement karyogamique chez les ciliés. Arch. de Zool. expér. 2e série. T. vii, 1889.

The one fact that would be fairly decisive appears to be lacking, or, at any rate, incompletely known. This is as to the precise point at which the chromatin-reduction takes place.

Theoretically, as will be presently proved, such a reduction at some point or other must be postulated even here. However, from R. Hertwig's statements the actual point can be fixed upon with a fair degree of certainty, and, as will be evident, it would appear to lie at a certain phase of the conjugation which *a priori* seems to be a very likely one.

Amoeba, Gregarina, &c.—in fact a great many far simpler Protozoa than *Paramecium*, apart from fission, exhibit a simple process of conjugation, leading to encystment and spore-formation. Such a process, however simple it may be, must entail a reduction of chromosomes prior to the next conjugation.

Although there appear to exist no direct observations on such a reduction in these cases, there is practically no doubt that it takes place at the spore-formation following conjugation and encystment. Otherwise the spore-formation would be without meaning; for these forms can multiply in a very rapid manner by simple fission alone. Such a conjugation as the above must be a very primitive form of an alternation, and, indeed, one in which a zygote or gametozoid hardly can be said to possess a separate existence for any lengthy period; because the spore-formation and reduction follow almost immediately on the conjugation and duplication.

Paramecium is morphologically a far more complex organism. It presents more than one nucleus, and division of labour among these. As in *Amoeba*, we recognize here two processes of multiplication—fission and conjugation¹.

Colpidium colpoda (woodcut 9) is usually cited as affording one of the simplest examples of conjugation, and it may therefore be the first form to be examined.

Turning our attention to the processes that occur after

¹ Spore-formation is not a distinct and separate mode of reproduction, but is a necessary corollary to conjugation.

conjugation (*f g h*) we find that these are all simple fissions, and they are bound up, as E. Maupas has demonstrated, with differentiations of nuclei into nutritive and reproductive, and the formation of new individuals by fission.

There are no abortive products, and there is no evidence of spore-formation subsequent to the conjugation.

Developmental processes which appear to be nonsensical have usually a deep significance. The morphologist who

encounters such ought always to suspect that there is something in them requiring close attention.

Apparently meaningless processes having, as O. Hertwig observes, a striking similarity to the formation of the polar bodies during oogenesis, are seen in the changes (*b c*) which take place in the micronucleus prior to the actual act of conjugation.

Now, the only reproductive products with which we are acquainted are gametes, including eggs and sperms, and spores. At the stage *c* there

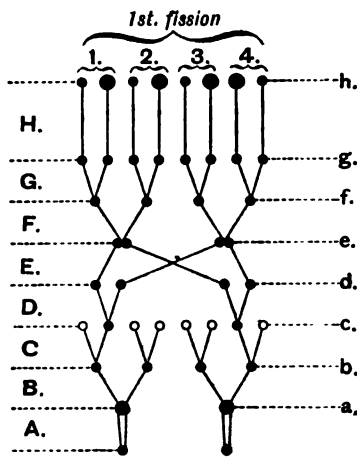

Colpidium colpoda (after Maupas).

are a number of nuclei formed, resulting from the two mitotic divisions B and C. In this particular species, *Colpidium colpoda*, three of the four (*c*) in each of the conjugating individuals are abortive. Do these cell-nuclei represent gametes? The answer to this appears to be in the negative; they do not conjugate. Before an actual conjugation happens, each of the functional ones again divides, and the products are those which furnish the actual materials for the conjugation, i.e. the gametes. (In this latter division, D, we have really a virtual fission of sporozooids to form like conjugating gametes.)

The pole-nuclei must therefore be spores, and the process, i.e. the two divisions at B and C, must be a spore-formation. The proof of this would undoubtedly be the discovery that in these two divisions—probably in the second one—a reduction of the number of chromosomes was accomplished.

The evidence that this happens is at present not quite complete. In *Paramecium*, where, as will be seen, quite similar processes occur (woodcuts 10 and 11, B and C), it is certain that prior to conjugation a reduction does occur. R. Hertwig¹ states that the stationary and the wandering nuclei, i.e. the like gametes (*d*), possess each 4-6 chromosomes, and he describes the normal number of chromosomes in the micronucleus of *P. aurelia* as ten².

Of the four spores produced in each individual (*Colpidium*), all but one atrophy.

The spore-individuals or sporozooids do not themselves conjugate, but by virtual fission, in which the individuals produced do not become separate, because there is no division of the protoplasm, like gametes or gametozooids arise. The sexual generation thus arises from the spores, or asexual generation, by fission³. Thus the antithetic alternation is recognizable here; but, and all this holds true for the other Infusorians to be afterwards considered, it is largely masked to observation and detection, because overshadowed by the process of fission, which has become so highly evolved among the Infusoria.

Other Infusoria present slight differences in the conjugation processes, and, in order to demonstrate how, *mutatis mutandis*, the 'law' holds for all, short interpretations of various cases, figured by Maupas and worked out by him and by R. Hertwig, may now follow.

Paramecium aurelia (woodcut 10). This form possesses two micronuclei. The conjugation is explained as follows.

¹ Loc. cit., p. 182.

² Loc. cit., p. 184.

³ Subsequent to actual conjugation the cycle contains a great but, as Maupas has proved, definite number of secondarily asexual generations, but with duplicated chromosomes, produced by fissions.

460 Beard.—*Reproduction in Animals and Plants.*

1. A to C. Two divisions of micronuclei leading to spore-formation (c) and reduction. Atrophy of seven of the eight spores.

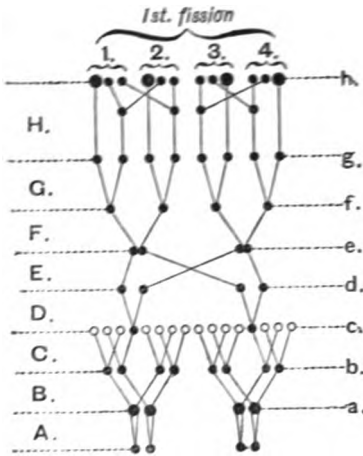

Woodcut 10.

Paramecium aurelia (after Maupas.)

2. D. Fission of the spores or sporozooids to form like gametes (d).

3. E. Conjugation of the gametes (e).

4. f, g, and h. Formation and differentiation of new individuals from the zygote by fission consequent on conjugation.

Paramecium caudatum (woodcut 11). Prior to conjugation there are, as in *P. aurelia*, two divisions of the micronucleus, which is here single.

1. B, C. Two divisions resulting in the formation of four spores (c) and reduction. Abortion of three spores.

2. D. Fission of the spore-individuals to form like gametes.

3. Conjugation (e) of the gametes.

4. F to H. Fission leading to the formation and differentiation of new individuals subsequent to conjugation, but with abortive individuals or nuclei (macro- or micronuclei after $\frac{G}{2}$ at h)¹.

Onychodromus grandis (woodcut 12). The conjugation here, as made out by Maupas² in a fashion that can only excite admiration, is exceedingly interesting and complicated. There are two micronuclei, and of these one, after commencing the steps leading to spore-formation and reduction, aborts (b)³.

¹ Probably micronuclei.

² Maupas, E., loc. cit., pp. 238-263.

³ Abortion of virtual spore-daughter-cells.

The other accomplishes the spore-formation and reduction, but only two of the spores produced atrophy (*c*). The other two in each individual form four like gametes by two fissions, and of these gametes two only are of functional use (*d*). The other two abort (*d*). After the conjugation, owing to the peculiar manner in which the macro-nuclei of new individuals are developed—in a mode quite different from that in which they arise in *P. aurelia* (a form also with two micronuclei)—

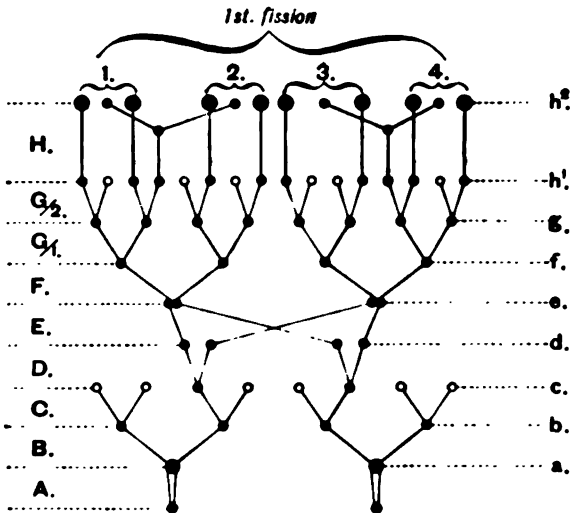

Woodcut 11.

Paramecium caudatum (after Maupas).

there is again a nuclear atrophy (*g*). This is obviously due to the fact that, after the first virtual fission subsequent to conjugation, the one nucleus is specialised to form micro-nuclei, the other to give rise to macro-nuclei only. To the species as it at present exists, the one macro-nuclei-forming element has become superfluous, but, though useless, like so many abortive vestigial structures, it must still invariably be formed, because the useful and functional one could not otherwise arise.

The form just considered presents quite sufficient com-

plications in the processes which result in the building up of new individuals after the conjugation, but in the next and final one (*Vorticella*, woodcut 13) these are met with in a yet more exaggerated form, and other amazing things happen prior to the conjugation. The reader may be reminded of what most of these are due to, i.e. to the differentiation of the conjugating individuals into macro-zooids and micro-zooids. The terms

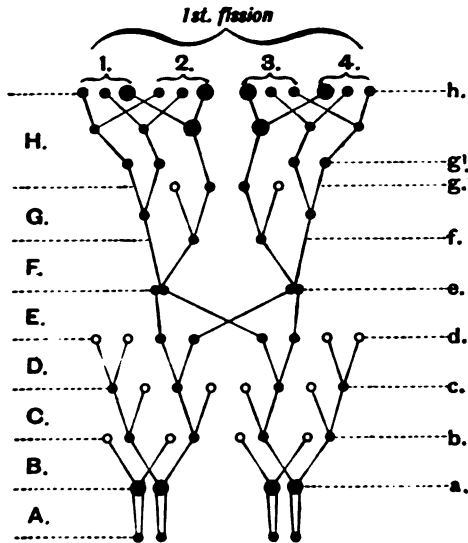

Woodcut 12.

Onychodromus grandis (after Maupas).

macro- and micro-gametes used by Maupas are misnomers, for, as other instances have made evident, the individuals which are present at the beginning of the union culminating in conjugation are not really the conjugating forms. The true gametes are formed later on within, and as descendants of, the 'micro-' and 'macro-gamete.' The differentiation into these can hardly be said to affect the conjugating gametes; the latter are alike, as in other cases, and do not differ in form, as Maupas has shown. It would be incorrect to term

the 'micro-' and 'macro-gametes' male and female respectively. This is something which should be reserved for the terminology of Metazoan individuals, where the gametes differ in form, although they are, as demonstrated by Boveri and O. Hertwig, morphologically equivalent. In other words we are not entitled to speak of sex in the Infusoria hitherto investigated.

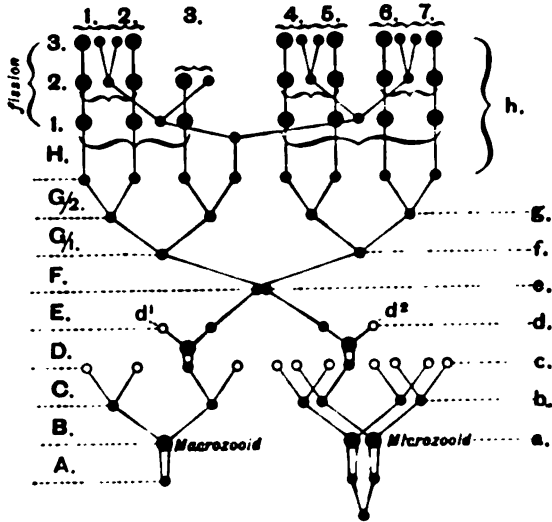

Woodcut 13.

Vorticella (after Maupas).

Before venturing on an interpretation of the whole process in *Vorticella*, I should like to pay a tribute of admiration to Maupas' brilliant researches. They stand out prominently among the published results of recent years as marvels of patience, exactitude, and morphological insight. It is a somewhat painful position to find one's self in, that of attempting to take a little of the cream from other people's researches. Some slight excuse may perchance be found in the circumstances that several years of my life have been devoted to the solving of this puzzle of the mode in which

animal development is accomplished, and that the alternation solution has been persistently stuck to, in spite of the fact that it was almost universally ignored, or, where noticed, looked upon as absurd.

My own researches have been sufficiently laborious and costly in time and money, without the additional burden of new investigations into, for instance, the conjugation of the Infusoria. With such works as those of R. Hertwig, and still more, of Maupas to fall back upon, one is relieved from anything but the utmost acknowledgement of what is due to them. If these researches had offered serious obstacles to the further elucidation of the problem, two courses would have been open. The views might have been dropped as probably erroneously based, or new researches might have been attempted. In many ways I consider myself as fortunate in having had the track cleared, and all the serious work done, by such distinguished observers.

Maupas' diagram of the conjugation of *Vorticella*, reproduced in woodcut 13, yields at a glance abundant evidence demonstrating the intricate nature of the process. Complicated as are the phenomena which ensue on conjugation, their explanation, as processes solely concerned in the formation and differentiation of new individuals, furnished with macro- and micro-nuclei, will hardly be challenged.

The two divisions B and C of the micro-nucleus of the 'macro-gamete' are also simply explicable, for they differ in no respects from corresponding ones leading to spore-formation and reduction in other forms. Of the four spores (*c*) produced three are abortive, whilst the fourth, representing the sporozooid, divides (*D*) as in other cases, once. Owing to the circumstance that the other individual, the micro-zooid, has become reduced in size, and has lost all power of receptivity for a conjugating gamete, the one (*d*¹), which in the ancestry performed the functions of a 'wandering nucleus' passing over to what is now the micro-zooid, no longer possesses functions and undergoes atrophy. It is still formed, because its formation is a necessary incident in the

origin of the functional one. This abortive gamete (d^1) corresponds, if anything in the conjugation of the Infusoria does so, to one of the polar bodies formed in oogenesis, i.e. as a rudimentary gamete. It will be noted that it also has its abortive equivalent in the micro-zooid (d^2). Regarding the phenomena in the latter prior to actual conjugation, an apparent stumbling-block is met with in the fact of the occurrence of *three* divisions of the micro-nucleus instead of two.

There might have been some hesitation in explaining away the first of these, were it not that Maupas, who is justified more than any one else in expressing an opinion on the matter, had already given a verdict favourable to all my desires. He regards the first division of the three, which also happens in both the conjugating individuals of *Euplotes patella*, as a formation of two micro-nuclei. The reasons assigned may be found in his memoir as cited below¹. Leaving the first division out of account, as Maupas has also done, we have then in the micro-zooid two divisions B and C, which may be interpreted as spore-formation and reduction. Of the eight spores (c) only one is functional. It, like the corresponding sporo-zooid of the macro-zooid, divides once (D) and the abortion of one of its products, or gametes (d^2), has already been commented upon, and the obvious reasons given.

At the time of writing the present paper it is quite out of question to construct diagrams from Maupas' accounts of the conjugation of other forms, which he has studied, but of which he has furnished no schemes. And the risk must be taken of postponing another study of the whole of his immense monograph, until more leisure is available. It might well happen that some details of the explanation of his results here suggested may have already been put forth by Maupas himself. If so, there is neither wish nor intention of detracting from his merits. What has really been my concern was the demonstration of an antithetic alternation of generations and of a spore-formation with reduction in the

¹ p. 364 and p. 341.

Infusoria. All else has only been offered in order to convince the reader of the inherent probability of the truth of the attempted solution. This is certainly new, and Maupas could not have entertained the slightest idea of it. This is certain from the general discussion in his memoir.

Before the close of my remarks on the conjugation of the Infusoria, I should like to quote a passage from R. Hertwig and express entire agreement with it. As against Maupas on p. 214 of his work on *Paramecium* Hertwig writes: 'Bei den meisten Infusorien copuliren weder sexuell differenzirte Kerne, noch auch Kerne sexuell differenzirter Thiere, sondern gleichwerthige Kerne, welche in gleichwerthigen, aber getrennt und unabhängig von einander entwickelten Thieren entstanden sind. Damit fehlt aber die Basis für die Begriffe männlich und weiblich, vollends aber für den Begriff Hermaphroditismus.'

It is doubtless highly hazardous on the part of a zoologist to venture an opinion that the botanists may, nay, must be, in error in supposing spore-formation to be a later acquisition than sexual reproduction.

We are bound to assume it to be a primitive process, which had its origin in the necessity of reduction following a conjugation¹.

The primitive form of 'sexual' reproduction or conjugation—and by either of these terms may be understood the

¹ Another, and perhaps better, way of stating this would be that an antithetic alternation of a very simple kind must be a consequence of even the most primitive conjugation in plants also. That a suspicion of an alternation of generations with spore-formation is more than justified even in the simplest plants is proved by the facts of the conjugation of *Closterium*, as described by Klebahn. After the conjugation of like gametes, the resulting zygote, i.e. its duplicated nucleus, divides twice without resting-phase. Four nuclei arise, two in each cell as there is only one fission of the protoplasm of the zygote. As described by O. Hertwig (*Die Zelle und die Gewebe*, pp. 224, 225) 'the two nuclei of each (of these cells) rapidly acquire a different appearance, the one becomes large and vesicular, whilst the other remains small and later on disappears.' This is strongly reminiscent of the 'pole-nuclei' of the Infusorians, indeed, these abortive nuclei must be regarded as exactly the equivalents of the latter. The process is, without question, a spore-formation with reduction. Of the spores formed two are abortive. Thus here also the antithetic alternation would appear to obtain.

union of at first like zygotes, and afterwards of unlike but none the less morphologically equivalent ones—apart from fission, was from its very nature bound up with an asexual process, or spore-formation, leading to reduction of the previous duplication of chromosomes. This very primitive antithetic alternation of generations still exists, and is bound to remain in a more or less modified form in both animals and plants, in consequence of the duplication which results from any conjugation. The tendency in higher forms has been in the direction of its modification, never towards its entire suppression. An attempt is made to abolish one of its most obvious factors, spore-formation, in both *Infusoria* and *Metazoa*. In the former this results in the formation of functionless vestigial spores, but the fact of a spore-formation is very evident, for these are here necessary factors in the evolution of conjugating gametes.

In *Metazoa* it has been avoided by apospory. The processes differ considerably in the two cases, because the lines of evolution have been so divergent. But, although the means adopted to attain the end (i.e. reduction of the duplicated number of chromosomes), is not by any means identical in both, the result is the same, the attainment of cells (nuclei), in which the primitive or reduced number of chromosomes is present. In the one case the reduction is associated with the formation of abortive spores (pole-nuclei), in the other with abortive eggs, i.e. abortive gametes (polar bodies).

Even in the steps leading to the spore-formation abortive products may be formed, as in *Onychodromus grandis*, where, in addition to abortive spores, functionless, and therefore abortive, spore-daughter-nuclei obtain (woodcut 12 b).

The same form is also interesting as presenting at the close of the division D a number of abortive gametes, which are to be regarded as in a certain sense the homologues of the 'polar bodies' of *Metazoan* oogenesis. Similar abortive gametes are also present at the corresponding stage in *Vorticella*.

Boveri has shown that the 'polar bodies' of *Metazoa*

represent abortive eggs. It has now been proved that in Infusorian conjugation abortive spores are invariably, and abortive gametes occasionally, formed.

It also follows that the essential act of conjugation, apart from the spore-formation and other processes leading up to the formation of like gametes, is the same in both Protozoa and Metazoa¹, i. e. the union of two like nuclei, not, as is often stated, two like half-nuclei.

Finally, from all that has been adduced in the course of this discussion, it may be concluded that there is one universal law underlying all those processes (conjugation, fertilization, etc.) which are classed together as sexual in nature, and this law has been defined in the preceding pages.

¹ And in plants.

On Spore-Formation and Nuclear Division in the Hepaticae.

BY

J. BRET LAND FARMER, M.A.,

*Fellow of Magdalen College, Oxford, and Professor of Botany in the
Royal College of Science, London.*

—♦—
With Plates XVI, XVII, and XVIII.
—♦—

THE present paper is primarily intended to give some account of the behaviour of the nucleus during the formation of the spores in a few genera of Liverworts, but I have not scrupled to add other matters where they seemed to possess interest. Thus the process of germination of the spores of *Fegatella*¹ offers certain points of contrast as well as of similarity, with the corresponding occurrence in *Pellia* which has already been described in this journal². And again the mode of separation of the maturing spores seemed to deserve a few remarks.

As regards the methods employed in fixing the cell-contents, absolute alcohol, alone or in conjunction with formic or acetic acids, gave fair results, but on the whole Hermann's solution proved perhaps the most satisfactory reagent. The

¹ Now often called *Conocephalus*.

² Farmer and Reeves, On the occurrence of centrospheres in *Pellia epiphylla*. *Annals of Botany*, Vol. viii.

[*Annals of Botany*, Vol. IX. No. XXXV. September, 1895.]

protoplasmic structures at the critical period of spore-formation are unfortunately exceedingly difficult to fix properly, although this observation does not apply to the nuclei of all of the other cells, whether of gametophyte or sporophyte. For staining, I chiefly used Heidenhain's iron-haematoxylin, followed by a ground stain of Orange G. In this way it was possible to trace the developmental history of the chromosomes, though the results obtained were checked by the use of many other dyes, used both singly and in combination. In all cases the microtome was used for cutting the sporogonium which had been previously embedded in paraffin, but observations were also made on uninjured spore-mother-cells which had been teased out of the sporogonium.

Fossombronia.

I examined three species of this genus, *F. Dumortieri*, *longiseta*¹, and *F. angulosa*. I found the first-named species on the whole the best for my purpose, as I had a large quantity kindly sent me by Mrs. Tindall; nuclear divisions were not so frequent in the material of the other two species.

The archesporial cells are fairly large, and contain very prominent nuclei. The nuclei seldom include more than one nucleolus, which is of a relatively large size; the lining consists of a freely anastomosing fine threadwork, which is very delicate in the resting nucleus. The anastomosing spots, and also the intercrossing threads, give to the nucleus a granular appearance at first sight. The nuclear wall is very obvious. The protoplasm outside it is of a granular texture, and in the resting cells I was unable to determine the presence of either centrospheres or centrosomes. If the centrosomes exist as such, they would be very difficult to distinguish from the other granules of the cytoplasm.

When the nucleus is about to divide, however, two centrospheres appear, one at either end of the nucleus (Figs. 14, 15). They consist of a somewhat dense mass of protoplasm (arc

¹ I am indebted to the kindness of Professor D. H. Campbell for a supply of material.

plasm or kinoplasm), from which extends a beautiful system of radiations, some passing towards the cell-periphery, whilst others curve over the surface of the nucleus. A single central body could in some cases be easily distinguished, although I failed to find it in others. Shortly after the appearance of these structures, the nuclear elements begin to alter in character. The linin becomes more chromatic, and disposed more regularly just beneath the nuclear wall. The nucleolus, so far as I could determine, does not begin to change until *after* the linin has begun to do so; but in the stages which rapidly follow, it is seen to alter its form. It then becomes angular, and, in extreme cases, almost star-shaped, whilst at the same time the linin begins to exhibit a very striking increase in the amount of chromatin which it contains. This substance is not evenly distributed, but is aggregated along certain tracts of the filament, and eventually the intervening parts give way and thus set free the chromosomes. But this is only accomplished when a considerable interval of time has elapsed after the chromatic tracts have been well mapped out. The young chromosomes then appear as rods, which are often bent in an elbow-sort of fashion, and they lie much more irregularly in the nucleus than in both previous and subsequent stages. The nucleolus, which now is very much distorted in form, is often connected with several of the chromosomes, and it soon afterwards disappears. The centrospheres at this time become very prominent, and indeed they are the finest I have seen in any plant-tissues. The chromosomes split longitudinally, and almost immediately afterwards the achromatic spindle is completely differentiated, and the chromosomes, or rather the still closely approximated respective halves, become regularly arranged equatorially around its periphery. I could not follow out with certainty the stages in the formation of the spindle, owing to the suddenness with which it appears in its fully formed condition. Whether it is in this case largely of nuclear origin, as seems not improbable, or whether it is of cytoplasmic nature, must remain for the present undecided. The spindle when fully formed still exhibits radiations at its poles, though

these become very faint for a time, a circumstance often met with in spindles when at this stage in their development. Presently, however, the radiations again become clear, and the daughter-chromosomes move off to their respective poles. There is a sheaf of fibres commonly attached to each daughter-chromosome, and the whole process of the separation of the daughter-chromosomes is such as to suggest a passive 'roping up' to the poles, rather than any spontaneous movement on the part of the chromosomes themselves.

It is easy to distinguish the number of the chromosomes in the archesporial nuclei. They are, in all the nuclei in which I could count them, sixteen in number. I estimated their number both at the equatorial plate-stage and also, in other instances, while the daughter-chromosomes were travelling poleward. The membrane very early appears around the daughter-nuclei, but the connecting spindle-fibres persist for a considerable time, and across them the cell-plate is formed in the normal manner. I was unable to distinguish the centrospheres of the two daughter-nuclei after their walls had been formed. I saw occasionally, vesicular bodies which occupied the place where the centrosphere might have been expected to be found, but they were very irregular in character. Sometimes they were altogether absent, and at others I saw as many as three lying together. The protoplasm is somewhat vacuolated at this stage, and I believe that the structures in question were nothing more than small vacuoles which happened to lie upon the surface of the nuclei. The nucleoli reappear early within the nuclei, first as two or three small bodies which finally fuse to one large one, and the linin concomitantly loses its chromatin constituent, and passes quickly into the ordinary resting condition. I was unable, however, to distinguish any difference in the staining capacity of either the nuclear sap or of the cytoplasm, such as would indicate that the stainable substance (chromatin) had become diffused out of the linin. The only structures which do change in this respect are the growing nucleoli. This does not necessarily imply that the chromatin passes, as such, into the nucleolus. Indeed, all the

more recent results obtained from microchemical examination of the cell, so far as they afford any evidence at all, are against it. But it may very well be that some constituents of chromatin find their way ultimately into this body, since both chromatin and the nucleolus readily yield albumen on appropriate treatment¹.

THE DEVELOPMENT OF THE SPORES OF *Fossombronina*
Dumortieri.

After the last archesporial divisions have been completed, the spore-mother-cells loosen their union with each other, and grow for a time before undergoing any further change. The nuclei are at first rather small, and contain a very prominent nucleolus. The linin constituent is very poor in staining substances, and is rather difficult to trace. As the cells approach their full size they become somewhat four-lobed, each protuberance corresponding to a future spore. But the lobed appearance is not nearly so striking here as in most other genera of the *Jungermannia*-series of *Hepaticae*. When the cell reaches its full size the nucleus alters in structure. The linin becomes very clear as a delicate threadwork within the nucleus. It seems always to pass through a peculiar phase about this time, being much massed up together, and this aggregation occurs almost always in the vicinity of the nucleolus. Afterwards it again is visible as an anastomosing mass of threads, which are somewhat tightly stretched from one knot or anastomosis to another. The whole thread now thickens somewhat, and there are seen other threads of very delicate texture running from the nucleolus to the thicker linin. Whether these thinner filaments are remains of the original linin which have not shared in the general increase in bulk it is not possible to say; they are at least similar to it in staining characters. But however this may be, they served to connect up the linin with the nucleolus at this stage. I am

¹ Kossel, Ueber die Nucleinsäure, Verhandl. d. Physiol. Gesellsch. z. Berlin, 1892. Zacharias, Ueber d. Chemische Beschaffenh. v. Cytoplasma u. Zellkern, Ber. d. deutsch. Bot. Gesellsch. 1893.

myself disposed to believe that they do represent linin structures rather than structures originating from the more fluid part of the nucleus. They may also be occasionally observed in the pollen-mother-cells of Lilies at an early period of the nuclear division. The straight threads which run from one anastomosis to another often appear to be composed of a double thread lying side by side; this peculiarity becomes more obvious at a later period, but, as will be seen presently, it can hardly, by itself, constitute the longitudinal fission of the chromatic elements of the nucleus, and it may further possess a totally distinct significance. The nucleus remains in the rudimentary and early phase of karyokinesis for a considerable time, and this is a feature very often met with in spore-mother-cells. Thus it would seem from the accounts given by Belajeff¹ and by Strasburger² that the pollen-mother-cells of *Larix* can continue in a somewhat later phase throughout the winter, only completing the process on the return of warmer weather.

The first sign in *Fossombronina* of renewed activity appears in the cytoplasm in the form of centrospheres. These bodies arise, or at least become first recognisable, simultaneously at *four* points on the periphery of the nucleus which are situated equidistantly from each other, one being opposite to each of the four lobes of the spore-mother-cell. They are exceedingly well marked, and in preparations stained with Heidenhain's iron-haematoxylin and afterwards treated with orange, they are so clear as to be suitable for demonstrative purposes (Figs. 2-4). The central part of the sphere is rather hyaline, and a minute granule may often be distinguished in the middle of it, which I take to be a centrosome. The cytoplasmic radiations spread outwards, and may often reach the periphery of the cell. Occasionally they are seen to terminate in granules, which are sparsely scattered about in the cytoplasm. When a number of these granules lie near

¹ Belajeff, Zur Kenntniss d. Karyokinese b. d. Pflanzen. Flora, Ergänzungsband zum Jahrg. 1894.

² Strasburger, Karyokinetische Probleme, Pringsheims Jahrb. XXVIII, p. 166.

together, they are often united into a sort of reticular system by threads of protoplasm.

As time goes on the nucleus becomes angular, each angle corresponding to a centrosphere, and then a quadripolar spindle of an exceedingly well-marked type is seen as the further result of this angular extension. The nuclear wall is not broken, although it becomes greatly pulled out beneath each centrosphere, and thus the quadripolar spindle is thus far a nuclear distortion. The cytoplasm meanwhile alters its appearance, and becomes vacuolated in a manner highly characteristic for this and subsequent periods. The centrospheres later become more closely approximated in pairs, and although I have not seen the process of fusion it is certain that the first karyokinetic spindle is *bipolar*, and that a simultaneous division of the nucleus into *four* daughter-nuclei does not take place here, as it does in *Pallavicinia*¹. This fact, taken together with the approximation of the centrospheres in pairs, seems to point clearly to the merging of the original four kinetic centres into two, and it is highly probable that the ultimate axis of the bipolar spindle comes to lie in the direction of the resultant of those forces which are operating within the cell, and of which the centrospheres and the radiations are the visible expression. The particular parts of the protoplasm which are involved in the production of the radiations is of a different character from the intervening mass. Although during life the radiations are by no means rigid structures, they become so after death, and I was able to observe in one cell, the side of which had been broken off in cutting it, that the radii extended, unbroken, as stiff projections beyond the edge of the fractured cytoplasm.

Whilst the quadripolar protuberances of the nucleus have been in course of formation, the linin framework also undergoes further change. Chromatin begins to form abundantly within it, and especially so at the places where the thread-anastomoses are found. In fact ultimately it all is found localized in these spots, the linin shrinking up to them.

¹ Studies in Hepaticae. *Annals of Botany*, Vol. vii.

There are formed eight of these aggregation or condensation groups, and they ultimately give rise to the eight chromosomes characteristic of the gametophyte of this plant. The longitudinal fission of the chromosomes occurs during this stage. The aggregations just mentioned lengthen and are then clearly seen to be double. Indeed the longitudinal halves are often so distinct that I believed at first that a fusion of two separate chromosomes, and not the fission of one, was taking place. Each half is very clearly seen in favourable cases to be only a local thickening in the line of the thin and comparatively uncoloured portions still connecting one chromosome with another. The swollen portions of the linin, to which the chromatin is chiefly restricted, then contract, and form the eight intensely staining bodies which are situated just within the wall of the otherwise non-staining nucleus. As they contract, the longitudinal character of the fission becomes more difficult to discern. The chromatin is often seen to be grouped in a singular manner at this stage (Figs. 5-7) when the chromosomes happen to be regarded from one end. Sometimes four such aggregations could be seen in each chromosome, but the number was not sufficiently constant to afford very secure ground for theorising. At the same time the appearance was such as to suggest that a double longitudinal fission may take place here, and thus the next (and final) division may be prepared for. Such a case has been described by Brauer for *Ascaris*, and some of his figures bear a striking resemblance to what is seen at this stage in *Fossombronina*. But the question can only be settled by a study of a far larger amount of material than I had at my disposal. The process is passed through so rapidly that several hundred preparations may be examined without finding the exact stage required. Finally all the unthickened parts disappear, and the chromosomes then appear as either solid structures or else as ring- or ellipse-shaped bodies lying within the nucleus. They become more dense still before the advent of the achromatic spindle, all signs of any longitudinal fusion become obliterated, and they gradually assume their

form of spindle-shaped rods. The nucleolus in the meanwhile fragments, and the particles become attached to the rudiments of the young chromosomes, often in a very striking manner¹; there exists a good deal of variety, however, in the extent to which this relation of nucleolus and chromosome-rudiment obtains. One thing is however clear, that as the chromatin increases in the latter, the nucleoli become less and less easily differentiated, although traces of them can sometimes be observed even up to the time of the differentiation of the achromatic spindle. This body appears with great suddenness, and this particular material is not very suitable for tracing out its genesis, but from the relation of the drawn-out nucleus with the centrospheres it seems highly probable that it is for the most part of nuclear origin. There is, besides the so-called 'nuclear sap,' the unused linin which does not enter into the constitution of the chromosomes, and also possibly a part at any rate of the nucleolus which might serve as material out of which it could be differentiated within the nucleus. My own observations have rendered me sceptical as to the existence of a special spindle-forming substance, and I regard it as not improbable that the spindle represents nothing more than hyaline protoplasm (using the term in its widest sense) which has become strained along 'lines of force.' Thus, for me, it is not a very important matter whether the spindle is of cytoplasmic or of nuclear origin, especially as we know that it *may* be either of entirely nuclear or of mixed origin, taken that is as a whole. To this question I shall return later.

The chromosomes, eight in number, lie along the spindle in the equatorial plane, and they very clearly exhibit a hump in the middle of each one of them, similar to the hump seen in the chromosomes of Lilies during the first mitosis in the pollen-mother-cell. It is not very easy to follow out the true course of events in *Fossombronina*, owing to the minuteness of the chromosomes, but I think I am justified in saying that the

¹ Cf. Strasburger, Die Controversen d. indirecten Kerntheilung, p. 23.

hump is brought about here, exactly as in Lilies¹, by a bending over on itself of the elliptical chromosome, and by the divarication of the limbs formed at the place of bending. Finally the chromosome splits across its middle, that is, across the hump, and the daughter-chromosomes immediately open out to form V-shaped bodies. The limbs are very short, and so the daughter-chromosome may easily be mistaken for a rod, but in a number of cases V-shaped chromosomes were certainly observed. Of course, this does not exclude the possibility of variations occurring, such as have been described² for Lilies and animal cells. In any case, it will be seen that the division of the chromosome is really longitudinal, and not a transverse one, as it would have been had not the chromosome doubled on itself to form the hump already referred to. This doubling over on itself, and the subsequent separation of the daughter-halves of the chromosome, can easily be understood by bending a wire ellipse in the manner described, and on pulling out the two ends thus formed, it will be found that the originally (approximately) parallel sides, which represent the two halves of the chromosome, are thereby separated from each other.

After the separation of the chromosomes, the two daughter-nuclei are formed, and a cell-plate appears in the connecting spindle. It is very delicate, and in spite of devoting considerable time to the question, I was unable to feel quite certain as to whether the spore-mother-cell is at once divided across by a wall into two cells. I believe, however, this is the case, and that in this respect *Fossombronina* conforms to the method of spore-formation, as seen in those other members of the *Jungermannia*e that were examined, in which this certainly takes place. The vacuolated character of the protoplasm, which causes it to be often thrown into plate-like films, greatly increases the difficulty of arriving at a definite conclusion. In one spore-mother-cell (Fig. 12) the division of the cell appeared to be deferred until after the second mitosis.

¹ Farmer and Moore, On the Essential Similarities existing between the Hetero-type Nuclear Divisions in Animals and Plants. *Anat. Anzeiger*, Bd. XI, 1895.

² Farmer and Moore, loc. cit.

The daughter-nuclei rapidly divide again, and the axes of their spindles lie in different directions, so that when one is seen in profile the other is commonly viewed from the pole. I am unable to say how the chromosomes originate for the second mitosis. The whole process is passed through with great rapidity, and I did not, even from a large stock of material, secure any stages sufficiently early. But the appearance of the fully formed chromosomes, when lying on their respective spindles, imitates exactly that seen in the first mitosis. The presumption then is, that the second karyokinesis is also heterotype¹ in character, just as is the first. It is a matter of some importance to settle this question, and I hope to be able to do so when my plants fruit again. The heterotype character of the first mitosis is shared by every spore-mother-cell in its first karyokinesis, so far as it is possible to judge from the figures published by Strasburger and others. Moreover it is also characteristic of that division in the reproductive tissues of animals in which the nucleus comes out of rest with the reduced number of chromosomes. Now in animals the subsequent mitoses vary in character, and also may exhibit certain interesting and, at present, obscure peculiarities; often the next division, at any rate, is heterotype, but it may also be homotype. The divisions in the spore-mother-cell of Lilies belong to this latter category; the first mitosis is strikingly different, not only from all the preceding vegetative divisions, but also from the one which follows it within the pollen-mother-cell. The indifference manifested in the second mitosis in animals (and probably also in *Fossombronia* when compared with *Lilium*) as to whether it be heterotype or homotype, is of some theoretical interest; it proves that the apparent transverse division of the heterotype chromosome cannot be interpreted as the separation of a pair of V-shaped chromosomes which had become attached by their free ends to each other.

¹ A term introduced by Flemming to denote the remarkable form of karyokinesis met with in the division of the spermatocyte-nuclei of the Salamander. Archiv für Mikrosk. Anat., Bd. XXIX, p. 400 et seq.

After the final separation of the chromosomes, each of four daughter-nuclei becomes invested with its proper wall and the spore-mother-cell becomes divided into the four spores, the protoplasm still retaining its singular vacuolated appearance (Fig. 13). The protoplasm of each spore immediately surrounds itself with its proper membrane, the membrane of the spore being shortly afterwards also differentiated. The wall of the spore-mother-cell then becomes mucilaginous, and the same is true of the partition-walls, and so the spores are ultimately set at liberty. The solution of these walls is not so easy to follow. I have met with the best results by using orange G, which stains the swelling membranes deeply, and thus marks them clearly from the proper spore-membrane. The centrospheres have also long ceased to be recognizable, and apart from the radiations which characterize them during the active periods of nuclear division, there is no feature in these cells, by which I find them to be distinguishable. The vacuolated and rather granular protoplasm, indeed, would seem to preclude any positive conclusion as to their permanance being reached.

Pellia epiphylla.

The spore-mother-cells of *Pellia epiphylla* afford good material in which to study the changes which occur in nucleus and cytoplasm during the formation of spores. After the completion of the archesporial divisions, the spore-mother-cells become isolated from each other, and a considerable period of rest and growth intervenes before the two final mitoses take place. The effects of growth are manifest both in the cells as a whole, and also, subsequently, in the nucleus. As regards the entire cell, it conforms to, and indeed exaggerates, the type characteristic of the Jungmannia series of Hepaticae. At first more or less irregularly spherical, it soon becomes four-lobed, and these lobes increase in size, chiefly owing to radial extension, so that the spore-mother-cell ultimately comes to consist of four large spaces whose cavities communicate with each other by means

a small central space common to them all. The nucleus is always found to be situated in this central common region (Figs. 17-20).

If the nucleus be examined at a stage in which the cell as a whole has reached rather less than one-third of its final size, it will be seen to possess a well-marked wall, within which is contained a very distinct linin thread. The latter is very much convoluted, and lies just within the wall, though some parts of the filament are also visible in the more central regions of the nucleus. It is very easily differentiated at this period, as it still possesses a considerable amount of chromatin which is distributed through its substance. There is also present one (seldom more than one) large nucleolus.

As the sporogonium increases in size the spore-mother-cells also become larger, but the process is one which takes considerable time as compared with the cells during what may be termed their archesporial period, in which both growth and division proceed rapidly. The linin next loses its definiteness, owing to the disappearance of its chromatic constituents as such, but *pari passu* the nucleolus becomes more clearly prominent. It now absorbs greedily those stains used for differentiating chromatin, although in its reactions to these substances it is not quite similar to chromatin. It shrinks somewhat in size and occupies the centre of the nucleus. Indeed at this period it is easy to mistake it for the real nucleus, for the extra-nucleolar portion now hardly differs from the cytoplasm save in its rather denser and more uniform consistency. This peculiarity is one which is shared by a large number of liverworts at the stage in question, and it is also a familiar one in the vegetative nuclei of many Algae.

In the next stage, that is, when the spore-mother-cells have reached their mature size, the nucleus again begins to alter its appearance preparatory to the two final mitoses; the nucleolus becomes less chromatic in character, and assumes a more peripheral position, whilst at the same time the linin thread is again clearly distinguishable. It is in nearly all cases seen to be specially aggregated and convoluted in the

vicinity of the nucleolus (Fig. 18). This aggregation is, I believe, to be regarded as an artefact produced merely by the inadequate action of fixing-reagents. It is confined to these particular divisions in the reproductive cells, and is absent from all other dividing nuclei which may have been fixed in the same material and at the same time; thus it is not seen in the cells of the vegetative regions of either gametophyte or sporophyte, nor does it occur in the earlier asexual or sporial divisions. Furthermore it is best seen in those cells which in other respects seem to be the best preserved. Again, the fact that the aggregated linin was differently orientated in even neighbouring nuclei seems to tell against the view which would regard it as a mere artefact. Hence I would expressly state that I did not observe the nucleolus flattened out against the nuclear membrane. This body was always free from the wall, though near to it, and thus the structure was no 'sichelstadium'¹ represented. This in itself is perhaps important, since Zimmermann was unable to recognize it in all the spore-mother-cells which he investigated (e.g. *Hyacinthus caudicans*). Humphrey² has suggested that the 'Sichelstadium' of Zimmermann and the *paranucleolus* of Strasburger may be due merely to the faulty penetration of the reagents, but I do not think that either of these structures corresponds with the aggregation of linin I have just described. Moreover an identically similar appearance is seen in the homologous mitoses of animal cells, and my friend Mr. J. E. S. Moore informs me that it can, in some favourable cases, be discerned in the still living cell. At the same time it must be stated that at this particular epoch in the life of the cell, the protoplasm is very sensitive to the action of the reagents. It is exceedingly difficult to fix properly, and displays a tendency to break up into lumps on a slight provocation. Moreover it has suddenly changed its affinity for stains, and now greedily absorbs dyes such as safranin which at other times but slightly affect it. Everything point

¹ Zimmermann, Morphol. u. Physiol. d. Pflanzenzelle, Bd. II. Heft 1, p. 9.

² Humphrey, Nucleolen u. Centrosomen, Ber. d. deutsch. Bot. Gesellschaft, 1887.

to the cell being in a very unstable condition, if I may so express it, and if it were not for the extreme regularity with which the aggregation phenomenon, above described, appears at this stage, I should have regarded it as merely an artificial contraction-effect induced by the reagents employed for fixing purposes. The close connexion of the linin with the nucleolus, and their relative alterations in staining capacity, suggests that in these cases the chromatin itself or some nearly allied substance may have been stored in the nucleolus and is now passing into the linin. At any rate it seems difficult to explain the juxtaposition of the two masses apart from some such hypothesis, since it does not seem to be related to the diffusion of reagents. It may be that it is connected with the formation of the spindle, the functional relation of the nucleolus to which has recently been suggested by Prof. Strasburger¹. But the fact that the spindle is not formed till long after this phase is over, seems to be opposed to such a view as applied to this particular case, although it by no means follows that the nucleolus may not *also* be connected with the spindle formation in other plants, or perhaps in this one too, at a subsequent period. The 'aggregation' condition very soon passes over, and the linin filament becomes both shorter and thicker. Owing to the small size of the object, it is very difficult to be quite certain whether a longitudinal splitting of the thread occurs at this period, but I think I am justified in stating that it does, but it is of a somewhat irregular character and not very well marked. At uneven intervals the linin is seen to be very much thinner than at other places, and there may nearly always be distinguished two thin filaments lying close together. In *Pellia* it is not nearly so easy to follow out the course of events at this stage as in *Fossombronia*, but what evidence there is, all points to the processes in both being in reality quite similar; and this is especially true of the succeeding changes. Eventually the chromatin is seen to be almost confined to

¹ Strasburger, Karyokinetische Probleme, Pringsheims Jahrb. f. wiss. Bot., Bd. XXVIII.

specially-thickened areas of the linin, and these mark out the future chromosomes. In many instances it seemed as if the chromatin were grouped in four distinct patches in each chromosome-rudiment, as Brauer described it in the case of *Ascaris*¹. And in the event of this being general it would point to a double fission, whereby the chromosome elements would be thus early distributed for the two following mitoses. But I was unable to recognize this arrangement with such sufficient regularity or frequency as would lead to so important a conclusion being definitely drawn, though I regard it as a very probable one. Many chromosomes, however, at this stage showed more than four chromatic groups, and this would seem rather to diminish the value of those observations in which the fourfold grouping was distinctly visible, for there was no evidence to show that the former was merely a transitional stage of the latter; at the same time it might easily be due to the chromosome having been observed in an oblique position. Contraction of the chromosome still proceeds, and these bodies, eight in number, are clearly seen to possess the form of *rings*, or loops closed at both ends (Figs. 20, 21). At this period the nucleoli cease to be longer visible. The original large nucleolus almost always fragments, after becoming very much vacuolated, and the particles into which it breaks up are usually seen to be lying on or close to the young chromosomes. It does not of course follow from this that substance is directly passing out of them into the segments of the linin, although I think this to be not improbable. It is, however, possible that their proximity has a mechanical rather than any other relation, and that as they decrease in size, their substance at first diffuses into the surrounding nuclear sap, whatever may be its ultimate destination. The chromosomes become shorter and thicker, and their ring-like shape is no longer discernible. They are at first lying somewhat irregularly in the nucleus, but they gradually assume a regular arrangement in the equatorial

¹ Loc. cit.

plate of the nucleus. Nothing has hitherto been said as to the origin of the spindle, which must now be considered.

At an early period in the process of mitosis, a centrosphere appears at four points on the periphery of the nucleus, and these points correspond with the four lobes of the spore-mother-cell, just as in *Fossombronia*. The centrosphere contains a minute centrosome, and from it, though starting at a very short distance from it, are seen radiations which extend into the lobe in front of which it is situated. The small clear space around the granule may perhaps be caused by the fusion of the radiating filaments. Each centrosphere apparently exercises a pull on the nucleus, which becomes drawn out at each of the four spots, and forms a small protuberance into each lobe. Later on the radiations diminish, and the nuclear protuberances are less easily seen; in some cases they seem to fuse pairwise, probably by the mutual fusion of the centrospheres, but in other instances there is no doubt but that this quadripolar spindle persists through the first mitosis (Fig. 23). It must be clearly emphasized that the nuclear wall is quite visible to a late period, and that the quadripolar figure is entirely, in its earlier stages at least, of nuclear origin; only the centrosphere is cytoplasmic. But the nuclear wall can no longer be distinguished when the chromosomes reach the equator, and the achromatic spindle-fibres are completely formed. The achromatic spindle is often very short, but it varies a great deal in this respect. The difference seems to depend on the length of the arms of the quadripolar body. If they have extended far into each lobe of the spore-mother-cell, then the spindle is elongated, and it often is divided up, so that there is an apex in *each* lobe. But no simultaneous division into four nuclei follows, even in these latter extreme cases, and thus the four spindle-arms when present act in pairs. The chromosomes agree in shape with those met with in the first division of the pollen-mother-cell of *Lilium*, that is they exhibit two processes which lie along the spindle, and a humped portion which is directed outwardly from it. The same mode of division of the chromosome as has been

described in the case of the Lilies also obtains here, although it is more difficult to follow out the process on account of the minuteness of the structures in question in this plant. The daughter-chromosomes retreat as open V's with their apices directed polewards, and they aggregate as the two daughter-nuclei into two groups placed very closely to the cell-plate which forms between them. The cell-plate forms a cell-wall which exhibits very remarkable curves, the general effect of which is to enable it to meet the walls at the middle of the spore-mother-cell at right angles. In fact it appears, in this respect, to obey ordinary physical laws, since a comparison instituted between it and the behaviour of a soap film introduced into a glass model of the spore-mother-cell which I had constructed, revealed a most remarkable degree of correspondence between the two cases.

I am unable to say whether the two daughter-nuclei in *Pellia* enter into a condition of rest before they finally divide once more. This does happen in some liverworts, for example in *Scapania* and in *Lophocolea*; but if it also occurs in *Pellia* it must be very quickly got over, since I never saw any instances of it. In fact the whole process is very rapidly passed through, and intermediate stages are in any case difficult to get. But when the chromosomes of the second division are in the equatorial plate, and lying on the spindle-fibres, they resemble exactly the corresponding structures of the first mitosis. In this they are in marked contrast with Lilies. In the latter plants the second mitosis of the spore-mother-cell is strikingly different from the first one in all its more obvious features. But it does not therefore follow, in the case of *Pellia*, that a second *heterotype* division follows on the first one, because in this plant the homotype vegetative mitosis in the germinating spores are also hardly distinguishable from the heterotype mitosis when both are examined at the somewhat late stage in which I found them. The heterotype is, however, clearly recognizable in the younger condition, both on account of the very *early* longitudinal fission of the linin, and also by reason of the peculiar forms assumed by

the young chromosomes. In the absence of the early stages of the second mitosis it is impossible to be sure whether it conforms in general characters with the homotype form met with in the gametophyte, or whether it rather should be regarded as a second heterotype. There would be nothing strange in the recurrence of this latter form, since it certainly reappears in the *successive* spermatogenetic mitoses in many animals.

After the chromosomes have receded to their respective poles the cell-plate now formed is converted into a cell-wall, and thus the division of the spore-mother-cell is completed. Very shortly after these events, changes become visible in the outer and common wall of the spore-mother-cell. It becomes extremely thin, except at those parts where the lobes were in close contact, and in the meanwhile the inner, newly-formed coat begins to exhibit the spiny character which is met with in the mature spore. The peripheral parts of the membrane become more and more attenuated, and finally disappear, but the thickened portions which lie in the angles formed by the lobes persist for a time, and sometimes break away and are found lying free amongst the spores. The separation of these bodies is effected by the final disappearance of the primary division wall¹, but the period which elapses before this occurs is subject to some variation.

After the complete formation of the spores they may either rest for a time within the sporogonium, or they may proceed at once to germinate. And in the latter event the process may even commence before the separation of the spores from one another (Fig. 28).

The first sign of change is seen in the nucleus and surrounding protoplasm. Beautiful centrospheres² with abundant radiations appear on opposite sides of the nucleus, which is rapidly drawn out in the direction of the longest axis of the spore.

¹ This agrees with Strasburger's statements, *Zellbild. und Zelltheil.*, dritte Auflage, p. 157.

² Cf. Farmer and Reeves, On the occurrence of Centrospheres in *Pellia epiphylla*. *Annals of Botany*, Vol. viii.

The linin goes through none of the evolutions which distinguish the first heterotype mitosis, but becomes visible as a thickening thread which is divided into eight segments. These double upon themselves, and so resemble V's whose limbs are nearly, or even quite, in contact. They place themselves on the spindle with their angle directed centrally, and at once split longitudinally. But the fission, thus deferred beyond the time usually assigned to even homotype divisions, is not at first complete through the entire length. It commences at the angle, and the split portions at once diverge polewards along the spindle-fibres. Thus an appearance is produced which irresistibly recalls that presented during the final separation of the segments of the heterotype chromosomes, and it is only the differences in their respective earlier stages which differentiates the one from the other. Further, a comparison of *Pellia* with *Fegatella*, in which the spores also germinate while still within the sporogonium, conclusively shows that we are here dealing with a true, if somewhat aberrant, homotype mitosis. For the process of karyokinesis in *Fegatella* is almost diagrammatic in the regular and typical succession of the events and in the distinctness of the several stages.

The nuclei of the *sporophytic cells* exhibit sixteen chromosomes, instead of eight, when in the equatorial plate, and thus this plant furnishes another instance of the correctness of Overton's view as to the correspondence of the reduction in the number of these bodies with the periodic alternation of generations.

I observed a slight amount of variation in the number of the chromosomes in the nuclei of the germinating spores (gametophyte). Thus in two cases there were certainly *nine*, and not eight chromosomes as in the great majority of the nuclei, and in one case I could only count seven. This last instance was taken from a very good preparation, and I do not think that there was any reason to think one chromosome had become displaced or that it had been so obscured by another one that I missed counting it. But these facts do not

invalidate the general rule that the number of the chromosomes is normally constant. Cases are known both in plants and in animals of a diminished or increased number occurring as exceptional cases. Of course there are the further instances of the antipodal cells of Lilies described by Guignard, and of the late endosperm cells in *Pinus* mentioned by Dixon; these, however, occur in declining tissues, and are therefore perhaps not to be regarded as on the same line as variations occurring in the first stages in the existence of the organism.

Aneura multifida.

The process of spore-formation in this plant recalls that observed in *Fossombronia*, except that the number of the chromosomes are more numerous. A very well-marked quadripolar spindle is seen during the earlier stages, and the end of each arm, which protrudes into the rather shallow lobes of the mother-cell, is occupied by an exceedingly well-marked centrosphere, with exquisite radiations extending from it. The division of the nucleus is successive, and an interval of rest occurs between the first and second division. These two mitoses are, so far as I could determine the point, exactly alike, and when seen in the equatorial plate the chromosomes often exhibit the ring form with greater or less distinctness (see Fig. 36). It would be very desirable to repeat these observations on *Aneura pinguis*, of which I have for two years endeavoured to secure sufficient abundance of fruiting specimens, hitherto without success. The nuclei are very much larger in this species, and are in every way better fitted for accurate and close observation than is the case with those of *A. multifida*. In the latter plant it was clearly seen that the number of the chromosomes is reduced to one half between the last archesporial and the first spore-mother-cell division, and also that the appearance of the chromosomes in the two cases respectively is very different, just as has already been mentioned for other genera.

Fegatella conica.

The characters of the spore-formation as presented by this

plant differ considerably from those exhibited in the Jungermannia series. The spore-mother-cell is a flattened oval body, rather like a biscuit in shape. The nucleus is prominent and large and is enclosed in a coarsely granular protoplasm, from which it is separated by a very well-marked membrane. The spore-mother-cells increase very greatly in size between the last archesporial division and the two final mitoses which result in the formation of the spores. As the time for these last divisions approaches, the character of the protoplasm alters; it evinces a much greater readiness to take up stains, and is more difficult to fix than at other times. But the latter remark does not apply to the nucleus, which in this particular plant is easy to fix, and gives very clear preparations, even at this, the most critical and usually most difficult period.

It is a noteworthy fact that neither in this plant, nor in any member of the Marchantia or Riccia series which I examined, was a quadripolar spindle at any time observed¹. I think that this point is of some interest when taken in connexion with other differences which exist between these groups and that of the Jungermannia alliance. In all of the former sections (with perhaps one exception), the *absence of the lobed character* of the spore-mother-cell was noticed, and this is very marked when one bears in mind the frequency, perhaps the universality, of this peculiarity in the Jungermannia series. It is true that the flattened character of the spore-mother-cell, which is so striking a feature in *Fegatella*, is absent from other forms, such as *Marchantia* (two species examined), *Plagioglypta*, *Fimbriaria*, *Riella*, *Riccia*, and *Targionia*, in which the spore-mother-cells are spherical. The last-mentioned plant is of interest inasmuch as its spore-mother-cells are at first slightly four-lobed, and there is some doubt as to its agreement with the rest in the main features of its cell-division. Unfortunately, however, its protoplasm is excessively difficult to fix properly, on account, probably, of the large quantity of oil-drops which it contains. Thus, although I had a con-

¹ With the possible exception of *Targionia*, reckoning it with the Marchantiaceae. See *infra*, p. 499.

siderable amount of material at my disposal I am unable to speak with confidence about the more delicate details of its nuclear division.

As the spore-mother-cell of *Fegatella* begins to prepare for its final divisions, besides the changes in the cytoplasm already alluded to, an alteration is seen in the structure of the nucleus. At first this body is not very easy to discriminate. The linin takes no stain other than that absorbed by the cytoplasm, and it is the nucleolus, with its intense capacity for absorbing dyes, which strikes the observer. But as time goes on, the nucleus loses its comparatively homogeneous aspect. The linin threadwork becomes plainly visible, and is arranged in an almost diagrammatic way with regard to the nucleolus. When this body happens to be so orientated as to be seen in the middle of the nucleus, the linin threads are seen to radiate out from it, like the lines of longitude from the poles of a globe. When seen from the side, a corresponding connexion is also clearly discernible. I take this to represent the same aggregation stage as is seen in *Pellia* and other forms, but in *Fegatella* the subsequent occurrences lend additional support to the view that the connexion of the linin with the nucleolus is not a merely accidental one. The nucleolus now fragments, sometimes two or three, but oftener a larger number of small nucleoli are seen, and in every case the linin filaments are associated with them. It may be urged that there can be no real importance attaching to this observation, since the large nucleolus of the pollen-mother-cells of Lilies and other plants is often not obviously connected with the linin. But even in the case of these latter cells, the nucleolus often is related to the linin, and Strasburger has drawn attention to it in his recent memoir. Moreover I am myself convinced, after an inspection of a large number of preparations, that there exists in Lilies also, a very important relation between the linin and the nucleoli during the earlier stages of karyokinesis. But *Fegatella* certainly exhibits this relation far more clearly than in any other plant with which I am acquainted, and it is seen not only during the differentiation

of the reproductive cells, but almost equally well during the germination of the spores.

At this period, that is, when the nucleolus is fragmentary, the longitudinal division in the linin thread is effected, but it is not easy to follow out the details owing to the obscuring effect of the nucleoli. The linin, which is now becoming increasingly rich in chromatin, swells up and finally breaks into eight chromosomes, but I could not at this time find any trace of the primary slit formed by the earlier longitudinal fission. The spindle is now formed, and the eight chromosomes lie along it. They resemble the chromosomes of *Lilium* at the corresponding stage, and each one consists of a hump or thickening, directed outwards from the spindle, and two limbs which lie along it. When they have reached this stage they may in favourable cases be recognized as being of a ring-like form (Fig. 61), though this is often difficult to determine. Eventually they divide across the middle, and the two daughter-halves retreat towards their respective poles. A cell-plate is then formed across the equatorial plane of the spindle, but it remains in a rudimentary condition, and does not effect a division of the cell. The two daughter-nuclei immediately divide again, and so far as I could determine the question, the second division is here also exactly similar to the first, in its later stages at least. There is the less doubt in this case (as compared with *Pellia*), since the normal vegetative mitoses are very different from those which we are now considering (cf. Figs. 70, 71). It must for the present be left an open question whether the second mitosis is prepared for during the formation of the young chromosomes for the first division. I failed to find any direct evidence for this hypothesis, though I especially looked for it. Sometimes, during the shortening up of the linin to form the chromosomes, a localization of the chromatin at four spots could be seen, but this did not occur with sufficient frequency to admit of any safe generalization being based on it. At the same time, a similar condition was sometimes observed both in *Pellia* and in *Fossombronia*, as mentioned above.

I hope, however, to be able to settle definitely this point, both in *Fegatella* and in those other liverworts in which I have so far failed to reach a position of certainty as to the exact mode of procedure. The omission here is due to the great difficulty of getting enough material suitably fixed at exactly the right time. This being so, it seems better to avoid speculation, which further observation may only show to be unsound. But whatever the exact mode of origin of the chromosomes previous to the final karyokinesis may be, there is no doubt whatever as to the further course of events. The eight chromosomes possess, as has been said, exactly the same shape as those in the first division, and when they divide at the equatorial plane, they exactly resemble the chromosomes of the first heterotype division. The daughter-chromosomes now retreat to the spindle poles, and radiations extend from each daughter-nucleus to the two others which are nearest to it, and, further, a spindle appears connecting the two nuclei which are situated at the obtuse angles of the rhombus formed by the peripheral spindles (Fig. 59). In this way *five* spindles are formed altogether, and in each one a cell-plate is formed. These all unite ultimately, and thus the spore-mother-cell is divided into the four special mother-cells. The elements of the nuclei have now begun to enter into a state of rest, and they do so in the reverse order in which they came out of it. The nucleoli reappear in all cases, several in number, and they are always associated with the linin thread which has been re-formed, by the fusion of the chromosomes. The filament shows frequent anastomoses, and perhaps this points to the fusion of the chromosomes not being so regular as is sometimes supposed. As the nucleoli increase in number and in total bulk, the linin becomes thinner and diminishes in its staining capacity. Gradually the nucleoli run together, and though vacuolated at first, they lose this character as the whole process nears its termination, until finally there only remains in each spore-nucleus a single large nucleolus¹, and a diffuse and somewhat indistinct tangled

¹ It is not meant to imply that the nucleolus becomes the receptacle for the

linin filament ; these are all enclosed in a wall, and are bathed in sap. The nucleus as yet, however, is by no means as structureless as it (probably only apparently) becomes at the time when the spores are lying free within the sporogonium. The separation of the spores is effected by the disappearance of the outer wall of the enclosed tetrad, and by the degradation of an extremely thin film in each of the recently-formed dividing walls. It is very easy to miss the stage of disappearance of the outer walls, but it is quite clear if observed at the right time.

GERMINATION OF THE SPORES OF *Fegatella*.

The spores of this plant germinate while still enclosed within the sporogonium, as do those of *Pellia*, but the process does not begin so early as in the latter-named plant. The difference in character between the gametophyte divisions as contrasted with the spore-mother-cell mitoses is most striking. The whole process accords with what we are accustomed to regard as the normal type of karyokinesis, and in this respect it compares favourably with *Pellia*, in which owing to a comparatively slight modification the proper relations are very much obscured. But *Fegatella* also exhibits a little variation, and it was by a comparative study of these differences that I arrived first at a clear idea of the structure of the gametophytic chromosomes in *Pellia*.

The resting nucleus in the newly-formed spores contains one or more deeply staining nucleoli and a tangled thread of linin, which is especially grouped in their vicinity. The rest of the nucleus is filled with a clear nuclear sap and the whole is enclosed by a nuclear wall. As the nucleus prepares for division, the linin alters its appearance, though still very delicate, forming a convoluted thread which exhibits frequent anastomoses.

The thread is stretched across the nucleus in various chromatin. The researches of Zacharias seem to entirely negative the probability of any such crude hypothesis. [Zacharias, Ueber d. Nucleolus, Bot. Zeit. 1885.] See also below.

directions, and its general character recalls the framework of radiating filaments in a spider's web. The nucleolus is situated in the middle of these radiating threads, and the appearance is such as to strongly suggest an intimate connexion between the two structures. As the linin becomes more pronounced in character, the centrospheres are seen on the periphery of the nucleus at opposite sides. They are difficult to distinguish at this stage, on account of the feebleness of the radiations, later on they are however readily recognized.

The nucleolus now becomes very much vacuolated, and no longer stains with its former intensity, but as the nuclear sap remains quite unstainable, and the only structure which at this point suddenly begins to absorb dyes greedily is the linin, it seems not unreasonable to conclude that something has passed out of the nucleolus to the threadwork. At any rate one is otherwise driven to suppose that the material which leaves the nucleolus, and thereby causes its vacuolated appearance, alters its reactions to stains entirely as it diffuses out into the nuclear sap. After the vacuolation just spoken of the nucleolus commonly fragments, and finally disappears at the formation of the achromatic spindle.

Meanwhile changes have gone on in the linin filament. Certain portions of it, which are relatively somewhat elongated, have become thickened, and now greedily absorb the ordinary nuclear stains. These thickened portions are the rudiments of the young chromosomes, and they certainly owe their present features to the increase of chromatin within the linin substratum. It is not easy to assign an origin to this chromatin which thus appears in these localized spots. The behaviour of the nucleolus already alluded to strongly suggests that it may have some share in the process, but I do not think it at all probable that it is *alone* concerned. Professor Strasburger¹ has suggested that the chromatin originates from the cytoplasm, in part at any rate, and I am inclined to attach importance to this possibility. Perhaps both nucleolus and cytoplasm may each furnish their respective

¹ Karyokinetische Probleme. Pringsheims Jahrb., Bd. XXVIII.

portions, which only assume all the characters of chromatin when they meet in the nuclear framework.

The regions in the linin which remain destitute of chromatin form the separation limits between the individual chromosomes. The latter bodies, however, still remain united by these delicate filaments even when they begin to group themselves under the nuclear wall. The chromosomes are also irregularly connected with each other by similar threads attached to other parts than the ends.

The origin of the latter filaments is obscure, but I regard them as being of linin origin¹. They become later indistinguishable from the threads of the achromatic spindle, though it is not possible, as yet at any rate, to state definitely that they form any component structural elements in this body. The young chromosomes are at first of an irregular shape, but later they nearly always assume the form of the well-known bent rods, and on the appearance of the spindle they become attached in the equatorial plane at its periphery with the free ends directed outwardly from it. Each chromosome is now divided longitudinally by a split in the plane of the whole bent body. Nearly always the split is complete, and the two chromosome-halves then become 'roped up' so to speak along the spindle, in such a way that the apex of each V is directed towards the pole. In nearly every case a well-marked sheaf of fibres is attached to this apex and seems to pull the chromosome towards its destination. The two sister-halves are commonly connected across the equator, from which they are now diverging, by connecting fibres. The latter fibres become much more numerous as the chromosomes recede from each other, and a cell-plate is subsequently formed across them in the usual way. Very often some of the connecting fibres stray away from the main spindle and become attached to nucleolar-like granules, which are very

¹ It will be recollected that the linin exhibits frequent anastomoses, and possibly the structures in question may owe their origin to these; at the same time it may be pointed out that young chromosomes often exhibit a ragged surface, even where anastomosis is not frequent.

abundant at this stage in the cytoplasm about the spindle. The appearance of these granules, and their relation with the spindle-fibres is such as to lend support to Strasburger's view of the nutritive relation of the nucleolus to the cell-plate.

Sometimes, however, the process is not so regular, as regards the behaviour of the chromosomes, and this especially applies to the mode of fission of these bodies. If they split through their middle portions, but not quite out to the ends, a complicated figure may result, and if further, the limbs of the V-shaped chromosome become closely approximated instead of widely separated, the same appearance met with in *Pellia* is produced. The apices of each half of the V (which may be regarded as split in the plane of this paper) then diverge towards their respective poles, whilst the ends of the two limbs are as yet undivided. It is obvious that in this way a figure may be produced which is essentially similar to the normal splitting of a heterotype ring, though the events which have preceded this particular state differ widely in the two cases. But it is of interest to note that this *delayed* fission (so to speak) may occasionally occur in *Fegatella*, whereas it is the ordinary event in *Pellia*.

It is remarkable that at the aster stage the radiations around the centrospheres die away completely for a time¹, and the centrosphere can no longer be readily distinguished. But just before, and during, the migration of the daughter-chromosomes to the poles, the radiations again become perfectly distinct. It is well known that the duration of the aster stage is relatively of considerable length, and thus perhaps a condition of comparative repose is temporarily established; this is, however, again broken during the final movements of the daughter-chromosomes to the poles, and it may be that the reappearance of the radiations, which certainly often extend to the periphery of the cell, is directly connected with this renewed activity, and renewed necessity for fixing the position of the poles. After the chromosomes have arrived at their destination, the daughter-nuclei become

¹ See also *Pellia epiphyllia* for a similar occurrence (Farmer and Reeves, loc. cit.)

rapidly formed. The cytoplasmic radiations from the centrospheres entirely disappear, and with them the possibility of distinguishing either centrosphere or centrosome. The connecting fibres, however, persist for a short time, until the spore is completely divided by a cell-wall.

The most noticeable feature of the daughter-nucleus is its extreme clearness with which the stages by which it passes into the resting condition are shown. Very shortly after the appearance of the nuclear wall, the nucleoli are formed within it, and they are exactly similar to the small bodies already alluded to which are discoverable about the connecting fibres at this stage. They are at first small, and of two or three in number, and they exhibit the same relation to the linin framework as has been already described in the earlier phases of division. At first they are vacuolated, and this condition persists for a while after their fusion into a single large one, but gradually this appearance is lost, and *pari passu* the linin loses its chromatic constituent, or at any rate it is no longer distinguishable. The threads of linin now become excessively fine, but they are still quite clear within the nucleus, and they are stained brown, like the cytoplasm, by Gentian Violet and Orange G., whereas the nucleolus absorbs the Gentian Violet just as the chromosomes did when still rich in chromatin.

NUCLEAR DIVISION IN THE SPOROPHYTE.

I observed several cases of karyokinesis in the sporophyte of this plant, including cells of the archesporium and also the wall of the capsule. I did not investigate them minutely beyond assuring myself that in both tissues there were six chromosomes in each nucleus instead of eight, as in the gametophytic nuclei.

Plagiochasma, Riella, Marchantia, Fimbriaria.

Plagiochasma, in the general character of its spore-formation, recalls that of *Fegatella*, but it differs from it in possessing a spherical spore-mother-cell instead of a flattened one. T

spore-mother-cells, as in the other plants, rest for a considerable time before entering on their final divisions, and they also increase in bulk very considerably during this interval. The behaviour of the nucleus resembles that of *Fegatella* that it is not necessary to enter on details here, especially as I was not able to get an unbroken series of stages. The first mitosis does not result in a division of the mother-cell; a cell-plate is formed (Pl. XVII, Fig. 56), but it remains in a rudimentary state. Immediately after the first division, the two daughter-nuclei divide again (Fig. 57), and the resulting four nuclei take up positions similar to those occupied in a dicotyledonous pollen mother-cell (Fig. 58). The cell is then simultaneously divided into four daughter-cells, the protoplasm of which speedily becomes invested by a new membrane. The four cells then separate by the disintegration of the original wall together with the partition walls.

Essentially the same course is followed during the spore-formation of *Riella*¹, in two species of *Marchantia*, and in *Fimbriaria*², and they all differ from *Fegatella* in the spherical shape of their spore-mother-cells. It is a marked character of all these plants of the *Marchantia*-series that quadripolar spindles are *not* present. It is impossible to avoid the conclusion that this is connected with the difference in the shapes of their respective spore-mother-cells at the commencement of nuclear division, especially the presence or absence of lobes. *Targionia* is an interesting form in this respect. It does exhibit a slight amount of lobing, but unfortunately the spore-mother-cells are so exceedingly difficult to fix that at present we can hardly speak very confidently about it. But in several cases I saw what I take to be quadripolar spindles, and I do not think that I have been deceived by mere contraction figures; I hope, however, to re-investigate this plant when it next fruits. The great difficulty which arises in fixing the cell-contents arises from the frothy character of the protoplasm, which is filled with

¹ I am indebted to the kindness of Prof. Strasburger for material of this plant.

² Prof. D. H. Campbell kindly sent me material of this plant.

oil globules. At present, however, this is the only liverwort allied (almost certainly) with *Marchantia* in which I have observed any sign of a quadripolar spindle.

***Scapania undulata*.**

The cells in *Scapania* after the last archesporial division become loosened from each other, and each one grows to a considerably increased size. As this increase becomes apparent, it is seen that the growth is not uniform, but that it is more active in four equidistantly-placed regions, and thus the cell as a whole assumes the four-lobed shape which is so characteristic of perhaps all the *Jungermannia* series of hepatics. The nucleus is situated in the centre of the cell, and consequently at the junction of the cavities formed by the four pouch-like outgrowths. As the spore-mother-cell approximates to its final size, the nucleus alters its appearance. During the earlier period, it is a rather diminutive spherical object, containing a small but readily stainable nucleolus. The extra-nucleolar portion, however, hardly stains at all and it is difficult to make out any structure within it. But on passing out of the period of repose, the extra-nucleolar part becomes granular, and the linin framework is easily discernible. The nucleolus loses its compact and almost solid appearance, and often becomes vacuolated. At the same time the nucleus as a whole exhibits a change of shape. From being spherical, it passes into a kind of tetrahedral form with one angle directed towards the cavity of each of the four cell-lobes respectively. This appearance becomes accentuated as time goes on, until a quadripolar spindle is formed (Pl. XVII, Fig. 42). I was unable, in this plant, to observe with certainty the presence of well-defined centrospheres, and this seemed a little strange, as they are so obvious in some other liverworts (cf. *Fossombronia*). The duration of the quadripolar spindle condition is but brief, and it is eventually replaced by an ordinary bipolar spindle. But when this spindle is examined, it is seen to be always arrayed with regard to the symmetry of the spore-mother-cell. That

is, one of its poles is directed (apparently) into the cavity of a lobe, while the other is seen to terminate about a partition between the two lobes. And if the spindle end which occupies the latter position be regarded carefully, it will become obvious that it may sometimes fork, and that each limb of the bifurcation ends in an adjacent lobe. This is shown in Pl. XVII, Fig. 43. The apparent termination of the opposite end of the spindle in one point is, I believe, due to the fact that one sees the bifurcating limbs lying exactly one above another; that is, it is in reality similar to the lower end, but the limb which enters the fourth cell lies in the same vertical plane with its fellow. Thus it seems clear that the apparent bipolar spindle here is the result of a more or less complete coalescence of *four* original protuberances.

I am strongly of opinion that the spindle here produced is of *nuclear* origin. During the quadripolar condition the chromatin is seen to be distributed in the form of eight little aggregations, much like those in *Fossombronia*. These little aggregations (Figs. 41 and 42) are the rudiments of the future chromosomes, and there can exist no doubt but that these bodies form *closed rings*; when they are mature they take up a position just beneath the nuclear wall, and flatten out, so that they soon appear as mere rods. After the disappearance of the nuclear wall, they lie with their long axes directed along the spindle, and they then split across the middle as shown in Fig. 46. The daughter-chromosomes move apart, and a cell-plate is formed, which ultimately forms a membrane dividing the spore-mother-cell into two parts. Each of the two daughter-nuclei then divides once again, and the process is, so far as I have been able to follow it, an exact repetition of the first mitosis. Both of these two divisions are then *heterotype*.

Cephalozia bicuspidata.

The stage in this plant where a quadripolar spindle might have been expected was not observed, but during the first mitosis the forked spindle so nearly resembles that of *Sca-*

pania, that it seems reasonable to conclude that both have passed through a similar history. The chromosomes are much smaller. The same curious prophase was seen in the plant as has been described for *Scapania*, but it is not so obvious owing to the smaller size of the cells, and still more so to the increased number of the chromosomes. In the mature spindle there are about eighteen chromosomes, and as they are very small, it is exceedingly difficult to follow out the minute details. This much is however certain, that they consist of flattened rings, and that they divide across the middle, thus serving as another example of a heterotype mitosis. The second division is exactly like the first, and both differ markedly from the divisions which obtain in the gametophyte. I did not see any mitoses in the archesporial cells.

***Lophocolea bidentata* and *L. ciliolata*.**

The same features which characterize *Scapania* are also met with in *Lophocolea*, but in some respects the latter is a more advantageous object than the former, inasmuch as the spore-mother-cells mature more gradually, and thus several stages may often be made out in one preparation. The lobing of the mother-cell is a little more marked than in *Scapania*; the nucleus is situated, in both groups, in the centre of the lobed cell. It seems, however, a singular fact at first sight that the quadripolar spindle, so striking in *Scapania*, is difficult to distinguish here, although the tetrahedral shape of the nucleus becomes plain enough. I do not, however, attach very much importance to this, as experience shows that the stages at which this form of spindle is clearly recognizable may be very transient, and that in this respect much variation is shown amongst even closely allied forms.

The nucleus, during the earlier period, consists of a slightly staining ground-substance, which surrounds the nucleolus. This body stains sharply and intensely, but later on, it becomes vacuolated, and stains far less readily. This change occurs simultaneously with the initial differentiation of the chromosomes. These bodies originate as granular areas, each

of which is separate from all the rest, and rather resembles a little heap of coarse sand when treated with reagents which specially stain the chromatic elements of the nucleus. Later on, however, as the granular aggregations become more pronounced, the connecting groundwork of linin is also visible. Each chromosome-rudiment subsequently assumes an elliptical shape, which eventually passes over into the well-known rod-like shape, with a hump or swelling occupying the place where the fission finally takes place. After the separation of the daughter-chromosomes, a cell-wall is formed across the spore-mother-cell, and the two daughter-nuclei become enclosed in proper nuclear walls before entering on the final mitosis. The nucleolus also reappears within each of them. Owing to the very small size of the objects in question it was not found possible to trace certainly the earlier stages, but at the time when the aster condition is reached, the two dividing nuclei precisely resemble the original one in the spore-mother-cell. Thus it would seem probable that two heterotype divisions succeed each other here, instead of a difference obtaining between the first and second mitoses, as in Lilies.

After the completion of the process the spore-mother-cell is divided into the four special mother-cells, and the protoplasm within each one becomes surrounded with its own proper membrane. The spores are set free, as in other forms, by the disintegration of the original walls. It is very difficult to follow this in *Lophocolea*, but I have found either Bismarck Brown or Orange G. a good staining reagent for this purpose.

Frullania dilatata was also examined. It exhibited a very distinct quadripolar spindle, but the cell-contents are so exceedingly difficult to fix that I was unable to obtain any preparations of sufficient excellence to enable the entire process of karyokinesis being satisfactorily followed out. This is to be regretted, as the structure of the sporogonium in the Jubuleae section of liverworts is rather distinct from that of the others. But I saw nothing which would lead one to suppose that the process of spore-formation differs to any marked extent from that in the other Jungermanniac which I examined.

GENERAL CONCLUSIONS.

In endeavouring to obtain a general survey over the various processes which have just been detailed, one is struck at the outset by the difference existing between the behaviour exhibited by the cytoplasm in the *Jungermannia* and *M. chantia* series respectively. The (probably) constant appearance of four attraction-spheres in the four-lobed cells of the former, coupled with the absence of this peculiarity in the spherical or regular biscuit-shaped cells of the latter, hardly be devoid of significance, and it seems to me it may have some bearing on the nature and function of these much-discussed structures.

The facts may be briefly summarized as follows. In ordinary cells, whether of the archesporium, as in *Fossiliporia*, or in the gametophyte, as in *Fegatella* and in *Peperomia*, amongst the first signs of nuclear division is the well-marked appearance, at the two opposite poles, of a fan- or brush-series of radiations. These can often be traced to a minute dense particle situated on the outside of the nuclear envelope. Until the radiations become visible, there is nothing to distinguish the particular particle just mentioned from the many other granules of various sorts and sizes which coexist with it in the cell. As soon, however, as the radiation-systems are formed, they are seen in these cells to be definitely referred to certain focal spots, in the centre of each of which a 'centrosome' is usually to be discovered. But I did not always observe one body only, even during the early stages. Sometimes it was possible to speak of a *microcentrum* in Heidenhain's¹ sense of the term, for as many as three or four of these point-like granules might occur in the centre of each of the two systems of radiations. Just around the centrosome or centrosomes, a clear hyaline space can be discerned. I believe this to be due mainly to diffraction, but partly, perhaps also to the fact that a large number of hyaline radii

¹ Heidenhain, Neue Unters. über d. Centalkörper und ihre Beziehungen z. Zell- und Protoplasma. Arch. f. Mikr. Anat., Bd. XLIII.

converging to this point. The radii themselves often extend quite out to the periphery of the cell in the direction of the polar axis, whilst those on all sides of this axis exhibit the well-known system of curves produced by holding a horseshoe magnet below a paper covered with iron filings. Now it is not practicable in these cells with their granular contents to demonstrate the permanence of the centrosomes during those periods of inactivity when the radiations are absent. Thus I find that they become indistinguishable through a considerable part of the long interval which elapses whilst the nucleus remains in the aster stage, although they may often be quite plainly seen both before and after this period. Nor can they be recognized in the resting-cell. Even assuming them to be the permanent organs of the cell that Boveri¹ claims, they could scarcely be differentiated from the other granules scattered about in the protoplasm. Boveri and with him many other cytologists believe that they do actively direct and control the process of nuclear division, and these writers insist on their multiplication by fission alone—a necessary condition of the view of their morphological permanence. It may incidentally, however, be pointed out that their apparent formation *de novo*, which especially occurs during the maturation of the ova of certain animals, still demands a satisfactory explanation, regarded from this standpoint.

And when we turn to the spore-mother-cells in the *Jungermannia* series of *Hepaticae*, we are confronted with still other difficulties. Here we must assume that the centrosome either divides into four, simultaneously, or that the full number is reached as the result of a second bipartition, which might happen after the divarication of the first pair. And in either case it seems odd that the systems of radiations should defer their appearance until after the centrosomes have taken up their proper positions opposite each cell-lobe, seeing that the act of translation involves definite activity. This difficulty is also met with in a simpler form even in normal bipolar spindles,

¹ Boveri, Ueber das Verh. d. Centrosomen b. d. Befrucht. d. Seeigelcicis. Verhandl. d. Physik.-Med. Gesellsch. z. Würzburg, Bd. XXIX.

for in ordinary plants there seems to be nothing which corresponds to the early spindle of animal cells, which arises between the two diverging centrosomes. But, especially in these four-lobed cells, it is difficult to conceive the nature of the emanations from the centrosomes which in some way are supposed to effect their transportation to their several peculiar destinations. No signs of any operating forces are to be seen until the four systems of radiations suddenly start into existence in the places appointed to them by the configuration of the spore-mother-cell. And yet, if we assume with Boveri that the centrosome is 'Ein der entstehenden Zelle in der Anzahl zukommendes distinktes dauerndes Zellenorgan, das durch Zweitheilung sich vermehrend, die dynamischen Centriolen für die Entstehung der nächst zu bildenden Zellen liefert' we accept this descriptive definition, then it follows that we must also admit that the four daughter-centrosomes begin to initiate and direct their own transportation to their ultimate destinations in the cell.

For my own part, I find less difficulty in accepting the view that the centrosome merely acts as an 'Insertionsmittelpunkt,' a view which Heidenhain has so ably supported. It further appears to me to be most natural to explain the occurrence of these *normal* quadripolar spindles in the *Jungmannia* series as the result of the simultaneous activity of four independent cytoplasmic kinetic centres, which owe their existence to the peculiar conformation of the cell as a whole. There is evidence to show, in the early stages of even normal bipolar divisions, that the cytoplasm (kinetic centres) exerts a 'pull' on the nucleus. This is well seen, for example, in the nuclei of the germinating spore of *Pellia*. The spindle-shaped assumption by the nucleus, previous to the disappearance of the wall, indicates this; and in those animal cells in which a central spindle is first formed remote from the nucleus, the same effect is seen in the roping-up, as it were, of the chromosomes which thus become caught up and pulled on to the spindle.

And in the four-lobed cells of these Hepaticae, the pull

¹ Boveri, loc. cit., p. 60.

strain exerted on the nucleus takes place in four directions, each of which corresponds to the localization of a mass of protoplasm which is comparatively isolated from its neighbours by reason of the four pouch-like outgrowths of the spore-mother-cell. Furthermore the appearance of centrosomes in these cells, wherever they can be best made out, is not of such a character as to inspire confidence in their claims to individuality. They vary both in size and in number, even within the same cell, and this irregularity they share in common with animal centrosomes, as for example in the tissues investigated by F. Reinke and by Heidenhain. But if they mark mere nodal points, as it were are granules which have been pushed or drawn into a position of stable equilibrium in the centre of those forces of which the radiations may not unreasonably be regarded as the optical expression, there seem to be no grounds for expecting them to exhibit uniformity, either in size, number, or texture. In all of these respects we do, as a matter of fact, find differences and variations, both in animals and in plants.

Again, it is by no means obvious, on the assumption of their individuality, why the centrosomes in these four-lobed cells should take up positions, and start systems of radiations, which in most cases are soon abandoned. In *Fossombronia* and in *Aneura* in which plants I obtained the clearest cases of four equidistant centrospheres, these structures gradually approximate, and I believe (though I did not actually observe the process) that they finally coalesce in pairs to form the first karyokinetic spindle which, when mature, is *bipolar*, as in ordinary nuclear division. Those plants in which the poles of these spindles do not fuse to give rise to the bipolar condition, always disclose good reasons why this should not be the case, as for example in *Pallavicinia decipiens*¹, in which the lobing of the cell is carried to such a point that no room is left for a normal straight spindle to be formed.

Thus it would seem that in cases such as that of *Fossombronia*, the direction of the strains which are exerted on the

¹ Farmer, Studies in Hepaticae, Ann. of Bot. 1894.

nucleus is determined proximately at least by the cell-plasm; and that if circumstances admit of it, the ordinary *four* separate strains are replaced by *two*, which act in the same direction of the resultant. It may further be observed that a closer similarity exists between these quadripolar spindles and ordinary bipolar ones, than might at first sight appear to be the case. It is usual for a cell to divide transverse to its own long axis, and it is a significant fact that the nucleus is acted upon by a larger mass of protoplasm in this than in any other direction. It is known that the order of succession of walls in spherical cells may sometimes vary, and it will be that slight differences in the general symmetry of the whole cell determine ultimately the particular axis of the nuclear divisions; thus the geometrical considerations clearly enunciated by Sachs, harmonize also with the dynamics of cell-division as deduced from a study of the behaviour of the protoplasm during the process. The quadri-polar spindle then is only a special case of ordinary karyokinetic phenomena; instead of two relatively large masses of protoplasm, there are four distinct aggregations, one in every quadrant, each exercising an independent strain, and the direction of the strains may continue separate to the very end of the process, or not, according to the form and other special circumstances of the cell.

The existence of the centrosome is, for me, a secondary matter. I regard it as a mere insertion point, a granule, perhaps a condensation mass; and thus when it is present is immaterial whether its origin be nuclear or cytoplasmic. It is certain at all events that it may exist either with or without the nucleus. Thus in *Ascaris megalocephala*, *bivalens*, the centrosomes are extra-nuclear, whilst in the variety *univalens*¹, of the same species, the centrosome together with the whole achromatic spindle, arises within the nucleus. The same is true of the spermatogenetic centrosome of some birds, and from Fairchild's researches on *Valonia*

¹ Brauer, Die Spermatogenese von *Ascaris megalocephala*. Arch. f. Mikr. Bd. XLII.

would seem that in this plant, the centrosomes, if present, are also intra-nuclear. Their particular location depends on the arrangement and position of the systems of forces operating in the cell. I have already mentioned the fact that cases are known in animal cells, and particularly in those mitoses which accompany the maturation of the ovum, in which no centrosome presides over the process of karyokinesis by which the polar bodies are cut off. Brauer¹ has described such a case in *Artemia*, and when a centrosome is finally summoned into existence, it seems to arise as the result of a mere condensation of protoplasm.

So long as it was believed that the male and female centrosomes generally fused during fertilization, it was very natural (though not necessary) that considerable importance should be attached to these bodies, but we now know that as regards animals, this fusion does not take place, and that Fol's statements were based upon defective preparations. Sometimes the centrosome connected with the ovum², oftener that associated with the sperm nucleus³, alone persists, whilst the other one disintegrates and becomes lost, merged in the general cytoplasm. Another factor which enhanced the value of the centrosome depended on the discovery that during nuclear division these bodies also divide, and further that, in some cells at any rate, they persist through the interval which elapses between two successive mitoses. But in connexion with the latter point, it may be remarked that the divisions in these instances often succeed each other with such rapidity that the cell has not, in the interim, settled down to a state of rest. In other cases again, such as in certain cells described by Heidenhain⁴, it is not clear whether

¹ Zur Kenntniss d. parthenogenet. sich entw. Eies v. *Artemia salina*. Arch. f. Mikr. Anat., Bd. XLIII.

² Wheeler, The Behaviour of the Centrosomes in the fertilized egg of *Myxosoma glabrum*. Journ. of Morphology, Vol. x.

³ Julin, Structure et Développement des glandes sexuelles . . . chez *Stylopsis grossularis*. Bull. Sci. de la France et de la Belgique, T. XXV, p. 56 of the separate copy.

⁴ Ueber Kern u. Protoplasma. Festschr. für A. v. Kölliker, 1892.

the 'microcentrum' does not really represent stages of disintegration of the original centrosome. The researches of Moore on *Branchipus*¹ are of interest in this connection. During the earlier phases in the karyokinesis in the spermatocytes of this crustacean, granules of a fairly large size (the pseudosomes of Moore) are distributed throughout the cytoplasm. They are connected together by cytoplasmic filaments so as to form a sort of net-work, but are clearly separated as separate particles during the earlier period in the existence of the achromatic spindle. Finally, they fuse up to form a gigantic 'centrosome,' and the spindle becomes hence normally bipolar. It would seem as if these separate particles were at first sufficient to start a number of centres of division in the cell, but that these gradually drew together and finally after the pseudosomes had been forced to coalesce a single kinetic centre became a possibility at each pole of the cell. The same phenomenon of multipolar spindles has been observed by several investigators² in the early stages of nuclear division in Lilies and other plants, though they usually pass over into the normal bipolar type at a subsequent period. Still any large mass in the vicinity of the spindle may serve to disturb the uniformity of the figure, as I have elsewhere described in *Lilium Martagon*³. These considerations seem to confirm the suggestion that the quadripolar spindles of these Hepaticae are really only the result of the special conditions imposed by the configuration of the spore-mother cell.

As regards the change which takes place within the nucleus, the chromosomes and the nucleolus have long attracted the attention of observers. To the latter body indeed almost every conceivable function has been attributed. The reason for this is sought in the extraordinary difference in behaviour of the nucleoli of different nuclei exhibit during karyokinesis.

¹ Some points in the Origin of the Reproductive Elements in *Branchipus*. Quart. Journ. of Micr. Sci., Vol. xxxv.

² Belajeff, Zur Kenntniss d. Karyokinese b. d. Pflanzen. Flora, Ergänzungsb. z. Jahrg. 1894.

³ Ueber Kerntheilung in Lilium-Antheren, besonders in Bezug auf die Frage des Centrosomenfrage. Flora, 1895.

In the liverworts examined by me, the nucleolus was associated with the chromosomes in an unmistakable and remarkable manner. In other plants (e. g. Lilies), on the contrary, this relation may be merely subordinate in character, whilst large portions of the fragmented nucleolus are cast out into the cytoplasm. This occurs in *Lilium Martagon*, and according to Zimmermann¹ it holds good also for a large number of diverse plants. Zimmermann's observations have been challenged by Humphrey², but I can safely state that in the account which Zimmermann gives of the process in *Lilium Martagon* he is certainly correct, and that the appearances shown in his figures may be seen in almost any well-preserved material which has been appropriately stained. There is also evidence to show that the nucleolus may behave differently in different tissues of even the same plant. Thus Guignard³ found that in the archesporial cell-divisions of *Psilotum*, when the chromosomes have congregated in the equatorial plate, the nucleoli, which have diminished somewhat in size, are cast out into the surrounding cytoplasm. But in the spore-mother-cells of the same plant the nucleoli are almost entirely dissolved within the nucleus, and at most only a few relatively small particles are cast out and continue to be recognizable in the cytoplasm. This latter observation seems at first sight hardly to harmonize with the course pursued by the same body in *Lilium*, but it must be remembered that in the latter plant the nucleolus reaches an enormous size, and that it does, as a matter of fact, lose a good deal of its substance (as is proved by the extensive vacuolation) before its remains are extruded into the extra-nuclear protoplasm.

In a considerable number of cases, the decrease of nucleolar substance is contemporaneous with the growth of the chromosomes, and I cannot regard this coincidence as a merely accidental one. I have been led to this view, not only by the study of the earlier phases of karyokinesis, but also by a con-

¹ Zimmermann, Beitr. z. Morph. u. Physiol. d. Pflanzenselle, Bd. II, Heft 1.

² Nucleolen u. Centrosomen. Ber. d. deutsch. Bot. Gesellsch., 1894.

³ Guignard, Sur l'origine des sphères directrices. Journ. d. Bot., 1894.

sideration of the events which occur during the reconstruction of the daughter-nuclei. But I may at once say that I do not believe that the *entire* nucleolus is concerned in the process. For quite apart from the fact that the disappearance of the nucleolus does not, by any means, always coincide with the growth of the chromosomes, there are chemical considerations which render any such hypothesis untenable.

Zacharias¹ has clearly shown that the chemical constitution of the chromosomes, and certainly that of their chromatin component, is by no means identical with that of the nucleolus, for whereas the former contains nucleic acid in combination with other substances, this is wanting in the nucleolus which consists of plastin and albumen. But albumen also is a constituent of chromatin, according to the statements of Zacharias and also of Kossel², who regards chromatin as containing, besides nucleic acid, a variable quantity of albumen. Zacharias³ has also pointed out that the male nuclei which are so rich in nuclein, are usually destitute of a nucleolus, whilst the oosphere nucleus is poor in nuclein, but possesses a large nucleolus. The inference to be drawn from this observation seems to be, that the nucleolus, though not itself containing chromatin, is able to furnish at least one, and probably the albuminous constituent of this substance, so that when the chromatin diminishes, as happens during the stage of karyokinesis, it again decomposes, and that the albuminous matter contributes to the rehabilitation of the nucleus. This would perfectly agree with Kossel's observation that chromatin can be split up into albumen and other substances.

It seems hardly possible to explain the intimate relations which exist between the linin and the nucleolus, during the early and latest phases of mitosis in the liverworts, as a mere accidental circumstance. Not only their mutual positions, but also the relative differences in their staining capacity, all

¹ Zacharias, Ueber den Nucleolus. Bot. Zeit., 1885; also Ueber die Beschaffenheit v. Cytoplasma u. Zellkern. Ber. d. deutsch. Bot. Gesellsch.

² Kossel, Ueber die Nucleinsäure. Verhandl. d. Berl. Physiol. Gesellsch.

³ Zacharias, Ueber Beziehungen d. Zellwacht. z. Beschaffenheit d. Zellkern. Ber. d. deutsch. Bot. Gesellsch., 1894, p. 106.

to a transference of substance from one to the other, although this transference may take place in various degrees. Many other forms have been described and figured, especially by zoologists, which lend support to this view, and on the botanical side I may cite the observation of Strasburger on the embryo-sac of *Galanthus*¹, in which he describes and figures the fragmented nucleolus lying along the young chromosomes within the nucleus. I have myself repeated this observation on the snowdrop, and have obtained quite similar results.

But in attributing a nutritive function to the nucleolus I have left untouched the question as to what rôle (if any) is played by the other substances of which this enigmatical body is composed. Professor Strasburger has recently suggested² that the nucleolus is concerned in an important way in the formation of the intra-nuclear part of the achromatic spindle. This may well be the case, at any rate there can hardly be any doubt but that a considerable part of perhaps all normal spindles is differentiated from substances within the nucleus; and of course it must be so in those cases in which, as in *Ascaris megaloccephala*, var. *univalens*, the whole spindle is intra-nuclear. I confess, however, that I feel sceptical as to the possibility, or even the *d priori* necessity, of deriving it from any one constituent of the cell, which one could regard as set apart to provide a 'spindle-forming' substance. It seems to me to be somewhat difficult to regard the spindle as a growing, organized structure at all, in the morphological sense of the term. I venture to think that the facts hardly warrant us in saying more than that the spindle-fibres are the visible expression of strains (and perhaps stresses) within the protoplasm. This protoplasm consists of, or at least includes, an extremely heterogeneous assemblage of substances which vary amongst themselves very much in such physical characters as cohesion, viscosity, extensibility, elasticity, and the like. If the kinetic centres are really *active* existences, and there seems no reason to doubt this, then such 'lines of force' as

¹ Strasburger, *Die Controversen*, p. 23.

² Strasburger, *Karyokinetische Probleme*. Pringsh. Jahrb., Bd. XXVII, Heft 1.

are seen in any well-developed spindle are exactly what have been expected. Their resemblance to the line in a magnetic field has been repeatedly pointed out, and also one of those who believe that there is a real mechanical similarity underlying the appearances presented in both. I do not see any sufficient reason for postulating the existence of any special spindle-forming substance distinct from the general protoplasm of the cell. Just as the protoplasmic limiting surfaces of cells assumes the form of hyaloplasm, so often the free surfaces may be artificially or naturally renewed, so also the spindle-fibres can equally well be renewed, when the mechanical conditions of their existence arise. Given a homogeneous, extensible, cohesive frame, such for example as the researches of Bütschli have rendered probable for the structure of protoplasm, and it will be once apparent that such a structure, when exposed to tension, must inevitably react differently from the surrounding medium of granules and other heterogeneous and disunited contents of the protoplasm. And the same result will also follow if we admit the distinction between hyaloplasm and turbid, bedded particles which render its interior so turbid, without committing ourselves to any definite conception as to the architectural structure of the protoplasm. It is a characteristic feature in all well-developed spindles that the whole area lying between the two kinetic centres, and enclosing the spindle, becomes cleared of nearly all the turbid protoplasm, which is, however, abundant enough in the medium outside the spindle. And during the reconstitution of the daughter-nuclei, after their walls have become differentiated, the granular portions are first seen to spread into the area (whilst this persists as the connecting fibres) unimpaired. In the lee of the two daughter-nuclei, the equatorial regions remain for some time clear of these minute granules. It is urged that we have here to do merely with an additional rapid metabolism, due in the one case to the strain, and subsequently to the energy set free in the protoplasm, and in the other to the exigencies of the new cell-wall, and that

account for the clearance of the granules. But I think that any one who is familiar with the whole appearance presented by the spindle at the various stages of its existence in such a cell as, for example, the pollen mother-cell of a Lily, would admit that this will hardly supply a complete explanation of the appearances observed.

The general conclusion to which I have arrived is one which, so far as I understand him, is also held by Heidenhain, namely, that the achromatic spindle is the direct effect of stresses and strains acting in the cell from definite centres, that their arrangement obeys ordinary mechanical laws, and that those constituents of the cell, be they cytoplasmic or be they nuclear, which possess the physical consistency necessary for the purpose, may be requisitioned to take part in the formation of the spindle-fibres.

Finally, there remain the chromosomes themselves to be considered. A considerable amount of knowledge has been accumulated with respect to the structure and mode of origin of these bodies in plants, chiefly through the investigations of Strasburger and of Guignard. But it will have been already seen from the foregoing account that the earliest stages in the development of these bodies are not in all cases identical, nor do they conform to one type in the mode of their further evolution. This is especially true of the divisions in the spore-mother-cells, as contrasted with the mitoses which occur elsewhere in the same organism.

The features which seem to be distinctive of this spore-mother-cell division, at least in plants, are, first, the *early* period at which the longitudinal fission of the chromosome takes place, and, secondly, in the very peculiar and highly characteristic shape of the chromosomes when they reach their mature form on the spindle.

As regards the first of these two points, the liverworts, described above, do not quite agree with the process of chromosome-differentiation as seen in Lilies, in which most of the detailed observations in this process have been carried out. In these plants, and also, it would seem, in the Gymno-

sperms, the linin is discoverable at a very early stage as a much coiled thread, in which the chromatin particles are distributed. As the coil shortens and thickens, the chromatin is seen to be specially located in two lines along the edges of the filament, whilst the intervening clearer part of the filament marks the tract of the longitudinal fission. The chromosomes are thus made up of a linin basis, in which the chromatin particles imbedded, eventually become isolated by the 'thinning' and final disappearance of the linin at certain transverse planes, and in this way the length of each chromosome is determined. But in Hepaticae the process is complicated by the existence of anastomoses, and the chromosomes are by no means delimited in so orderly a fashion as in Lilies. The longitudinal fission is often recognized only with difficulty, so much so that at one time I doubted its occurrence.

The appearance of the chromatic areas in the Jungermannia is highly characteristic. The young chromosomes usually form more or less ring-like structures, the chromatin in which is frequently seen to be grouped in a manner which strongly suggests that a *double* distribution of the chromatin for the next *two* divisions occurs here (see Figs. 5, 6, 7, 8, 2). There is, so far as I know, no *à priori* objection which could be urged against this. Brauer showed that it happens in *A. hepatica* and Flemming showed that a longitudinal division of the daughter-chromosomes of the one mitosis in the spermatocytes of Salamander occurred before going into rest, while the number of chromosomes for the final mitosis was already prepared for.

Later on, this curious appearance in the rings is lost as the chromosomes contract and bend over on themselves, assuming the well-known humped appearance so characteristic of the corresponding mitosis in the pollen-mother-cells of Phanerogams. An explanation of the highly complex development which these chromosomes pass through before they finally divide on the spindle has been attempted elsewhere.

¹ Farmer and Moore, loc. cit.

so that I need do no more here than briefly recapitulate the important steps of the most normal type met with, bearing in mind, however, that variations on this may occur¹. The process, in outline, is as follows: The chromosomes in which the longitudinal fission has taken place, and which may be open or closed at both ends, doubles on itself. The two *sides* now begin to divaricate, beginning to do so at the place where the bending occurred. Thus the well-known T shape is produced, the vertical bar of the T representing the hump which is produced by the approximation of the two *ends* of the young chromosome, and which are directed outwardly from the surface of the spindle. Finally, the two halves separate along the spindle, and as a result of the bending already referred to, the daughter-chromosomes have from the first the shape of the letter V; each represents one of the original longitudinal halves of the mother-chromosome. Variations on this process may occur, but the essential feature, namely, the *longitudinal* splitting of the mother-chromosome, already referred to, the daughter-structures, is common to all.

The second mitosis in the spore-mother-cell of the liverworts investigated is, so far as the minuteness of the objects admitted of its being traced, similar to the first, though the earlier stages were, however, exceedingly difficult to follow on account of the small size of the nuclei. On the assumption of a double splitting occurring during the first mitosis, it is obvious that the chromosomes in both divisions might well exhibit that identity in form which, as a matter of fact, is actually displayed.

In this respect the second karyokinesis in the Hepatic spore-mother-cell *differs* from that one corresponding to it in Lilies. The dissimilarity between the two consecutive mitoses in the pollen-mother-cells of Lilies and some other plants is most striking, and has not escaped the notice of those who have investigated these plants. I think I am justified in asserting that in the second division of the pollen-mother-cell

¹ *Ibid.*

of the Lily a true homotype mitosis occurs, and that it in way resembles those mitoses in the vegetative cells of the plant, except in so far as the retention of the reduced number of chromosomes is concerned. I have observed the chromosomes lying in pairs, and arrayed on the spindle in a way as hardly to admit of a doubt as to their having been by a longitudinal fission, exactly like that in the chromosomes of the endosperm nuclei, for example.

But it would appear that not all Phanerogams exhibit this difference between the two mitoses which is so pronounced in the Lilies. Thus Strasburger¹ states that in *Orchis masculina* the chromosomes of the two successive mitoses in the primary mother-cells are quite similar in appearance. Here, therefore, it seems that, as in liverworts and in some animals², the two mitoses are both similar, and approximate to the heterotype form.

A study of these divisions affords not the slightest evidence in favour of any reduction-division (in Weisman's sense) taking place. The only point at which, so far as I can see, it is conceivably occur, is in the period of rest which intervenes between the last archesporial division and the first primary mother-cell mitosis, in which the reduced number of chromosomes is already complete. It might be suggested that the chromosomes of the last archesporial mitosis had come together laterally and in pairs, so that what has been here and by other writers described as a longitudinal fission in the chromosomes really represents the partial lateral fusion, or perhaps re-union of a pair of entire ones. The apparent division in this case would then really amount only to a sorting out of the two members of each pair, a process which would completely fulfil the requirements of the 'Reductionstheilung' if it were proved to take place. But the great similarity of the heterotype in plants with the first heterotype division

¹ Karyokinetische Probleme. Pringsh. Jahrb., Vol. xxviii, p. 192.

² Moore, On the Germinal Blastema and the nature of the so-called 'Reduction-division' in the Cartilaginous Fishes. Anat. Anz., Bd. IX; also, On the Metamorphosis of the reproductive elements in Elasmobranchs. Quart. Journ. of Micr. S.

animals is opposed to such hypothesis, for in animals no 'reduction' is claimed at this stage. Moreover it seems clear that whatever significance the heterotype form of mitosis may possess, it cannot be concerned with a qualitative reduction, since in animals¹, and at any rate in some plants, *two* heterotype divisions succeed each other, and there is no reason for supposing that the real process is so essentially different in the two cases as to effect a reduction in the one and not in the other.

Thus it would seem that the heterotype divisions in plants, different as they are from the normal homotype mitosis in the rest of the cells of the organism, afford no evidence in support of any assumption of a *qualitative* difference existing between the daughter-chromes in each pair. The only 'reduction' is a numerical one, and it would appear that this must be due to an end-to-end fusion in pairs which occurs in the resting nucleus, as was suggested by Strasburger²; that is if the chromosomes really retain their identity in the resting nuclei.

But it is difficult to feel certain even on this point. Certainly the chromatin as such does not remain unaltered. It undergoes chemical change during the last phases of karyokinesis, which results in the loss of staining power and a large portion at least of its substance. Prof. Strasburger has recently suggested that the chromatin wanders into the nucleus from the cytoplasm in a dissolved condition, and he explains the 'Sichel-stadium,' previously described by himself and other authors under different names, as a condensation of this substance at one end of the nucleus. It is driven here owing to the one-sided penetration and diffusion of the reagents used in fixing. It is, however, not very easy to see how such a quantity of dissolved chromatin could exist in the nucleus without colouring the nuclear sap in those cells in which the fixing has succeeded better. But however this may be, it hardly seems to me to be probable that the chromatin

¹ Moore, loc. cit.

² On the periodic reduction in the number of the Chromosomes. *Annals of Botany*, Vol. viii.

as a *whole* enters the nucleus in this manner. It may happen that the cytoplasm does furnish some constituent of that body which we call chromatin in the dividing nucleus, but in addition to this there exists another substance which forms the *essential* part of the chromatin, and it seems probable that this substance resides in the nucleus. The fact that nucleins are not found in the cytoplasm supports this suggestion. The sudden and large increase in bulk which chromatin exhibits during mitosis is perhaps referable to the recombination of the substances which contain phosphorus with the albumen, which probably originate from the nucleus, and perhaps partly also from the cytoplasm.

I have endeavoured in the above discussion to hint at some of the lines along which further investigation is much needed, and also to indicate the nature of some of the problems which await solution. I am conscious that in attempting to discuss on some of these questions I cannot hope to avoid the charge of vagueness. This is, however, unfortunately a defect inherent in the present condition of the subjects involved, and I think it best to put forward the difficulties with which I have myself confronted, in order that perhaps others might be tempted to overcome them. So little ground has been yet reclaimed, and of that little so much is still unsafe, that one can only with diffidence attempt to estimate the general bearings of any one set of observations, however true they may be for the particular objects investigated. Thus, but a short time ago, few would have believed that the achroplasmic spindle could be formed entirely within the nucleus, whereas we now recognize that the actual position which it occupies in the cell is of no importance from a general standpoint, in the same way many observations which to-day seem to possess little significance may prove of considerable importance to-morrow, as has already happened to the theory of the *general* fusion of the centrosomes during fertilization—

‘*Multa renascentur quae iam cecidere, cadentque
Quae nunc sunt in honore —.*’

I cannot do better than close this essay and these

tions with a passage from one of Boveri's papers: 'Ich meine deshalb, es sollte . . . nicht mehr jeder Autor, wenn er an einem bestimmten Object die eine Entstehungsart als sicher erweisen kann, nun denken, er habe damit alle anders lautenden Angaben für andere Objekte umgestossen und dürfe seinen Befund als allgemein gültig proklamieren.'

EXPLANATION OF FIGURES IN PLATES
XVI, XVII, AND XVIII.

Illustrating Prof. Farmer's paper on Spore-Formation in Hepaticae.

All the Figures were drawn, using Zeiss 2 mm. apochrom. Microsc. with various oculars, and are reduced.

Figs. 1-16. *Fossombronina Dumortieri*.

Fig. 1. Spore-mother-cell with nucleus in resting condition.

Fig. 2. Same a little more advanced, nucleus preparing for division, three centrospheres at the angles, where the quadripolar spindle-rays afterwards appear.

Fig. 3. The same still later, the lacin is forming aggregations, and the chromatin becomes prominent.

Fig. 4. The chromatin aggregations appear as flattened rings, well marked. The nucleolus still present, but vacuolated.

Figs. 5, 6. Variations which occur at the next stage, quadripolar spindle.

Figs. 7, 8. Slightly older cell. The nucleolus becomes much vacuolated. The chromosomes more marked.

Fig. 9. The first spindle.

Fig. 10. The divided chromosomes retreating, a rudimentary cell-plate shown.

Fig. 11. The second division. One nucleus is seen in pole-field, with its eight chromosomes. The dotted line indicates the position of the first division wall.

Fig. 12. The four daughter-nuclei, resulting from the last division. They are diagrammatically represented in one plane; in reality the pair with the cell-plate between them are alone in focus. The appearance of the division walls seems to be simultaneous, and not successive, in this particular cell.

Fig. 13. The spore-mother-cell after division. The protoplasm is very much vacuolated.

Fig. 14. A young cell of the sporogenous (archesporial) tissue preparing for division; the centrospheres well shown.

Fig. 15. Later stage of the same, with the chromosomes forming.

Fig. 16. A spindle from the same tissue, with sixteen chromosomes which have just divided (only seven are shown in the drawing). The astral radiations are hardly visible at this stage.

Figs. 17-35. *Pellia epiphylla*.

Figs. 17, 18. Spore-mother-cell with nuclei just preparing for division.

Fig. 19. Later stage nucleolus vacuolated, chromatin becoming more abundant, the nucleins drawn out into a four-armed spindle.

Figs. 20, 21, 22. Further stages in the development of the chromosomes. In Fig. 21 they appear distinctly as eight rings.

Fig. 23. The first spindle. There are eight chromosomes (four shown).

Fig. 24. Diaster stage seen obliquely.

Fig. 25. The second division. One nucleus only of the lower pair shown, it is seen in pole-field, and the fellow one is concealed. In the upper part, the other two daughter-nuclei are both seen in profile. The cell-walls have appeared dividing the spore-mother-cell into four chambers.

Figs. 26, 27. Other views of the process.

Fig. 28 *a*. The spores are formed, and are preparing to germinate.

Fig. 28 *b*. Slightly later stage, showing the marking on the proper wall of the spores, and the disappearance of the spore-mother-cell membrane.

Figs. 29, 30. Division of nuclei in cells of the stalk of the sporogonium, a typical homotype karyokinesis.

Figs. 31-35. Nuclear divisions in the gametophyte.

Fig. 31. Nucleus in early stage of karyokinesis.

Fig. 32. The same, showing a centrosphere at one pole.

Figs. 33, 34. Chromosomes in equatorial plate.

Fig. 35. Division of chromosomes.

Fig. 36. *Aneura multifida*; the division of the chromosomes in the first spore-mother-cell mitosis.

Figs. 37-39. *Cephalosia bicuspidata*.

Stages in nuclear division of spore-mother-cells.

Figs. 40-49. *Scapania undulata*.

Fig. 40. Spore-mother-cell with resting nucleus.

Fig. 41. Same preparing for division. The nucleolus has fragmented; the linin now forms a well-defined net-work.

Fig. 42. Nucleus drawn out in a quadripolar spindle. The chromosomes beginning to form.

Figs. 43, 44. Chromosomes form the equatorial plate.

Fig. 45. Polar view of nucleus in same stage as in 43. The nucleolus N still visible amongst the eight chromosomes.

Fig. 46. The division of the chromosomes.

Fig. 47. First mitosis, the cell-plate divides the entire spore-mother-cell.

Fig. 48. The second division of the spore-mother-cell.

Fig. 49. A slightly later stage than that represented in Fig. 46.

Figs. 50-53. *Lophocolea bidentata.*

Stages in the division of the spore-mother-cell.

Figs. 54, 55. *Lophocolea ciliolata.*

Fig. 55 shows the second division in the lower nucleus, and it is clearly of a heterotype character.

Figs. 56-58. *Plagiochasma.*

Fig. 56. Late stage in first division.

Fig. 57. The second division (the two lateral nuclei lie in deeper focus), diagrammatic.

Fig. 58. The manner of appearance of the cell-walls.

Figs. 59-75. *Fegatella conica.*

Fig. 59. Spore-mother-cell, with dense deeply-staining cytoplasm and nucleus with linin net-work.

Figs. 60, 61. Two views of the division of the daughter-nuclei.

Figs. 62-64. Different views of the spore-mother-cell after the division of the nucleus.

Fig. 65. Diagrammatic representation of the arrangement of the cell-walls (see Fig. 63).

Figs. 66-75. Germination of the spores.

Fig. 66. Nucleus with reticulum of linin, and two vacuolated nucleoli.

Fig. 67. The chromosomes have formed, two centrospheres are shown.

Fig. 68. Polar view at stage of the fission of the eight chromosomes.

Fig. 69. Profile view at a little later period.

Fig. 70. The same a little younger, the chromosomes just splitting.

Fig. 71. The daughter-chromosomes are retreating to the two poles.

Fig. 72. The daughter-nuclei forming. The cell-plate and spindle shown. Some of the spindle-fibres terminate in granular bodies.

Fig. 73. A later stage, the nuclear walls and nucleoli have appeared, the linin has lost its staining capacity.

Fig. 74. The first division of the spore completed, the daughter-nuclei are in a state of complete rest.

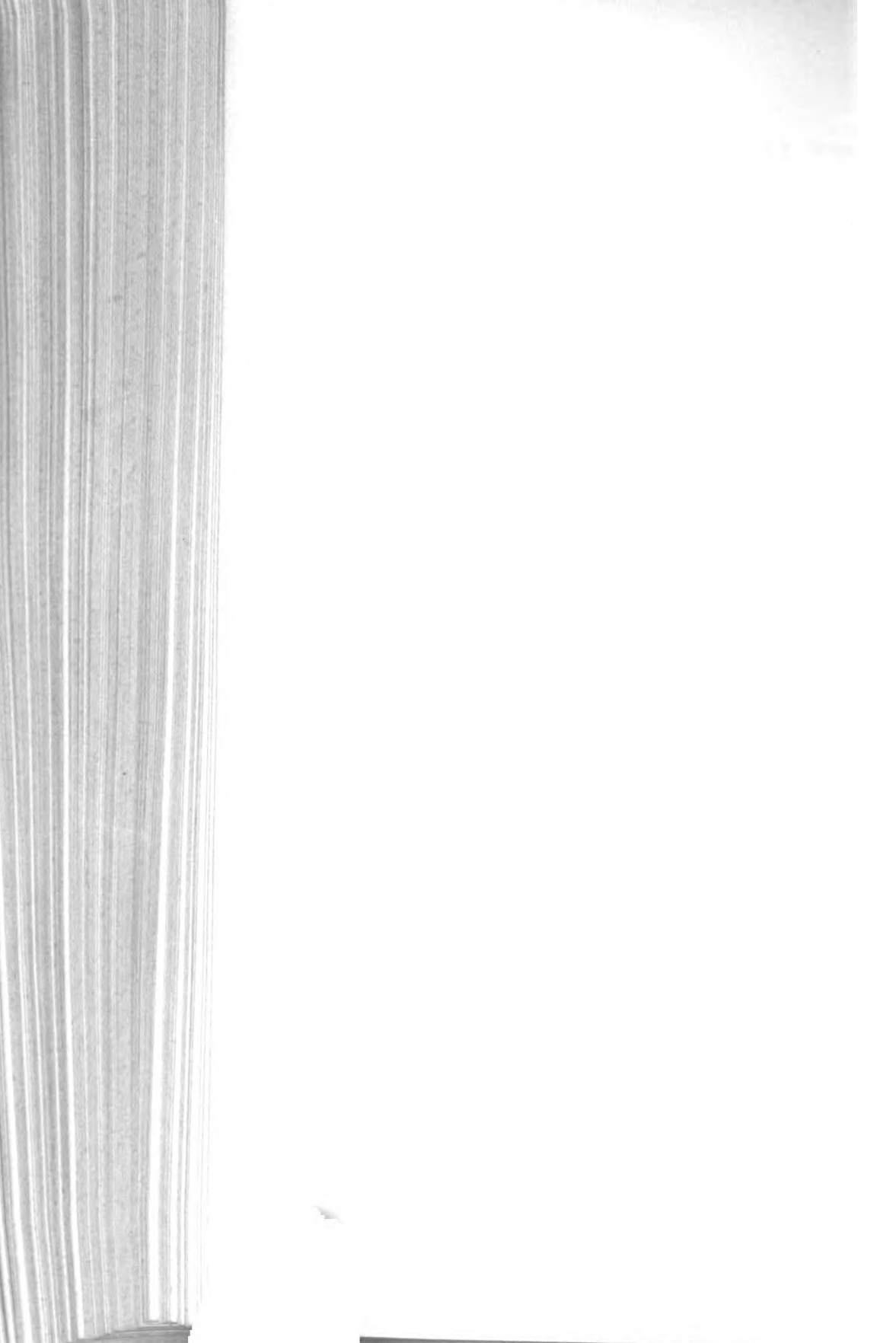

NOTE.

ON LYGINODENDRON AND HETERANGIUM. By the late W. C. WILLIAMSON, LL.D., F.R.S., Emeritus Professor of Botany in the Owens College, Manchester, and D. H. SCOTT, M.A., Ph.D., F.R.S., Honorary Keeper of the Jodrell Laboratory, Royal Gardens, Kew¹.

Introduction.

The two genera, *Lyginodendron* and *Heterangium*, are among the most interesting and at the same time the most puzzling representatives of the carboniferous flora. Although we are still without any satisfactory evidence as to the reproductive organs in either genus, yet the organization of their vegetative members is preserved with such completeness and perfection as to show that these fossils present a combination of characters such as exists in no living group of plants.

The evidence afforded by the vegetative characters clearly points to a position intermediate between ferns and Cycadeae.

I. LYGINODENDRON.

Lyginodendron oldhamium, Will.², is one of the commonest fossils preserved in the calcareous nodules of the Lancashire and Yorkshire coal-measures, and has also been found in those of Germany and Austria. A renewed investigation, with the aid of numerous additional specimens, has enabled us to clear up many doubtful points in

¹ Abstract of a paper read before the Royal Society on June 13, 1895, forming Part III of Further Observations on the Organization of the Fossil Plants of the Coal-measures.

² See Williamson, Organization of the Fossil Plants of the Coal-measures, Part IV, Phil. Trans., 1873; Part VI, Phil. Trans., 1874; Part VII, Phil. Trans., 1876; Part XIII, Phil. Trans., 1887; Part XVII, Phil. Trans., 1890.

the structure of the plant, and to give for the first account of all its vegetative organs.

A. *The Stem.*

1. *General Structure.*—The middle of the centre is occupied by a parenchymatous pith. Surrounding this is the primary wood, which usually forms a ring of from four to six strands. Beyond this we find, in all but the youngest stems, a broad zone of secondary wood, then the cambium and phloëm. The whole stele is bounded by a well-developed cortex. The inner cortex is mainly parenchymatous, while the outer consists of alternating strands of fibres and parenchyma, the well-known 'dictyoxylon cortex' of Count Sacc.

The pericycle and cortex are traversed by the perimedullary xylem-strands which alternate with the perimedullary xylem-strands.

2. *Course of the Vascular Bundles.*—We have observed that the perimedullary strands of xylem form the main part of the bundles which pass out into the leaves. The bundle-system of the stem is built up of the leaf-traces. Each trace extends through at least ten internodes; it is not traversed while it is passing through cortex and secondary wood, more after it has reached the periphery of the pith. In the pith the trace turns aside in the cathodic direction to the adjacent perimedullary strand on that side. Thus these strands are sympodial bundles, made up of the portions of adjacent leaf-traces.

In the upper part of its course, each leaf-trace forms a bundle, which unite into one in passing through the cortex.

The phyllotaxis was usually two-fifths, but in the youngest stems was probably one-third.

3. *Structure of the Vascular Bundles.*—The present structure that we have been able to determine with certainty in the stem were normally *collateral*, having xylem and phloëm on their outer side. As they passed through the secondary wood their structure became *concentric*, the phloëm surrounding the xylem.

The xylem of the bundles in the stem of *L. cycadea* resembles that in the leaves of existing Cycadeads. The pith lies in the interior of the primary wood, but near the

that the greater part of the primary wood was centripetally developed, while a smaller portion was centrifugal. We propose to term such bundles *mesoxylic* or *mesarch*¹. All statements as to the position of the protoxylem are based on longitudinal as well as on transverse sections.

4. *The Secondary Tissues*.—A few young stems have been observed with little or no secondary thickening; in most specimens it has made considerable progress. A large amount of secondary wood and bast, both fascicular and interfascicular, was formed, by means of a normal cambial layer, which is often well preserved.

The tracheides of the wood have numerous bordered pits on their radial surfaces. Similar elements occur in the primary wood also. The rows of tracheides are separated by numerous medullary rays.

The phloëm is often well preserved, so that primary and secondary phloëm can be distinguished.

The secondary tissues bear a general resemblance to those in the stems of Cycadeae.

5. *Pith and Pericycle*.—Both these tissues contained nests of dark-coloured elements, probably of a sclerotic nature. They are also traversed by numerous rows of cells with carbonaceous contents, which may have been secretory sacs, but not intercellular canals. At the outer border of the pericycle a characteristic internal *periderm* was developed.

6. *The Cortex*.—The parenchymatous portions of the outer cortex became much dilated in the older stems, in consequence of the secondary growth.

7. *On Small Stems of the Lyginodendron Type*.—Certain very small stems have been described, differing in structure from the usual form. In some of these the primary xylem forms a continuous ring, instead of being divided into distinct bundles. We now suggest that these specimens may represent the *basal*, first-developed region, of normal stems. In *Osmunda*, which in many respects resembles *Lyginodendron*, it has been shown by M. Leclerc du Sablon, that the embryonic stem has the same peculiarity.

8. *Structural Anomalies*.—Some of the specimens show remarkable individual anomalies, the most frequent and conspicuous of which

¹ One of the authors has recently found that this peculiarity sometimes extends to stem-structures in Cycadeae; in the peduncles of both male and female flowers of *Stangeria* the bundles are often mesoxylic.

consists in the appearance of a cambium at the periphery of the stem, forming medullary wood and bast, with inverted orientation. This is precisely the anomaly shown by certain species of *Ternstroemia* and other dicotyledons. The anomalous medullary cambium is continuous with the normal cambium through the leaf-trace gaps. This case is a striking instance of the independent appearance of this structural peculiarity in families as remote as possible from each other.

B. *The Leaf.*

1. *Connexion between Leaf and Stem.*—New and conclusive evidence has been found, confirming the conclusion previously arrived at (Mem. XVII), that '*Rachiopteris aspera*' is the petiole of *Lyginodendron*. In several specimens petioles with the characteristic structure of that fossil are found inserted on the stems of *Lyginodendron*. The vascular bundles on leaving the pericycle of the stem pass rapidly into the base of the leaf, becoming concentric at the leaf tip. Petioles, continuous with the *Lyginodendron* stem, may be traced up to the point where they begin to ramify.

2. *Form of the Leaf.*—The petioles, which we now know to be continuous with the stem, branch repeatedly, and ultimately give rise to palmately-segmented leaflets. The leaf was thus a highly compound one, and we can confirm the statement previously made that the character of the foliage was that of Brongniart's fossil *Sphenopteris*.

3. *Structure of the Petiole.*—The most important point here is that throughout the petiole and rachis, the vascular bundles, whether one or two are present, are of typical concentric structure in a fern.

The cortex of the petiole has essentially the same structure as that of the stem.

4. *Structure of the Lamina.*—We have examined sections of the lamina (found in connexion with petioles of *Lyginodendron*), in which the structure is perfectly preserved. The lamina had a distinct structure, with well-differentiated palisade, and spongy parenchyma. Stomata have only been observed on the lower surface. The vascular bundles in the lamina appear to have been collateral, as is the case in recent ferns.

5. *On a Peculiar Bud-like Structure.*—This is a unique

consisting of an axis, of obscure structure, bearing numerous appendages which exactly resemble the well-known cortical outgrowths of the stem and petiole of *Lyginodendron*. At first sight, the specimen bears some resemblance to a cone, but it was more probably a bud or young leaf, from which the inner delicate tissues have perished, leaving the protective outer coat, bearing the appendages, which may represent the bases of paleae.

C. The Root.

1. *Connexion between Root and Stem.*—We have already briefly recorded our discovery that '*Kaloxylon Hookeri*' is the root of *Lyginodendron*¹. We have found that certain appendages of the stem of *Lyginodendron*, most of which were formerly described as 'branches,' are in reality of endogenous origin, as is shown by the fact that the appendage, in passing through the cortex of the parent stem, is surrounded by a well-defined cortex of its own. These appendages are further shown to be roots, by the structure of their central cylinder and their mode of branching. Sections of the free part of the same organs, which are in connexion with stems of *Lyginodendron*, show that they agree in all respects with '*Kaloxylon Hookeri*,' namely, in the structure and arrangement of both primary and secondary wood, and in the details of the cortex, which is well characterized by its double or treble external or epidermal layer.

We find then that the stem of *Lyginodendron* bore numerous adventitious roots, of endogenous origin, and that these roots are identical with the fossils previously described under the name of '*Kaloxylon Hookeri*.'

2. *Primary Structure of the Root.*—All the specimens of '*Kaloxylon Hookeri*' have been re-examined, and are found to present a perfectly typical root-structure. The stele varies from triarch to octarch structure in different specimens. The protoxylem is external, showing centripetal development of the primary wood. In favourable specimens the regular alternation of the phloem-groups with those of xylem is quite clear. The stele has no pith, but there is a considerable amount of conjunctive parenchyma. Both pericycle and endodermis are present. The inner cortex contains abundant 'secretory sacs.'

¹ Roy. Soc. Proc., Vol. lvi. 1894.

The young roots much resemble the smaller adventitious roots of Marattiaceae.

3. *Secondary Tissues of the Root.*—These are beautifully preserved, and are found at all stages of development. The cambium is often specially clear. Secondary growth began opposite the phloëm-groups, and the secondary wood is generally interrupted by large rays opposite the protoxylem-strands. The secondary tissues resemble those of the stem. The whole process of secondary growth was perfectly normal, as in dicotyledons at the present day.

4. *Branching of the Root.*—The numerous specimens showing branching prove that the rootlets were endogenous, and that they arose opposite the protoxylem-groups of the main root.

D. *Habit and Dimensions of the Plant.*

In none of our authentic specimens is the stem more than 4 cm. in thickness. Certain cortical impressions, belonging to much larger stems, have been referred to *Lyginodendron*, but on inconclusive grounds.

There is one large specimen showing structure, in which only the secondary wood and portions of the pith are preserved. So much of the structure as remains agrees closely with that of *Lyginodendron*. This specimen may have reached a diameter of 30 cm. or 40 cm., and establishes a certain probability that *L. Oldhamium*, or some allied species, may have attained the dimensions of a small tree.

The ordinary specimens must have had upright stems of considerable height, bearing spirally-arranged, compound, fern-like leaves, separated by internodes about an inch long. The lower parts of the stem gave off on all sides numerous adventitious roots.

The entire absence of fructification is remarkable, considering the great frequency and admirable preservation of our fossil. It may be explained, either on the hypothesis that the leaves bore very caducous, fern-like sporangia, or by supposing that our material consists entirely of immature specimens.

II. HETERANGIUM.

Introduction.

The genus *Heterangium* differs conspicuously from *Lyginodendron*, in the structure of the stele of the stem, which in *Heterangium* contains no pith, but has a solid axis of primary wood. In most other respects the two genera much resemble each other.

i. *Heterangium Gricvii*, Will.¹

The original specimens of this species were derived from the Burntisland deposits. At a later date, specimens were found in the coal-measures of Dulesgate, Lancashire, which have been referred to the same species, though they show some slight differences from the original form.

A. *The Stem.*

1. *General Structure.*—The whole interior of the stele is occupied by the primary wood, consisting of tracheides intermixed with conjunctive parenchyma. In most specimens a certain amount of secondary wood has been formed around the central mass. Outside the wood a zone of phloëm can be traced, and this again is surrounded by a parenchymatous belt, which we regard as pericycle. The inner cortex is characterized by the presence of horizontal plates of sclerotic tissue. The outer cortical zone has a structure similar to that of *Lyginodendron*. In the pericycle and cortex numerous leaf-trace bundles are met with.

2. *Course of the Vascular Bundles.*—The bundles can be traced from the stele into the bases of the leaves. Their arrangement indicates that the phyllotaxis was three-eighths in the larger and two-fifths in the smaller stems. Each leaf received a single bundle. The leaf-trace bundles can be followed downwards for some distance at the periphery of the stele, where they form distinct strands, though united with the axial wood.

3. *Primary Structure of the Stele and Leaf-trace Bundles.*—The strands at the periphery of the stele, as well as the leaf-trace bundles with which they are continuous, have the same collateral and meso-

¹ Williamson, British Association Reports, 1871; Organization, Part IV, 1872; Part XVII, 1890.

xylic structure as the bundles in the stem of *Lyginodendron*, or the foliar bundles of Cycadeae. The essential difference from *Lyginodendron* consists in the fact that in *Heterangium* these bundles are united by the axial xylem, which extends throughout the whole interior of the stele. The primary tracheides, with the exception of those adjoining the protoxylem, have numerous bordered pits.

4. *The Secondary Tissues.*—The secondary wood, when present, has essentially the same structure as in *Lyginodendron*. Cambium and phloem, in the normal position, are fairly preserved in some of the specimens.

5. *The Cortex.*—The most characteristic feature here consists in the horizontal plates of sclerotic cells in the inner cortex. Their structure is precisely that of the 'stone-cells,' found in the cortical tissues of many recent plants. Their presence in the cortex of the stem is a point of difference from *Lyginodendron*, where the sclerotic masses are usually limited to the pith and pericycle.

6. *Branching of the Stem.*—In one specimen a young stem bears a branch much smaller than itself. This is the only distinct case of branching observed in either genus. All other supposed branches have turned out to be either petioles or adventitious roots.

B. *The Leaf.*

1. *Connexion between Leaf and Stem.*—The bases of petioles, in connexion with the stem, have been observed both in transverse and longitudinal section. These specimens show that the cortical tissues of the petiole have the same characteristic structure as those of the stem; we are thus enabled to recognize the petioles of *Heterangium Grievii* when detached from the stem. Unlike *Lyginodendron*, the petiole of *H. Grievii* usually receives from the stem a single bundle only.

2. *Form and Structure of the Leaf.*—We find innumerable portions of petioles, varying from 4 mm. to 0.4 mm. in diameter, sometimes branching, and intermixed with fragments of leaflets. We can only infer that the leaf of *H. Grievii* was a highly compound one, probably not very different from that of *Lyginodendron*.

The petiole is traversed by a single bundle of *concentric* structure. Thus the bundles underwent the same change on entering the leaf as in *Lyginodendron*.

The petioles bear a considerable resemblance to those of the latter plant, from which they chiefly differ in the absence of cortical out-growths.

C. *The Root.*

1. *Connexion between Root and Stem.*—In several cases endogenous appendages, evidently adventitious roots, have been found arising from the stems of *H. Grievii*. In one specimen the bases of three such roots are seen in a vertical row, and the connexion of their tissues with those of the stem can be exactly traced.

a. *Structure of the Root.*—We have good evidence, though not so direct as in the case of *Lyginodendron*, that the roots of *H. Grievii* also belonged to the '*Kaloxylon*' type. A special form of root, with a large tetrarch stele of characteristic shape, seems to be peculiar to *Heterangium*.

D. *Habit and Dimensions of the Plant.*

In habit, *Heterangium Grievii* must have been similar to *Lyginodendron*, but its dimensions were considerably smaller. Sporangia, like those of ferns, have occasionally been found in close association with the foliage, but not in connexion with it.

ii. *Heterangium tiliacoides*, Will.

This species differs from *H. Grievii* in several points, but evidently belongs to the same genus. The specimens are from the coal-measures of Halifax¹, and are remarkable for the astonishing perfection with which the histological structure is preserved. The general anatomy was fully described in 1887. In primary structure the stele agrees with that of *H. Grievii*, but the peripheral bundles are more distinct. The secondary tissues are subdivided by broad primary rays (enormously dilated in the phloëm), which correspond to the conjunctive tissue separating the primary bundles. Cambium and phloëm are perfectly preserved; the latter is of great thickness, almost equal to that of the secondary wood. So perfect is the preservation, that stages in the development of the tracheides from the cambium have been observed, while the compound sieve-plates on the radial walls of the sieve-tubes are quite clear. Sclerotic groups

¹ Williamson, *Organization*, Part XIII, 1887.

occur in the pericycle, as well as in the cortex, and the leaf-trace bundles are in pairs—two points in which this species resembles *Lyginodendron* and differs from *H. Grievii*. Thus the close relationship of the two genera, in spite of the different arrangement of the primary wood, comes out even more clearly in this species than in *H. Grievii*.

We have a single specimen of a *Heterangium*, which differs in some respects from the two species above described, and may turn out to represent a third type.

III. *Affinities of Lyginodendron and Heterangium.*

The vegetative organs of these genera show a remarkable combination of fern-like and cycadean characters. The leaves of *Lyginodendron*, which are now well known, are so like fern-leaves, not only in form and venation but in minute structure, that if they stood alone they would, without hesitation, be referred to Filices. Although many leaves simulate those of ferns in external characters (*Stangeria*, *Thalictrum*, &c.), none are known which at the same time show the characteristic anatomy of fern-leaves. Hence we are led to attach great weight to the characters of the *Lyginodendron* foliage. That of *Heterangium*, though less well preserved, was evidently of the same type.

In *Heterangium* the primary structure of the stem is much like that of a monostelic fern such as *Gleichenia*, but the leaf-trace bundles closely resemble the foliar bundles of a Cycad.

In *Lyginodendron* the whole structure of the stem suggests a Cycad, but with the remarkable peculiarity that the bundles here have the structure which in Cycadeae is usually (though not always) limited to those of the leaf. The cycadean characters are too marked to be accidental, though the general anatomy of *Lyginodendron* is not inconsistent with a close relationship to ferns, for in *Osmunda* we have a monostelic fern, with a large pith, collateral bundles in the stem, and concentric ones in the leaf¹. The mere occurrence of secondary growth in a fern-like plant is not surprising, considering that it takes place in *Botrychium* and *Helminthostachys* at the present day.

¹ See Zennetti, *Botanische Zeitung*, 1895.

In various respects *Lyginodendron* and *Heterangium* have points in common with Gleicheniaceae, Osmundaceae, Marattiaceae, Ophioglossaceae, and Cycadeae. The view of their affinities, which we suggest, is that they are derivatives of an ancient generalized race of ferns, from which they have already diverged considerably in the cycadean direction. Of the two genera, *Heterangium* appears to be geologically the more ancient, and certainly stands nearer to the filicinean stock. *Lyginodendron*, while retaining conspicuous fern-like characters, has advanced much further on cycadean lines. This view by no means involves the improbable assumption that these plants were the actual ancestors of existing Cycadeae. How far their divergence from the fern stock had proceeded cannot be determined until we are acquainted with their organs of reproduction.

The existence of a fossil group on the border land of ferns and Cycads seems now to be well established. Count Solms-Laubach places his *Protopylis* in this position, which is probably shared by *Myeloxylon* and *Poroxyton*. Messrs. Bertrand and Renault have indeed endeavoured to derive the last-named genus from Lycopodiaceae, and have extended the same view to *Lyginodendron* and *Heterangium*. In the latter cases their theory is completely negated by the organization of the leaves, and by many structural details.

The relation of the genera which we have described to those ancient gymnosperms, the *Cordaiteae*, will form one of the most interesting palaeobotanical problems of the future.

The paper is illustrated by micro-photographs and by camera-lucida drawings.

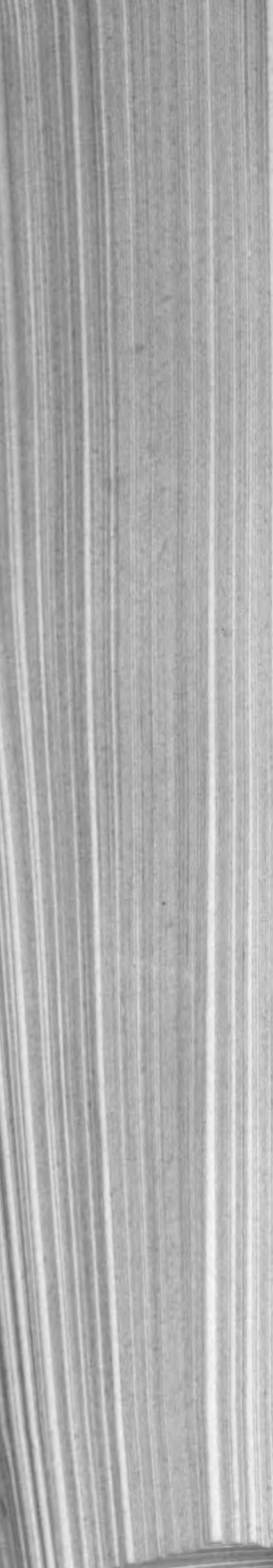

Faint, illegible text is visible on the right side of the page, appearing as a list or series of entries. The text is too light to transcribe accurately but seems to follow a structured format, possibly a table of contents or a list of items.

Polyembryony in *Erythronium americanum*.

BY

EDWARD C. JEFFREY, B.A.,

Lecturer in Biology, University of Toronto.

—♦—
With Plate XIX.
—♦—

DURING the Spring of 1894 I collected a large amount of material of the ovules and seeds of *Erythronium americanum* in various stages of development with the intention of studying the process of fertilization and development of the embryo. When some of the seeds, which had reached their full size, but had not yet become filled with the characteristic horny endosperm of the Liliaceae, were cut into series by means of the turpentine-paraffine method, they were seen to present the phenomenon of polyembryony. A detailed examination of serial sections of the embryos in all stages of development resulted in the conclusion that the polyembryony here differed from any which has yet been described. Publication has been delayed till this year in the hope of adding other examples of polyembryony in native Canadian Liliaceae, a hope which has not however been realized.

It is hardly necessary to refer to the well-known work
[*Annals of Botany*, Vol. IX. No. XXXVI. December, 1896.]

of Strasburger on polyembryony in *Funkia*, *Euonymus*, *Citrus*, &c.¹

In these forms the multiplicity of embryos is due to the adventitious buds derived from the integuments which pass into the cavity of the embryo-sac after fertilization. Guignard has described in *Mimosa Denhartii* embryos arising from the fertilization of one or both of the integuments in addition to that of the normal egg-cell².

He has not explained however how the nuclei of the pollen-tube are able to fertilize the three cells which give rise to the embryos. He has also described polyembryony in *Schrankia uncinata*, but his material was unable to discover its mode of origin.

More recently Dodel and Overton have described polyembryony in *Iris sibirica*, which they refer to as fertilization³.

In February of this year (1895) Tretjakoff has given an account of polyembryony in *Allium odorum*, in which the formation of embryos from the antipodals is described.

It will be seen from the above that there are two kinds of the supernumerary embryos being considered, one termed *extrasaccal* (*Funkia*, *Nothoscordum*, &c.) and the other *saccal* (*Mimosa*, *Iris*, and *Allium odorum*). The embryos of *Erythronium* are intrasaccal, but differ from those described in *all* taking their origin from the fertilized egg-cell.

The youngest ovules of *Erythronium americanum* in the early spring show the embryo in the cleave state. The two nuclei divide in the cleave state to rise to four and then to eight nuclei. The micropylar and antipodal ends of the embryo-sac are markedly different in size, but sometimes the

¹ Ueber Befruchtung und Zelltheilung, Jen. Ztsch. Bd. XI. Jen. Ztsch. Bd. XII.

² Annales des Sci. Nat., Sér. 6, tome XII.

³ Dodel, Beitr. z. Erkenntn. der Befruchtungerssch. bei *Iris sibirica*.

⁴ Ber. d. Deutsch. Bot. Gesells., Feb. 1895.

sometimes the antipodal ones are the larger. The differences are specially noticeable in the quadrinucleate condition of the embryo-sac. The number of chromosomes could not be made out, as the nuclei were not seen in the process of division. The final condition of the embryo-sac is similar to that which has been shown to obtain generally. The embryo-sac, at the time of fertilization, is imbedded in a richly protoplasmic nucellus. There is a considerable amount of tissue in the chalazal region of the nucellus, but at the apex there is only a single layer of cells over the embryo-sac. The cells of the nucellus are strikingly marked off from those of the integument by their richness in protoplasm and by their avidity for stains.

The pollen-tube penetrates the ovule in the usual manner and the egg becomes fertilized, the stages in the union of the male and female nuclei being made out with special facility on account of the large size of the elements. No attempt was made to demonstrate the existence of centrosomes and astrospheres¹.

Fig. 1 shows the essential parts of a just fertilized ovule. Two nuclei are seen in process of fusion in the egg. The synergids have disappeared entirely, as is usually the case in *Erythronium*. The egg-cell subsequently divides into two generally, but not invariably, by a division at right angles to the axis of the embryo-sac. The first division is followed by others which have no fixed order or plane.

In Fig. 2 a division is represented taking place in the upper cell of the two-celled embryogenic mass. The single layer of nucellar tissue over the apex of the embryo-sac is seen to be densely filled with protoplasm. Strasburger found the same peculiarity in *Funkia*, in which plant it is these 'inhaltsreiche Zellen' which give rise to the multiple embryos. In *Erythronium*, however, as before stated, *all* the tissue of the nucellus is rich in protoplasm. The same is true of *Lilium canadense* and species of *Trillium*, so the phenomenon is probably of general occurrence.

¹ Strasburger, Hist. Beiträge, IV.

Fig. 3 shows an embryogenic mass in a later stage of development. In Fig. 4 the embryogenic mass appears still further increased in size; whilst in Fig. 5 the mass is seen not only increased in size, but beginning to send forth outgrowths from the free end, the future embryos. The single layer of nucellar cells over the apex of the embryo-sac still persists, but their dense protoplasm is for the first time vacuolated. At no time do the cells of this layer show any signs of division. In Fig. 6 four embryos are seen at the free end of the embryogenic mass. The preparation here represented shows an unusually large number of embryos. Generally there are but two or three of them to be made out. The single investing layer of nucellar tissue has disappeared by absorption. As is the case in *Mimosa Denhartii*, only one embryo persists in the ripened seed¹. This is buried in the endosperm resting on the broad base furnished by the persistent embryogenic mass, or, as it may be better termed at this stage, the suspensor. The large size of the latter in the case of *Erythronium* suggests the possibility that the equally enlarged suspensor of the *Vicææ*² may be a relic of polyembryony. No investigation, however, has been made as yet in this direction.

The fact that the single layer of densely protoplasmic nucellar tissue over the apex of the embryo-sac in *Erythronium* does not give rise to the multiple embryos, suggested a reinvestigation of *Funkia* in the expectation that the employment of the improved technique now in vogue might give similar results in that form. Detailed examination of *Funkia* showed, however, that Strasburger's description of the origin of the embryo was in all respects exact.

Guignard himself suggests the possibility of doubt as to the multiplicity of embryos in *Mimosa Denhartii* being due to the fertilization of the synergids, and offers the alternative that they may have come from the segmentation of the egg-cell. The latter supposition seems to gain force from the difficulty of conceiving that the *three* cells which give rise to

¹ Guignard, op. cit.

² Vide Guignard, op. cit.

embryos¹ should be fertilized by the *two* generative nuclei of the pollen-tube. The conditions in *Erythronium* also lend strength to this opinion. From lack of material I have not been able to reinvestigate the facts in *Mimosa*.

Iris versicolor was examined in the hope of finding polyembryony, but it was found to possess normal embryos. As *Iris sibirica* was not available, it was not possible to compare it with *Erythronium*.

The polyembryony of *Erythronium americanum* is also of interest, in that it is exactly homologous with the polyembryony which is so commonly found among the Gymnosperma. The resemblance extends even to the ultimate persistence of only one of the multiple embryos.

¹ Op. cit., Plate I, Fig. 31.

EXPLANATION OF FIGURES IN PLATE XIX.

Illustrating Mr. Jeffrey's paper on Polyembryony in *Erythronium*.

Fig. 1. Embryo-sac just after fertilization has taken place. In the oospore the male and female nuclei are seen in process of union. The synergids have disappeared. $\times 180$.

Fig. 2. A later stage. The embryonic mass consists of two cells, in the upper of which a mitosis is just taking place. $\times 250$.

Fig. 3. The embryogenic mass has increased in size. $\times 250$.

Fig. 4. The embryogenic mass has grown still larger. $\times 250$.

Fig. 5. The still more enlarged embryogenic mass is beginning to give rise to embryos. $\times 250$.

Fig. 6. Four embryos are seen projecting from the embryogenic mass. $\times 180$.

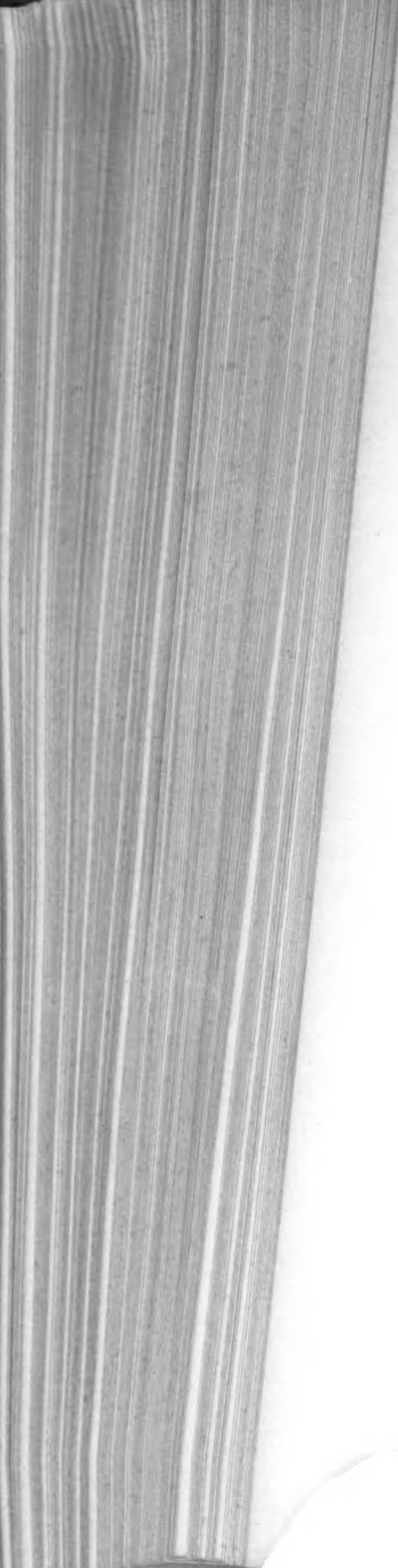

The text on this page is extremely faint and illegible. It appears to be a list or a series of entries, possibly a table of contents or an index, but the individual words and numbers cannot be discerned. The text is arranged in several columns, with some lines appearing to be indented. The overall appearance is that of a very old or faded document.

The Proteids of Wheat (II).

BY

M. O'BRIEN, D.Sc.

A GRAIN of wheat, as is well known, consists of the embryo and the endosperm, together with various integuments derived both from the coats of the ovule and the wall of the ovary. In the modern process of milling, the embryo—or 'germ,' as it is technically termed—is removed before the grain is ground, so that the flour is derived entirely from the endosperm.

Since the results stated in my previous paper¹ on this subject refer exclusively to the proteids of flour, I have endeavoured, on the suggestion of Professor Vines, to complete my investigation of the proteid-chemistry of wheat by a study of the proteids of the 'germ.' The necessary material, consisting of isolated embryos, can be readily obtained in quantity from the millers.

The Proteids of the Germ.

The embryo of wheat is richly stored with typical aleuron-grains, its proteids thus assuming the form most characteristic of nitrogenous reserves in seeds; in this respect it contrasts with the endosperm in which the proteids are stored chiefly as gluten, though they also occur in the form of the somewhat abnormal grains in the aleuron-layer described in my previous

¹ *Annals of Botany*, Vol. ix. p. 171.

[*Annals of Botany*, Vol. IX. No. XXXVI. December, 1895.]

paper. No starch is present in the embryo, but there is to be a small amount of sugar, and much oil.

The aleuron-grains occur in almost all the cells of the embryo, including the scutellum: they are, however, absent from the epithelium of the latter, and are often imperfectly formed in the epidermal cells of the radicle and of the coleorhiza, being destitute of globoids; in the reserve-cells of the scutellum they are smaller than those of the aleuron-layer. The grains have usually one distinct globoid, occasionally two or more; around the globoid is a ring of proteid, the outer layer of which is somewhat less soluble than the rest. This proteid ring stains deeply with iodine, fuchsin, Hoffmann's blue, and other aniline dyes: it rapidly dissolves in dilute potash, less rapidly in a ten per cent. solution of sodium chloride, and is only partially soluble in water. The globoid dissolves instantly in picric acid, but is not attacked by dilute potash, salt solution, or water; it thus differs markedly from the substance which forms the core of the grains in the aleuron-layer of the endosperm.

The separation of the various proteids was performed on extracts made from quantities of 'germ,' as the material is to be conveniently termed.

Treated with water, germ yields a slightly alkaline extract holding proteids in solution and much oil in suspension, which filters with difficulty. On slowly heating the extract, three coagula were obtained at three distinct temperatures, namely, at about 55°C ., 75°C ., and above 80°C .. Since, after coagulation is complete, the liquid still gives the xanthoproteic and Millon's reactions, the presence of a proteose is indicated; the amount of it is but small, and it may be a secondary product.

On saturation with sodium chloride, the watery extract gives a dense precipitate of a proteid which is presumed to be *myosin*. Since this proteid very rapidly coagulated on standing, it was impossible to collect and re-dissolve it in order to determine its exact coagulating-point. Probably the point is about 55°C ., because the substances remaining in solution

in the watery extract after saturation with sodium chloride, gave no coagulum below 75° C., but coagulated (as in the original watery extract) at about 75° C., and later between 80° and 90° C.

The proteids remaining in solution after saturation with sodium chloride were next examined. The liquid was dialysed for about ten days, with the result that a precipitate was formed within the dialyser, whilst the liquid still held a proteid in solution, which was found to coagulate at about 80° C.

Hence it appears that the watery extract of wheat-germ, in addition to a small quantity of proteose, holds three distinct coagulable proteids in solution, viz. :—

globulins	{	coagulating at 55° C., probably myosin.
		" " " 75° C., " vitellin.
		not coagulating below 80° C., " albumin.

The results obtained from the watery extract by treatment with sodium chloride were confirmed when magnesium sulphate was used. On complete saturation of the watery extract with magnesium sulphate, a reddish-brown precipitate is obtained which readily redissolves on dilution, forming a yellow-brown liquid. This liquid yields a coagulum at two distinct temperatures, viz. 55° and 75° C., and therefore contains the two globulins already mentioned. Complete precipitation by MgSO₄ was only effected after standing for several days. The proteid remaining in solution after saturation with MgSO₄ was found to coagulate only above 80° C.: it therefore corresponds to the substance, apparently albumin, obtained by the sodium chloride method.

On treating the watery extract of germ with a stream of carbonic acid gas, a precipitate is produced, indicating the presence of globulins; a considerable time (up to twenty-four hours) was required for the complete precipitation of the globulins. The filtrate, after the removal of the globulins, gave a slight coagulation between 80° and 90° C., thus indicating albumin as before.

Confirmatory results were obtained from extracts of germ with dilute solution of sodium chloride, the same proteids being determined.

The following table summarises the facts observed, and justifies the suggested chemical determination of the proteids of germ :—

I. Globulins: precipitated by CO_2 from watery solution, and by dialysis from solutions of neutral salts.

(a) *myosin-type*: coagulating at 55°C .; soluble in dilute solutions of NaCl and MgSO_4 , precipitated by excess.

(b) *vitellin-type*: coagulating at $75^\circ\text{--}78^\circ\text{C}$.; soluble in dilute solution of NaCl , not precipitated by excess; soluble in dilute solution of MgSO_4 , precipitated by excess.

II. Proteose: not coagulated by heat.

III. Albumin: does not coagulate below 80°C .; soluble in NaCl and MgSO_4 solutions, and not precipitated by excess or by dialysis; not precipitated by CO_2 .

Comparison of the Proteids of the Germ with those of the Endosperm.

As stated in my previous paper, I find the proteids of flour to be as follows:—

I. Globulins:

(a) *myosin-type*: coagulating at about 55°C .; soluble in dilute NaCl and MgSO_4 , precipitated by excess.

(b) *vitellin-type*: coagulating at $75^\circ\text{--}80^\circ\text{C}$.; soluble in dilute NaCl , not precipitated by excess; soluble in dilute MgSO_4 , precipitated by excess.

II. Proteose: not coagulated by heat.

III. Mother-substance of gluten: only attainable in hydrated form as either

(a) *glian*, by extracting flour with alcohol ($75\text{--}90\%$), or

(b) *gluten*, by treating flour with water.

Thus the proteids of germ and of flour seem to correspond so far as the globulins and proteoses are concerned, but in the remaining proteid-matter they differ widely—the insoluble gluten of the endosperm taking the place of the albumin of the germ. Osborne and Vorhees¹ have, however, described as an albumin from flour, under the name of leucosin, a substance which is apparently the proteid which I have classed as a globulin of the myosin-type. As pointed out in the postscript to my previous paper, these authors admit that it has certain qualities which are exceptional for an albumin, inasmuch as it is precipitated by magnesium sulphate and coagulates at the low temperature of 52° C. But the fact that this proteid was not, in their experiments, precipitated from saline solution by dialysis, led to its classification by them as an albumin. So far, however, as I have been able to investigate the point, I have never found the proteid in question to behave in this way on dialysis; and the further fact that it is completely precipitated by passing a stream of carbonic acid gas through its solution supports the view that it is a globulin rather than an albumin.

Among my dialysis-experiments were the following. (1) A watery extract of flour was saturated with magnesium sulphate; the precipitate formed was redissolved, and its solution submitted to dialysis. After ten days the liquid in the dialyser, when filtered from the precipitated proteid, still contained a minute trace of coagulable proteid. Since, however, it did not show any sign of coagulation below 60° C., but only as boiling-point was approached, it would seem that this coagulable proteid could not be either the myosin-like globulin or Osborne's albumin (leucosin), but was a small residue of the vitellin-globulin. (2) In another case an extract of flour made with 10% sodium chloride solution was, in the same way, saturated with magnesium sulphate, and the resulting precipitate redissolved as before. After the solution had been submitted to dialysis for eleven days in the presence of chloroform, and a dense precipitate had been

¹ Connecticut Agricultural Experiment Station, Annual Report, 1893.

formed, the liquid in the dialyser was filtered. Even after repeated filtration the filtrate remained slightly milky, but when heated no increase in turbidity was perceptible, so that all the proteid in the extract had been precipitated by dialysis. Distilled water was used throughout. The dialysate was changed daily and tested, but there was no indication that any proteid had passed through the dialyser.

In accordance with these facts, the table of the proteids of flour on p. 546 may be amended by the following addition :—

I. Globulins : precipitated by CO_2 , and by dialysis, from neutral saline solutions.

Hence the correspondence between the globulins of germ and those of flour may be regarded as fairly complete.

BOTANICAL LABORATORY,
OXFORD.

Experimental Studies on the Variation of Yeast-cells¹.

BY

EMIL CHR. HANSEN, Ph.D.,

Professor at the Carlsberg Laboratory, Copenhagen.

I.

IT was the epoch-making works of Darwin that gave the impulse to the tendency which is becoming more and more prevalent in modern zoology and botany, of viewing organisms from the standpoint of variation. As has been generally the case, the beginning was made here also with the higher organisms. Thus, the literature on phanerogamic plants abounds in observations in that direction; the cryptogams came under consideration considerably later, which is also true of yeast-cells and bacteria, or, as we usually style these two groups by a common appellation, micro-organisms. In the case of the Phanerogams, investigators have hitherto generally confined themselves to observations of the forms and phenomena as actually occurring in nature, and to discussions on those observations. It is, however, evident that nothing short of systematic experiments, performed by exact methods, will be able to lead to a real insight into the very complicated problems of variation; in this respect unicellular

¹ Read before the Botanical Section of the British Association, Ipswich, September 13, 1895.

[*Annals of Botany*, Vol. IX. No. XXXVI. December, 1895.]

organisms offer the most favourable conditions, everything being here simpler, more easily seen through, and more easily mastered, than in the case of the higher plants. Further their much stronger powers of multiplication here play an important part, as enabling us to arrive at a definite result within a reasonable time.

As is known, Reess published in 1870 a work, important at that time, on alcoholic fermentation-fungi. Those yeast-cells which give endospore-formation are referred by him to a particular genus, *Saccharomyces*, of which he establishes a series of species. He takes as the basis of his description the form and size of the cells. The large oval cells commonly found in beer-yeast are referred by him to the species *Saccharomyces cerevisiae*; the cells of wine-fermentation, which are also oval but generally smaller, he considers as constituting a different species, *S. ellipsoideus*; the sausage-shaped cells are termed *S. Pastorianus*, and so forth. In 1883 and the following years I proved that the limits drawn by Reess do not exist in reality, and that we are able from each of the species conceived by him to develop the rest. If we therefore still use the designations of Reess, it can at most be as denominations of groups of species, and from an essentially different stand-point from his. *It is not, as he and his successors thought, the form and size of the cells per se, in which the distinguishing characters lie, but in the form and size contingent upon particular conditions of cultivation.* Besides shape and size, we now make use of a whole series of other characteristics. When, therefore, we use the old appellations of Reess, it must be borne in mind that they have now very different significations from those in which he used them, and we must have a clear understanding that each of these groups of forms may transform itself pretty readily into each of the others. Several of the best and most vigorous yeast-fungi of wine may, morphologically, be referred as well to *Saccharomyces cerevisiae* as to *S. ellipsoideus*, and in like manner the beer-yeast fungi which, if we go by the system of Reess, may equally well be looked upon as belonging to *S. ellip*

soidens as to *S. cerevisiae*; both of these groups again run into *S. Pastorianus*. Large oval cells like those which are characteristic of *S. cerevisiae*, may, under favourable circumstances of nutrition, be developed by wine-yeasts with small oval cells; and, conversely, large typical cells of beer-yeast fungi may form smaller cells resembling wine-yeast. And, again, as regards the sausage-shaped cells the form of which distinguishes those species which, by a name of Reess's, we call *S. Pastorianus*, it must be noted, that there are several ways in which we can produce *S. Pastorianus* in the sense used by Reess, from either of the groups *S. cerevisiae* and *S. ellipsoideus*. These various relations deserve notice at the present moment, because there is now again a certain tendency to speak of *S. cerevisiae*, *S. ellipsoideus*, &c., as if each of these names designated a well-defined species.

If we ask the question, which of the various forms of yeast-cells is the primitive one, there are many reasons which make it probable that it must be the oval form, and that the species classed under the group *S. Pastorianus* have developed from the groups *S. cerevisiae* and *S. ellipsoideus*. Yeast-cells are, upon the whole, of a very plastic nature; yet it is true of at least a large number of the species, that, if cultivated under the same particular circumstances, they appear in the same forms again and again.

As regards the factors which determine the variation of the form of the cells, I have given information in previous papers. Among my former researches on the variations, some experiments are described on the action of the air on some species of beer-yeast, and also on the influence of certain conditions of nutrition with regard to spore-formation. I have shown that in the case of several species there appear suddenly, generally from unknown causes, varieties which have lost, more or less completely, their power of forming endogenous spores. The usual cultivation in a favourable nutritive liquid, as beer-wort, at favourable temperatures, in these cases avails nothing; but in the case of some species, I found that such cells are reduced to their normal state, if some dextrose is

added to the nutritive liquid. Here, therefore, the particular effect exercised by a particular chemical factor has been pointed out. In the instances just mentioned the variations were of a more or less inconstant nature.

In the course of the above researches on the disappearance and recovery of spore-formation, I made in 1889 the discovery that in this domain it is possible to produce very deep-seated transformations, and to render these permanent. It was found that when the cells were cultivated for a length of time in aerated wort, and at a temperature above the maximum for spore-formation and approaching that for vegetative development, they completely lost their power of forming spores.

I have effected this transformation in the case of five of the species described by me in 1883, and also with several bottom-fermentation and distillers' top-fermentation yeasts that is with representatives of the various groups of the *Saccharomycetes* properly so called. Thus we have to do with a common law; yet this seems to apply to the typical and genuine *Saccharomycetes* only; at any rate, I have not hitherto succeeded in producing this transformation in the case of *S. anomalus* and *S. membranæ-faciens*, both of these being, indeed, species which, as may be remembered from my papers, differ so widely from the others, that they might well be set up as types of quite new genera.

As might be expected, the law of correlation asserts itself. Thus a closer examination shows that the transformation which we effected does not stand alone, but is accompanied by others. This is especially evident from the fact that the yeast-cells under our treatment at the same time completely lose their former power of forming films on the surface of liquids.

While the loss of spore-formation is attended in all species without any exception, with loss of film-formation, there appear differences in other directions in the species transformed. Thus in some I observed that in wort-culture they produced a more abundant growth, and at a quicker rate, than

the parent-cells from which they were descended, while in others no such difference could be observed.

The above variation has thus influenced some of the most important morphological and physiological features, and it is of such a constant and radical nature that the resulting cells might well be regarded as constituting new species; however, I described them as varieties in my earliest publications, and will keep this designation for the present. Although they have been cultivated for several years past, under most varying circumstances, through endless generations, still they have kept constant; the newly acquired qualities have proved to be entirely heritable.

II.

The investigations mentioned above are to be found partly in my *Recherches sur la physiologie et la morphologie des ferments alcooliques* (*Comptes-rendus des travaux du laborat. de Carlsberg, 1881-1891*), partly in the *Centralblatt für Bakteriologie und Parasitenkunde, 1889, p. 638*, and partly in the *Annales de Micrographie, février, 1890*. A more detailed summary than the above may be found in my book, *Practical Studies in Fermentation*, which will appear this autumn, published by Messieurs Spon, London. I will therefore dwell no longer on this subject, but pass on to a mention of my recent experiments¹.

About fifteen years ago I published a paper on the biology of *Saccharomyces apiculatus*, in which I pointed out, amongst other facts, that this yeast winters in the earth; later, I found that this also holds good of the true *Saccharomycetes* with endospores. I will, in this connexion, only mention the fact that wine-yeasts belonging to the group *S. ellipsoideus* kept alive in the earth, like *S. apiculatus*, for more than three years. By making comparative investigations on the varieties

¹ In a fuller treatise which I am preparing at present, a detailed account of the phenomena of variation observed by me and of the factors and laws which influence them, will be found.

which had lost their power of spore-formation, I found that, when placed in the earth, they showed a decreased vitality as compared with their original forms, and generally perished within less than a year. In the sugar-solutions, on the other hand, in which they had produced alcoholic fermentation, they kept alive for several years, and, as far as my experiments go, they appear not to be second to their parent-cells in this respect.

Since the varieties no longer possess the power of forming films on the surface of liquids, their life in these becomes quite different from what it used to be. As shown in one of my papers, the cells of the film which develops on fermented beer-wort cause the liquid to become lighter in colour; and from the chemical investigations of Kruis and Rayman (1891) we know that these cells produce a vigorous oxidation, by which the alcohol is converted into carbonic acid and water. Thus the yeast, as long as it is in its normal state, not only produces alcoholic fermentation in the sugar-liquid in which it is present, but when it has carried this fermentation as far as it is able to do, it forthwith takes to transforming the alcohol produced by itself, thus coming to live in a liquid with less and less of alcohol. The varieties not being able to develop any film, they of course have given up this activity. As an example of the contrast between the varieties and their original form in this respect, I will here only mention the result of one of my experiments. Two cultures in the same wort, of which one contained a brewers' bottom-fermentation yeast, the other a variety of the same, which I had produced in the manner described above, were left to stand for six months. The original form had developed a film as usual, and its fluid contained only 1.5 per cent. (by volume) of alcohol, whilst the variety showed 5.5 per cent., that is, the same amount of alcohol as it contained after standing the first month. The beer from the primitive form was lighter in colour than the corresponding beer from the variety. Thus the varieties described manifest in those directions also sharp differences from their primitive forms.

We are now going to mention some experiments, by means of which varieties were produced in another manner than that described above, and with other properties.

If yeast-cells are living on the surface of nutritive gelatine, they are exposed to quite different conditions from those which obtain when, for instance, they are living in wort, and the new generations produced under these special circumstances therefore also acquire a special character. Two varieties, *a* and *c*, of the Carlsberg bottom-yeast, No. 1, were partly cultivated in wort, partly on the surface of wort-gelatine, the cultures being renewed fairly frequently during some months. On the gelatine new varieties developed having a greater fermentative power than their primitive forms. In wort to which cane-sugar had been added, the latter only produced about 13 per cent. (by volume) of alcohol, while the new varieties produced 13.6 per cent. In this experiment only vegetative cells were made use of.

A more marked difference, in the same direction, appeared in some experiments which I made with the top-fermentation yeast *Saccharomyces cerevisiae*, I. They were arranged in the same manner as the foregoing experiments, but the cultures were here made from spores, and instead of wort-gelatine, yeast-water gelatine was used. The growth which was cultivated on gelatine in this case gave 3 per cent. of alcohol more than the corresponding growth which had been cultivated in wort.

Before leaving these experiments, I must emphasize the fact that the gelatine varieties produced were all descended from varieties which, as long as they were cultivated in wort, were very constant, and were distinguished by producing only a comparatively small percentage of alcohol.

Another way in which we may operate on yeast-cells in the direction mentioned, is by the action of antiseptics. In 1887 Biernacki arrived at the conclusion that all antiseptics, when employed in small quantity and under certain conditions, possess the property of accelerating and strengthening alcoholic fermentation. Maercker's and Hayduck's investigations

tend to prove the same. Later, Effront, in his well-known experiments on hydrofluoric acid and alkaline fluorides, arrived at the same general result. In all these cases only transitory transformations are meant.

In the foregoing I have mentioned that a great part of my experiments were carried out to determine the influence which temperature has in respect to the form and the functions of yeast-cells; by this I was also led to make the following researches on the attenuation of the fermenting powers of yeast-cells. Carlsberg bottom-yeast, No. 1, was cultivated in wort at 32° C. through eight cultures in such a manner that each subsequent culture was inoculated from a foregoing one, and left standing at rest until the fermentation had ceased, without being aerated. In the ninth culture a variety was obtained, which gave 1-2 per cent. of alcohol less than its primitive form, when the fermentation was carried out in wort (14 per cent. Ball.) to which was added 10 per cent. of saccharose. Also in other directions changes had taken place; thus the new variety in some brewery-experiments clarified better and gave a more feeble attenuation at the end of the primary fermentation than the growth from which it descended. The variety seems to be constant, and what has been found out for the species in question seems also in the main to hold good for others.

But if the same species was submitted to the same treatment, only with the difference that the growth was strongly aerated and renewed every day, these transformations would not occur; they thus afford an illustration of the fact, that temperature only under certain conditions has the effect described.

Before concluding this survey of the varieties observed by me, I have to record an experiment by which the effect of the chemical composition of the nutrient liquid is shown. *Saccharomyces Pastorianus* I., is one of the disease-yeasts of beer, to which it imparts an offensive odour and a disagreeable bitter taste. According to Mach and Portele's investigations, however, it gives a good wine, and my own experiments have

shown that when this species is cultivated for a number of generations in a solution of cane-sugar in yeast-water, a growth is obtained the cells of which have for a time lost the disagreeable properties referred to. From this it is seen that it is possible to act upon yeast-cells in such a way that they can be made to impart to fermenting liquids a taste and odour different from that originally characteristic of the yeast.

It is a common fact that when bacteria are cultivated in a certain manner they lose their fermenting power. In a very interesting paper, read at the British Association for the Advancement of Science, 1893, Professor Percy Frankland has given an account both of the researches which he himself has undertaken in this direction and of those which at that time had been made by other investigators. He brings into relief the fact that it may frequently be observed that a bacterium which had originally the power of fermenting some particular substance, has lost this power through prolonged culture, and that, indeed, even a single passage through gelatin may apparently destroy the capacity to exercise this function. We do not know any similar instance of such behaviour in the case of the alcoholic yeasts. Their cells may be transitorily very much enfeebled, and, as we have learnt, varieties may be produced which give less alcohol than their primitive forms, but it appears to be impossible to produce a variety which has completely lost its alcoholic fermenting power.

In the Danish edition of my paper on the circulation of *Saccharomyces apiculatus* in nature (1881), I expressed the idea that it might possibly be well to abandon the cultivation of the old culture-yeast (*S. cerevisiae*, as we usually term all these species) for technical purposes and replace it by some of the yeast-species occurring in nature, it being my belief that in this way we should *perhaps* be able to obtain products which were not only different from, but also in certain directions better than those manufactured by means of *S. cerevisiae*. Just at that time there was a great deal of talk about the degeneration of culture-yeast, and there was a general inclination to ascribe to it most of the difficulties occurring in the

brewery-fermentations. But, if we ask, what do we know about this variation which is supposed to have taken place from the primitive form, then the answer must be: Nothing at all. *We have never been able to carry one single Saccharomyces species back to its progenitor!* Some years ago I showed, it is true, that typical Saccharomycetes may appear in forms resembling *Oidium* and *Dematium*, and possessed of a mycelium with distinct transverse septa, but we have not advanced further in that direction. As is well known, Takamine, Juhler and Jörgensen have recently come forward as advocates of the view formerly represented, especially by Bail and Hoffmann, that the Saccharomycetes are merely developmental phases of various common mould-fungi, and they have also all three fallen back upon the idea alluded to above, that there should be a possibility of obtaining, through the original forms, yeast-species that in certain particulars might be better than those actually employed. In their cultivations they started from the moulds themselves, and describe how *Aspergillus* and *Dematium* develop *Saccharomyces*-cells.

Klöcker and Schiønning at the Carlsberg Laboratory repeated the above experiments with *Aspergillus Oryzae*, and in accordance with the previous investigations of Cohn, Büsgen and Wehmer, they were not able to observe any development of yeast-cells. The whole question must at present still be considered as an open one. For the rest we know now so many mould-fungi that develop alcoholic fermentation-fungi, that it would not be a matter of wonder if some should really be found which also develop yeast-cells with endospores. (About this question see the articles of Juhler, Jörgensen, Wehmer and myself in *Centralblatt f. Bakteriologie*, 2^{te} Abt. 1895, pp. 16, 65, 321, 326, and 565.)

In the preceding portion of my paper I have chiefly described the phenomena of variation without inquiring more closely into its mechanism, nor have we examined the agencies and causes to which it is due. I have, however, made extensive experiments in that direction also, but to describe the details of these would on this occasion lead us too far.

Those who would be likely to take an interest in them will find information in the fuller treatises which I am about to publish. I shall, therefore, now only refer to the results in a few words.

Among the above-mentioned variations, those offer the greatest interest in which cells were produced which had entirely lost their power of forming spores and films. In trying to elucidate how this transformation is effected, we have on one hand to examine the external factors, and on the other hand to elucidate how the cells are influenced by them. Of course, we always work with absolute pure cultures; in some cases we experiment with the whole bulk of the vegetation in question, while in others we separate the single cells at the different stages, putting each severally to the test.

We find, that in the cultures under discussion, at the high temperature a vigorous multiplication still takes place, and that even in the first stages a large number of the cells have become transformed; this number increases as the cultivation progresses, but the change is at the beginning of a transitory nature, and it is only through the development of new generations that the newly acquired qualities become fixed, so that at last a constant variety comes out.

As thus shown it is not the temperature alone, which effects the transformation, but only in connexion with the multiplication of the cells. In agreement with this we find, that it is not sufficient to cultivate the cells in water, but that a favourable nutritive substratum and a certain aëration are required.

Of the variations which have been observed in bacteria, in some cases it has been assumed that they were due to chemical changes in the culture-liquid; since this might also apply to my above-mentioned variations in the Saccharomycetes, I therefore put the question to an experimental test. The result I obtained was that special chemical compounds do not play any part in that case.

Of the external factors we have then only the nutritive substratum, the aëration and temperature left.

As to the nutritive substratum and aëration my experiments have proved that only this much is required, that they must allow of a vigorous multiplication, and the range within which these factors may vary is a very large one. But this does not apply to temperature. One or two degrees too much or too little is enough to prevent the changes from taking place; if the temperature be a little too low, the effect will not be sufficiently marked, whilst at a somewhat too high temperature the multiplication of the cells ceases too soon, the consequence being that the transformation, which has commenced, does not become fixed. In comparing the temperature with the other external factors we must, in the experiment under discussion, consider it the most influential.

The above described phenomena of variation affect the yeast-cells in very different ways, influencing both morphological and physiological characters. Some of the phenomena still remain isolated as if accidentally caused, others group themselves under certain rules. It is especially the latter, which invite to new investigations in order at last to find out the laws. To discuss what relation there may be between the observed facts and the hitherto established theories of variation would at present only be to waste words. When finishing my experiments I hope in that respect also to be able to give a survey.

On some Constituents of the Cell.

BY

JAMES ELLIS HUMPHREY, S.D.,

Lecturer in Botany, Johns Hopkins University, Baltimore, U.S.A.



With Plate **XX**.



A YEAR and a half ago the writer published ('94) a brief preliminary account of the results of studies on the cell, carried on in the Botanical Institute at Bonn, under the inspiring guidance of Professor Strasburger. Since then these studies have been continued and extended in America, and meanwhile several papers bearing on the same questions have appeared. It seems, therefore, now worth while to examine the views then brought forward in the light of the latest and fullest evidence from all sources. Various details and general considerations which are stated in my earlier paper will hardly require to be repeated here.

The question as to the nature of the bodies long known as nucleoli has been made prominent by a paper of Zimmermann ('93) on their behaviour during karyokinesis. These bodies, while they readily take up very many stains, and are perhaps the most conspicuous features in preparations of the resting nucleus, are not so stained by all media as to be readily distinguishable from all other constituents of the cell. But until our knowledge of the higher organic compounds is

[*Annals of Botany*, Vol. IX. No. XXXVI. December, 1895.]

greatly increased, the best staining methods will offer the only trustworthy means for their study. We know certain combinations which give to the nucleoli in all stages a sharply differential colour by which they can be unhesitatingly distinguished from all other bodies in the cell. They vary greatly, as is well known, in form, size, and position in the nucleus, and sometimes, as Zimmermann has shown, outside of it. But, so long as they are present in size recognizable by the highest powers, their reaction with certain stains remains characteristic. A favourite combination with many students for differentiating the chromatic and nucleolar elements of the nucleus has been the mixture of fuchsin and iodine green, first recommended by Babes and introduced into botanical technique by Strasburger. This combination was used by Zimmermann in his studies, with the addition of an after-treatment of the sections with alcohol containing iodine and acetic acid. This addition constitutes a real improvement in the process by increasing the sharpness of the preparations obtained, and the permanence of the stain. The nucleoli take, under this treatment, a blood-red colour, which is not approached by that of any other cell-constituent.

Zimmermann's argument is based on the occurrence of nucleolar masses outside of the nucleus during karyokinesis, a fact which no one will dispute. Several years before his observations, very large and numerous nucleolar masses had been observed by Strasburger in the cytoplasm of the wall layer of the embryo-sac of some *Amaryllidaceae*, and Zimmermann has done good service in showing that the phenomenon is more common than had previously been suspected. He has found the 'extranuclear nucleoli' to be sometimes abundant in the cytoplasm of cells from a large number of tissues, both during nuclear division and in the resting-state. But he attempts to show that the nucleoli are normally thrown out of the nucleus during division, remaining in the cytoplasm, entire or in fragments, and being taken up again by the daughter-nuclei resulting from the division. He regards the nucleoli as true organs of the nucleus derived

directly from each other, and seeks to establish the principle, '*Omnis nucleolus e nucleolo*,' as of equal value with the long-accepted statement of Flemming, '*Omnis nucleus e nucleo*.' This is directly contrary to the generally prevailing view, that the nucleoli consist of a reserve substance which is ordinarily dissolved or otherwise changed during the earlier stages of karyokinesis, so that they are no longer recognizable as nucleoli.

The results of my earlier studies upon this question, begun soon after the appearance of Zimmermann's paper, have already ('94) been briefly stated. More recently Guignard ('94) and Strasburger ('95) have discussed the question. And a somewhat fuller account of its present status seems not to be superfluous, especially since Guignard seems to take a less definite position than is warranted by the facts he admits.

The fate of the nucleoli during karyokinesis has, very naturally, been discussed by almost every writer on that process, since those bodies are so conspicuous when present. And the number of observed cases of their persistence during the spindle-stages or of their occurrence in the cytoplasm had been so small before the publication of Zimmermann's results that they had been practically ignored. The fundamental significance attached to them by this author led to a renewed investigation of the facts. In my examination of spore- or pollen-mother-cells of *Osmunda regalis* and *O. cinnamomea*, *Psilotum triquetrum*, *Ceratozamia longifolia*, and *Convallaria majalis*, the first divisions in the spores of *Pellia epiphylla*, root-tips of *Vicia Faba*, *Hyacinthus* sp., and *Allium Cepa*, and the wall-layer from the embryo-sac of *Leucojum aestivum*, I have found only in rare cases a trace of nucleoli during the middle stages of karyokinesis, or of any in the cytoplasm at any stage. Reference to the figures accompanying my earlier paper and the present one will show what has been found to be the general condition of these bodies during the chief phases of nuclear division. Figs. 2 to 6 on the plate given herewith show several steps in the first division of the spore-mother-cell in *Osmunda regalis*, while Figs. 11 and 12

of my former paper ('94) and Fig. 7 of the present one show some stages in its second division which yields the spore-cells. Not one of these shows any nucleolar substance in the cytoplasm; nor does any in which the nuclear membrane is not intact show it within the nuclear cavity. It is not necessary to go into a detailed discussion of the matter, for Zimmermann has stated his position so uncompromisingly that, as Strasburger has said ('95), a single case of the solution and subsequent reappearance of the nucleoli during division overturns it at once. If the nucleolus is a definite organ, derived only from its like, it must persist as such so long as the cell is active. Zimmermann himself admits that he has not been able to see it in all cells with dividing nuclei in the apex of the stem of *Phaseolus*. I have seen hundreds of karyokinetic figures in cells of both vegetative and reproductive tissues of all the plants above named, which showed no trace of any substance reacting to stains like the nucleoli. Besides, when nucleolar globules are found in the cytoplasm they are as likely to remain there as to be taken into the nuclei resulting from the division. There is not the least indication of any provision for their return to a daughter-nucleus after being thrown out from the mother. (Cf. Fig. 2 of my previous paper.)

Strasburger ('95) finds that, in agreement with his earlier statements, the nucleolus in the pollen-mother-cells of *Lilium* usually becomes entirely dissolved at the time of the formation of the spindle-fibres. And he adds that when a nucleolus is thrown out into the cytoplasm, this does not happen until it has been greatly reduced in volume, apparently by the solution of its substance. Guignard ('94) states, as a result of his study of *Psilotum*, that the persistence of the nucleoli is much rarer than their solution, and that the re-entrance of extranuclear nucleoli, when present, into the new nuclei is by no means a constant feature. In my examination of *Psilotum*, not a single well-marked case of extranuclear nucleoli was found. So far as the final divisions of the spore-mother-cells are concerned, Guignard found them almost equally rare;

but in the divisions of the sporogenous cells to form the definitive spore-mother-cells, he found nucleolar substance much more abundant, and its occurrence in the cytoplasm correspondingly common. The material of *Psilotum* at my disposal, from the Botanic Garden at Bonn, showed only the spore-formation from the definitive mother-cells, which accounts for my having failed to agree in all respects with Guignard's observations. The fact that in *Osmunda* the definitive mother-cells are formed in autumn, has prevented the study of the divisions preceding their formation, my material having been collected in early spring. But if the extranuclear nucleoli are sometimes common in certain cells, this does not alter the fact that they are extremely rare in others, or lessen the force of the evidence against the view which regards the nucleolus as a permanent organ. Guignard does not seem to have sufficiently emphasized this point.

It is hardly necessary to repeat what was pointed out in my preliminary paper, that the great variability and evident passivity of the nucleoli are equally opposed to the conception of their definiteness and permanence. Their inconstant form, the readiness with which they break up or fuse together, and their tendency to assume the globular form when unhampered and not too large, all point unmistakably to the probability that they are of a fluid consistency, while their gradual disappearance in the early stages of division, as the karyokinetic forces come into full activity, and their equally gradual reappearance as this activity is ceasing, show plainly that they are directly acted upon by those forces. The constant occurrence of nucleoli in the nuclei of most widely different plants indicates the importance to the cell of the material which takes this form during its less active condition. Very careful studies of preparations from a large number of plants, stained with the best reagents for nucleolar substance, have quite failed to show me any change in the staining properties of the more permanent cell-constituents, which would give an indication of the distribution of the material of the dissolved nucleoli, although some writers have

believed they have observed such a change. It is a common observation that a disappearing nucleolus within the nucleus often loses its staining power more rapidly than it decreases in size, though remaining distinctly stainable to the last. These facts seem to confirm the belief that the nucleoli are indefinite masses of a reserve substance, which, for want of chemical knowledge, we must call nucleolar substance, or, with Schwarz, *pyrenin*, and which undergoes a chemical change, in consequence whereof it loses its power to take up stains. They are, then, strictly comparable, to borrow my previous comparison, with the drops of oil in the Castor Bean, which disappear as oil-drops during the active life of the plant, to reappear in the resting-stage of the new seeds. There is no evidence that the nucleolar substance which appears in the daughter-nuclei after division is identically the same as that which disappeared just before the division. It can only be said to be a chemically similar substance. The fact that not all of the nucleolar material in a cell is always changed, may show nothing more than that more may sometimes be produced than can be changed at once. We know, as yet, so little about the part played by this substance and about the relation of nutrition and other conditions to its formation in the cell, that it is idle to speculate upon its significance.

The latest view of the rôle of the nucleoli¹ is that of Strasburger ('95), who is led by his observations on *Larix* to believe that they furnish the material for the formation of the spindle-fibres. I can add nothing at present to the discussion of this question.

Zimmermann's demonstration of the not infrequent passage of nucleolar substance into the cytoplasm, and the pretty generally accepted fact that in many cases extranuclear substance contributes to the spindle-fibres, deserve emphasis as indicating a free interchange between all parts of the cell,

¹ More exact information concerning the nature of the nucleoli in animal cells, and whether any of the bodies included by zoologists under this name are chemically similar to the nucleoli of plants, is greatly to be desired.

and as supporting, in a measure, Boveri's view that the so-called nuclear sap is not a specific or peculiar substance. Evidence from the botanical side is much to be desired, as to whether, as this author believes, the nuclear membrane is merely a bounding layer of the cytoplasm enclosing the nuclear cavity.

Zimmermann ('93) observed in the sexual cells of *Lilium Martagon* that, as he believes, only at a certain early stage of their division the nucleolus becomes flattened against the nuclear membrane, constituting what he has called its *sickle-stage*, which was earlier referred to by Strasburger under the names 'Sekretkörperchen' and 'Paranucleolus.' He has attempted to connect this peculiar phenomenon with the reduction of the chromosomes, holding that it occurs only in the stage immediately preceding that process. During studies of various tissues, my attention was occasionally attracted by crescent-shaped accumulations against the nuclear membranes, often so great as to distort the nucleus. These are commonly present, if at all, in all the nuclei of a section, even when it includes both vegetative and reproductive tissues, and in resting nuclei as well as in those beginning to divide. The presence of these accumulations always on the side of the nucleus turned away from the nearest surface of the organ (cf. Figs. 3 and 4 of my previous paper) showed clearly that they are caused by the uneven penetration of the fixing fluid, which carries with it, until stopped by the nuclear membrane, certain deeply staining constituents of the nucleus. The reactions of the accumulations with stains made it very doubtful if they contain any nucleolar substance, but rather chromatin, a conclusion with which Strasburger has lately expressed ('95) his agreement. Since no similar bodies with the reactions of nucleoli were found in the tissues examined, it was believed that these represented the 'sickle-stage' of Zimmermann, which was therefore explained as due to imperfect fixation of the material. This identification was probably hasty, in view of the fact that Zimmermann figures his bodies as staining precisely like nucleoli. And he has

since ('94) insisted upon the restriction of the 'sickle-stage' to a special phase of sexual cells. Strasburger ('95) has lately stated that the nucleolus may be flattened against the nuclear wall by the fixing fluid at an early stage of the prophase, when the nucleus is, as various observers have pointed out, peculiarly sensitive to reagents. Renewed examination of a large number of preparations has failed to show me any instance of this sort, but there is no reason for doubting that such displacement sometimes occurs, though far less commonly than the heaping up of chromatic substance.

If the so-called 'sickle-stage' bears any relation to the passage from sporophyte to gametophyte marked by the reduction in the number of chromosomes, as Zimmermann believes, it should be found always during the prophase of the first division of the definitive pollen- or spore-mother-cell. Yet, in the study of a very large number of such cells in the very stage indicated, and from several different plants, I have been able to find no such sickle-shaped nucleolus, nor indeed any nucleolus, in contact with the nuclear membrane. For the quick fixation of the nuclear constituents with the least possible displacement, the trial of many fluids has led me to prefer, in general, the alcoholic to the aqueous media. Of the latter, Hermann's fluid seems oftenest to do well. Merkel's fluid, recommended by Zimmermann, is much less satisfactory. But alcohol, sublimate-alcohol, or the fluid recommended for some animal tissues by Mann, are the most to be recommended for vascular plants, especially for reproductive tissues. As the formula for Mann's fluid has not, to my knowledge, been published in a botanical journal, it may be worth while to give it here:—

Absolute alcohol	100 cc.
Picric acid	4 grams.
Corrosive sublimate	15 „
Tannin	7 „

Dissolve and filter.

While it is, therefore, impossible to say positively what is

the real nature of the 'sickle-stage,' it seems probable that it will prove to be a nucleolus, and not chromatic substance, as I formerly thought, but displaced and flattened by the unequal penetration of the fixing fluid, as before indicated. Strasburger appears to share this belief. The evidence we now have is quite too slight to justify the attachment of any importance to this particular form.

It is not yet nine years since the fundamental importance of the structures variously known as attraction-spheres, directive-spheres, and centrospheres, was first suggested, almost simultaneously, by van Beneden and Neyt and by Boveri; and it is four years less since they were described for plant-cells by Guignard ('91). Since then they have been observed by several investigators in various vegetable tissues; but, on the other hand, it is certain that not all the structures which have been so regarded have really been centrospheres or centrosomes. The small size and comparative inconspicuousness of these bodies, which caused them to be so long overlooked in animal cells, are still more pronounced in case of plants, and make their study one of extreme difficulty. In the best and clearest vegetable preparations yet obtainable, their demonstration leaves very much to be wished for, in comparison with successful slides from animal tissue.

There are now generally recognized two more or less distinctly differentiated parts of these bodies, and the limitations of the names applied to them by Strasburger ('92), though not all first used by him, has been largely adopted by both botanical and zoological writers. A tiny central body, the *centrosome*, is usually distinguishable from the surrounding globular, hyaline mass, the *astrosphere*; these portions together constitute the whole structure, the *centrosphere*. In plants the centrospheres have been seen only in the cytoplasm, usually in intimate relations with the nucleus; but it is only under most favourable circumstances that they can be recognized. The centrosome is little or no larger than the larger microsomes of the cytoplasm, and can only be recognized when it is surrounded by an astrosphere of sufficient breadth to

characterize it. That it sometimes exists without an astrosphere, as Boveri believes, still requires proof so far as plant-cells are concerned; but this seems by no means impossible. At present we are practically restricted to the presence of the astrosphere as a diagnostic character. It is well known that the cytoplasmic microsomes are commonly surrounded by clear diffraction-areas, which are the wider as the microsome is larger. These areas, however, are never so wide as the well-developed astrosphere, and their optical properties are different. They appear as narrow and empty or watery rings about the microsomes; while the true astrosphere is more strongly refractive, appearing like a clear thick drop of jelly with a darker point, the centrosome, at its centre. The attempt is made to show these differences in Fig. 12, where both centrospheres and large microsomes are seen; but it is impossible to represent with the pencil the optical difference just described. The advantage of conspicuous cytoplasmic radiations guiding to the centrospheres, at least in certain stages, which are of great assistance in most animal cells, is quite wanting among plants with the exception of a few cases; and, even in these, the radiations are far less pronounced than in animals.

Various stains have been said to possess a specific selective power for these bodies, or at least for the centrosomes. A careful trial of all the important methods proposed for staining them which have come to my notice, as well as of various unpublished treatments, has entirely failed to yield any satisfactory results. Stains which show a strong affinity for the cytoplasm often include these bodies in the diffuse colouring they impart; but I have not yet succeeded in differentiating them beyond a slight darkening of the centrosome in some cases. It would be superfluous to enumerate all the methods which have been tried, but it may be well to say that neither Heidenhain's iron-haematoxylin stain, Hermann's process with pyroligneous acid and haematoxylin, nor Rawitz's new method ('95) of inverse staining, has given better results than others. The first two of these stains bring out quite as

sharply, or even more distinctly, the larger microsomes and various other proteid granules, such as leucoplasts, when present; and the result is only confusion and uncertainty (cf. Fig. 12). Boveri ('95) states that the egg of the Sea-Urchin contains numerous granules which stain as deeply with iron-haematoxylin as the centrosomes. No treatment has yet enabled me to see these bodies more distinctly than after simple staining with the gentian-violet-eosin combination recommended by Farmer ('94), or according to the fuchsin-iodine-green method used by Zimmermann. The substitution of acid fuchsin for fuchsin in the last mixture seems to offer no advantages.

Since the centrospheres are relatively so small, the chances of their concealment are correspondingly great. Thus, unless a section be taken in the right plane, they may be easily hidden beneath the nucleus, as probably in Fig. 2. Or, if a section be not very thin and the centrospheres in a given cell lie below the surface of the section, covered by a thin layer of the granular cytoplasm, they are very effectually concealed. These possibilities must be borne in mind in the consideration of any account of the presence or absence of centrospheres.

It may be remarked that these results of my experience in the study of these bodies coincide, in the main, with those of Guignard ('94). It is also of interest to observe that Boveri remarks, in his last admirable discussion ('95) of the centrosome question, upon the importance of 'the clear space and the radiations' for the recognition of the centrosome in many animal cells. One may be pardoned serious doubts whether all the appearances heretofore interpreted as centrospheres by zoologists really justify such interpretation.

Among the most clearly recognizable plant centrospheres yet seen are those figured for *Sphacelaria* by Strasburger ('92) and the writer ('94), and for *Pellia* by Farmer and Reeves ('94), and by Strasburger ('95). I have been able also to observe them in material of *P. epiphylla* collected near Baltimore. In both of these cases cytoplasmic radiations render considerable aid to the observer. The relation of the centro-

spheres to nuclear division, and their apparent control over the formation of the spindle in determining the position of its poles, are too familiar to need description here. My own experience agrees with that of Farmer and of Strasburger in regard to the extreme difficulty of recognizing these organs at the poles of the spindle in *Pellia*, or in the resting cells. On the other hand, I have observed centrospheres in cells in nearly all conditions of rest and of division in a variety of plant-tissues, including most of those enumerated above in connexion with the investigation of the nucleoli. My observations on *Psilotum* have been confirmed and extended to every phase of cell-life by Guignard ('94), and Strasburger ('95) has added *Larix europea* to the list.

A favourable plant for the study of the structures in question is *Osmunda regalis*. Here they are not quite as large, as a rule, as in *Psilotum*, but in their occurrence and behaviour they quite agree with those of the latter plant. Sections of the sporangia of *O. regalis*, collected at the very beginning of growth in the spring, show the various stages in the formation of the spores from the spore-mother-cells, often in great abundance. But all the mother-cells of a single sporangium are in nearly the same phase of rest or division as may be. Figs. 1 to 6 on the accompanying plate show several stages in the first division of these cells. Beside the completely resting nucleus of the cell shown in Fig. 1, lie the very evident centrospheres. Here, where they have abundant room, they show the usual spherical form, but they sometimes appear smaller and flattened in resting cells, when confined in a narrow space, as in Fig. 7. Fig. 10 shows the same thing from the root-tip of the Onion. In the stage shown in Fig. 3, the chromosomes have become individualized, and a remnant of the disappearing nucleolus, *n*, may still be seen. The centrosomes have just divided, apparently somewhat prematurely. In the two following stages the centrosomes are very plainly seen; but Fig. 6 fails to show them, probably because they are hidden by the daughter-nuclei. In the view of the young spore-tetrad (Fig. 7), which results from the second divisions in

the mother-cell, one pair of centrospheres can be made out. Again, in the single isolated spore-cell of *Osmunda cinnamomea* (Fig. 9), these bodies are very distinct.

Farmer has lately published ('95) a detailed account of his studies of pollen-mother-cells of *Lilium Martagon*, which were briefly described in an earlier note ('93). He finds spindle-threads converging towards various irregularly placed granules in each spindle, and fails to recognize definite centrospheres. His published figures are largely reproduced from photographs of the objects, and he has had the goodness to send me several prints from the original negatives. It must be said that these figures do not arouse suspicions of poorly hardened or of abnormally developed material, in so far as they justify any judgment, to the same extent as did the woodcuts accompanying his preliminary note. But the results of photographing with high powers are utterly inadequate to the preservation of the finer details of a preparation. It is doubtful if any preparation of a plant-tissue has yet been made in which the centrospheres were sufficiently distinct to be sharply brought out in a photograph. Our chief dependence must still be on the camera lucida and the pencil. Those of Farmer's figures which are reproduced from drawings show none of the abnormal spindles which he describes. In view of the very remarkable agreement in the phenomena of nuclear division in the vascular plants in which it has been studied, one might almost feel justified in doubting the normal character of the phenomena described by Farmer for *Lilium*, because of their divergence from what occurs in *Psilotum* and *Osmunda*, as Farmer intimates I have done. But this would not be fair, especially when a proper basis for judgment is at hand. Unfortunately my own acquaintance with the cells studied by Farmer is very slight. This plant, however, has been a very favourite object for the study of karyokinesis with various other observers of the first rank. It is chiefly because of their difference in important respects from the observations of Strasburger, Guignard, and others, that I still venture to doubt that the phenomena described by Farmer are typical

for the pollen-mother-cells of *Lilium Martagon*. The granules in and about Farmer's spindles appear to be of a nucleolar nature. And if Strasburger's present view that the rôle of the nucleolar substance is to form the spindle-fibres be correct, these apparently multipolar spindles may be unusual forms due to the presence of an excess of nucleolar substance in the cells concerned. At all events, as already suggested, a better knowledge of the relations of the amounts and proportions of the substances taken up by the plant, or of the influence of the conditions which further or retard growth, to the cell-constituents, may explain many such phenomena as those which are here in question.

For fixing material to show the centrosomes, not all fluids are equally good. With favourable objects alcohol does well. But in general, and especially for vegetative tissues, where the cell-structure is less conspicuously developed, nothing has given me better results than Hermann's platinum-chloride-osmic-acetic mixture. Subsequent staining by the long and tedious process recommended by this author for showing animal centrosomes, gives less satisfactory results than the simple fuchsin-iodine-green stain. As has been remarked, the former brings out various proteid granules in the cytoplasm as conspicuously as the centrosomes; with the latter stain the centrosomes come out distinctly and the other bodies remain uncoloured. The difference is shown in Figs. 11 and 12, from the root-tip of the Onion. Both are from material fixed with Hermann's fluid; but the section from which Fig. 11 is taken was stained on the slide by Zimmermann's method, while Fig. 12 is from a root-tip stained *in toto* according to Hermann. The writer can therefore confirm the recent statements of Schaffner ('94), that centrospheres occur in their usual form in these young vegetative cells of the Onion root. But, as may be understood from Fig. 12, it is much easier to find bodies which one who is determined to find them may interpret as centrospheres, in sections stained by Hermann's method, largely used by Schaffner, than in those treated in a better way.

That the centrospheres increase by division cannot be doubted. In the early stages of spindle-formation but a single one is found at each pole; and later, commonly just after the splitting of the chromosomes, in vascular plants, each is replaced by a pair. That the division takes place rapidly is shown by the fact that it is rare to find any stages in the process. But I have observed two cases in sporangia of *Osmunda regalis* which illustrate the mode of division. In Fig. 3 is a nucleus in an early stage of karyokinesis, whose centrospheres have arrived at the opposite poles and are beginning to divide, apparently earlier than usual. The astrosphere has become biscuit-shaped, and each centrosome has divided into two, which still remain very near together. In Fig. 8 is seen a later stage in the division of a tapetal nucleus and centrospheres, showing the constriction of each astrosphere into two about the separated centrosomes. It is, of course, impossible to assert that the increase of these organs always takes place in this way, since our knowledge of them is so fragmentary. But it is natural to ask why, if they can be formed *de novo* in the cell and are derivable from other cell-constituents, they should ever have acquired this power of division.

My objections to certain views which have been held concerning the relations of the centrosomes and the centrospheres¹ to other cell-contents have since received important support. In the previous paper ('94) I tried to show the very fundamental structural and chemical differences between the centrospheres and the nucleoli, and that Karsten's belief ('94) in the derivation of the former from the latter at the beginning of karyokinesis in *Psilotum* was based on his having overlooked the centrospheres entirely, although they are not difficult, comparatively speaking, to demonstrate in that plant. Guignard ('94) has so fully confirmed this explanation that further arguments seem superfluous to demonstrate the essential

¹ As Guignard points out, not all writers on the subject have appreciated the important distinction between the two.

improbability of a genetic connexion between the two sorts of bodies. It should quite satisfy any sceptic to examine such preparations as those from which Figs. 1, 9, and 10 are drawn with all possible exactness.

The behaviour of the centrospheres with reagents warrants a distinction between the denser slightly stainable centrosome, and the enveloping, highly refractive, and as yet unstained astrosphere. The substance of both appears to be, in general, protoplasmic; but the idea of its special character has been expressed in the terms *archoplasm* and *kinoplasm*, applied to it by Boveri and Strasburger, respectively. What we know of it seems to me to point to its specific nature. Whether the centrospheres are permanent organs of the cell it is impossible to say with certainty. So far as the astrosphere is concerned, Boveri ('95) denies this for animal cells, which afford much more satisfactory material than plants. It may well be that their substance contributes more or less to the formation of the spindle or is otherwise distributed in the cell. Such a fate would readily explain the difficulty of observing them in some stages of karyokinesis in *Pellia*. And the centrosomes, as has been said, would be quite unrecognizable without the characteristic envelope of the astrosphere. Yet in *Pellia* the centrospheres are most clearly seen when the radiations about them are most distinctly developed. This hardly supports the idea of the formation of the radiations from the substance of the astrosphere. On the other hand, the astrosphere appears, in the case of *Psilotum*, to be constant in all stages; and my observations on *Osmunda* point to the same conclusion. It appears, then, that the centrospheres show no essential changes in their appearance, except when they are themselves undergoing division. If we omit the observations of Lauterborn ('98) on some Diatoms, and of Wager ('94) on a species of *Agaricus*, both of which seem to require confirmation, the structure and behaviour of the centrospheres in plants is strikingly uniform, so far as known. Judging from present knowledge, one may be warranted in believing it probable that these structures will prove to be

permanent organs of the cell, increasing only by division. The question whether the centrosome or the whole centrosphere is permanent may be left to be answered by future researches. It is easy to conceive of the production of a surplus of these organs in abnormal cases by one or more extra divisions. As to whether the supernumerary ones are disposed of by subsequent fusions or by degeneration we have no evidence. Strasburger states ('95) that spindles from nuclei originally having three or four poles in *Pellia* finally always become bipolar, and is inclined to regard fusion as more probable than degeneration.

In all plant-cells in which it has been recognized, the centrosome is a tiny, homogeneous mass, so far as present methods of study show. Heidenhain has lately ('94) based on his observations upon leucocytes and giant-cells of marrow some new and radically different views of the centrosome from those above expressed. His discussion is long and very confusing to one whose acquaintance is chiefly with the definite and characteristic centrospheres of plant-cells. But Boveri ('95) has so clearly pointed out his misuse of terms and the entire agreement of the facts observed by him, when rightly understood, with the conception of this organ underlying the earlier work of van Beneden and Boveri, which is practically that above expressed, that no further discussion of his ideas is necessary. Heidenhain has shown, however, that in some leucocytes the centrosome may be so large as not to be uniformly stained, but to show deeply-staining granules within it. And in other animals similar structural features have been observed, as, for instance, in the centrosomes of the Sea-Urchin egg, by Boveri ('95).

The question of the cytoplasmic or nuclear origin of the centrosomes, which has been considerably debated and to which a good deal of importance has been attached, becomes more and more secondary as we realize the extent to which interchange between nucleus and cytoplasm occurs, and if we regard, with Boveri, the nuclear cavity as merely a space set apart for the chromosomes. This writer has done good

service in pointing out that the question becomes interesting chiefly when asked from a phylogenetic point of view, though for a reply to it in this form we have as yet no materials whatever.

PAPERS REFERRED TO.

- BOVERI, TH., '95: Ueber das Verhalten der Centrosomen bei der Befruchtung des Seeigel-Eies, &c. Verhandl. der phys.-med. Ges. zu Würzburg, Bd. XXIX, No. 1, 1895.
- FARMER, J. BRETLAND, '93: On the nuclear division in the pollen-mother-cells of *Lilium Martagon*. Annals of Bot., Vol. vii, p. 393, 1893.
- '95: Ueber Kerntheilung in Lilium-Antheren, besonders in Bezug auf die Centrosomen-Frage. Flora, 1895, Heft 1, p. 56.
- AND REEVES, J., '94: On the occurrence of centrospheres in *Pellia epiphylla*, Nees. Annals of Bot., Vol. viii, p. 219, 1894.
- GUIGNARD, L., '91: Nouvelles Etudes sur la Fécondation, &c. Ann. Sci. Nat., Bot., Sér. VII, T. XIV, p. 163, 1891.
- '94: Sur l'origine des sphères directrices. Journ. de Bot., T. VIII, p. 241, 1894.
- HEIDENHAIN, M., '94: Neue Untersuchungen über die Centrialkörper und ihre Beziehungen zum Kern- und Zellen-protoplasma. Arch. für micr. Anat., Bd. XLIII, p. 423, 1894.
- HUMPHREY, J. E., '94: Nucleolen und Centrosomen. Ber. der deutschen Bot. Ges., Bd. XII, p. 108, 1894.
- KARSTEN, G., '94: Ueber Beziehungen der Nucleolen zu den Centrosomen bei *Psilotum triquetrum*. Ber. der deutschen Bot. Ges., Bd. XI, p. 555, 1894.
- LAUTERBORN, R., '93: Ueber Bau und Kerntheilung der Diatomeen. Verhandl. des naturh.-med. Vereins zu Heidelberg, Bd. V, p. 112, 1893.
- RAWITZ, B., '95: Centrosoma und Attractionsphäre in der ruhenden Zelle des Salamanderhodens. Arch. für micr. Anat., Bd. XLIV, p. 555, 1895.
- SCHAFFNER, J. H., '94: The nature and distribution of attraction-spheres and centrosomes in vegetable cells. Bot. Gazette, Vol. xix, p. 445, 1894.
- STRASBURGER, E., '92: Schwärmsporen, Gameten, pflanzliche Spermatozoiden, und das Wesen der Befruchtung. Histol. Beitr., Heft IV, p. 47, 1892.
- '95: Karyokinetische Probleme. Jahrb. für wiss. Bot., Bd. XXVIII, p. 151, 1895.
- WAGER, H., '94: On the presence of centrospheres in Fungi. Annals of Bot., Vol. viii, p. 321, 1894.
- ZIMMERMANN, A., '98: Ueber das Verhalten der Nucleolen während der Karyokinese. Beitr. zur Morph. und Phys. der Pflanzenzelle, Bd. II, p. 1, 1893.
- '94: Referat über HUMPHREY, '94. Bot. Centralblatt, Bd. LIX, p. 57, 1894.

EXPLANATION OF FIGURES IN PLATE XX.

Illustrating Dr. Humphrey's paper on some Constituents of the Cell.

All Figures are drawn from microtome-sections with the Abbé camera.

Figs. 1-8. From sporangia of *Osmunda regalis*.

Fig. 1. Spore-mother-cell in the resting stage, before separation. $\times 1000$.

Figs. 2-6. Successive stages in the first division of a definitive spore-mother-cell. $\times 1200$.

Fig. 7. Three young spores of a tetrad formed from a mother-cell. $\times 1200$.

Fig. 8. Division of a tapetal cell, showing dividing centrospheres. $\times 1000$.

Fig. 9. *Osmunda cinnamomea*. Young spore, after separation of tetrad. $\times 1200$.

Figs. 10-12. From root-tip of *Allium Cepa*.

Fig. 10. Cell in resting stage. $\times 1200$.

Fig. 11. Cell with dividing nucleus, at time of splitting of chromosomes; fixed with Hermann's fluid, stained with fuchsin-iodine-green. $\times 1200$.

Fig. 12. Cell with dividing nucleus, at time of migration of daughter-chromosomes to poles; fixed and stained by Hermann's method for centrospheres, showing also many stained proteid granules. $\times 1200$.



The Structure of the Thallus of *Neomeris dumetosa*, Lamour.

BY

ARTHUR H. CHURCH, B.A., B.Sc.,

Jesus College, Oxford.



With Plates **XXI**, **XXII** and **XXIII**.



OUR knowledge of the structure of the species belonging to the remarkable genus *Neomeris* is based on the account of the Madagascar species *N. Kelleri* given by Cramer¹, who describes very fully the anatomy of the full-grown plant and figures some of the earlier stages from spirit-material. Whether or not Solms-Laubach² is correct in his statement that Cramer's *N. Kelleri* is identical with his own *N. annulata*, Dickie, from Mauritius, it is generally agreed that *N. dumetosa* represents a distinct form; and this species has not yet been fully investigated owing to lack of suitable material. The older figures of Sonder³ and Agardh⁴ are very incomplete, as also are Cramer's, whose measurements are quoted in the specific description given in De Toni's Sylloge Algarum, No. 1065.

¹ Ueber die verticillirten Siphoneen. Zürich, 1887. Ibid. Part II. Zürich, 1890.

² Ann. du Jard. Buitenzorg, Vol. xi.

³ Die Algen des tropischen Australiens. Hamburg, 1871.

⁴ Till Algenes Systematik. Lund, 1887.

N. dumetosa, originally collected by Richard in the Antilles, and Harvey in the Friendly Islands, occurs also, according to Solms, in the island of Flores and New Guinea. I am indebted to Professor Vines for the opportunity of examining spirit-material of this species collected by Mr. H. N. Ridley at Singapore. The plants, Mr. Ridley informs me, grow in smooth shallow water, attached to mud or piles, and, when living, each individual looks 'very much like a little green sausage.' They reach a length of 3.5 to 4 cm., and vary from 2 to 2.5 mm. in diameter; the main axis is flexible and bears a delicately calcified upper portion, ill-adapted to withstand damage from rough water or pebbles, thus forming a striking contrast to *N. Kelleri*, Cramer, which is a densely calcified and stunted species growing, according to Keller, between coral-blocks exposed by the tides. It is possible, therefore, that *N. dumetosa* may prove a more typical species of the genus than *N. Kelleri*. Associated with the adult plants were younger specimens in all stages of growth, and in tracing the course of development evidence appears to be forthcoming to show that *N. dumetosa*, in consequence possibly of exposure to fairly constant and peaceable environment throughout its entire life, recapitulates in its ontogeny, not only its own phylogeny, but sufficient of that of the whole group of the Dasycladaceae to shed light on the relationships of the genera comprised in this remarkable order.

The history of development, in the specimens examined, falls naturally into five stages, of which the fifth constitutes the adult reproductive form.

Stage I.

The youngest plant in the material at my disposal (Fig. 1) consisted of an erect *Vaucheria*-like coenocytic filament, 5 mm. in length, attached to the substratum by a typical dichotomously-lobed basal portion, and bearing at its apex a whorl of six dichotomously-branched filaments, delimited from the main axis by perforated septa. At points further down the axis two other nodes were marked out by the presence of

circular scars representing the points of attachment of previous whorls of similar deciduous lateral appendages. In this specimen the lowest whorl of scars was 4 mm. from the rhizoid portion; but six other specimens of the same length, though slightly older and showing 4-8 whorls of scars, agreed in the position of the first scars at a distance of about 2 mm. from the base. The first whorls of filamentous appendages are formed at varying distances along the main axis; but as growth proceeds, development becomes more regular and the length attained by the internodes is fairly constant in the growing region. In the older portions, as the tubular axis increases in breadth, and the wall in thickness, the internodes are correspondingly shortened, and the zones of old scars rapidly become pulled down close to one another and finally obliterated. It is thus only in comparatively young plants, in this first stage of growth, that the first-formed whorls can be traced right down the axis, and in such cases there appeared to be a general agreement in the first whorl being formed at a distance of 1.5 to 2.5 mm. from the basal portion; and though the comparative elongation of these young specimens at first suggested that they might be merely spindly etiolated specimens, owing their poor development to their being crowded out by the more mature individuals, their close agreement in the structure of the few lower millimetres and the known effects of later increase in diameter of the main axis may fully justify the acceptance of these as normal specimens; the later apparent slowness in longitudinal extension of the thallus as a whole being due to the counterbalancing shortening of the basal internodes (Fig. 20). The first stage, therefore, marks the direct assumption of the *Dasycladus* type of thallus, and this structure is maintained for many nodes. With increasing bulk of the axis, the number of appendages in a whorl increases (12-18), while the lateral appendages themselves reach a higher degree of complexity, ultimately consisting of 3-4 times di- or trichotomizing filaments, corresponding to the 'articulated ramelli' and 'byssoid fibrils' of Harvey which occur in allied genera. The constituent segments of these

appendages are delimited by similar perforate septa, and detach, leaving circular attachment-scars similar to those found at the junction of the whole appendage with the main axis. On the upper nodes the perfect appendages form a tuft of assimilating filaments ('coma') about 2 mm. in length; but further back the basal segments of the appendages alone persist, and these also ultimately disappearing, leave only their scars of attachment, which may be traced down the axis, becoming transversely elongated and more faintly defined on the lower portions, until they can be no longer accurately followed. On a well-grown specimen in this stage (Fig. 2), 18 mm. in length, 79 zones were counted; this was the highest number observed in a plant wholly in Stage I; the upper 5 nodes being in full plumage, while basal segments of appendages remained to a greater or less extent on 23 nodes, and 51 whorls of scars could be traced back to a distance about 2 mm. from the rhizoid portion. Twelve other plants, wholly in Stage I, varying in length from 10–18 mm., possessed 27–79 whorls of scars or else nodes with segments still attached. Thus an average specimen, 13 mm. long, would have attained to 40 whorls. Specimens passing on to Stage II in the apical region, as a rule, showed scanty traces of any basal segments of appendages belonging to Stage I attached to the lower part of the axis, and the number of whorls of the first type of appendage possibly varies considerably; thus, one plant, 15 mm. long, passed on to Stage II at the 55th node; another, 11 mm. long, at the 40th, while a specimen figured (Fig. 10), with 23 apical whorls more or less in Stage II, showed over 80 whorls of scars to within .5 mm. of the base. Again, reversion to Type I occurs very generally in the early development of Stage II (Fig. 10 *b*). Branching of the main axis occurs commonly in the basal portion below the first whorl of scars, abortive branches or outgrowths being found on half the young specimens examined. In some cases, such a branch led to definite development (Fig. 5); while indications of the possibility of a formation of new individuals from stolon-like outgrowths,

which assist in the work of attachment, were also met with (Fig. 5 *a*). No creeping rhizome-filaments were observed, nor any formation of a special food-containing reservoir, as described in *Acetabularia*; but the storage of starch, in the form of large grains, throughout the whole of the rhizoid portion, was often very marked (Fig. 6). Once the thallus has assumed the whorled type of growth, branching of the main axis only occurs as an anomaly (Fig. 8); but in one specimen branching into two equal individuals occurred just above the first formation of the appendages of Stage II, and before it had become permanently fixed (Fig. 4). No case of branching was met with beyond Stage II, and this is perhaps important in reference to the branching of the main axis in *Cympolia*. Rejuvenescence of an axis on damage to the growing-point, and outgrowths due to wounds, may commonly occur; the contrast between the distant nodes of the young shoot and the shortened internodes of the old axis being especially well marked in such a case (Fig. 3).

Stage II.

As already indicated, the nodes now tend to be formed closer together, and the whorls of members become more regular in development. The characteristic feature of this stage is the delimitation of a basal portion from the basal segment of the appendage by means of a typical perforated septum formed as a ring-wall in the segment; the portion abstricted roughly equalling in length an internode of the main axis (Fig. 10 *a*). This takes place with great regularity and symmetry in all the new whorls, and these abstricted portions, on disarticulation of the remainder of the appendage to which they belong, persist as more or less complete whorls of short segments; every segment retaining at its distal end a single scar, and thus presenting a marked contrast to the long basal segments of Stage I, which exhibit at their extremities the two scars of the first dichotomy (Fig. 7). The 3-4-times dichotomizing appendage, which now appears to be borne at the end of this second type of basal segment,

presents no peculiarity beyond a further increase in the length of its segments. Only the upper whorls of the plant possess undamaged appendages; those further back retain for a considerable period the short basal portions of Stage II, but present few traces if any of Stage I. The base of the main axis is now becoming considerably thickened by internal apposition of layers; wear and tear of the outermost layers which alone were perforated at the older scars, together with alterations in volume of the main tube, soon lead to obliteration of the first-formed scars, and in this and further stages, as a rule, no traces of earlier formations remain.

This second type of lateral appendage also obtains for many nodes; thus, 4 specimens averaging 16 mm. in length, and showing traces of Type I attached to a lower whorl of scars, while the apex was passing on to Stage III, gave evidences of the second type of formation on 28–46 nodes; the average being 37. Again, 11 specimens, 10–19 mm. in length, in which the apical whorls were passing on to Stage III, but in which no trace of Stage I remained, showed relics of basal segments of the second type on 28–84 nodes. Thus, an average plant, 15.5 mm. in length, would have laid down 50 whorls of appendages of the form characteristic of Stage II.

Stage III.

The short basal portions, formed, as shown, by abstriction from the elongated basal segments of Stage I, remain fairly constant for Stage II (Fig. 11); but, in later-formed whorls, they exhibit a tendency to dilate, especially on the acroscopic surface (Fig. 12), and thus soon come into lateral contact with their neighbours. This dilatation may increase by degrees over several internodes, or may be so hastened that the transition is complete in passing from one whorl to the next; the ultimate result being the formation of a 'cortex' of bladder-like basal segments, completely hiding the main axis, and appearing externally as a faceted layer, of which the component units are pressed into close lateral contact,

without any pronounced adhesion of cell-membranes (Figs. 12, 14, 16). The contrast between the branched 'assimilating filament' and its expanded basal segment is now very marked, and the terminal portions henceforth assume the appearance of mere hair-like appendages; but it must be carefully noted that their morphological value will remain unaffected. When these terminal portions become detached, the axis remains clothed by a pseudo-parenchymatous one-layered cortex (Fig. 14), the constituent members of which differentiate into pedicelled vesicles, and exhibit a single scar as in Stage II (Figs. 14, 16). In the older parts of the axis, they again become isolated, and gradually fall away, leaving as in previous stages their whorled attachment-scars on the main axis (Fig. 13). Cases of reversion to Stage II frequently occur; very generally, a dozen or more whorls of the second type may be intercalated after 12-20 whorls of Type III; but reversion becomes rarer once the type has become long established.

A median longitudinal section of the apex at this period shows that the structure, attained by the plant after an average of 100 nodes, is recapitulated in about 5 nodes at the actual growing-point (Fig. 15); thus, delimitation of the basal portion, characteristic of Stage II, occurs in the third whorl behind the apex of the main axis; the dilatation of the lower segments results in lateral contact being complete at the fifth node; and in a few more internodes the form characteristic of Stage III is attained (Fig. 16).

As examples of the extent to which Stage III is retained in the life-history, the following may be taken: one specimen, possessing traces of Stage II on 25 whorls of scars, afterwards developed 98 whorls of Stage III; the apex still continuing the formation. This was the highest number observed. On the other hand, 11 specimens, retaining traces of Stage II on the lower scars, while the apical whorls were in Stage IV, and whose length varied from 14-19 mm., showed 7-77 whorls of Type III. Thus, an average plant might have formed 43 whorls of Stage III and be passing on to the

next stage and yet be only 15 mm. in length, owing to the compensating contraction of the lower part of the main axis.

Stage IV.

A transition now takes place to a more elaborate type of cortex. The passage is sudden, and, as a rule, complete in all the members of a single whorl, though occasionally mixed whorls may be found (Fig. 22).

Instead of a basal portion of the lowest segment of the lateral appendage dilating to form a cortical facet, and bearing the rest of the segment and further ramifications as an assimilating filament, the whole basal segment forms a pedicel supporting the segments of the first dichotomy, and it is the lower portions of these segments of secondary order which now become swollen vesicles and repeat the cortex-formation (Figs. 17, 18, 21). The cortex has therefore, as it were, moved one degree outwards. The basal segments have again a characteristic appearance (Fig. 19), being short with two strongly pronounced distal scars, and as before they may persist on the main axis long after the loss of the cortical dilatations.

Reversion is general at first. For example, in a well-developed young plant (Fig. 17), Stage IV was initiated after formation of 42 whorls of Stage III; but, after 4 whorls of the new type had been laid down, a reversion to Stage III occurred for 3 nodes; Stage IV being afterwards resumed and its whorls maintained in unbroken succession.

As the branching of the first dichotomy takes place in a horizontal plane, contrary to the method observed by Cramer in *N. Kelléri*, the new cortical whorls will exhibit twice the number of facets on the surface of the thallus in transverse section. If these are to be of equal size to those of Stage III, longer pedicels will be required, and the diameter of the thallus will thus be increased. Transitions from one stage to the other will therefore result in the production of a more or less moniliform appearance (Fig. 17); and this again is a foreshadowing of what becomes in *Cympolia* the

normal structure. A section of the growing-point at this period (Fig. 18) shows the origin of this new type of appendage to be due to a precocity of development of the first dichotomy of the member, accompanied by a laying down of septa above, instead of below, the first point of bifurcation; all earlier stages, therefore, cease to be recapitulated, the third node from the apex is already unmistakably Stage IV, and the growing-point henceforth lays down only appendages of this new and improved pattern. In the nearest approach to the actual transition obtainable in the neighbourhood of the apex (Fig. 18), the junction of the secondary segments to form a continuous cortical layer was just completed in the 9th node behind the apex. The number of members in a single whorl now reaches 16-22, and this number steadily increases with increasing bulk of the plant.

Stage IV may be regarded as the adult sterile condition; its formation may be continued over 200-300 nodes, the main axis slowly increasing in length to 25-30 mm. Compensating contraction of the older internodes still proceeds, and, in an older plant of this stage, the two-scarred basal segments may be traced almost to the base of the plant. Before being entirely obliterated, the whorls of old scars become pulled down so close together that it often becomes difficult to isolate the scars of one particular node; at the same time, the individual scars become greatly elongated transversely to eye-like markings, while the cellulose plug which closes the septum retains its sharp contour to the last (Fig. 20). Reversion to a previous type of appendage on a large scale occasionally happens, but only in one case was a considerable interpolation of Stage II observed. Such phenomena may possibly be the result of injury to the growing-point, and in these cases the thallus will appear markedly constricted. Similar non-calcified constrictions have been described by Cramer in *N. Kelleri*, and these again present suggestions of the normal structure of *Cympolia*.

Calcification of the lateral appendages sets in after formation of a number of whorls of Stage IV, which may reach

to 100–200, but varies considerably in different specimens. The apex does not calcify, the first trace of deposit being found at about the tenth node from the growing-point. The whole of the surfaces bounding the cavities beneath the cortical layer are incrustated, the maximum deposit forming a layer beneath the dilated ends of the cortical segments, perforated only by the pedicel portions. The deposit appears as an extremely fine precipitate of calcium carbonate in a mucilaginous outer layer of the cell-membrane (Fig. 21), but further details may be left for consideration in connexion with the calcification of the mature thallus.

Stage V.

As already shown, the plant vegetates for a considerable period in Stage IV, increasing steadily in length, diameter of the main axis, and number of appendages in a single whorl (Figs. 28, 29); these last being 30–32 in the mature plant. The new epoch is inaugurated by the appearance of the reproductive organs as new and special formations. These arise as outgrowths of the basal segments in the angle of the first dichotomy of the appendage, that is to say, in the angle between the cortical segments (Figs. 32, 33). Appearing first at the 6th node from the apex in the form of a papilla-like projection at the extreme distal end of the basal segments, they soon develop into spherical stalked structures, and are delimited from the rest of the lateral member by the characteristic ring-septum. They possess abundant protoplasmic contents and chlorophyll, and rapidly calcify. At about the 60th node from the apex they are plugged off by a cellulose stopper (Fig. 31). The contents round off, and secrete a new cellulose membrane which fits closely the spherical terminal portion of the structure¹ (Fig. 27). Although further development is unknown, there can be little doubt that we have here to deal with an aplanosporangium containing a single aplanospore. The formation

¹ Cramer, loc. cit., p. 31; Solms, loc. cit., p. 64.

of aplanosporangia is common to the whole of the Dasycladaceae with the exception of *Dasycladus claviformis*, in which Berthold¹ has described the direct development of gametangia, and also *Cympolia*, which, according to Cramer, appears to follow *Neomeris*, but no specimens were observed in which the sporangia had developed sufficiently far to be plugged off from the segments bearing them, while the interesting observations of Solms² on a case of apospory await further confirmation. The essential point to notice in *Neomeris*, however, is that we have here, side by side with a high degree of differentiation in the vegetative thallus, a presumably higher type of reproductive organ; since the aplanosporangia which in *Acetabularia*, for example, are morphologically equivalent to one segment, or possibly a whole appendage, and give rise to many aplanospores, here arise as special and later outgrowths on the appendages, and are restricted to the production of a single aplanospore³.

Only the upper portion of the adult plant possesses the full appendage of Stage V (Fig. 23) as a thrice di-trichotomizing member, of which the lower segments are highly differentiated, while the ultimate ramifications remain delicately filamentous. Further back the calcified cortical segments break away, leaving the incrustated basal segments, bearing the aplanosporangia, exposed to view; on the loss of these latter, the basal segments remain as three-scarred structures (Fig. 25), and may persist for a considerable period, though soon undergoing decalcification. Starch is generally distributed throughout the plant, the aplanosporangia being filled with large grains. Inulin also occurs in the form of small irregular

¹ Bot. Zeit. p. 648, 1880.

² Loc. cit., p. 74.

³ In describing the reproductive organs of *Neomeris*, I have so far used the words 'aplanosporangium' and 'aplanospore' as being generally accepted terms. But while there is no need to fully discuss here the question of the alternation of generations occurring in the life-history of these forms, it must not be overlooked that, as Bower has pointed out (*Annals of Botany*, vol. iv, p. 356), all these plants are really *sexual* forms, i. e. gametophytes. No progress can be made toward a conception of the phylogeny of the group until it is clearly understood that the vegetative thallus of all the genera of the Dasycladaceae is directly homologous with that of *Dasycladus* itself and the other admittedly sexual Siphonaceae (see p. 598).

sphere-crystals, and is especially noticeable in the cortical segments of Stage IV. Calcification becomes more pronounced, and is remarkable for its limitation to definite areas (Fig. 24); but it never reaches the massive incrustation of *N. Kelleri*. The layer beneath the dilated ends of the cortical segments becomes much thickened and forms a continuous calcareous jacket, perforated by the slender non-calcified pedicel-portions of the cortical segments; a small deposit is laid down on the basal segments; the main axis, growing-point, surface of the thallus, and filamentous portions of the appendages do not incrust; but the aplanosporangia are densely coated to a distance more than half-way down their pedicels (Figs. 24, 30).

Relation of N. dumetosa to the rest of the Dasycladaceae.

From the observations above recorded on the youngest plants available, it may be reasonably concluded that *N. dumetosa* commences its life-cycle as an organism presenting the appearance of a *Vaucheria*; that is to say, a coenocytic filament without transverse septa, possessing a dichotomously-lobed rhizoid portion, and exhibiting a general tendency to form branches at right angles to the main axis and equal to it in diameter. This continues only for a length of two or three millimetres, when the whorled *Dasycladus* type is suddenly assumed. A similar filamentous stage has been shown by De Bary to occur in *Acetabularia mediterranea*; *N. dumetosa*, however, is more precocious in development than this *Acetabularia*, which reaches a length of over 20 mm. before growing the first whorl of appendages, and thus agrees with the youngest stage observed in *N. annulata* by Solms-Laubach.

After the definite assumption of the whorled type of growth, the study of the development of *N. dumetosa* resolves itself into a question of the variation in form, number, and composition of certain lateral appendages.

Reviewing the different stages of growth, I think it will be

readily granted that the primary type of Dasycladean appendage is the polytomizing coenocytic filament, with constriction or incomplete septation at the points of origin and ramification. This again is morphologically of foliar nature, the whorled lateral appendages of *Dasycladus* itself being regarded by Nageli as definite leaves: specialization of the appendage as a distinct foliar member is indicated, not so much by its limited growth, as by its being endowed with a certain partial individuality which ultimately finds anatomical expression in the formation of perforated septa. Such septa never occur at the points of ramification of the main axis, and in the 'leaves' they are correlated with a deciduous habit. That the leaf repeats in its own ramification the same whorled type which obtains in the main axis, though in an abbreviated form, does invalidate its foliar nature; the essential point to notice being that here also the secondary segments arise as simultaneous whorls.

The archetype of the Dasycladaceae may therefore be conceived to have consisted of a main axis bearing whorls of several times polytomizing foliar appendages; and these, after functioning as assimilating leaves, possibly became wholly converted into gametangia, after the manner of such a recent type as *Bryopsis*. The nearest approach to such a form of reproduction, within the limits of the Dasycladaceae, occurs in *Dasycladus clavaeformis*, in which, according to Berthold, the whole protoplasmic contents, when the reproductive stage is attained, stream into the specially formed gametangia. The first stage in the development of *N. dumetosa* may be regarded therefore as a recapitulation of the primitive 'Proto-*Dasycladus*' type of thallus. The same stage occurs in the life-history of *Acetabularia*, in which plant the polytomizing filament may be seen at its best development, and in *Polyphysa* (Agardh, Cramer, Solms) and *Halicoryne* (Cramer, Solms); while it persists as the adult condition in *Botryophora occidentalis* Agardh, *Chlorocladus australasicus* Sonder, and *Eudasycladus clavaeformis*. Of these last, *Botryophora* approaches most nearly the earlier condition of the type in its

elongated internodes and long wavy segments; *Chlorocladus* with a terminal 'coma' recalls the later type of Stage I (Fig. 2); but on the other hand, while retaining a primitive type of thallus, all three of these genera have specialized their reproductive organs, and these arise as new outgrowths from the leaf, borne either laterally or in the angle of its ramification. In the latter case, owing to their contents being delimited by septa similar to those as the points of ramification of the leaf, they have often been described as leaf-segments. *Dasycladus clavaeformis* alone retains a definite gametangium, the others attain to the so-called aplanosporangia.

Exceptional cases of branching of the main axis to form two equal individuals, previously noted for Stages I and II of *N. dumetosa*, find a parallel in similar examples in *Acetabularia mediterranea*¹, *Botryophora occidentalis*², and they may also be observed in *Dasycladus clavaeformis*.

The meaning of the delimitation of a special basal segment in Stage II, is at first sight not clear; it can scarcely be a mechanical necessity, nor can it be regarded as purely transitional to the cortex-formation of Stage III. The fact that the type is retained in a high state of perfection for as high an average number of whorls as is the case in Stage I or Stage III, may be taken perhaps as an indication of its importance at some period in the life-history of the group. Perhaps a reasonable working hypothesis is that we have here the first step in the specialization of the 'leaf' into assimilating and reproductive portions, and that the basal portion represents the primary gametangium for the Dasycladaceae, with the exception of the three previously noticed *Dasycladus* types which have specialized their reproductive organs as new outgrowths on a thallus which is structurally in Stage I. There is no difficulty in conceiving such a *Dasycladus* type in which the protoplasm of the leaves, on reaching the reproductive stage, streamed down to the lower portion of the basal segments and there cut itself off by a septum; after

¹ Woronin, Ann. Sci. Nat. 1862.

² Cramer, I. loc. cit., Taf. V, 21.

the fall of the filamentous portion, the whorl of gametangia would then persist on the main axis much as in the older stages of Stage II. This second type of leaf occurs again in the adult plant of *Cympolia barbata*, where according to Cramer¹, the non-calcified whorls of the nodal portions of the axis are of this type, and, when first formed, bear the full filamentous terminal portion.

Again, the remarkably symmetrical habit of one of these whorls of short members suggests nothing so strongly, at first sight, as the cap of *Acetabularia*. The publication of Solms-Laubach's important monograph of the Acetabulariaceae², just as the present paper is being completed, enables me to compare the hypothesis now put forward with the results obtained for these highly aberrant types of Dasycladaceae. Solms-Laubach concludes, from a careful comparison of species of *Polyphysa* and *Acetabularia*, that the ray-segments of *Acetabularia mediterranea* are to be regarded as, not so much a whorl of lateral appendages, as a development of lateral sporangia on the sides of appendages which have become extremely reduced and distorted, and he presents a series of types in support of his opinion; but the older view of the morphological value of the cap of *A. mediterranea* seems so simple in comparison with the new one, that until the former has been definitely proved to be impossible, it will doubtless retain adherents. Again, Solms points out the difference between the *Acetabulum* section comprising *A. mediterranea* alone, and the *Acetabuloides* section, and here perhaps the possibility is not excluded, that, granting that the cap-type of thallus represents a form which has proved itself a success in relation to special environment, a cap may have been evolved at different points in the phylogeny of the group, and that these may resemble each other by convergence of type. Thus, according to the older view, the formation of a cap-whorl in *A. mediterranea* seems to be accompanied by a telescoping of the main axis in the neigh-

¹ I. loc. cit., Taf. IV, Fig. 4.

² Trans. Linn. Soc., Vol. v, I.

bourhood of the cap, and the superior and inferior coronae may be regarded as belonging to the main axis rather than to the cap-rays. The marked radial arrangement of the scars on the *corona superior* of *A. mediterranea* seem to point definitely to such a correlation, and we have in addition the general habit and external form which in a coenocytic plant may be considered of some importance. Solms-Laubach bases his view on the presence of a certain septum formed within the apparent attachment of the coronae to the cap-rays; it may, on the other hand, be objected that it has not been shown that this septum is of primary morphological significance, and that it necessarily implies the point of origin of an appendage. Whether *A. mediterranea* may be regarded as representing a survival of a highly specialized and aberrant form of Stage I or Stage II, or not, thus correlating the cap-rays with the basal portions of appendages or whole appendages reduced to a single segment, it is only important to point out here that *Acetabularia* must have diverged from the *Proto-Dasycladus* type at some point, and that in searching for this point the capacities for variation of the normal Dasycladean appendage must first be exhausted.

Again, the fact that the swollen cortical segments of Stage III can neither subserve protection nor support, since they neither enclose the apex, nor persist on the lower portions of the axis, suggests that this stage marks a tendency to compact aggregation of the reproductive organs which are being developed from the specialized basal segments which now increase in bulk, bulge out especially on their basiscopic side, and thus tend to expose the maximum surface in a plane at right angles to the incident light (Fig. 16). A similar type of appendage occurs, according to Solms-Laubach¹, in the life-history of *Cympolia van Bossei*; while it is also probable that the fertile appendages of *Halicoryne Wrightii* may be placed here. The legume-like aplanosporangia of this species were described by Agardh rather incompletely, but such

¹ *Annales Jard. Buitenzorg*, xi, Plate VIII.

a correlation would be further supported by the discovery by Solms¹ and Cramer² that these each possess in the young condition 'solitary dichotomously branched hairs' placed laterally. The peculiar aberrant form may be regarded as a further development of the tendency to bulge on the basiscopic side. The most remarkable feature, however, in *Halicoryne Wrightii* is the late formation in the fertile segments of a new septum delimiting the reproductive 'pod' from a pedicel-portion. This small detail, described by Agardh and confirmed by Solms-Laubach³, is the first definite indication of a point of extreme importance. We have here the late formation of a secondary septum for the obvious physiological purpose of delimiting the reproductive coenocytic mass of protoplasm; that is to say, the Dasycladaceae may form septa of two kinds: first, those which occur in connexion with the assimilatory processes; secondly, those formed in correlation with the necessity for the isolation of the developing gametes. The septa of the first order indicate a high degree of specialization of the leaf as an assimilatory organ; the septum, by preventing extensive streaming movements of the protoplasm, under the stimulation of external agencies, provides for an even distribution of protoplasm and chlorophyll-corpuscles in the assimilating segments; at the same time allowing free conduction and transfer of substances in solution in the cell-sap by the open pore. When the protoplasm of the segment has reached the end of its assimilatory activity, the pore is closed and that segment falls off. In the same way, the delimitation of the gametangium by a septum isolates the contained protoplasm, but allows free entrance by the pore to reserve carbohydrates, &c.; when the supply is complete, the pore is plugged by a cellulose stopper. But it must be noted, that while septa of the first kind, by being fortunately placed at the points of ramification of the leaves, afford valuable landmarks in determining the comparative morphology of segments, the

¹ Monograph, Plate IV, Fig. 5.² *Ibid.* p. 39.³ Monograph, p. 30.

septa of the second order, owing to the fact that the gametangia are not constant in position, do not necessarily possess an equal significance; that is to say, a septum does not necessarily imply a point of ramification or even origin of a leaf when reproductive processes are concerned. This again not only explains how it is that the special 'sporangial' outgrowths of *Neomeris*, for example, have been described as 'terminal branches,' and lends support to the hypothesis put forward in explanation of Stage II, as also further suggesting that the septum used as a landmark by Solms-Laubach in *A. mediterranea* may be a special formation in connexion with the high degree of specialization of the cap as a reproductive organ; but it leads on to the solution of the difficulty which seems to exist as to the real nature of the so-called 'aplanospores.' In these plants, it must be clearly understood, we are dealing not with cells, but with coenocytic masses of protoplasm. The special coenocytic masses which are entering on a reproductive phase, delimit themselves from the rest of the plant by a formation of membrane giving rise to a special gametangium, utilizing for the purpose at least some part of the original membrane of the vegetative thallus. This coenocytic mass in the majority of the recent genera undergoes further partition; but the smaller coenocytic aggregates, instead of utilizing part of the membrane of the gametangium for their own investment, as in the segmentation of cellular tissue, form complete new membranes individually, and thus effectually isolate themselves. The so-called 'aplanosporangium' therefore is to be regarded, not as a spore-producing organ, but as a multilocular gametangium, of which the 'aplanospores' are the component loculi lying free inside the original membrane. The formation of solitary 'aplanospores,' as in *N. dumetosa*, represents, then, the retention of the latter mode of formation, only a single loculus being however developed, and points to a descent from a type in which numerous distinct loculi ('aplanospores') were developed. In the single 'aplanospore' therefore we have the highest type of gametangium attained in the *Dasy-*

cladaceae. That such a mode of formation of a multilocular gametangium is of biological significance, in allowing for the dispersal of these isolated gametangia in the resting condition, is quite conceivable, and the interpolation of this phase in the life-history must be regarded as a phenomenon of adaptation to environment, and in no way interfering with the sexual character of the parent plant. The peculiar phenomenon already mentioned as having been observed by Solms in the germination of *Cympolia* gametangia must hence be included under the head, not of apospory, but of apogamy.

Returning to the consideration of *N. dumetosa*, it has already been observed that the transition from Stage III to Stage IV is startlingly sudden, and henceforth there is no apical recapitulation of previous stages. It is also to be noted that the cortical segments are again, not the second leaf-segments, but basal portions of these segments, as if the plan of structure which was worked out in the first segments had now been transferred bodily to the next further out. Possibly there is a gap in the record at this point; at any rate, the immediate result of the arrangement, on the foregoing view of the nature of the reproductive organs, would be a doubling of the reproductive segments. Such a type in which the basiscopic cortical segment becomes reproductive, while the acroscopic remains sterile, thus combining in a single whorl the alternation characteristic of *Halicoryne*, is suggested even more strongly by Solms-Laubach's figure of *Polyphysa peniculus*¹, than the older drawings of Agardh and Cramer; the sterile segment bearing a true whorl of three filaments. If Solms-Laubach's view is correct, the *Acetabuloides* section may possibly be connected to the main series at this point, and may lead on ultimately to the *Acetabulum* type. I am however content to leave the discussion of the phylogeny of these types in the more competent hands of Graf zu Solms-Laubach, merely pointing out, as already indicated, the care required in dealing with septa as morphological landmarks. Thus, the septa which Solms-Laubach describes as cutting off the vestibules of

¹ Monograph, Plate II, Fig. 2.

Acetabularia crenulata are undoubtedly secondary, and this leads to the suggestion that the other septum below the coronae may possibly represent the formation of a special septum for the purpose of smoothly detaching the reproductive rays, at some earlier stage in the phylogeny.

The fifth type of leaf closes the series ; other genera at this point, owing possibly to the greater capacity for protection in the cavities of the thallus, follow the plan of the simpler genera of the *Dasycladus* group, and originate the gametangium as a new outgrowth, either laterally as in *Bornetella*, or in the angle of ramification of the first dichotomy (*Neomeris*) or polytomy (*Cympolia*). This again may be regarded as a transition to a 'paraphysial type,' in which protection is afforded to the reproductive organs while in the early stages of development. At any rate, this is probably the function of the cortical layer in *Neomeris* ; thus the gametangia are developed later, and when they are ready for dispersal, the calcified layer, either from contraction of the older internodes, or decalcification of its now non-assimilating members, becomes worn away and exposes them freely.

Finally, *N. dumetosa* suggests the lines along which differentiation has taken place in *N. Kelleri* and *Cympolia*. The calcification *en masse* of the latter is due, as Solms points out, to the fusion of the mucilaginous layers in the internal cavities of the thallus ; while similar calcification of groups of adjacent gametangia in *N. Kelleri* into block-masses, so excludes light from the basal segments that they soon cease accumulating calcium carbonate. The tendency of *N. dumetosa* to reversion to a lower order of leaf is carried still further in *Cympolia* : cases in which *N. dumetosa* tended to revert after a dozen whorls or so have already been described ; *C. barbata*, according to Cramer, reverts after 4-16 whorls of Stage V right back to 5-10 whorls of Stage II. Such extensive reversion was observed in one specimen only of *N. dumetosa* ; the reversion and dichotomous branching at this stage, noticed as exceptions in the case of *N. dumetosa*, thus becoming the normal condition in *Cympolia barbata*.

Whether the preceding hypotheses as to the evolution of the leaf and gametangium of the Dasycladaceae will hold or not, I think it remains sufficiently clear that the subdivision of the Dasycladaceae into the two sub-tribes Acetabulariaceae and Dasycladeae, originally proposed by Hauck and followed by Cramer and Wille, may prove too artificial. Agardh alone has insisted on the morphological identity of the Dasycladean appendage, though his conception was that the most reduced leaf was the highest type, and thus he headed the series with *Acetabularia*. At any rate, as I have already pointed out, this is the line which primarily demands exploration, the old distinction between 'fertile leaf' and 'sterile hair' resting on an unsatisfactory basis.

The phylogeny of the group as thus indicated may be expressed in such a form as the following :—

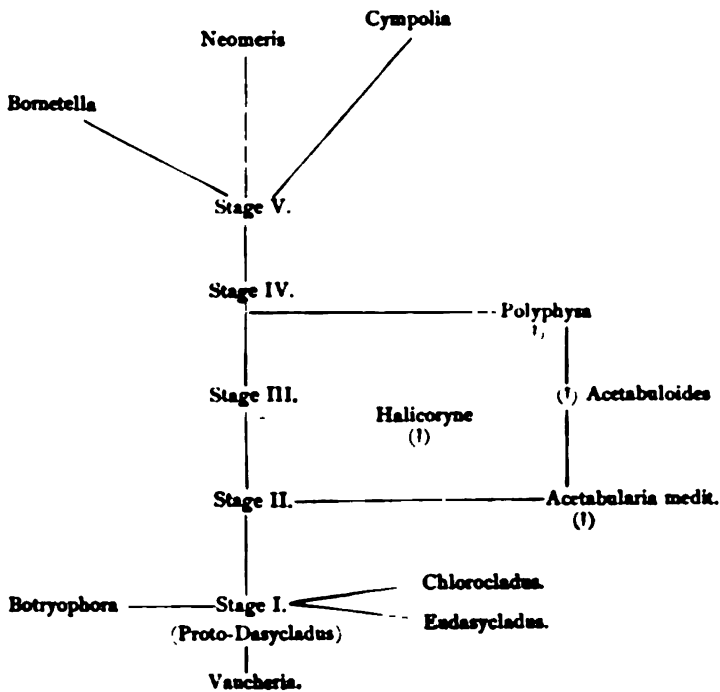

Note on the Calcification of N. dumetosa.

A comparison of sections of the calcified and decalcified thallus leads to the conclusion that the deposit of calcium carbonate is closely connected with two phenomena: the presence or absence of, first, an external mucilaginous layer on the cellulose membrane, secondly of chlorophyll-corpules (Fig. 26); and, in fact, that it is abundant on segments where both occur, but absent if either is for some reason wanting.

The growing apex of the main axis is covered by striated layers of clear hyaline mucilage, and the thick mucilaginous sheaths of the developing appendages of the upper half-dozen whorls form a series of striated layers filling the cavity of what may be termed the apical bud. This apical bud is formed by the inarching of about 16 whorls of appendages, and on the whole surface of these the mucilaginous layer is well marked; but, as soon as the filamentous portions spread out in the water, the thin mucilage is dissipated and no trace of it remains, either on the filaments or on the outer surface of the cortical facets. On the other hand, it persists unaffected lining the internal cavities of the thallus, beneath the cortical system, and it is only in this situation that any incrustation takes place. Even here, however, the pedicels of the cortical segments, as also of the aplanosporangia, which possess mucilaginous layers, do not calcify in the adult plant, although it has been shown that they were slightly incrustated in Stage IV (Fig. 21).

Again, with the first formation of a cortex, as in Stage III, the chlorophyll-corpules, at first evenly distributed throughout the plant, will tend to leave the pedicel-portions of the cortical segments and accumulate in the dilated, almost peltate, facets. In fact, it is possible that this very differentiation in form of the basal segment was induced by the assimilatory requirements of the member. In the cortex of Stages IV and V this centrifugal migration will be still more pronounced; the main axis will contain relatively fewer; the basal segments few, and these exhibiting a tendency to

collect at the distal ends of the segments, and the elongated pedicels of the cortical segments as also those of the aplanosporangia will be practically devoid of corpuscles; while, on the other hand, the dilated cortical facets and the spherical aplanosporangia will appear furnished with a dense layer (Fig. 26).

Nor will streaming movements of the protoplasm, entraining the corpuscles, bring about any great change in their distribution. The perforated septum being concave towards the cavity of each segment, revolution will take place around rather than through the pore; hence, although the corpuscles may accumulate at the distal ends of the basal segments (Fig. 26), few will pass on into the pedicels of the cortical segments; and for the same reason, the narrower the pedicels become, and the more spherical the cortical facets and aplanosporangia, the fewer corpuscles will pass inwards. Exact demonstration of the behaviour of the chlorophyll-corpuscles is of course out of the question with spirit-material; but the observations of De Bary and Strasburger¹ on the aggregation of the chloroplasts in young non-calcified plants of *Acetabularia*, due to their extreme sensitiveness to direct sunlight, lend support to the view that extensive movements of the corpuscles may take place in the cortical facets, without leading to any considerable migration into the pedicels. Hence the absence of incrustation on the pedicels is to be correlated with a diminution in the number of contained chlorophyll-corpuscles; and though a slight incrustation was laid down on the short broad pedicels of Stage IV (Fig. 21), as these become narrow and elongated in Stage V, the absence of corpuscles will result in an entire absence of calcification (Figs. 26, 30). On the other hand, the abundant supply of chlorophyll in the cortical facets does not lead to calcification of the outer surface of the thallus, owing to the lack of a mucilaginous layer in this locality.

The mechanism of calcification, so far then, admits of ready

explanation: in direct relation to the energy of the assimilatory processes going on in the chlorophyll-carpuscles, a precipitation of calcium carbonate is formed in the surrounding medium; that part of it which deposits in the mucilaginous sheath will be 'fixed,' the rest will be washed away; further deposition takes place uniformly throughout the mucilaginous layer, and calcification becomes more and more intensified in direct proportion to the activity of the chlorophyll-carpuscles in the immediate vicinity. A suggestion that the maximum precipitation is not utilized in *Neomeris dumetosa* owing to scanty development of the mucilaginous layers, is afforded by the observation that calcification extends down the pedicels of the aplanosporangia to about a distance equal to nearly twice the thickness of the deposit over the spherical portion (Fig. 30, 31); and this, again, agrees with the phenomena described by Cramer¹ for *Cympolia*, the young parts of which are endowed with a copious mucilage. That the apex and upper twenty whorls or so show scarcely any trace of deposit in their mucilaginous sheaths may be due to the rate of growth being greater than the rate of deposition; but, more probably, it is to be explained by the assimilatory processes being less energetic in the growing whorls than the respiratory, so that, even were a deposit formed, the parts would tend to decalcify owing to excess of carbonic acid in the neighbourhood. It is not so easy, however, to suggest why calcification should not set in until Stage IV is well advanced. Precipitation will vary with the amount of calcium in the water, the intensity of the light, and the assimilatory activity of the chlorophyll-carpuscles in the segments; but, as the plants are colonial, and the clumps contain specimens in all stages of growth, the first two factors will be fairly constant, and it can only be concluded that it is at this stage that the intensity of chlorophyll-assimilation first becomes sufficient to destroy the equilibrium of the solution of calcium bicarbonate. It is interesting to compare De Bary and Strasburger's observations

¹ Loc. cit., p. 19.

on *Acetabularia mediterranea*; here the young plant commenced calcification before it became attached to the substratum, and they suggest that a highly calcareous substratum is requisite for normal development. In view of the far greater deposit of lime in this species, it is evident that this must be the case, unless the energy of assimilation is correspondingly enormously increased.

Finally, with regard to the mechanism of precipitation, it cannot be claimed that the case of *Neomeris* presents a solution of the problem. Pringsheim¹ has shown that a localization of calcification in species of *Nitella* is to be explained by local variations in the intensity of chlorophyll-assimilation; and he regarded all phenomena of incrustation as being due solely to abstraction of carbonic acid from the surrounding medium containing calcium bicarbonate in solution, and consequent precipitation of carbonate on the surface of the plant. That water-plants can live healthily in such a solution, and can obtain carbonic acid for assimilation by decomposing the bicarbonate, and that the carbonate is precipitated on their surface, has been conclusively shown by Hassack²; but only in a few cases did he succeed in obtaining a permanent incrustation, and hence falls back on the suggestion that there must be some peculiarity in the membrane of plants which normally calcify. Hassack, however, endeavours to show for *Chara foetida*, that the deposition may be referred to a precipitation of calcium carbonate outside the plant in consequence of the excretion of an alkaline carbonate, formed as a waste product in the assimilatory processes; and Schimper³ points out that such precipitation would present an analogy to the neutralization of acid potassium oxalate in the formation of secondary calcium oxalate.

The chief difficulty with regard to such an hypothesis for all calcification is, as Pringsheim suggested, the explanation of the extremely localized deposit. It is not easy to see why an alkaline carbonate should be excreted in the immediate

¹ Jahrbücher, vol. xix, p. 138.

² Untersuchungen, Tübingen, III, p. 465.

³ Flora, 1890, p. 239.

vicinity of the chlorophyll-corpuses, as soon as formed, rather than tend to accumulate first in the cell-sap. Nor is the analogy with the case of secondary oxalate formation a strict one, since in this case the injurious acid oxalate is neutralized inside the cell, and the harmless calcium salt excreted. Further, Loew¹ suggests that the observations of Klebs and Hassack on the formation of alkaline carbonate may be vitiated by peculiar reactions of the colour-test employed. It is evident that, in *Neomeris*, the precipitation takes place outside the membrane, and either hypothesis might account for its formation, but it may be pointed out that, even if precipitation be entirely ascribed to the excretion of an alkaline carbonate which still remains hypothetical, the withdrawal of carbonic acid from the surrounding medium will still play an important part in maintaining the incrustation. For, living in shallow water, it is evident that the free carbonic acid present in the medium, which tends to decalcify the calcareous substratum, would also tend to decalcify the incrustated plant; and it has already been shown that the older segments decalcify as their assimilatory activity ceases, and before they become finally detached from the main axis.

¹ Flora, 1893, p. 419.

EXPLANATION OF FIGURES IN PLATES XXI, XXII, AND XXIII.

Illustrating Mr. Church's paper on *Neomeris*.

PLATE XXI.

Fig. 9. Natural size.

Figs. 7 and 15 Zeiss 3 D., all the others Zeiss 3 A. Figs. 1-8 reduced $\frac{1}{2}$.
Figs. 10-16 reduced $\frac{3}{4}$.

Fig. 1. Young plant of *Neomeris dumetosa*, bearing apical whorl of 6 members, and 2 whorls of 6 scars each,—enlarged view of apex at the side.

Fig. 2. Well-grown specimen in Stage I. Upper 5 whorls with full appendages.

Fig. 3. Rejuvenescence of an old injured axis. The young shoot commencing with greatly elongated internodes.

Fig. 4. Exceptional case of dichotomy of main axis, just above first signs of Stage II.

Fig. 5. Basal portion of plant in Stage I. Branching of the main axis below the lowest whorl of scars. 'a' possibly young branch developing from a creeping rooting portion.

Fig. 6. Root-portion of healthy plant. Starch-storage general in the lobes.

Fig. 7. Basal segment of Stage I, showing 2 apical scars.

Fig. 8. Anomalous branching of main axis in Stage I.

Fig. 9. Young plants (Stage I, natural size).

Fig. 10. Commencement of Stage II. (a) formation of the septum, delimiting the basal portion; (b) reversion to Stage I.

Fig. 11. Young plant in Stage II, the upper 10 whorls. In the water the lateral members stand out horizontally, they are shown closed in a pencil to give the symmetrical effect.

Fig. 12. Transition to Stage III.

Fig. 13. Segments of the primary cortex, wearing off on older part of thallus.

Fig. 14. The primary cortex of Stage III after loss of the filamentous portion of the appendages.

Fig. 15. Apex of a young plant in Stage III. Cleared in Eau de Javelle to restore normal turgidity. Formation of cortex at fourth and fifth node behind the apex.

Fig. 16. Longitudinal section of Stage III, cortical segments enclosing a cavity.

PLATE XXII.

Figs. 17, 21, 22, 24, 25, 26, Zeiss 3 A. and reduced $\frac{1}{2}$.

Figs. 18, 19, 20, 27, Zeiss 3 D. and reduced $\frac{1}{2}$.

Figs. 28, 29, $\times 5$.

Fig. 17. Upper portion of plant passing into Stage IV after formation of 43 whorls of Stage III. Reversion after 4 whorls and back again after 3.

Fig. 18. Section of apex showing transition, after 36 whorls of Stage III. Cortical layer in continuity at the ninth node from the apex. Stage IV laid down at the third node from the apex.

Fig. 19. Characteristic basal segment of Stage IV, showing 2 apical scars.

Fig. 20. Portion of main axis near the base. Transverse elongation of scars, the cellulose plug retains its circular contour. Number of members in a whorl at this point, 14-16.

Fig. 21. Transverse section of plant in Stage IV, partly decalcified. The depth of shading indicates the amount of deposit, as seen by transmitted light. Number of members in a whorl, 18-20.

Fig. 22. Older portion of thallus at transition from Stage III to IV, showing irregularities in formation, and scanty remains of whorls of members.

Fig. 23. Full type of 'leaf' in *Neomeris dumetosa*, showing specialization of basal portion and addition of new outgrowth, the aplanosporangium, at the first bifurcation.

Fig. 24. Transverse section of adult plant at about the middle of its calcified

portion; partly cleared. The dichotomy in a transverse plane is less regular than in Stage IV. Half the members in a whorl undergo displacement at the surface, rendering the facetting less symmetrical. Number of members in a whorl, 30-32. Depth of shading indicates amount of calcification.

Fig. 25. Older portion of thallus after disintegration of cortex. The calcified aplanosporangia and calcified basal segments only left. These latter decalcify and persist some time. Many of the aplanosporangia also decalcify and exhibit no contents, but no rupture in the wall; possibly sterile.

Fig. 26. Portion of transverse section, cleared and stained with Hoffmann's blue to show chlorophyll-corpuscles. Diagonal shading indicates the region of calcification in the mucilaginous sheath.

Fig. 27. Mature aplanosporangium enclosing a single spore, (?) gametangium. This latter invested with a thick cell-wall distinct from the thin membrane of the aplanosporangium. Contracted contents allow the wall to be clearly defined.

Fig. 28. Young plant in Stage IV, just commencing calcification. 22 mm.

Fig. 29. Adult plant in reproductive stage. Spirit specimen showing region of cortical calcification and apical coma of filamentous appendages. Below, the disintegrating cortex exposing the densely calcified aplanosporangia. Further back the scanty remains of basal segments. 35 mm.

PLATE XXIII.

The whole Zeiss 3 D. and reduced $\frac{1}{3}$.

Fig. 30. Basal segment of leaf bearing aplanosporangium. Calcified.

Fig. 31. The same decalcified, showing mucilaginous outer layer of wall and contents of aplanosporangium rounding off to form a spore. Also delimitation by T-shaped cellulose plug, not found in other septa.

Fig. 32. Median longitudinal section of apical bud of adult plant. Continuous cortex formed at node 9. At node 14 the cortical segments begin to assume globular extremities. First dichotomy in transverse plane, irregularities in facetting by displacement arise later.

Fig. 33. The same series of appendages in tangential view; bifurcation of Stage IV in 2. First sign of gametangium, as also delimitation of the cortical segments in 6. The full filamentous portions not shown. Cleared in HCl and Eau de Javelle.

The Karyology of Saprolegnia.

BY

A. H. TROW, B.Sc., (LOND.),

Lecturer in Botany, University College of South Wales and Monmouthshire.

—♦—
With Plates XXIV and XXV.
—♦—

IN the summer of 1893 I proceeded to Freiburg with a view to acquiring, among other things, a knowledge of certain of the newest methods in botanical technique. Prof. Oltmanns, who very kindly allowed me to work in his laboratory, and gave me, especially at the outset, much invaluable assistance, suggested that I should apply these methods to the detailed study of the cytology of the sexual organs of the Saprolegnieceae. Humphrey's ('92) monograph on the group had just appeared, and it was evident that there were still considerable gaps in our knowledge, more particularly with respect to the behaviour of the nuclei in the gametangia. The work was subsequently carried on partly in England, partly in Germany, until in the summer of 1894 I obtained results which suggested further study, which has been prosecuted entirely in the Biological Laboratory of the University College, Cardiff.

The long series of researches by De Bary (commenced in '52 and terminated only by his death) and Pringsheim (com-

Annals of Botany, Vol. IX. No. XXXVI. December, 1896.]

menced in '51 and terminated in '83) not only made us well acquainted with the whole course of development in a considerable number of species of Saprolegnieae, but placed the taxonomy of the whole group for the first time on a satisfactory basis. The method adopted by De Bary of cultivating each species separately for many generations—that of so-called 'pure cultures'—has been of inestimable value.

It may be useful to briefly refer to those features in the structure and life-history of the Saprolegnieae which were placed beyond doubt mainly by the labours of these two great pioneers.

In the Saprolegnieae the mycelium is branched, unicellular and multinucleate,—or to use Vuillemin's term,—*apocytial*. Certain branches—the rhizoids—penetrate the nutritive substratum and serve to absorb nourishment from it; other branches, when fully developed, bear the reproductive organs. These are, with rare exceptions, of two kinds—asexual and sexual. The asexual organs are sporangia, and give rise to numerous biciliate zoospores. The sexual organs—oogonia and antheridia—are produced in considerable numbers. Oogonia have been found in nearly all the species, and it is by no means improbable that they occur even in those few species in which their presence has not, so far, been noticed. The antheridia may, according to the species, be always absent from the oogonia, always present on the oogonia, or present on some of the oogonia and absent from others.

The antheridia are generally borne on special antheridial branches. When these branches arise near the oogonium the species is said to be *androgynous*, and when at some distance from the oogonium, *diclinous*.

It is especially noteworthy that in two species only—*Achlya stellata* and *Saprolegnia monilifera*—have the oogonia been found to be invariably destitute of antheridia. The closely related species or races—*S. mixta*, *S. torulosa*, and *S. Thureti*—have a certain but variable number of oogonia with antheridia attached to them. In cultures of *S. mixta* 50% of the oogonia bear antheridia, in cultures of *S. torulosa* antheridia

are seldom to be found, while they have only been seen in *S. Thureti* on very rare occasions.

An oogonium produces from 1 to 40 or 50 oospheres. The antheridia give rise to small tubes—fertilization-tubes—which pierce the walls of the oogonium and apply themselves closely to the naked oospheres. The oosphere then becomes clothed with a wall of cellulose and is now known as an oospore. In the young oospore De Bary noticed a clearer central speck, which he looked upon, at least provisionally, as a nucleus. In the mature oospore an oleaginous mass, which generally occupies a central position, is universally present. The oospore which usually remains in the resting condition for some time, ultimately germinates, and produces in most cases a hypha, which either forms a sporangium, or at once develops into a new generation.

De Bary ('81) has given us an admirable account, with figures, of the stages in the development of the oogonium and oospheres in *S. Thureti*. The oogonium in the Saprolegnieceae makes its appearance as a terminal swelling either on main or lateral branches, or occasionally is formed in an intercalary manner at some other point of a filament. Large quantities of protoplasm pass into the swelling, which is then delimited from the rest of the mycelium by one or two transverse walls. The mass of protoplasm generally has the form of a hollow sphere and surrounds a large central vacuole, which is continuous at first with the vacuole of the filament upon which the oogonium is borne. After a time, peculiar shifting vacuoles make their appearance in the protoplasm. These fuse together and finally unite with the large central vacuole. The layer of protoplasm thus becomes denser and thinner and the central vacuole larger. The protoplasm then moves gradually towards certain points so as to form hemispherical heaps projecting into the vacuole, and attached to one another ultimately by an extremely thin layer at their bases. These heaps may be called the oosphere-rudiments. Ultimately the thin connecting layer is ruptured and the oospheres lie free, in contact with each other, in the cavity of the oogonium. After a

certain amount of amoeboid movement, during which small portions of non-nucleated protoplasm are extruded from and again absorbed by them, the oospheres become perfectly spherical and are then furnished with a thin hyaline border.

In those species in which antheridia are produced, the antheridial branches attach themselves to the oogonium after it has attained its full size and before the formation of its basal wall. The antheridia are then separated off by transverse walls. The fertilization-tubes begin to grow out as soon as the oospheres have been formed.

It is obvious from the foregoing that it is very easy to identify, even in sections, a large number of successive stages in the development of the sexual organs—a matter of considerable importance in a study involving the accurate determination of the relative ages of structures which cannot be thoroughly examined in the living condition.

De Bary ('81, '83), influenced no doubt by the indubitable apogamy of the species destitute of antheridia, came to the conclusion that the Saprolegnieae as a group were distinctly apogamous: this conclusion was based on his inability to trace the passage of protoplasm from the fertilization-tube to the oosphere.

Pringsheim ('82, '83 *b*), as is well known, maintained that in certain species at least, fertilization took place.

I do not propose to enter into the merits of this controversy or to discuss the results obtained by other botanists [e.g. Zopf ('82, '83)]. I venture to believe that the methods at the disposal of these observers were not sufficiently accurate to insure trustworthy results. There seems also to be some doubt as to the identity of the appearances described by Pringsheim and Zopf. In this paper, however, I hope to prove conclusively that the genus *Saprolegnia* contains at least two species (*S. dioica* and *S. mixta*) in which fertilization either invariably or frequently takes place, and have little doubt that two species of *Achlya* may be added to the list. It is well to lay stress upon this at the outset, since under the influence of the great name of De Bary, the

apogamy of the Saprolegniae has been generally accepted by botanists.

It is only in recent years that the karyology of the group has received much attention. In addition to the researches of Schmitz ('79) and Strasburger ('80), special studies of the structure, behaviour, and fate of the nuclei in these plants have been made by Hartog ('89, '91), Dangeard ('90 *a*, '90 *b*, and '91) and Humphrey ('92).

Hartog ('91) states that the 'nuclei are vesicles with a central chromatin-mass supported by a network of "linin" or nucleo-hyaloplasma.' The nucleus of the zoospore is spherical and undergoes divisions by a process which is virtually direct, but nevertheless exhibits some features of karyokinesis. He ('89) also states that the division of the nucleus is preceded by great changes in the central mass of chromatin. This becomes very irregular and ends by dividing into two halves having the form of blunt crescents, placed back to back, and in structure distinctly 'fibrillaire.' These crescents move away from each other (*s'écartent*) and become spherical, and finally the nuclear wall is inflected so as to separate them, and thus the two daughter-nuclei are constituted. The nuclear divisions go on only in the mycelium and antheridia. No divisions consequently take place in the sporangia and oogonia. The number of nuclei which passes into a sporangium is just sufficient to provide one for each zoospore. A large number of nuclei pass into the oogonia—many more than is sufficient to provide one for each oosphere. The vacuoles which form in the young oogonia bring these nuclei nearer to each other, and they fuse in pairs until, in the genus *Saprolegnia*, the number is reduced at the time of the formation of the oospheres to one for each oosphere. Some of the details of the fusion are particularly interesting. 'In fusion of the nuclei the chromatin-masses long remain distinct, but are *smaller and take up stain less readily* (the italics are mine), and the nuclear wall at this stage ceases to stain, so that the fusion-nuclei have the look of vacuoles in the cytoplasm.' In his last paper Hartog carefully distinguishes between these

vacuole-like fusion-nuclei and the true vacuoles. He comes to the conclusion that the male gametangia are functionally impotent, and has developed a theory to explain his observations which would be all the more interesting and valuable if these were entirely beyond question. 'We have,' he says, 'a case of multiple endogamous union of potential gametes.'

Hartog further points out that the young oospore is uninucleate in *Saprolegnia*, but frequently binucleate in *Achlya*. He has apparently made no observations on the germinating oospores, and, so far, has unfortunately given no figures.

Dangeard's ('90 *a*) results are in accordance with those of Hartog up to a certain stage. The differences on the really critical points, however, are very great. This author, putting aside the question of vacuoles, finds no evidence of fusion-nuclei. He says, that from the vacuolated stage onwards to the formation of the young oospore, one sees only fine granules of chromatin dispersed in the protoplasm,—'la substance des noyaux s'être éparpillée'; and also asserts that the ripe oospore is multinucleate, but as to the origin of these nuclei he can only offer conjectures.

Dangeard suggests, in addition, that the 'Kern-fleck' of De Bary seen in the young oospore is the commencement of the fatty mass and not a nucleus at all, and that certain small deeply staining bodies which make their appearance in the young oospore are globules of glycogen. It is well to pay some attention to these curious and bewildering observations,—on which I hope to be able to throw some light—as they so plainly indicate the special difficulties of the investigation. Dangeard leaves the question of fertilization undecided.

Humphrey's ('92) conclusions do not differ to any great extent from those of Hartog. In particular, both of these botanists are agreed as to the reduction of the nuclei in the oogonium by a process of fusion, the uninucleate character of the ripe oospores, and the impotency of the antheridia. Humphrey, however, finds no evidence of division of the nucleus taking place in the antheridia. His figures, of which comparatively few deal with the histology, are of very con-

siderable interest, but furnish no real evidence of the existence of fusion-nuclei. The figure of a binucleate oospore of *Achlya americana*, together with Hartog's statements concerning another species of *Achlya*, are the grounds for my belief that fertilization takes place in *Achlya* as well as in *Saprolegnia*.

My own studies have led me to conclusions which differ fundamentally from those advanced by these three observers. The results brought forward in the present paper will, I trust, help us to form definite conclusions respecting these divergent and strikingly contradictory views.

In his investigations, Humphrey adopted the method of imbedding in paraffin and cutting serial sections with the microtome. His material was stained *en masse* by haematoxylin and then imbedded and sectioned. I have tried this method, but have not been able to obtain good results with it. Hartog and Dangeard have apparently trusted to preparations involving fixing, staining, clearing and mounting only. Such methods may suffice to elucidate the structure of the zoospores and mycelium together with their nuclei, but it appears to me to be totally inadequate to solve the difficult problems presented by a study of the sexual organs. Hartog's observations, nevertheless, so far as they go, appear to be most accurate and reliable, and it is only in the interpretation of them that I differ widely from him.

The question of the formation and liberation of the zoospores, which since 1880 has attracted the attention of a very large number of botanists, cannot be entered into here. The figures of sections of sporangia here given are intended only to illustrate the behaviour of the nuclei.

METHODS.

As the genus *Saprolegnia* is admirably adapted for teaching purposes and has been strangely neglected by the writers of text-books, it may serve more than one useful purpose if a somewhat extended account be given of the methods adopted in this research.

Cultures. It is obviously advisable to secure material which consists of a single species only. To obtain such, following the main the method of De Bary ('88), samples of fresh aquatic plants, e.g. Algae, Mosses, Phanerogams, are first collected from any convenient piece of fresh material. These are placed in small glass jars—marmalade pots will do well—and dead house-flies, previously wetted with water and washed with water, are thrown on to the surface. Invariably some member of the Saprolegnieae is found growing on the flies in the course of two or three days. The fungus produces a kind of halo of hyphae extending over the submerged parts of the fly's body. The sporangia are large enough to be detected by the practised unaided eye; and rapidly make their appearance; and later on, generally about a week, the sexual organs are formed.

When the sexual organs have produced ripe oospores, the purity of the culture may be roughly estimated. If more than one species is present. If a suitable species has been found, it may be separated from those associated with it in several ways. The most effective method is to place on a cover-glass, a small branch bearing oogonia; wash with water, boil, and add all spores and extraneous matter with water sterilized by boiling; add the leg of a fly and a drop of water, and place over a perforated piece of cardboard, which is macerated on a glass slide and is kept thoroughly moist. The culture started thus, in a very simple and effective moist chamber, kept under microscopic control for a day or two, the separated branch is not seriously injured by these operations, and generally puts out small branches which bear rhizoids and attack the leg of the fly. When it is ascertained that the severed branch alone has infected the culture, the cultures may be proceeded with on a large scale, as follows.

Glass jars are sterilized by a dilute solution of sodium hypochlorite and thoroughly rinsed with water carefully by boiling. Sterilized water must naturally be used as culture-fluid. If small glass squares are used to cover the jars, a large number may be prepared at one time.

ready for use. Flies killed by chloroform to prevent injury to their chitinous coats, moistened with alcohol and washed with sterilized water, are next thrown into the jars. The infected leg of the fly is then taken and placed in contact with one of the floating flies. In a week the flies are well covered with so-called pure cultures of the species selected. The cultures are not, however, pure, as they contain bacteria, monads, infusoria, &c., and in specially hot weather these unwelcome organisms affect more or less unfavourably the healthy development of the cultures.

Successive generations may readily be produced by infecting a second jar with water from the first, a third with water from the second, and so on. To attain certainty as to the purity of a culture, it is well to keep it under microscopic control for several generations, and to adopt the usual precautions with respect to the sterilization of the various instruments used in the different operations. De Bary was able to maintain the purity of a culture of *S. Thureti* for a period of eleven years. I have obtained a pure culture by placing with the leg of a fly, as described, a single sporangium in which the spores were already outlined. The spores germinated *in situ*, infected the leg, and produced the required cultures. Cuttings of the hyphae behave in the same way.

On one occasion I succeeded in making a pure culture of *Aphanomyces laevis* from a single zoospore. The method adopted in this case may be of use later in determining the real nature of the diclinous species: it is certainly possible that these are dioecious. White of egg was beaten up and a small drop spread thinly on a cover-glass, which was then immersed in boiling water in order that coagulation might take place. The thin layer of albuminous matter is sufficiently transparent for observations to be made through it, and it provides suitable and abundant nourishment for the developing plant. These covers are then floated on the surface of the water in the jars containing a mixture of species of Saprolegniae. Of ten covers floated on the surface of a jar, nine were found after a day or two to be unaffected, the tenth had

a single spore upon it which had already commenced to germinate. The culture was continued in a moist chamber and observed day by day until the sporangia characteristic of *Aphanomyces* and the sexual organs characteristic of *A. laevis* were produced in succession.

It is worth mentioning that I have found hard-boiled white of egg, cut up into minute oblong pieces and *floated on the surface* of the water in the jars containing the cultures, to be a very good substitute for flies. At the commencement of the investigation, most of the cultures were carried on on meal-worms; later on white of egg was tried and used, but finally house-flies were found to be, upon the whole, the most satisfactory: if kept dry, as Humphrey ('92) has pointed out, they retain their nutritive properties for at least six months.

The vitality of these cultures is great: they may be neglected for six months, and still on adding fresh food-material, new growths at once appear. In the winter of 1894-1895 some of my jars containing cultures of *S. dioica*, which stood near an exposed window, had the water which they contained converted into solid masses of ice, but nevertheless fresh cultures were obtained from them when the ice melted.

The species I have principally examined in pure cultures and in the fresh condition have been *S. dioica*, De Bary, *S. Thureti*, De Bary, and *Achlya prolifera* (Nees, 1823), De Bary. I have carried the study no further than to satisfy myself of the correctness of De Bary's descriptions and to learn to discriminate the various stages in the development of the sexual organs for use in the detailed study of serial sections: such studies of fresh material are easily carried out in moist chambers by means of small cultures on the legs of flies. I have found that by changing the water the whole course of development (excepting naturally the germination of the oospores) may in this way be followed on a single culture.

The four species mentioned do not, however, include all those which I have been able to identify. *Apodya lactea*

(Agardh, 1824), Cornu, was found very unexpectedly, apparently associated with no other species, in a test experiment as to the purity of the Cardiff Water-Works water. I have seen most of the forms (or species) of the *Ferax*-group of De Bary, but have not been able to study them critically.

Fixing. Most of the better known methods of fixing were tried, viz. solutions of osmic acid, picric acid, and chromic acid, absolute alcohol, as well as a hot saturated solution of mercuric chloride—the last being recommended by Hartog and found most satisfactory by Humphrey. I have found Hartog's method to be the best, and have used absolute alcohol side by side with it, as a means of avoiding any error due to the effect of the fixing liquid.

Imbedding and Sectioning. The fixed material was generally washed for twenty-four hours in running water, and in the earlier experiments was passed into absolute alcohol by means of Schultze's dehydrating apparatus, but later on this was dispensed with. Graded alcohols give results which are sufficient for all practical purposes. The dehydrated material was passed into paraffin, chiefly through the medium of xylol, but sometimes of chloroform. The position of the fly and fungus is well seen in the paraffin. The fly was generally bisected longitudinally, certain useless portions—determined by preliminary experiment—cut away, and the remainder sectioned by means of a Jung microtome. Some of the sections were of 7.5μ thickness, a few of from 2 to 3μ , but most of them of 5μ . For the more difficult work, the last-mentioned thickness is very convenient: one gets by this means about four sections through the young oospore. I may add that the chitinous coat of the fly is easily sectioned, but it is better to cut it away so as to save the edge of the knife and avoid the sectioning of useless material. Moreover, the smaller the surface of section, the longer becomes the series mounted on the same slide—an advantage of some importance.

Staining. In the earlier experiments an attempt was made to stain the material *en masse* with haematoxylin. The

results, so far as concerns the nuclei of the zoospores and mycelium, were satisfactory, but the study of the sexual organs could not be carried out properly by this method. The staining was effected on the slide in all later experiments, and the advantages of this method compensate for its laboriousness: the stain comes into direct contact with the protoplasm and does not have to pass through more or less impermeable membranes.

The sections were fixed to the slide with a mixture of white of egg and glycerine, freed from paraffin and stained with Schneider's acetic carmine, gentian-violet and eosin, or Kleinenberg's haematoxylin, and all three methods gave excellent results. I have used the two former very extensively; the latter has furnished me occasionally with beautiful preparations. The best haematoxylin-stained preparations were obtained by using a very dilute solution, allowing it to act for twenty-four to forty-eight hours, and then partly decolorizing with acid alcohol, alum solution, or best of all by a saturated solution of picric acid. [See Zimmermann ('92).] Schneider's acetic carmine was diluted so that the solution contained from two per cent. to five per cent. of acetic acid, and the objects remained in the stain for from twelve to twenty-four hours.

For a long time I failed entirely to apply Gramm's method of double staining with gentian-violet and eosin, although I had been using it successfully for twelve months in the laboratory for a great variety of purposes. In the case of material fixed by absolute alcohol, I believe it is impossible to secure good results, as the gentian-violet taken up by the nucleus is almost instantaneously taken out again by the absolute alcohol used in dehydration. With material fixed by mercuric chloride, the same difficulty presents itself, but not to such an extent as to make it impossible to surmount. When successful, the preparations are so excellent that for most purposes they are far superior to those produced by any other method. The difficulty of carrying out this method satisfactorily is great, and at first only a small percentage of

the slides were satisfactorily stained : towards the close of the work, however, I succeeded in obtaining uniform results.

Simultaneous fixing and staining by picro-nigrosin can readily be carried out, and may be recommended for demonstration purposes ; this method does not appear, however, to be suitable for detailed critical study.

KARYOLOGY.

At the commencement of my investigation of the karyology of the genus *Saprolegnia*—the main object of the research—I devoted myself to the examination of pure cultures of *S. dioica*, De Bary—a diclinous species whose histology had till then, apparently, never been studied. In the summer of 1894 I was able to prove to my own satisfaction, and to that of Prof. Oltmanns, that fertilization took place regularly and normally in this species. In view of the controversies which have so long raged over this point in the Saprolegnieae, we both thought it advisable to make a special study of a species destitute of antheridia. I soon obtained pure cultures of *S. Thureti*, De Bary, which is, for all practical purposes, destitute of antheridia. After maintaining the purity of this culture under microscopic control for about six generations, large quantities were grown, fixed, and preserved in the usual way. These were not previously examined microscopically. I depended entirely upon macroscopic examinations with respect to the determination of the condition of the cultures, and that of course with a view to avoiding the handling of the specimens as much as possible, and thus securing better results. The first sections examined revealed the presence of oogonia with and without antheridia. Suspecting that in some inexplicable way the cultures had become impure, I re-examined them in the fresh condition, and found that the cultures now appeared to be a mixture of *S. Thureti*, De Bary, and *S. mixta*, De Bary. These forms are so closely allied, that but for the fact that De Bary found the first to maintain its characters for eleven years, and the second for five

years, I should have at once concluded that both species are simply forms of one produced by somewhat different external conditions of life. Under the circumstances, however, I concluded, at least provisionally, that the cultures were impure, and that the oogonia with antheridia might reasonably be referred to *S. mixta*, and the oogonia without antheridia to either *S. mixta* or *S. Thureti*. These are, of course, respectively *androgynous* and *completely apogamous* forms.

It would have been obviously entirely outside the province of this research to attempt the decision of the specific identity of *S. Thureti* and *S. mixta*; the work would probably have required many years to carry out, and the results would not have had, so far as I can see, the slightest effect in the solution of the problems investigated in this paper. As a matter of fact, it may be regarded, apart from the difficulties of description, as a fortunate circumstance that the material contained the antheridium-bearing form.

In the following descriptions I shall refer to the antheridium-bearing oogonia as those of *S. mixta*, and to the others as those of apogamous oogonia of *S. Thureti* and *S. mixta*.

The most beautiful results were obtained during the investigation of *S. mixta*, but simply because by this time the method of staining adopted had reached its highest degree of efficiency. So far as I am able to judge at present, the karyology in the three forms, with one important exception, is identical. Most of my figures, however, refer to *S. mixta*, for the reason already stated.

The zoospore. Structure of the nucleus. Zoospores which have come to rest and clothed themselves with a cell-wall are generally abundant in the preparations. They fix well and stain easily, and I have consequently come to regard them as a kind of index to the value of the preparations. Each zoospore contains a quantity of granular protoplasm which is of a more or less spongy texture. The granules or microsomata are frequently of considerable size, and stain readily, although not with so deep a colouration as the nucleus. The nucleus is spherical and is bounded by a distinct nuclear wall.

In the centre of the nucleus is a spherical mass, which in deeply stained preparations appears homogeneous, and has, I believe, always been figured as such. This may be regarded as a chromosome. Dangeard looks upon it as a nucleolus. In good preparations its substance is seen to be distinctly spongy; median optical sections, in particular, have the appearance of a network. The cavities of the meshes appear to be filled with a substance which has not the same affinity for nuclear stains as the substance which forms the boundaries of the meshes. Although it is a difficult matter to decide, I think that the strands of this meshwork never become resolved into threads or rods of any kind: it cannot consequently correspond to the nucleus of higher plants. The chromosome is apparently suspended in the middle of a nucleo-hyaloplasm—which occupies the space between it and the nuclear wall—by a number of threads, which are only distinguishable from the nucleo-hyaloplasm which they traverse, and of which they probably form a constituent part, by their reaction towards stains. It is frequently difficult to detect these threads, even in preparations which are otherwise good, and a detailed study of them has not been possible with the lenses at my disposal: they appear most clearly and constantly in the acetic carmine preparations. The zoospore generally contains a somewhat large vacuole.

In the young zoospores, before germination begins, one finds in the best preparations a number of granules close underneath the external surface. Two of these are frequently elongated and arranged as if constituting a pair, and I have consequently been inclined to regard them as having some connexion with the cilia. They stain deeply with nuclear stains and are represented in Fig. 1 *a*, between the nucleus and the vacuole.

Division of the Nucleus. Germination. Development and Structure of the Mycelium. Germinating zoospores frequently appear in the preparations, and it is by no means uncommon to find them conveniently sectioned in the plane of the germ-tube. The nucleus first undergoes division, and the division,

so far as I have been able to observe, *always* follows the direct type: my observations on this point, however, might well have been more extensive. The chromosome loses its spherical character, becomes oblong, and soon after appears to have a slight median constriction. The two halves thus outlined gradually move apart until they are separated from each other by a distance equal to about the diameter of the originally spherical chromosome. The nucleus as a whole increases in size and alters in shape to accommodate itself to these internal changes. The nuclear wall, however, remains intact. Finally, a new nuclear wall appears in the plane of the equator of the nucleus, as is shown in Fig. 1 *b*, and the division is nearly complete. This wall later appears to split into two lamellae, for a constriction of the nucleus takes place in its plane and thus brings about a complete separation of the two daughter-nuclei. Further divisions follow, and while this is going on the germ-tube is developed. The apex of the germ-tube appears at all times to be destitute of a nucleus (Fig. 1 *c* and *d*).

If we turn now to the study of the mature hyphae, sections of which abound everywhere in the preparations, we find that the nucleus is generally more or less elongated, and the chromosome alters its shape to keep pace with the change in the nucleus. The protoplasm forms a lining to the cell-wall, and encloses a large central vacuole, across which thin bridles or connecting strands of protoplasm sometimes stretch. The nuclei are fairly evenly distributed, but are sometimes to be found in groups in accumulations of the protoplasm. Divisions appear to take place regularly (except perhaps in those hyphae poor in protoplasm), and sometimes one sees very elongated nuclei like those in Fig. 2 *b*, as if a simultaneous division into more than two daughter-nuclei were to follow.

Sporangia. Formation of Zoospores. The phenomena connected with the development of the sporangium and spores appear to be mainly of physiological interest. A hypha is arrested in its growth, and considerable quantities of protoplasm pass into its apical portion. This apical portion filled

with dense protoplasm is the young sporangium. It becomes delimited from the mycelium by a cell-wall—the basal wall—and there is not the slightest doubt that the protoplasm at this stage contains the number of nuclei necessary to furnish each zoospore with a single nucleus. Fig. 3 *a* illustrates a transverse section of a fairly old sporangium with the zoospores nearly mature, and Fig. 3 *b* and *c* illustrate radial and tangential sections respectively of the lower portion of a younger sporangium. These figures will suffice to indicate how little need there is to dwell on the morphological characters. The nucleus, it will be noted, has again become spherical. In Fig. 3 *a* the zoospore-rudiments are almost separate; they are connected together merely by very thin strips of protoplasm which ultimately get ruptured and so give rise to the spores. In Fig. 3 *b* and *c* the protoplasmic bridges, connecting the young spores, which have been so frequently described, are well seen. It may be worth while to note that the sections appear to prove conclusively, if this were any longer necessary, that there is here no possibility of the formation of a nuclear or cell-plate or special explosive substance. I have examined with some care sections of younger and older sporangia, the latter with the zoospores fully formed; but these furnish no additional features of interest.

Development of the Oogonium up to the complete formation of the Oospheres. The development of the oogonium has been most successfully followed in *S. mixta*, but there is no reason to believe that the other forms do not agree with this one in every respect. When an oogonium is formed at the end of a hypha, the latter ceases to increase in length, but grows in breadth, so as to give rise to a more or less spherical head. Large quantities of protoplasm and numerous nuclei pass into it. Fig. 4 illustrates a median section of a young oogonium which at this stage contained seventy-two nuclei: it is to be noted that the vacuole of the hypha extends into the oogonium. A careful examination of the nuclei shows that their structure alters coincidentally with their passage into the oogonium. In the hypha below the swelling the nuclei have the normal

vegetative structure. In the swollen portion the chromosome has become irregular in shape, and the nucleo-hyaloplasm takes up stains readily. The chromosome, with the double stain used, becomes violet, and the nucleo-hyaloplasm a dull red. The nuclear wall is extremely well defined; indeed the nuclei at this stage are very easy to demonstrate.

When the oogonium has attained its full size, the antheridia come into contact with it, and the basal wall is then formed. Fig. 5 represents this stage, and shows clearly that the nuclei are still in the same condition as that shown in Fig. 4. The number of nuclei in this particular oogonium was very small, and they were also of unusually large size. At this stage, the oogonium may, as figured, have no central vacuole: in by far the largest number of cases, however, a central vacuole appears to be present; and at all later stages up to the formation of the oospheres this is particularly evident.

Soon after the basal wall is formed, the nuclei of the oogonia undergo great changes which are extremely difficult to follow except in excellent preparations. As these changes have been either overlooked or partially overlooked, and entirely misinterpreted by all previous observers, I must here devote special attention to them. Careful and detailed examination of the nuclei shows that the microsomata in the protoplasm bordering on the nuclear wall become more deeply stained and conspicuous. The chromosome-mass undergoes division into two generally more or less unequal parts, and this process appears to take place, as represented in Fig. 6 *a*, by the appearance of a large cavity in the spongy mass immediately under the surface, near to which, therefore, it is thus bordered by a thin membrane only. The thin part appears to be ruptured, and the splitting commenced in this way is continued until the chromosome has been divided into two rod-like halves. Fig. 6 *b*, *c*, *d*, and *e* is very instructive. In *d* the rods produced by the division are shown in plan, in *e* in profile. Fig. 7 represents one of the sections of the oogonium from which these figures were drawn.

Somewhat older oogonia show that the rods escape laterally

from the stained microsomata and nucleo-hyaloplasm which surrounds them, and thus come to lie free in the protoplasm. At this stage no nuclear wall can be detected, although there is a clear space around the pair of rods: in the figures the boundary of this space is represented by a line, which must not be regarded as implying that the nuclear wall persists, though no longer evident. The evidence rather points to the conclusion that the nuclear wall is ruptured, and that the stainable nucleo-hyaloplasm, together with the deeply-coloured microsomata which surround the nucleus, are dispersed in the protoplasm, retaining however, for a time, their capacity for absorbing nuclear stains. These points will be appreciated so much the better if Fig. 8 *a*, *b*, *c*, and *d*, and Fig. 9 be consulted, the latter of which represents one section of the oogonium and antheridia in which these phenomena were specially studied. In Fig. 8 *a* the stained mass (nucleo-hyaloplasm, &c.) still lies in contact with the rods; in *c* it has entirely disappeared; and in *d* it seems further as if one of the rods were undergoing degeneration, as it does not stain deeply like its fellow. It will be noted, too, that the rods ultimately assume a spherical form.

Fig. 10 *a* and *b* deserves special study, as that of a stage immediately following upon the one represented in Fig. 9. Four of the pairs of now spherical rods are still to be seen, and are stained deeply; three of the pairs have undergone complete division so as to give rise to six new small daughter-nuclei, which are still, however, arranged in groups of two; while in addition there are six small solitary nuclei. One frequently notices in preparations of this stage that one or both of the paired rods stain badly; and occasionally, as at *deg. n.* in Fig. 10 *a*, we can just discern pairs in which the half-chromosomes have become so excessively small as to be scarcely recognizable. The stained nucleo-hyaloplasm and microsomata are still to be recognized, associated with those nuclei that were later than the others in entering upon division.

It would be natural to anticipate that, in consequence of

this division, the number of nuclei in the older oogonia would be doubled, since every nucleus in the oogonium undoubtedly passes through all the stages of division up to the halving of the chromosomes and the passage of the halves in pairs into the surrounding protoplasm.

A study of a somewhat later stage—the typical vacuolated stage—shows us clearly that the conditions are not so simple. Fig. 11 *a* and *b* represent two sections of an oogonium, one tangential and the other median, the greatest diameter of which was 50 μ . The nuclei in this oogonium, which were all small, were counted carefully, and numbered forty-five. The oogonium probably contained at the outset, when the basal wall was formed, considerably over 100 nuclei: it should be remembered that seventy-two were counted in an oogonium with a diameter of 29 μ . In consequence of the division the number would be doubled, but the number actually determined was forty-five. This, in itself, would be sufficient, provided the case were a normal one, to prove that a larger number of the small nuclei must undergo degeneration. Repeated examinations and measurements have convinced me that the case *is* a normal one. We have, however, ocular demonstration of the degeneration in the sections themselves; for the small and badly stained chromosomes which make their appearance while the division is still incomplete, must be looked upon as more or less degenerate. There is not the slightest evidence for the view that the reduction is brought about by nuclear fusions.

The significance of this division must, I think, be apparent to every one. It is exactly of the nature of a reducing division. The whole chromosomes are converted into half-chromosomes, which do not, as in the case of the direct divisions, become whole chromosomes by a process of growth.

These processes correspond very closely to the karyokinetic phenomena described by Hartog as occurring in these plants. Apart from referring to the fact that the evidence for the occurrence of indirect division of the nucleus has been made more complete by my observations, I need only state that

the points of difference between us are trifling, and concern the behaviour of the nuclear wall, which Hartog considers to remain intact, and the position of the half-rods back to back, and not face to face, as I have found them. As he expressly states that divisions do not occur in the oogonia, I conclude that he observed these phenomena in the antheridia, where they certainly occur regularly.

It is clear then that by the time typical vacuolization has begun, a reducing division of the nuclei, and the degeneration of the large majority of the daughter-nuclei thus formed, have taken place in the oogonium. The fact that it is the smaller half-chromosome that generally undergoes degeneration, and that the nuclei are slightly larger on the average at a later stage, leads me to believe that it is the smaller nuclei that go to the wall in this struggle for the survival of the fittest.

But an oogonium of $50\ \mu$ diameter does not produce forty-five oospheres, and as the oospheres are uninucleate, it is clear that we have to explain how the number of nuclei is still further reduced. The vacuolated stage of the oogonium passes away and is replaced by one in which we have a thin layer of protoplasm lining the wall and surrounding the vacuole. Fig. 12 *a* and *b* represent two out of six sections, $7.5\ \mu$ thick, of an oogonium whose greatest diameter measured about $45\ \mu$. The nuclei which could clearly be distinguished by any definite recognition marks numbered forty-one. Of these seven were noted as typical and thirty-four as degenerate. Three typical ones are shown in Fig. 12 *b* and twelve degenerate ones in Fig. 12 *a*: an oogonium of this size would produce about seven oospheres. The typical nuclei have the structure already described. The chromosome is small and its spongy character cannot be determined, simply because in order to see the nucleus at all it is necessary to stain as deeply as possible. The degenerate nuclei present various appearances: some of them stain so badly that they are not readily visible, and can be identified only by careful comparison with more deeply stained ones. The deeply stained nuclei have the appearance

of being made up of a number of much smaller ones, or sometimes appear distinctly spongy, and one can therefore readily understand how an observer might be tempted to conclude that they are fusion-nuclei. I believe that the granulated and spongy appearances may be traced to the same cause—the expansion and breaking up of the spongy network of which the chromosome-mass consists. The appearances represented in Fig. 12 *a* are then to be regarded as due to nuclear degeneration and not to nuclear fusions.

The protoplasm of the thin layer soon begins to be heaped up at certain points in order to constitute the oosphere-rudiments: Fig. 13 *a*, *b*, and *c* show an early stage in the development of these. In the three successive sections figured, three distinct rudiments will be noted. In each rudiment *there is one typical nucleus and one only*, having the structure we have observed in previous stages. Associated with it are degenerate nuclei, and some of these *do really appear to unite in pairs*: five distinct pairs may be noticed in the three sections. Not only do the forms assumed by these nuclei suggest fusion, but the increase in size and decrease in number is very marked. I believe that much of the confusion which has crept into the study of apocytial plants can be traced to the fusion of these degenerate nuclei, together with the study of badly stained preparations. These abnormal nuclei ultimately undergo complete degeneration, becoming more or less deformed, and finally losing all capacity for taking up nuclear stains. I have never been able to discover them in fully formed oospheres, but they are frequently still noticeable as irregular bodies near the surface of the older oosphere-rudiments.

Fig. 14 shows one of four sections through a small oogonium $28\ \mu$ in diameter, which contained four oosphere-rudiments, each uninucleate like that figured. The perfect agreement in structure of this nucleus with the typical ones seen in Fig. 13, and the complete dissimilarity from the degenerate nuclei, leave no room for doubt as to which are the functional nuclei in the younger oogonia.

When the oospheres are fully formed, we find, as represented in Fig. 15, that the nucleus still persists, but has undergone slight modification—the chromosome-mass has become more or less irregular. This irregularity of the chromosome left me for a long time in doubt as to whether fusions might not actually take place in the case of the functional nuclei at a very late stage, and I was especially anxious to determine this point in the apogamous forms. I have at last convinced myself that from the inception of the oogonium to the complete development of the oospheres, *no fusion of functional nuclei takes place.*

Figs. 16 and 17 show clearly that both young and mature oospheres of *S. dioica* are uninucleate, and the small size of the nuclei and general behaviour leave no doubt in my mind of the occurrence of reducing divisions in this species also. Similar evidence may be brought forward with respect to the apogamous oogonia of *S. Thureti* and *S. mixta*.

I cannot but conclude, however, that these observations will meet with considerable adverse comment, and it will be as well to bring forward at this stage additional independent evidence in support of them.

Hartog, who admits that divisions take place in the antheridia, denies that they take place in the oogonia. All observers are agreed that the oogonia and antheridia are homologous organs. They represent the culminating point of a development, which, starting with typical isogamy, terminates in complete heterogamy. Such developments are obviously of secondary importance, but reducing divisions must be of primary value, as they of necessity date back to the evolution of the sexual condition itself. If the nuclei of the antheridia undergo division, it is extremely improbable *a priori* that the nuclei of the oogonia should remain undivided.

Wager ('89) has carefully investigated the karyology of *Peronospora parasitica*, and has described and illustrated with numerous figures a process of karyokinesis which, while taking place in most parts of the plant, is particularly well

seen in the oogonia and antheridia. Hartog, curiously enough, has partly verified and accepted these observations. The affinity between *Peronospora* and *Saprolegnia* is sufficiently close to justify us in viewing with extreme suspicion any such differences in the karyology as would involve nuclear divisions in the one genus and nuclear fusions in the other.

Although I am not prepared to accept Wager's results in detail, and, for a reason which will appear later, am much inclined to give them another interpretation, one must admit that the observations show inherent evidence of being thoroughly trustworthy: in particular the evidence as to nuclear division appears to me to be very strong. I have little doubt indeed that Wager's figures, together with my own, furnish considerable evidence for the occurrence of reducing divisions in *Peronospora* also.

The researches on reducing divisions carried out by Overton ('93), Strasburger ('94), and others, make it at any rate not improbable that such divisions should take place in the Saprolegnieae and Peronosporae.

In addition to this positive evidence in favour of the occurrence of divisions in the oogonia, it may be useful to bring forward what evidence exists as to the improbability of nuclear fusions taking place.

Oltmanns ('95) has shown that in the oogonia of *Vaucheria*, where nuclear fusions were supposed to take place, no such phenomenon occurs. A number of nuclei pass into the oosphere, but before the basal wall is formed they all pass out again with the exception of one, which becomes the nucleus of the oosphere, and later unites with the sperm-nucleus to form the nucleus of the zygote. I may add that it has been my good fortune to have seen some of the sections upon which Prof. Oltmanns's conclusions were based.

So far as I have been able to ascertain, there is no thoroughly reliable evidence for the occurrence of the fusion of nuclei in the Thallophytes, except in connexion with the sexual process.

It must, moreover, not be forgotten that Dangeard came to

the conclusion that in the later stages of the development of the oogonium the substance of the nuclei becomes finely divided and distributed through the protoplasm. Such a view, while manifestly incorrect, might be formed naturally enough from a study of unsatisfactory preparations: my own earlier work caused me to form a somewhat similar opinion. It is difficult, however, to see in what way Dangeard could come to the conclusion indicated if the nuclei really undergo fusions.

I may also refer to Hartog's description of the nuclei at this critical stage of development of the oogonium, already given on p. 613. In particular, the fact that *the chromatin-masses are smaller* tells strongly in favour of *division*, and that '*they take up stain less readily*' appears to confirm the observations I have already made on *degeneration*.

Vacuoles in the Oogonium. The vacuoles in the oogonia have given rise to much discussion. In recent years they appear to have been confounded with the nuclei, as in former times they were confounded with the pits in the wall of the oogonium. They occur in the protoplasm of the oogonium from the time that the reducing division has led to the liberation of the paired rods up to the formation of the thin layer of protoplasm. They virtually exist then during the time that the degeneration of the nuclei is going on. They occur in their most typical form, as represented in Fig. 11 *a*, at the time of the completion of the division of the nuclei. The study of sections, moreover, shows that they are even more irregular and inconstant than would be suspected from a study of the fresh material. I believe that many of the so-called vacuoles observed in fresh material are simply thin places in the lining layer of protoplasm, as may be seen, for example, in Fig. 11 *b*. They have no morphological connexion with the nuclei, and with their possible physiological importance we cannot concern ourselves here. They cannot possibly be the means, as Hartog supposes, of bringing the fusion-nuclei into proximity with each other: this is well seen in Fig. 11 *a*, where the vacuoles are well developed, but the small nuclei are

equally distributed in the protoplasm, and show no tendency even to come together in pairs, much less to undergo fusion.

Development of the Antheridia up to the formation of the Fertilization-tubes. The antheridia have not been studied so thoroughly as the oogonia. The results won by the more difficult examination of the development of the oogonia, enable one to follow with ease the corresponding stages in the antheridia. Figs. 5, 9 and 10 show antheridia in successive stages of development. At the time of the separation of the antheridium from the antheridial branch by the formation of a basal wall, its protoplasm encloses a small but variable number of nuclei. These undergo division exactly as in the case of the nuclei of the oogonia. Fig. 8 *c* and *d* represent two nuclei from an antheridium. Degeneration of the nuclei certainly takes place in the antheridia at a very early stage, just as was seen to be the case in the oogonium. When the oospheres have been developed the antheridia give rise to the fertilization-tubes, and these apply themselves closely to the oospheres.

Some of the small nuclei pass into these fertilization-tubes and are there specially easy to see; others remain behind in the antheridium and ultimately degenerate, as indeed do many of those which pass into the fertilization-tubes. This later degeneration has been observed by many botanists, and has long been thought to furnish evidence of the absence of fertilization.

Fertilization. The most detailed observations on fertilization were made on *S. dioica*, the species first studied, on sections stained with acetic-carmin. Early in the course of my investigations young oospores were found with two large nuclei, corresponding closely to those of *Achlya americana* figured by Humphrey. As the uninucleate character of the oospheres had already been placed beyond doubt, there remained but two alternatives to account for the presence of these two nuclei: they must have arisen either by the division of the pre-existing nucleus, or a new nucleus must have passed into the oosphere from some outside source. The structure

of the nucleus, too, at this stage, presented some difficulty, as it was distinctly unlike that of the oosphere-nucleus. A careful search was consequently made for stages intermediate between these two which would account for the change in the nuclei. These were soon found, and it was noticed that the nucleus of the oosphere gradually became larger and more irregular: indeed, the appearances led me at first to suppose that the chromosome-mass divided up into small portions which laid themselves in contact with the nuclear wall. Though I now believe this view to be incorrect, it will be seen from Fig. 17 that it was more or less reasonable. As a matter of fact, in consequence of the study of the dividing nuclei of the oogonium and a later examination of the oospore-nuclei in *S. Thureti*, I have come to the conclusion that the small gameto-nuclei undergo changes in virtue of which the microsomata in proximity to them become deeply stained; the chromosome-mass becomes of smaller and the nucleo-hyaloplasm of larger volume. As the small chromosome is more or less masked by the large microsomata, it is difficult to detect it in carmine-preparations at this stage. These changes in the nucleus agree in most respects with those which precede its division in the oogonium.

During the course of this investigation of the nuclei, oogonia in the condition represented in Fig. 18 were several times observed. I think they place beyond all doubt the occurrence of fertilization in *S. dioica*. The nuclei of the fertilization-tubes and oospheres are at this stage of identical structure. A nucleus is frequently seen at that point of the fertilization-tube which is in contact with the naked oosphere. Occasionally one observes, as in the figure, a second nucleus in the oosphere lying at its extreme edge, and in such cases one always finds by careful examination that a delicate cell-wall has been formed around the oosphere, and that there is a fertilization-tube exactly opposite to this lateral nucleus. No opening can be seen in the tube, and it would in any case be probably very difficult to prove its presence even were it there. But a permanent opening does not appear to be

necessary for fertilization to take place in such cases. No one, for example, has been able to determine the presence of a permanent opening at the end of the pollen-tube of the Angiosperms, where fertilization undoubtedly takes place. This remark has a special significance if we remember that Hartog has actually described the passage of Monads into the hyphae of Saprolegniae, and expressly states that the opening made is not a permanent one. It is well known too that in these plants little protoplasm escapes from the cut end of a hypha, the damage being repaired with extreme rapidity by the formation of a new piece of cell-wall, possibly owing to the presence of cellulose as a reserve material in a specially soluble form.

The young wall of the oospore is generally easily seen owing to the slight contraction of the protoplasm induced by the method of preparation, as is represented in the binucleate oospore of Fig. 18.

After a time, the two gameto-nuclei lie fairly closely together near the centre of the oospore. Fig. 19 represents the young oospores in this condition. Nuclei are still to be seen in the antheridia and fertilization-tubes. The two nuclei do not always appear in the same section, so that careful drawings and comparisons have to be made to convince oneself that the oospore is always binucleate at this stage. The oospores of two large oogonia were investigated in this way, and a large number of other oospores examined in a less rigorous manner. As the result of these observations, extending to hundreds of oospores, I was forced to the conclusion that the young oospores are *invariably binucleate*.

An examination of the nuclei in Fig. 19 shows the increase in size already described: the nuclei of the oospores are very much larger than the nuclei of the oospheres and fertilization-tubes.

The study of *S. Thureti* was undertaken to place the process of fertilization beyond doubt. As already pointed out, the absolute identification of the species, owing to the behaviour of the cultures, has here become impossible. Figs. 20

and 21, however, illustrate sections of oogonia in successive stages of development, which were almost certainly those of *S. Thureti*. They were certainly destitute of antheridia. The oospores are uninucleate, and exhibit those changes in the structure of the nucleus already described. The whole of the oospores in both of these oogonia, as well as a large number of others, were carefully studied, and *every oospore proved to be uninucleate*. A careful examination of the nucleus in Fig. 21 will lead to the conviction that it corresponds to De Bary's 'Kern-fleck,' and that Dangeard's view that it represents the first stage in the development of the fatty mass, must then fall to the ground.

I had anticipated that the application of the new and improved method of staining with gentian-violet and eosin to the study of *S. mixta* would yield valuable confirmatory results, but have been disappointed. At the period of fertilization the borders of the oosphere stain deeply with gentian-violet, and numerous small deeply stained granules appear in the protoplasm, so that the critical stages, as to which confirmation was needed, were more or less obscured. A return to the earlier method of staining with acetic carmine produced better preparations, but even these were not sufficiently good to give unquestionable results. When the young oospore has developed a little, and the nuclei in particular have increased in size, we find that *many of the oospores are binucleate*, as represented in Fig. 22, *while others are uninucleate*.

A long study of this perplexing condition, involving the careful examination of hundreds of oospores, has led me to the conclusion that the development in the uninucleate forms is apogamous, that is to say, no fertilization takes place; while in the binucleate forms fertilization occurs, and the nuclei are respectively male and female. This conclusion is based solely upon the absence of all evidence for either the fusion or division of the nuclei in the young oospore, and the important fact that the gameto-nuclei—as I must term them—may be found close together, though still distinct, in oospores much older than those which contain a single nucleus.

The oogonia may contain binucleate oospores alone, uninucleate oospores alone, or a mixture of these in various proportions.

In *S. mixta* then we conclude that fertilization frequently takes place, but in default of its occurrence the oosphere may develop parthenogenetically. The diclinous, androgynous, and completely apogamous forms investigated, thus form a very interesting series as regards sexual capacity: *S. dioica* is typically sexual, *S. Thureti* is typically apogamous, and *S. mixta* occupies an intermediate position.

An examination of Humphrey's figure of a binucleate oospore of *Achlya americana*, already referred to, leaves no room for doubt in my mind that a process of fertilization takes place in this species also. The figure of the uninucleate oospore—provided that the other nucleus has not been overlooked—leads me to believe that an apogamous development of the oosphere is also possible in this case. Humphrey's view that these constitute the last pair of fusion-nuclei is manifestly incorrect.

Hartog ('89), who appears to have investigated one or two other species of *Achlya* (either *A. recurva* or *A. prolifera*, or both), agrees with Humphrey that the last fusions of the nuclei may be delayed in *Achlya* until the formation of the young oospore. This remark leads me to believe that a second (if not a third) species of *Achlya* at least undergoes occasional fertilization. The fact that Hartog did not find binucleate oospores in *Saprolegnia* may be traced most probably to an examination of apogamous forms like *S. Thureti*.

It appears clear that not the least interesting of the results of this investigation is the discovery of a *distinct and unequivocal process of fertilisation in at least four species from a group which has for many years been almost universally regarded as affording one of the most interesting cases of complete apogamy.*

Maturation of the oospore. This was studied first in *S. dioica* by means of preparations stained with acetic carmine or

haematoxylin. Later, during the examination of *S. Thureti* and *S. mixta*, an attempt was made to obtain better preparations by using gentian violet and eosin, but this proved entirely unsuccessful.

The difficulty of following the processes connected with the maturation of the oospore is extreme, not only because of the changes in the cell-wall of the oospore, which prevent the efficient action of the fixing reagents, but also by reason of the appearance in the ripening oospore of entirely new and puzzling structures. Fig. 23 *a, b, c, d* and *e* represent successive stages in the development of an oospore. The nuclei long remain distinct, but ultimately come together and lie closely side by side or end to end as represented in *b*. The histological details are difficult to follow, but it is easy, up to this point, to satisfy oneself of the indubitable nuclear character of the structures by a study of successive stages. In *e* is represented a uninucleate oospore, but as I have not been able to observe those stages which illustrate the actual fusion, I do not attach much value to it. At this stage it would be easy to overlook one of the nuclei under certain circumstances, as, for example, when side by side and in the same vertical plane.

In the stage represented at *b* the protoplasm is seen to contain deeply stained granules like large microsomata, lying in the knots of the protoplasmic meshwork. These appear to correspond to the drops of glycogen observed by Dangeard. They rapidly increase in size, as may be seen by comparing *b, c, d* and *e*. Ultimately they are seen, especially clearly in the haematoxylin preparations, to consist of hollow spheres, rings, or crescents. Finally, they increase further in size and diminish in number by fusing together in pairs until, at a late stage in the maturation of the oospore, they are reduced to a few rings or crescents, or sometimes a single hollow or more or less chambered sphere. That the rings are not optical sections of hollow spheres is proved by the fact that they frequently overlap each other, as well as by the appearances presented by optical sections from various points of view.

What are these curious structures? As they make their appearance coincidentally with the fatty reserve material of the oospore, and the fusions observed amongst them appear to coincide with the fusion of the oily globules, I think it is very probable that they have some connexion with the production of this reserve material. They take up all nuclear stains that I have experimented with more readily even than the chromosomes, and all my efforts to discriminate between them and the nuclei by differentiating staining failed. The only test by which they can be distinguished is that of structure, and as the structure of the nuclei, owing to the incomplete fixation, is not well seen in nearly ripe oospores, there is a great difficulty in distinguishing between the nuclei and some of the forms assumed by these bodies. As I have not tested them microchemically, in the fresh condition nor paid any attention to them except in stained sections, I must refrain for the present from expressing any definite opinion as to their character and significance. For some time I worked on the assumption that they were analogous to the pyrenoids seen in so many of the Algae. It is not unlikely that they simply form a special part of the fatty globules, in other words are a special form of reserve material. It seems very probable that it was these bodies which led Dangeard to regard the ripe oospores as multinucleate; this is all the more strange as he ('90 *b*) has described similar structures as occurring in the oospores of *Cystopus candidus*.

This study of the maturation of the oospores leaves the fusion of the gameto-nuclei undetermined, and it was mainly in consequence of this that I resolved, if possible, to follow the germination of the oospores.

Germination of the oospores. Specially good cultures of *S. Thureti* were obtained in September, 1894, and these were left in their jars for six months. In March, 1895, one of the cultures was removed to a warm room, the water changed and fresh flies added. The new flies were soon infected, and an examination of the old material then showed that many of the oospores were in all stages of germination. In germination,

as is well known, the wall of the oospore becomes thinner and more permeable to reagents, and the fatty mass disappears. A germ-tube is generally produced, and finally a club-shaped sporangium is formed. No case of the formation of a germ-tube was noticed in the fresh material, the swollen oospore itself becoming the sporangium. Moreover, the zoospores appeared, as a rule, to remain unliberated and to undergo germination inside the sporangium. This mode of development is not infrequent in the normal sporangia of old or somewhat unhealthy cultures.

The material thus obtained was sectioned, and very beautiful preparations were the result. While the wall of the oospore is still of considerable thickness, and the protoplasm still takes on that peculiar reddish tinge with the gentian-violet and eosin which I had already found to characterize the resting oospore, *the oospore contains one nucleus only.* This nucleus has the same structure—the typical vegetative structure—as those of the zoospores, mycelium and sporangia, as is shown in Fig. 24. In Fig. 25 we see a binucleate oospore with the nuclei still near to each other. The divisions appear to be in all cases direct. Figs. 26, 27 and 28 represent oospores with 5, 6 and 8 nuclei respectively. In these successive stages of development it will be noted that there is a gradual thinning of the wall of the oospore, an increase in its size, and the formation of a central vacuole and zoospore-rudiments, while the nuclei undergo division. Fig. 29 represents a section of an oospore which had produced 11 zoospores not yet entirely separated one from the other. Ultimately we find in the cavity of the oospore from 8 to 12 zoospores in various stages of germination. I have seen zoospores with from 1 to 5 nuclei and germ-tubes of various lengths. In the case of one oospore, represented in Fig. 30, which possessed 12 nuclei and was the only oospore in the oogonium, a germ-tube was produced, no doubt with a view to the formation of the typical club-shaped sporangium.

The uninucleate character of the oospore at the commencement of germination and its subsequent behaviour finally

remove all doubt as to the incorrectness of Dangeard's view, and makes it certain that the gameto-nuclei undergo fusion at a late stage in the maturation of the oospore.

Chlamydo-spores. The chlamydo-spores, as might be expected, contain nuclei of the normal vegetative type. (Fig. 31.)

GENERALIZATIONS AND CRITICISMS.

Generalizations based on the examination of a single genus must necessarily be of small value: indeed those which have been already made on apocytial plants, by at least one observer, have in this paper been proved to be quite valueless. It is obviously necessary that a large number of the genera of the Phycomyces should receive a thorough investigation, and I have already made preparations for this purpose.

Some points of wider interest have, however, suggested themselves to me in consequence of the special study upon which I have been engaged.

The observations of Wager appear, as already stated, to be thoroughly reliable, but they are nevertheless manifestly incomplete. The nuclei in the gonidia, in particular, have a structure totally distinct from that figured for those of the mycelium and sexual organs. No indication is given as to how the one condition passes into the other. Wager's paper, however, deals mainly with so-called karyokinetic figures, and it may well be that the undividing nuclei have been more or less neglected.

In the early part of my investigation I met with some curious appearances in a few oogonia of *S. dioica*, a section of one of which is represented in Fig. 32, which may throw some light on this matter. In these sections I imagined I had found karyokinetic figures exactly similar to those described by Wager. Later on, towards the end of the research, and after the expenditure of much effort, I found the correct explanation of these appearances, and this may readily be guessed from the

examination of the antheridium in Fig. 10 *b*. The apparent karyokinetic figures are produced by the stained granules on the nuclear wall at the time the nucleus is undergoing division, and the dark-coloured spindle is the nucleo-hyaloplasm. The chromosome-rods, already half the size of the original mass, are frequently at this time only distinguishable with difficulty from the larger granules.

May not the figures of Wager be explained in the same way? If the resting nucleus has really a single chromosome, as the figure of the gonidium seems to indicate, this must be regarded as very probable; and should it be so, we might expect the karyology of the two genera to agree very closely. So much has this view appealed to me that I have already commenced an examination of *Cystopus candidus* with a view of putting it to the test, and have secured material for the study of *Peronospora parasitica*.

The evidence for the occurrence of fusions of nuclei in the unfertilized egg of *Peronospora* is extremely weak. Indeed, Wager's figures suggest to me that no such fusion occurs.

In the theory of heredity propounded so brilliantly by Weismann, the admixture of the substance which is the bearer of the hereditary tendencies during the sexual process is looked upon as the chief cause of variation in the higher organisms. An apogamous group, such as the Saprolegnieae was supposed to be, offers a special difficulty to the acceptance of this theory by botanists. The difficulty, however, is not a real one, as Weismann expressly rejects Nägeli's view that protoplasm has an inherent tendency to vary along certain definite lines of development, and, consequently, he is of necessity driven to adopt the view that it varies under the direct influence of the external conditions. The sexual process becomes specially important in those organisms in which the gametes are protected by their position from the direct action of the external conditions. Such apocytial plants as the Saprolegnieae, however, have their gametangia as much exposed to this direct action as the mycelium or zoospores, and the

nuclei of the sexual organs, it must be remembered, pass into them from the mycelial hyphae.

Although the difficulty presented by the Saprolegnieae is not a real one, it is of special interest to note that, even were this the case, the difficulty disappears under the light of the few observations already made on the functional character of the antheridia. Apogamy certainly must inevitably take place in the two species in which there is absolutely no provision for fertilization. In the other species, more or less closely related to *S. mixta*, in which apogamy *may* take place, antheridia are sometimes present; and after what has been said, we may be permitted to believe that fertilization *may* occur whenever antheridia and fertilization-tubes are present until this has been proved to be impossible. The Saprolegnieae as a group must therefore be no more regarded as apogamous than the Characeae, the Vascular Cryptogams, or the Phanerogams, in all of which isolated apogamous forms occur.

It might have been expected that the apogamous oogonia investigated would have differed from the others by their nuclei not undergoing a reducing division. Weismann, indeed, anticipated that this would be the case with the parthenogenetic ova of animals. The non-occurrence of the reducing division would then have accounted for the power of parthenogenetic development. As matters stand, we have to account for this by assuming—and there are excellent grounds for such an assumption—that the half-chromosome, if not increased to a whole-chromosome by the sexual process, can attain to the required mass by a process of growth during the resting period of the oospore. Since the oospheres and zoospores are generally admitted to be homologous organs, this is nearly equivalent to the statement that the oospheres simply revert to their primitive asexual condition.

The formation of azygospores in both algal and fungal conjugate forms, and the apogamous development of the old gametes of *Botrydium*, which appear to be well authenticated, to say nothing of the development of weak plants of *Ulothrix* from gametes which have not succeeded in conjugating, may be

mentioned as phenomena of which a similar explanation may, with great probability, be given. A thorough investigation of the nuclei of these plants is much to be desired.

The occurrence of fertilization in the androgynous forms is certainly very curious and puzzling. Nuclei, so closely related by descent as to be less than ten generations distant from each other and maintained throughout life under apparently identical external conditions, pass into the separate gametangia, and after undergoing a reducing division fuse with one another to form the nucleus of the zygote. This phenomenon seems to involve the assumption that the nuclear divisions are qualitative as well as quantitative in character. If this be so, the advantage of the sexual process in promoting variability is evident.

I should like to make clear that there is nothing exceptional in the degeneration of nuclei as described in these plants, and any peculiarity in the details of the phenomena are readily explained as special adaptations. The majority of gametes, in the animal as well as in the vegetable kingdom, die, and are a serious loss to the organism, or rather to the species. The gameto-nuclei in the oogonia of *Saprolegnia* which are present in excess of the required number evidently die, but they are not a great loss to the plant, as their substance is almost certainly utilized by the oogonium at once as food, or is stored up as reserve material for future use. The protoplasm, which we may regard as having belonged to the defunct nuclei, is not lost at all, but goes to increase the size of the oosphere—probably a decided advantage to the plant. Thus it happens that when the nucleus of the zygote divides after its period of rest, the number of nuclei is restored, and the requisite protoplasm to furnish each with a sufficiency for spore formation is already present. In consequence of this, about as many zoospores are produced by the oospores of an oogonium as there were nuclei enclosed in it at the time of the formation of its basal wall.

I cannot bring these remarks to a close without recording my conviction that Strasburger's ('94) interpretation of the

periodic reduction of the chromosomes does not adequately explain the facts. So far as concerns the Thallophytes too, it may be safely asserted that his prophecies have not been fulfilled. He asserted, and at the time with sufficient justification, that 'the assumption that this reduction takes place during the development of the sexual organs is not supported by any direct evidence,' and then proceeds to suggest that the necessary reduction takes place in the lower Cryptogams during the germination of the zygote. The facts already mentioned show quite clearly that a reducing division takes place in *Saprolegnia*, in the gametangia and not in the zygote.

The great objection which all biologists must raise against Strasburger's view is that it necessitates one explanation of the reducing division in plants and another in animals without sufficient reason. *Saprolegnia* and most other Thallophytes (like animals) have no sporophyte-generation. If the real significance of the reducing divisions observed in higher plants is simply the return of the sporophyte-cells to their primitive gametophyte-condition, what meaning are we to attach to the corresponding process in *Saprolegnia* and animals where no such return is possible? It would needlessly complicate matters to assume that the zygote and its products constitute a sporophyte-generation in *Saprolegnia*, for they certainly do not; and even if they did, no reducing division takes place in it.

In plants in which there is no sporophyte-generation it would be reasonable to admit that the reducing division occurs, as in animals, in the sexual organs; and that the number of chromosomes is restored by the sexual act. The phenomenon consists essentially of a halving and a subsequent restoration to the whole condition, and this we have proved to take place in a characteristic manner in *Saprolegnia*.

In plants in which there is a distinct sporophyte-generation there really appears to be no halving in connexion with the sexual process, but rather a doubling, and a reduction to the undoubled condition takes place in the transition from sporophyte to gametophyte. When we consider that the sporophyte

is a new generation intercalated between two successive gametophytes, and that it is entirely unrepresented amongst animals, it is not unlikely that the reducing division has in this case a special significance.

In fact, I would suggest that the evolution of the sporophyte was initiated by the fusion of gametes in which the halving observed in animals and Thallophytes did not take place; and that the increase in the mass of the nucleus had the effect of a stimulus in the direction of spore-formation, giving to the organism the advantages of polyembryony. The power of subsequent return to the undoubled condition must, on this theory, have been developed simultaneously with the sexual capacity of the abnormal gametes. Wallace has conclusively shown that such simultaneous variations certainly occur.

Such a view is, at any rate, supported by the facts already ascertained, and will certainly have the effect of stimulating me, and possibly others, to further research. An investigation of the karyology of *Oedogonium*, *Coleochaete*, and some genera of the Florideae seems particularly desirable.

The results of Klebahn's investigation of *Closterium* and *Cosmarium*, and Chmielewsky's investigation of *Spirogyra*, appear to require confirmation. The facts seem to me to support the theory propounded here. The whole course of development and the minutest details as to the structure of the nuclei must, however, be determined before the significance of the behaviour of the nuclei can be made clear.

SUMMARY.

1. The nucleus in the genus *Saprolegnia* is bounded by a nuclear wall, and possesses one central chromosome of spongy texture. The space between the nuclear wall and chromosome is occupied by a nucleo-hyaloplasm, which is traversed by fine threads.

2. The nucleus undergoes direct division in the zoospore

and mycelium, and the products of these divisions ultimately pass into the sporangia and gametangia.

3. Neither nuclear divisions nor nuclear fusions take place in the sporangia.

4. In the oogonia and antheridia each nucleus undergoes one reducing division by an indirect method, in virtue of which the whole chromosome becomes a half-chromosome, but no fusions of functional nuclei take place.

5. The number of gameto-nuclei produced in the oogonium by the reducing division is about twenty times greater than that necessary to provide one nucleus for each oosphere. The number is reduced by the degeneration of the excess.

6. Most of the gameto-nuclei in the antheridia and fertilization-tubes also undergo degeneration.

7. Fertilization takes place invariably in *S. dioica*, and at least occasionally in *S. mixta*, *Achlya americana*, and another species of *Achlya*, while *S. Thureti* is normally apogamous. The whole-chromosome condition is restored to the nucleus either by the sexual process or by a process of growth. The two gameto-nuclei do not fuse to form the single zygote nucleus until a late stage in the maturation of the oospore. The Saprolegnieae as a group is not apogamous.

8. At the period of germination of the oospore the nucleus of the zygote undergoes direct division to furnish one nucleus for each zoospore.

9. The sporophyte-generation of the higher plants probably owes its origin to the fusion of gametes whose nuclei did not undergo a reducing division. The doubling of the chromosomes acted as a stimulus to spore-formation, and involved a halving of the chromosomes in the return to the undoubled condition of the nuclei in the gametophyte-generation.

UNIVERSITY COLLEGE, CARDIFF,

September, 1895.

BIBLIOGRAPHY.

The list includes only the more important of the works bearing upon the subject investigated which I have been able to consult directly.

- De BARY, A., '52: Beitrag zur Kenntniss der *Achlya prolifera*. Bot. Zeitung, Bd. X, S. 473.
- '81: Untersuchungen über Peronosporéen und Saprolegnieen. Beitr. zur Morph. und Phys. der Pilze, IV Reihe. Frankfurt am M.
- '83: Zu Pringsheims neuen Beobachtungen über den Befruchtungsact der Gattungen *Achlya* und *Saprolegnia*. Bot. Zeitung, Bd. XLI, S. 38 and 54.
- '84: Vergleichende Morphologie und Biologie der Pilze. Leipzig.
- '88: Species der Saprolegnieen. Bot. Zeitung, Bd. XLVI, S. 597, 613, 629, und 645 mit T. IX und X.
- DANGEARD, P. A., '90: a, Recherches histologiques sur les Champignons. Le Botaniste, 2^e Sér., 2^e Fasc., p. 63 avec 4 planches.
- '90: b, Sur les oöspores formés par le concours d'éléments sexuels plurinucléés. Comptes Rendus, T. 111, p. 382.
- '91: Du rôle des noyaux dans la fécondation chez les Oömycètes. Revue Mycol., T. XIII, p. 53.
- HARTOG, M. M., '89: Recherches sur la structure des Saprolegniées. Comptes Rendus, T. 108, p. 687.
- '91: Some Problems of Reproduction. Q. J. M. S. Vol. xxxiii, N. S., p. 1.
- HUMPHREY, J. E., '92: The Saprolegniaceae of the United States, with notes on other species. Read before the American Philosophical Society.
- OLTMANN, F., '95: Ueber die Entwicklung der Sexualorgane bei *Vaucheria*. Flora oder Allg. Bot. Zeitung, Heft 2, S. 388 mit T. VI-X.
- OVERTON, E., '93: On the reduction of the chromosomes in the nuclei of plants. Annals of Botany, Vol. vii, No. XXV, p. 139.
- PRINGSHEIM, N., '51: Entwicklungsgeschichte der *Achlya prolifera*. Nova Acta Acad. C. L. G. N. C. Bd. XXIII, Heft 1, S. 395 mit Tafeln XLVI-L.
- '82: Neue Beobachtungen über den Befruchtungsact von *Achlya* und *Saprolegnia*. Sitzungsbericht der Akad. der Wissensch. zu Berlin, S. 855, mit T. XIV
- '88: a, Nachträgliche Bemerkungen zu dem Befruchtungsact von *Achlya*. Jahrbuch für wiss. Botanik, Bd. XIV, S. 111.
- '88: b, Ueber die vermeintlichen Amöben in den Schläuchen und Oögonien der Saprolegnieen. Bot. Centralblatt, Bd. XIV, S. 378.
- SCHMITZ, F., '79: Untersuchungen über die Zellkerne der Thallophyten. Verh. des naturhist. Vereins der Preuss. Rheinl. und Westfalens, S. 345.
- STRASBURGER, E., '80: Zellbildung und Zelltheilung. IIIte Auflage. Jena.
- '94: The periodic reduction of chromosomes in living organisms. Annals of Botany, Vol. viii, No. XXXI.
- WAGER, H. W. T., '89: Observations on the structure of the nuclei in *Peronospora parasitica*. Annals of Botany, Vol. iv, No. XIII, p. 127.

ZIMMERMANN, A., '92 : Die Botanische Mikrotechnik. Tübingen.

ZOPF, W., '82 : Ueber Parasiten in den Antheridien, Oögonien und Oösporen von Saprolegnien. Bot. Centralblatt, Bd. XII, S. 356.

———— '83 : Erwiderung. Bot. Centralblatt, Bd. XV, S. 156.

EXPLANATION OF FIGURES IN PLATES XXIV AND XXV.

Illustrating Mr. Trow's paper on the Karyology of *Saprolegnia*.

The outlines of all important structures in the figures were traced with the camera lucida and the details then filled in by freehand. The highly magnified figures of the separate nuclei were, however, drawn entirely by freehand. Those referring to *S. dioica* were drawn from preparations stained with Schneider's acetic carmine and with the aid of Zeiss's apochromatic 2 mm. objective (aperture 1.3) and the compensating ocular 4. The magnifications given were determined by measurement.

The other figures were drawn from preparations stained with gentian-violet and eosin and with the aid of Zeiss's $\frac{3}{4}$ achromatic homogeneous immersion objective (aperture 1.3) and the Huyghenian oculars 2 and 4.

All the nuclei in a section have as a rule been represented by reducing them to the same optical section. Sections in which there were nuclei overlying one another were rejected as unsuitable.

Abbreviations: *an.* antheridium; *ch.* chromosome; *c. w.* cell-wall; *deg. n.* degenerate nucleus; *d. n.* dividing nucleus; *f. g. n.* female gameto-nucleus; *g. n.* gameto-nucleus; *m. g. n.* male gameto-nucleus; *n.* nucleus; *n. m.* nuclear membrane; *nu. hy.* nucleo-hyaloplasm; *oog.* oogonium; *v.* vacuole.

S. mixta, De Bary.

Fig. 1. *a.* Resting zoospore showing the structure of the nucleus. The deeply stained granules between the nucleus and the vacuole disappear before germination. *b, c,* and *d.* Germinating zoospores showing the division of the nucleus, and the formation of the germ-tube. The nuclei in *d* were further apart than they appear to be, the close grouping being partly due to the necessary process of reducing them all to the same optical section. $\times 1150$.

Fig. 2. *a* and *b.* Hyphae: *a* is a tangential section, *b* has been sectioned at various angles. The nuclei in *b* are abnormally elongated. $\times 1150$.

Fig. 3. *a.* Transverse section of a nearly mature sporangium. The arrows A and B point in the direction of two zoospore-rudiments whose nuclei were respectively above and below the optical section figured. $\times 1290$.

b and *c*. Radial and tangential sections respectively of the lower portion of a younger sporangium. The strands of protoplasm connecting the young spores are well seen. $\times 1150$.

Fig. 4. Median section, $7.5\ \mu$ thick, of a young oogonium which contained 72 nuclei. Its diameter was $29\ \mu$. $\times 1150$.

Fig. 5. Median section of an oogonium. The basal wall has been formed. Three of the antheridia attached to it are also represented. The nuclei are preparing for the reducing division. $\times 660$.

Fig. 6. *a*, *b*, *c*, *d*, and *e*. Nuclei undergoing the reducing division. In *d* the half chromosomes are seen in plan and in *e* in profile. The early stages are represented in *a* and *b*. The nuclear wall appears to be breaking down in *e* and the nucleo-hyaloplasm is dispersing itself in the surrounding protoplasm. $\times 2300$.

Fig. 7. An oblique section of the oogonium in which the nuclei of Fig. 6 were found. The antheridia were not drawn. The two half chromosomes are seen in most of the nuclei. The intact nuclear wall appears still to prevent the escape of the nucleo-hyaloplasm into the surrounding protoplasm. $\times 1150$.

Fig. 8. *a* and *b*. Dividing nuclei from an oogonium. *c* and *d*. Dividing nuclei from an antheridium. The half chromosomes lie more or less free in the protoplasm. $\times 2300$.

Fig. 9. Median section of an oogonium, one of the antheridia attached to which is also drawn. The nuclei are in the condition represented in Fig. 8, and the stained masses of nucleo-hyaloplasm and microsomata are still evident. $\times 1150$.

Fig. 10. *a* and *b*. Two sections of one oogonium and sections of two antheridia showing the completion of the development of the gameto-nuclei (the end of the reducing division) and the commencement of the degeneration of the rejected gameto-nuclei. $\times 1150$.

Fig. 11. *a* and *b*. Tangential and median sections of an oogonium (antheridia not drawn) which had a diameter of $50\ \mu$ and contained 46 gameto-nuclei. The oogonium was in the typically vacuolated condition. $\times 1150$.

Fig. 12. *a* and *b*. Tangential and nearly median sections of an oogonium (antheridia not drawn) at the stage preceding the commencement of the formation of the oosphere rudiments. $\times 1150$.

Fig. 13. Three successive sections of an oogonium (antheridia not drawn) with three oosphere-rudiments in the earliest stage of development. Degenerate fusion-nuclei are to be noted in these, but only three typical gameto-nuclei, one near the centre of each rudiment. $\times 1150$.

Fig. 14. Section of an oogonium with one uninucleate oosphere-rudiment. The three remaining sections contained three additional uninucleate rudiments. $\times 1150$.

Fig. 15. Section of an oogonium with 4 nearly mature uninucleate oospheres. The antheridium is proceeding to develop a fertilization-tube. $\times 1100$.

S. dioica, De Bary. Fertilization.

Fig. 16. Section of a large oogonium (antheridia not drawn) with three uninucleate oosphere-rudiments. All the other rudiments in the oogonium were likewise uninucleate. $\times 610$.

Fig. 17. Median section of a large oogonium with mature oospheres. The spongy character of the protoplasm is beautifully seen and also the single central

nucleus. One antheridium is drawn. Its fertilization-tube which is already almost in contact with an oosphere contains two male gameto-nuclei. $\times 610$.

Fig. 18. Section of an oogonium and two antheridia showing fully developed fertilization-tubes and two newly formed oospores. $\times 610$.

Fig. 19. Section of an older oogonium showing the pair of gameto-nuclei in the oospores still unfused but decidedly larger. $\times 610$.

S. Thureti, De Bary. Typical apogamy.

(Possibly apogamous oogonia of *S. mixta*, De Bary.)

Fig. 20. Section of an oogonium with uninucleate oospores. The nuclei are still small. $\times 660$.

Fig. 21. Section of an older oogonium with uninucleate oospores. The nuclei have increased greatly in size and have the same appearance as those about to undergo the reducing division except that the chromosome is much smaller. $\times 660$.

S. mixta, De Bary. (Intermediate condition with respect to apogamy.)

Fig. 22. Section of an oogonium with oospores. One oospore is distinctly binucleate. The one to the right beneath had a second nucleus in another section. All the other oospores in the oogonium had certainly one nucleus, and some of them might possibly have had two. $\times 660$.

S. dioica, De Bary. Maturation of the oospores.

Fig. 23. *a, b, c, d,* and *e.* Oospores in successive stages of development. The large deeply stained granules around the nucleus in *e* are developed from the smaller ones seen in *b*. $\times 610$.

S. Thureti, De Bary. Germination of the oospores.

Fig. 24. Two uninucleate oospores. $\times 1150$.

Fig. 25. A uninucleate and binucleate oospore. The separation of the nuclei in the latter is just completed. The indentation in the wall is the result of the method of preparation and is rather exceptional. $\times 1150$.

Fig. 26. *a* and *b.* Successive sections of an oospore with 5 nuclei. $\times 1150$.

Fig. 27. *a* and *b.* Successive sections of an oospore with 6 nuclei. $\times 1150$.

Fig. 28. *a, b, c,* and *d.* Successive sections of an oospore with 8 nuclei, in which the zoospore-rudiments have already commenced to form. $\times 1150$.

Fig. 29. One section out of four, of an oospore in which eleven zoospores had just been formed. $\times 1150$.

Fig. 30. Section of a germinating oospore which contained altogether 12 nuclei, and has developed a germ-tube with a view to the formation of a normal sporangium. $\times 1150$.

Fig. 31. Tangential section of a chlamydo-spore of *S. mixta*. $\times 1150$.

Fig. 32. Tangential section of an oogonium of *S. dioica* showing pseudo-karyokinetic figures. The figures are due to imperfect preparations of nuclei in the process of undergoing the reducing divisions. $\times 610$.

NOTES.

THE FORMATION OF BACTERIAL COLONIES¹.—During the detailed examination of a large number of forms or species of Bacteria from the Thames, I have been struck, as have other investigators, with the extreme difficulty—not to say impossibility—of successfully employing the diagnoses given in authoritative works, such as Eisenberg's *Bakteriologische Diagnostik*. Over and over again prolonged cultures of a given form showed departures in sometimes one and sometimes another direction; and although the generality of the characters sufficed to diagnose a type nearer to one or another of the accepted 'species,' the variations were so numerous that it was difficult to do anything with them beyond describing all the 'varieties.'

This was not due to differences in the cultures in the ordinarily accepted meaning of the word, because half a dozen forms of the same type varied when cultivated side by side in the same media, and consequently it was impossible to admit that differences in the conditions of culture (in the ordinarily accepted meaning of the term) were responsible.

The suspicion therefore arose that one and the same 'species' of *Bacterium* will differ in its behaviour according to the vicissitudes it has been subjected to in the river previously to its capture: in other words, that 'varietal' forms occur stamped for the time being with acquired characters.

On the other hand, the possibility existed that in cultures side by side, assumed to be identical, and still more in the case of cultures in media prepared according to the same formula but at different times—e.g. two brews of peptone-gelatine, or two potato-tubes prepared from different potatoes—causes of variation might exist far too subtle for detection, but which nevertheless have their effect on the sensitive organization of the Schizomycetes.

Consequently I attempted the task of cultivating gelatine-plate-colonies under such circumstances that the very earliest stages of development could be observed directly under the highest powers of the microscope, so as to see how colonies are built up from the first division of a Bacillus until the usual macroscopic characters of the colony are recognizable, as in ordinary plate-cultures.

This was done by isolating simple Bacteria in a hanging drop of

¹ Read before the Botanical Section of the British Association at Ipswich.

gelatine by the method described in my Fourth Report to the Royal Society Water-research Committee¹, and so arranging matters that the gelatine-drop, &c. forms a plate-culture, the floor of which is the thin cover-slip. In fact, if we suppose a modified Petri-dish with the glass floor so thin that the whole thickness of the gelatine film can be optically pierced by a one-twelfth immersion, the essential conditions are obtained.

When the colonies become visible to the unaided eye, it is easy to inoculate a tube and test the purity of the culture, &c., by the ordinary methods.

In other cases, I utilized the method of preparing *Klatschpräparate*. A sterile cover-slip is held by sterile forceps and laid flat on a growing colony, a thin film of nutrient gelatine having been distributed over the contact side of the cover-slip: this is then lifted and used as if it were a hanging-drop preparation. The adherent Bacilli, fixed *in situ* on the film of gelatine, can then carry on their growth, &c., under observation.

It usually happens that when a rodlet, fixed in solid gelatine, grows to twice its length and then divides, the two daughter-cells slip one over the other *as if the elasticity of the gelatine* made itself effective on the free distal ends, and this phenomenon is repeated, so that when say a dozen or twenty divisions have occurred, we have a group of rods irregularly side by side in a spindle-shaped micro-colony. It is in this way that the frequent occurrence of 'whetstone-shaped' and 'oval' submerged colonies is to be explained. Subsequently, as the gelatine is softened around, these may gradually round off to a spherical shape.

Another proof that the elasticity of the gelatine comes into play is afforded by such observations as the following. A *Micrococcus* or *Bacillus* having divided many hundreds of times, forms a perfectly spherical colony. The gelatine then softens at one point on the periphery of the submerged sphere, whether by local increase of enzyme or otherwise does not matter, and a rounded protuberance of the colony at once forces its way into the softer gelatine, converting the whole colony into a pyriform shape. As this occurs, all the diameters of the rounded part of the pear—i.e. the previous sphere—perceptibly diminish. In other words, the elastic pressure of the gelatine forces the colony to bulge into the yielding gelatine. Later on other local protuberances may occur in the same way, and the rapidly enlarging colony then assumes moruloid or lobed shapes, such as are common in submerged colonies.

¹ Proc. R. Soc., vol. lviii. pp. 12 and 13.

If the direction of least pressure on a submerged spherical colony of the above description happens to be at right angles to the free surface of the gelatine-film, then the colony bursts to the exterior and emerges as it were like a fountain, oozing out its Bacilli or Cocci, &c., in the form of a button-like drop, or a flat cake, film, &c. according to circumstances. In these cases the dark submerged 'manubrium' of the colony shows long after emergence the point in gelatine where the Bacilli burst through.

If, on the other hand, the still submerged spherical colony begins to liquefy the gelatine equally all round its periphery, a beautiful play of chemotaxis comes in: the superficial Bacilli arrange themselves at right angles to the periphery, in the zone of liquefied gelatine, and form a radiating fringe. In some cases this may be brought about by softening of the gelatine by a slight rise of temperature, and possibly by other agencies than the direct liquefying power of the Bacilli.

Turning now to emerged colonies. It is pretty clear that the flow over the free surface of the gelatine may be affected by several factors, and especially by the degree of moisture. If a damp film exists, or if the *Bacillus* can slightly liquefy, the free spreading of the colony is favoured much more than when the gelatine is relatively dryer or the *Bacillus* weak, and it is obvious how this may be profoundly affected by tardy emergence, differences in hygroscopic properties of the gelatine-film, dry or moist atmosphere, temperature, &c. Several cases are given where colonies of one and the same form behave in this respect so differently on emergence, that they might be taken for different species, and would probably be so described by bacteriologists unacquainted with these phenomena.

That the liquefying power of Bacteria varies is well known, and I have been able to show that with comparative plate-cultures of one and the same form the rapidity of liquefaction, like the rate of growth, can be affected by exposure to light and other agents, and in these cases the appearance of the resulting colonies may be so different that no one would suppose them to belong to the same species.

In pursuance of the subject, I have made a large number of cultures to see if exposure to light alone will so affect the organism that its after-behaviour is modified. Several species have been exposed in tubes of broth or of water to sunshine, with control tubes shaded from the light. The usual effects—death of Bacilli in the light, and retarded growth of those which survive—were confirmed, but it has not

as yet been possible to obtain a distinct varietal form definitely due to the modifying action of the light alone from these tubes. On growing colonies in the dark, in normal gelatine, the Bacilli retarded by the light-action slowly recover their usual characters after a time. Even after numerous transferences from light-tube to light-tube, and dark-tube to dark-tube, day after day, the same recovery occurs, and the colonies are not affected in any permanent way.

While actually growing in gelatine, on the other hand, very slight exposures affect the appearance of the colonies, and if the effects of varying temperatures (within limits in no way fatal to the plants) are superposed on those of light, some marked changes in shape, rate of growth, and even pigmentation may be induced.

Much research will be necessary, however, before the problems here raised are settled.

Growth is very easily affected by much slighter changes of condition than is usually accepted, and my experiments convince me that plate-cultures 'at ordinary temperatures'—or 'at the temperature of the room' (*Zimmertemperatur*)—so often employed in diagnoses, are useless. The exact temperatures must be quoted, and they must not be allowed to vary.

In many cases, the emerging colonies form extremely thin films on the gelatine-surface, the play of light on which gives the iridescence so often quoted as a character. These films may consist of contorted or coiled tresses of filaments, lying parallel on the flat surface, like coils of rope: if growth is so vigorous that these films become more than one filament thick, the iridescence may not appear: if local liquefaction occurs, the filaments may break up into isolated Bacilli in patches, and curious mottled or mosaic-like, or tortoise-scale-like patterns may occur. If the liquefaction is more vigorous, the whole film may be set in curious amoeboid movements, and rapidly extend over the surface of the gelatine. I have a whole series of forms which seem to connect extremes where liquefaction of ten per cent. peptone-gelatine is rapidly brought about (in forty-eight hours or less) by means of these creeping and almost invisible surface-films, with others where the hyaline film shows no movements and the segments remain connected in coiled filaments.

The size—both length and thickness—of Bacilli may differ in different parts of the same colony; and forms, usually described as non-motile, may often be shown to be motile under given conditions.

Colour-variations have long been known. I have confirmed the occurrence of white varieties of crimson forms, and find considerable variations in yellow pigmented forms. An interesting case is that of white varieties of a violet *Bacillus*, so permanent that I have cultivated it for weeks and even months as a white form, and can only get it to produce its pigment in broth, though otherwise it seems vigorous enough.

In view of these and other results, which I hope to publish later, it seems extremely probable that the following three propositions are true.

(1) That variations in the form, rate of growth, size and colour, and other characters of plate-colonies result from much slighter variations in the gelatine and other environment than has hitherto been recognized.

(2) That, regarding the water of a river as the food-medium, the vicissitudes which a *Bacillus* has been exposed to in this medium previous to its capture and isolation in the laboratory, may have stamped on it such differences that its plate-colonies differ considerably at different times of the year, or even in the same season according to the length of time the individual germ isolated has been in the river.

(3) It is in great part owing to the coincidence of these causes of variation that it is often so difficult to recognize a given 'species' described in Eisenberg and other authorities: in fact, the same 'species' recurs under different names, because the conditions preceding and during its cultivation in the laboratory have differed more or less.

The only way out of this difficulty will be, I think, to cultivate each form from the beginning for a sufficiently long period under conditions as accurately known as possible, and strictly according to some carefully arranged plan agreed on by bacteriologists in council beforehand.

H. MARSHALL WARD.

A FALSE BACTERIUM¹.—During my investigations of the bacterial flora of the Thames, a form has turned up which well illustrates the truth that the methods of tube-plate-cultures of minute organisms may lead one astray, and that in order to settle the question of the nature of such forms we must employ the methods of direct cultivation from a single germ under powers of the microscope: that, in fact, we must supplement the macroscopic gelatine-plate-cultures of Koch and his followers by the original *microscopic* gelatine-cultures of Klebs, Brefeld, and De Bary, which preceded and suggested the now usual methods.

¹ Read before the Botanical Section of the British Association at Ipswich.

The organism in question forms non-liquefying porcelain-like white or cream-coloured colonies on gelatine, and behaves exactly like a Schizomycete when grown on Agar, Potato, and in Broth, Milk, and other media. It does not ferment glucose, and when examined in the usual way under the microscope it appears as a Bacillus-like form 2-4 μ long, and about 1 μ thick, or as 'cocci' about 1 μ diameter staining normally by Gram's and other methods, without movements, and with no known endogenous spores.

Nevertheless, on tracing its development even *in alkaline gelatine*, under the one-twelfth and one-twentieth immersion, it is found to branch and to grow by acropetal apical growth. When a short branch-system has been formed, the whole segments up entirely into joints like Bacilli, which eventually separate at the septa, and are at length cut up into shorter and shorter portions almost like micro-cocci or extremely short Bacteria.

From all the evidence there can be no doubt that we have here an òdial form of a true Fungus, and not a Schizomycete at all, and it raises some interesting questions concerning alleged forms of 'branching' Bacteria, and the very various origins of the different micro-organisms commonly grouped together as 'Bacteria.' In particular, it is an excellent case in point, illustrating the fact that an organism must not be assumed to be a Schizomycete merely because it is small, grows on gelatine, and can be stained by the methods of bacteriology.

H. MARSHALL WARD.

ON A NEW FORM OF FRUCTIFICATION IN SPHENOPHYLLEAE¹.—The author gave an account of *Bowmaniles Römeri*, the fructification of a new member of the Sphenophylleae. It is only recently that the work of Williamson and Zeiller² has given us a clearer insight into the structure of the fructifications of *Sphenophyllum*, which consist of successive and similar whorls of leaves arranged in a spike, the leaves of each whorl being coherent at the base. The numerous sporangia are seated on the inner and upper side of this

¹ Abstract of a paper read before the Botanical Section of the British Association at Ipswich. For the full illustrated description see Jahrbuch der K. K. Geolog. Reichsanstalt, Wien, 1895, Band 45, Heft 2.

² See Williamson, Organization of Fossil Plants of Coal-measures, Parts V and XVIII, Phil. Trans. 1874 and 1891; Williamson and Scott, Further Observations on Organization, &c., Part I, Phil. Trans. 1894; Zeiller, L'Appareil fructificateur des Sphenophyllum, Mém. 11 de la Soc. Géol. de France, 1893.

sheath-like portion of the whorl, ranged in two or three concentric circles between each two whorls of leaves. Each sporangium is borne on a thin stalk, from the apex of which it is suspended, bending over towards the axis. At the bend, just where the stalk passes over into the base of the sporangium, we find a crested ridge, characterized by large thick-walled epidermal cells, like those of an annulus. Zeiller has come to the same conclusions from studying specimens preserved as impressions, which Williamson arrives at from the sections of his *Bowmanites Dawsoni*, and has declared the two forms to be identical, both belonging to *Sphenophyllum cuneifolium*. It seems, however, that this specific identification will not hold good.

The author found exactly the same structure in the original specimen of *Bowmanites germanicus*, Weiss, and in a fruit-spike of *Sphenophyllum emarginatum* in the Dresden Museum.

A different structure, however, is exhibited by a fragment of a cone, which the author has named *Bowmanites Römeri*, and which was found by Ferdinand Römer on the refuse-heaps of the Nieldzielisko Colliery in Cracow. In the first place, the superposition of the successive whorls forming the spike could here be determined with certainty. It could further be shown that several successive circles of sporangium-pedicels are inserted upon each whorl. While, however, in all forms of *Sphenophyllum* previously investigated, only a single sporangium is borne on the recurved end of the pedicel, in the new form two sporangia are suspended from a scale-like enlargement at the apex of each pedicel. In all other points of its organization there is the greatest similarity with the specimens already known.

H. GRAF ZU SOLMS-LAUBACH, Strassburg.

PRELIMINARY NOTE UPON THE STRUCTURE OF BACTERIAL CELLS¹.—In this preliminary paper, which is a continuation of some work already referred to in the *Annals of Botany*², a short account is given of observations which have been in progress for some time upon the structure of bacterial cells, especially with reference to the question of the presence or absence of a nucleus. It is, I think, generally admitted that the structure of the bacterial cell is of a simpler kind than that of other cells; but nearly all observers agree in stating that some kind of structure akin to the nucleus is

¹ Abstract of a paper read at the Ipswich meeting of the British Association before the Botanical Section.

² *Annals of Botany*, Vol. v, p. 513.

present. Bütschli has pointed out the existence of a central body in various bacterial cells, the structure of which is similar in many respects to that of the nucleus in some forms of Infusoria ; but whether Bütschli's central body is to be regarded as a nucleus or not, depends upon the interpretation to be placed upon certain structures which, according to Bütschli, are to be regarded as cytoplasmic. The discussion of this question must, however, be reserved for the complete paper ; I propose now merely to give an outline of my own observations without referring to the numerous other observers who have made a study of the subject.

The first form to be described is a short *Bacillus*, oval in outline, sometimes almost of a Coccus-form, which was found forming a pellicle upon water containing a quantity of putrefying tadpoles. In this form the cell-wall appears to possess a thick gelatinous membrane which stains, if at all, only slightly. In the protoplast two parts can be distinguished—a central rod which stains deeply in fuchsin and other aniline dyes, and fairly deeply in Delafield's haematoxylin, and is not digested by pepsin ; and a slightly stainable substance in connexion with it, which is only distinctly visible at the two ends of the cell. Such a structure is perhaps the simplest to be found in any bacterial cell. Division of the cell is always preceded by division of the central rod.

In other Bacteria the structure of the cell is not quite so simple, but, as I hope to show in the complete paper, the structure of all bacterial cells may be referred to this type, and they may be regarded merely as more or less differentiated forms of this simple one. In *Spirillum undula*, for example, numerous deeply stained bands are to be seen in specimens carefully stained with various aniline dyes, especially fuchsin, crossing the cell in a transverse direction ; these vary in number and size in different individuals. On examining them closely we find that they are peripheral and in close contact with the cell-wall, and do not extend all across the cell. They are connected with one another by a layer of less deeply stained substance. They apparently increase in number by a more or less regular process of division, and at certain stages they may divide more irregularly and even form granules arranged at the periphery of the cell and connected together by a network of the less deeply stained substance. Between the simple form first described and this much more complicated structure of *Spirillum undula*, forms will be described which show that we are dealing in both cases with practically the same organization.

We may, I think, conclude that in a bacterial cell there are two different substances to be recognized—a nuclear substance and a cytoplasmic substance; that the nuclear substance has a definite structure, which is found in principle in all bacterial cells, and which plays an important part in the division of the cell; but that it is simpler in structure and form than the nucleus of the higher plants and animals.

HAROLD WAGER, Leeds.

THE WEALDEN FLORA¹.—The Wealden strata of Surrey, Sussex, Kent, and the Isle of Wight have long been familiar to geologists as the delta-deposits of a large freshwater, or possibly brackish, lake of Lower Cretaceous age. Bones of *Iguanodon* and the remains of other fossil animals were discovered in these beds many years ago, and latterly fragments of a genus of *Mammalia* have been described from Wealden strata. The vegetation which grew on the land bordering the lake has hitherto been known to us in the form of a few meagre specimens of Pteridophytes and Gymnosperms preserved in the delta sediments.

During the last few years there have been discovered in the Wealden rocks of the Hastings district numerous and clearly preserved examples of this interesting flora, and, thanks to the energy and enthusiasm of Mr. Rufford, the Wealden flora is now much more fully represented in the collections of the National Museum.

In a short note², it is impossible to do more than enumerate the species which have been determined from the material in the Rufford collection, with the addition of those first described by Stokes and Webb, Mantell, Carruthers, Gardner, and others. The following list includes such British species of Wealden plants as are at present known, but we may confidently expect that fresh material will soon be acquired from the rich plant-bearing strata of Ecclesbourne and Fairlight.

ALGAE: *Algites valdensis*, sp. nov.; *A. catenelloides*, sp. nov.; *Chara Knowltoni*, sp. nov. HEPATICAE: *Marchantites Zeileri*, sp. nov. PTERIDOPHYTA: *Equisetites Lyelli*, Mant.; *E. Burchardti*, Dunk.; *E. Yokoyamae*, sp. nov.; *Onychiopsis Mantelli*, (Brong.); *O. elongata*, (Geyl.); *Acrostichopteris Ruffordi*, sp. nov.; *Matonidium Göpperti*, (Ett.); *Protopteris Witteana*, Schenk; *Ruffordia Göpperti* (Dunk.); *Cladophlebis*

¹ Read before the Botanical Section of the British Association at Ipswich.

² For a fuller account of this flora see Fossil Plants of the Wealden (British Museum Catalogue), Part I, 1894, and Part II (in the Press).

longipennis, sp. nov.; *C. Albertsii*, (Dunk.); *C. Browniana*, (Dunk.); *C. Dunkeri*, (Schimp.); *Sphenopteris Fontainei*, sp. nov.; *S. Filtoni*, sp. nov.; *Weichselia Mantelli*, (Brong.); *Taeniopteris Beyrichii*, (Schenk); *T. Dawsoni*, sp. nov.; *Sagenopteris Mantelli*, (Dunk.); *S. acutifolia*, sp. nov.; *Microdictyon Dunkeri*, Schenk; *Dictyophyllum Römeri*, Schenk; *Leckenbya valdensis*, gen. et sp. nov.; *Tempskya Schimperii*, Cord.

GYMNOSPERMAE: *Cycadites Römeri*, Schenk; *C. Saporatae*, sp. nov.; *Dioonites Dunkerianus* (Göpp.); *D. Brongniarti* (Mant.); *Nilssonia Schaumburgensis*, (Dunk.); *Otozamites Klipsteinii* (Dunk.); *O. Göppertianus*, (Dunk.); *Zamites Buchianus*, (Ett.); *Z. Carruthersi*, sp. nov.; *Anomozamites Lyellianus*, (Dunk.); *Cycadolepis*; *Carpolithes*; *Androstrobilus Nathorsti*, sp. nov.; *Conites elegans*, Carr.; *C. armatus*, sp. nov.; *Bucklandia anomala* (S. & W.); *Fittonia Ruffordi*, sp. nov.; *Bennettites Saxbyanus*, (Brown); *B. Gibsonianus*, Carr.; *B. (Williamsonia) Carruthersi*, sp. nov.; *Yatesia Morrisii*, Carr.; *Withamia Saporatae*, gen. et sp. nov.; *Becklesia anomala*, gen. et sp. nov.; *Dichopteris*, sp.; *Sphenolepidium Kurrianum* (Dunk.); *S. Sternbergianum* (Dunk.); *Pagiophyllum crassifolium*, Schenk; *Brachyphyllum obesum*, Heer; *B. spinosum*, sp. nov.; *Pinites Solmsi*, sp. nov.; *P. Carruthersi*, Gard.; *P. Dunkeri*, Carr.; *P. Mantelli*, Carr.; *P. patens*, Carr.; *Thuites valdensis*, sp. nov., &c.

Without attempting to discuss any special points of interest connected with the above species, we may briefly consider the flora as a whole, and note how far it throws light on certain questions of botanical and geological interest. There is little doubt that it was in Wealden times, or probably at the close of that period, that angiospermous plants first made their appearance as members of the world's vegetation. In the Potomac beds of North America, which comprise rocks of Wealden age with others on a somewhat higher geological horizon, and in the thick series of Lower Cretaceous and Upper Jurassic plant-beds of Portugal, there have been discovered several undoubted examples of monocotyledonous and dicotyledonous species. Speaking of the Wealden flora, a reviewer has well said¹: 'It is as if we stood at the mouth of a great river flowing from an unexplored interior, whose flotsam we anxiously interrogate for clues as to the nature of the unknown hinterland; yet nothing reaches us from beyond the coast-belt, which we have already explored.' In spite of the comparatively large number of forms at present known from these beds, there are

¹ *Nature*, July 26, 1894, p. 294.

none which can be reasonably regarded as angiospermous plants. If we compare the Wealden flora with that of the preceding Jurassic epoch, and again with the flora of overlying beds, we find in the former case a very striking similarity, and in the latter an almost equally well-marked difference. In short, the Wealden vegetation seems to be of essentially the same character as that which is so well represented in the Jurassic rock of the Yorkshire cliffs. Questions of climate and geographical distribution are of considerable interest when we are dealing with geological floras, but speculations as to climatal conditions are as a rule far from satisfactory when the evidence is furnished by extinct species. So far as it is possible to draw any conclusions of scientific value, our extended knowledge of Wealden plants supports the view of more or less tropical conditions of growth. A detailed comparison of the English species with those from other parts of the world, shows very clearly an exceedingly wide distribution of some characteristic forms, and points to a distinct uniformity in the vegetation of this period in widely separated regions. As points of some botanical interest, brought out by an examination of the English plants, mention may be made of the evidence obtained in support of the generic identity of *Williamsonia* and *Bennettites*, and the discovery of fertile pinnae in *Sphenopteris Mantelli* and other ferns; but limits of space preclude any discussion on these and other matters of greater or less botanical importance. A. C. SEWARD, Cambridge.

THE NUCLEI OF LILIUM LONGIFLORUM.—If the chromosomes of the dividing nuclei in the growing-point of the stem of this Lily are counted, it is found that their number is variable; thus nuclei with sixteen or twenty-four chromosomes are the most usual, and of these the former number is the most frequent. Besides these nuclei there are others which very probably contain intermediate numbers, e. g. eighteen, twenty, twenty-two. Again, in the divisions taking place in the pollen-mother-cells and in the upper nuclei of the embryo-sac a variation occurs. Some pollen-mother-cells contain nuclei with eight, others with twelve or ten chromosomes and that too in the same pollen-sac. In the upper nuclei of the embryo-sac eight, ten, or twelve chromosomes are found.

Before entering on the early stages of karyokinesis, the nucleus of the pollen-mother-cells of this plant possesses a very delicate and complexly coiled nuclear thread. Portions of this thread lie parallel

to one another, and in some places these parallel portions present the appearance of a single thread which has undergone longitudinal fission. That this is not the case, however, appears probable from the sudden divarications of these portions of the thread and the way in which they often lie across each other, and also from the fact that in later stages the divarications are not so conspicuous. As the thread thickens the parallel portions become more regular in their disposition, and finally transverse fission divides it into a number of chromosomes, each composed of two portions lying more or less exactly parallel to one another. Sometimes the two portions of a chromosome form a loop which is possibly derived from a loop in the original thread, and sometimes they are twisted round one another. Thus it appears that the double form of the chromosomes before the formation of the nuclear plate is in this case not due to longitudinal fission of the nuclear thread, but to the lateral approximation of portions of it in pairs.

As the chromosomes arrange themselves at the equator, they become simultaneously shorter and thicker, and they dispose themselves so that the plane of division between their two short rod-like parts is vertical and is not in the equatorial plane. These two parts are in close contact with one another and seem fused together at their inner extremities, while their outer or peripheral ends are often slightly parted. So that when seen from the poles at this stage they appear triangular, quadrate, or ring-shaped. Viewed from the equatorial plane each chromosome has the characteristic humped form. In the nuclear plate each undergoes horizontal longitudinal fission beginning at the inner end (so that seen in profile each chromosome now appears T-shaped), and as this proceeds two daughter-chromosomes are formed. As these latter separate from one another, the rod-like portions, which form them, diverge from one another, so that a diamond-shaped space is enclosed between the two daughter-chromosomes. When the latter are approaching the poles their two rod-like portions part asunder from one another, so that at the poles there appear twice as many short, straight chromosomes as there were at the equator.

From the process described it appears probable that each chromosome in this karyokinesis represents two of previous nuclear divisions, which have become more or less completely united end to end. Their double nature is shown in their mode of origin of the two parallel portions of the chromosomes which exist prior to the formation of the nuclear plate and in the separation of the two parts of the

daughter-chromosomes as they approach the poles. Thus the reduction in number is effected by an end-to-end fusion of the chromosomes, as Strasburger has already suggested.

The next division by which the pollen-tetrads are formed takes place probably according to the normal karyokinesis in plant-cells, as it is found to do so in *Lilium Martagon* and *L. chalcedonicum*. In these two species not only were the slender chromosomes forming the equatorial plate observed, but also their longitudinal fission which is similar to that which takes place in vegetative cells.

Before signs of approaching karyokinesis are apparent in the primary nucleus of the embryo-sac, fibres of great distinctness develop in the protoplasm of this cell, forming a spindle above and completely outside the nucleus, in position and appearance recalling Hermann's figure of the sperm-mother-cell of *Salamandra maculata* preparing for division (Archiv f. Mikrosk. Anat. 37). During division this nucleus behaves, so far as has been observed, with complete similarity to that of the pollen-mother-cells. In the later nuclear divisions in the embryo-sac, the doubling of the nuclear thread before the formation of the chromosomes, and the fission in the nuclear plate into V-shaped daughter-chromosomes, were not to be observed; in a few cases, however, the nuclear plate was seen to be composed of the humped chromosomes characteristic of the first division in this cell and in the pollen-mother-cells. But in the great majority of cases which were observed of these later divisions, the equatorial plate was formed of the usual slender bent chromosomes, which cleave longitudinally when in this position. Another point of interest connected with this embryo-sac is the fact that even without fertilization its central portion becomes occupied by a large number of nuclei. These nuclei arise by *direct* division and are formed as far as, at present, can be made out from the lower polar nucleus¹. H. H. DIXON.

TRINITY COLLEGE, DUBLIN.

ABNORMAL NUCLEI IN THE ENDOSPERM OF FRITILARIA IMPERIALIS.—In some material which was fixed during the spring of 1894, I have found some very peculiar forms of direct nuclear division, as well as intermediate forms between direct and indirect division. Nuclei before direct fission often attain monstrous

¹ Fuller details of this and the following note were laid before the Royal Irish Academy on Nov. 11, 1895, and will be published with illustrations in their Proceedings, Vol. III, Pt. 4.

dimensions; thus one nucleus measured 0.3 mm. long and 0.2 mm. broad. Sometimes these nuclei break up simultaneously into a large number of small nuclei, sometimes they become constricted in the middle, and after drawing out into the shape of an hour-glass divide into two equal daughter-nuclei. In another form of a direct division the nucleus forms a large number of bud-like projections from its surface which become separated from the parent nucleus. Ring-shaped nuclei were also often met with, which divide into two, three, or four daughter-nuclei according to the number of places in which the ring becomes attenuated.

It was in the smaller nuclei I observed transition-forms between direct and indirect fission. In these cases the nucleoli disappear and the nuclear thread breaks into a number of chromosomes; but without the nuclear membrane dissolving or the formation of a nuclear plate, the nucleus becomes constricted across the middle so that it appears dumbbell-shaped. The piece connecting the two daughter-nuclei usually lies more to one side than the other, and beside it is formed an apparently normal achromatic spindle. The solution of the nucleoli and the persistence of the nuclear membrane during these direct divisions prior to the formation of the spindle, supports the view that this latter structure is in part derived from the nucleolar substance. In these divisions I could not observe a longitudinal fission of the nuclear thread.

It is to be noted that the direct as well as the transition-forms of nuclear division were, in the cases observed, found in groups among nuclei exhibiting normal karyokinetic figures, from which we may conclude that the abnormal forms are not the result of imperfect fixing, and also that the same stimuli give rise to both kinds of division. Nearly all these forms of nuclear fission have been observed in animal cells, but so far as I am aware, they have not been recorded as occurring in plants.

H. H. DIXON.

TRINITY COLLEGE, DUBLIN.

FURTHER INVESTIGATIONS ON SPORE-FORMATION IN FEGATELLA CONICA.—I have already (page 489 et seq.) described the chief points connected with the nuclear divisions in this plant. Since that paper was written my plants have fruited again, and as a large amount of material has rendered it possible to fill up some of the gaps existing in my previous account, I now briefly summarize the new results.

(1) As the spore-mother-cell approaches the period of division, the nucleus becomes oval, and the linin aggregates in the vicinity of the nucleolus, which is commonly situated at or near one end of the nucleus. Some portions of the linin however still protrude as threads or network from the aggregated portion.

(2) The nucleolus suddenly becomes vacuolated and often fragments, the linin is seen to consist of a tangle of double filaments, indicating that the longitudinal fission has already occurred. Frequent anastomoses are obvious.

(3) The nucleus becomes asymmetrical owing to the linin and nucleoli becoming massed about the middle of one side.

(4) The achromatic spindle next appears with extraordinary suddenness. It is bipolar, but of a peculiar form. The polar angles of the spindle are very wide, whilst the depth of the flat spore-mother-cell is comparatively slight. Thus the transverse section of the spindle at the equator becomes elliptical instead of circular, and the chromosomes are seen to be collected on one side, instead of being uniformly distributed around the equator (cf. par. 3). When observed from the flat side of the cell, the spindle is seen to present the form of a triangle, at two of the angles of which fine centrospheres are visible, whilst the chromosomes are grouped at the remaining angle. It must be stated that this appearance is seen both in sections, and also in uninjured cells teased out of the sporogonium and mounted in glycerine tinged with eosin. The general effect produced strongly recalls the development of the spindle during the division of the spermatocytes of Salamanders, as described by Hermann¹, and indeed his figures 8 and 9 would almost serve to illustrate these spindles in *Fegatella*. The origin of the structure is, however, different in the two cases, and the form in *Fegatella* is probably connected partly with the contour of the cell, and partly with the existence of the lateral aggregation already (3) referred to. The strand connecting the two centrospheres consists of *unbroken* threads, and it is weaker than those which run from these bodies to the chromosomes.

(5) Very extensive radiations extend from the centrospheres into the surrounding protoplasm, and they may often be traced *quite to the periphery* of the cell. Furthermore, weak radiations also extend from the equatorial patch of chromosomes towards the nearest wall. The latter filaments suggest the existence of an early tripolar spindle; and

¹ Hermann, Archiv für mikr. Anat., Bd. xxxvii.

though observation does not yet confirm this, and the regularly oval shape of the nucleus militates distinctly against it, it is not otherwise *a priori* improbable that a third centrosphere might be differentiated just outside the nucleolar mass referred to in par. 3, but in this case it must be excessively fleeting.

(6) The spindle next becomes longer by the wider separation of the centrospheres, and at the same time it loses its 'lop-sided' appearance. The division of the chromosomes conforms to the type of the first mitosis in the pollen-mother-cell of the Lily.

(7) After the separation of the elements of the daughter-nuclei, a cell-plate is formed, which does not extend to the peripheral walls. It subsequently shrinks somewhat, but remains suspended *transversely* within the cell.

(8) The two daughter-nuclei, after almost going into a condition of rest, divide with the formation of wide-angled spindles. The 'lopsided' arrangement of the chromosomes is however seldom met with, but when present, radiations also extend from the aggregation of chromosomes.

(9) The axis of these second division-spindles is variable, but from the axis of that pole which happens to lie nearest the primary cell-plate above alluded to, radiations are observed to branch off, and to connect with it. Thus the two spindle-poles which lie on opposite sides of the plate act as a 'couple,' and they cause it to rotate through an angle of 90° , so that it now lies *longitudinally* in the cell. During the rotation, the spindle-poles shift somewhat, and the fibres connecting them with the plate form the fifth spindle referred to on page 493. This rotation is perfectly constant, as is the position taken up by the four daughter-nuclei (see Pl. XVIII, Fig. 65). The formation of the new cell-plates, and their mode of attachment to the first one, have already been described. The whole process is susceptible of an obvious mathematical interpretation; soap-films introduced into a box, corresponding in shape to that of the spore-mother-cell, take up precisely similar positions. The arrangement of the spindle-fibres, and especially their mode of attachment to the cellulose framework, are in precise conformity with what, on mechanical considerations, might have been anticipated.

(10) The cells which form the elaters separate from each other by means of a mucilaginous degeneration which affects the entire wall except the innermost layers around each cell-cavity.

J. BRETTLAND FARMER.

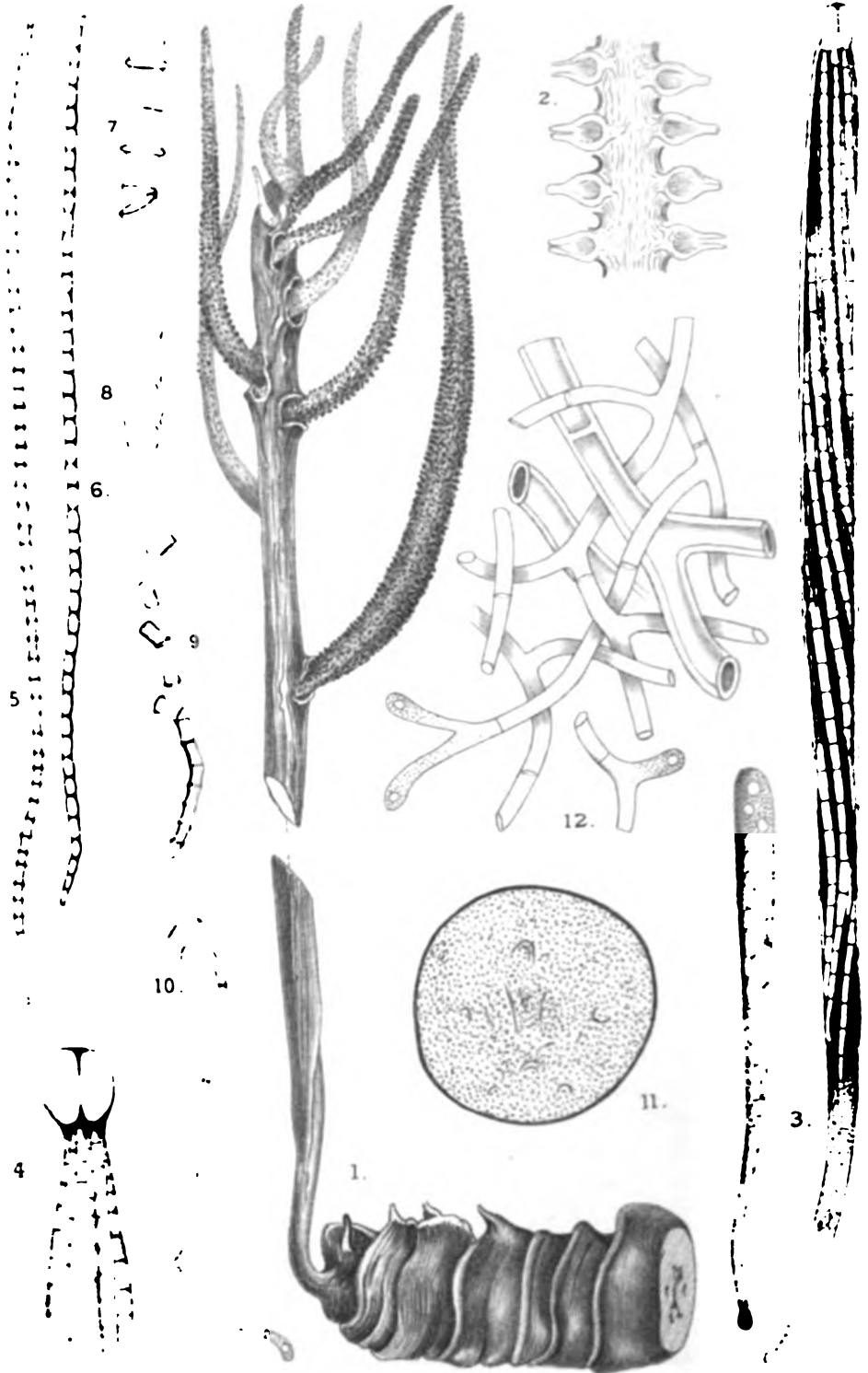

G. Massee del.

Illustrated by Prentiss

MASSEE — CORDYCEPS HENLEYAE.

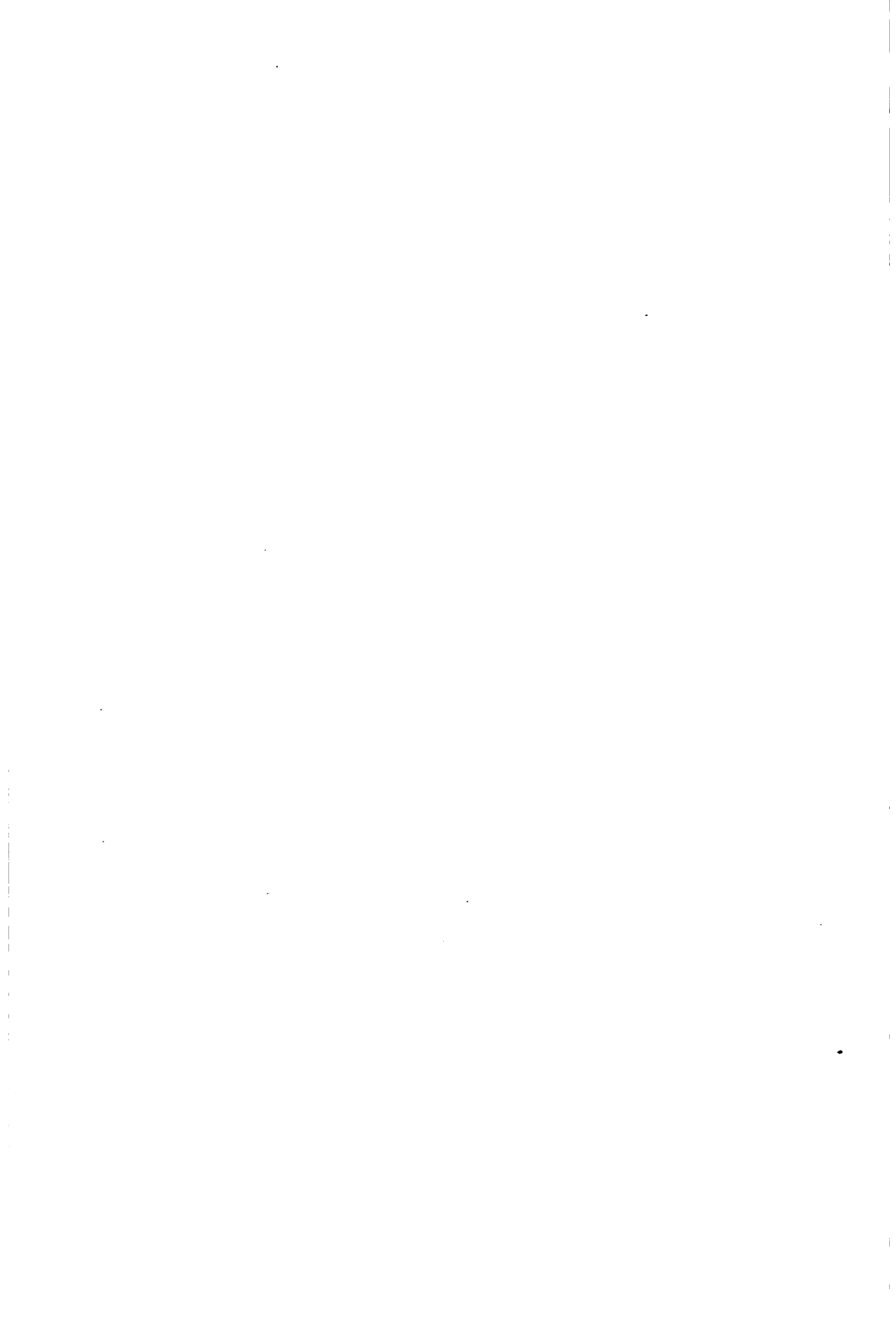



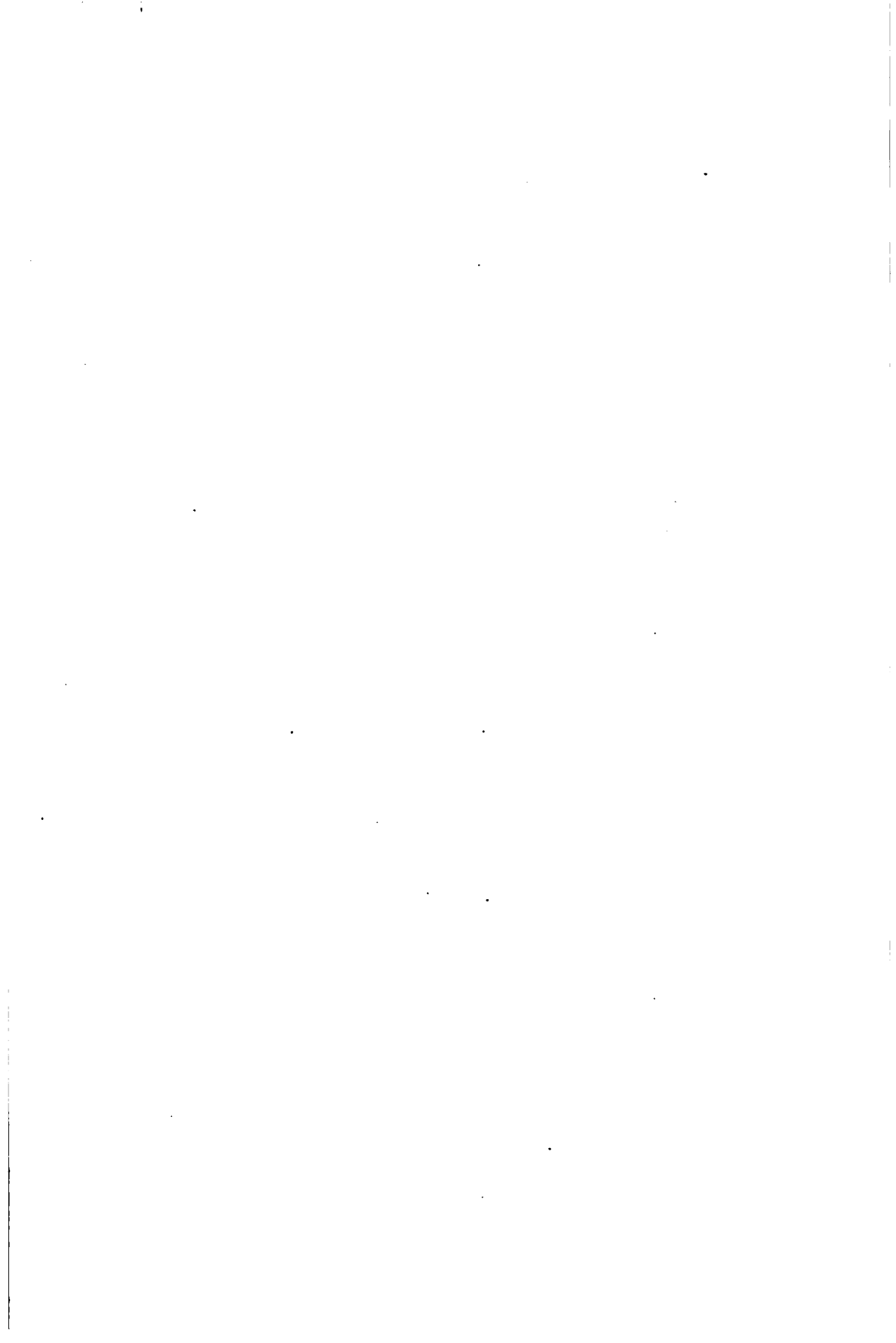

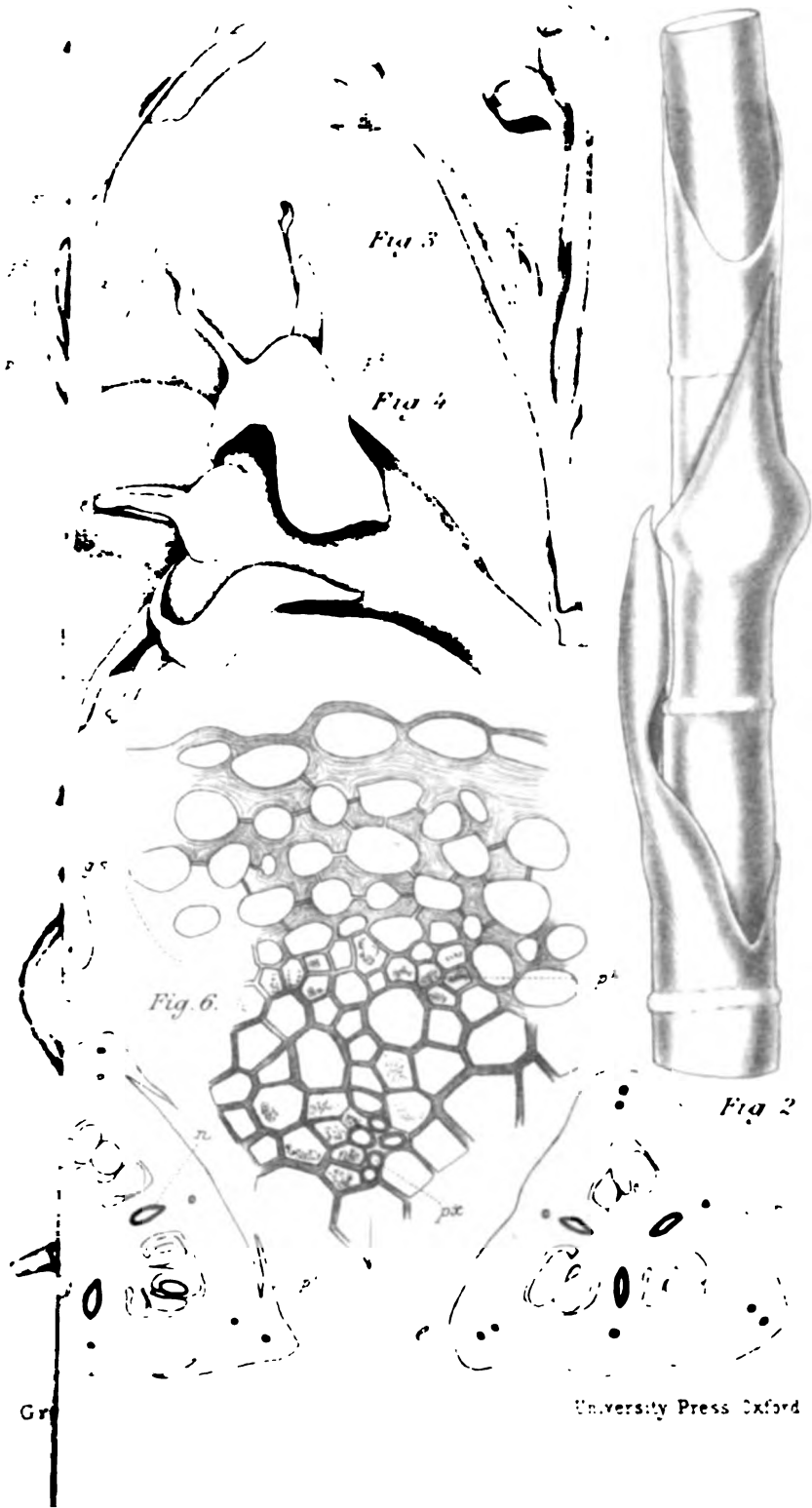

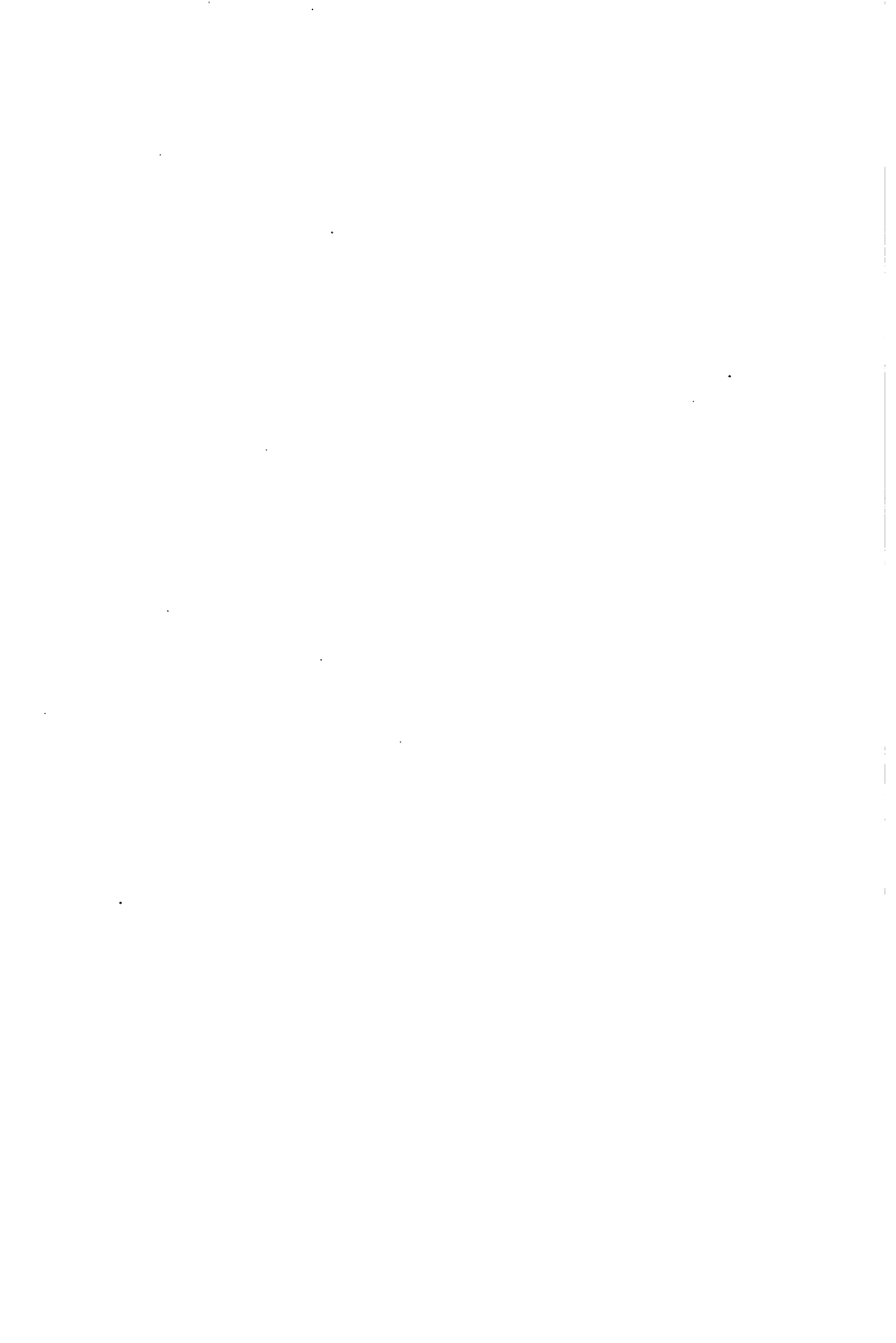



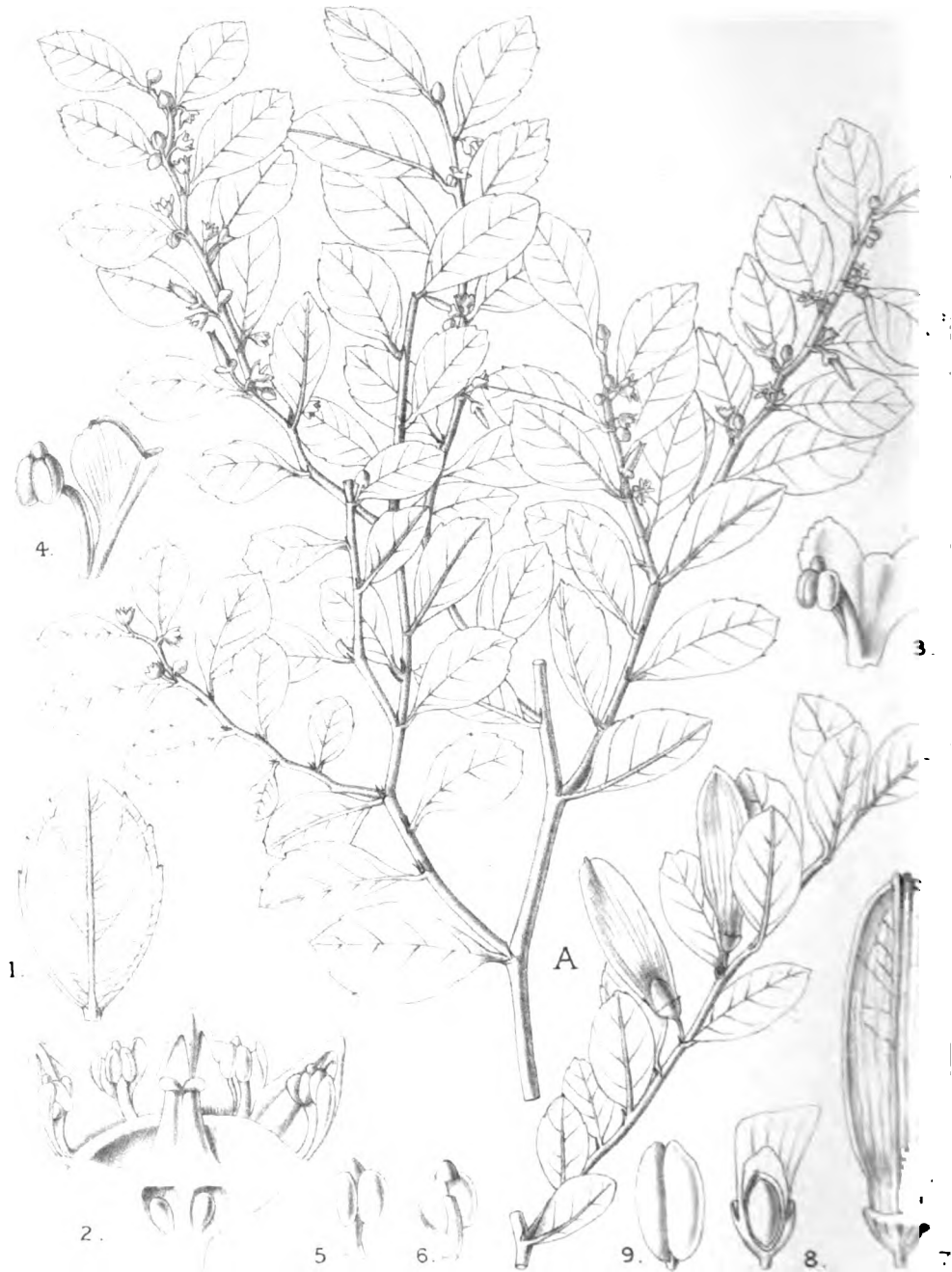

M. Smith del.

HEMSLEY. — FORMOSAN PLANTS.

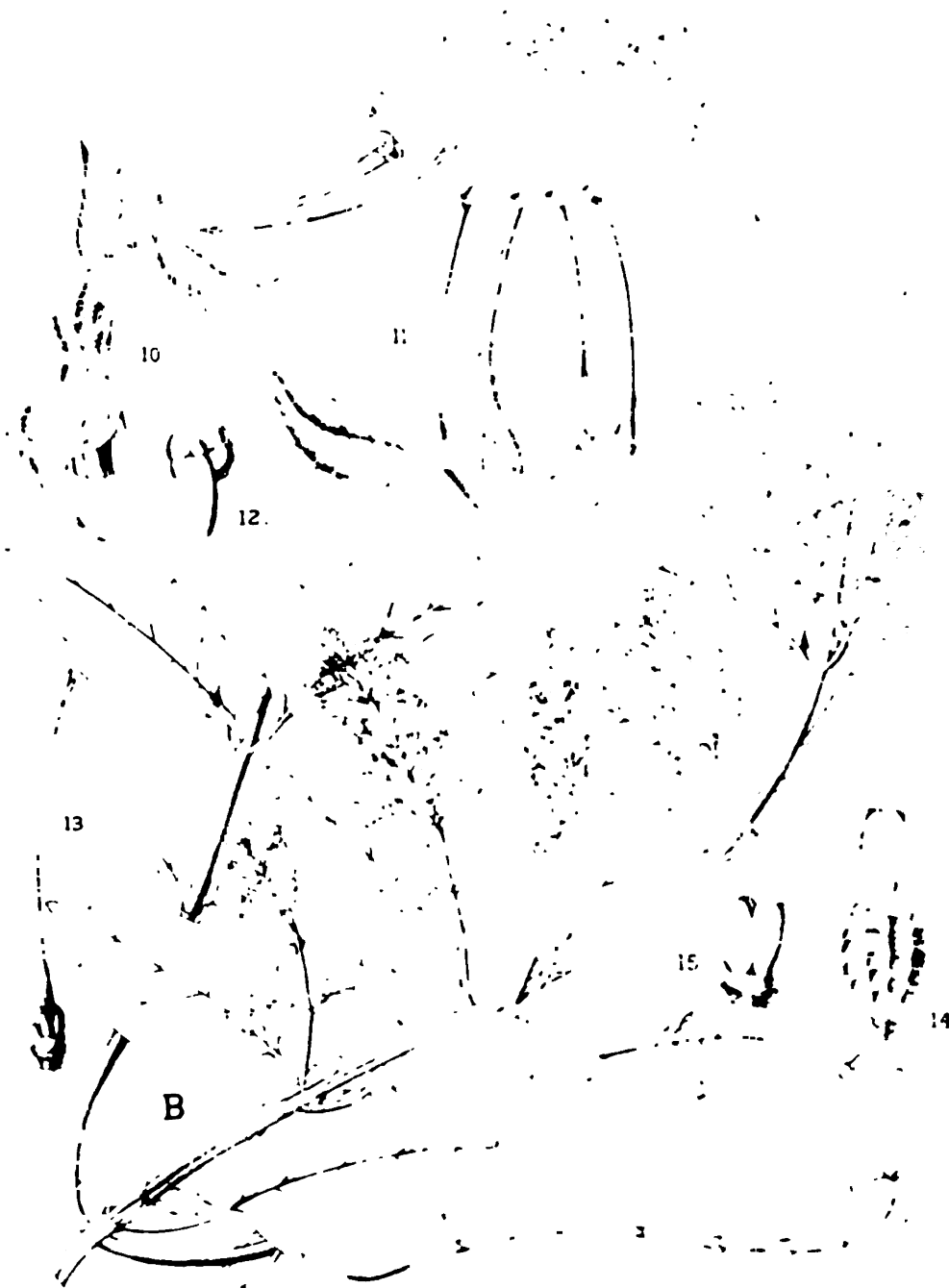

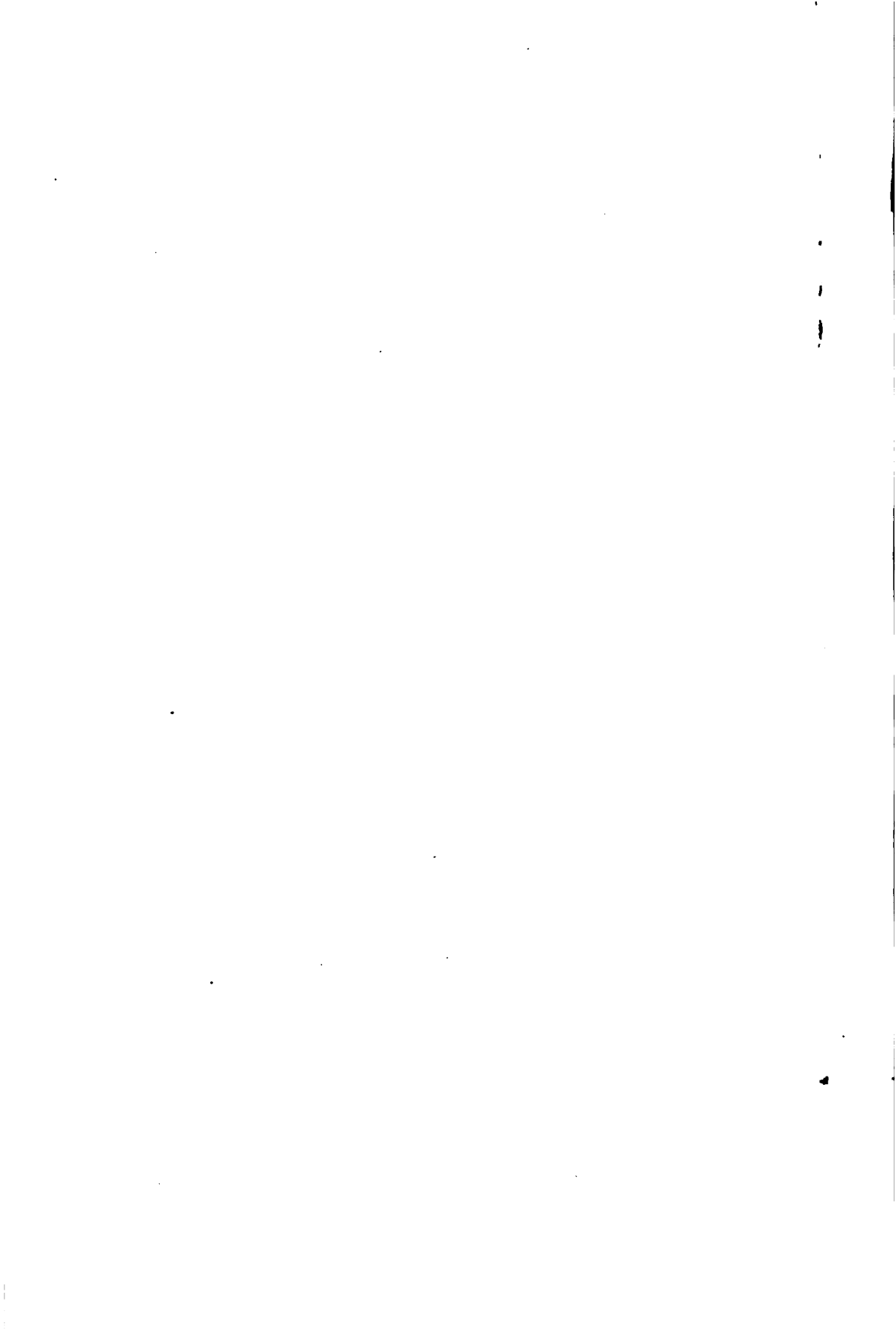





M. Smith del.

HEMSLEY. — FORMOSAN PLANTS.

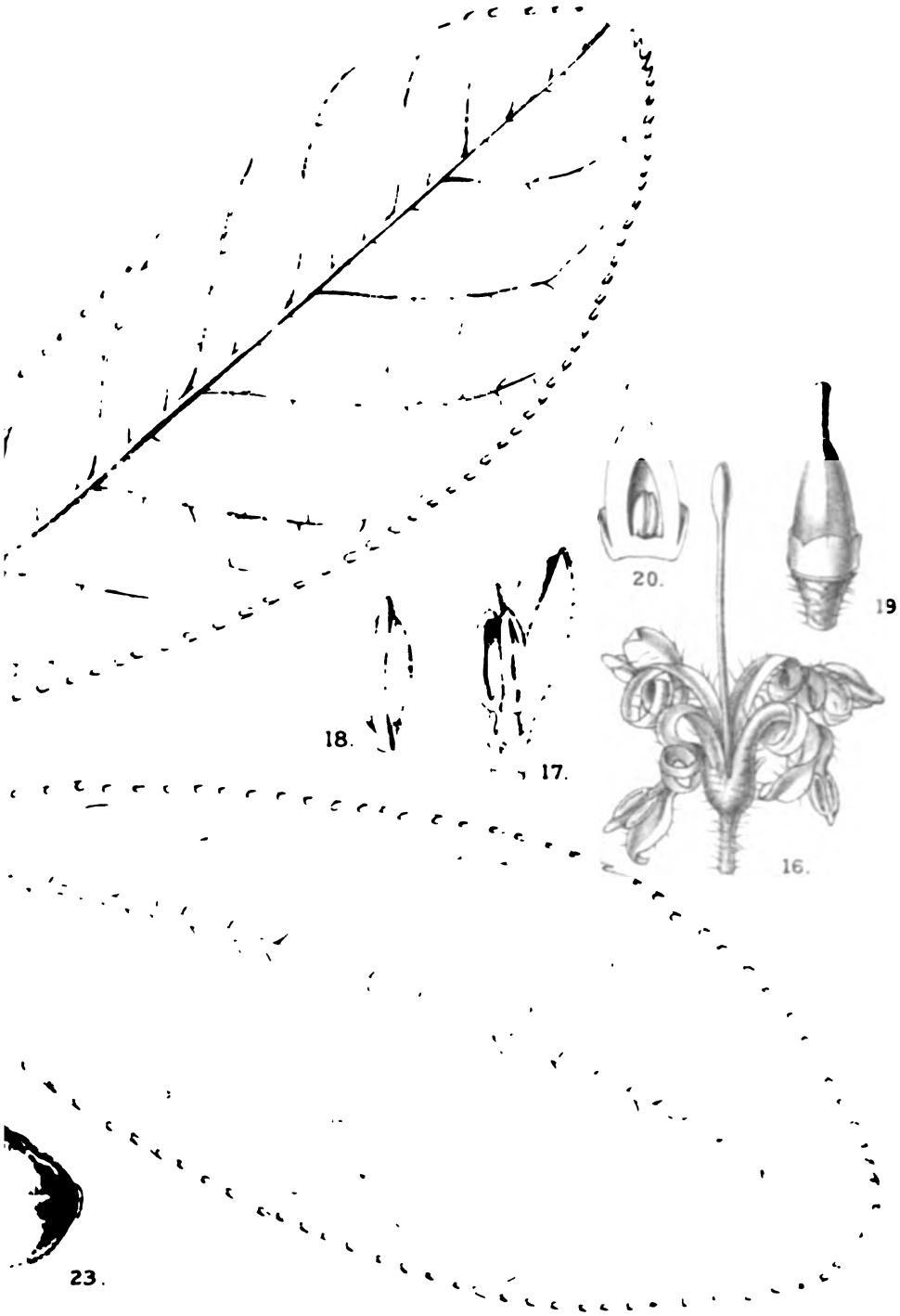

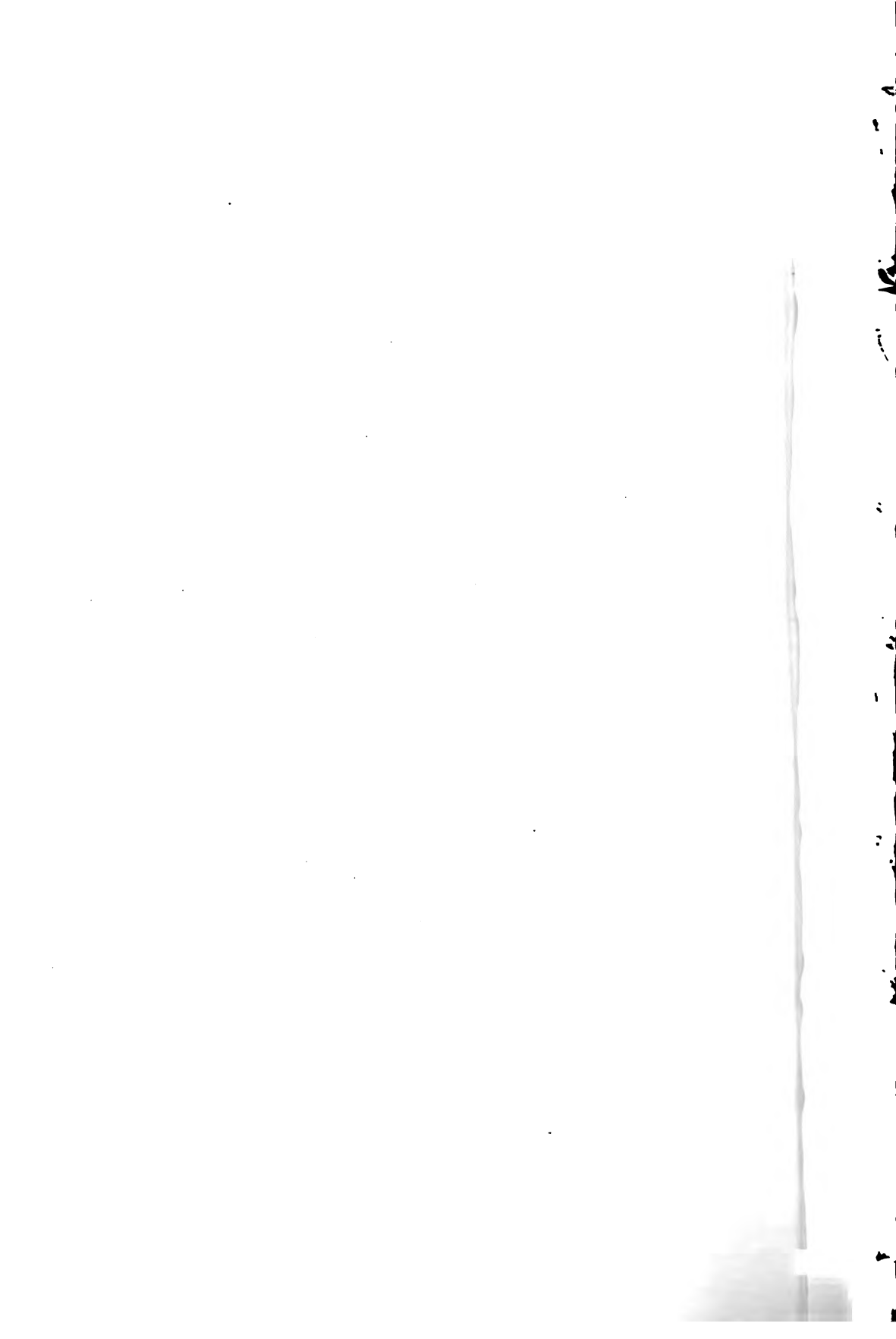

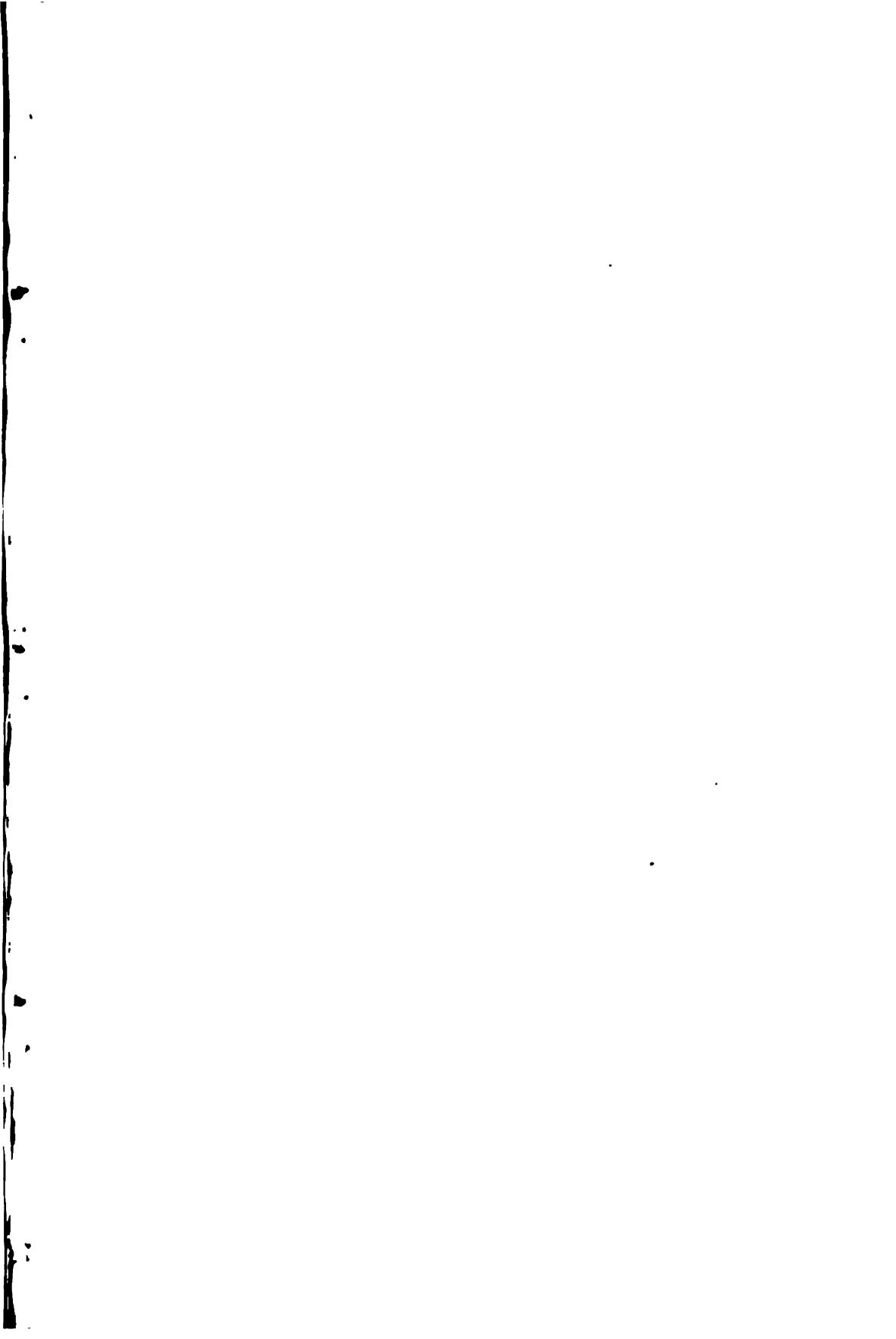

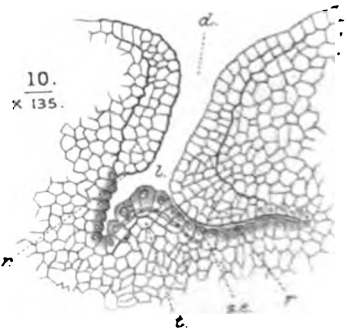
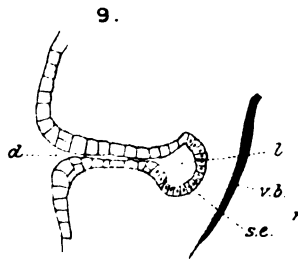
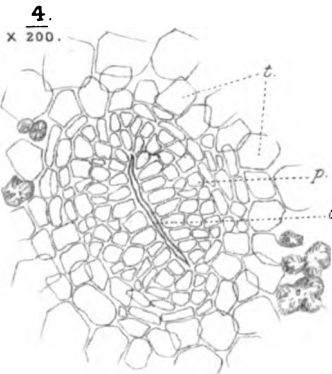
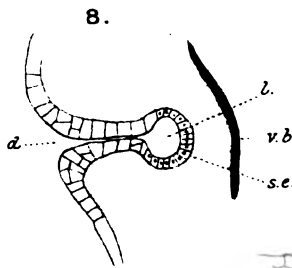
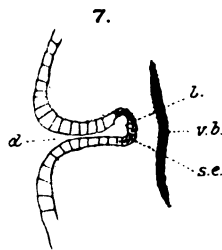
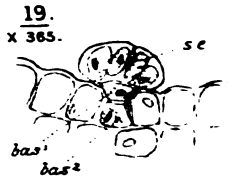
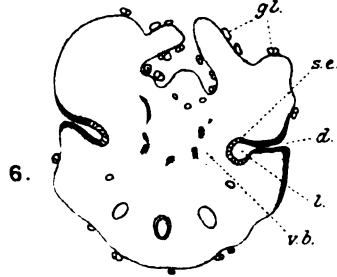
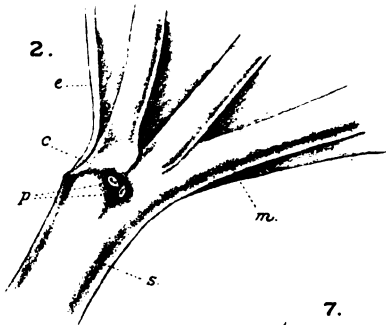
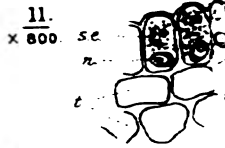
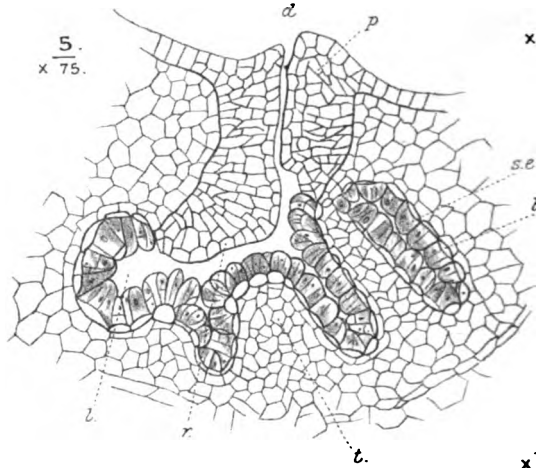
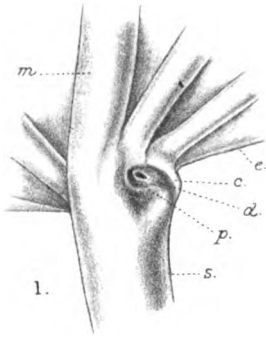

15.
x 800

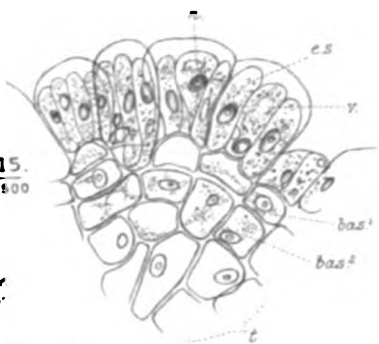

16.
x 375

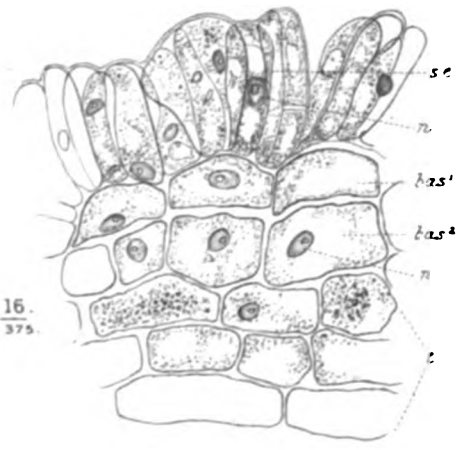

13.
x 550

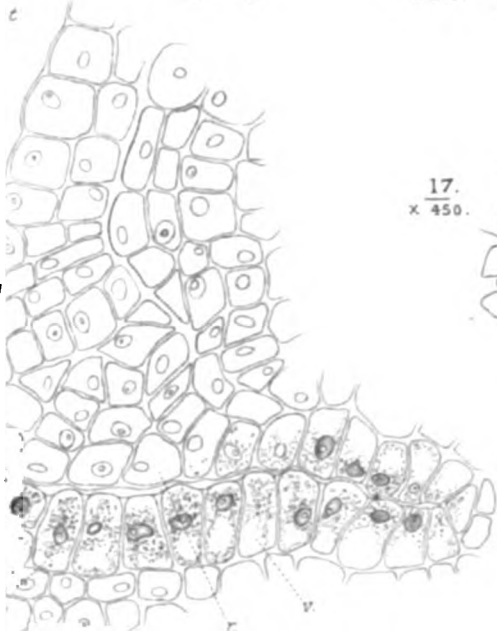

17.
x 450



18.
x 420

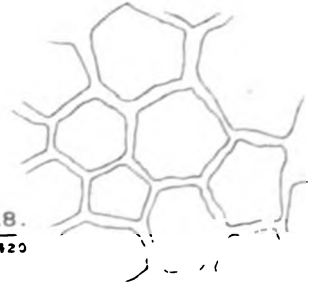

14.
x 460

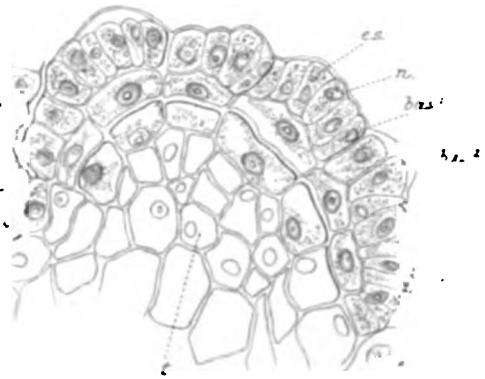

20.
x 650



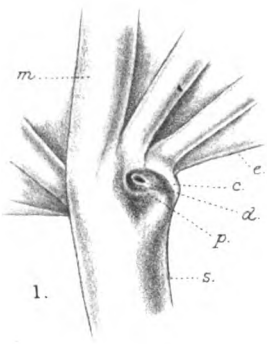

1.

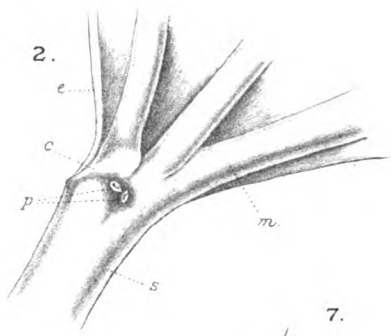

2.

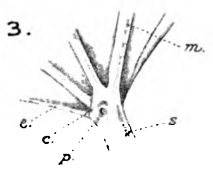

3.

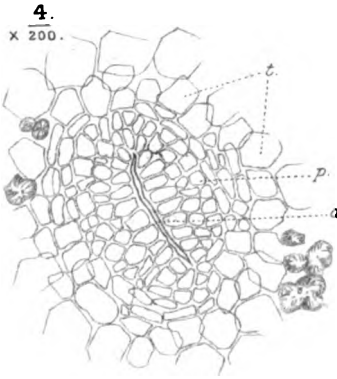

4.
x 200.

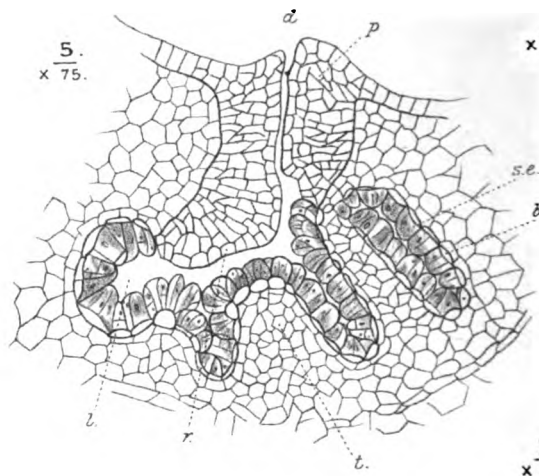

5.
x 75.

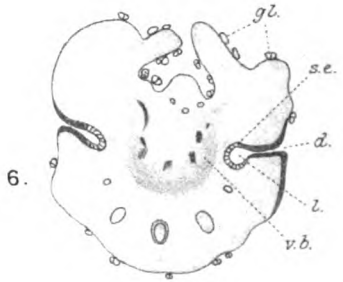

6.

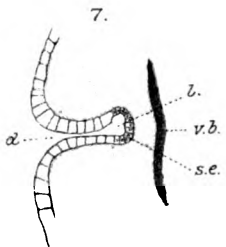

7.

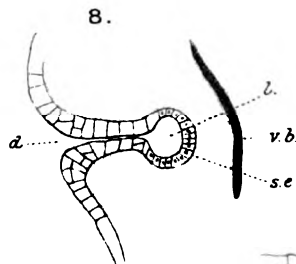

8.

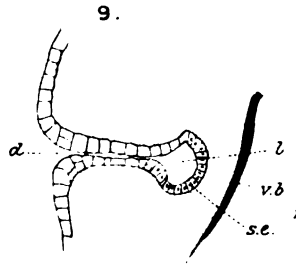

9.

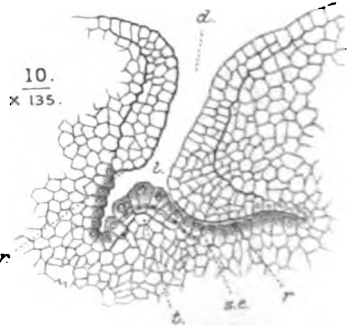

10.
x 135.

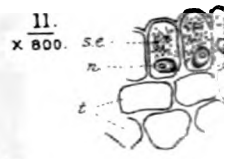

11.
x 800.



12.
x 500.

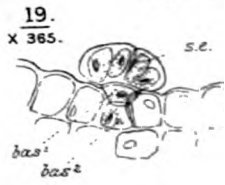

19.
x 365.

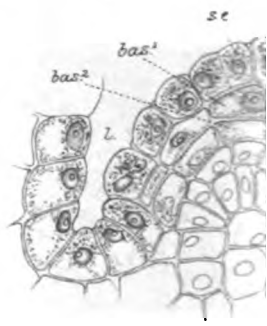



15
x 300

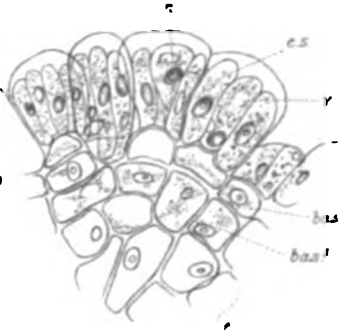

13
x 550



16
x 375

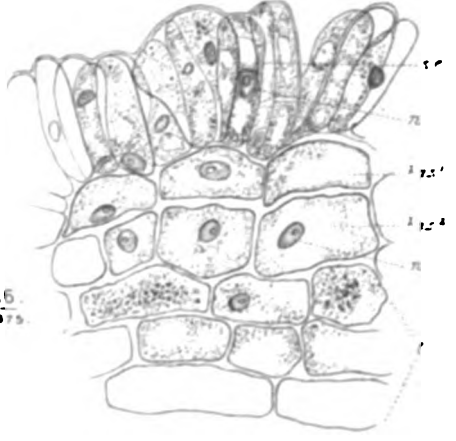

17
x 450

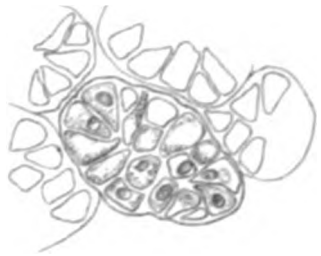

18
x 420



14
x 480

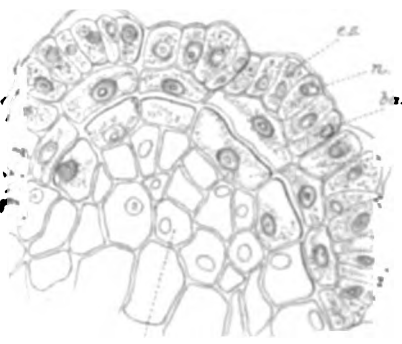

20
x 650



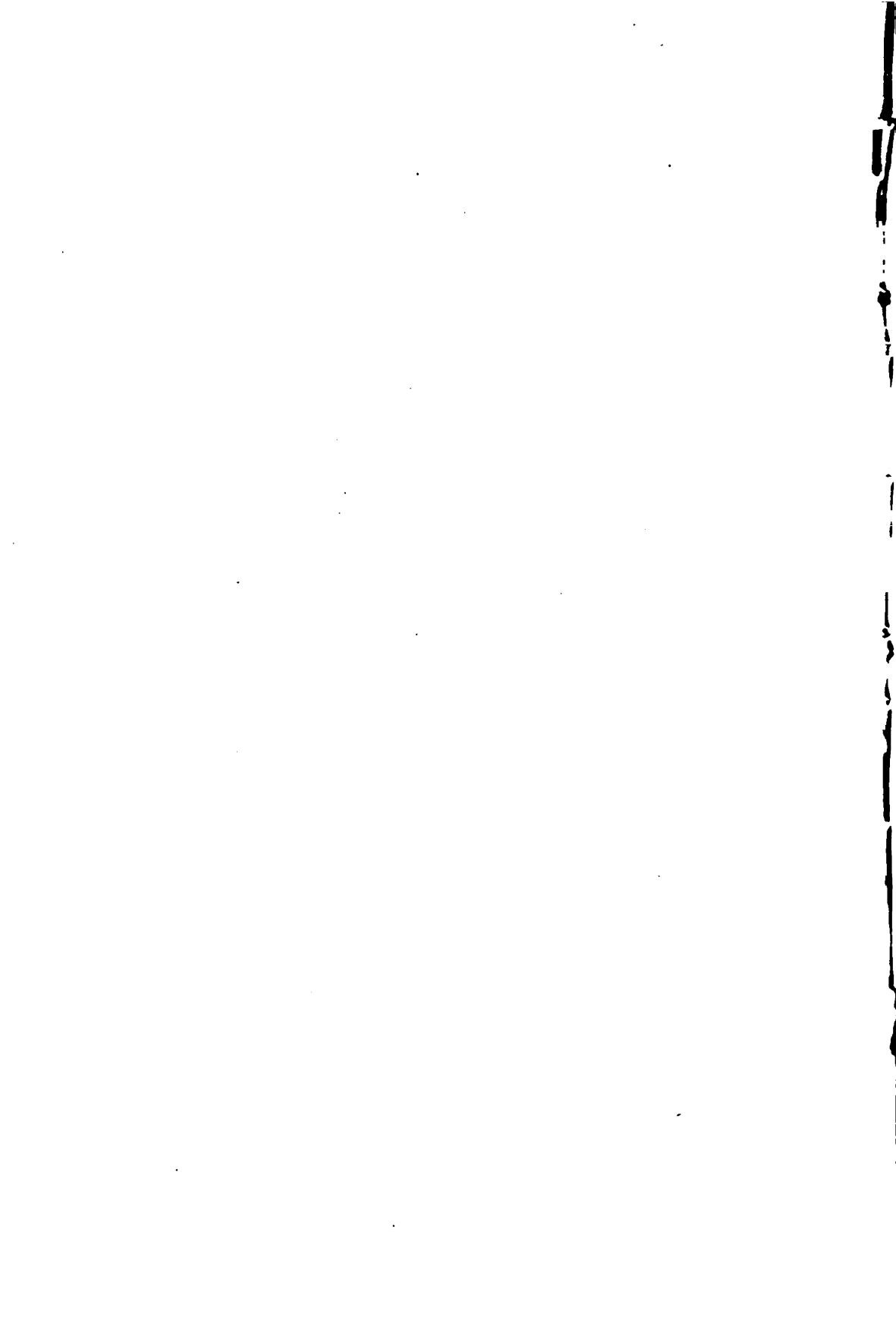

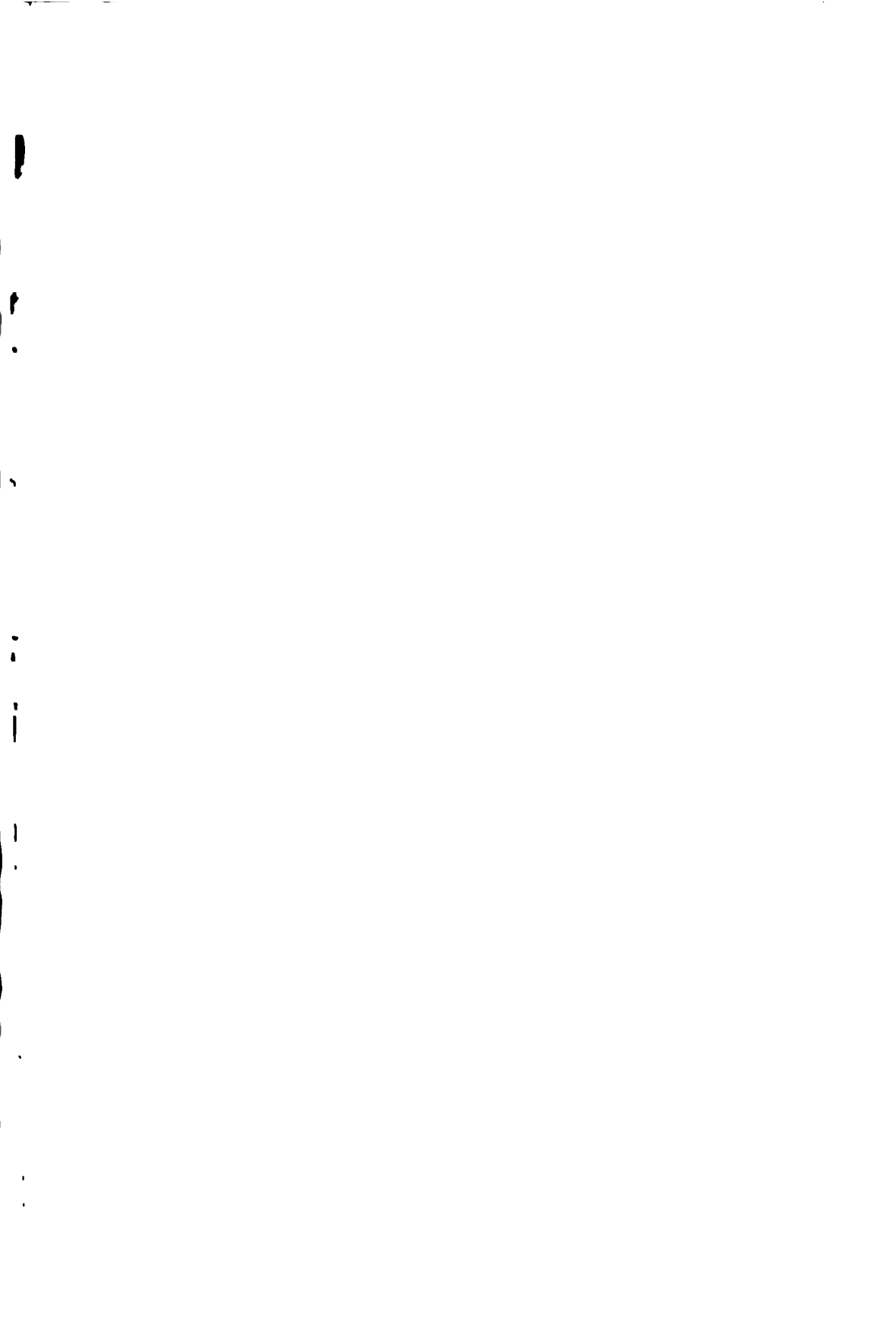

Fig. 1.

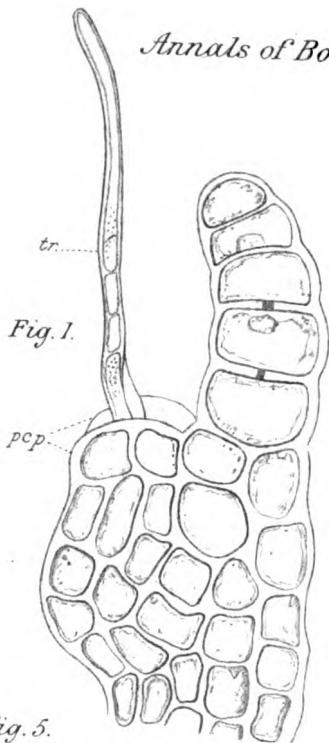

Fig. 2.

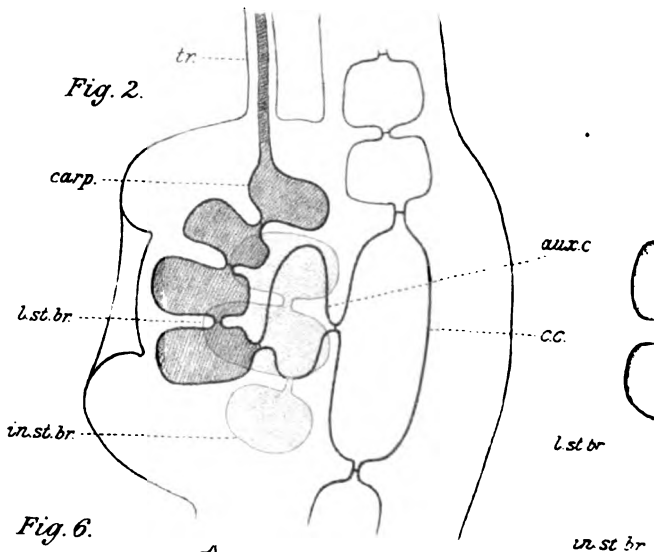

Fig. 5.

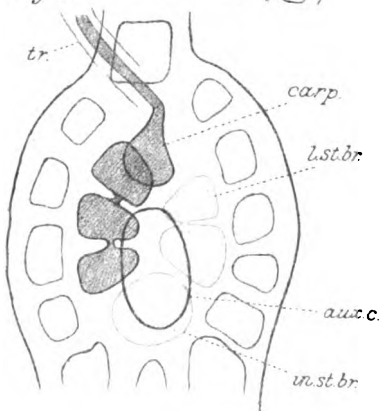

Fig. 6.

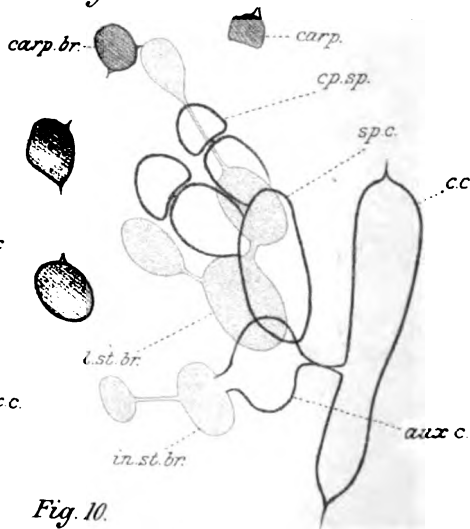

Fig. 7.

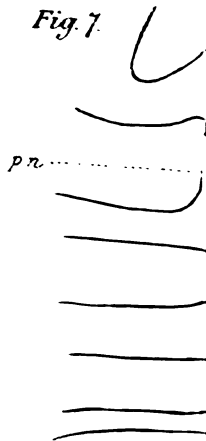

Fig. 10.

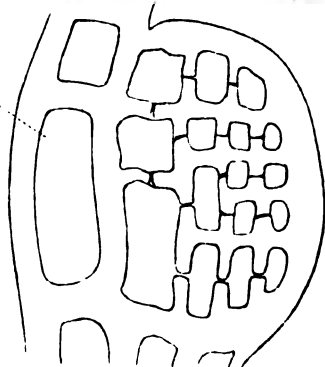

Fig. 11.

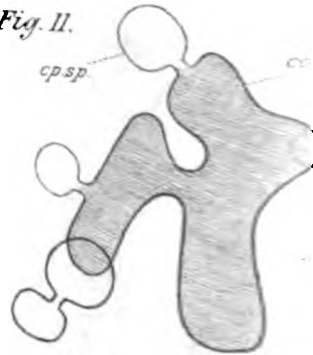
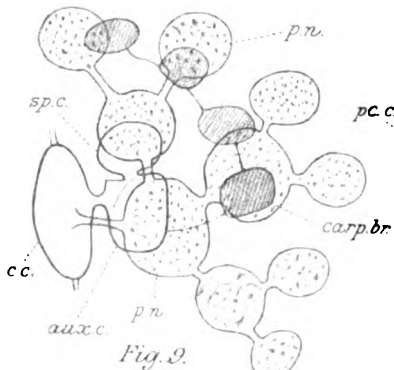

Fig. 9.



R.W.P. del.

Fig. 3.

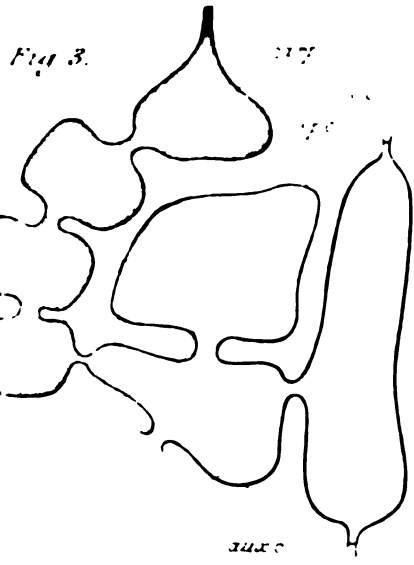

Fig. 4.

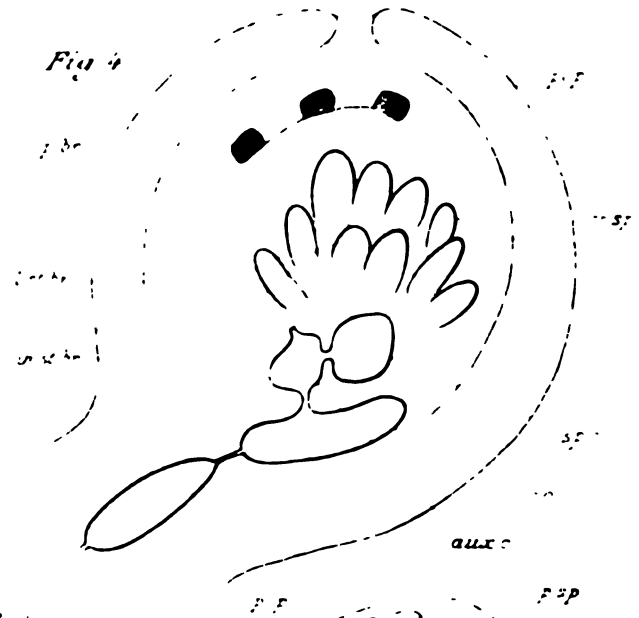
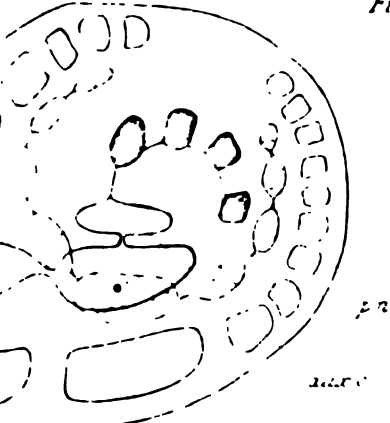

Fig. 8.



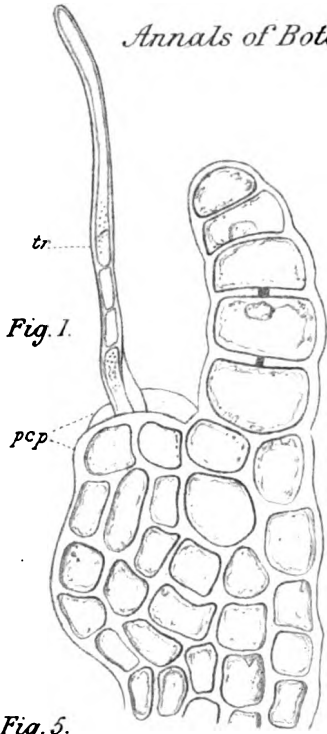

Fig. 1.

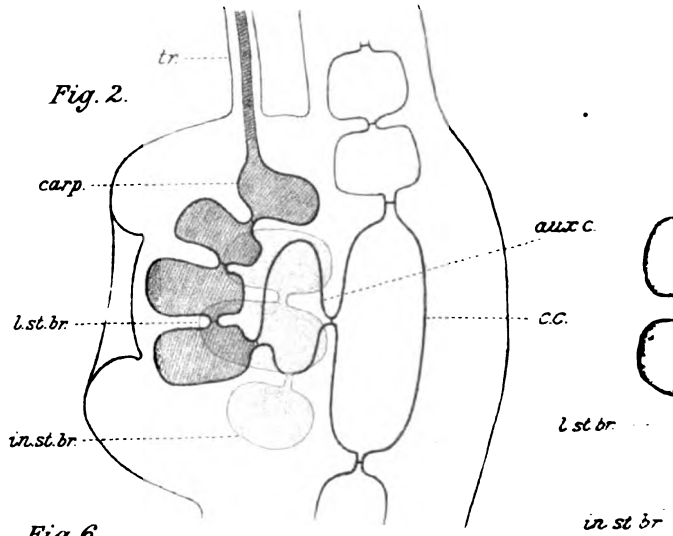

Fig. 2.

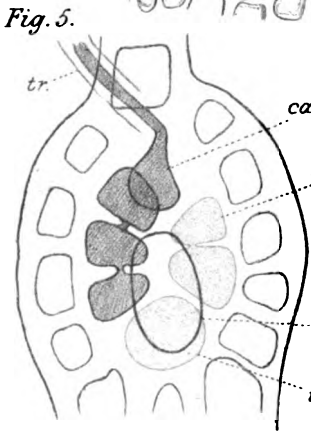

Fig. 5.

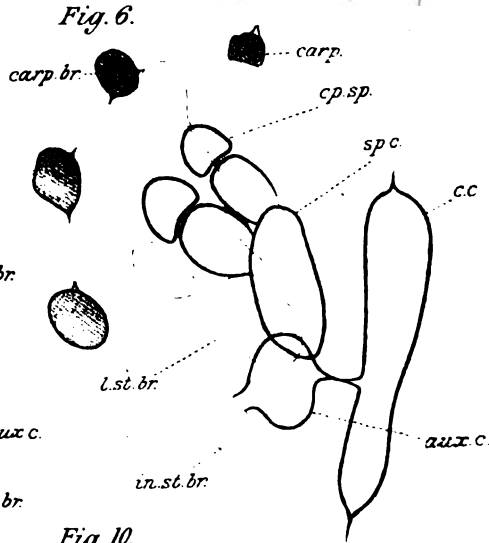

Fig. 6.

Fig. 7.

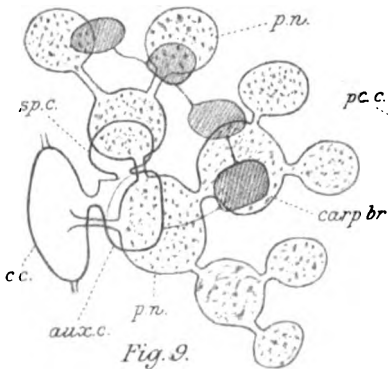

Fig. 9.

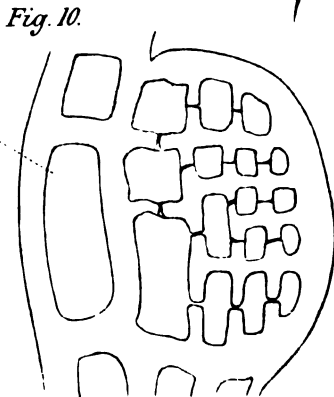

Fig. 10.

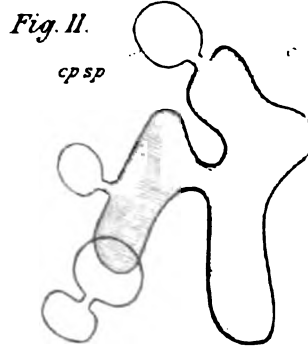

Fig. 11.

R.W.P. del

Fig 3

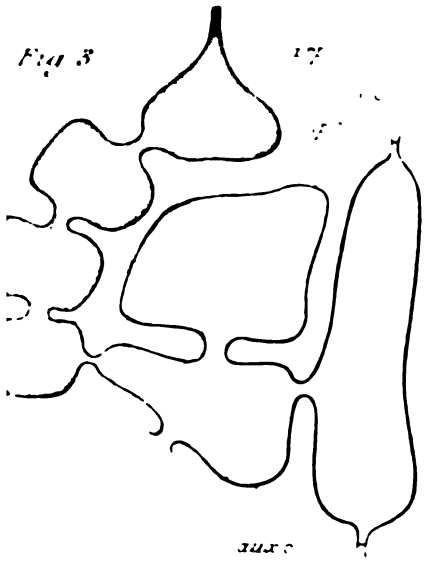

Fig 4

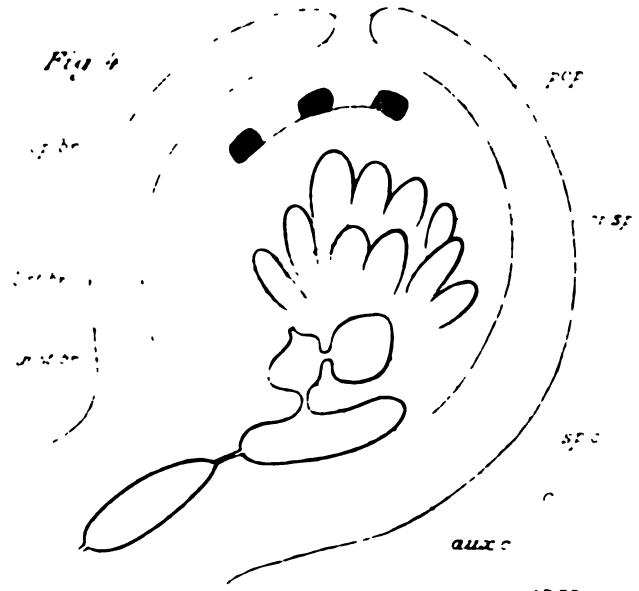

Fig 8.

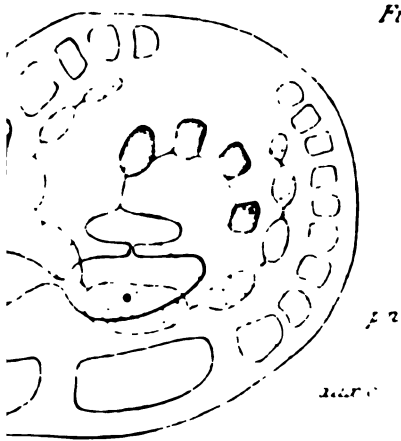

Fig 12

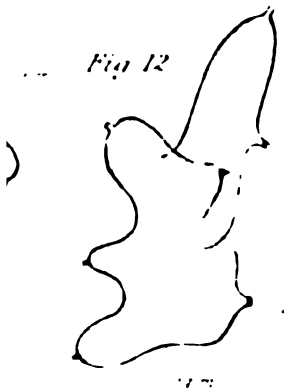

Fig 13

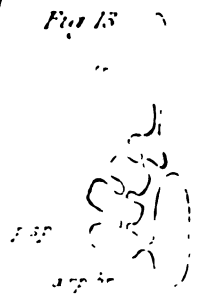
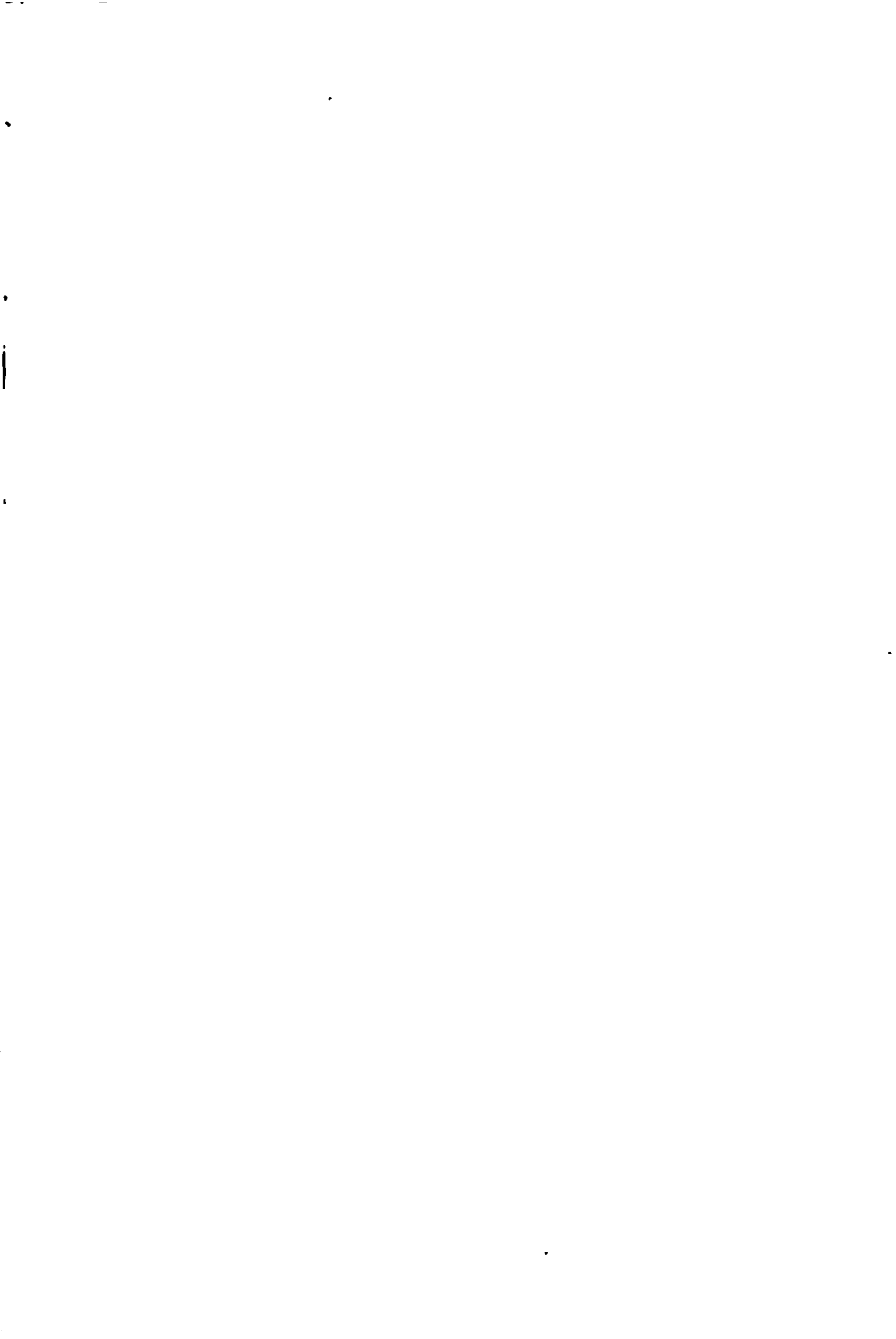
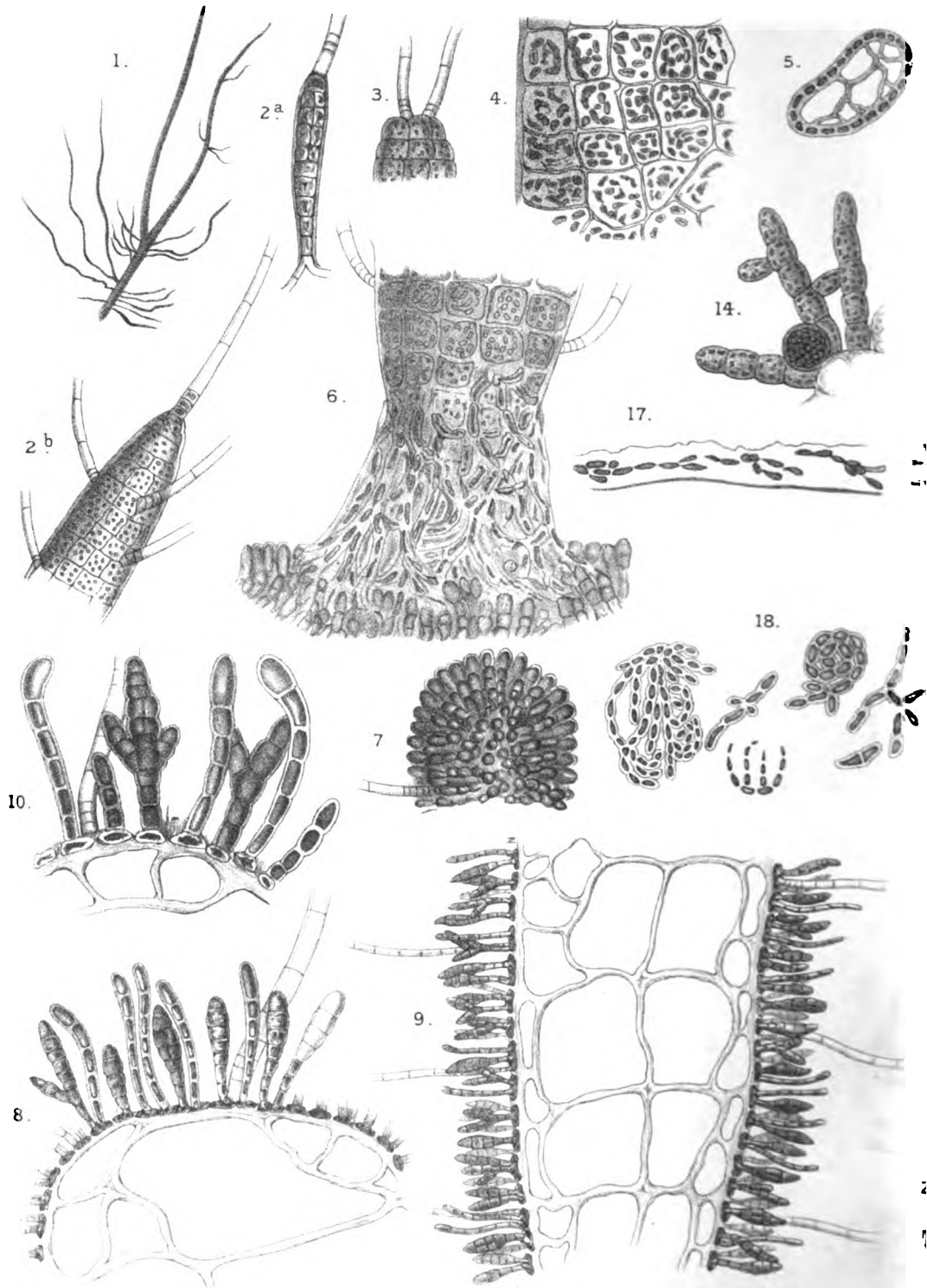

Fig 14.









F. A. Batters del.

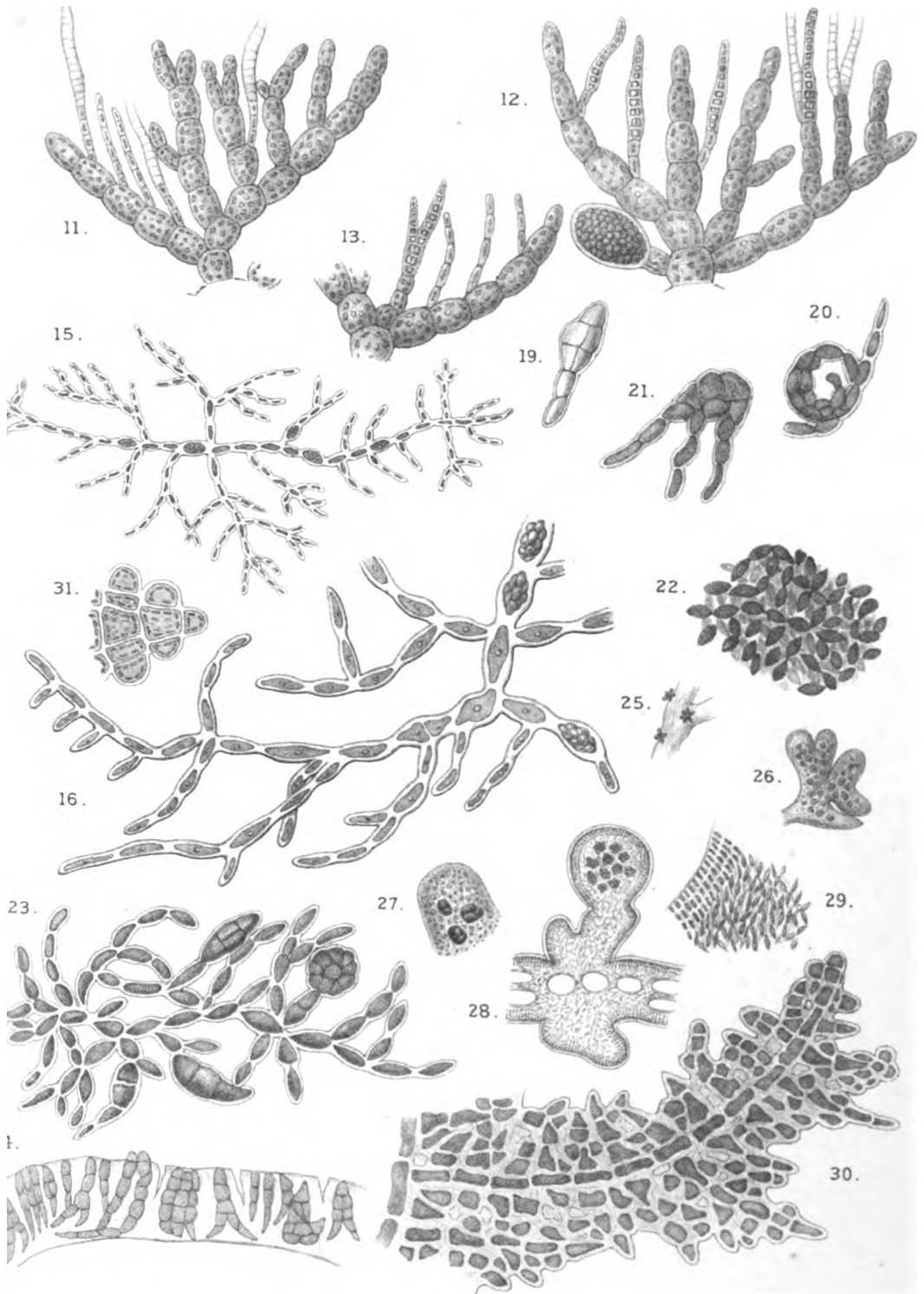

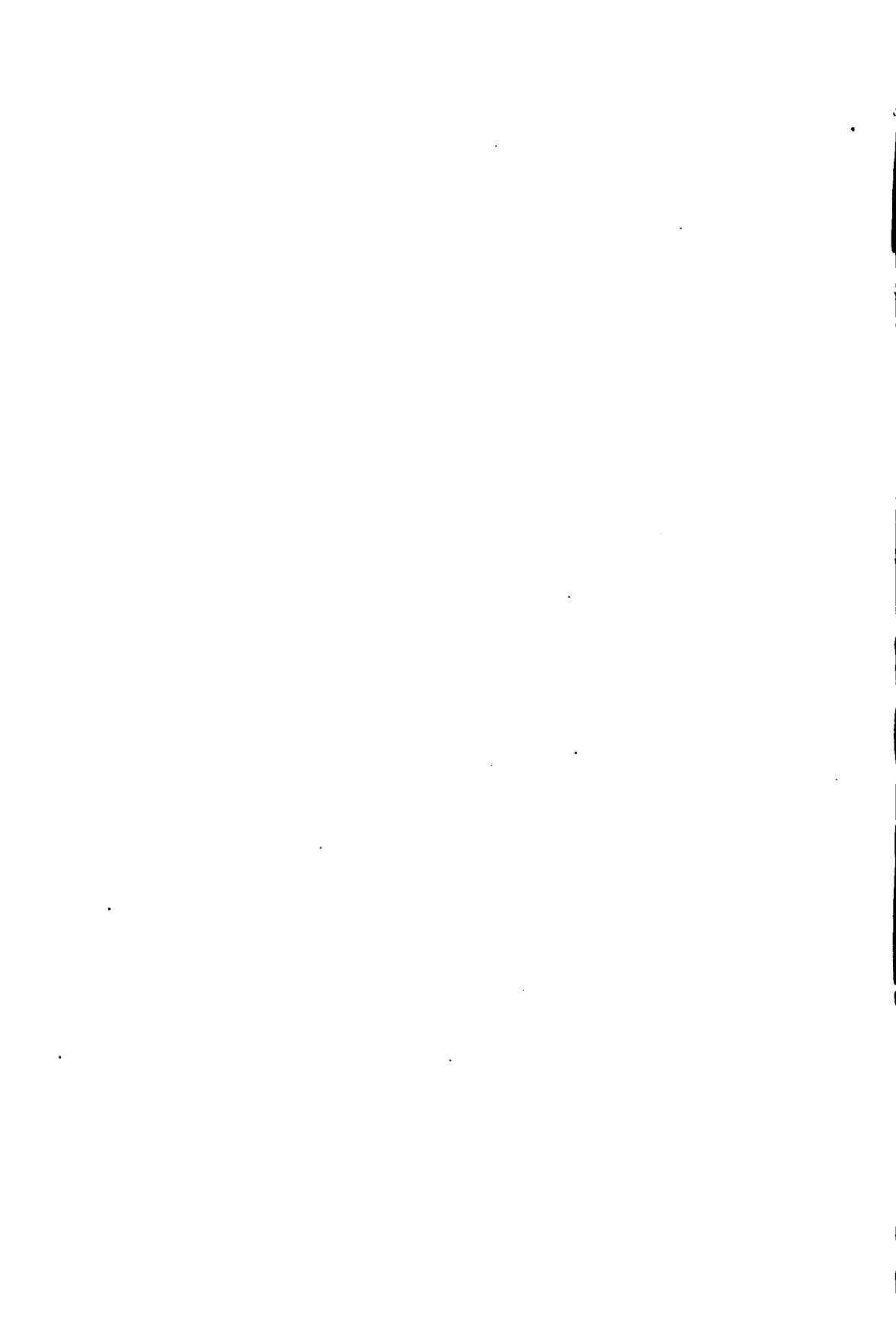

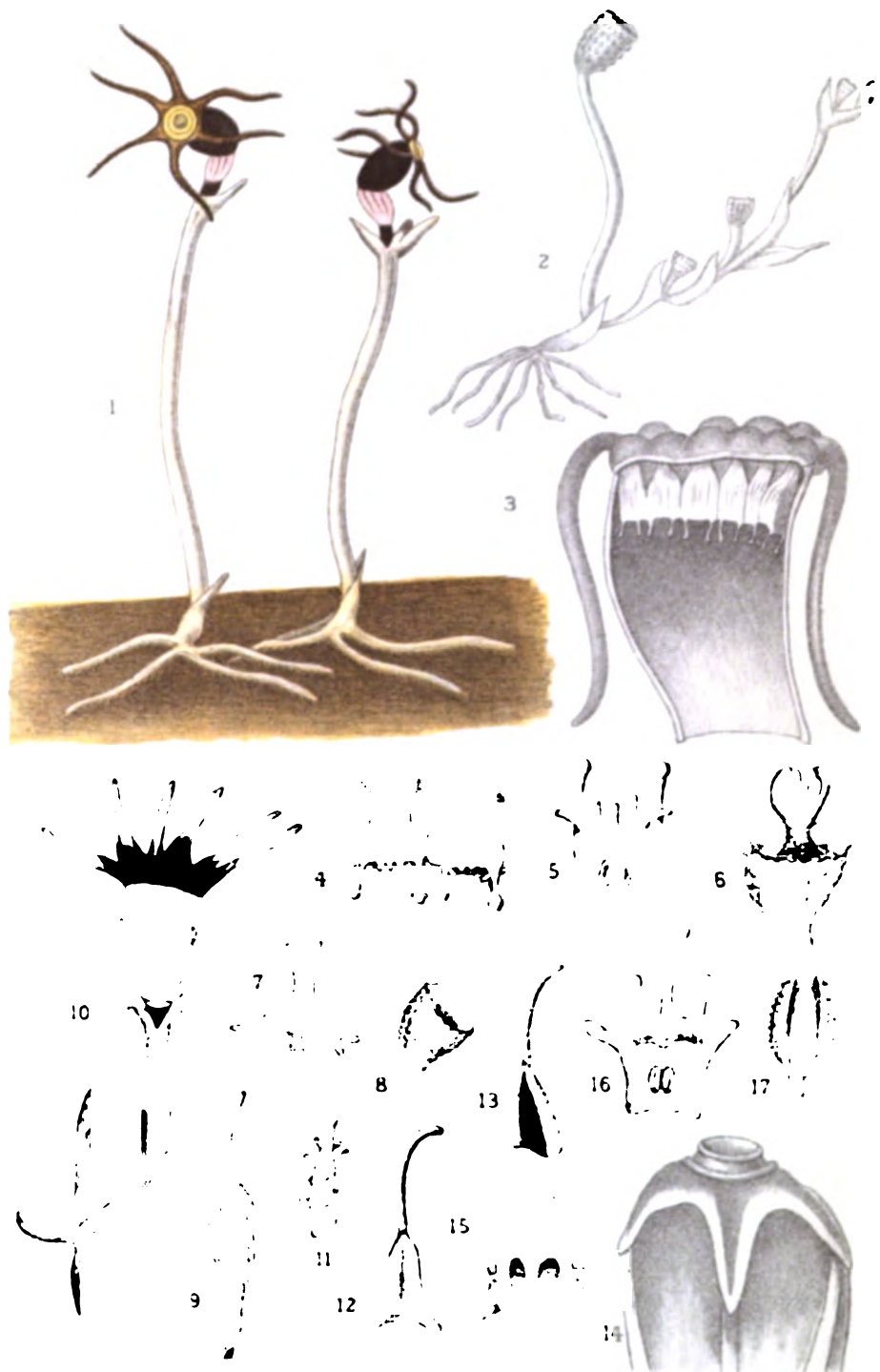

RIDLEY — ON *THISMIA*

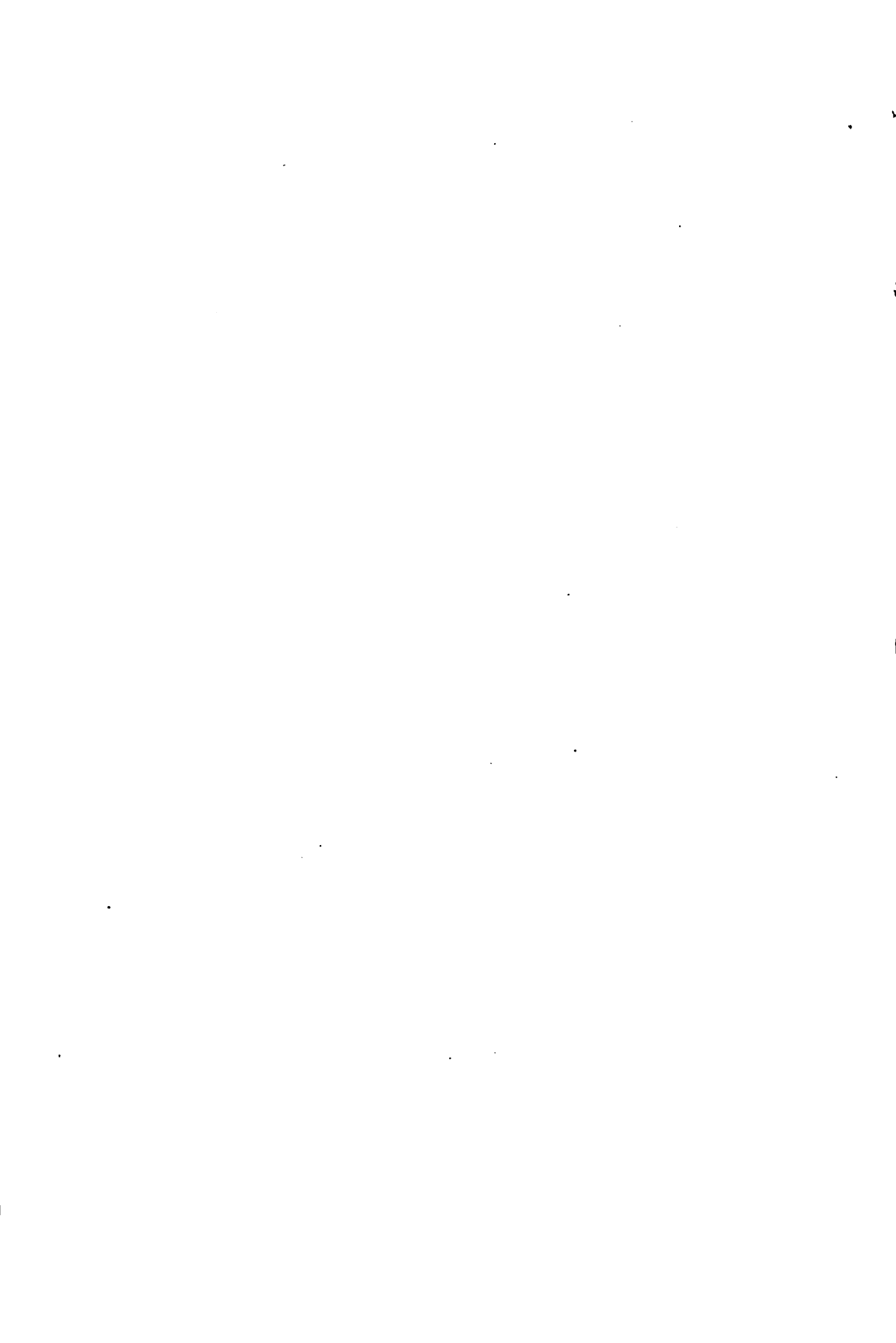



RIDLEY - ON THYSANOTUS

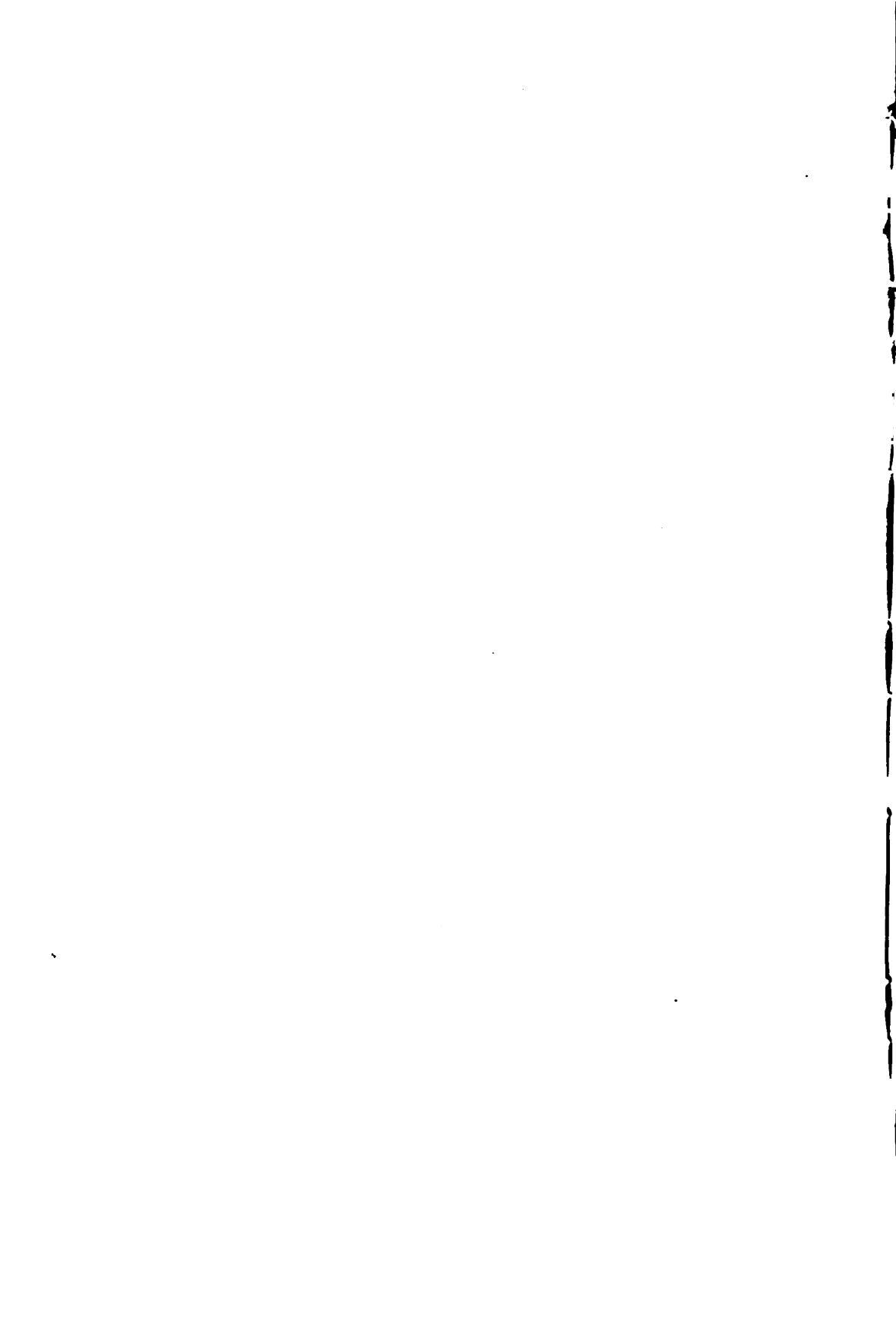



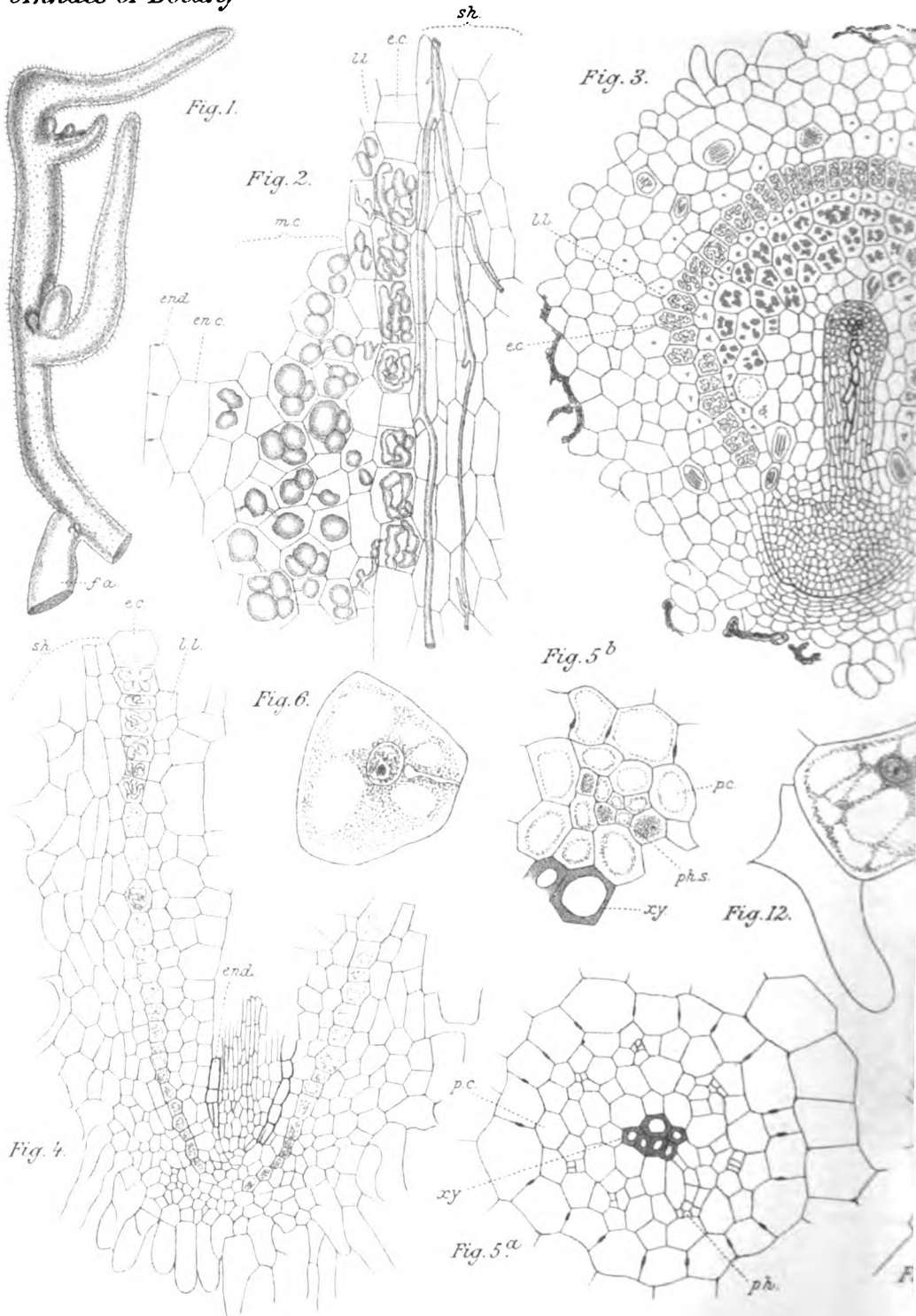

P Groom de.

Fig. 7.

Fig. 9.

Fig. 8.

Fig. 11.

Fig. 13.

Fig. 10.

Fig. 14.

Fig. 15.

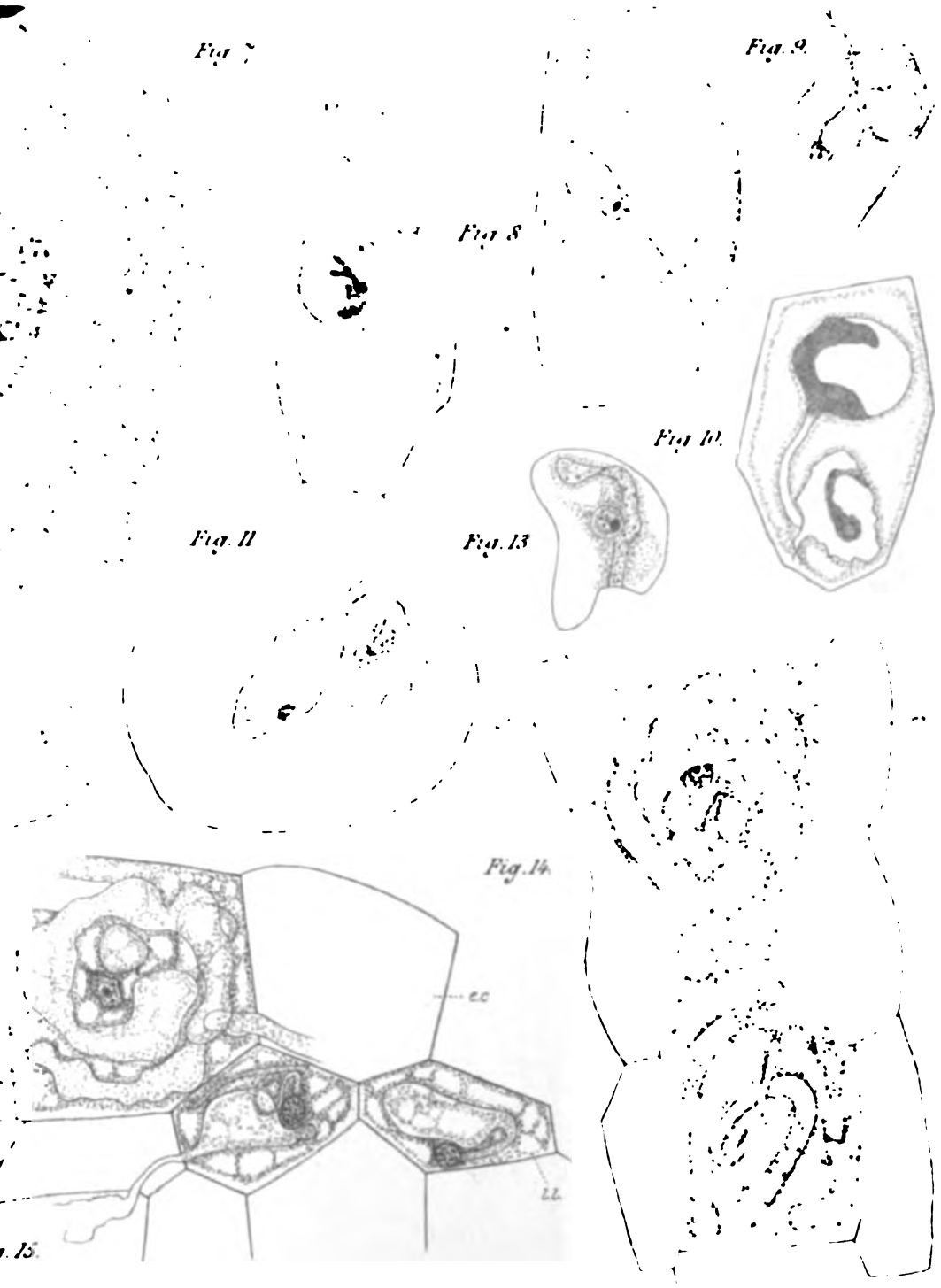

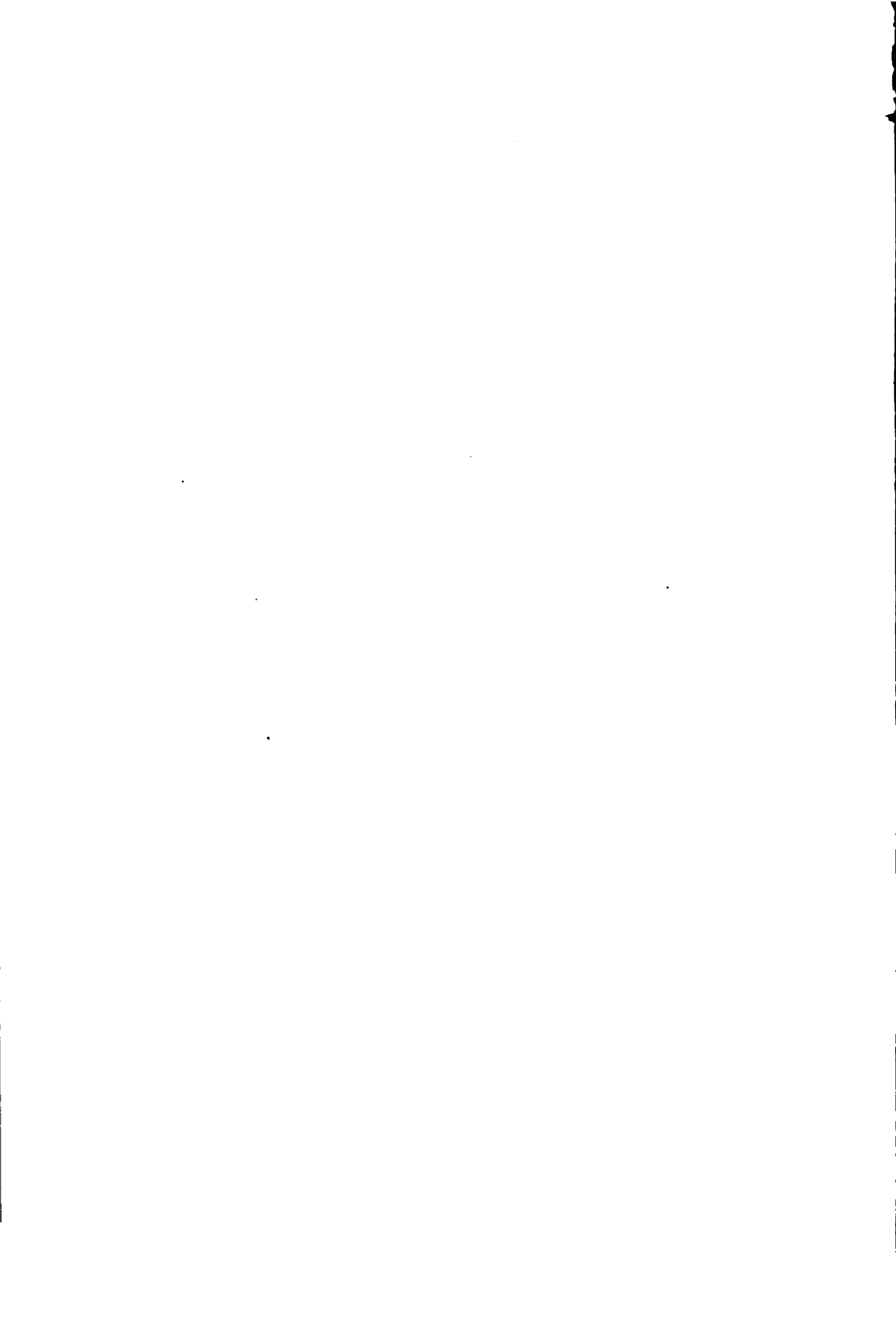

Fig. 17.

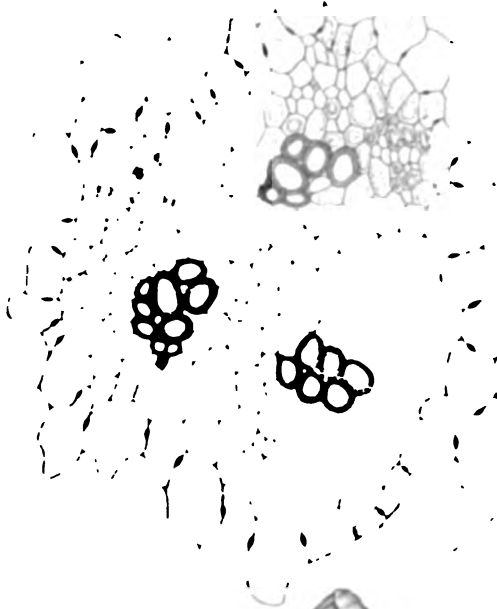

Fig. 18.



Fig. 16.



Fig. 19.



Fig. 20.



Fig. 19. m. 20.

Fig. 16. 17. 18.



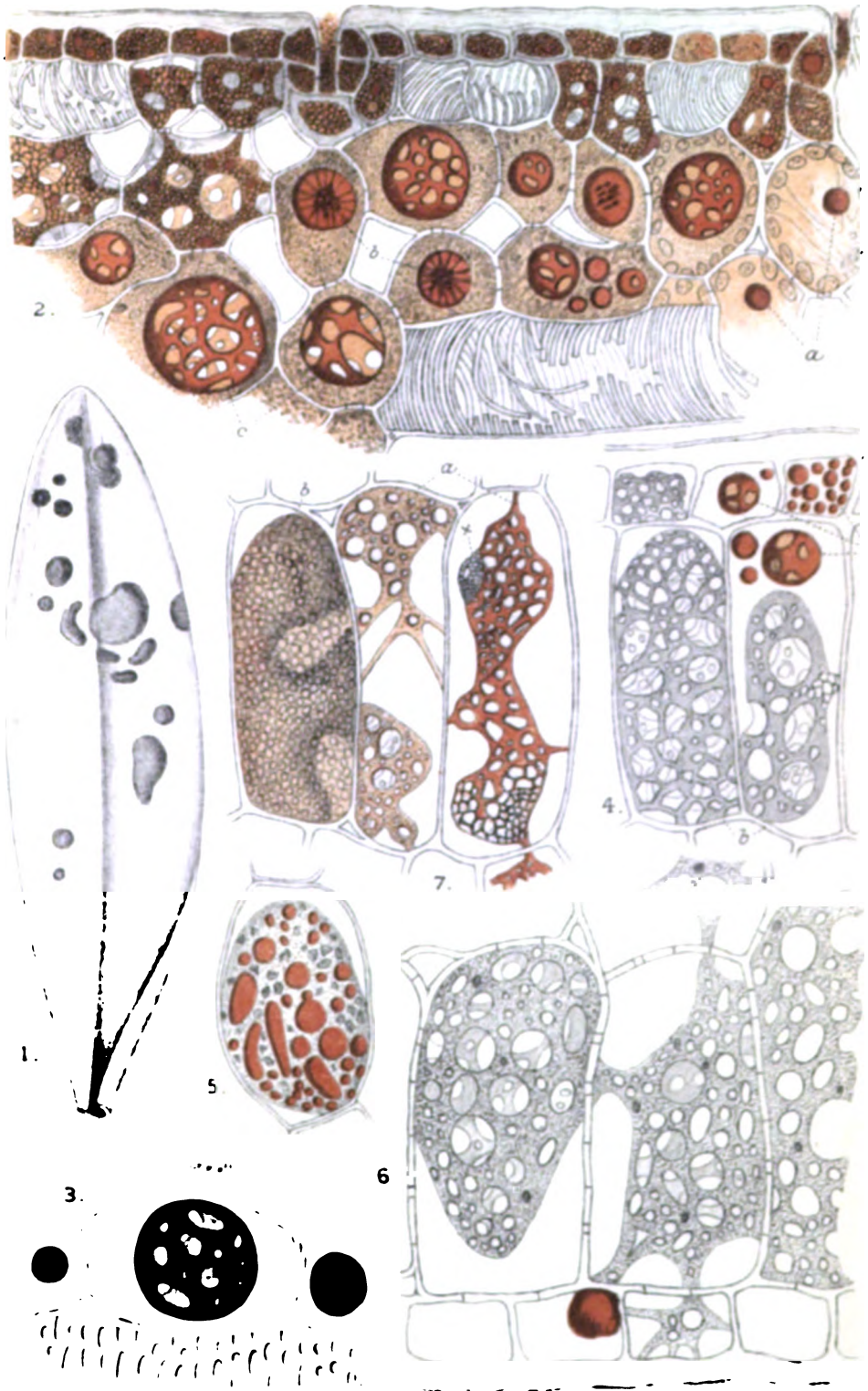

MASSEE. - "SPOT" IN ORCHIDS



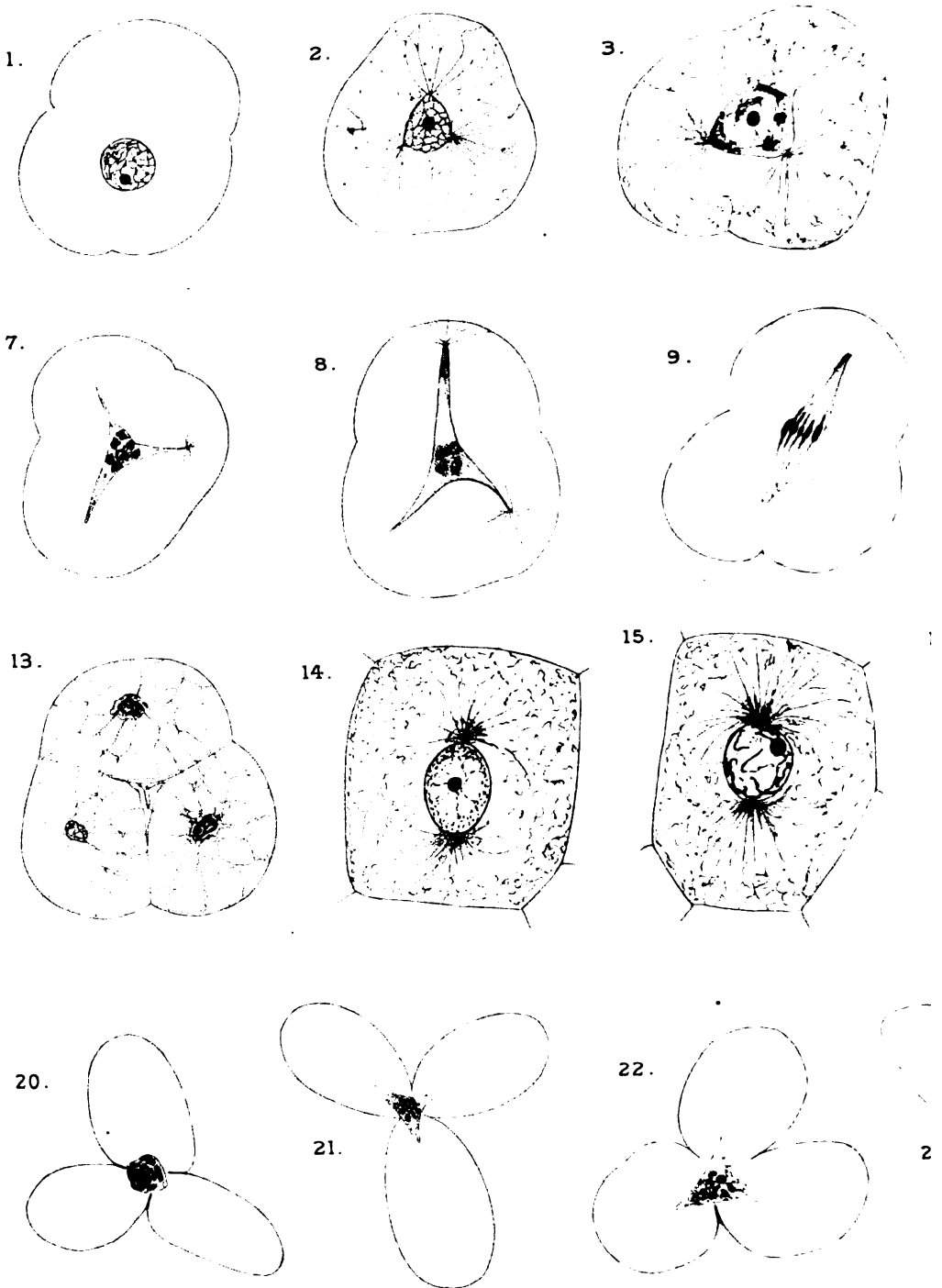

J.B. Farmer del.

FARMER.— NUCLEAR DIVISION IN HEPATICÆ.

Fig^s 1-16, Fossombronia. 17-25, Pellia.

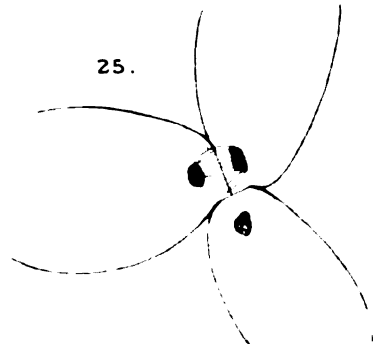
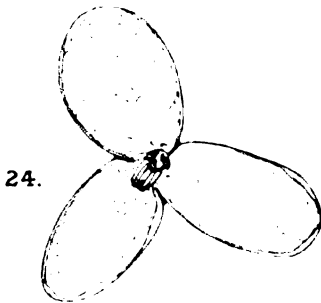
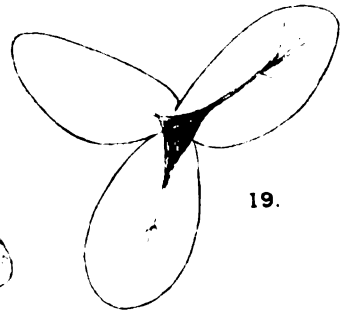
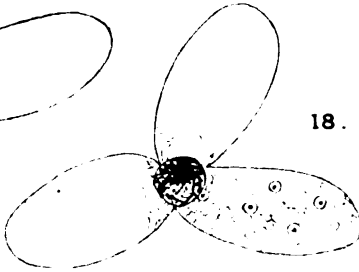
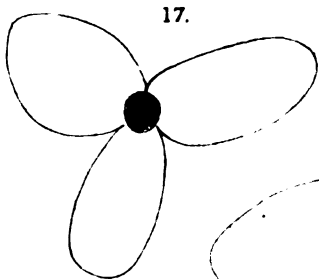
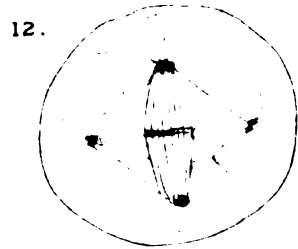
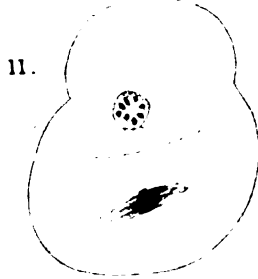
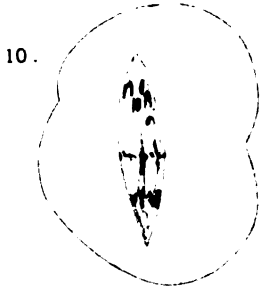
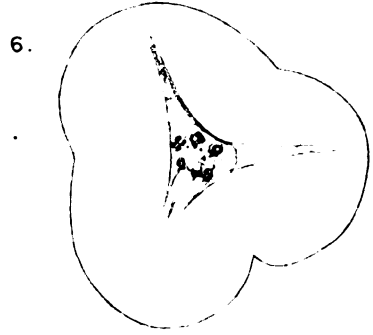
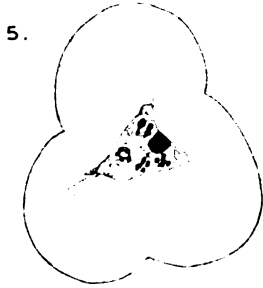

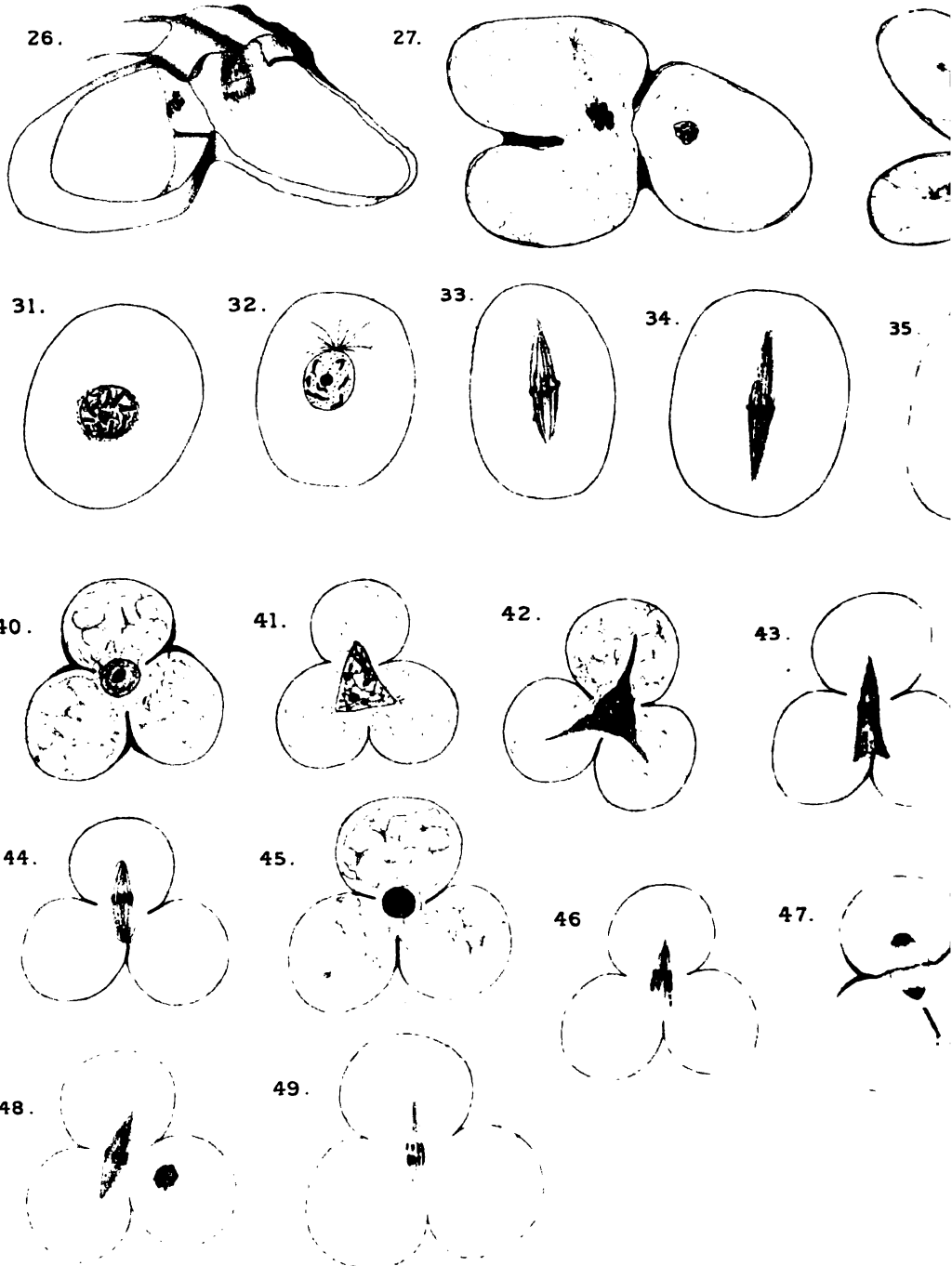

J. B. Farmer del.

FARMER.—NUCLEAR DIVISION IN HEPATICÆ.

Fig^s 26-35, *Pellia*. 36, *Aneura*. 37-39, *Cephalozia*. 40-49, *Scapania*.
50-53, *Lophocolea bidentata*. 54, 55, *L. ciliolata*.

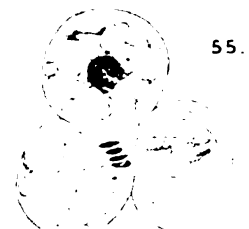
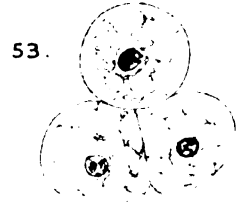
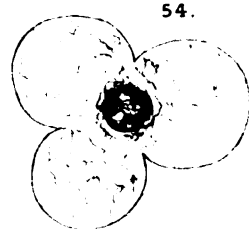
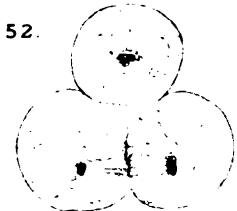
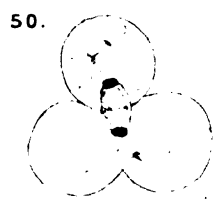
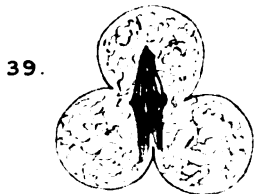
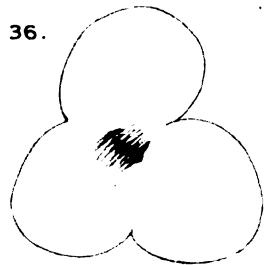
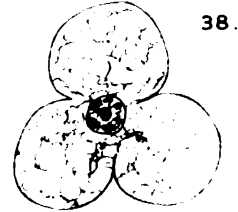
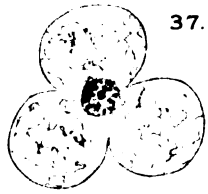
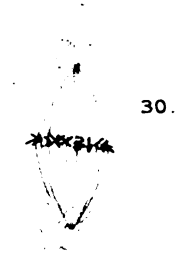
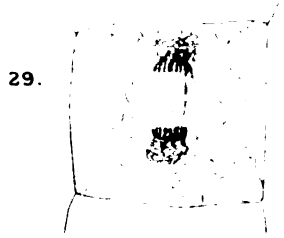
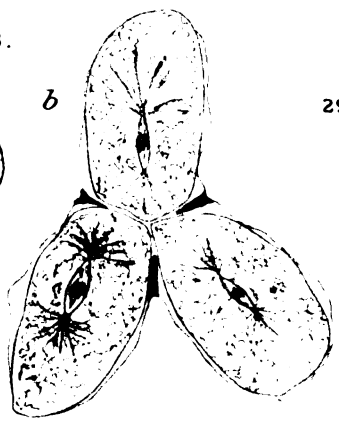
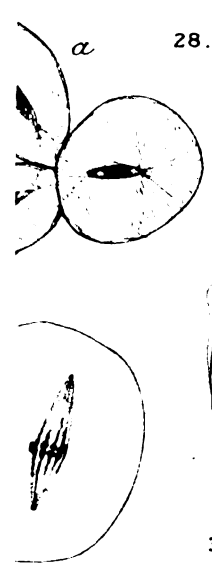





J.H. Farmer sc.

University of Toronto

FARMER -- NUCLEAR DIVISION IN HEPATICÆ.

Fig^s 56-58, *Plagiochasma* 59-74, *Pegatella*

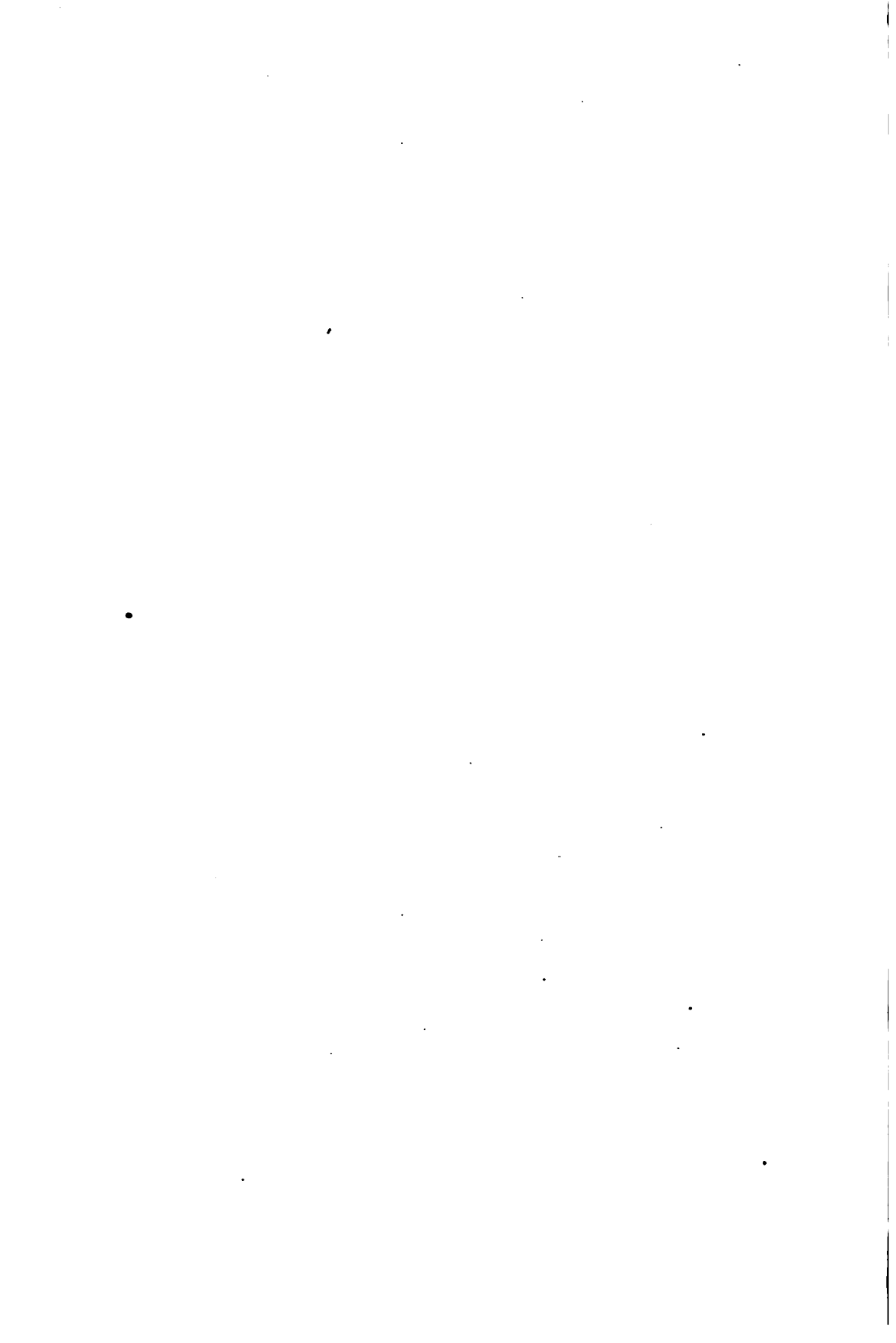



Fig. 1.



Fig. 2.



Fig. 3.

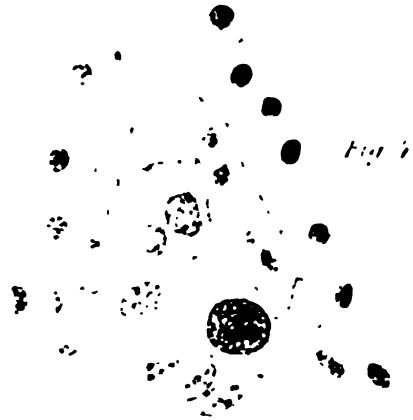

Fig. 4.

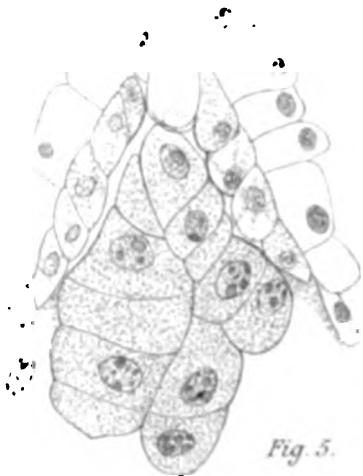

Fig. 5.

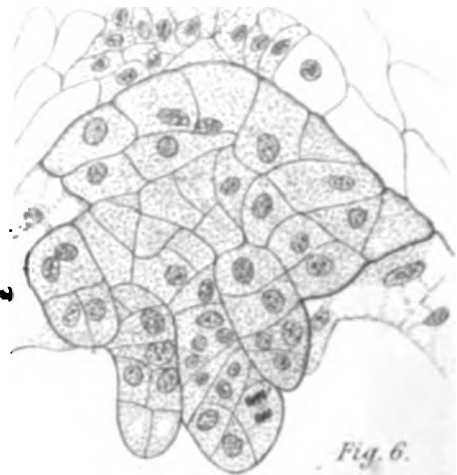
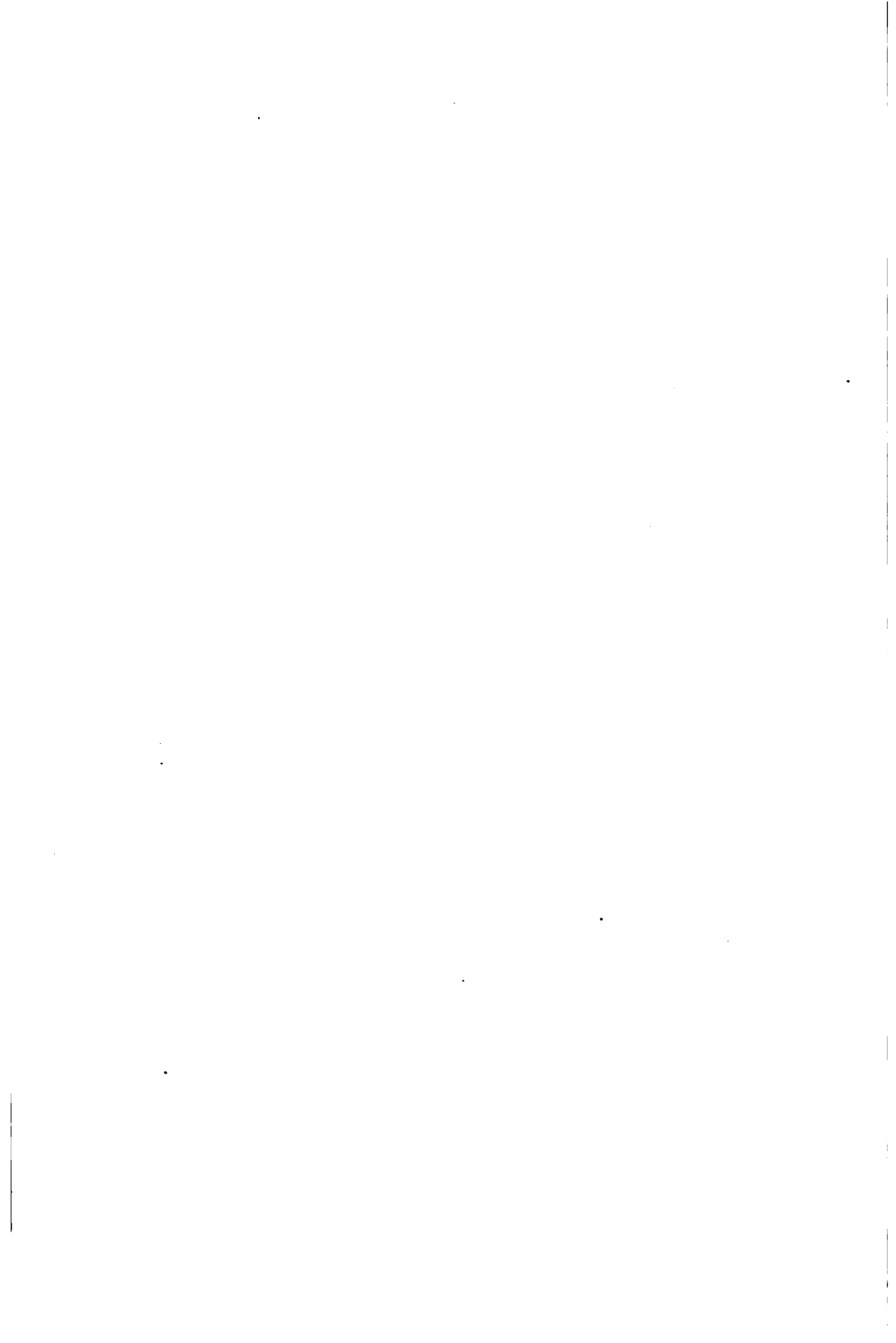
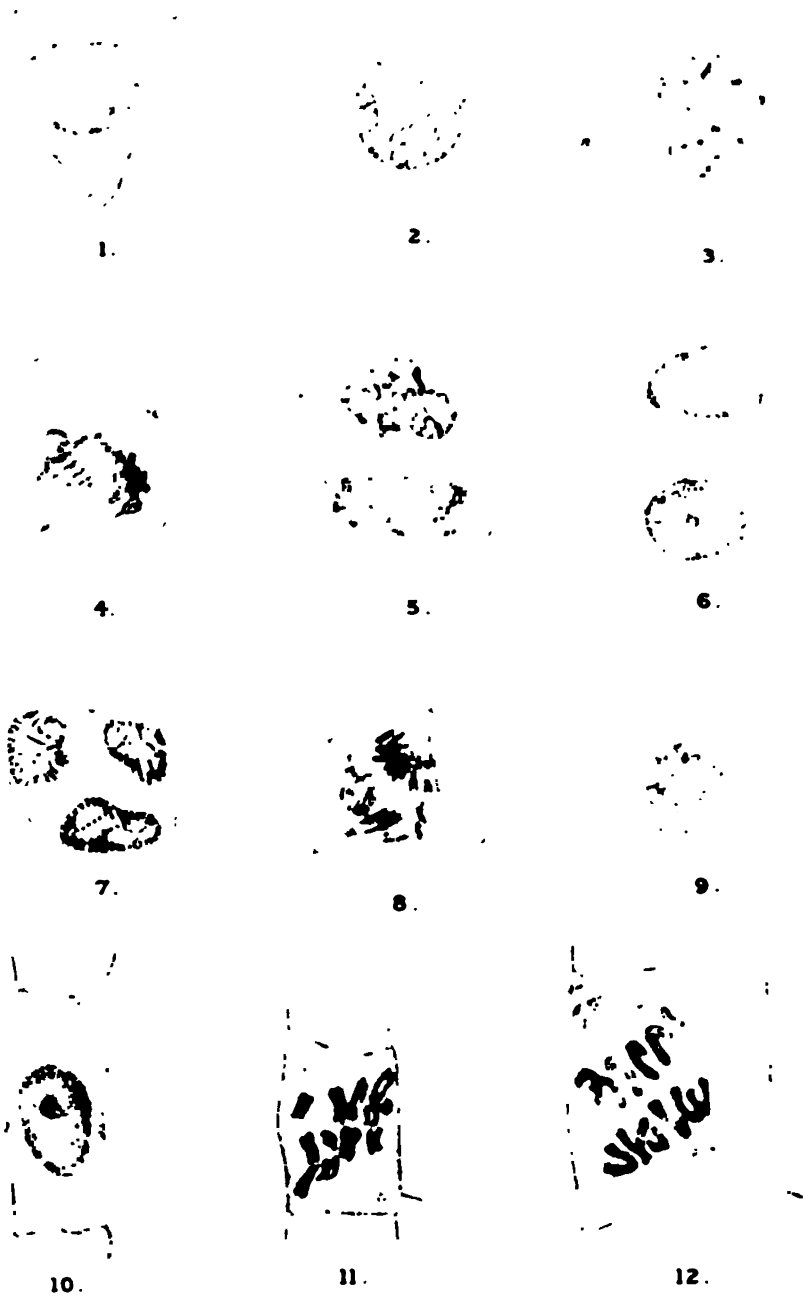

Fig. 6.





Humphrey del.

University Press Oxford

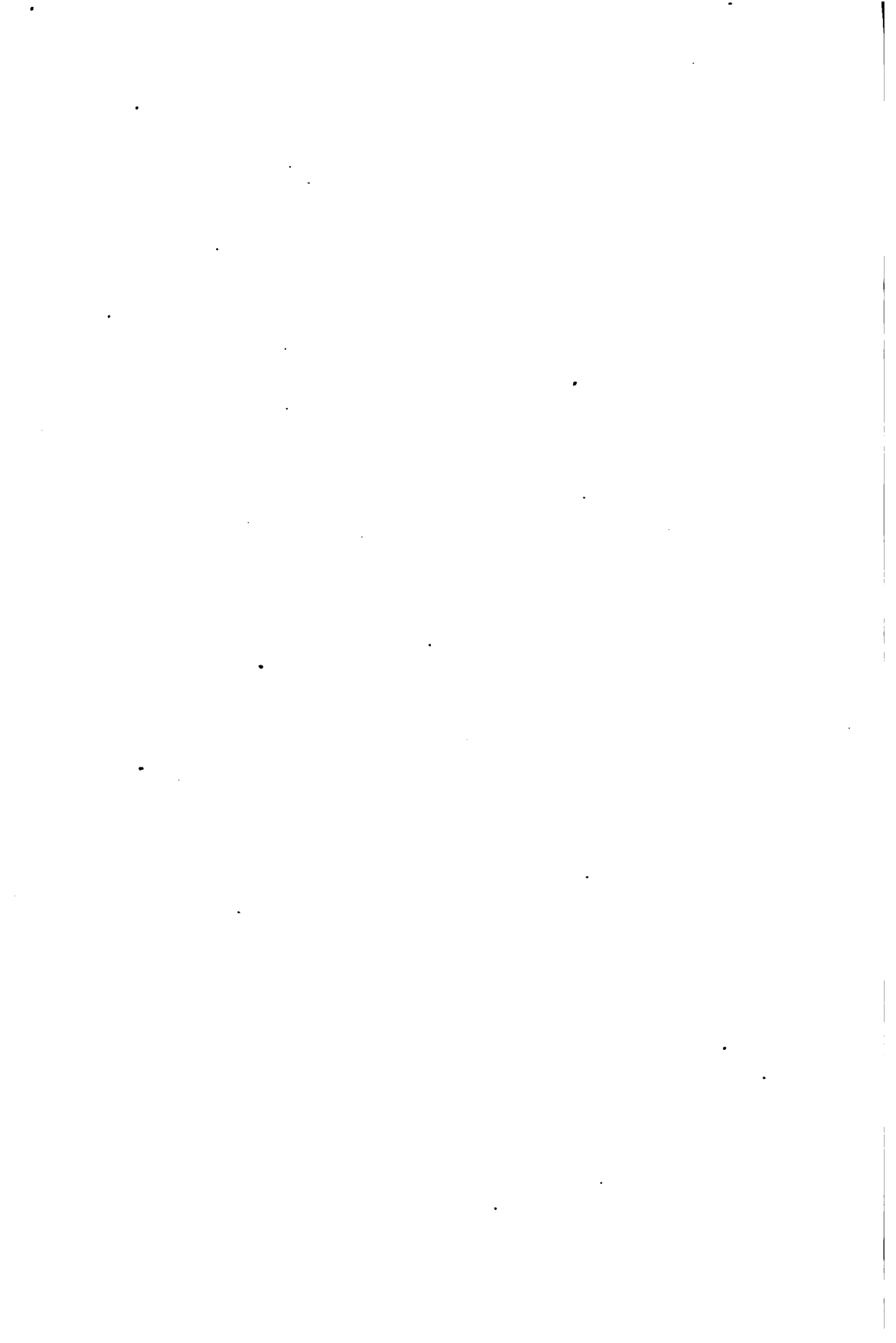

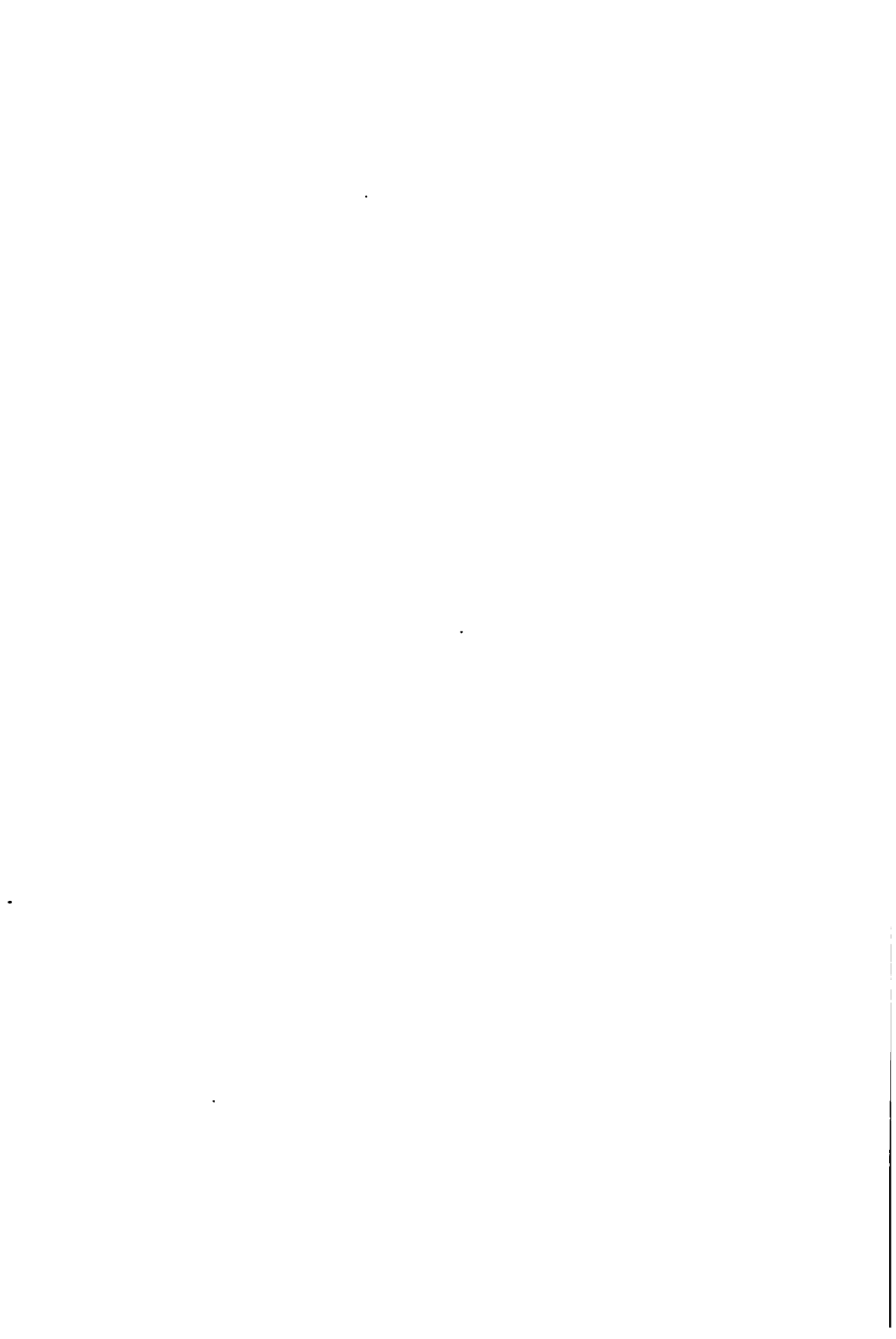

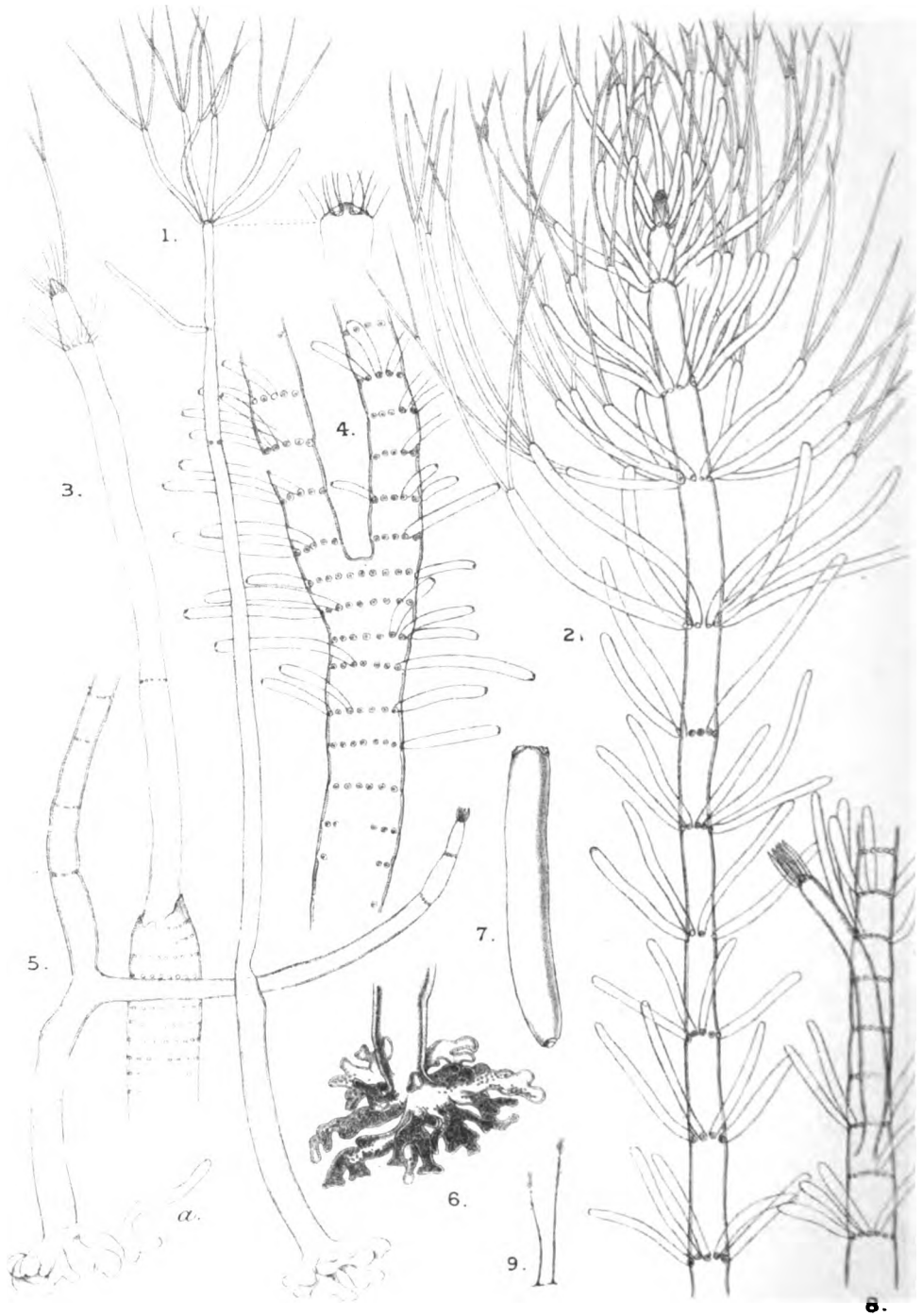

A. H. Church del.

CHURCH. — NEOMERIS.



10.

13.

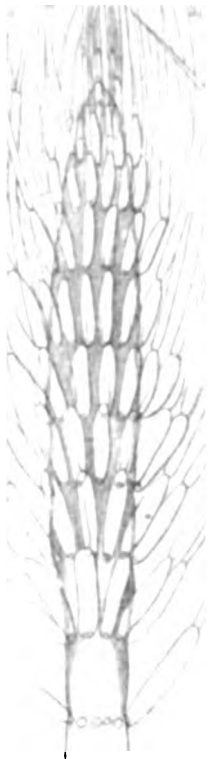

11.



14.

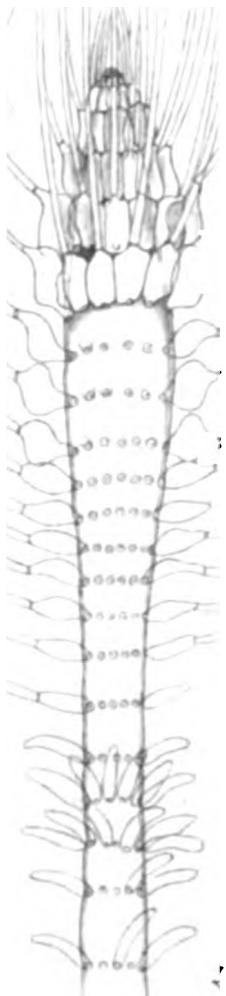

12.

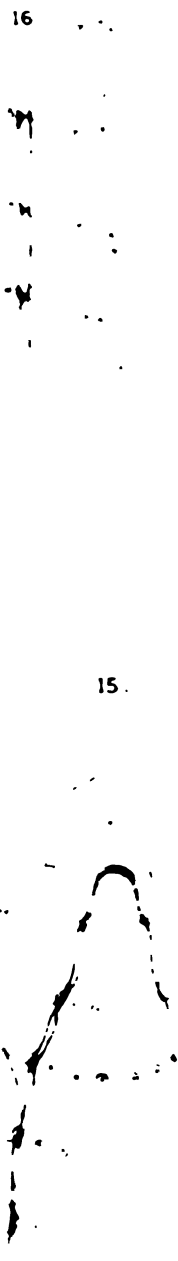

15.

16.

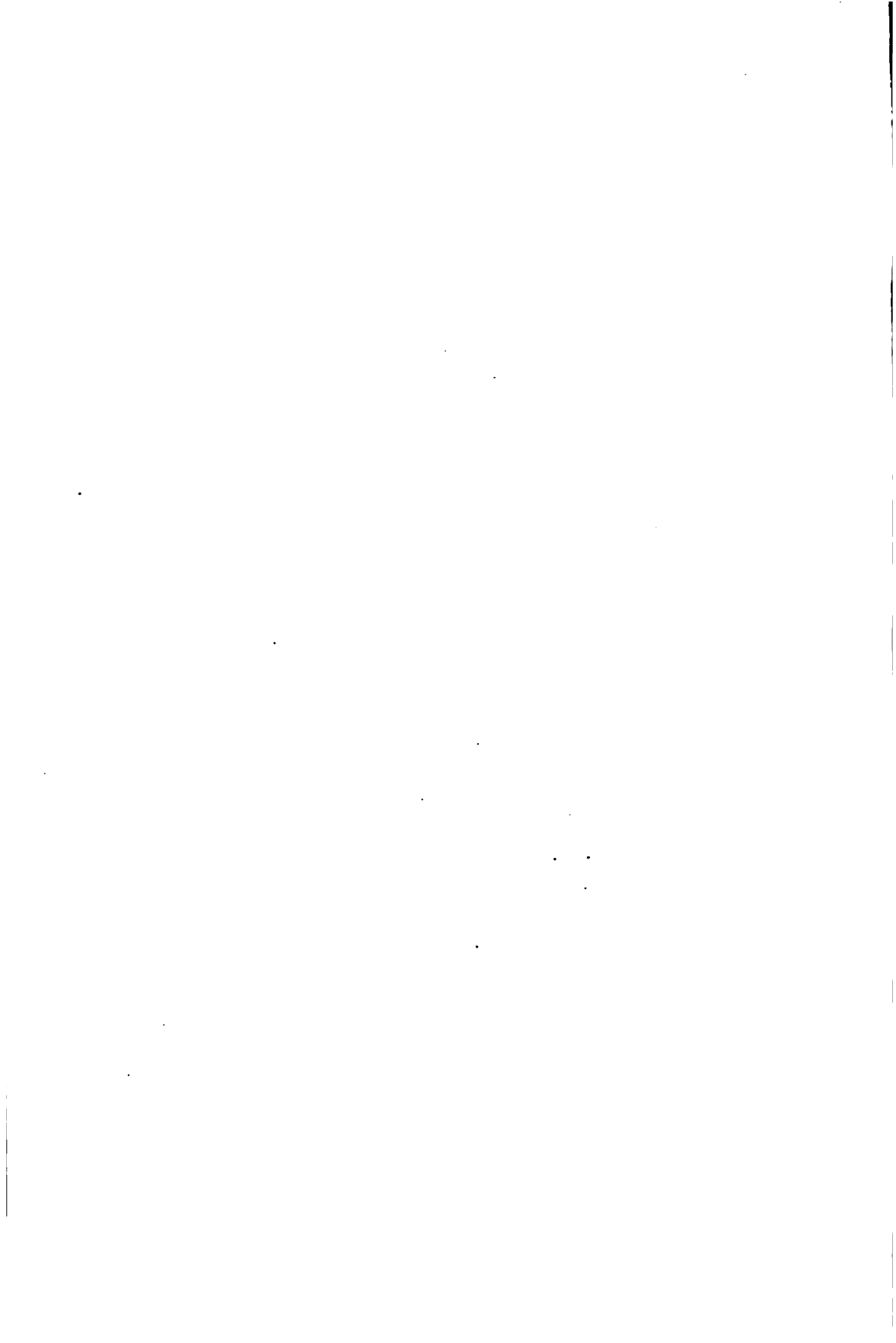

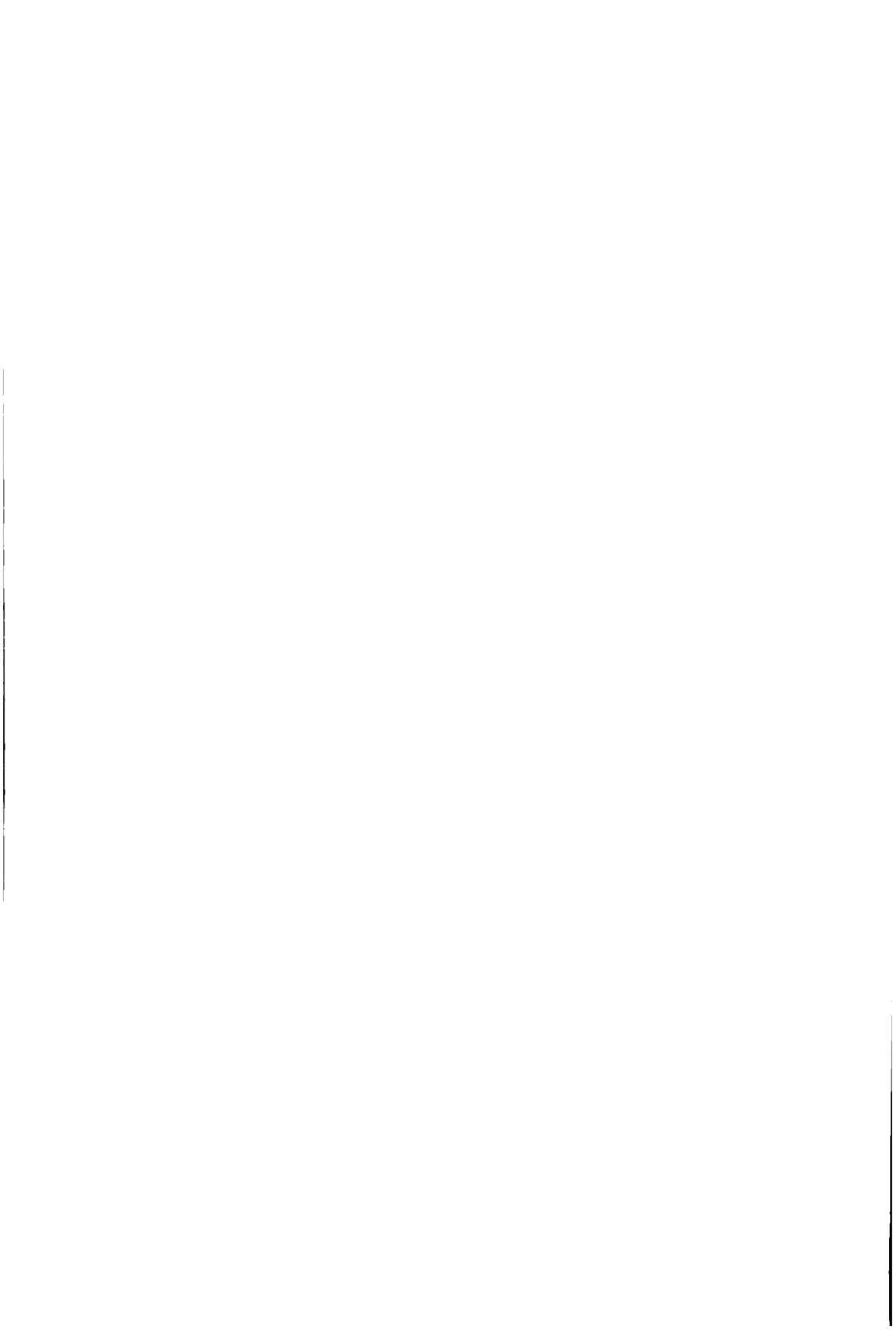

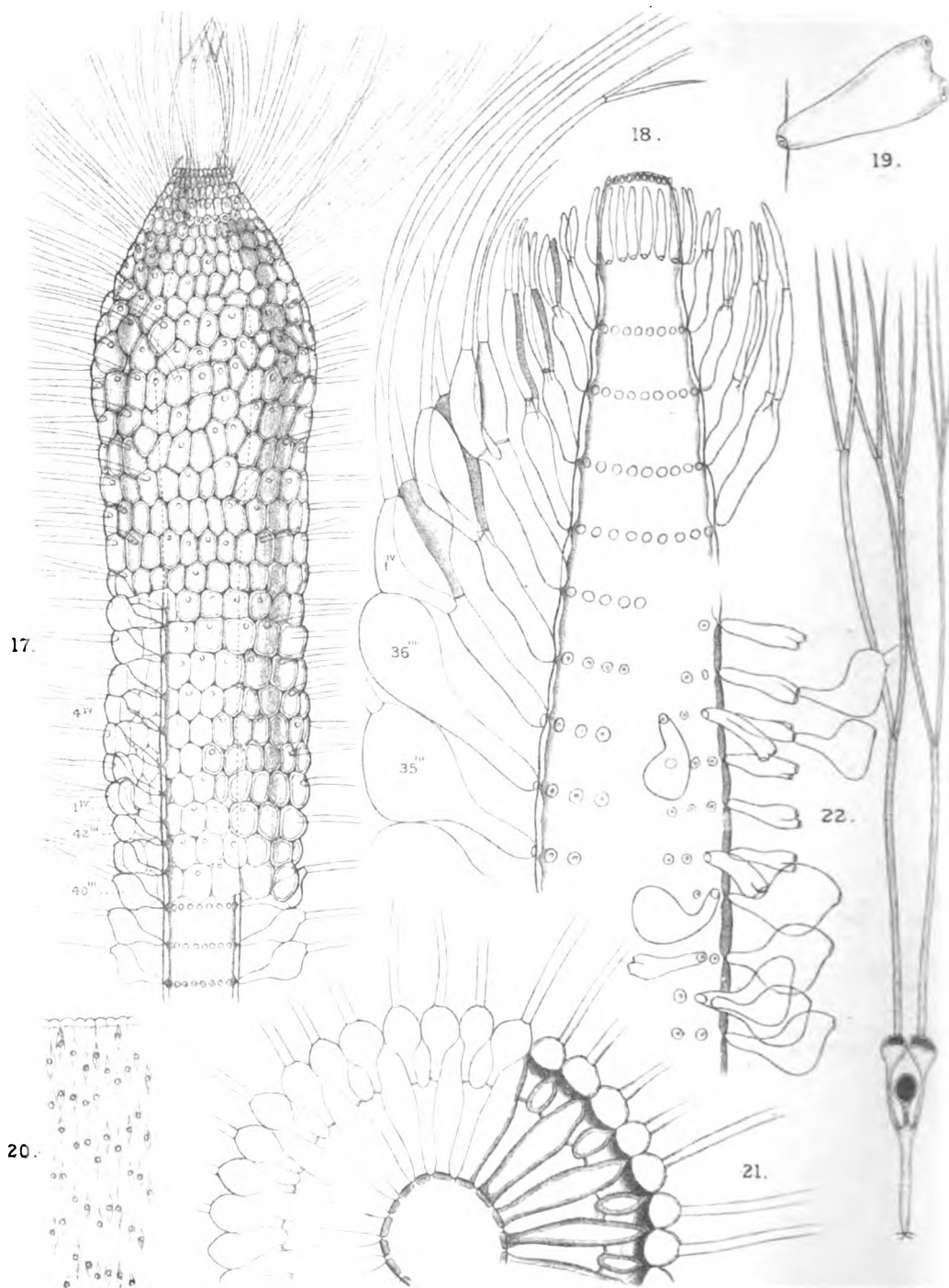

A. H. Church de.

24.

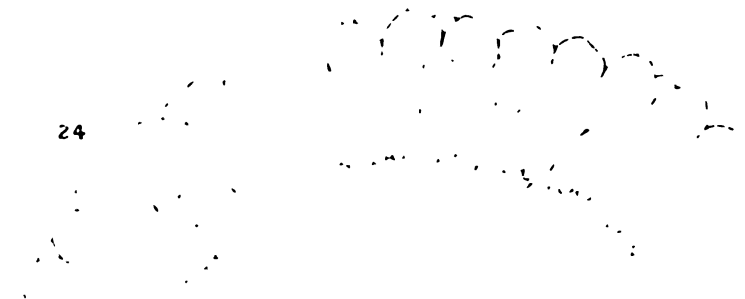

3.

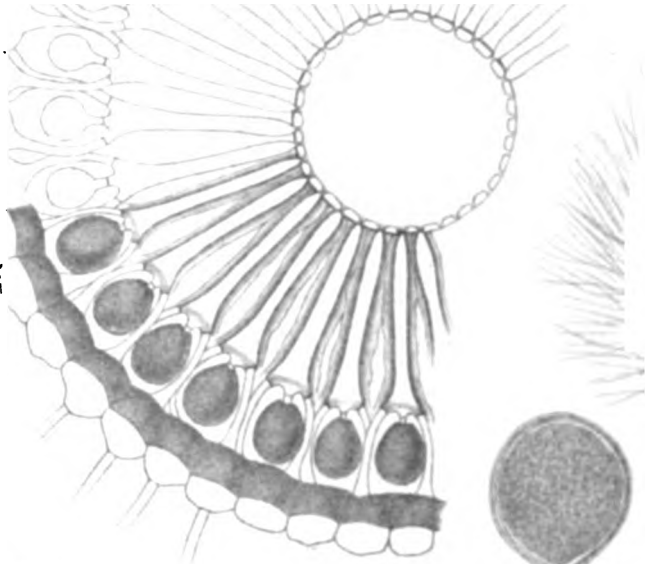

27.



28.

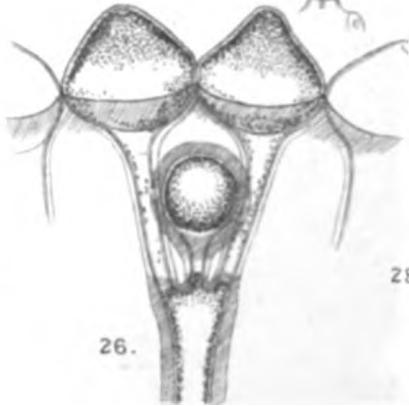

26.

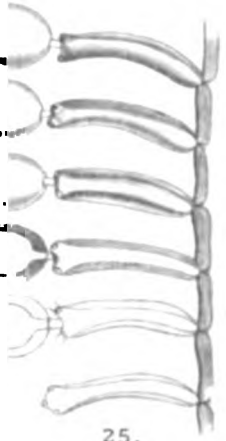

25.



29.



CHURCH -- NEOMERIS

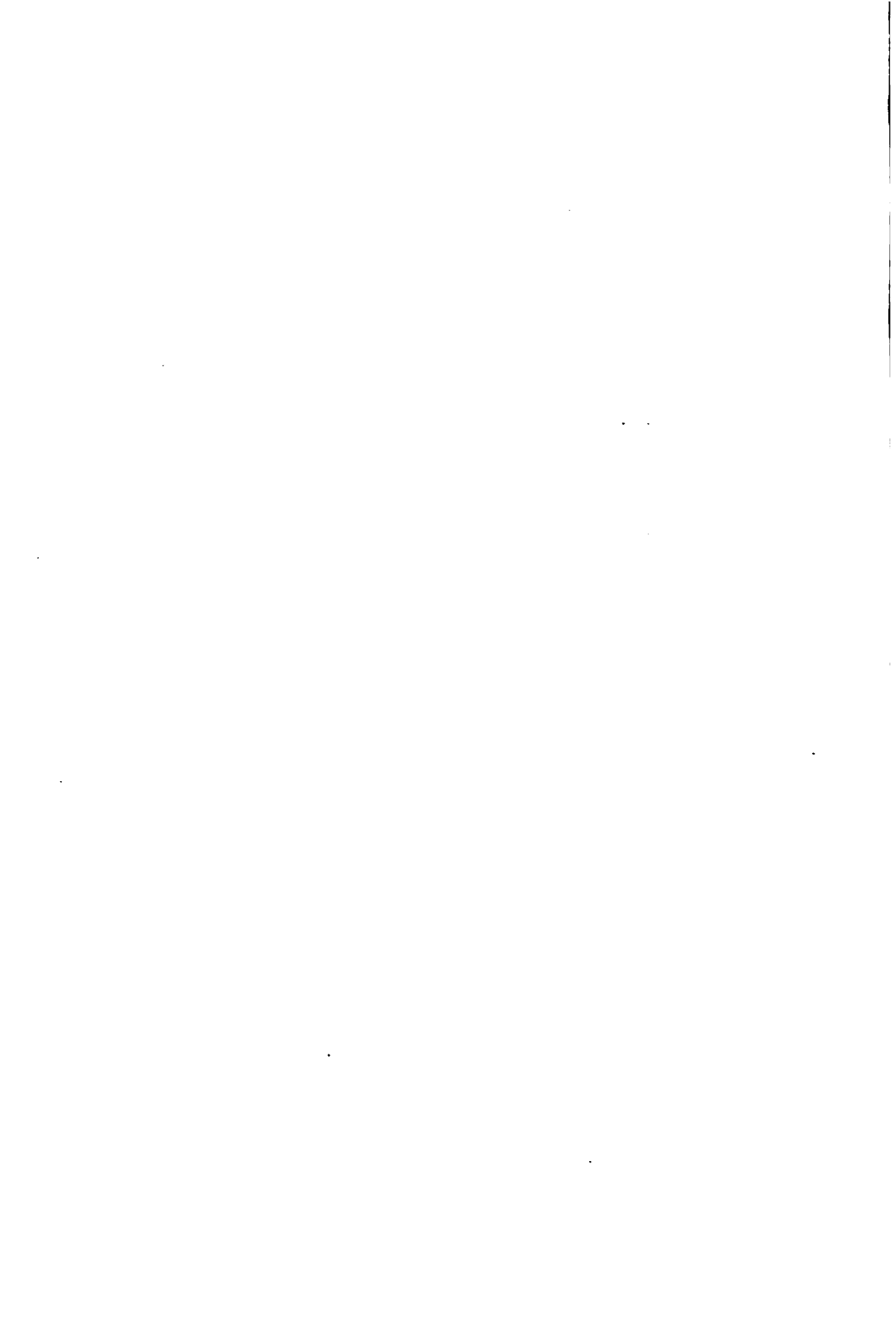

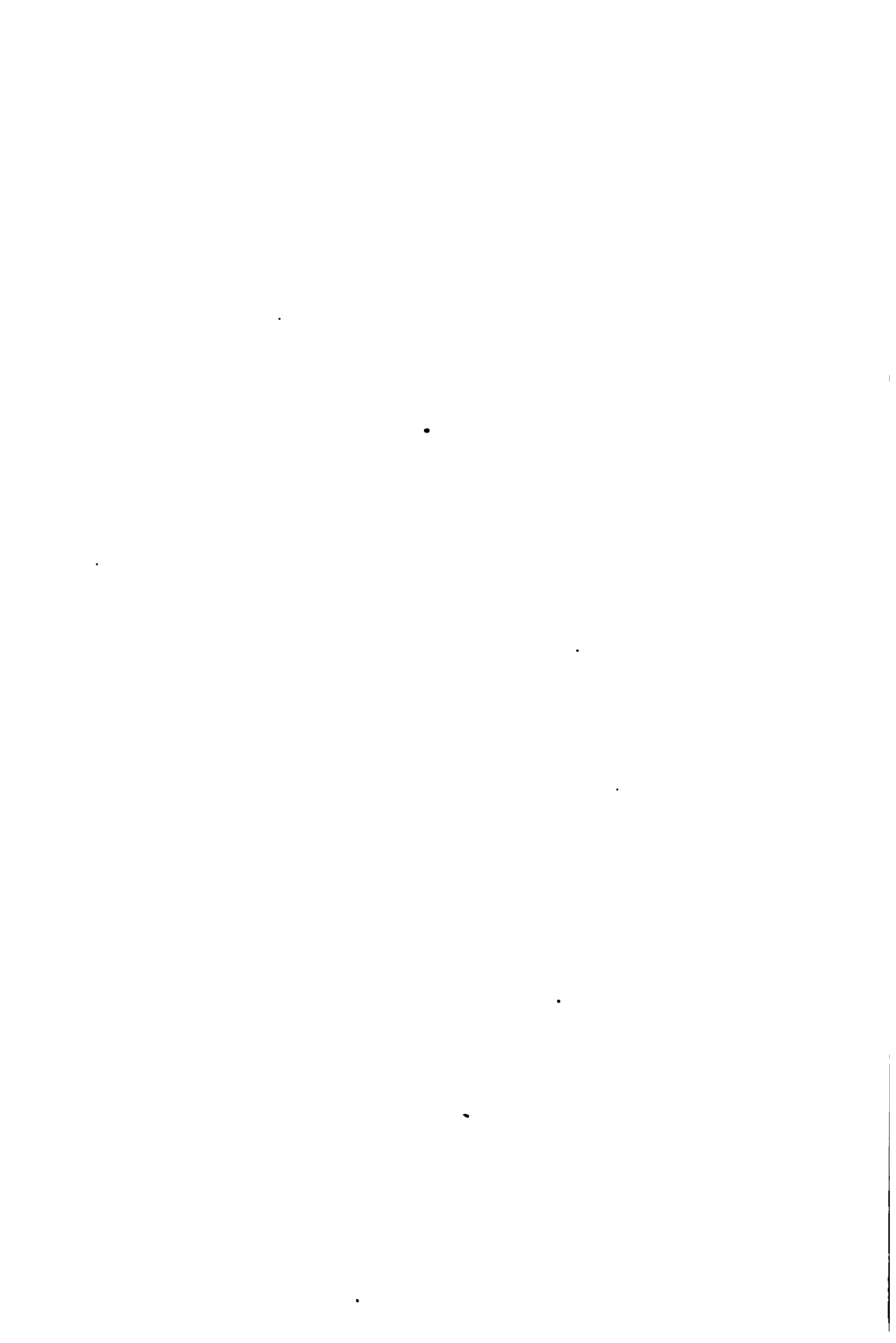

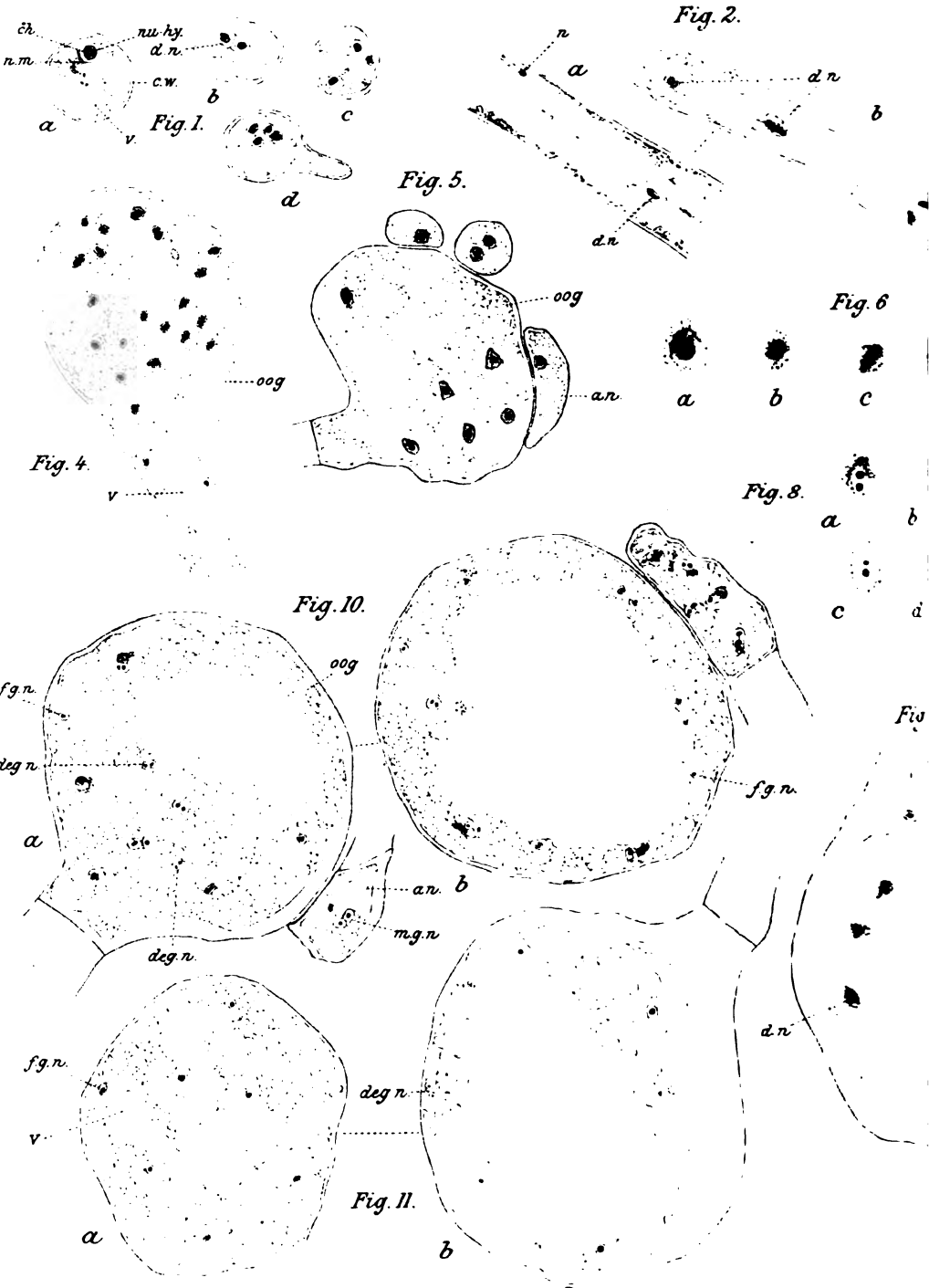

A H Trow del

Fig 3

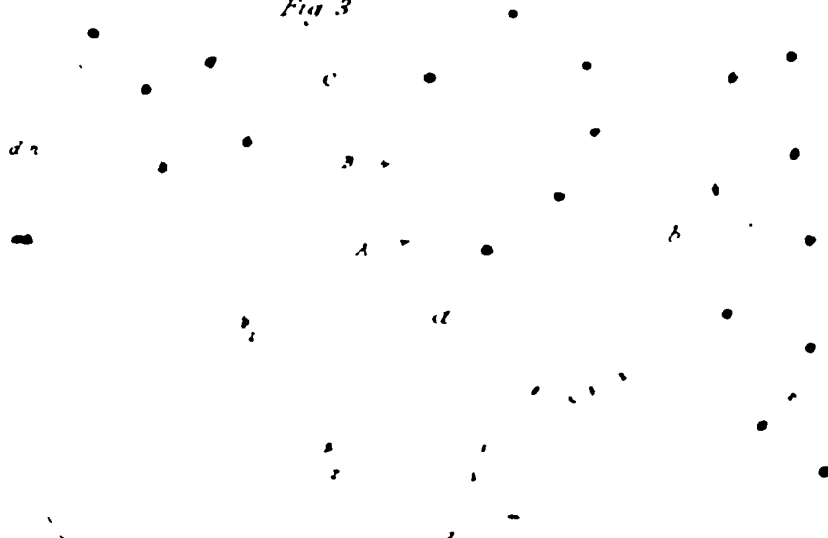

Fig. 9

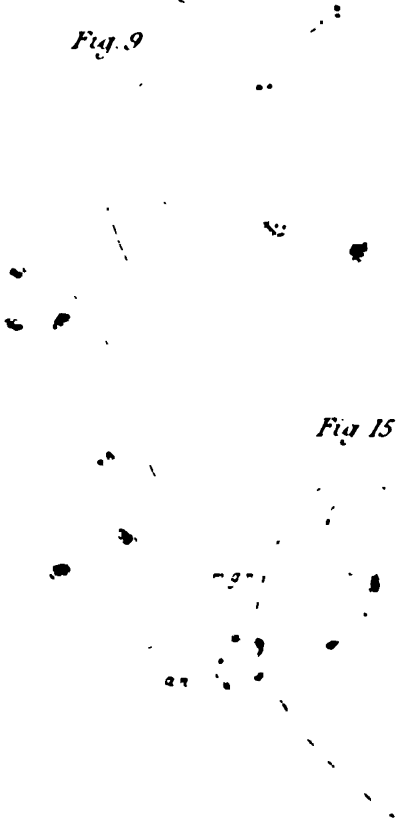

Fig 12

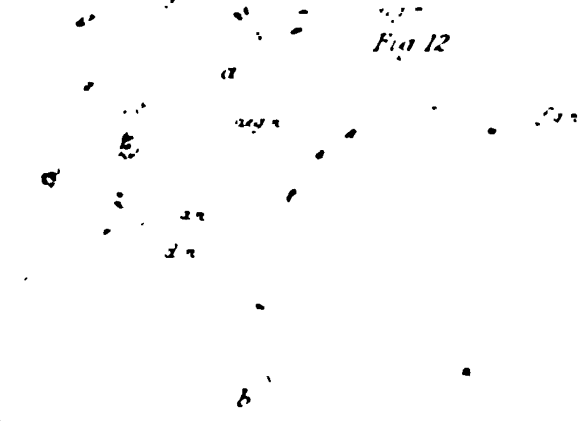
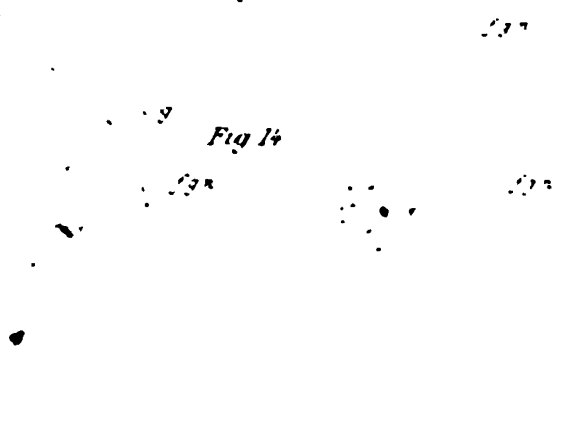

Fig 15



Fig 14



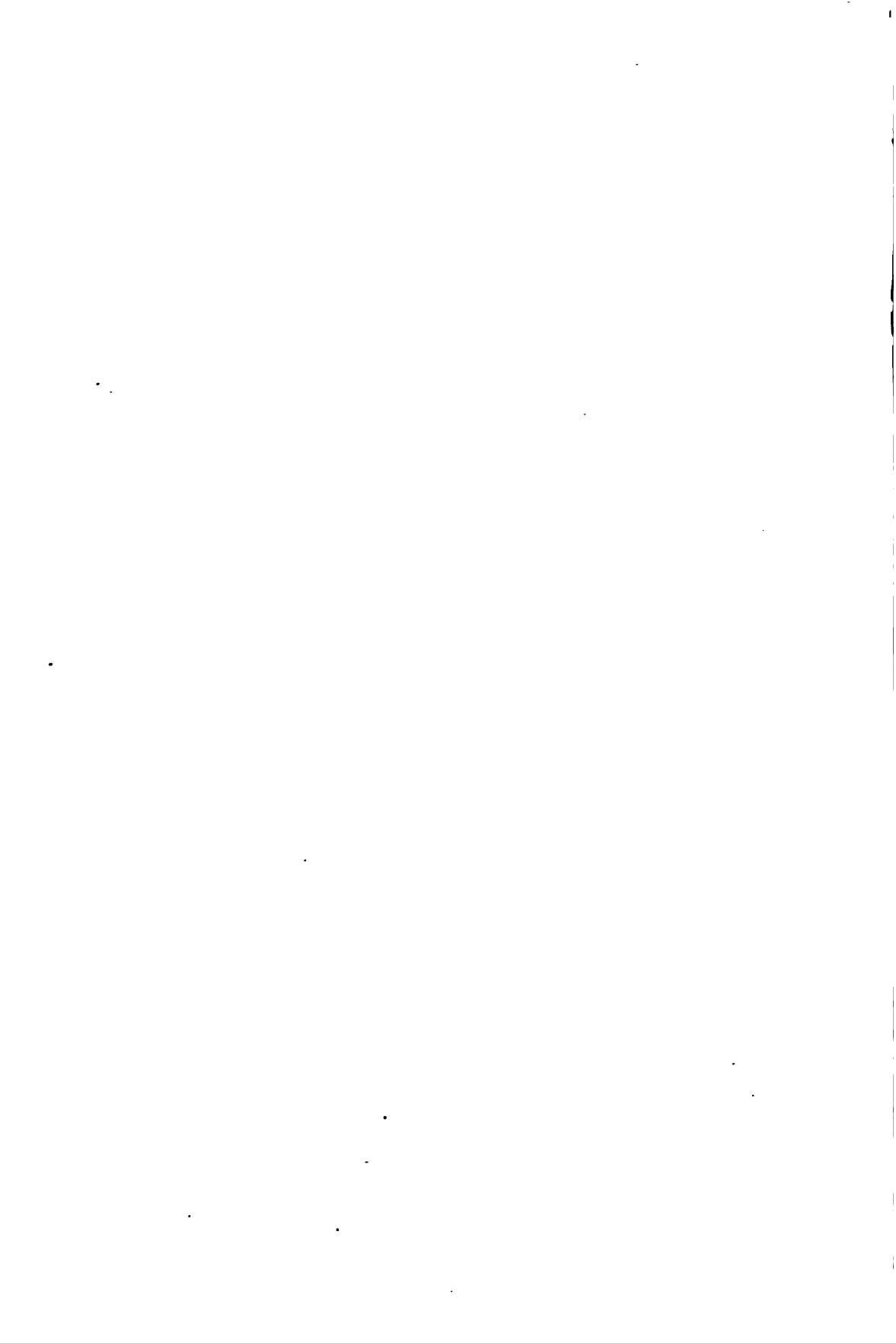





Fig. 13.



deg n

fg n

Fig. 16

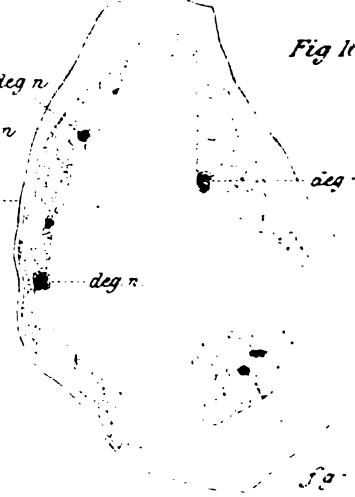

deg n

deg n

fg n

Fig. 19.



Fig. 20.

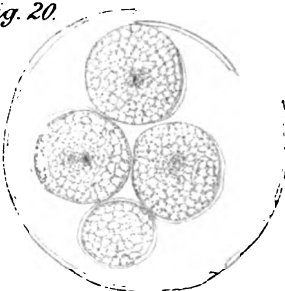

Fig. 21.

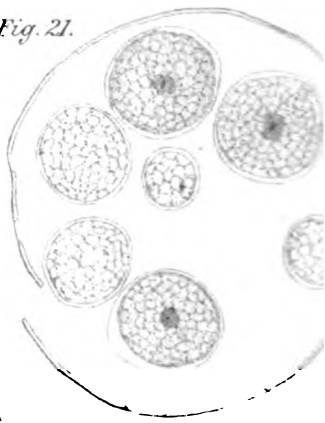

Fig. 24.

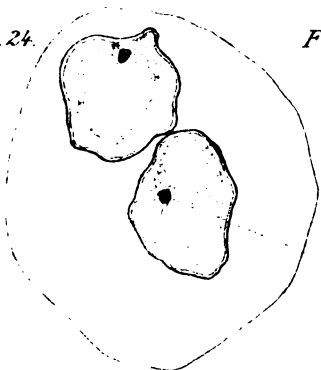

Fig. 25.

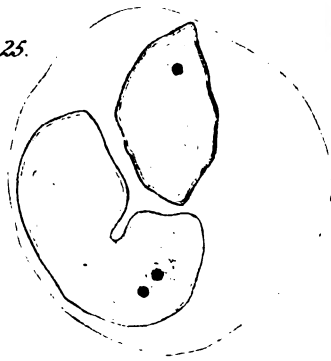
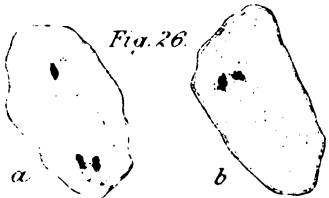

Fig. 26.



a

b

Fig. 27.

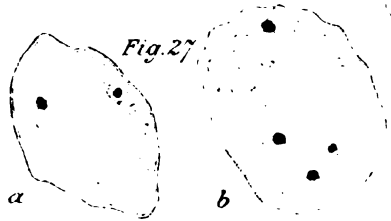

a

b

A.H. Trow del

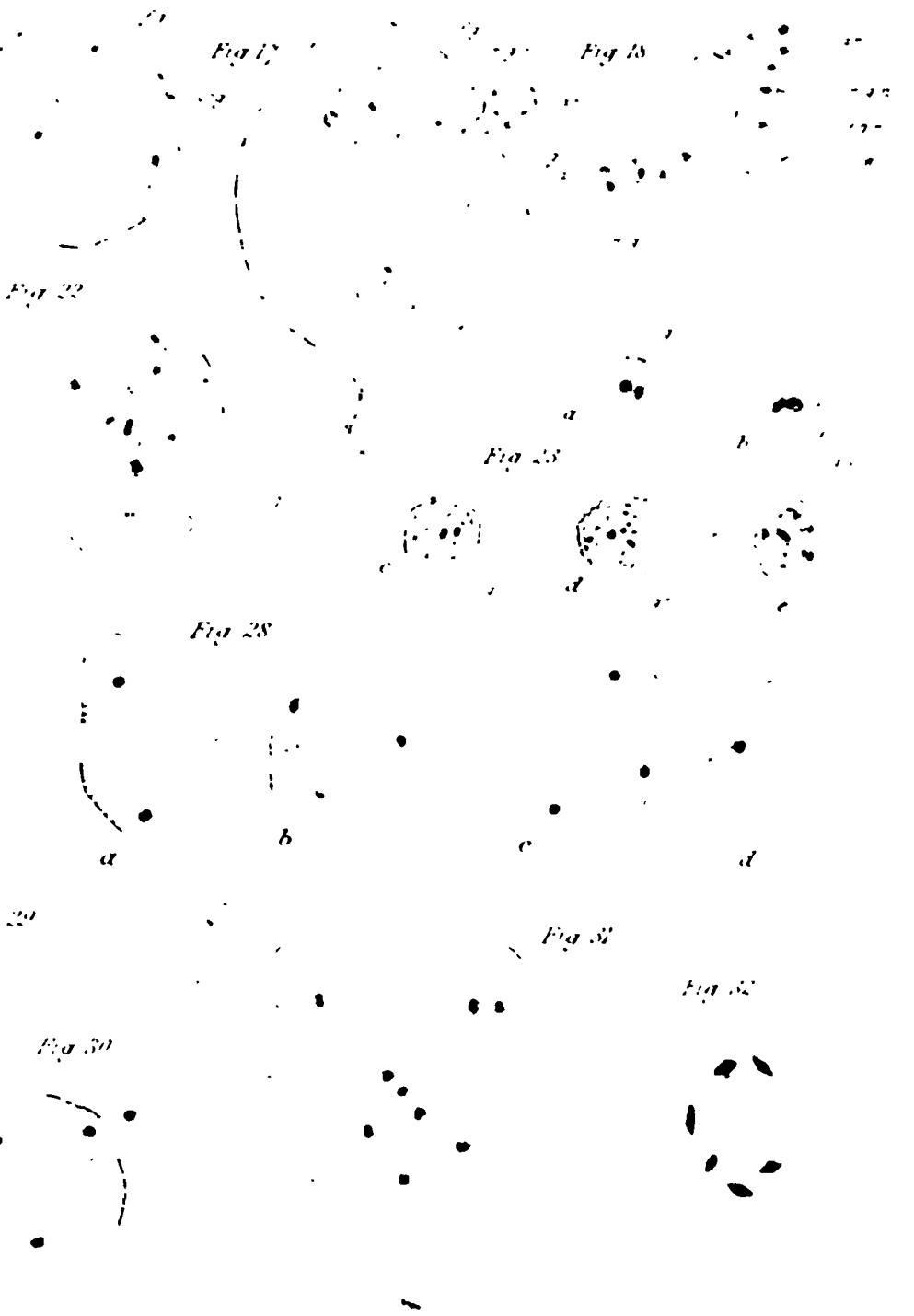

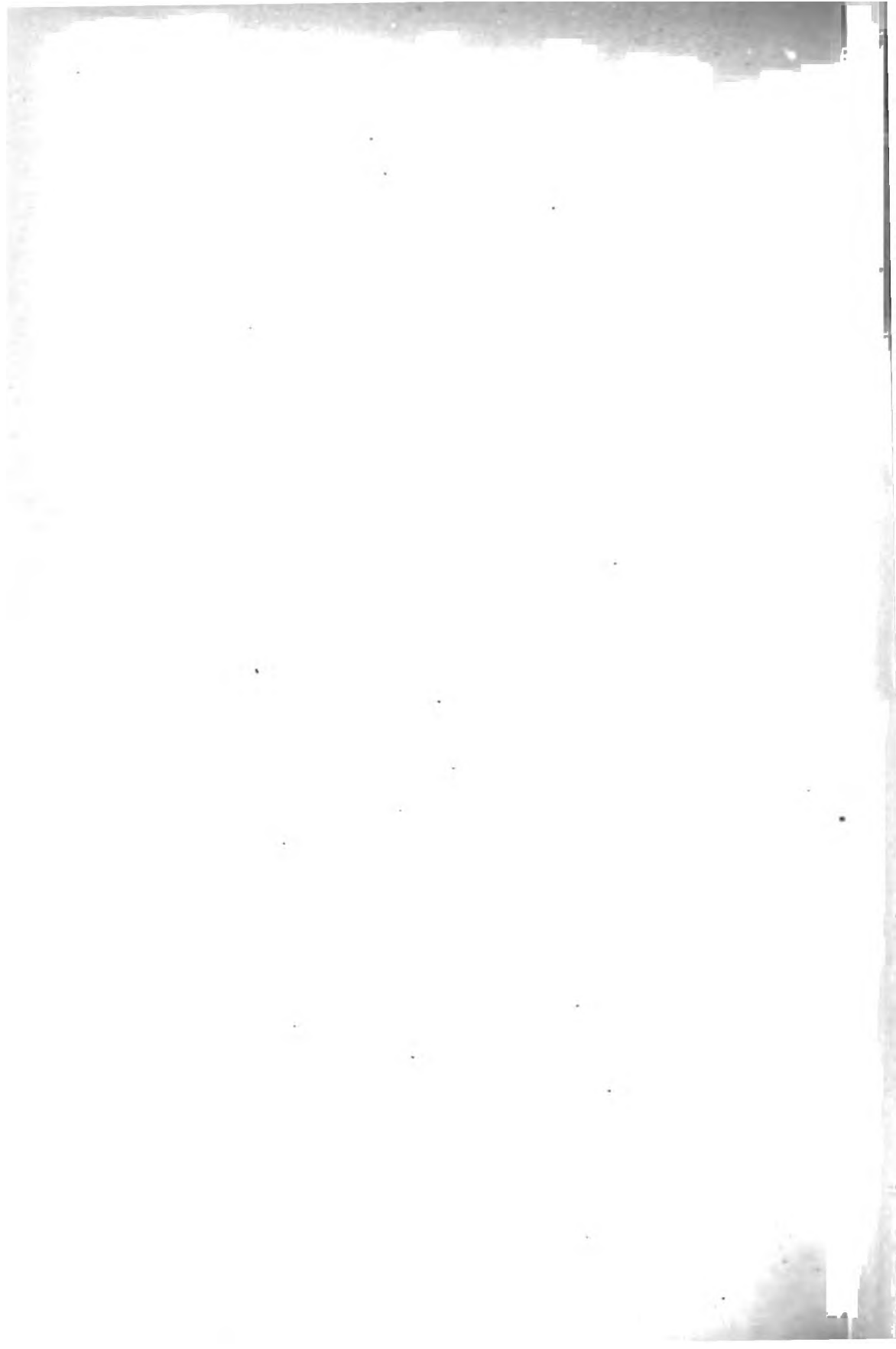

1198
Vol. IX. No. XXXIII. MARCH, 1895. Price 14s.

ANNALS OF BOTANY

EDITED BY

ISAAC BAYLEY BALFOUR, M.A., M.D., F.R.S.

QUEEN'S BOTANIST IN SCOTLAND, PROFESSOR OF BOTANY IN THE UNIVERSITY
AND KEEPER OF THE ROYAL BOTANIC GARDEN, EDINBURGH

SYDNEY HOWARD VINES, M.A., D.Sc., F.R.S.

FELLOW OF MAGDALEN COLLEGE, AND SHERARDIAN PROFESSOR OF BOTANY
IN THE UNIVERSITY OF OXFORD

D. H. SCOTT, M.A., Ph.D., F.R.S.

HONORARY KEEPER OF THE JOYRELL LABORATORY, ROYAL GARDENS, KEW

AND

WILLIAM GILSON FARLOW, M.D.

PROFESSOR OF CRYPTOGAMIC BOTANY IN HARVARD UNIVERSITY, CAMBRIDGE, MASS., U.S.A.

ASSISTED BY OTHER BOTANISTS

London

HENRY FROWDE, AMEN CORNER, E.C.

Oxford

CLARENDON PRESS DEPOSITORY, 116 HIGH STREET

1895

CONTENTS.

	PAGE
MASSEE, G.—A Revision of the Genus <i>Cordyceps</i> . (With Plates I and II)	1
GROOM, P.—On a New Saprophytic Monocotyledon. (With Plate III)	45
KEEBLE, F. W.—The Hanging Foliage of certain Tropical Trees, (With Plate IV)	59
HAECKER, V.—The Reduction of the Chromosomes in the Sexual Cells	95
WORSDELL, W. C.—On the Comparative Anatomy of certain Species of the Genus <i>Christisonia</i> . (With Plates V and VI)	103
BOODLE, L. A.—Spores in a Specimen of <i>Tempskya</i> (Endogenites). (With Woodcut 1)	137
HEMSLEY, W. B.—Descriptions of some New Plants from Eastern Asia. (With Plates VII and VIII)	143
NOTES.	
JOHNSON, T.—Sporangia of <i>Litosiphon</i> , Harv.: a Correction	161
BLACKMAN, F. F.—Experimental Researches on Vegetable Assimilation and Respiration:—	
(1) On a New Method for Investigating the Carbonic Acid Exchanges of Plants	161
(2) On the Paths of Gaseous Exchange between Aërial Leaves and the Atmosphere	164
BATTERS, E. A. L.—Some New British Algae	168
MASSEE, G.—On an Orchid-Disease	170

The subscription price of each volume of the *Annals of Botany* is thirty shillings (paid in advance), and the parts, four in number, are supplied to subscribers as they appear. Non-subscribers are charged at a higher rate; the price of individual parts varying according to size.

Subscribers should send their names with subscription to Henry Frowde, Oxford University Press Warehouse, Amen Corner, London, E.C.

As the earlier volumes of the *Annals of Botany* are becoming scarce, Vol. I will only be sold as part of a complete set; and Parts will not as a rule be sold separately, after the publication of the volume to which they belong.

A few extra copies of particular Parts at present remain on hand, for which special application must be made to the Editors, Clarendon Press, Oxford.

Each contributor to the *Annals of Botany* is entitled to receive gratis twenty-five copies of his paper, and may purchase additional copies if he informs the Editors of his wishes in this respect when he returns corrected proofs. The price of these additional copies will depend upon the amount of text and the number of plates in the paper.

Communications from intending contributors should be addressed to the Editors, at the Clarendon Press, Oxford.

ANNALS OF BOTANY, VOL. IX.

No. XXXIII, March 1895, published at 14s., contains the following papers and notes:—

	PAGE.
MASSIE, G. A Revision of the Genus <i>Cordyceps</i> . (With Plates I and II)	1
GROOM, P.—On a New Saprophytic Monocotyledon. (With Plate III)	45
KEEBLE, F. W.—The Hanging Foliage of certain Tropical Trees. (With Plate IV)	59
HAECKER, V.—The Reduction of the Chromosomes in the Sexual Cells	95
WORSDELL, W. C.—On the Comparative Anatomy of certain Species of the Genus <i>Christisonia</i> . (With Plates V and VI)	103
BOODLE, L. A.—Spores in a Specimen of <i>Tempskya</i> (Endogenites). (With Woodcut 1)	137
HEMSLEY, W. B.—Descriptions of some New Plants from Eastern Asia. (With Plates VII and VIII)	143

NOTES.

JOHNSON, T. Sporangia of <i>Litosiphon</i> , Harv.: a Correction	161
BLACKMAN, F. F.—Experimental Researches on Vegetable Assimilation and Respiration:—	
(1) On a New Method for Investigating the Carbonic Acid Exchanges of Plants	161
(2) On the Paths of Gaseous Exchange between Aerial Leaves and the Atmosphere	164
BATTERS, E. A. L.—Some New British Algae	168
MASSIE, G.—On an Orchid-Disease	170

