

TT 520

.G55

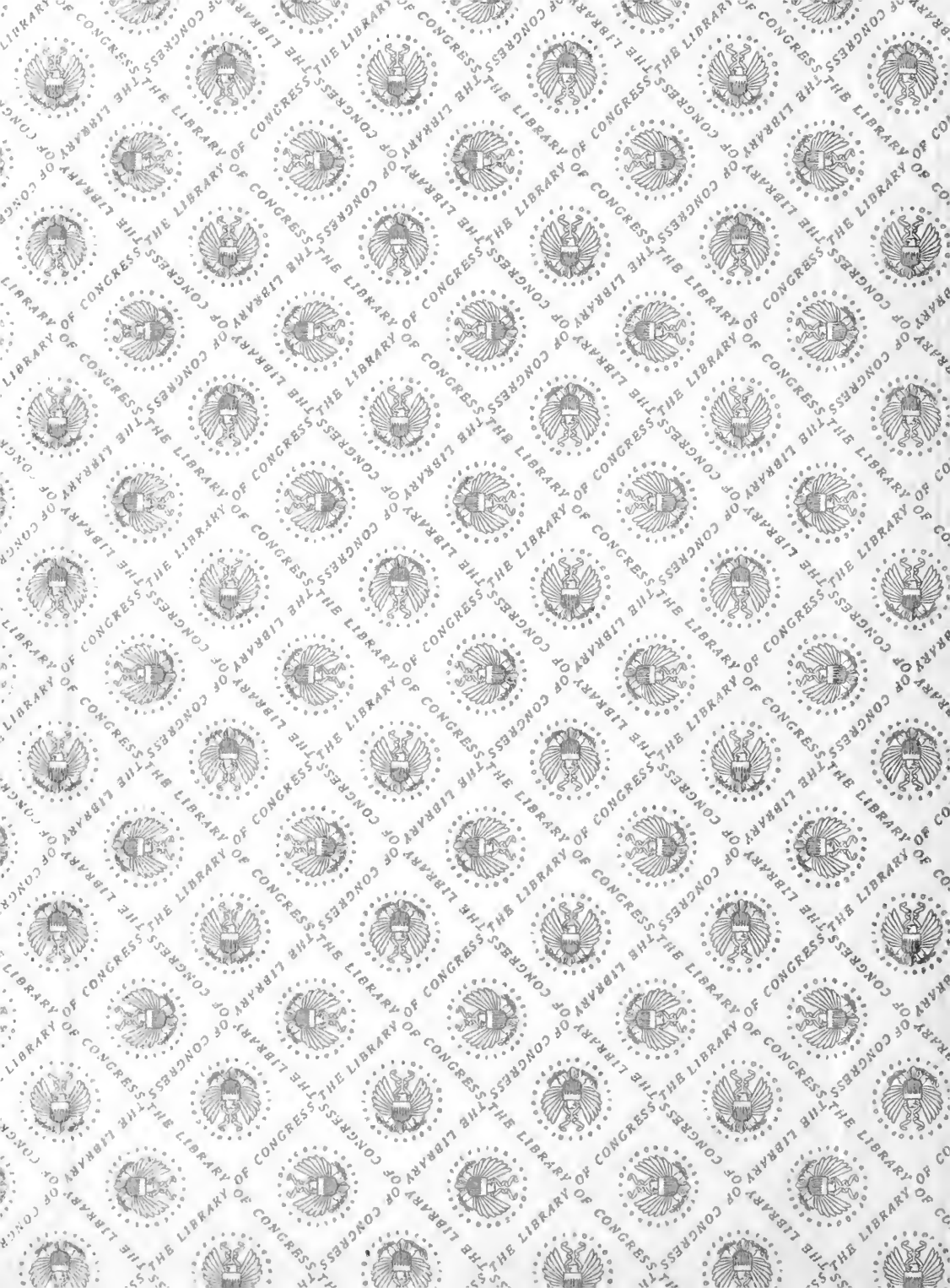

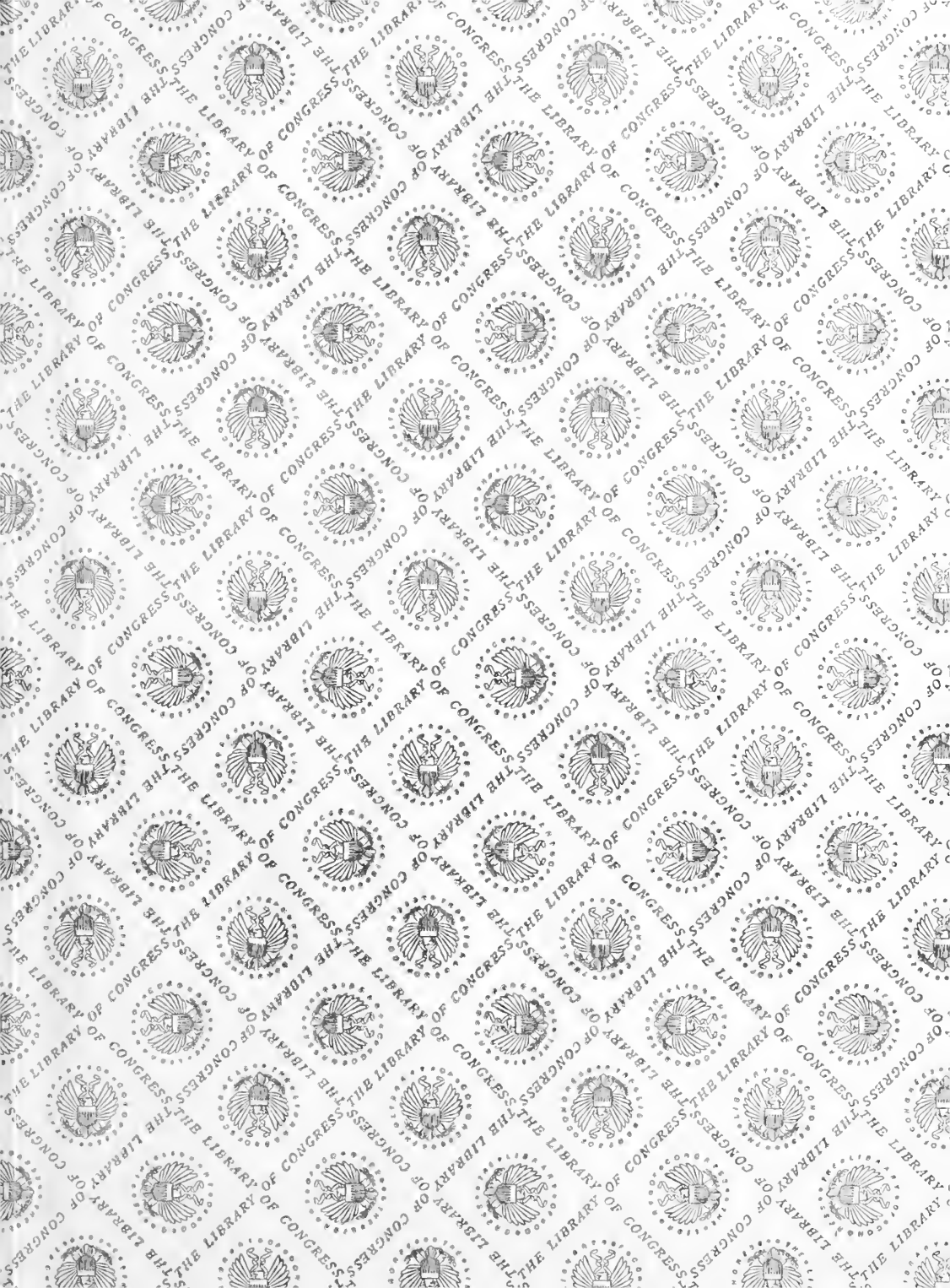

A SCIENTIFIC GUIDE
TO
PRACTICAL CUTTING.

EVERY STYLE OF GARMENT TO FIT THE HUMAN FORM.

BY WILLIAM GLENCROSS,

AUTHOR OF "A GUIDE TO PRACTICAL CUTTING;" "A MANUAL, OR TRUE GUIDE;" AND OF THE
"CUTTER'S MONTHLY JOURNAL, AND SEMI-ANNUAL REPORT OF FASHIONS."

IN ONE VOLUME.

ILLUSTRATED BY DIAGRAMS OF NEARLY EVERY STYLE OF GARMENT THAT IS NOW
WORN BY EITHER MEN, YOUTH, OR CHILDREN: ALSO, LADIES' BASQUINES
AND HABITS BY ACTUAL MEASUREMENT, COMBINED WITH PRO-
PORTIONS, BY THE ESTABLISHMENT OF A CENTRE POINT.

NEW YORK:

Published by WILLIAM GLENCROSS, 569 Broadway.

1873

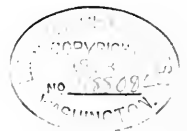

TT 520
G 55

Entered, according to Act of Congress, in the year one thousand eight hundred and seventy-three, by
WILLIAM GLENCROSS,
in the office of the Librarian of Congress at Washington.

208950*

CA 10-3286 Uurev'd

P R E F A C E .

IN introducing this, my third work on cutting, I do it with renewed confidence, looking at it from Reason's standpoint, its basis being established upon the immaculate principles of philosophy and common sense, which will at once be its best recommendation to all thinking minds, who have either studied or taken an interest in how to fit the human body in all its various forms, and also to give it that character for artistic beauty of style, and elegance in its appropriateness to the structure to be suited, which is the ambition of all artistic cutters.

There are many cutters, or students of the art, who have not as yet come up to the high standard here referred to, having paid but little attention to the cause-and-effect principles of the art, a strict observance of which can alone cultivate and improve the mind in that which it is essential for it to know, and fully understand the various structures of the human form, and how best to carry out the results of those ideas necessary for its requirements. It is believed that the student in taking a strict observation of the diagrams laid down in this work—the great variety and artistic beauty of their execution—and reading the instructive ideas explanatory of the same, will have his mind sufficiently exercised on scientific problems with a disposition to reduce the same to practice, as to be the initiatory step to study and future progress. The present work is based on the same principles as our late work, the "Manual," which run out over a year ago, after having gone

through three editions; and at no time since it was first published has there been so great a demand for the work as during the past year. Perhaps no work of the kind, or the principles contained in it, have ever met with such universal approbation. We believe it has reached and been practiced in almost all parts of the civilized world. We have been called upon in one week to send a system to Australia on the one hand, and to the Hawaiian Islands on the other.

It would be a work of supererogation for me to go into details respecting the merits of the late work. In fact, wherever it or its representatives has gone, its superiority has been duly acknowledged and appreciated. To such an extent has this been the case, that in certain cities of the West, we have been credibly informed by respectable merchant tailors, that they would not employ a cutter who did not use our system. We are in possession of hundreds of letters at this office eulogizing the principles of the work, and tendering their thanks to the author for their remarkable success. I could mention the names of thousands who are now in position, influence and wealth through the instrumentality of the ideas inculcated in the aforesaid work and their author. The demand for the work has rendered it necessary that I should set my head to work again; and I can assure my readers that it is no small business in the line of brain work. And I think I will not be accused by any of my readers, with the present work

before them, as being guilty of egotism, when I say that I have felt myself equal to the task.

As I have already stated, the present system is based on the same principles as the "Manual," namely—the anatomical proportions of the human form, by actual measurement, combined with proportions—the measures producing the proportions. In the old work, many of its principles were correct in themselves and incapable of being improved upon; while in the new work, actual measurement, through the instrumentality of the centre point in establishing the point of shoulder, becomes a demonstrated reality. This point being truly established, all other measures or points being equal, the cutting of a garment to fit the various shapes of the human form, remains no longer one of doubtful import, but becomes at once one of stern reality. No mantua-making arrangements of trying on are necessary in this system. But methinks I hear the following query: Do you mean to convey the idea, if the principles of your system are correct, that all men can be taught to measure correctly? I certainly believe that any man with ordinary capacity can be taught to measure correctly through a proper course of drilling, subject to the same mistakes that occur in other mechanical operations. But perhaps some will say: Will actual measurement, such as yours, produce as good style of garments as some of the other systems? My answer is, looking at the query from reason and practical observation, it will produce better styles, for the following reasons: A coat must fit in order to have good style; a man must be a draughtsman in order to cultivate and produce styles. The mantua-making, trying-on system completely neutralizes all style, as it destroys all taste for drafting and all confidence, depending entirely on a third party for whatever success it may

have, namely—the bushelman. But all bushelmen are not artists. In answer to all such queries, I would hereby state—show me any principle, either in science or in philosophy, which is correct in the abstract, and I will show you one that can be reduced to practice. But I do not mean to say by the foregoing that all men have the requirements to become artists; on the contrary, I positively do know that there are a great many engaged in the profession who must always be failures, Nature never having designed them for any such purpose, and had they studied their organism and its tendencies, might have been useful ornaments in some other sphere of action. But we would hereby positively assert, that through the instrumentality of our system, we have taken some individuals of very moderate capacity and made tolerably good cutters of them. As an illustration of this fact, I would refer to two cutters who learned at my office more than six years ago, one of whom is cutting in one of the first houses in New Jersey at the present time, and has filled some first-class positions; the other, when last heard from, was in Milwaukee. Two different foremen of mine, at different periods, wanted me to discharge these young men, after they had been practising for three or four weeks, stating to me that they could never make cutters of them. My answer in both cases was that there was no such letter in my alphabet as "could not." I took hold of the Milwaukee pupil myself, and I made him the best cutter out of a class of sixteen, which was then learning at my office. This statement will identify the individual to many.

In our new system we have made a change in our measuring square, so as to make it conform to the requirements of our new principle of taking the centre point, and by means of which we think they will be enabled to take the measures with greater

accuracy. As there are many in the trade who have a prejudice against using any instrument for measuring, we have provided for this in two different ways, which will appear under the head of "Measurement."

To those who have had our former work we would say—you should undoubtedly have the new, coming, as it does, brightened up with new ideas and illustrating some of the old ones in a more practical form, clothed in a new dress and illustrated by some of the most beautiful diagrams that have ever been presented to the trade in any work. All the different styles of garments are laid down according to the newest fashion; and all the newest styles of cloaks are laid down in a neat and practical form.

We present some very practical illustrations of corpulent and stooping men, with illustrations of military and naval uniforms; and also with most of the newest styles of children's costumes, and a very neat illustration of the newest styles of ladies' basques and habits. To those who have learned with us, this work will be of much value and interest; and to all, as a work of reference, when they are called upon oc-

asionally to cut garments, not in the ordinary line of cutting, but which can be found in this work, where everything is laid down so as to meet the requirements of the trade. It is believed no other work of the kind ever published contained such an amount of useful information; and I might add here, for the very best of reasons—their authors never had any practical experience on the subject.

In conclusion I have to say that the present work has cost me a great deal of care and study in the transferring of my ideas through its lettered pages. The principles laid down in this work are not of doubtful import, but are the production of one of the first tailors of the age; and as he feels positive that this is his last work on cutting, as his future in this life must necessarily be short, he feels a strong conviction, which is to him a source of gratification, that the principles as embodied in this work will live long after him, and that it will be the means of producing wealth to thousands yet in the unforeseen future as it has in the past, is not only the firm conviction but also the hope of the author,

WILLIAM GLENCROSS.

NEW YORK, September, 1873.

ON MEASUREMENT.

HOW TO MEASURE.

ON the outset, we would solicit the earnest attention of the reader or student to the proper way of taking the measure as laid down and illustrated in this work, for the very obvious reason, if your measure is taken correctly, you will be very likely to cut correctly. And in order to attain this very desirable result, we would suggest the following plan, particularly to tailors in the rural districts, where they very frequently have customers come to be measured for a coat in their shirt sleeves, and not unfrequently with very bad fitting coats on them to measure over, as also these suggestions may be useful to a great many cutters:—I would suggest, to all whom it may concern, to have four or five skeleton jackets, made of some heavy cheap goods, to extend a little below the waist, and to button up the front—the cut of said jackets to be of that character which will fit the greatest number of customers—and when a customer comes along, put on one of your jackets for the purpose of measuring over.

Our advice is never to measure over a sack coat if it can be avoided; the sack coat requiring greater length of back from the bottom of sye up, would be very likely to show that extra length in the measure, and when applied to another coat cut through the waist, would produce too much length of back; and if applied to a sack coat, the extra allowance should not be given in the draft.

With these preliminaries, we will now call the reader's attention to Figure 1. On measurement, draw the coat you are about to measure over, into its proper place on the customer; have it buttoned; examine the coat which you are about to measure over, whether it is too low in the sye

or too high, because, if care is not taken, you will be likely to fall into the same error; then feel the socket-bone or nape of neck, as some call it, and if the collar seam is not right on it, then mark it with a piece of chalk; then take the measuring square with the solid elbow in your right hand, and cause your customer to raise his arms, and place the elbows of square close up under arm; then let the arms fall down to their natural position, and as they fall down draw the two elbows of square close together on the body; then step to the right side of your customer and take a side view, and see whether the elbows are placed right straight across the body or not; then put a mark on centre of back on the upper side of square, and establish the point of bottom of sye on back, then apply the square at natural waist; at hollow of waist, just above the hip-bone, draw the elbows close together; let it be straight across the body, and make a mark on centre of back underneath. In order to have uniformity in our measure, we will first proceed with Figure 3, or diameter crosswise. Take the short arm of your square in your left hand with the fore finger resting on elbow as represented on the figure; raise your customer's left arm with your right; place the square underneath as represented, with the solid elbow close up to the front of sye, then bring the slide close up behind the arm, press them closely together but not tight, then take the square off and examine the side that was next to the body, and count the distance between the elbows, say $4\frac{1}{4}$ or diameter crosswise, with $\frac{1}{4}$ for making up or $4\frac{1}{2}$, the half of which is the centre line.

We will now call the reader's attention to Figure 2, or diameter lengthwise. Take

measuring square in your left hand, just below the solid elbow ; then raise your customer's left arm with your right and put the solid elbow close up under the arm ; then let your customer's arm fall straight over it ; let the square be flat to the body and close up to the front of arm, the square being straight up and down ; then take your right hand and fetch the slide down on shoulder ; let your left hand be holding the square flat to the body at the same time, so as to avoid getting it too far in toward the neck or too much out ; then look between the two elbows and count the numbers, say $5\frac{1}{4}$ inches, or diameter lengthwise ; your diameter crosswise being $4\frac{1}{4}$, mark one half of that inside of elbow, at top of shoulder, with $\frac{1}{8}$ of inch added, which would be $2\frac{1}{4}$ or centre point, and also make a chalk mark inside of elbow, at same point.

We will now proceed to Figure 4, consisting of shoulder, sye, and elliptic measures. Take the long arm of square in your hand, a little below the elbows, so as to enable you to command it with more ease ; raise your customer's left arm with your right, and place the elbow of square close up under arm, and let your customer's arm fall down over it ; let the arm of square be flat to the body, and close up to the front of sye ; then stroke down the shoulder of your customer and loosen your hand from the front of sye, so that the shoulder may be in a natural and easy position ; then apply your measure up to the socket-bone ; see that the pivot of measure is properly turned by giving it a jerk, and the measure applied in a straight direction ; this we call shoulder measure ; we will suppose it $12\frac{1}{4}$ inches ; then apply your measure right over shoulder-blade to the centre of back at bottom of sye, (see Figure 1) ; be sure the measure is drawn in a straight direction ; this we call blade measure, and suppose it to be 17 inches ; we will then withdraw the square, and draw the inch measure

under the arm, and throw it over the right shoulder, so as to prevent its twisting, then raise the arm and place the square in the same position again, flat to the body and close up to the front of sye ; then draw the measure to the centre of back, under arm, give the measure a gentle pull and then let it rebound back to a breathing point, and touch centre of back, no matter how hollow the back may be ; this we call sye measure, say $11\frac{1}{2}$ inches ; then draw the pivot in the direction and apply measure to natural waist ; draw your hand right along the body in a straight direction, if there are wrinkles in the coat, gather them up ; give the measure a little pull and let it rebound back, and touch natural waist ; this we call elliptic measure and suppose it to be $12\frac{3}{4}$ inches, (see Figure 8). We take another proof measure for corpulent men only, as represented by $\frac{1}{2}$ waist on Figure 8 ; when we are taking the natural waist and marking underneath on centre of back, we also put a mark underneath at side ; and when we are taking shoulder measure with the square straight up and down, we put a mark inside of square, at side, on natural waist, thus producing a cross ; we then apply a measure from the cross to the natural waist, and use it in connection with the elliptic, in the case of corpulent men, so that the one can be a corrective of the other ; whatever difference exists we generally divide it. The measure taken from front of sye, around behind to $17\frac{1}{2}$ at top of back, on Figure 8, may be used as a corrective ; then place measuring square on as the upper measure, on Figure 1, with the elbows of square resting on Figure 8, or centre point, as represented on Figure 8, let it be straight across, mark inside toward the neck, and then measure the distance from back seam to centre point, which we will suppose 8 inches, which is the balancing point for shoulders of forepart.

* We will now finish with the inch measure.

Apply measure from socket-bone at neck to proof-centre, say 2 inches, then to bottom of sye $8\frac{1}{2}$ inches ; natural waist, $17\frac{1}{4}$; full length, 19 ; skirt 34 ; next, length of sleeve from centre of back to elbow and sleeve hand ; next, width of elbow and hand at the most prominent part, according to fashion ; next, breast and waist measure, as represented on Figure 6 ; which completes the coat measure with the measuring-square. We will now describe how the system may be used, and the measures taken without the measuring-square, in the following manner : Take the plain square, the short arm in your right hand, place it on the point of shoulder, touching the extreme point of shoulder-bone with your finger, as represented on Figure 1, and then lay elbow on said point, and let the long arm run straight across to the other shoulder, and make a mark underneath on centre of back ; then take the square and raise the arm of your customer, and put the long arm of square straight across under arm, make a mark on coat both in front of sye and behind on top of square ; then lay the straight edge of square close up to the front of sye, and make a cross mark at the front of bottom ; then let the edge of square range with the back seam of coat, with the top of short arm ranging with the chalk mark at back sye ; then put a mark on top of square at centre of back. You will, through this means, have established the depth of shoulder, and also the bottom of sye on back and front ; also a point at the bottom of sye in front, from which to take the shoulder measure and blade, and also the sye measure and elliptic, which should be taken with an inch tape from the cross mark in front of sye to the various points in the manner we have hitherto described. The natural waist can be marked by laying the short arm of a common square in the hollow of waist, with the long arm running straight across, and making a mark on

backseam in the same way I have described. In measuring by this plan care should be taken that the coat measured over should not be moved from its first position. The depth of sye and natural waist may be also very correctly taken with the inch measure by the plan represented on Figure 5 : Take the point of inch measure in your left hand as represented, draw the measure over right shoulder, around the arm, along underneath, and across the back, under the left arm, around the sye and over shoulder, and then place both ends of the measure in one hand, and draw the measure tight, and place it straight across the back with the other. The natural waist may be marked by putting the inch measure straight around the hollow of waist, and holding the measure tight in front, while you mark it with the other hand underneath ; behind, the diameter lengthwise and crosswise may be used in the following manner : By using $5\frac{1}{4}$ graduated inches for the length, and $4\frac{1}{4}$ for the width.

In extreme high or low shoulders or flat bodies, this plan would not work so well as taken with the measuring square. Fig. 7 is an illustration of our new measuring square.

Figure 8 is a diagram exhibiting the application of the measurement, and also a centre line all the way through from the middle of diameter on back to the centre line, which runs to the centre of diameter on back while in a joining position to the shoulder ; also the centre point and proof-centre. This can only occur, however, in certain proportions. The measure taken from front of sye away to $17\frac{1}{2}$ at top of back is one we never use, but some of our friends use it as a corrective in case they should take the depth of sye on back too long or too short ; by the application of this measure they can remedy it, but if the depth of sye on back is taken correctly it is entirely useless.



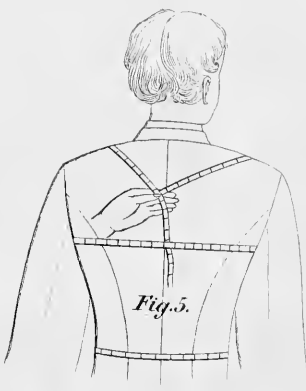
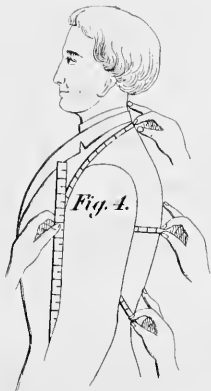
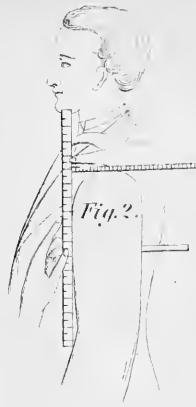
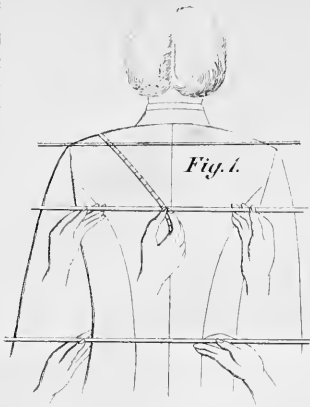

Measuring Square

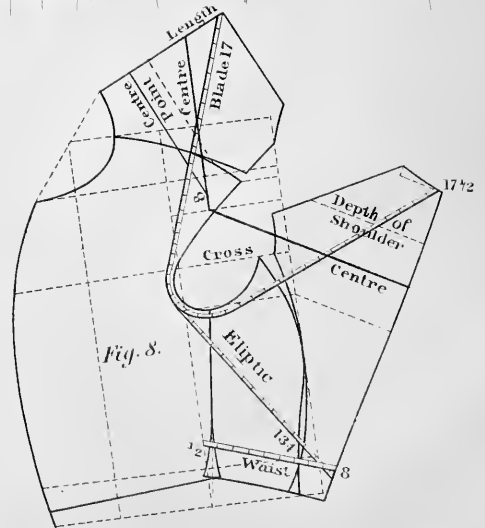
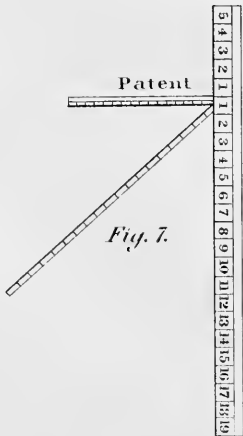

Description of Plate I.

FIGURE 1 is the depth of syc on back, taken with the measuring square, and also natural waist, taken at the hollow of waist above the loin bones; and also the blade measure, taken over the shoulder to centre of back at depth of syc on back, the square being placed in the same manner as on Figure 4.

Figure 2 is the diameter lengthwise. The diameter crosswise, as represented on Figure 3, should be taken before Figure 2, in order to know the diameter crosswise, so as to be enabled to mark the centre point on figure 2 by the slide on top of shoulder, which is half the diameter crosswise.

Figure 4.—On this figure we have represented shoulder measure, taken from the bottom front of syc to socket bone, and syc measure from same point under arm to centre of back; and also the elliptic from the same point to natural waist.

Figure 5.—On this figure is represented the way of taking the depth of syc and natural waist with the inch measure, by drawing the measure close up under arms and drawing it up over the shoulder, and after adjusting it in its proper place to hold it, as represented, and mark on the top at back seam. The natural waist may be taken by drawing the inch measure close above the loin bone.

Figure 6 represents breast and waist measure taken over the vest.

Figure 7 is the measuring square.

Figure 8 represents the system with the application of the measures, and exhibiting a centre all through from centre of diameter to centre with the centre point at 8. The proof measure at natural waist is only used in the case of corpulent men.

Description of Plates II. and III.

HOW TO DRAUGHT FROCK COAT.

WE would claim the reader's most ardent attention while we proceed to draught a coat by the system according to measure; and in doing so, we will select the measure laid down on plate III., which we will call the Bowband Coat, it being the first coat on which we demonstrated our new principle of the proof-centre or centre point. The diagrams on both plates are those of a Frock Coat. Plate II. represents that which we call the fair-proportioned type, the whole body of the coat being laid down in a solid piece with its accompanying appurtenances, to show the application of the measures, and in laying on the back to those points in which it stands connected, and exhibiting to view the manner of forming the forepart. In our explanation we shall refer to either plate as the circumstances of the case may require. The following is the measure: Diameter crosswise, $4\frac{1}{2}$; lengthwise, $5\frac{1}{4}$; shoulder, $12\frac{3}{4}$; blade, $17\frac{5}{8}$; sye measure, $12\frac{1}{4}$; elliptic, 14; centre point, 3; proof-centre, 2; depth of sye, $8\frac{1}{2}$; length of natural waist, $17\frac{1}{4}$; full length, 19; skirt, 34; length of sleeve to elbow, $20\frac{1}{2}$; full length, $32\frac{1}{2}$; width at elbow, $8\frac{3}{4}$; sleeve hand, $5\frac{1}{2}$. We will now proceed to draught back according to the measure: Draw construction line from 0 to 34; lay elbow of square on at 0, with the long arm inside from construction line $1\frac{1}{2}$ graduated inches, at natural waist, or $17\frac{1}{4}$; then draw back line from 0 to 19, or full length, and then square in top; mark down on back line 2 inches or proof-centre, and $8\frac{1}{2}$ or

depth of sye according to measure; square these lines across by back line and the waist by construction line; then lay your square on back line, your diameter lengthwise $5\frac{1}{4}$, resting on $8\frac{1}{2}$ and elbow on $3\frac{1}{4}$, and draw line diameter lengthwise; establish centre of diameter by dividing the $5\frac{1}{4}$ or $2\frac{5}{8}$, and mark $\frac{1}{2}$ inch below centre and establish line bottom of pitch at $6\frac{1}{4}$; then mark width of pitch from bottom 2 graduated inches, as from $6\frac{1}{4}$ to $4\frac{1}{4}$, and square those lines across; then mark on your line centre point 8 inches, according to measure. We will now proceed to the bottom line of pitch, and find width of pitch by laying the elbow of square on at $12\frac{1}{4}$ or sye measure, with $12\frac{1}{4}$ resting on back line; then deduct your diameter crosswise, off, which is $4\frac{1}{2}$, leaving the width of bottom of pitch $7\frac{3}{4}$; $\frac{3}{4}$ or $\frac{7}{8}$ may be added to top of pitch, as at $8\frac{5}{8}$, which should be regulated according to the fashionable width of shoulder; for width of top mark $2\frac{1}{2}$ graduated inches, square it up and mark $\frac{1}{2}$ inch for spring—in stooped men it should not be more than $\frac{1}{4}$; mark width of back at waist $1\frac{3}{4}$ inches, and at bottom $3\frac{1}{2}$; draw line from $\frac{1}{2}$ to $8\frac{5}{8}$, and from $7\frac{3}{4}$ to $1\frac{1}{2}$, and form top of back from 0 to $\frac{1}{2}$; shoulder from $\frac{1}{2}$ to $8\frac{5}{8}$; pitch from $8\frac{5}{8}$ to $7\frac{3}{4}$; sidescam from $7\frac{3}{4}$ by $3\frac{1}{4}$; skirt as model to $3\frac{1}{2}$.

HOW TO DRAUGHT FOREPART, FIGURE 4.

—Draw construction line from 0 to $22\frac{1}{2}$ square in top; mark down from 0 at top to find bottom of sye, your shoulder measure with the width of top of back included, with $\frac{1}{2}$ inch added for shoulder and

MEASURE

Diameter Lengthwise	5 $\frac{1}{4}$
Crosswise	4 $\frac{1}{4}$
Shoulder	12 $\frac{1}{4}$
Blade	17 $\frac{1}{4}$
Sye	11 $\frac{1}{2}$
Depth of Sye on back	8 $\frac{1}{2}$
Waist	17 & 19
Proof Centre	2 & 7 $\frac{3}{4}$
Breast	18
Waist	16

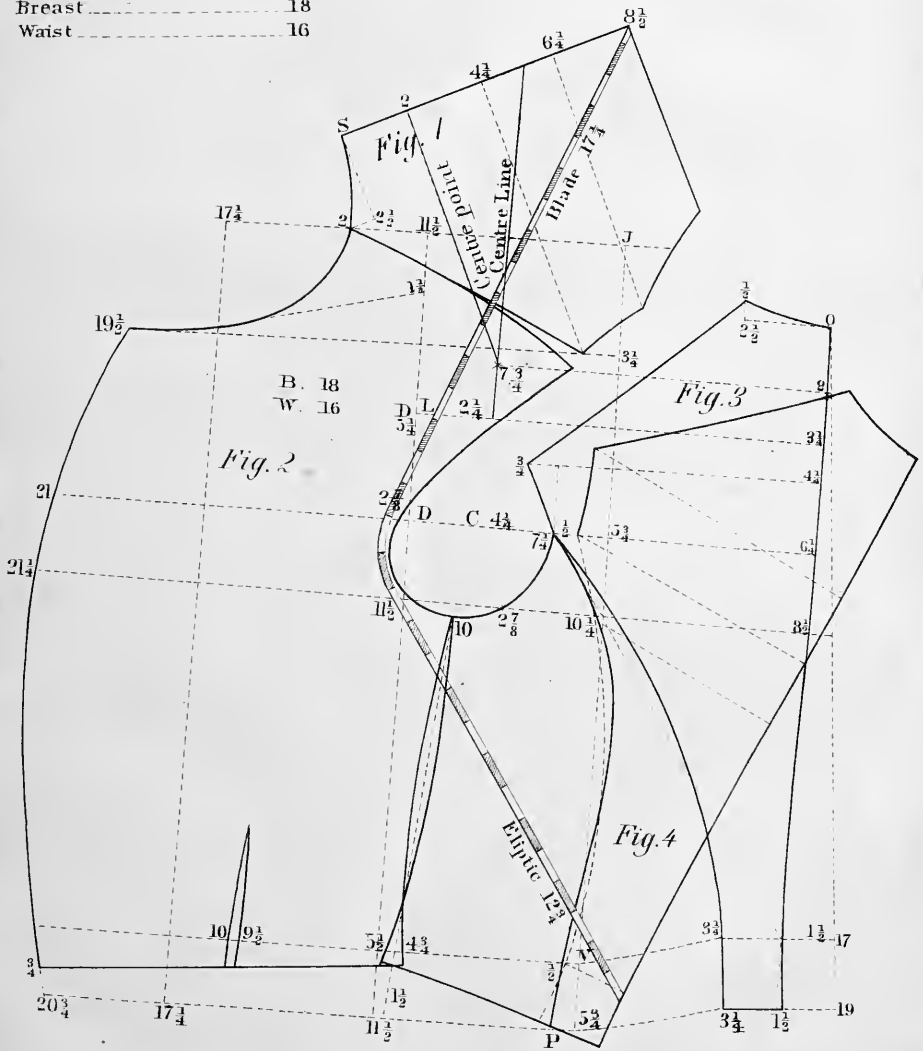



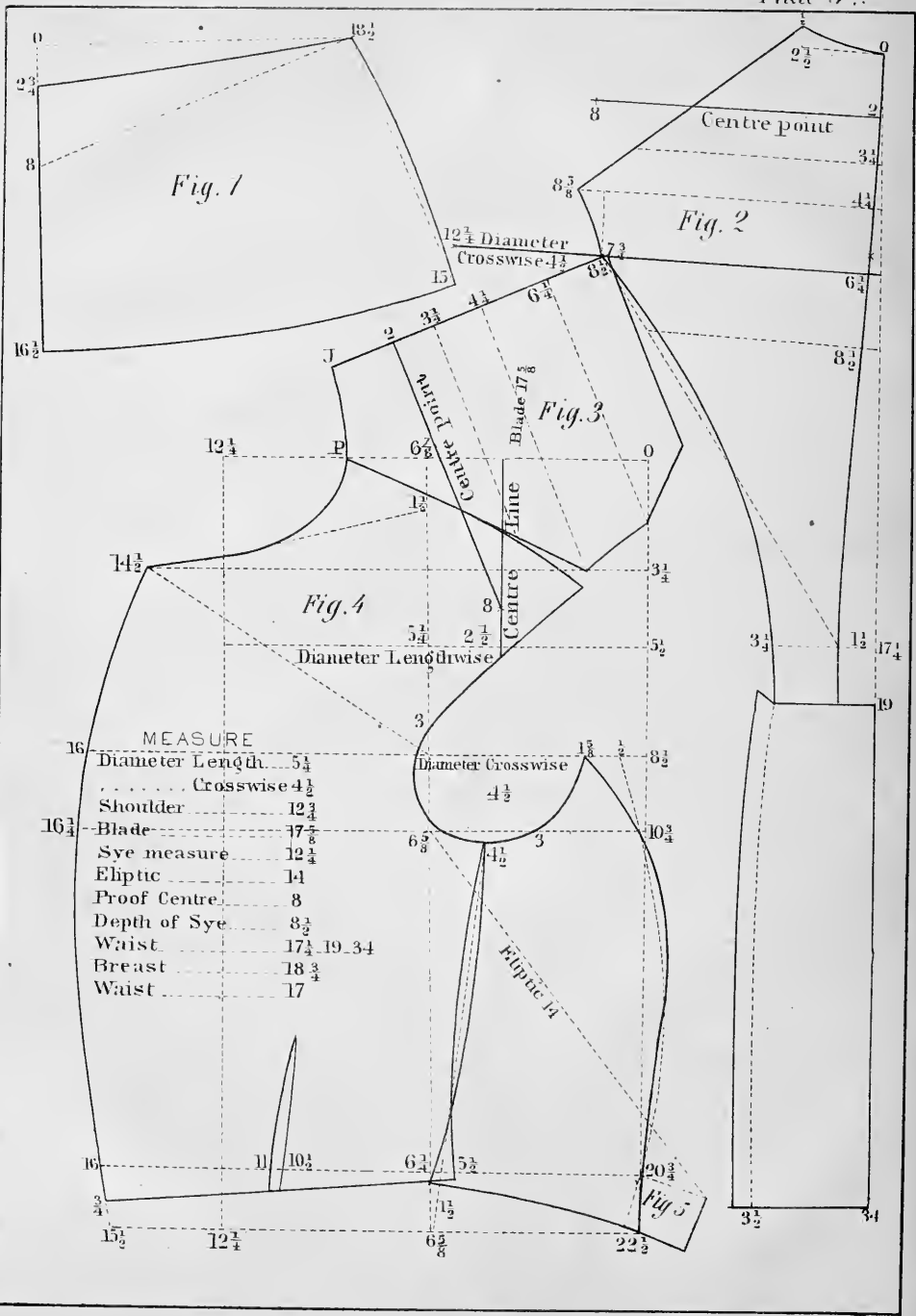

Fig. 1

Fig. 2

Fig. 3

Fig. 4

Fig. 5

MEASURE

Diameter Length	5 1/4
..... Crosswise	4 1/2
Shoulder	12 3/4
Blade	17 7/8
Sye measure	12 1/4
Eliptic	14
Proof Centre	8
Depth of Sye	8 1/2
Waist	17 1/4 19 3/4
Breast	18 3/4
Waist	17

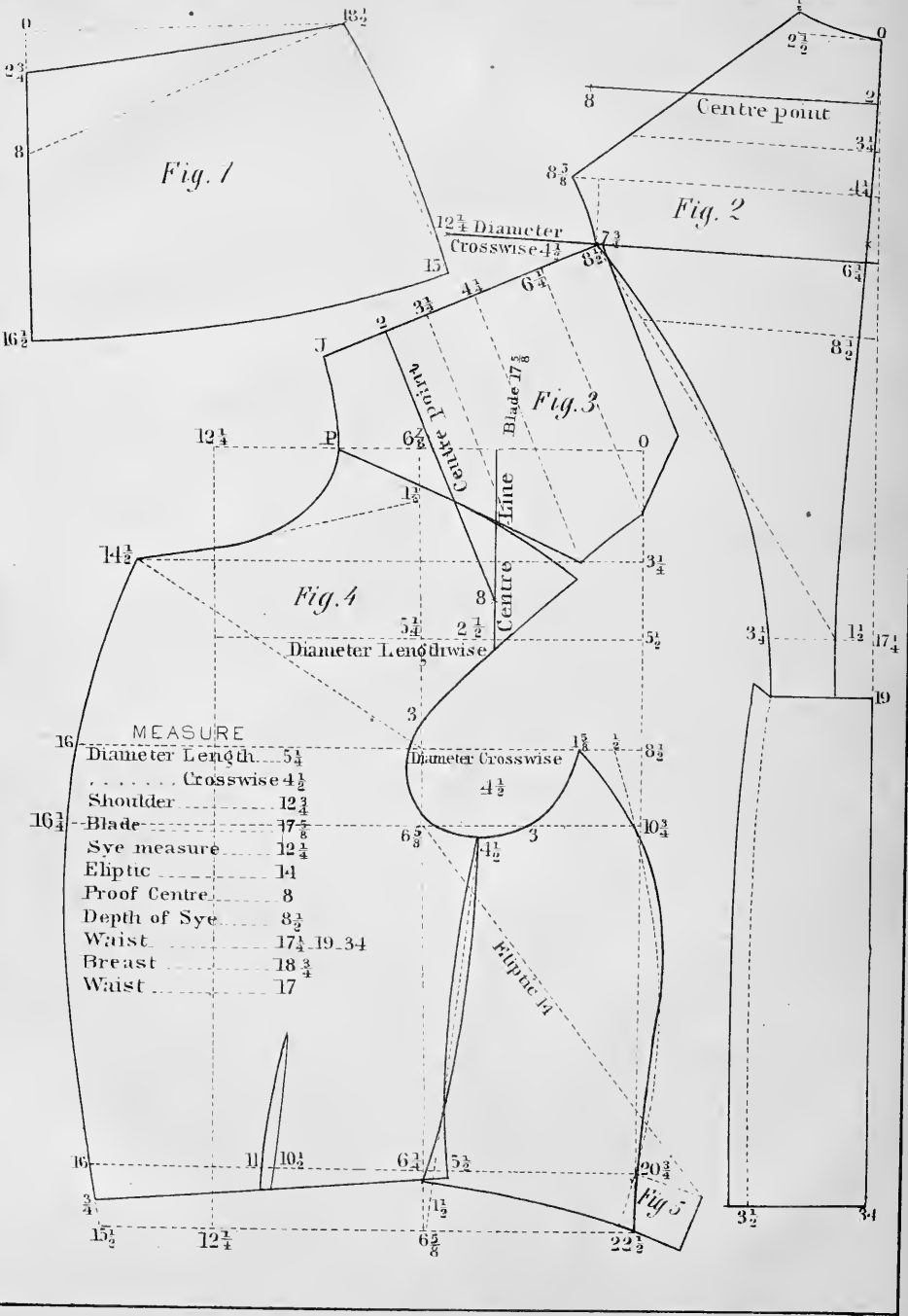

backseam, say $2\frac{1}{2}$ for top of back, and $10\frac{3}{4}$ would make $13\frac{1}{4}$, the shoulder measure being $12\frac{3}{4}$, and one half inch for making up, would amount to $13\frac{1}{4}$, or $10\frac{3}{4}$ to bottom of sye; then take your back, laying the bottom of sye of back on that of forepart backseam on construction line, and mark the line bottom of pitch by that of back, also the line diameter lengthwise; then run up the top of back to the top of forepart to 0, and mark the depth of shoulder at $3\frac{1}{4}$ by that of back; then square these lines across; and we will establish our widths by marking on top, from 0, the sye measure, or $12\frac{1}{4}$ inches (what we mean by the sye measure is the measure taken from front of sye, under arm, to centre of back); we will now divide the $12\frac{1}{4}$ in two parts, making $6\frac{1}{2}$ the half; we also add $\frac{1}{2}$ inch for seams, making $6\frac{3}{4}$, this being the part that front of sye comes to, the other half to $12\frac{1}{4}$ being only given to produce proportion in draughting, as, by casting a glance on the diagram in plate II., the sye measure is occupied by the back, in one part, and the other part with the $\frac{1}{2}$ inch is occupied with the diameter crosswise, which is deducted from the sye measure to $7\frac{3}{4}$, illustrated on Figure 2, and marked diameter crosswise. We will now proceed with Figure 4 by drawing a line from $12\frac{1}{4}$ to bottom, on the square, also the line from $6\frac{3}{4}$ front of sye. We will now come to the line of pitch, and mark from the line at front of sye our diameter crosswise $4\frac{1}{2}$, with $\frac{1}{2}$ inch added for seams, to $1\frac{3}{8}$, which is the top point of sideseam; we will then measure the length of our sideseam from this point by applying the sideseam of back down construction line, as to $20\frac{1}{4}$ and $22\frac{1}{2}$, then square these lines across. The length of sideseam can be also obtained in the manner shown on Figures 2 and 3, plate II. by sweeping from $3\frac{1}{4}$ to $\frac{1}{2}$ at natural waist by $7\frac{1}{4}$ at point of sideseam, and the bottom line in the same way; the point of

sideseam being established $1\frac{5}{8}$ inches in from construction line, we mark $\frac{1}{2}$ the distance to said line, for the purpose of forming sideseam, and we mark $\frac{1}{2}$ inch in at natural waist, as represented at V on plate II; we will then lay on back, as represented by Figure 5, dotted line, with the side touching at $\frac{1}{2}$ inch in at natural waist, and $\frac{1}{2}$ the distance from $1\frac{5}{8}$ at sidepoint; then apply your elliptic measure from $6\frac{5}{8}$, at the bottom of sye, to 14 at natural waist, and move sideseam in or out according to measure; then mark dotted line all the way by the side of back, and form the sideseam according to model. We will now mark from $6\frac{5}{8}$ at the bottom of sye $\frac{1}{4}$ the sye measure, being 3 inches each way along the bottom and front, as a guide for crossing lines in the forming of sye; we will also establish our centre line by marking $2\frac{1}{2}$ inches from front of sye on line diameter lengthwise, and is one-half the diameter crosswise, with the $\frac{1}{2}$ inch added for seams; then take your back and place the line proof-centre at 8 on centre line, with the top of back touching the line of forepart at P; the top of back pitch may also touch the line depth of shoulder on forepart, (see Figure 1); then apply your blade measure to $8\frac{1}{2}$, which is $17\frac{5}{8}$ inches, as represented on plate II.; this part of the coat being all on the bias, will stretch a little, $\frac{1}{4}$ of inch may be added for making up, and when the shoulder is raised with wadding, $\frac{1}{2}$ to $\frac{3}{4}$ of inch may be added according to the requirements of raising; the shoulder should be changed up or down at this point to correspond with the blade measure, if it is found necessary, then form shoulder by rounding it off $\frac{1}{2}$ inch from centre line to point of shoulder (see model); then form your sye by touching the 3 on front and bottom, and about $\frac{1}{4}$ of inch in front of line, and $\frac{3}{8}$ of inch each way in crossing around the bottom corner, and $\frac{1}{4}$ below the bottom line; lay on back

as Figure 5, and apply waist measure along the natural waist to the front at 16 or 17 inches; add $1\frac{1}{2}$ inches for making up, and form front of breast from $14\frac{1}{2}$ by 16, $16\frac{1}{2}$, $16\frac{3}{4}$ to $15\frac{1}{2}$ at bottom, and take out V of $\frac{1}{2}$ inch, unless in cases of large waists, when no V should be taken out, and no allowance given for making up, as it will always stretch sufficient for that purpose; in small waists the V should be enlarged in proportion, and not rounded off in front to its seeming requirement by the measure, which will prevent the breast from rising up in front when buttoned; apply $\frac{1}{2}$ breast measure from line in front of syc to 16 in front, and also to $14\frac{1}{2}$ at top, and form breast by those points; then draw line from $1\frac{1}{2}$ down from $6\frac{5}{8}$ to $14\frac{1}{2}$, and form neckgorge as model. Mark along the bottom from construction line $6\frac{5}{8}$ inches, and draw a line from bottom of syc to $6\frac{5}{8}$; mark up said line $1\frac{1}{2}$ from bottom, then up from $1\frac{1}{2}$, 2 inches, and place the natural waist in its proper place; then form bottom of sidebody by the $1\frac{1}{2}$, giving it a gentle curve, and form the front by drawing the line by $1\frac{1}{2}$ to $\frac{3}{4}$ up from bottom; then hollow the sidebody, as model, by crossing at the natural waist, and giving about $\frac{3}{8}$ of inch of spring on either side at bottom; take out V of $\frac{1}{2}$ inch from $10\frac{1}{2}$ to 11 when the arms are well forward, which indicates a narrow

chest; $\frac{1}{2}$ breast is too much to add in front at 16; in such cases apply your breast measure with your back in a joining position, as represented on Figures 2 and 3, plate II., with $\frac{1}{2}$ the breast measure added, or 3 graduated inches, which will regulate the front of breast. In establishing the front of syc the placing it forward $\frac{1}{2}$ inch for seams is merely accommodating as the measures work backwards from this part, and $\frac{1}{4}$ of inch added to diameter crosswise will generally be enough for making up.

HOW TO DRAUGHT SKIRT, FIGURE 1.— Draw construction line from 0 to 18, square in top; mark down construction line from 0, $2\frac{3}{4}$, $7\frac{3}{4}$; then apply measure from $2\frac{3}{4}$ to 18, applying exact measure of waist of forepart, with bottom of lapel included, and 1 inch added for fullness; then draw a line from $2\frac{3}{4}$ to 18, or waist of skirt; then draw spring of skirt by laying elbow of square at 18 with arm resting at $7\frac{3}{4}$; then form top of skirt by hollowing $\frac{1}{4}$ of an inch as model; then lay on sidebody in a joining position to skirt at 18, and form your spring of skirt to arrange with sideseam $3\frac{1}{2}$ inches up; mark length of skirt by that of back; form bottom of skirt to correspond with hollow at top, the front being half an inch shorter than behind.



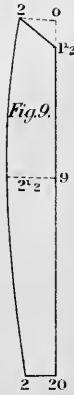
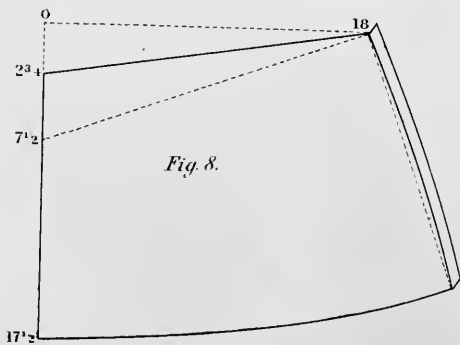
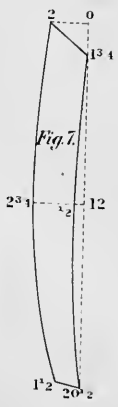
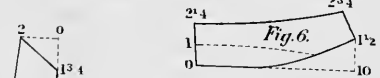
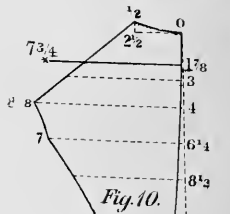
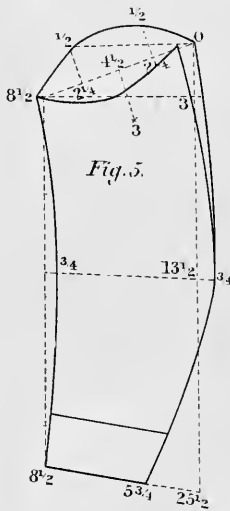
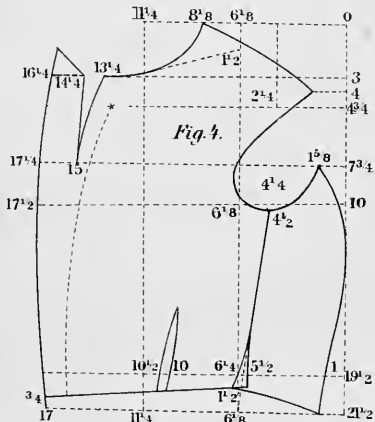
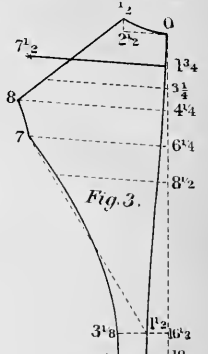
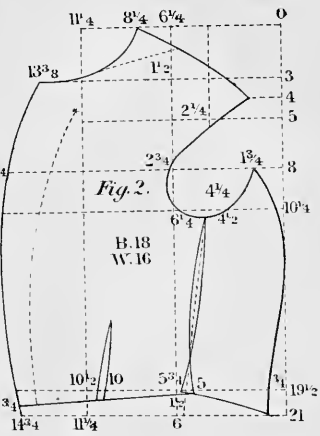
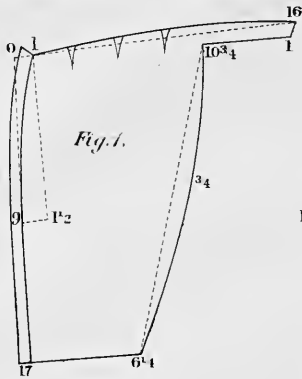

Description of Plate IV.

IN plate IV. we have two different styles of coats; the one a dress coat and the other a single-breasted frock.

As we have shown in our measurement the manner of taking the measure without the use of the measuring square, the reader can use either the common square or inch tape, as he pleases, according to instructions on measurement. We now propose showing the way to draught the dress coat by the measure taken without the square, on general principles not to be applied to this coat exclusively, but for the use of whom it may concern. The following is the measure: diameter crosswise, $4\frac{1}{2}$; lengthwise, $5\frac{1}{2}$; shoulder measure, $12\frac{1}{4}$; blade, 17; syc measure, $11\frac{1}{4}$; elliptic, $12\frac{1}{2}$; depth of syc, $8\frac{1}{2}$; length of natural waist, $16\frac{1}{2}$; full length, 18; skirt, 34; breast, 18; waist, 16. By a reference to the plan of measurement it will be seen that you have got all the essential measures for cutting your coat, length behind and front, the blade and elliptic measures, and also the widths, the most essential of which is the measure from front of syc to centre of back, which we call the syc measure, $11\frac{1}{4}$ inches; we will now divide the syc measure into its appropriate parts, so that the reader may understand what he is doing: the width of back at bottom of pitch is half the syc measure and one-eighth, say $5\frac{5}{8}$ and $1\frac{3}{8}$ or 7 inches; and in establishing the front of syc from 0 at construction line to $6\frac{1}{4}$ is half the syc measure and half inch for making up, and the diameter of syc from $9\frac{1}{4}$ to $1\frac{3}{8}$ is $4\frac{1}{2}$,

with $\frac{1}{4}$ added for seams making $4\frac{1}{2}$. added to the 7, width of back, make $11\frac{1}{2}$ inches thus allowing $\frac{1}{4}$ inch for making up, which goes to the diameter of syc.

HOW TO DRAUGHT BACK, FIGURE 3.—

Draw construction line from 0 to 34; then select your scale corresponding with the breast measure, then mark inside at natural waist $1\frac{1}{2}$ inches: then draw the back line from 0 by said $1\frac{1}{2}$ inches; then mark down from 0 on back line, $8\frac{1}{2}$ inches by square, natural waist, $16\frac{1}{2}$; full length, 18; the lines of pitch, $4\frac{1}{4}$ and $6\frac{1}{4}$ by the scale, and square those lines which form the pitch, by the back line, and also the line at top from 0 to $2\frac{1}{2}$. Square in waist lines by construction line; then take scale and mark on top from 0 $2\frac{1}{2}$ with $\frac{1}{2}$ up for spring, top of pitch 8, bottom 7; at natural waist $3\frac{1}{2}$, at bottom $3\frac{1}{2}$; draw a straight line from 7 to $1\frac{1}{2}$ at natural waist, and form back by those points indicated and according to model.

HOW TO DRAUGHT FOREPART, FIGURE 2.

—Draw construction line from 0 to 21, and square in top; then mark down your shoulder measure, which was $12\frac{1}{4}$, from 0 at top to $10\frac{1}{4}$ at bottom of syc, which being added to the $2\frac{1}{2}$ on top of back will make $12\frac{3}{4}$, thus allowing half an inch for seams; then take your scale corresponding with the breast measure, and mark down from 0 to 3 or depth of shoulder to point of shoulder 3, 4; then 8 or $2\frac{1}{4}$ inches up

from $10\frac{1}{4}$, same as back, and $19\frac{1}{2}$ and 21^* or full length; then square those lines across from construction line; then mark on top line $6\frac{1}{4}$ and $8\frac{1}{4}$, or 2 graduated inches in all cases in front of syc line, on line, depth of shoulder at front $13\frac{3}{8}$ on line of pitch from 8, $1\frac{3}{4}$, $2\frac{3}{4}$, $15\frac{1}{4}$, on line $10\frac{1}{4}$, or bottom of syc, $4\frac{1}{2}$, $6\frac{1}{4}$, $15\frac{1}{2}$, on line $19\frac{1}{2}$ or natural waist $\frac{3}{4}$, 5, $5\frac{3}{4}$, 10, $10\frac{1}{2}$; then mark on bottom line 6, $11\frac{1}{4}$, $14\frac{3}{4}$, $\frac{3}{4}$ the distance from $1\frac{3}{4}$, which is point of sideseam, and bottom of back pitch to 21 is length of sideseam, and should be carefully measured by the side of back; then lay your back on in a joining position, with $3\frac{1}{4}$ at natural waist of back, resting on $\frac{3}{4}$ of forepart, with 7 of back resting half way between 8 and $1\frac{3}{4}$ at top of sideseam; then apply your elliptic measure, with the inch tape, from $6\frac{1}{4}$ to $1\frac{1}{2}$ on back, and move it in or out to correspond with the elliptic measure; then form your sideseam as model. Then lay your top of back at $\frac{1}{2}$, resting on shoulder of forepart at $8\frac{1}{4}$, which should be two inches in front of line of syc, and let the point of back 8 rest half an inch above the line running from 4 on line of shoulder. Then apply your blade measure, which is 17, and change the point to conform with this measure. The proof measure from socket bone to the same place, may be applied here as a corrective, and then round your shoulder to correspond to the line; then mark $2\frac{3}{4}$ inches up the line from $6\frac{1}{4}$ at bottom of syc, and $2\frac{3}{4}$ outside along the bottom; then form your syc from point of shoulder, crossing the line at $2\frac{3}{4}$, and about $\frac{2}{3}$ of an inch inside, at bottom corner, crossing at $2\frac{3}{4}$ again to $1\frac{3}{4}$. Then mark down from $6\frac{1}{4}$, $1\frac{1}{2}$ inches, and from front of syc to $15\frac{1}{4}$ inches, half the breast measure, then sweep from $15\frac{1}{4}$ to $13\frac{3}{8}$, by front of syc; draw line from $1\frac{1}{2}$ to $13\frac{3}{8}$, and form neck gorge as model; then apply waist measure along natural waist, back included, which will make $16\frac{1}{2}$, allowing $1\frac{1}{2}$ inches for V and making up.

Then draw line from $4\frac{1}{2}$ under arm to 6 at bottom; mark up from 6, $1\frac{1}{2}$ inches; mark up from $14\frac{3}{4}$, $\frac{3}{4}$ of an inch, and form spring of side body and bottom as model. Then form round of breast from $13\frac{3}{8}$ by $15\frac{1}{4}$, $15\frac{1}{2}$, $14\frac{3}{4}$, at bottom. Take out V from 10 to $10\frac{1}{2}$, and form waist as model, which completes the forepart.

HOW TO DRAUGHT DRESS COAT SKIRT,
FIGURE 1.—Draw construction line from 0 to 17, mark down from 0, 9 graduated inches, square it out to $1\frac{1}{2}$, mark inside from 0 at top 1, then place elbow of square on at 1, with arm touching at $1\frac{1}{2}$, and draw hair line of top to 16, mark width of top of skirt $10\frac{3}{4}$, and bottom $6\frac{1}{4}$, draw line from $10\frac{3}{4}$ to $6\frac{1}{4}$, and give it a curve of about $\frac{3}{4}$ at centre, make the width of step 1 inch, and curve the top as model and the skirt at plait, from 1 to 9. Figures 6 and 7 is the lapel and collar adapted to this coat, and are drafted by the scale from the line of construction.

Figures 4, 5, 6, 8, 9, 10, are the diagrams of a single-breasted frock coat, and is drafted to the same measure as that of the dress coat, and the same sleeves and collar being adapted to either coat, and with the lapel. Figure 9 is adapted to frock coat on plate III. This coat is draughted in the same way as double-breasted frock coat, represented on plate III, with the exceptions of the measure being different, and the latter being single-breasted, and which we will now proceed to describe the difference in draughting the forepart, Figure 4, from that of the double-breast, and as the difference chiefly consists in the lapel growing, too, our remarks will, therefore, be mostly confined to that point. In applying the breast measure to the front of breast to where the lapel is added, it should have a reduction of $\frac{1}{2}$ inch less than double-breast to lapel, and then add $2\frac{1}{4}$ inches for lapel, or more or less according to fashion; an addition is made at waist,

including the addition allowed for V, of $1\frac{3}{4}$ inches. As the same skirt is adapted to either the single or double-breast, with the exception that it would require to be shortened one inch for single-breast, for further explanation, see Figure 1, plate 3rd.

HOW TO DRAUGHT SLEEVE, FIGURE 5.— Draw construction line from 0 to $25\frac{1}{2}$, square in top, the width of back at pitch being 7, lay 7 on at 0, and mark distance to elbow at $13\frac{1}{2}$ or $20\frac{1}{2}$ inches, the measure being 20, and $\frac{1}{2}$ inch for seams, and full length to $25\frac{1}{2}$, making $32\frac{1}{2}$, the $\frac{1}{2}$ inch being for seams. The distance from 0 to 3 on sleeve is same as from 8 to $10\frac{1}{4}$ on forepart, with $\frac{1}{2}$ the distance from 7 to 8 on back, amounting to $3\frac{1}{4}$, we have placed it at 3, which it would be when joined, or in other words, the same distance from middle of back pitch, where the back arm seam of sleeve joins to bottom of sye at $10\frac{1}{4}$, then square those lines across, then measure around the sye of your forepart back pitch,

included, say $16\frac{1}{2}$, and mark the $\frac{1}{2}$ to $8\frac{1}{2}$, we have given it $\frac{1}{4}$ of inch more for forming at forearm, then draw line on the square or forearm, from $8\frac{1}{2}$ to $8\frac{1}{2}$ at bottom, then draw line from 0 to $8\frac{1}{2}$, say 9 inches, the half of which is $4\frac{1}{2}$ as marked, then draw the line from $4\frac{1}{2}$ to 3, which is one-third the distance from 0 to $8\frac{1}{2}$, then divide the distance from $4\frac{1}{2}$ to 0 and $8\frac{1}{2}$ respectively, which is $2\frac{1}{2}$, and square up the lines to $\frac{1}{2}$ which is also $2\frac{1}{2}$, then sweep from 0 to $8\frac{1}{2}$ by $\frac{1}{2}-\frac{1}{2}$, and straighten curve a little in front, then sweep from $25\frac{1}{2}$ to $8\frac{1}{2}$ by 0, lay elbow of square on at elbow, or $13\frac{1}{2}$, with arm $\frac{1}{2}$ inch inside from $25\frac{1}{2}$, and draw line to $\frac{3}{4}$, then mark width of bottom from $8\frac{1}{2}$ to $5\frac{3}{4}$, form forearm from $8\frac{1}{2}$ to $8\frac{1}{2}$ by $\frac{3}{4}$, mark outside from $13\frac{1}{2}-\frac{3}{4}$, and finish upper side as model, from 0 by $\frac{3}{4}$ to $5\frac{3}{4}$; mark your underside from $8\frac{1}{2}$ to 1 inch inside from 0, or $\frac{1}{2}$ the measure of sye, and form underside as model. The principle of draughting this sleeve is applicable to any of the coats.

Description of Plate V.

ON plate V, we have three different styles of coats represented, all of which are very fashionable at the present time, the measures are nearly the same, with the exception of the length of waist and skirt, the back, Figure 3, is suited to the forepart, Figures 5 and 8, which represent a single and double-breasted walking coat with pointed lapel, the skirts 2 and 4, are either of them adapted to forepart, Figure 8; only the skirt 4 would require an additional length of 1 inch to suit the back; on Figure 1 and 9 are the diagrams of a walking coat of the open V form of breast, the step at front being gently curved, the bottom of skirt is square, but should also be curved when the step at front of collar is; these coats are all laid down with the numbers affixed, so that they may be drafted with the scale for cutting patterns as well as by the application of the system through the measures. As we have already shown the way of drafting by the measures, on plate II and III, it will not be necessary to go through the same routine again, but simply to confine our explanations to those points of the diagrams which represent the different points of style on each, peculiar to each garment different from those we have already described.

We will now give the measure of Figures 1 and 9; diameter, crosswise, $4\frac{1}{4}$; lengthwise, $5\frac{1}{4}$; shoulder, $12\frac{1}{2}$; blade, 17; in Figure 5 it is also 17; in Figure 8 it is $17\frac{1}{4}$; sye measure, $11\frac{1}{2}$; cleptic, $12\frac{1}{2}$; in Figures 5 and 8, $12\frac{1}{4}$; depth of sye on

back, $8\frac{1}{2}$; natural waist, $16\frac{1}{2}$ – $18\frac{1}{2}$; length of skirt 32; in Figure 5 and 8 the length of waist is at 17–19, and skirt 33, the proof centre on Figure 3 is $2-7\frac{3}{4}$, and on Figure 9 $1\frac{7}{8}$ – $7\frac{3}{4}$; breast 18, waist 16. We would here remark that it is not necessary that the proof centre should be left growing outside of shoulders, as represented on diagram in cutting pattern, as when the back at this point is laid on. For forming shoulders, the edge of square may be used in connection with the line to $7\frac{3}{4}$, or whatever it may be, the diameter crosswise is $4\frac{1}{4}$, but $\frac{1}{4}$ of an inch should be added for making up, and $\frac{1}{2}$ that amount added to centre line at $2\frac{1}{4}$, or half diameter crosswise; the line marked $6\frac{1}{4}$ at front of sye is half sye measure, with $\frac{1}{2}$ inch in front for seams; to $11\frac{1}{2}$ is full sye measure, the point of shoulders at $8\frac{1}{2}$ is 2 inches in front of sye, and where the proof centre at $7\frac{3}{4}$ touching centre line places it at this point; the amount given in front of breast in coats of this kind are in most cases regulated by fashion, and according to the size of the ball of breast, in this diagram we put it at 2 inches more than half the breast measure from line front of sye, or 11 inches, making $17\frac{1}{2}$; we then sweep from $17\frac{1}{4}$ to $15\frac{1}{2}$ at top, and then form the bottom part according to fashion, and the requirements of the customer, whether it should be well slanted off or moderately so, the bottom is at 17 and would button on a man $15\frac{1}{2}$ at waist. On Figure 5 the sye measure is the same, but the point of shoulder is $\frac{1}{4}$ of inch fur-

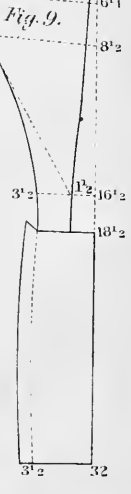
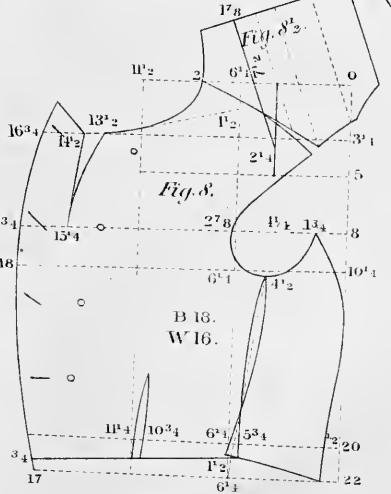
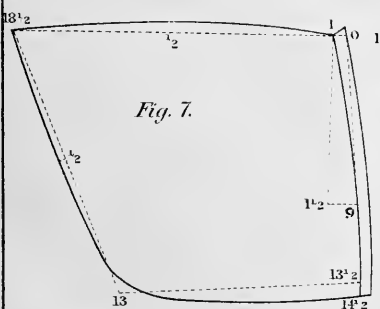
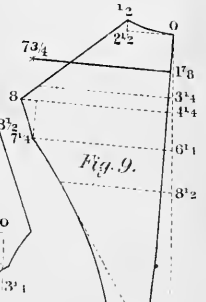
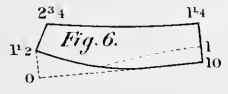
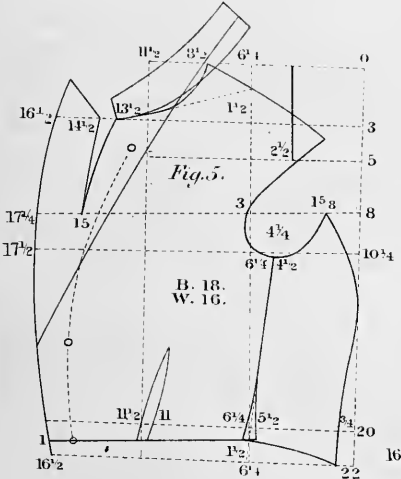
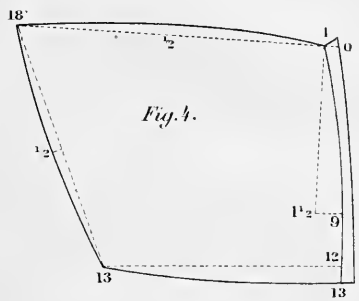
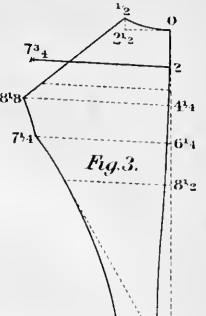
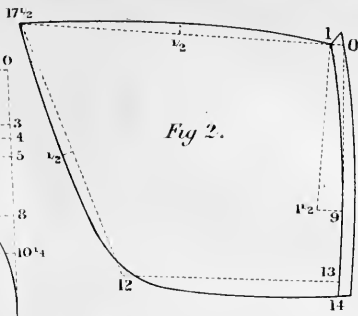
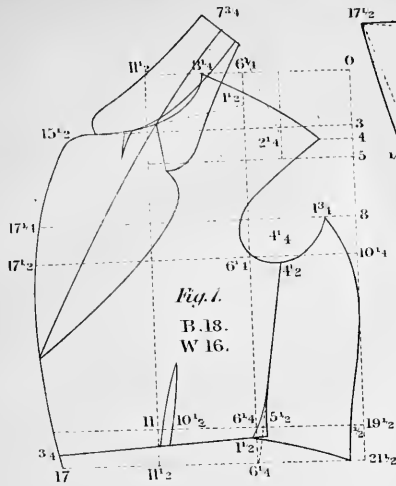

ther forward, being placed at $8\frac{1}{2}$; this forepart is single breasted, and of the pointed lapel form; in front of breast we give it $\frac{1}{2}$ breast less, $\frac{1}{2}$ inch from line front of sye to 15, and $2\frac{1}{4}$ inches more for width of lapel; sweep from 15 to $13\frac{1}{2}$, take out fish of one inch to $14\frac{1}{2}$, give the lapel 2 inches width at top, and form your lapel and front according to model. Skirt, Figure 7, is well adapted to this forepart, and may be made square at bottom if required.

On Figure 8 we have represented a very elegant style of double-breasted walking coat. It has the back in a joining position at shoulder, showing the establishment of point of shoulder by the proofcentre, touching centre point $7\frac{3}{4}$, at centre line $2\frac{1}{4}$; the

points of this forepart are in most respects like that of the other, the point of shoulder is $\frac{1}{4}$ of inch further back, being at $8\frac{1}{4}$, or 2 inches in front of sye; in front of breast to lapel in double-breasted coats we give $\frac{1}{2}$ breast, (subject to contingencies referred to in the explanations to froek coat,) as to $15\frac{1}{4}$ or 9 inches, and width of lapel at this part $2\frac{1}{2}$ inches, and at top $2\frac{1}{4}$, at bottom 17; take out the fish according to model, and form the front by those points indicated.

The collar, Figure 6, is adapted to either of these coats; it is drafted by the scale. The roll of breast of coats can be made to roll more or less in conformity with the sewing, too, part of front of collar being well rounded or otherwise.

Description of Plate VI.

ON Figures 1 and 7, we have a very neat style of coat or jacket, of the register form; this coat is admirably adapted for summer goods and for summer wear, being well rounded off, and stylish in its general appearance. It is drafted to the following measure: diameter, crosswise, $4\frac{1}{4}$; lengthwise, $5\frac{1}{2}$; shoulder measure, $12\frac{1}{4}$; blade, $17\frac{1}{4}$; sye measure, $11\frac{3}{4}$; elliptic, $12\frac{3}{4}$; proof centre, $7\frac{3}{4}$, and $1\frac{1}{4}$; depth of sye, $8\frac{3}{4}$; natural waist, $16\frac{3}{4}$ – $18\frac{3}{4}$; length of skirt, 31; breast 18; waist 16. The difference in the back of this coat from those I have been explaining, consists in the back being a little longer from bottom of sye up, and hence better adapted to a man slightly stooping, the pitch also in both width and breadth is $\frac{1}{4}$ of inch larger, the waist longer, and the skirt shorter. In the forepart the top of back is laid on with the proof centre, to establish the point of shoulders which is at $8\frac{1}{4}$, the sye measure $11\frac{3}{4}$; on front of breast of this coat there is only half breast, and $1\frac{3}{4}$ given, or 17 inches and $17\frac{1}{4}$ at bottom of sye, and at front of waist the skirt is well slanted and rounded off at bottom. In cutting the pattern for this coat, either the sidebody or skirt would have to be pieced out, and care should be taken in doing so to give it its proper form; the top of skirt with flap, is cut straight across, ranging with the waist lines; the skirt should be cut to plait, so as to allow of $\frac{1}{2}$ inch fullness; it is thrown out $\frac{2}{2}$ inches outside of construction line at bottom, but the spring of skirt should be

ranged by laying on the bottom of sidebody in a joining position to that of top of skirt, and ranging the spring of skirt with that of sidebody from about 3 inches up. Much care should be taken in joining the sidebody, too, at this point, so as not to contract it in any particular, and the lining should be held full over sidebody, but particularly at the waist.

On Figures 2, 3 and 4, we give the diagrams of an English style of jacket, but to the great points of style of this coat or jacket, New York might lay special claims.

This jacket is cut a good length at waist, but not to the extreme that some have been cut; it is $3\frac{1}{2}$ inches below natural waist, and 3 in width at this part, the full length being 17 and $20\frac{1}{2}$, and $30\frac{1}{2}$ respectively; the back from natural waist to the full length should be gently hollowed to range nearly straight with construction line; a very little spring should also be given to side seam below natural waist. These garments being generally cut loose and graceful, we give $\frac{1}{4}$ of inch more to width of back pitch, and deduct the same off point of side seam marked $1\frac{3}{4}$, and allowing only $\frac{1}{4}$ of inch over diameter crosswise for seams; the collar of these jackets may be cut to roll them down to the natural waist, or given a short roll, according to the round of stand up of collar. In long waists the spring of sidebody should be gently hollowed, and made nearly to arrange with the construction line; the spring under arm, after crossing natural waist,

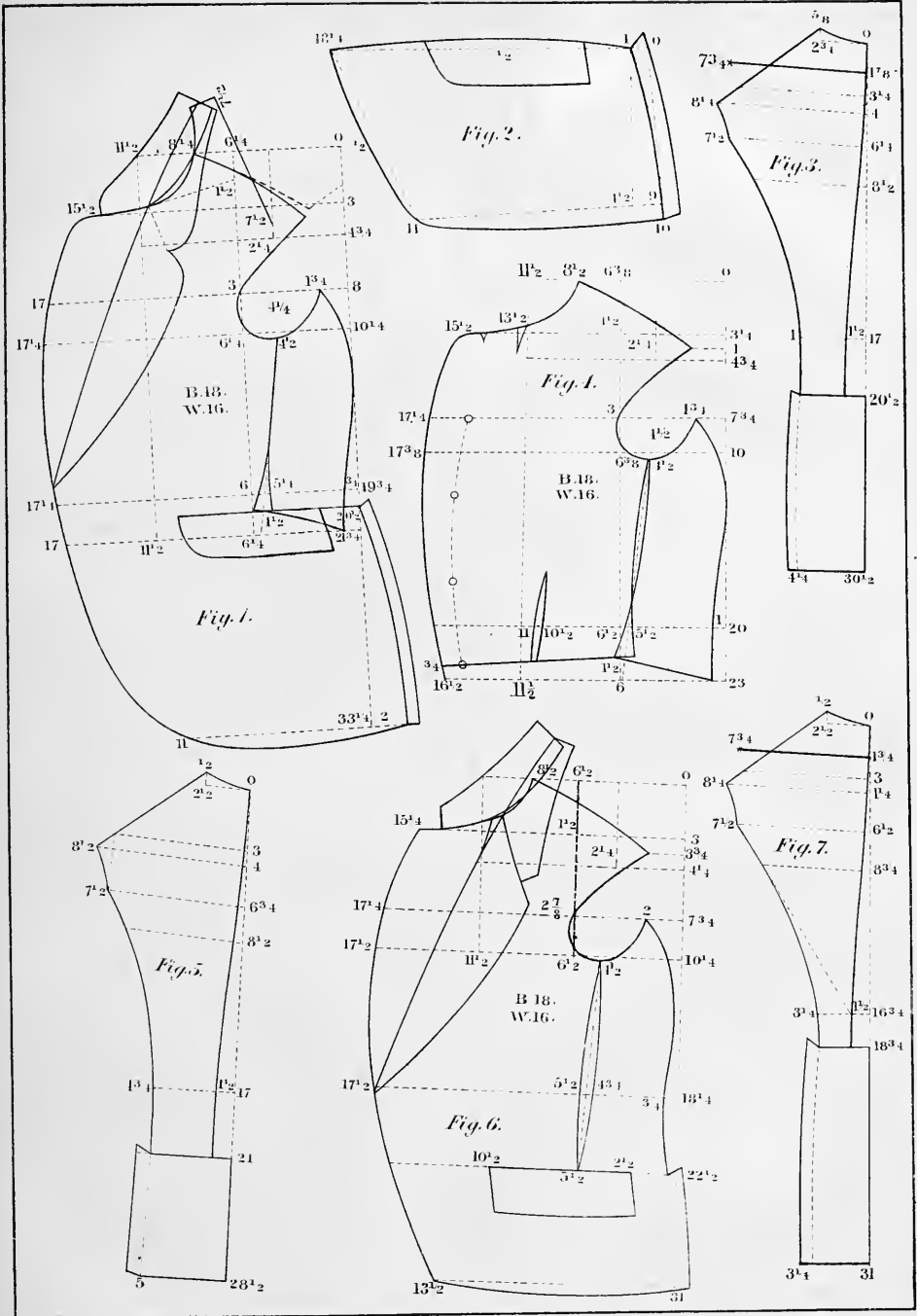



should take its regular range of spring in proportion to the length of waist ; the side-body should be cut $\frac{1}{4}$ of inch short, or $\frac{3}{8}$, and stretched from one inch above natural waist to the bottom, and care should be taken to have the linings put in full, both in length and breadth, over sidebody, particularly below the natural waist, as tight linings would destroy the whole effect of the spring. As these jackets are cut to hang flat in the short skirt, the spring of skirt is put at $1\frac{1}{2}$ inches. The points of construction of this coat are so nearly the same as the previous one, with the exception of the length of waist and a wider roll of breast, that further comments will be deemed unnecessary.

Figures 5 and 6 are the diagrams of a New York jacket ; as this jacket is of the sack species, although laid out on the frock principle, we will show the manner of drafting it by the measures. The following is the measure : diameter crosswise, $4\frac{1}{2}$; lengthwise, $5\frac{1}{2}$; shoulder measure, $12\frac{1}{4}$; blade, 17 ; sye measure, $11\frac{3}{4}$; elliptic, 13 ; depth of sye on back, $8\frac{1}{2}$; natural waist, 17 ; full length, 21 ; skirt, $28\frac{1}{2}$.

HOW TO DRAFT BACK, FIGURE 5.—Draw construction line from 0 to $28\frac{1}{2}$, mark inside from construction line at natural waist $1\frac{1}{2}$ inches, draw back line from 0 by $1\frac{1}{2}$, square in top ; then mark depth of sye on back $8\frac{1}{2}$, and natural waist 17, full length 21, lay on elbow of square at 3 and mark diameter lengthwise by 3, then mark up from $8\frac{1}{2}$ — $1\frac{3}{4}$ to $6\frac{3}{4}$, or $\frac{1}{2}$ inch less than coats cut through the waist, (as we give $\frac{3}{4}$ of inch more length in coats of this kind than those which are cut through the waist, we place $\frac{1}{2}$ inch of the extra material at bottom of back pitch as at $6\frac{3}{4}$, and the other $\frac{1}{4}$ at the top of sideseam at 2, which is placed $\frac{1}{4}$ of inch higher, and $\frac{1}{2}$ inch further in ; this is necessary to provide for the fact that when the fish under arm is taken out and

the pieces joined together, it will throw out the sideseam $\frac{1}{2}$ inch, and draw it down from top, to nearly the same amount, and hence we divide the extra material as we have herein described.) Then mark the line of shoulder at 4, so as to produce square shoulders, square these lines across the upper lines by back line, and the waist lines by construction line, then lay on your sye measure $11\frac{3}{4}$, on line bottom of pitch ; deduct your diameter crosswise, $4\frac{1}{2}$ off, leaving $7\frac{1}{4}$, the $\frac{1}{4}$ of inch for making up. We add to back in this kind of coat, making it $7\frac{1}{2}$, then add 1 inch extra to top of pitch to $8\frac{1}{2}$, mark on top $2\frac{1}{2}$, and then up for spring $\frac{1}{2}$, mark width of back at natural waist $3\frac{1}{4}$ to $4\frac{3}{4}$, and at bottom 5, form back from 0 to $\frac{1}{2}$, shoulder from $\frac{1}{2}$ to $8\frac{1}{2}$, pitch from $8\frac{1}{2}$ to $7\frac{1}{2}$, side from $7\frac{1}{2}$ by $4\frac{3}{4}$, skirt as model ; the back below natural waist should have a gentle curve, as represented.

HOW TO DRAUGHT FOREPART, FIGURE 6.
—Draw construction line from 0 to 31, then mark down from 0 your shoulder measure $10\frac{1}{4}$, to bottom of sye with width of top of back, $2\frac{1}{2}$ included, making $12\frac{3}{4}$, thus allowing $\frac{1}{2}$ inch for making up, then mark your diameter lengthwise, at $4\frac{3}{4}$, by back from bottom of sye, and depth of shoulder at 3, also by back, mark up from $10\frac{1}{4}$ to $7\frac{3}{4}$ at top of sidebody, $\frac{1}{2}$ inch higher, as we have already described on back ; $3\frac{3}{4}$ is the point where the blade measure places the point of shoulder, then square these lines across, mark on top from 0 your sye measure $11\frac{1}{2}$ inches, but these jackets being made of rough coating and should be cut easy, we have placed it at $11\frac{3}{4}$, then divide the sye measure with $\frac{1}{2}$ inch in front for seams, to $6\frac{1}{2}$, and draw these lines down to bottom of sye, then mark on line of pitch from front of sye, your diameter crosswise. No allowance is given, it being given on the back ; then mark the length of your sideseam by back from 2 to natural waist,

and full length to $22\frac{1}{2}$, square these lines across. It is very difficult to take an elliptic measure correctly in coats of this kind, but the sideseam should seldom come inside of construction line at bottom. The following is a good plan; draw the line front of sye down to flap head, and take a measure over the loins, and apply one half the measure, as from $6\frac{1}{4}$, with width of back included, with $\frac{1}{2}$ inch added for seams, then lay on your back to form shoulder, centre point at $7\frac{3}{4}$, touching centre line, and point $8\frac{1}{2}$ at the same time; apply blade measure and form shoulder to conform with this measure, then lay your back on the bottom of pitch, resting $\frac{3}{4}$ of inch outside from 2,

and $4\frac{3}{4}$ of back resting at $\frac{3}{4}$ of forepart, trace a line along the side of back, and form your sideseam as model, turning it into a hollow at natural waist, and bottom of skirt as model; then form your sye from point of shoulder to point of sideseam, in accordance with the principle laid down in frock, crossing the line $2\frac{7}{8}$ inches each way from $6\frac{1}{2}$, and inside from corner, $\frac{3}{8}$, mark in front of sye $\frac{1}{2}$ breast, with $1\frac{3}{4}$ or 2 inches added to $17\frac{1}{4}$, and sweep by front of sye from $17\frac{1}{4}$ to $15\frac{1}{4}$, and form neck-gorge from $8\frac{1}{2}$ to $15\frac{1}{4}$, and front from $15\frac{1}{4}$ by $17\frac{1}{4}$ - $17\frac{1}{2}$ - $17\frac{1}{2}$ - $13\frac{1}{2}$, and bottom from $13\frac{1}{2}$ to 31, take out fish under arm, and V at neck-gorge and finish forepart.

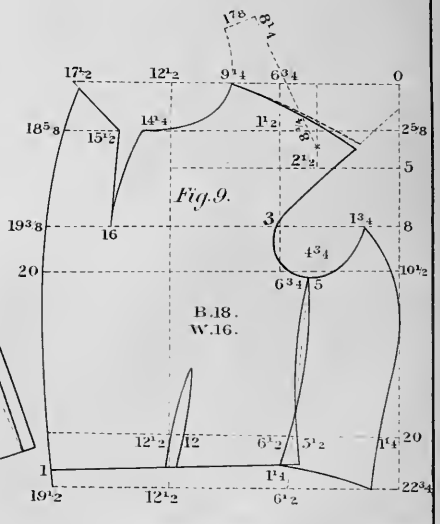
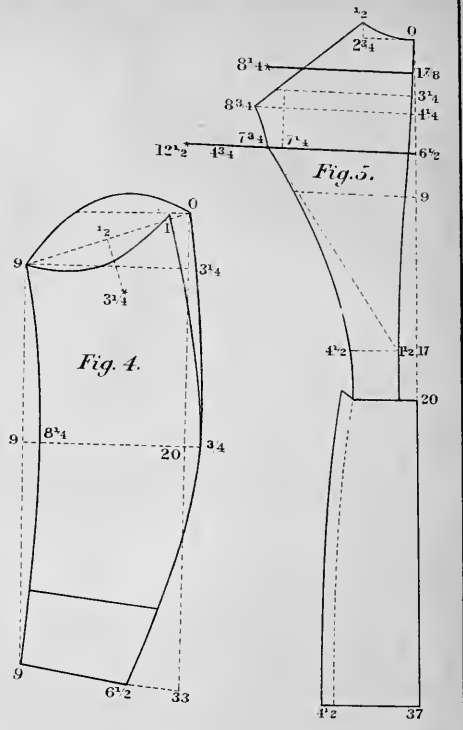
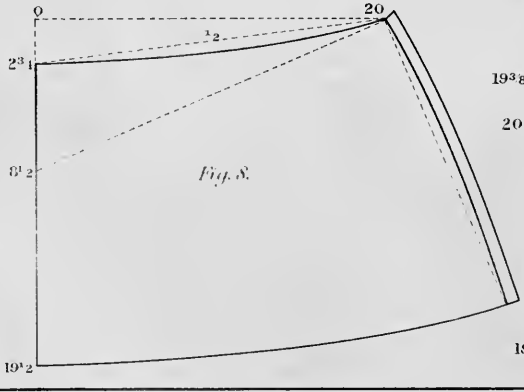
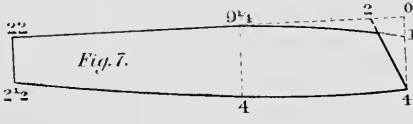
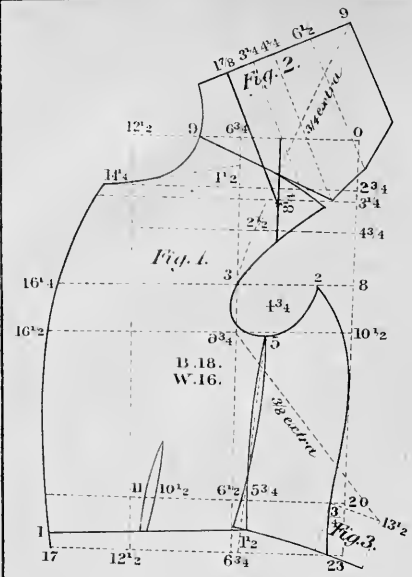

Description of Plate VII.

AS this plate is exclusively devoted to surtout overcoats, and as the measure and manner of drafting is the same as frock coat, we shall confine our explanation to the extra allowance given to the measures in drafting these styles of garments, and in order to do so we will first give the measures and the allowances, and then show their application. .

Diameter lengthwise, $5\frac{1}{4}$, $\frac{1}{2}$ inch added, $5\frac{3}{4}$; crosswise, $4\frac{1}{4}$, $\frac{1}{2}$ added, $4\frac{3}{4}$; shoulder measure, $12\frac{1}{4}$, 1 added, $13\frac{1}{4}$; blade $17\frac{3}{4}$ added, $17\frac{3}{4}$; sye measure, $11\frac{1}{2}$, 1 added, $12\frac{1}{2}$; elliptic, $13\frac{1}{4}$, $\frac{1}{4}$ added, $13\frac{1}{2}$; depth of sye on back, $8\frac{1}{2}$, $\frac{1}{2}$ inch added, 9, the $\frac{1}{2}$ inch to be given in diameter lengthwise; proof centre remains the same; centre point has $\frac{1}{2}$ inch added; natural waist remains the same, full length likewise, front of breast is $\frac{1}{2}$ breast measure, the breast has thus 1 inch added in the above measure, the waist should have 1 inch for overcoat and $1\frac{1}{2}$ for linings, if wadded; the sleeve should be cut to the measure.

Description of back, Figure 1: From 0 on top to bottom of sye has $\frac{1}{2}$ inch added, making 9, and the $\frac{1}{2}$ inch is all given in the diameter, making $5\frac{3}{4}$, the depth of shoulder remaining the same as inside coat; on bottom of pitch the sye measure has 1 inch added, making $12\frac{1}{2}$, one half being added to diameter crosswise, and the other to width of back. In sacks that are required very loose we add $\frac{1}{4}$ to width of back at pitch; the width of back at natural waist is about 3, or according to fashion.

We will now describe forepart, Figure 6. It will be perceived by looking at bottom of sye on forepart and width of top of back that the $\frac{1}{2}$ inch has been added to shoulder measure, with $\frac{1}{2}$ inch for making up, thus making $13\frac{1}{4}$ inches, also the 1 is added to the sye measure, making $12\frac{1}{2}$, and that the $12\frac{1}{2}$ is divided, with $\frac{1}{2}$ inch thrown to front, at $6\frac{3}{4}$ for seams, and also the diameter crosswise with the $\frac{1}{2}$ inch added, making in all $4\frac{3}{4}$, establishes the point of sideseam at 2, the sideseam is also formed in the same manner as frock; by the application of the elliptic measure, with $\frac{1}{4}$ or $\frac{3}{8}$ of inch added, the centre line is produced the same way, $\frac{1}{2}$ diameter crosswise, with $\frac{1}{2}$ the extra allowance also divided, and the shoulder is formed by the line, proof centre and the centre point at $8\frac{1}{4}$, being placed on centre line and applying the blade measure with the $\frac{3}{4}$ added, or $17\frac{3}{4}$; for overcoat there should be added $3\frac{1}{2}$ at waist; the neck gorge of overcoat requiring to be higher in consequence of being buttoned up occasionally, should be marked at $2\frac{1}{2}$ or $2\frac{3}{4}$ inches down from $12\frac{1}{2}$ at top, and gorge formed accordingly.

We will now proceed and draft forepart, Figure 9, there is very little connected with this forepart different from the other, except the lapel being growing too, and in very heavy goods it is much more appropriate; these two foreparts are essentially alike, with the following exceptions: the sye measure in this case is laid down at $11\frac{3}{4}$, the extra $\frac{1}{4}$ being given in the diame-

ter of the syc. We will proceed and show how to draught the front, wherein it differs from the other forepart: mark $\frac{1}{2}$ the breast measure from 3 to 16, sweep from 16 to $14\frac{1}{2}$ by 3, take out V of 1 inch from $14\frac{1}{2}$ to $15\frac{1}{2}$, then $3\frac{1}{2}$ to $18\frac{5}{8}$, then $3\frac{3}{8}$ to $19\frac{3}{8}$, apply measure at natural waist, allowing $3\frac{1}{2}$ inches for making up, including V, and then form your front by those numbers.

HOW TO DRAUGHT SKIRT, FIGURE 8.— Draw construction line from 0 to $19\frac{1}{2}$, mark down from 0 $2\frac{3}{4}$ and $8\frac{1}{2}$, measure carefully the width of your waist, and apply it from $2\frac{3}{4}$ to 20, including 1 inch over for making up, then lay elbow of square on 20 with long arm resting on $2\frac{3}{4}$, and draw spring of skirt; draw line from $2\frac{3}{4}$, to 20, or top of skirt, and hollow $\frac{1}{2}$ inch, lay bottom of sidebody in a joining position at 20, and round plait of skirt to correspond with sideseam about 3 inches up, mark length of skirt by that of back, the front $\frac{1}{2}$ inch less than behind, and give it the same round as that of waist. The sleeve, Figure 4, is drafted in the following way: First measure around the syc of

your forepart, suppose it to be 18 inches, then draw your construction line from 0 to 33, to 20 is length of elbow, then mark the distance on forepart from 8 to $10\frac{1}{2}$, or $2\frac{1}{2}$, and $\frac{1}{2}$ the distance on back from $4\frac{1}{4}$ to $6\frac{1}{2}$, which is $1\frac{1}{4}$, add $2\frac{1}{2}$ and $\frac{1}{4}$ together, make $3\frac{5}{8}$, deduct $\frac{1}{4}$ for joining of sideseam, and you have got $3\frac{3}{8}$; from middle of pitch or back arm seam to bottom of syc, then mark down $3\frac{3}{8}$ to $3\frac{1}{4}$, draw lines from $3\frac{1}{4}$ to 9, and also 20 to 9, which is $\frac{1}{2}$ the syc measure; then draw line from 0 to 9 or $9\frac{3}{4}$, divide that in halves to $\frac{1}{2}$, mark $\frac{1}{2}$ of same from $\frac{1}{2}$ to $3\frac{1}{4}$, and sweep from 0 to 9 by $3\frac{1}{4}$, and straighten the curve a little towards the forearm; draw hair line of forearm from 9 at top to 9 at bottom, sweep from 33 at bottom to 9 by 0, mark from 9 at bottom to $6\frac{1}{2}$, the width of your bottom, mark $\frac{3}{4}$ inside to $8\frac{1}{4}$, and outside $\frac{3}{4}$ and form forearm, from 9 by $\frac{3}{4}$ to 9, and backarm from 0 by $\frac{3}{4}$ to $6\frac{1}{2}$ at bottom, for underside, mark $\frac{1}{2}$ your syc from 9 at front to 1 behind, and form your underside as model; the collar 6, and the lapel 7, are drafted by the scale corresponding with the breast measure.

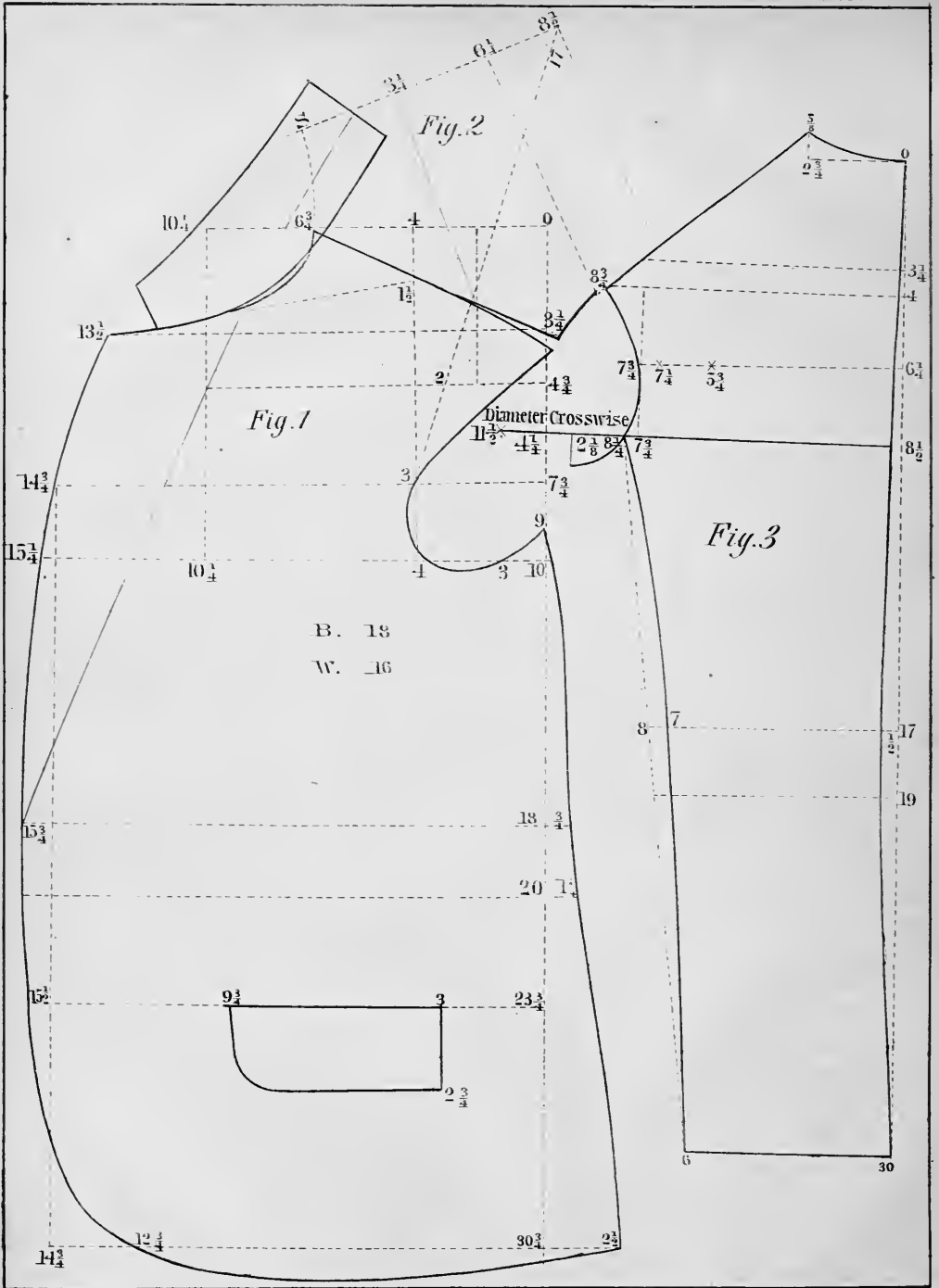

Description of Plate VIII.

ON Figures 1, 2, 3, is the diagram of a single breasted sack coat, it is drafted to the following measure: diameter crosswise, $4\frac{1}{2}$, lengthwise, $5\frac{1}{4}$, shoulder measure $12\frac{1}{4}$, blade 17, syc measure $11\frac{3}{4}$. It is marked $11\frac{1}{2}$, but should be $11\frac{3}{4}$, depth of syc on back $8\frac{1}{2}$, natural waist 17, full length 19, skirt 30, breast 18, waist 16.

HOW TO DRAUGHT BACK, FIGURE 3.—Draw construction line from 0 to 30, lay on elbow of square at 0, and draw back line from 0 by $\frac{1}{2}$, then mark down from 0 depth of syc $8\frac{1}{2}$, lay on diameter lengthwise on back line, $5\frac{1}{4}$ on $8\frac{1}{2}$, and draw line depth of shoulder from $3\frac{1}{4}$, then divide diameter, say $2\frac{3}{8}$ or centre, mark $\frac{1}{2}$ inch below centre for bottom of pitch at $6\frac{1}{4}$, then mark up from $6\frac{1}{4}$ to 4, $2\frac{1}{4}$ inches for top line of pitch or according to fashion, then mark down from 0 natural waist 17, and full length 19, square the upper lines by back line, and waist lines by construction line, lay on your syc measure at back line at $8\frac{1}{2}$, $11\frac{3}{4}$, and deduct your diameter crosswise off 4, from $11\frac{3}{4}$, leaving $7\frac{3}{4}$, to which we add $\frac{1}{2}$ inch for seams to $8\frac{1}{4}$, draw hair line from $7\frac{3}{4}$ up to top of pitch, and add 1 inch inside to $8\frac{3}{4}$, mark inside from 0 at top $2\frac{3}{4}$, raise top $\frac{3}{8}$ for spring, form top from 0 to $\frac{5}{8}$, as model, and shoulder from $\frac{5}{8}$ to $8\frac{3}{4}$ from $8\frac{3}{4}$ by $7\frac{3}{4}$ to $8\frac{1}{4}$, from $7\frac{3}{4}$ to $8\frac{1}{4}$ is $\frac{1}{2}$ inch added to syc measure for seams, mark width of bottom 6 inches, draw line from $8\frac{1}{4}$ to 6 and form sideseam by 7 or $\frac{1}{2}$ inch inside from 8, and form out your back seam as model from $\frac{1}{2}$ to 30, the diameter crosswise is placed here with $\frac{1}{2}$ diameter at $2\frac{1}{2}$, and 1 inch down from line, for the purpose of forming back, and also showing the 1 inch extra which back of sack requires more than other coats, as given from 10 to 9 at point of side of forepart.

HOW TO DRAUGHT FOREPART, FIGURE 1.—Draw construction line from 0 to $30\frac{1}{2}$, square in top, mark down from 0 your shoulder measure to 10 with top of back

$2\frac{3}{4}$ added, making $12\frac{3}{4}$, the shoulder measure being $12\frac{1}{4}$, thus allowing $\frac{1}{2}$ inch extra for making up, then lay on back $8\frac{1}{2}$ on 10, and mark line of pitch and diameter lengthwise, $7\frac{3}{4}$ and $4\frac{3}{4}$ respectively, and run back up to top and mark line depth of shoulder at $3\frac{1}{4}$, by that of back, then square those lines across, mark length of waist on forepart by back, from 9 to 18, 20, by $8\frac{3}{4}$, 8, and square those lines across, also the line $23\frac{3}{4}$ or depth for flap, then mark from 0 to 4, diameter crosswise with the $\frac{1}{2}$ inch added to back, from $7\frac{3}{4}$ to $8\frac{1}{4}$, to $10\frac{1}{4}$ is $\frac{1}{2}$ syc measure, then draw these lines to 4 and $10\frac{1}{4}$ at bottom, then mark centre line, or $\frac{1}{2}$ diameter crosswise as at 2, and lay on back Figure 2 as model, with line depth of shoulder touching centre line and top of back at $\frac{5}{8}$, touching top line at $6\frac{3}{4}$, apply your blade measure from bottom of syc over shoulder to $8\frac{1}{2}$, or blade measure to 17, add $\frac{1}{4}$ of inch for making up, and form shoulder of forepart, according to model. In all sack coats, unless in very erect structures, we let the point of shoulder touch construction line at $3\frac{1}{4}$ and in erect structures we use the line depth of shoulder, instead of proof centre, in all sack coats, as it makes the shoulder a little straighter, and braces them up a little more in front, then add 1 inch up from 10 to 9 at side, mark $\frac{3}{4}$ outside from 18 at natural waist, and mark $2\frac{1}{2}$ at bottom, and form sideseam as model, mark on front of breast from 3 to $14\frac{3}{4}$, $\frac{1}{2}$ breast, with $1\frac{3}{4}$ inches added, sweep from $14\frac{3}{4}$ to $13\frac{1}{2}$ by 3, in front of syc, draw line from $1\frac{1}{2}$ to $13\frac{1}{2}$, and form neck gorge as model, the Figure 3 marked on either side of 4 at bottom, is $\frac{1}{4}$ the syc measure placed on either side of corner, for crossing the lines in forming syc, then form syc by shoulder point at $3\frac{1}{4}$, by 3, 4, 3 to 9, square in bottom from $30\frac{1}{2}$ to $14\frac{3}{4}$ at front, draw line from $14\frac{3}{4}$ at front of breast to $14\frac{3}{4}$ at bottom, mark $\frac{1}{4}$ inch in front to $15\frac{3}{4}$, then form front and bottom as follows: from $13\frac{1}{2}$ by $14\frac{3}{4}$, $15\frac{1}{4}$, $15\frac{3}{4}$, $15\frac{1}{2}$, $12\frac{1}{4}$, to $2\frac{1}{2}$, and complete sack coat.

Description of Plate IX.

ON Figure 2, 3, 4 of this plate we have two different styles of a New York jacket, the same back being adapted to either forepart. These jackets are both drafted to the same measure, and are both laid out on the frock principle, and we do not propose to go over the system with these jackets, but simply to refer the reader to Figures 5 and 6, on plate VI.; where we have given a very ample explanation of a single breasted jacket of the same style. Our explanation in this case, shall, therefore be directed in showing how to draft the double breasted. The shoulder of Figure 4 is established by the centre point and that of Figure 2 by line depth of shoulder. It will be perceived that the line depth of shoulder produces a straight shoulder, which some of our patrons may prefer in this style of coat; they can try both principles and adopt that which they like the best. They are both cut double breasted, the one being pointed lapel with square bottom, and the other with curved lapel and curved bottom; there is no extra allowance given to diameter crosswise at point of side of these jackets, for the following reason: that when the fish under arm is joined, it will throw it, the point of side, out $\frac{1}{2}$ inch, and draw it down to the same amount; besides we have added $\frac{1}{4}$ extra to pitch of back at $7\frac{1}{2}$, at sideseam on Figure 2; from front of syc to lapel is $\frac{1}{2}$ breast to $15\frac{1}{2}$, and width of lapel $3\frac{1}{4}$ to $18\frac{3}{4}$; sweep from $15\frac{1}{2}$ to $13\frac{3}{4}$, take out V to $14\frac{1}{2}$, add 3 inches to $17\frac{1}{2}$ or top of lapel, then mark $18\frac{1}{2}$ in front, at natural waist, and at full length $17\frac{1}{2}$; bottom $12\frac{1}{2}$; and form the front as model. In Figure 1 the front of breast and lapel is $\frac{1}{4}$ less, being $15\frac{1}{4}$ and $18\frac{1}{4}$; 18 in front at natural waist, and $14\frac{1}{2}$ at bottom; and is formed by the numbers in front in the same way we have described. The hollow at sideseam of these styles of jackets should be stretched $\frac{3}{8}$ of an inch at $\frac{1}{2}$, at natural waist, before joining, and cut that much short at $23\frac{1}{4}$, and the lining kept full over sidebody. By a strict observance of the manner of drafting these jackets in connection with Fig-

ures 5 and 6, plate VI., will enable the reader to draft one of these jackets as easy as any other coat.

Figures 1 and 5 are the diagrams of a reefer or pea jacket. This jacket is drafted to the same measure as that of the other two jackets, excepting syc measure, which is $\frac{1}{4}$ of inch more in this case than the others, the following is the measure: diameter lengthwise, $5\frac{1}{2}$; crosswise, $4\frac{1}{4}$; shoulder $12\frac{1}{4}$; blade, $17\frac{1}{4}$; syc measure, $11\frac{3}{4}$; the other jackets $11\frac{1}{2}$; depth of proof centre, $1\frac{7}{8}$; centre point, $7\frac{3}{8}$; depth of syc on back, $8\frac{1}{2}$; natural waist, 17; full length in Figures 2 and 4, 21; in Figure 1, $23\frac{1}{2}$; length of skirt in each 30. In the syc measure of these jackets, the reader may think we have only allowed $\frac{1}{4}$ of inch extra for making up, but such is not the fact, as when the fish under arm is joined it will throw out the point of side at 2 and 9, from $\frac{1}{4}$ to $\frac{1}{2}$ inch, which adds so much to the syc measure. In back, Figure 1, the $\frac{1}{2}$ inch added to the syc measure for making up, is given to the width of back at pitch, to $7\frac{3}{4}$; the line of proof centre is not used in this jacket; but the line depth of shoulder, as marked on Figure 3, on back, placed for forming shoulder marked by hair lines; the step at $23\frac{1}{2}$ on back, may be omitted in this jacket, according to fashion, and at the will of the cutter; the back line is marked in $\frac{3}{4}$ at natural waist, and $\frac{2}{3}$ at step. The width of back at natural waist is 6 inches, and at bottom $6\frac{1}{2}$; the front of breast in the same way as that of Figure 4, excepting that the front is drawn straight from $16\frac{1}{4}$ in front of breast, to $16\frac{1}{4}$ at bottom. In some cases half inch more might be added at bottom. At natural waist of forepart, Figure 5, the side is outside of construction line $\frac{3}{4}$ of inch, and at plait $1\frac{3}{4}$, and at bottom $2\frac{1}{2}$; this point is regulated a good deal by fashion. They are made to fit rather close at this point, at the present time. Figure 25 is for locating the top of plait, and also of flap; the other points of the diagram seem so conspicuous, that further comments are thought unnecessary.

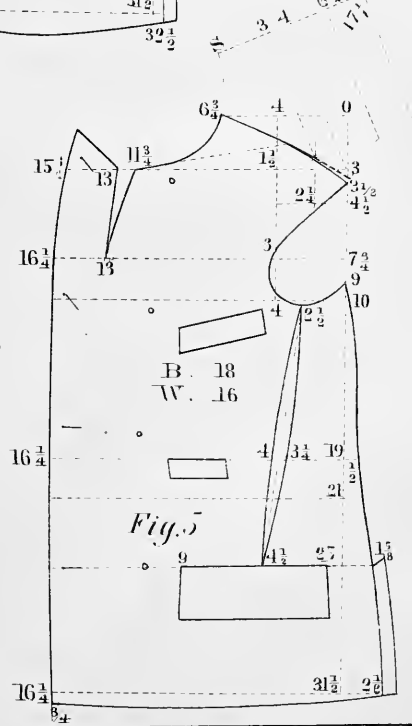
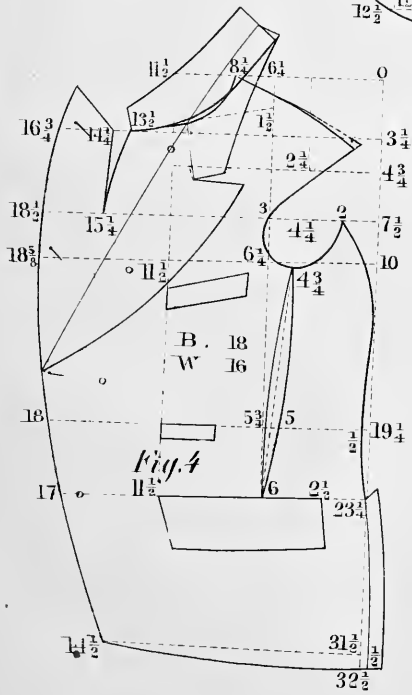
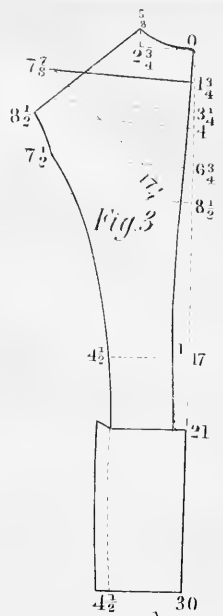
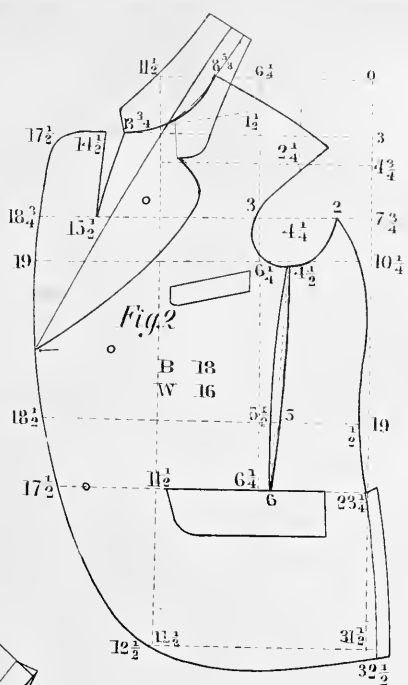
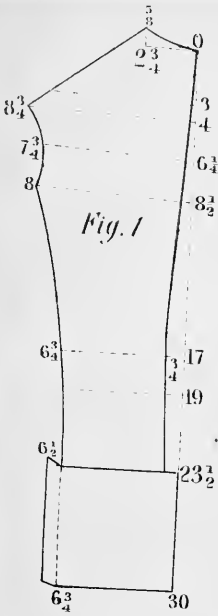





depth of shoulder, and therefore has nothing added. But we mostly keep the point of shoulder at construction line, at $4\frac{1}{2}$, and the front point touching top line as at 7; then apply blade measure with $\frac{3}{4}$ of inch added for overcoat, and if there is any filling up of shoulder, sufficient for that purpose, and form shoulder to correspond with your measure. Then mark $\frac{3}{4}$ outside at natural waist, and $1\frac{1}{2}$ outside from $25\frac{1}{2}$, and $3\frac{1}{2}$ at bottom; and form side seam from $9\frac{1}{4}$ by $\frac{3}{4}$ to $3\frac{1}{2}$ at bottom, and syc from $4\frac{1}{2}$ by 3, $4\frac{1}{4}$, 3, $9\frac{1}{4}$; then draw line from $1\frac{1}{2}$ to $12\frac{1}{2}$, and form neck-gorge as model; then take out V of $\frac{3}{4}$ of inch, as from $12\frac{1}{4}$ to 13; then mark in front of syc from 3 to $13\frac{1}{2}$, $\frac{1}{2}$ breast measure; sweep from $13\frac{1}{2}$ to $12\frac{1}{4}$ at top; take out V as to 13; mark width of lapel from $13\frac{1}{2}$ to 17, or $3\frac{1}{2}$ inches and 3 at top, from 13 to 16; draw line from $17\frac{1}{4}$ to $17\frac{1}{4}$ at bottom; add 1 inch outside, as to 18; and draw front line from $17\frac{1}{4}$ to 18, by $17\frac{1}{2}$ and $17\frac{3}{4}$; then draw bottom line on the square, front and rear; mark down from line $\frac{3}{4}$ of inch, and form

bottom, from $\frac{3}{4}$ to $3\frac{1}{2}$; take out fish, as from $2\frac{1}{2}$ to 5 as model, and finish forepart.

Figure 6 is the diagram of single breast-ed over sack, and is drafted to the same measure, with the following exceptions. It is but 2 inches shorter; the diameter in this forepart is marked at $4\frac{1}{2}$, and the back at 9, 8, $8\frac{1}{2}$, should be reduced $\frac{1}{4}$ of inch respectively; the $16\frac{1}{4}$ at bottom is in the wrong place, as it applies to the front hair line; the front of breast is $\frac{1}{2}$ breast measure from front of syc; and the lapel is $2\frac{3}{4}$ inches in width. When a straight sack is required, the back line and side lines are cut straight, and no fish taken out under arm.

The sleeve, Figure 4, is drafted in the same way as that represented on Figure 4, plate VII. The distance in all cases from 0 to $3\frac{1}{4}$ should be from where back seam of sleeve joins on back pitch, which, in this case, would be 1 inch above 8, and would amount to 4, and therefore $\frac{3}{4}$ of inch too short.



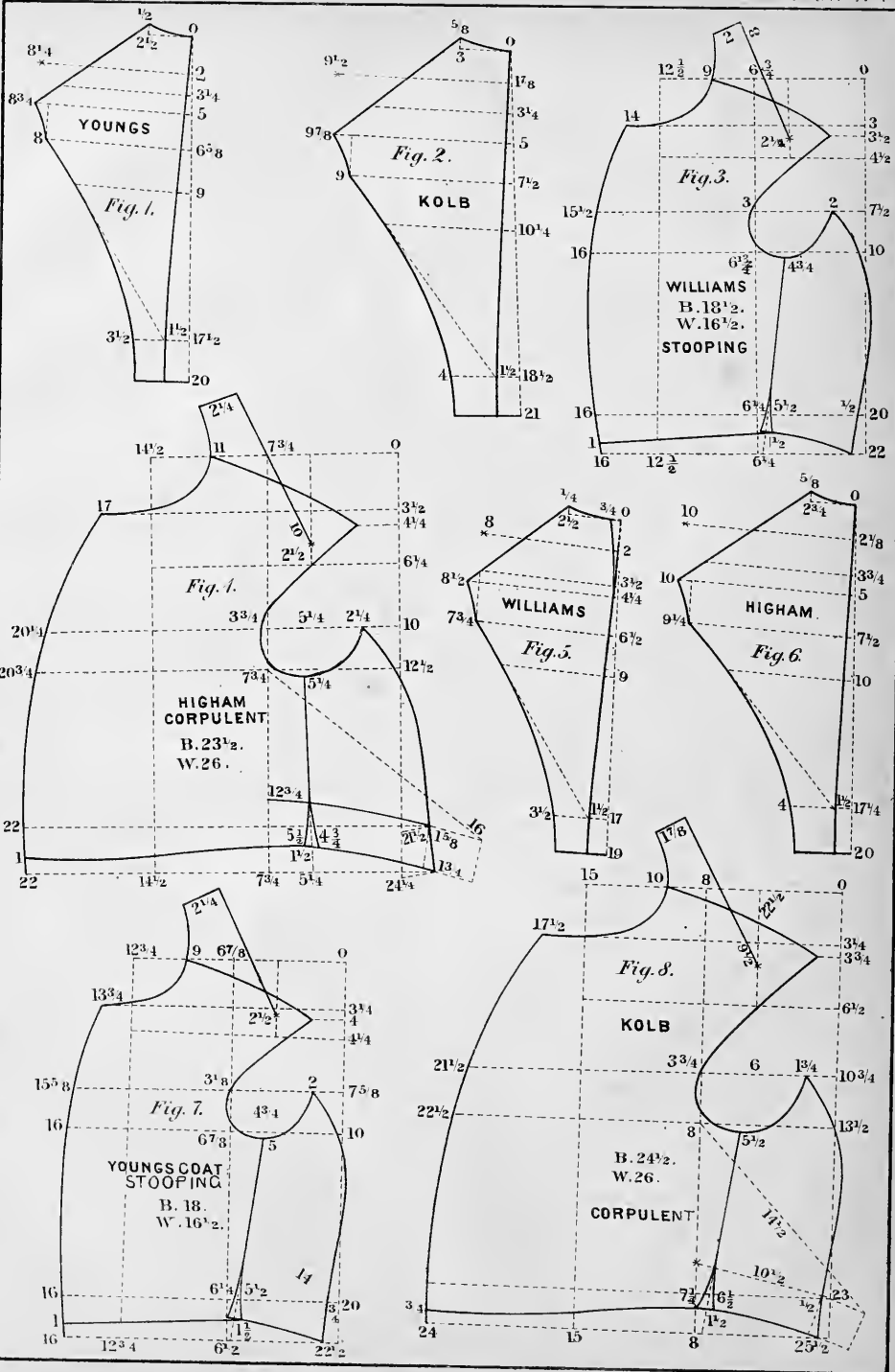

Description of Plate XI.

ON Plate XI. we give two illustrations of the stooping structure, and also two of the corpulent structure, and under this class of structures may be enumerated all the various phases of what is usually called deformities. We will confine our remarks to the corpulent structure first. In the Kolb coat, Figures 2 and 8, we have what is usually termed the pot-bellied structure. The various phases of this structure are the erect and extra erect, with high shoulders, and the extra erect stooping forward; and under the head of the Higham coat, we have three different types of corpulency, namely: the style known as the high hip-boned structure with high shoulders, whose stoutness is most behind, also the long bodied of a similar character, and also the structure which carries his corpulency all around, and is sometimes stooping. The Higham coat represents the latter phase, all but the stooping. We will now proceed and give the two measures, that the reader may be enabled to look at the contrast, and the natural result through the application of the measures by the system. The following is the Higham measure: diameter crosswise, $5\frac{1}{4}$; lengthwise, $6\frac{1}{4}$; shoulder measure, $14\frac{3}{4}$; blade, $20\frac{3}{4}$; sye measure, $14\frac{1}{2}$; elliptic, 16; depth of sye on back, 10; natural waist, $17\frac{1}{4}$; full length, 20; breast, $23\frac{1}{2}$; waist, 26. We will now give the measure of the Kolb coat: diameter lengthwise, 7 inches; crosswise, 6; shoulder measure, 16; blade, $22\frac{3}{4}$; sye measure 15;

elliptic, $14\frac{1}{2}$; depth of sye on back, $10\frac{1}{4}$; natural waist, $18\frac{1}{2}$; full length, 21; breast $24\frac{1}{2}$; waist, 25. The reader, by looking at the diagrams of these two coats in connection with the measure, will at once perceive their peculiar adaptation to the structures in question. In the Higham coat we perceive the diagram of a structure that never can redound much to the artistic skill of the cutter, however much it may to his practical judgment, for these are a class of customers more difficult to fit than are usually met with. In cases of extreme corpulency, and when the body is gathered up in a heap, the form is such an unshapely mass that the cutter would most gladly avoid it if he could, and yet men of this class are very particular respecting the fit of their garments, particularly as far as ease is concerned, and, if it is not easy, everybody will soon know it. But there is one type of men in this phase of structure who wear their clothes with neatness and in good taste; they are not only the most difficult to fit, but also to suit, that the cutter generally meets with. We refer to the high shouldered, short bodied, high hip-boned structure, whose corpulency is moderate in front, but very prominent behind. Among this class we have had some very talented men of certain peculiar characteristics; we have had three very prominent members of the trade, of this type, and who were all men of talent. The long bodied structure of this type is usually high shouldered and only moderately corpulent in front,

to solve that question—when you come across a customer of this kind, establish your centre point on the top of shoulder by a chalk mark, and from said centre point, apply a measure first to the socket bone, next to the centre of diameter, or a point about the same distance down, established on back, and also to the bottom of eye on back; these measures should be applied from the centre point as model, first to the bottom of eye on back, $\frac{3}{8}$ extra should be added next to the point at centre, and $\frac{1}{2}$ inch should be added next to the socket bone, 8, and $\frac{1}{2}$ inch should be added; the back and shoulder should be rounded and

formed in connection with these measures, and in the case where there is a hump on back, take the depth of the prominent part of the hump from socket bone, and apply the above measures from centre, and thus be able to ascertain the amount of roundness to give to shoulder and back seam. We give above the name, of this class of structures as deformities instead of misfits, as we do not intend there will be any of the latter, and it displays the artistic ability of the cutter to be enabled to neutralize the strong points of the former so as not to appear conspicuous.



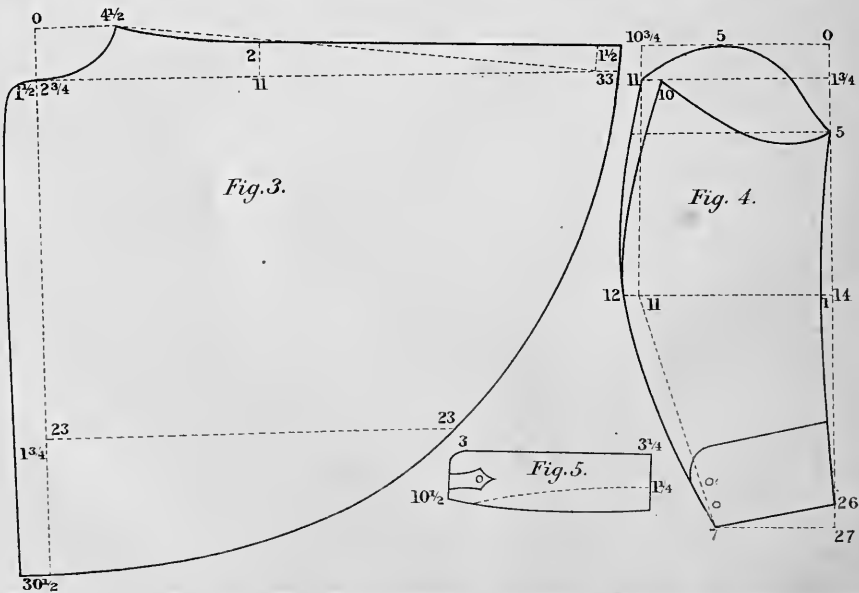
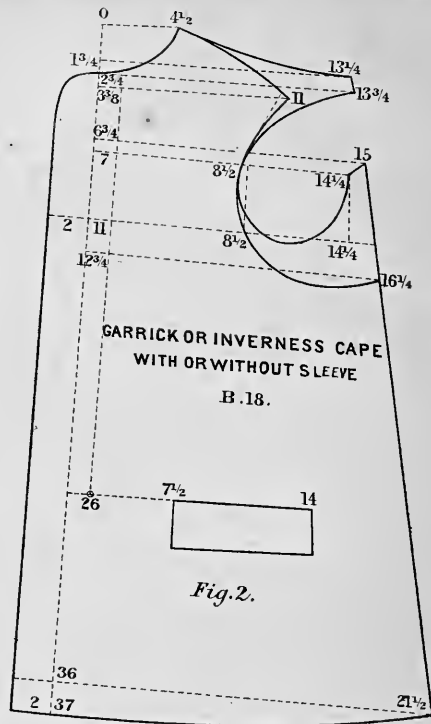

Description of Plate XII.

FIGURES 1, 2, 3, 4, 5 are the diagrams of a Garrick or Inverness cape. There are two different styles of cloak represented on Figure 2, the one with sleeve and the other without; the one without is formed by the Figures 11, $8\frac{1}{2}$ to $16\frac{1}{2}$, and is laid down to be drafted by the scale corresponding with the breast measure taken over the vest, the extra allowance being given in the diagram; and in case some of our readers may not know how to use the scale, we will select scale 18, and proceed to draft this garment. To draft back, Figure 1,—draw back line from 0 to 38, square in top; mark down from 0 by the scale, $\frac{5}{8}$, 5, 10, 37, 38, square these lines across; mark on top line, 3; second line, $8\frac{3}{4}$; third line, $10\frac{3}{4}$; bottom, $13\frac{1}{2}$; draw dotted line from $10\frac{3}{4}$ to $13\frac{1}{2}$; and form top of back from $\frac{5}{8}$ to 3; shoulder from 3 to $8\frac{3}{4}$; and side by $10\frac{3}{4}$ to $13\frac{1}{2}$; bottom from 38 to $13\frac{1}{2}$. To draft forepart, Figure 2,—draw construction line from 0 to 37; mark down from 0, $1\frac{3}{4}$, $2\frac{3}{4}$, $3\frac{3}{4}$, $6\frac{3}{4}$, 7, 11, $12\frac{3}{4}$, 26, 36, 37; square these lines across; mark inside, on top line, $4\frac{1}{2}$; second line, $13\frac{1}{4}$; third line, 11 and $13\frac{3}{4}$ inside, and $1\frac{3}{4}$ outside; fourth line, 15; fifth line, $8\frac{1}{2}$, $14\frac{1}{4}$; sixth line, $8\frac{1}{2}$; $14\frac{1}{4}$ inside, and 2 outside; seventh line is depth of pocket flap; eighth line, $21\frac{1}{2}$ inside, and 2 outside; draw lines from $4\frac{1}{2}$ to $13\frac{3}{4}$, and from 15 to $21\frac{1}{2}$; draw the short lines from $13\frac{1}{4}$ to $13\frac{3}{4}$, and from $14\frac{1}{4}$ to 15 respectively, and curve shoulder point out to $13\frac{1}{4}$; then form sye by $13\frac{3}{4}$, $8\frac{1}{2}$ in front and $8\frac{1}{2}$ at bottom, to $14\frac{1}{4}$ at side; mark neck-gorge from $4\frac{1}{2}$ by $2\frac{3}{4}$ to $1\frac{3}{4}$, and front and bottom as model.

TO DRAFT CAPE, FIGURE 3.—Draw construction line from 0 to $30\frac{1}{2}$, square in

top; mark down from 0 at top $2\frac{3}{4}$, 23, $30\frac{1}{2}$; square these lines across; mark inside at top, $4\frac{1}{2}$; second line, 11; 33 inside, and $1\frac{1}{4}$ outside; third line, 23 inside, and $1\frac{3}{4}$ outside; mark up from 11, 2 inches, and form the shoulder from $4\frac{1}{2}$ to 2, by forepart; then draw straight line from 2 to $1\frac{1}{2}$; sweep from $30\frac{1}{2}$ to 23, by $\frac{1}{2}$ the distance from 0 to $4\frac{1}{2}$; and from 23 to $30\frac{1}{2}$ by $4\frac{1}{2}$; and form front as model.

TO DRAFT SLEEVE, FIGURE 3.—Draw construction line from 0 to 27, square in top; mark down from 0, $1\frac{3}{4}$, 5, 14, 26, 27, square these lines across; mark on top line, 5, $10\frac{3}{4}$; second line, 10, 11; fourth line, 11, 12; bottom, 7; draw line from $10\frac{3}{4}$ to 11; and from 11 to 7; and form the outside of sleeve by 11, 12, 7; and forearm by 5, 1, 26; bottom from 26 to 7; sleeve-head by 11; 5 at top to 5 at forearm, and underside as model. The collar is drafted the same way, and a larger or smaller scale, gives a larger or smaller pattern. The line running up from front of sye on shoulder to 11; and also from bottom of sye to side at $16\frac{1}{4}$, is indicating a Garrick without sleeve; these points need not be added on in such case. To join it together, the point $13\frac{1}{4}$ and $13\frac{3}{4}$ should be joined to the point $14\frac{1}{4}$ and 15; and then the sleeve should be put in; then the cape, Figure 3, should be baisted on along the neck-gorge and down the side; and then the back, Figure 1, should be joined to that of forepart, 3 on back to point $4\frac{1}{2}$ on shoulder, sewing the three pieces together as far down the side as the cape goes, and the back and forepart to the bottom. The step of cape is cut $\frac{1}{2}$ inch narrower than forepart, and when there is a fly put in front, it should be in the cape.

Description of Plate XIII.

PLATE XIII. represents what is generally known as the King William Cloak, with sleeves. This cloak, we believe, is correct in all its points; a slight curve might be given to front. The back, forepart, and collar are drafted in the usual way by the scale (which we have described on Plate XII., on Inverness Cape), corresponding with the breast measure taken over the vest, the extra allowance being given in the diagram. To draft the cape and sleeve, draw construction line from 0 to 29, mark down from 0 the numbers on said line, draw the line $2\frac{1}{4}$, and mark the numbers 7, 10, $13\frac{1}{4}$, and square up to $3\frac{7}{8}$, then draw line from $4\frac{1}{2}$ to $9\frac{3}{4}$, and also from 6 to 11, $16\frac{1}{2}$, $17\frac{1}{4}$, $18\frac{1}{2}$, and draw the lines on the square by said numbers, first to $8\frac{1}{4}$, $16\frac{7}{8}$, next $8\frac{5}{8}$, next 12, $16\frac{7}{8}$; draw line on square from $8\frac{5}{8}$ to $10\frac{1}{4}$

and $20\frac{1}{4}$, and square out the line from $10\frac{1}{4}$ to 7, or elbow, then draw lines from $11\frac{5}{8}$ to $18\frac{1}{2}$ and from $14\frac{1}{2}$ to $30\frac{1}{8}$, sweep from 29 to $30\frac{1}{8}$ by * mark at $3\frac{1}{2}$, and form bottom of sleeve from $30\frac{1}{8}$ to $34\frac{1}{4}$ to $20\frac{1}{4}$, then form back arm seam from $9\frac{3}{4}$ by 11, $18\frac{1}{2}$ to $30\frac{1}{8}$, and back arm from $16\frac{7}{8}$ by 7 to $20\frac{1}{4}$, and sleeve head from $9\frac{3}{4}$ by 10, $3\frac{7}{8}$, $8\frac{1}{4}$, $8\frac{5}{8}$, 12, $16\frac{7}{8}$, and draw forearm from $8\frac{5}{8}$ to $34\frac{1}{4}$. In putting this cloak together it will be seen that the cape must be basted on the back and joined to the shoulder of forepart, and then the sleeve-head from $8\frac{1}{2}$ on forepart to $9\frac{3}{4}$ on back, which is the same point. The underside sleeve is fastened to the lining by means of a binding. It should have a fly down the front, and the edges should be finished with a wide silk braid.

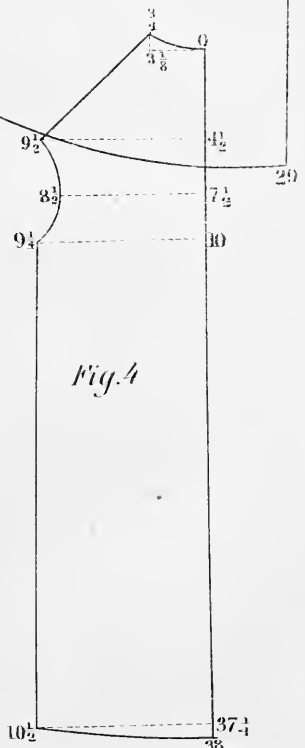
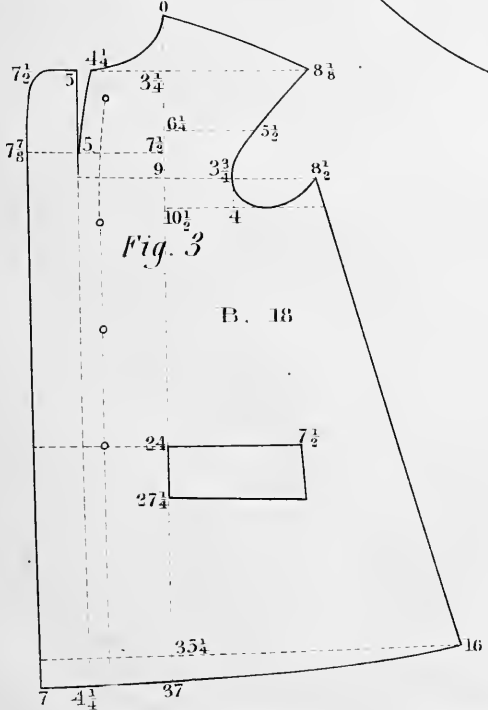
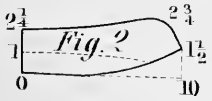
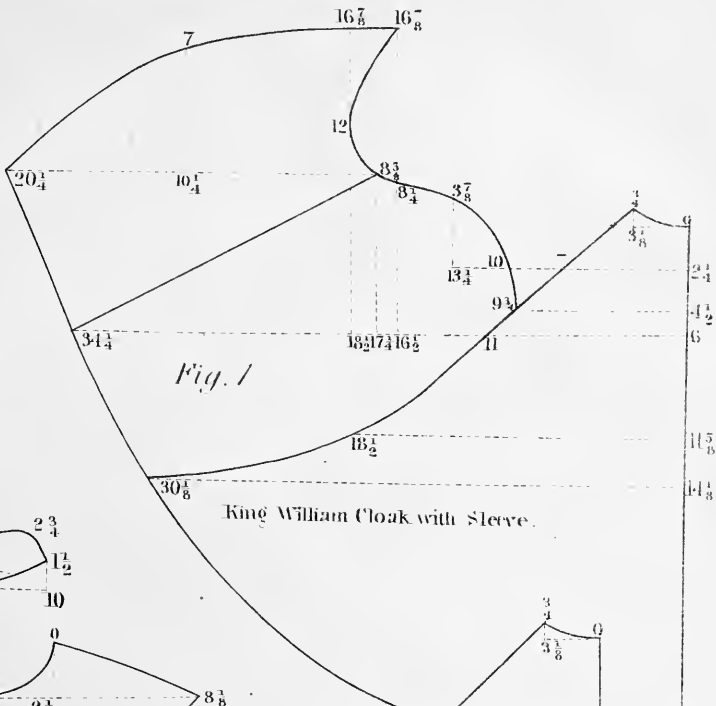

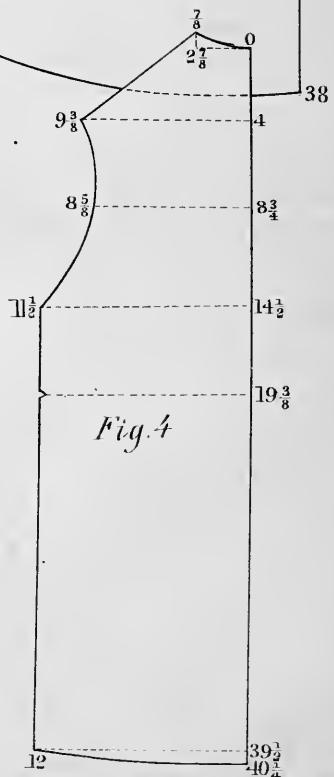
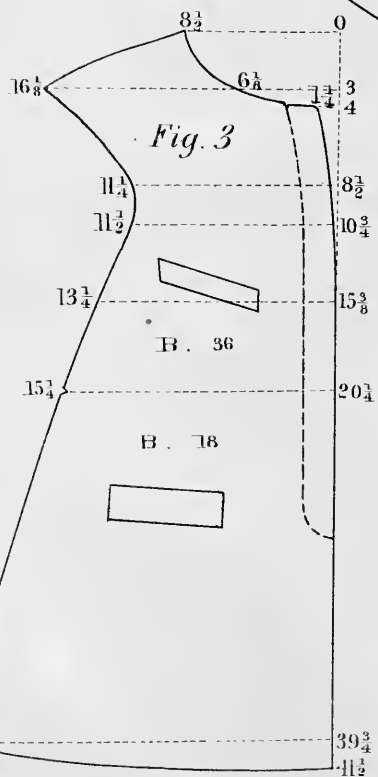
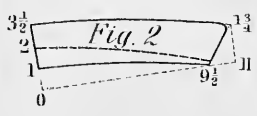
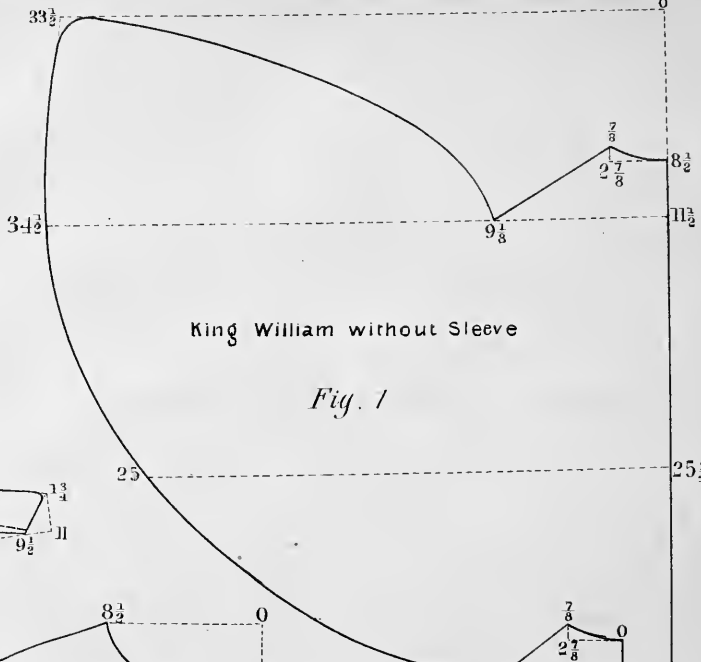

Description of Plate XIV.

THIS Plate represents a King William Cloak without sleeves. It is cut single-breasted, has a fly down the front, and is intended to button close up to the neck. When a roll of breast is intended, an addition should be given to the front. This garment is much worn by many for travelling purposes, and is a very handy garment for business men in going to and from their business. It is drafted in the usual way, by the scale corresponding with the breast measure taken over the vest, the extra allowance being given in the diagram. The reader will see at a

glance how the cloak is put together. The cape, Figure 1, is basted on the back, Figure 4, the shoulders joining to that of forepart, and the sleeve-head, or wing, sewed into the sye and drawn down the side as far as it goes; the point, $11\frac{1}{2}$ on back, should join the point $13\frac{1}{4}$ on forepart, and also the notch at side of back to notch at side of back to notch at $15\frac{1}{4}$ on side of forepart. It closes with a fly down the front as represented; the hollowed part of collar is sewed to the neck-gorge, but before sewing to, it should be stretched and the crease shrunken in.

Description of Plate XV.

HOW to draft half circular cloak, draw line from 8 on top to 42 at bottom ; mark down from 8 to 0, 8 inches or the width of neck, square in top or front of cloak. For taking the fish out of neck, square inside from 0 to $3\frac{1}{2}$, and raise up 1 inch, same as back of King William ; then draw line of shoulder to bottom at 44 by 4, or $\frac{1}{2}$ neck ; then mark down from 0, $5\frac{1}{4}$ and square out to $10\frac{3}{4}$; then mark 4 inches down on front and 10, draw line from 4 in front by $5\frac{1}{2}$ to 10 down on shoulder, and then form curve of shoulder from $5\frac{1}{2}$ to $10\frac{3}{4}$; sweep front of neck from $5\frac{1}{2}$ to 10 by 4 in front, and bottom from 42 to 44 by 4 on top, and from 44 to 41 by $5\frac{1}{2}$; then add 1 inch for step in front, as represented by dotted line. The scale can also be used for this cloak.

How to draft three quarter circular cloak, Figure 3—draw back line from 4 to 42, and square in top from 4 to $43\frac{1}{2}$; from 0 to 4 is half the neck measure, square inside from 0, $3\frac{1}{2}$ inches, mark 1 inch up and sweep the neck from 0, 1, 2 by 4 ; straighten the curve $\frac{1}{2}$ inch down at front, then measure the length of neck-gorge, which should be 2 or $2\frac{1}{2}$ inches more than tight

measure of neck, which would be 10 or $10\frac{1}{2}$, and usually divides the neck equally in three parts, or three quarter circular, and draw front line from 4 by $\frac{1}{2}$ to $40\frac{1}{2}$, curve front as model, sweep from 42 to $43\frac{1}{2}$ by 1, and from $43\frac{1}{2}$ to $43\frac{1}{2}$ by 4, and from $43\frac{1}{2}$ to 41 by 2 ; the collar, Figure 2, is adapted to either of these cloaks.

Figure 4 is the diagram of a Russian Hood, which may be worn with any over garment. It is drafted by the scale corresponding with the breast measure from the line of construction, which runs from 0 to $24\frac{1}{4}$; square in top to $10\frac{1}{2}$, and establish all the other points by the scale and the numbers on the diagram, and form as model. To put the hood together, seam up the cuts on the neck first ; from $7\frac{1}{2}$ to $24\frac{1}{4}$ is on the crease ; then seam it along the bottom and open up the crease, and place the number 16 on $7\frac{1}{2}$; put a binding an inch wide around the neck-gorge, so as to contain holes to button under the stand-up of the collar. The part from $10\frac{1}{2}$ to 16 should have a large turn in, so as to allow of a small ribbon or a piece of India-rubber to run through it, to confine it in close to the neck or for use when required.

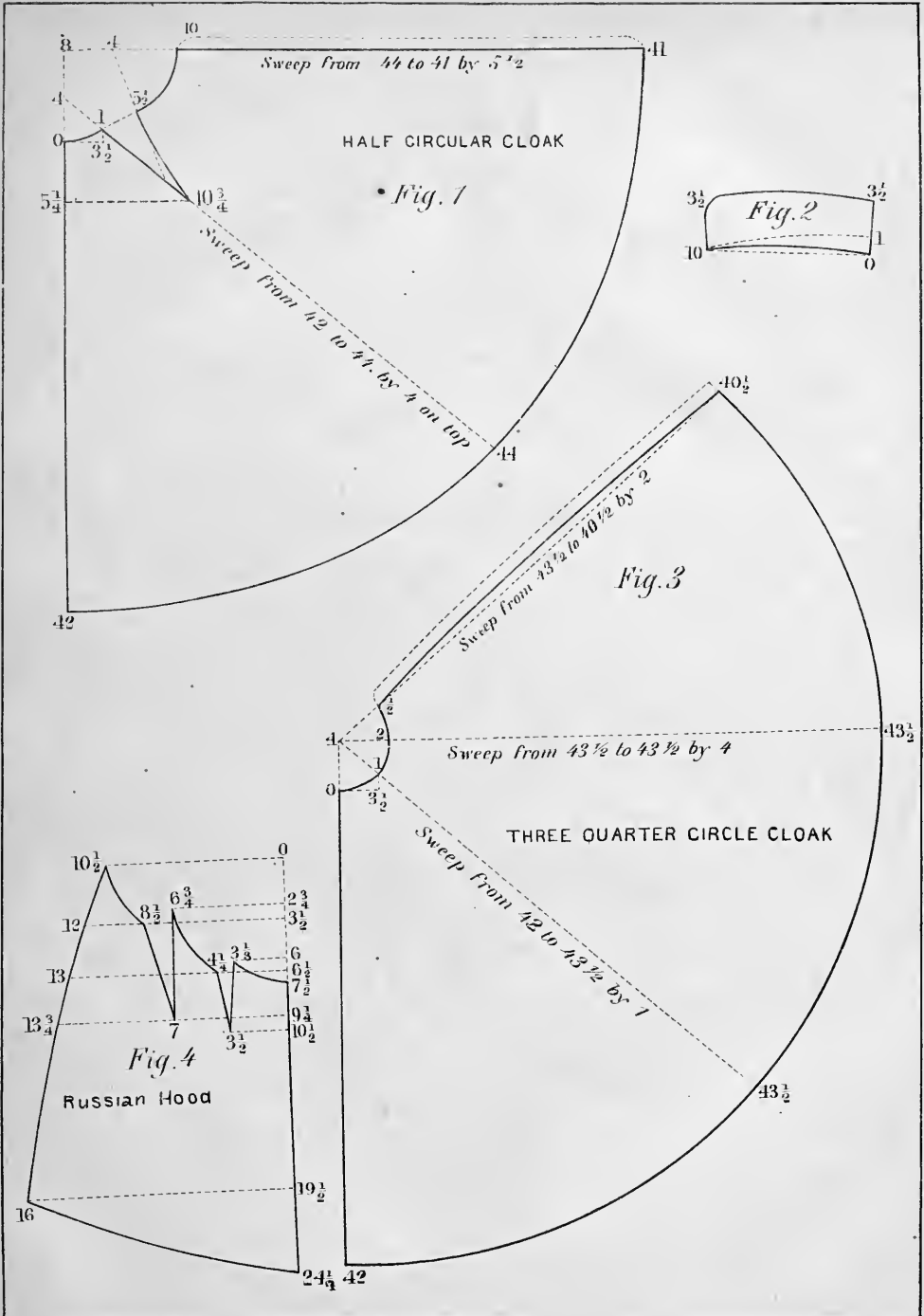





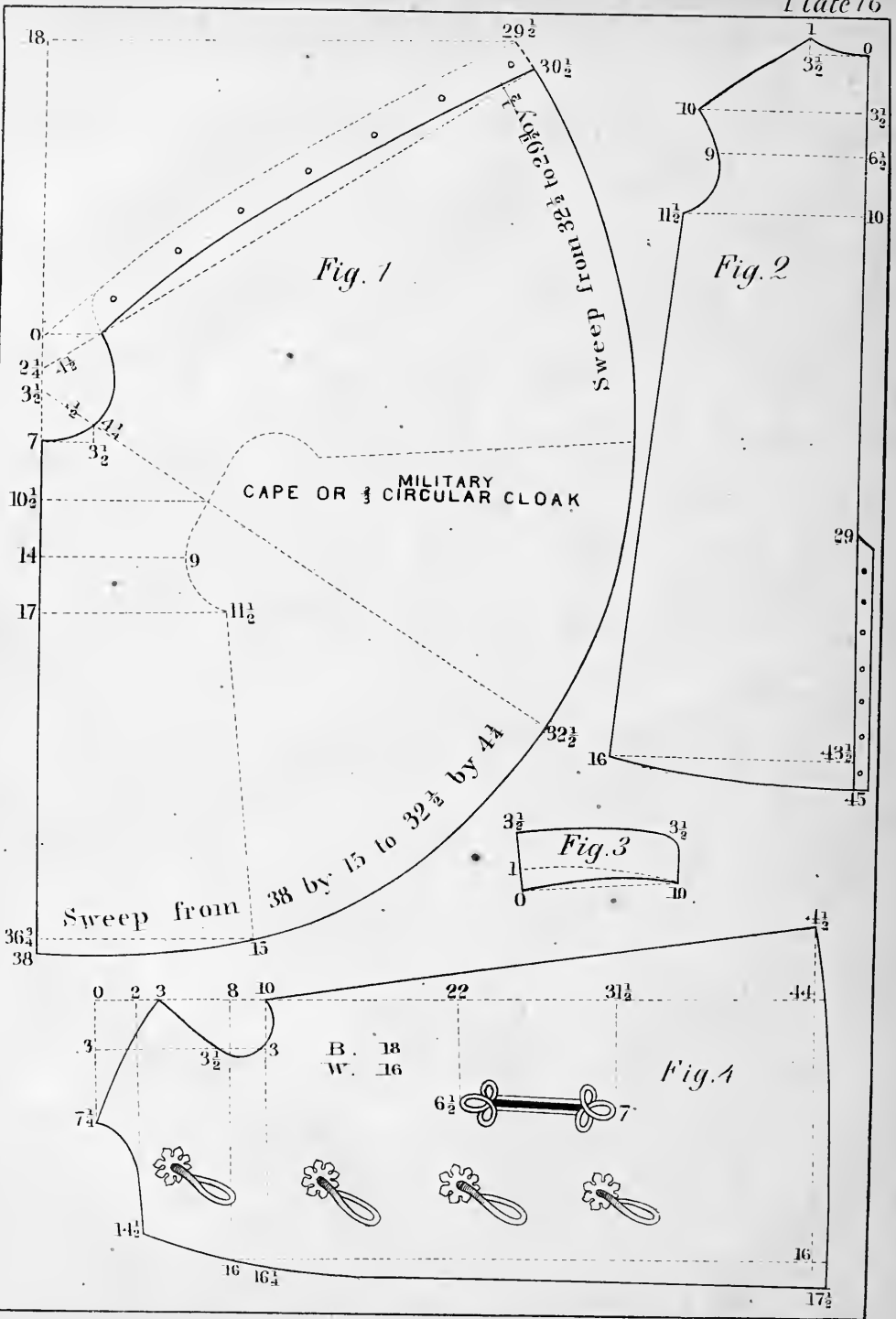

Description of Plate XVI.

MILITARY.

FIGURES 1, 2, 3, 4, with 9 on plate XVII. are the diagrams of a military cloak or coat. It should be of dark blue cloth, and closed by means of four frog buttons of black silk, and also 4 loops of black silk cord down the front, as represented on diagram, and at the throat by a long loop *a Eschille*, without tassel or plait, on the left side, and a black silk frog button on the right; the cord for the loops should be fifteen hundredths of an inch in diameter, the back is without seam, but is cut up from 15 to 17 inches, in proportion to the length, and a fly set in with 7 buttons and holes; collar of the same color and material as the coat; the edges should be slightly rounded off, and should be made to either stand or fall, and when standing, to be about 5 inches wide, sleeve loose, of a single piece, and round at the bottom, without cuff or vent; the linings should be of woollen. There should be a black silk braid about half inch wide sewed flat on the edges, and also the pockets; and around each frog button on the breast a knot two and one quarter inches diameter, of black silk cord, seven hundredths of an inch in diameter, arranged in accordance with the drawing on diagram. The cape is of the same color and material, and can be removed at the pleasure of the wearer, and should reach to the bottom of sleeve when the arm is extended; the length of the cloak should be from 6 to 8 inches below the knee, or in proportion to height, to indicate the rank; there will be on both sleeves, near the lower edge, a knot of flat black silk braid, not exceeding $\frac{1}{2}$ of an inch in width, arranged to correspond with the drawing, and composed as follows:

FOR A GENERAL—of five braids, double knot.

FOR A COLONEL—of five braids, single knot.

FOR A LIEUTENANT-COLONEL—of four braids, single knot.

FOR A MAJOR—of three braids, single knot.

FOR A CAPTAIN—of two braids, single knot.

FOR A FIRST LIEUTENANT—of one braid, single knot.

FOR A SECOND LIEUTENANT AND BREVET SECOND LIEUTENANT—a plain sleeve, without knot or ornament.

This cloak is drafted in the usual way from the line of construction by the numbers on the diagram, corresponding with those of the scale. We will now finish military cloak by showing how to draft cape in plate XVIII. Lay back and forepart in a joining position at shoulder, then mark around the neck and down the back the length you wish to cut the cape, say 31 inches; then give it the same shape as front of forepart; it should be a little fuller, it having to fit over the cloak; carry out shoulder line to bottom of cape, give it $1\frac{1}{2}$ more over shoulder than behind, and 1 less in front than behind, and sweep the bottom from 38 to 15 by $4\frac{1}{2}$, and from 15 to $32\frac{1}{2}$ by $4\frac{1}{2}$, and from $32\frac{1}{2}$ to $30\frac{1}{2}$ by $\frac{1}{2}$. This cape can also be drafted by the scale. The ornament on sleeve, with three braids, should be carried along the bottom of underside, as represented.

For all other officers, dark blue close fitting double-breasted surtout coat, with a cape made to detach from the coat, and fall to the tips of the fingers, when the arm and hand are extended, the skirt of the coat for mounted officers to reach half way between the knee and the sole of the foot. For dismounted officers, three inches below the knee. This coat should have 7 buttons on each breast, of the same pattern as those on the uniform coat; the insignia of rank are the same as the cloak.

Description of Plate XVII.

COATS—FULL DRESS.

FOR OFFICERS.—All officers shall wear a double-breasted frock coat of dark blue cloth, the skirt to extend from one half to three fourths the distance from the hip joint to the bend of the knee.

FOR A GENERAL.—Two rows of buttons on the breast, twelve in each row, placed by fours, the distance between each row five and one half inches at top, and three and one half inches at bottom; stand up collar, not less than one nor more than two inches in height, to hook in front at the bottom, and slope thence up and backward at an angle of thirty degrees on each side, corners rounded; cuffs three inches deep, to go around the sleeves parallel with the lower edge, and with three small buttons at the under seam; pockets in the folds of the skirt, with two buttons at the hips and one at the lower end of each side-edge, making four buttons on the back and skirt of the coat; collar and cuffs to be of dark blue velvet; lining of the coat black.

FOR A LIEUTENANT GENERAL.—The same as for a general, except that there will be ten buttons in each row on the breast, the upper and the lower groups by threes, and the middle groups by fours.

FOR A MAJOR GENERAL.—The same as for a general, except that there will be nine buttons in each row on the breast, placed by threes.

FOR A BRIGADIER GENERAL.—The same as for a general, except that there will be

eight buttons in each row, on the breast, placed by pairs.

FOR A COLONEL, LIEUTENANT COLONEL, AND MAJOR.—The same as for a general, except that there will be nine buttons in each row on the breast, placed at equal distances; collars and cuffs of the same color and material as the coat. The upper half of the cuffs to be ornamented with three double stripes of gold braid running the length of the cuff, pointed at their upper ends, and with a small button below the point of each stripe, according to pattern.

FOR A CAPTAIN, 1st LIEUTENANT, 2nd LIEUTENANT, AND AN ADDITIONAL 2nd LIEUTENANT.—The same as for a colonel, except that there will be seven buttons in each row on the breast, and two stripes on the cuffs.

FOR ALL STOREKEEPERS.—A single-breasted coat, as lately worn by captains of the staff, with staff shoulder-straps to indicate rank.

This coat shall be worn on all dress occasions, such as reviews, inspections, dress parades, guards, and courts-martial. It will be habitually worn at battalion drills, except in hot weather, or when otherwise exceptionally directed by the commanding officer.

Figures 1, 3, 5, 6, 7, 8, on Plate XVII. are the diagrams of single and double-breasted military coat, and are drafted by the system to the following measure: diameter lengthwise, $5\frac{1}{4}$; crosswise, $4\frac{1}{4}$;

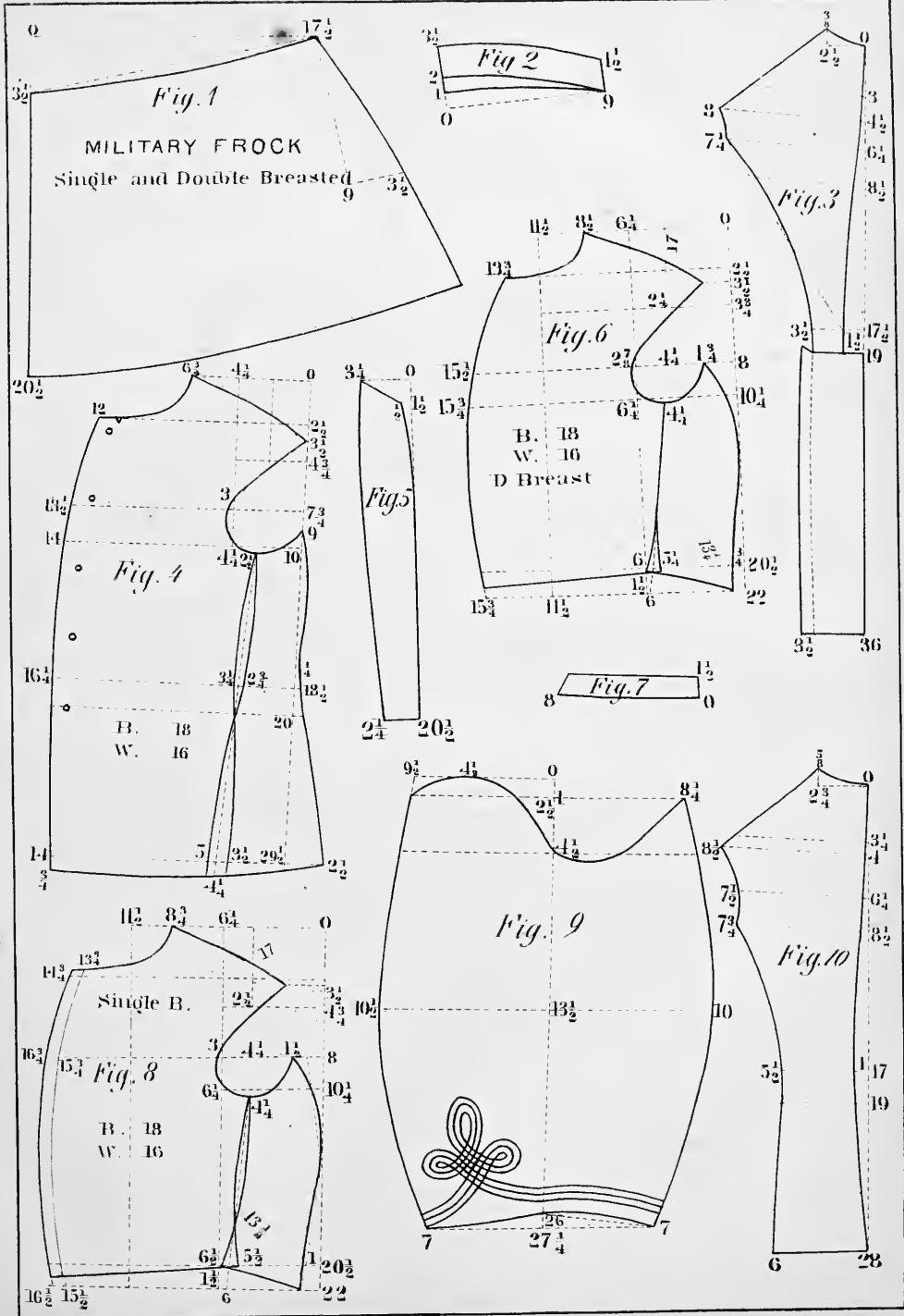



shoulder, $12\frac{1}{2}$; blade, $17\frac{1}{2}$; syc, $11\frac{1}{2}$; clip-tic, $13\frac{1}{2}$; depth of syc on back, $8\frac{1}{2}$; natural waist, $17\frac{1}{2}$; full length, 19; to bottom of skirt, 36; breast, 18; waist, 16; collar, 8. These coats are drafted the same as dress frock, with the following exception: The length of breast should be taken from the nape of neck, and when the thumb is on the measure at front of waist, the measure should be carried up to the extreme point of neck-bone; and, in the application of this measure, $\frac{1}{2}$ inch more should be added for the drawing in of front. In single breast there should be 1 inch added to front, and should be filled on, and facings kept tight and well wadded, which will require the extra inch. The Frock Coats are adopted in most all cases of military or navy, the difference consisting chiefly of trimming. The single-breasted frock is but little worn, except by militia. The skirts of military coats should have more drapery than citizens, and therefore hollowed a little more at waist, and given a little more spring behind.

COATS—UNDRESS.

FOR OFFICERS (for fatigue, marches, squad and company drills, and other drills, when authorized by the commanding officer, and for ordinary wear.) A sack coat of dark blue cloth or serge; falling collar; single breasted, with five buttons in front same as those worn on the dress coat; with black braid $\frac{1}{4}$ of an inch wide, extending from each button and button-hole back six inches, and terminating in "herring bone" loops.

The skirt to extend from $\frac{1}{3}$ to $\frac{2}{3}$ the distance from the hip joint to the bend of the knee; and to be slashed at the hip on each side; a knot of black braid, $\frac{1}{4}$ of an inch wide, on the upper part of the cuffs, according to pattern.

The shoulder straps will always be worn with it. Black braid binding, $\frac{1}{2}$ of an inch wide, around edge of coat.

FOR STOREKEEPERS.—Of pattern above described, but without braid.

FOR CHAPLAIN.—Plain black frock coat, with standing collar; one row of nine black buttons up the breast, with "herring bone" of black braid around the buttons and button-holes.

FATIGUE SACK.

On Figures 2, 4 and 10 we give the back, forepart and collar for a fatigue sack. We have not given the sleeve as we had not room for it, but a full description of it is given, as also the mode of trimming, and the reader can draft the sleeve by the measure, according to the system. This sack is close-fitting, and is drafted by the system in the usual way, excepting where it is laid out to be cut down all the way under the arm to bottom for spring, and to give ease over the loins. The breast is cut full, to be wadded in military style, in material which requires it. Figure 2 is the collar, and is adapted for buttoning close up to the neck.

TROUSERS.

FOR GENERAL OFFICERS, Officers of the General Staff and Staff Corps. Dark blue cloth, plain, without stripe, welt or cord.

FOR ALL REGIMENTAL OFFICERS OF CAVALRY, ARTILLERY AND INFANTRY.—Light blue cloth, same shade of color as prescribed for enlisted men, with stripe $1\frac{1}{2}$ inches wide, welted at the edges; color, that of facings of their respective arms, except infantry, which will be dark blue.

STOREKEEPERS.—Dark blue cloth, with black stripe, $1\frac{1}{2}$ inches wide.

FOR CHAPLAINS.—Plain black.

Description of Juvenile Plate.

FIGURES 2, 3, 4, 18 are the diagrams of a little cutaway jacket, laid out to a breast measure of 24, but any size may be cut by our graduating scales, by selecting the scale corresponding with the breast measure. We will now proceed and show how to draft this diagram as a criterion by which to draft all the others.

HOW TO DRAFT BACK, FIGURE 4.—Draw construction line from 0 to $20\frac{1}{4}$, square in top; mark down from 0, 4, $6\frac{1}{2}$, 8, $15\frac{3}{4}$, $20\frac{1}{4}$, square these lines across; mark on top line, $2\frac{1}{4}$, and up for spring $\frac{3}{4}$; mark on top of pitch, $8\frac{1}{4}$; middle of pitch, $7\frac{1}{4}$; bottom, $7\frac{1}{2}$; inside at waist, $6\frac{3}{4}$; bottom, $6\frac{1}{4}$; hollow the back about $\frac{1}{2}$ inch, as model. Form top from 0 to $\frac{3}{4}$; shoulder from $\frac{3}{4}$ to $8\frac{1}{4}$; pitch from $8\frac{1}{4}$ by $7\frac{1}{4}$ to $7\frac{1}{2}$; side from $7\frac{1}{2}$ to $6\frac{1}{4}$, at plait and bottom.

DESCRIPTION OF FOREPART, FIGURE 3.—Draw construction line from 0 at top to $21\frac{1}{2}$ at bottom; mark down from 0 at top, $2\frac{1}{2}$, $3\frac{1}{4}$, $8\frac{1}{4}$, $9\frac{3}{4}$, $16\frac{3}{4}$, $21\frac{1}{2}$, square these lines across, inside and outside; mark outside from $2\frac{1}{2}$, $5\frac{1}{4}$; next from $9\frac{3}{4}$ — $6\frac{1}{4}$; next from $16\frac{3}{4}$ — $4\frac{3}{4}$; outside from $3\frac{3}{4}$ — $6\frac{1}{2}$; outside from $8\frac{1}{4}$ — $1\frac{3}{4}$, and $5\frac{1}{2}$; outside at waist, $6\frac{1}{2}$; at bottom, $7\frac{1}{2}$. Form shoulder from 0 to $6\frac{1}{2}$; side from $5\frac{1}{2}$ by $6\frac{1}{2}$ to $7\frac{1}{2}$; sye from $6\frac{1}{2}$ by $1\frac{3}{4}$ to $5\frac{1}{2}$; neck-gorge from 0 to $5\frac{1}{4}$; and front from $5\frac{1}{4}$ by $6\frac{1}{4}$, $4\frac{1}{4}$, $21\frac{1}{2}$ and $7\frac{1}{2}$.

HOW TO DRAFT SLEEVE, FIGURE 2.—Draw construction line from 0 to 18, 4, 10, $17\frac{1}{2}$; square these lines across; mark outside from 0 at top, $4\frac{1}{4}$, $8\frac{1}{4}$; outside at elbow, $8\frac{1}{4}$; at bottom, $5\frac{1}{2}$; mark inside

from 4, $6\frac{1}{2}$, $7\frac{1}{2}$; square up from $6\frac{1}{2}$ to 7; mark inside at elbow, 8; and at bottom, $5\frac{1}{2}$; form sleeve-head from $\frac{3}{4}$ down from $8\frac{1}{4}$, $4\frac{1}{4}$, 4, $2\frac{1}{2}$, to 7; and the rest of the sleeve by the numbers indicated on the diagram, and finish sleeve by forming the ornament representing a cuff, which is done by a tracing braid. And also form the ornament represented on back and forepart, with the little plait at bottom with 3 buttons. The collar, 18, is drafted in the same way. The little vest, Figure 1, is an accompaniment of the jacket, and is drafted in the way we have been describing, and trimmed as represented by the tracing braid. Figures 8 and 16 are the little breeches accompanying this suit, the trimming of which is in accord with that of the jacket, the points of which the reader will see at a glance. These breeches are drafted in the way we have already described, from the line of construction, by the scale corresponding with the breast measure and the numbers on the diagram. These breeches are suited to any of the other jackets on the plate; the trimming may be omitted or another pattern substituted in accord with that of the jacket.

On Figures 5, 6, 7, we have another style of suit, which is a Highland costume. The sleeve and collar, Figures 2 and 18, are adapted for this jacket also. This jacket is of the Derby style; the line of construction of forepart runs from the point of shoulder, and it has a little false vest attached, which is fastened to the linings inside. It has openings at side

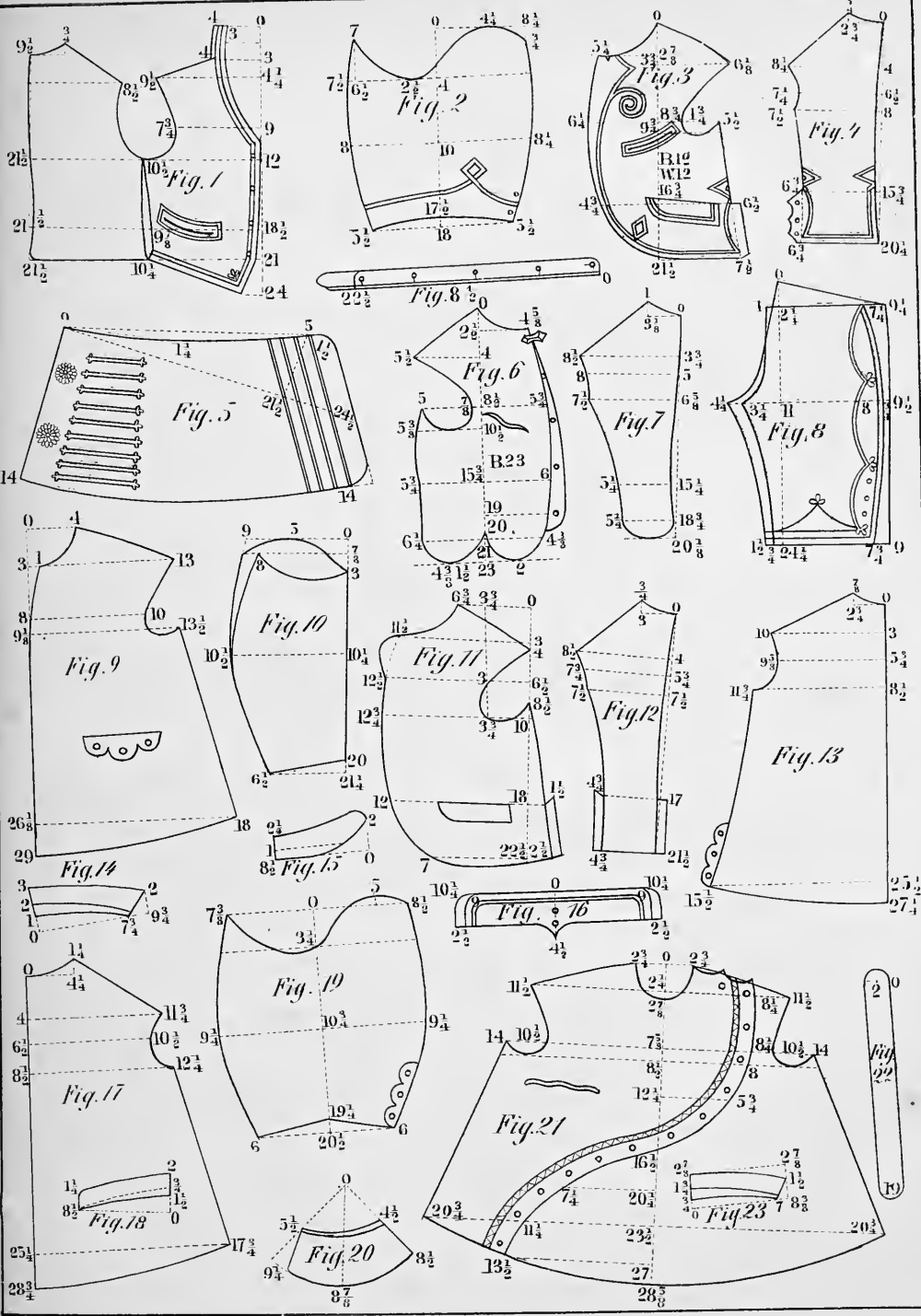



and behind, forming three curves; it fastens with a little tab at the neck. This jacket is drafted in the same way we have described the other. We will describe the way to draft skirt, Figure 5. Draw front from 0 to 14, and draw line on the square to $21\frac{1}{2}$ and $24\frac{1}{2}$, with 3 inches added for the 3 plaits running from 5 at top to 14 at bottom; then square up from $21\frac{1}{2}$ to 5; draw line of waist from 0 to 5; and hollow top to $1\frac{1}{4}$ inches, then draw the line of plait from 5 to 14 by $21\frac{1}{2}$, and add the 3 inches outside, and form the plaits as model; and form bottom according to the same curve as the waist. There should be a band $1\frac{1}{4}$ inches in width, sewed on to the waist, with holes worked in it to fasten to the waistband of Knickerbockers, which is worn underneath. The Knickerbockers are in plate XXIII, and are drafted by the scale corresponding with the hip measure.

On Figures 11, 12, 15, with sleeve 2, we have a very neat style of Derby jacket. This jacket has a plait behind and at side, it has a little curved lapel, and fastens with a tab underneath the lapel. The pockets are at waist, covered with flaps; the vest adapted to this jacket should close higher than Figure 1. Some of these jackets are ornamented with a tracing braid around the edge; this jacket is drafted in the same way we have already described. The little pants, Figure 8, are adapted to this jacket.

Figures 9, 13, 14, 19, are the diagrams

of a loose over sack or blouse, for a child; it has an ornament at side of back, and also on flap and at sleeve hand, with 3 buttons; the collar, 20, is also adapted to this blouse. It is single breasted and buttons up the front either with fly or without. The band, Figure $8\frac{1}{2}$, is also adapted to this blouse; it is drafted in the usual way.

Figures 10, 17, 21, 22, 23, are the diagrams of a diagonal blouse. Figure 17 is the back, and is drafted in the usual way; Figure 21 is the forepart, and should be drafted as laid down in diagram, the construction line in centre, the points outside, not only indicating the blouse, but also the diagonal line where it joins; after the forepart is drafted and the diagonal opening marked, the pattern should be cut around the diagonal line, and enough of material added to the underpart to run from $2\frac{1}{4}$ on point of shoulder in a straight direction to lap about 2 inches at $13\frac{1}{2}$ at bottom; the upper part of shoulder is formed with three points, where it laps underside, and is fastened on shoulder with three buttons and holes, and down the front with 12. Figure 10 is the sleeve, and Figure 22 is the belt which is just half the size, and should be fastened around the middle at waist. Figure 23 is the collar, and is designed to fit close around the shoulder. This blouse should be trimmed all around with two rows of braid $1\frac{1}{2}$ inches from the edge, and $\frac{1}{2}$ inch apart, interlined with one row of tracing braid.

Description of Plate XIX.

FIGURES 1, 2, 5, 8, 9 and 11 are the diagrams of the foreparts of seven different styles of vests to the same back, figure 7.

We will illustrate the manner of drafting by figures 7 and 8, which is a dress vest, with low roll of breast. The measures should be taken for length of vest from socket bone behind down to the length that the vest should be opened, then the full length of front, next breast and waist measure. We will suppose the following measure: length of opening, 16 inches; full length, 25 inches; breast, 18; waist, 16. Draw construction line from 0 to 22, square in top, mark along top $\frac{1}{2}$ breast measure, which is 9 inches, then divide that in 3 parts, or 1-6 and $\frac{1}{3}$ respectively; then mark down from 0, $1\frac{1}{2}$ inches or 1-12th breast measure, and to 6 one-third, and 9 one-half, and to $17\frac{1}{2}$ the length of natural waist, and when you have not got the natural waist, apply half the breast $\frac{1}{2}$ inch less, then apply your measure length of vest from 6, or point of shoulder at top; supposing width of top of back, 3 inches or 1-6; lay the 3 on 6 and apply length of breast down to 9 at bottom, with $\frac{3}{4}$ of inch added for making up; then square these lines across; then mark in from natural waist 1 inch; apply half your waist measure from said inch to front, with $1\frac{1}{2}$ inches in front at natural waist added. 1 inch for making up, and $\frac{1}{2}$ inch for V to $10\frac{1}{2}$, and 9 at bottom; mark $1\frac{3}{4}$ inches in front; draw line of shoulder from 6 to $1\frac{1}{2}$; then apply your measure down to the length of opening on breast, say 18; then draw your front by the $1\frac{3}{4}$ you have established by $1\frac{1}{2}$ to 9 at bottom; then mark up from

22, 3 inches, or 1-6th, and draw bottom of vest from 9 to 19; form your sideseam from 9 by 1 at natural waist; let it be well sprung below natural waist, as model; mark the width of top of shoulder about $5\frac{1}{4}$ inches, and form your syc as model; draw dotted line from 3 at top to $1\frac{3}{4}$ at front of breast, or the length of opening, according to measure; and form the neck-gorge as model; and take out V as represented on forepart. As this vest is designed to open well on the breast, we cut the sewing to part of collar, or stand up, rather straight; and the sewing, too, should be kept a little tight along towards the front, so that when the vest is finished, the crease will be hollow, something resembling the neck-gorge. These vests can be drafted as well by the scale as by divisions of the breast measure; and we should prefer the use of the scale, as in the larger sizes it (the scale) will curtail the size of the vest to the dimensions required, and it is more convenient. But at the waist, the real measure should be applied, so as to give it sufficient width at this part, no matter how small the waist measure may be, the front of vest should never be brought inside of the point 9 at bottom, but the extra material should be taken out as V; this is found necessary to prevent the vest raising up in front. In cases where the scale is used for cutting a garment for a tall and slim man, a scale a size larger should be used for the lengths than for widths; and if drafted by divisions, the bottom of syc and natural waist should be lengthened in proportion to the length required. Figure 1 is clerical or English style of vest, and is drafted in the same manner as Figure 8,

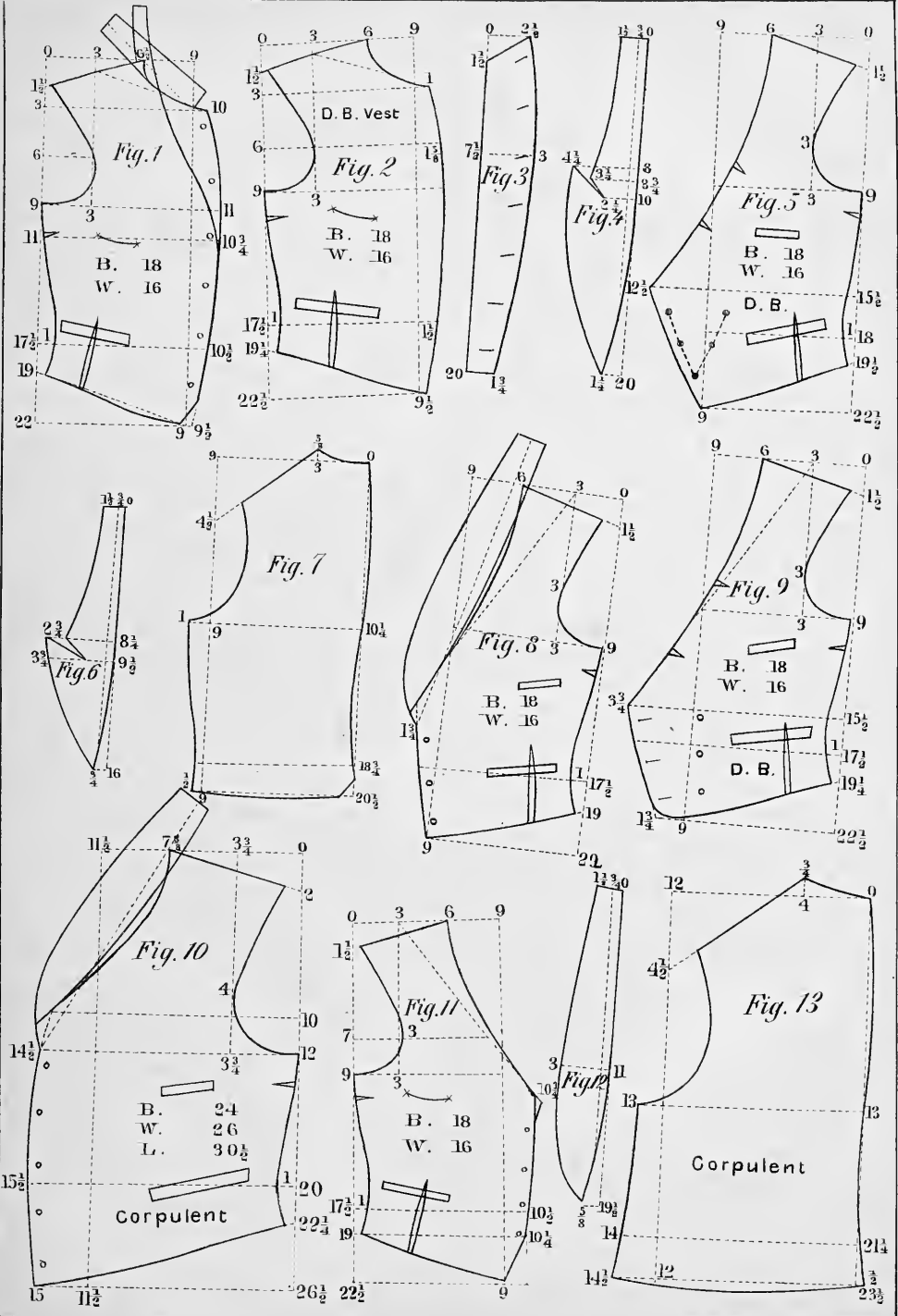



with the following exception : that 3 graduated inches, or 1-6th, is marked down from 0 to locate the front of neck-gorge, and there is 1 inch added in front of line at neck to 10, and 2 inches at front of breast to 11. At this point we vary from $1\frac{3}{4}$ to $2\frac{1}{4}$ in proportion to the chest of the customer ; the collar should be cut to fit the gorge, according to model.

In this diagram we also represent a vest of the straight form, without collar, which is usually called the French style of vest. The reader will at a glance see the points of this vest. There is a little collar behind, represented by the long curved piece, which is designed to give spring to this part of the neck gorge; the points of front of breast are indicated by the numbers on the diagram, marked 11 behind, and $10\frac{3}{4}$ in front. How to draft back, Figure 4 : draw construction line from 0 to $20\frac{1}{2}$, square in top ; mark down from 0, $10\frac{1}{4}$ inches, which should be from 1 to $1\frac{1}{2}$ inches more than from 0 to 9 at bottom of syc on forepart, one inch for the fair proportioned, and one and a half for the stooping ; mark on top 3 inches, or 1-6 for width of top of back, and then 9, or half breast ; then draw line from 9 to bottom on the square ; mark down said line 4 inches, or $\frac{1}{2}$ breast measure, less half inch ; this should be raised up or down in proportion to high or low shoulders, then mark inside at bottom of syc, 1 inch, for making up, to 10, and give $1\frac{1}{2}$ inches at bottom, over half waist ; mark length of side of back by that of forepart ; raise spring of top $\frac{5}{8}$ from 3, and form back as model. Figure 5 is the diagram of a double-breasted vest, and is drafted in the same way, with the following exceptions : the point of neck-gorge in front is established by placing the line 3 inches or 1-6th from top, the front of breast is placed at 1 inch and $1\frac{5}{8}$, $1\frac{1}{2}$ and $9\frac{1}{2}$ at bottom, respectively, but may be diminished in proportion to the size of chest, the width of lapel is placed

at $2\frac{1}{2}$, 3, $1\frac{3}{4}$, respectively, and the front of vest should be formed by those points; the collar should be cut square. Figure 9 is a double-breasted vest of the shawl form. The diagram indicates the points of difference from the single breast ; in front of breast there is $1\frac{1}{4}$ inches more for single breast, and $1\frac{3}{4}$ is added at top for the double breast, making in all $3\frac{1}{2}$; and at bottom $1\frac{3}{4}$ is added for the double ; and front of breast is formed in accordance with these points ; the collar should be fitted to the neck as represented on Figures 8 and 10.

Figures 10 and 13 are the diagrams of a corpulent man's vest, and is drafted in the same way as Figure 8, only the roll of breast being much higher. It is drafted to a breast measure of 24, waist 26, length $30\frac{1}{2}$. At natural waist, where it is marked 1 inch into sideseam, this point in vests should be marked 1 graduated inch, and the waist measure should be applied from sideseam to $15\frac{1}{2}$ at front, with 1 inch added, there being no V required in such vests, no allowance is made for it ; the front of breast on line at bottom of syc is placed at $3\frac{3}{4}$ to $14\frac{1}{2}$; and the front of breast is formed in accordance with these points. The back, Figure 13, is drafted in the same way as Figure 7, excepting the additional width at waist required by the measure.

Figures 6, 7, 11, are the diagrams of a single-breasted vest. Either of the collars Figures 6 or 12, are suited to this forepart, and represent two different styles of vest, —a collar of the shawl form, as represented on Figure 12, would give one style, or high-roll of the shawl form ; the other a pointed lapel ; the collars are drafted with the scale, as the entire vest may also be.

On Figure 5 we have another style of double-breasted vest, which is formed by the buttons running to a point at bottom, in the shape of a V, about $2\frac{3}{4}$ inches up from bottom, and leaving an opening at bottom when buttoned, of 2 inches. The collars, Figures 4 and 12, are adapted to either of these vests, and thus producing either a vest of the pointed lapel form on the one hand, or the shawl form on the other, by the change of collar.

Description of Plate XX.

FIGURE 1 is a diagram representing the measurement of pantaloons. How to take measure: Put the top of your measure in at the hollow of waist above the hip bones, and apply the measure down to knee, which we will suppose $23\frac{1}{2}$ inches, then to bottom of side 42 inches, we will then take measure of leg by putting measure close up into fork (unless you use an instrument for the purpose), and then apply the measure right down the side to what you think is the proper length, bring the measure also to the upper part of foot, which is usually a good criterion to judge of the proper length, say 32 inches, then apply waist measure around at the hollow of waist, and hip measure at the most prominent part of hips. (In corpulent men we take three measures, waist and one at the most prominent part of stomach, and one at the hips.) We will suppose the waist and hip measure respectively 16 inches and 19. In tight pants we take the thigh measure, dress and undress, and give the proper allowance for making up,—say, dress side $11\frac{1}{2}$, undress 11, knee $8\frac{1}{2}$, bottom $8\frac{1}{2}$ or according to fashion, elliptic, which should be taken on dress side; from the exact point you started for side seam, draw the measure right through the fork and right over hip to the same point you started, say $33\frac{1}{2}$, and allow $1\frac{1}{4}$ inches in its application, $34\frac{3}{4}$.

We will now commence and draft Figure 2. How to draft upper side: Draw construction line from 0 to 42, square in top, then mark down from 0, $23\frac{1}{2}$ inches, and 42

or full length; there should be $\frac{1}{4}$ inch added for making up, then mark up from bottom 32 inches with $\frac{1}{4}$ inch added, or leg seam, to 10, which makes line of fork, square those lines across, mark outside on this line from 10, $9\frac{1}{2}$ inches, or half hip measure, then mark inside from 10, $\frac{1}{8}$ the hip measure, which is $2\frac{3}{8}$, which we have marked on diagram $2\frac{1}{2}$, and also 1-6 to $3\frac{1}{8}$, then divide the distance from 10 to $2\frac{1}{2}$, which is $1\frac{1}{4}$, then divide the $1\frac{1}{4}$ which is $\frac{5}{8}$, and draw line from the $\frac{5}{8}$ to top, then add the $3\frac{1}{8}$, and half hip measure, $9\frac{1}{2}$ and $3\frac{1}{8}$ together, making $12\frac{5}{8}$, then mark in from $9\frac{1}{2}$ at side one half of the $12\frac{5}{8}$ or $6\frac{1}{4}$; and also $\frac{1}{2}$ the width of upper side at bottom marked $2\frac{7}{8}$, which is $3\frac{5}{8}$, $\frac{3}{4}$ inside to $2\frac{7}{8}$ or $3\frac{5}{8}$, and draw centre line from $2\frac{7}{8}$ at bottom by $6\frac{1}{4}$, then mark outside from 0 at top half waist 8 inches and half hip $9\frac{1}{2}$, mark outside from centre at knee $4\frac{1}{4}$ inches, and inside of construction line 1 inch or 4 from centre; then mark width of upper side at bottom, $3\frac{5}{8}$ inches on either side of centre, draw line from $1\frac{1}{4}$ at fork to 42 at bottom, then mark the curves of upper side at fork to $2\frac{1}{2}$ and $3\frac{1}{8}$ as represented, and side from 8 by $9\frac{1}{2}$ — $4\frac{1}{4}$ to $6\frac{1}{2}$, and bottom as model, then drop the line down $\frac{1}{2}$ inch from 0 at top, which is required in small waists, and finish upper side.

How to draft under side, Figure 3.—Lay on upper side as Figure 2, mark line of top out to 10, and line of fork to $4\frac{3}{4}$, to $4\frac{3}{4}$ is $\frac{1}{4}$ of hip from construction line at 10, then sweep from 8 to $3\frac{3}{4}$ by $2\frac{1}{2}$ at fork; mark inside at knee from construction line

Measurement

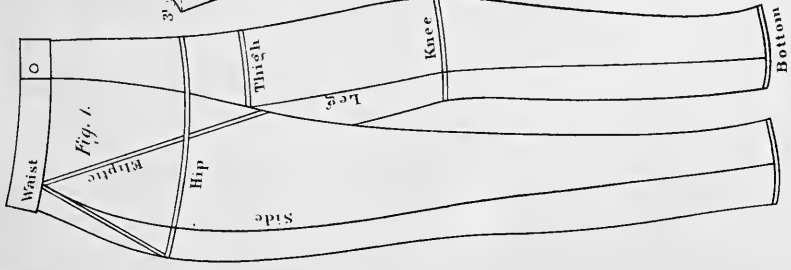
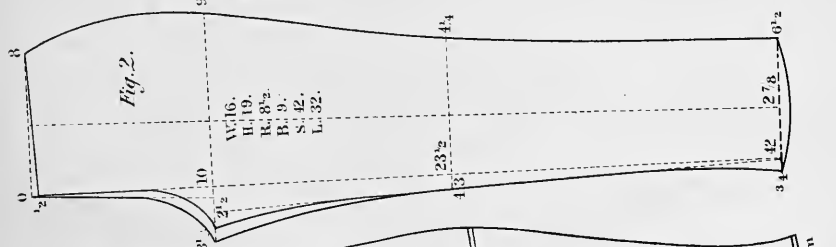
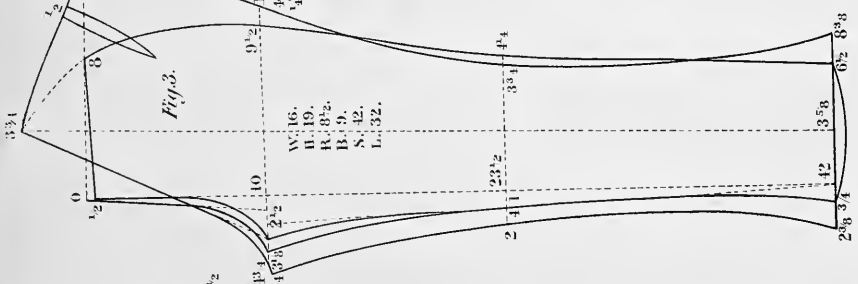

Fig. 2.



W. 16.
H. 19.
R. 8 1/2.
B. 9.
S. 42.
L. 32.

Fig. 3.



W. 16.
H. 19.
R. 8 1/2.
B. 9.
S. 42.
L. 32.

Fig. 4.

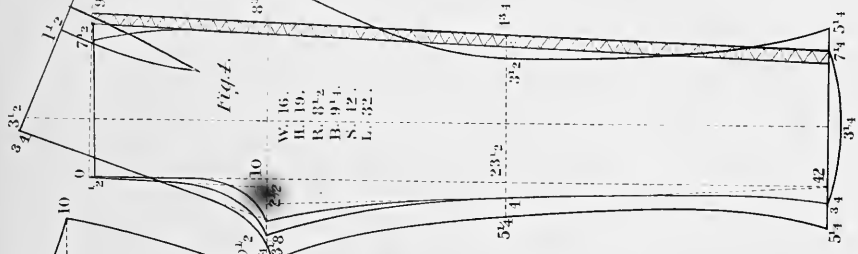

W. 16.
H. 19.
R. 8 1/2.
B. 9 1/2.
S. 42.
L. 32.

Fig. 5.

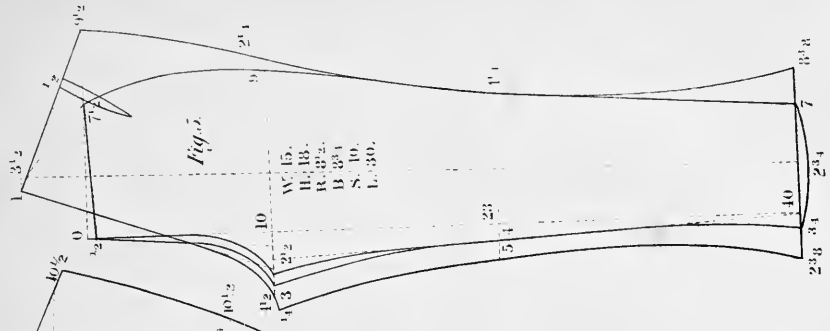

W. 15.
H. 18.
R. 8 1/2.
B. 8 3/4.
S. 40.
L. 30.



2 inches or 5 from centre, and outside $3\frac{3}{4}$ or $8\frac{3}{4}$ added to width of upper side $8\frac{1}{4}$ making width at knee 17 inches, mark inside at bottom from 42 $2\frac{3}{4}$ and outside $8\frac{3}{4}$, amounting to $10\frac{3}{4}$, and one half on each side from centre line, $10\frac{3}{4}$ added to $7\frac{1}{4}$ of upperside, making in all 18 inches; then apply waist measure from 0 to 8 and from $3\frac{3}{4}$ to 10 at side; take out V of $\frac{1}{2}$ inch, and thus allow $1\frac{1}{2}$ inches for making up; apply hip measure from where the line of seat crosses front across to side, allowing from $2\frac{1}{4}$ to $2\frac{1}{2}$ inches for making up as to $10\frac{1}{2}$; and then form top and side as model; draw seat line from $2\frac{1}{2}$ at fork to $3\frac{3}{4}$ at top and form your underside out to $4\frac{3}{4}$, and leg from $4\frac{3}{4}$ by 2 to $2\frac{3}{4}$ at bottom, and form bottom according to model.

Figure 3 is drafted in the same way we have described, excepting the side, which represents a side stripe. In such cases allow 1 inch to be taken out as V from $7\frac{3}{4}$ to side stripe at 9, and allow 1 inch to 9, and give 1 inch additional width to upper side at bottom; draw your side seam with a straight line from 9 to $7\frac{3}{4}$ at bottom, then whatever you have taken off from upper side at $8\frac{3}{4}$ should be added to under side

to $10\frac{1}{2}$, and also apply the seat measure and eliptic as we have described in Fig. 1, and form your under side by the measures. We recommend dropping the under side below the line of fork about $\frac{1}{4}$ inch, as represented in Fig. 1, and stretched to that amount to make the pants sit clear of any creases at this point. We have drawn the line of seat $\frac{3}{4}$ of an inch inside of centre line behind and advanced the point of side to $10\frac{1}{2}$; the object of this is twofold, namely, to take away all creases that might exist under the seat behind and also to take out the surplus material and avoid having too much round at the side.

Figure 5 represents a man with small hips. The eliptic is small, being at $32\frac{1}{2}$, and thus throwing the line of seat well back. Men of this build are flat behind, and round at side, having very prominent loin bones, which requires a good deal of round on this part of pants. These pants are drafted to the following measure—waist 15, hip 18, knee $8\frac{1}{2}$, bottom $8\frac{3}{4}$, side 40, leg 30; these pants are cut wider at knee than the others in proportion. There is nothing more in these pants calling for comment different from that we have given.

Description of Plate XXI.

FIGURE I is the diagram of a corpulent man's pants of the pot-bellied form, or one who has his corpulency pretty well developed in front; which is generally indicated by the appearance, but always discovered more essentially by the application of the elliptic measure, which is always more in the build which carries his thickness all around, than that of the pot-bellied structure. The waist and hip is put down at the same figure, 24 inches each; knee 11, bottom 10, side 44, leg 31. (We perceive that our engraver has substituted the letter R for that of K in all these diagrams, which was meant to indicate the knee.) We lay it down as a principle in the measurement of pants that in the proportionate structure there is always found a difference of 3 inches between waist and hip, thus 16 and 19 are supposed to be a medium fair proportioned structure; in stout builds we will suppose it at 2 inches, and when the waist is large in proportion to the hips, as in the present case, we have laid it down as a maxim, and it is found to be generally correct in practice, to give two parts of the extra material to the front and the other to the side. In the present measure, according to this principle, the waist is 2 inches larger than fair proportion, which would require $1\frac{3}{4}$ inches given to the front, and the balance behind; but there are exceptions to most of rules, and in the application of elliptic measure we discovered that the extra material should all be in front, and was much

better adapted to these pants. It should also be raised $\frac{3}{4}$ as much at top as it is advanced in front, and is therefore advanced 2, and raised $1\frac{1}{2}$; the top we curve a little and have it confined in a little for making up, so as to straighten it, as the prominent part of the thickness or roundness of stomach is usually about 3 inches lower down, which we have given $2\frac{1}{4}$, marked on diagram, and thus throw the fullness to this part; and in forming the front, we curve it so as to give more width about 3 inches down, and carry it gradually into a hollow towards the fork. Indeed, we would advise taking a second measure here, in extreme cases, three inches below the waist, and if found to be $\frac{1}{2}$ inch wider to add said $\frac{1}{2}$ inch to the round of front 3 inches below. In these pants the elliptic measure is applied, and $1\frac{1}{2}$ inches added, establishing the point at $16\frac{1}{4}$, and making the width of top $13\frac{1}{4}$ inches, including the 1 inch behind, from $3\frac{3}{4}$. But the question may be asked, if the elliptic measure is essential? and suppose it to be correctly taken, how could it apply in establishing the corpulency correctly in front? The answer is: the elliptic measure being short at $16\frac{1}{4}$, in proportion to the waist measure, this shortness proves that the stoutness must go to the front, where the elliptic does not apply. And observation going to confirm this opinion, it is found to be a safe rule of practice. The other portions of these pants are drafted the same way we have explained elsewhere.

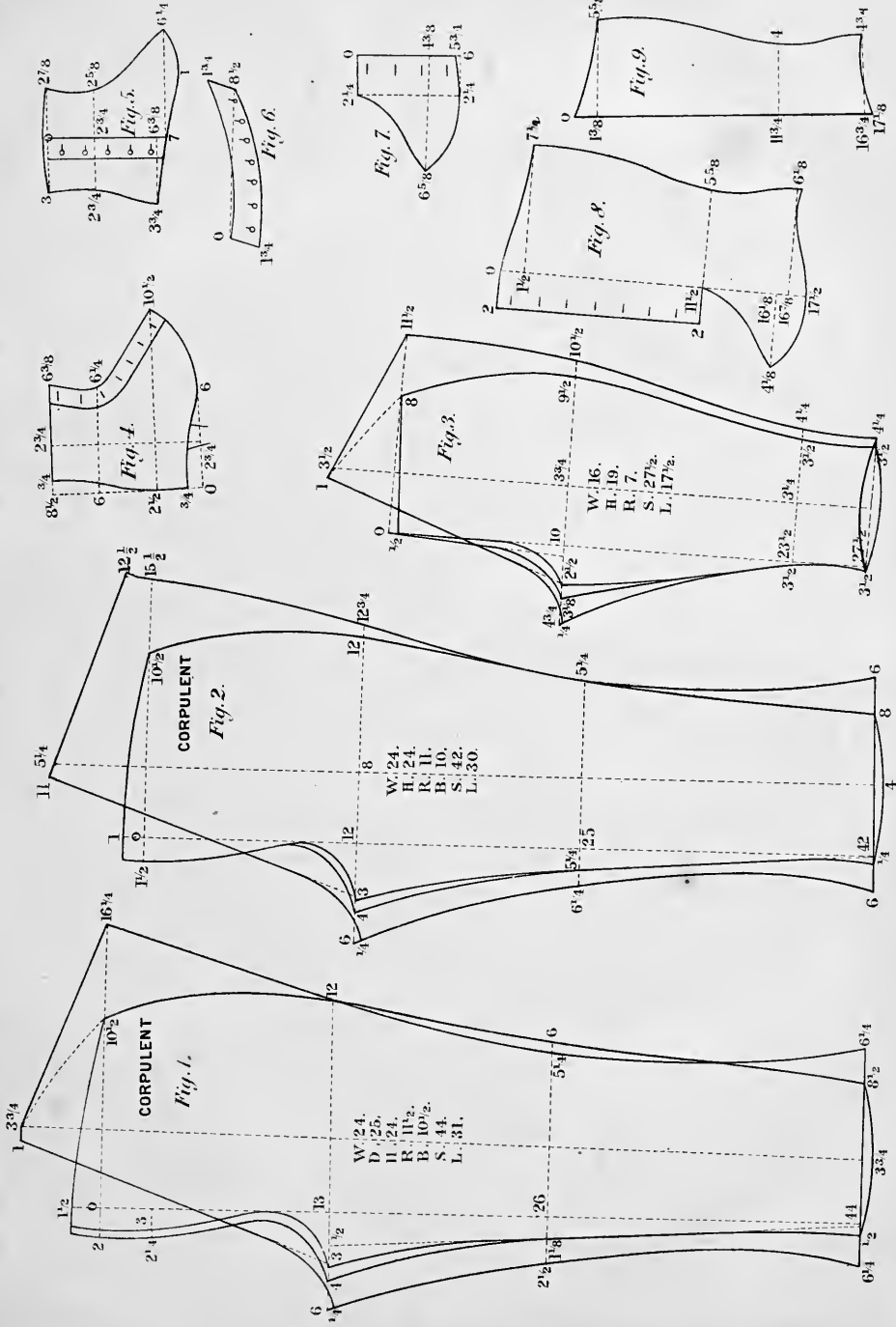



Figure 2 is a corpulent man's pants, and are cut full falls. The measure is similar to that of Figure 1; the length of side is 42; leg 30; waist 24; hip 24; knee 11; bottom 10; the width of top to 12½ with 1 behind and 12 top of front, is waist measure, with 1½ added for making up. They are drafted in the same way as the others, excepting being raised 1¾ inches up from 15½ at top, for the full falls. In these pants there is ⅔ given to the front and ⅓ behind, marked 1½ at front and raised 1 at top; the underside is dropped at fork ¼ inch below the line, and should be stretched to that amount. In these pants there should be 1½ inches extra given at top for making up, and 3 extra allowed in the application of hip measure; the fall bearer should be cut to raise 1¾ inches higher than fall, and to have a vent about 4 inches down the side; and should be cut ½ inch wider than fall, for the purpose of buttoning in front. In the widths of corpulent men's pants all extremes should be avoided, as that of a medium width is entirely more becoming.

Figure 3 is the diagram of a pair of knee breeches to the following measure: waist 16, hip 19, knee 14¼, side 27½, leg 17½. These breeches are cut for a waistband, but can be changed to full falls by adding 1¾ inches at top, as represented on Figure 2; they can also be cut the old frog mouth style, by cutting a fall in from 0, about 5 inches in length, and 2 in width at top, and 2½ wide at bottom inside, from upper side, and to raise 1 inch higher than 0 at top; and should have a welt sewed on to the

slit and made up ½ inch in width, with a fall bearer underneath to button in front. At the bottom half the width of knee is given each way from the centre; 23½ is the knee, and 27½ is the bottom; they are gently hollowed from knee to bottom, both inside and outside; and the upper side is gently curved around the bottom, and the under side slightly hollowed. They should have a welt sewed on and made up about ⅝ of inch wide, and a vent about 4 inches long at side, with 4 buttons and holes.

Figure 4 is a gaiter, the length of which is 7¼ inches; this gaiter opens down the front; the slash in front marked Figure 6, has the hollowed part from 0 to 1¾ joined to front, from 6¾ to 10½. For buttoning, it should be fullled on a little at 6¼; it has 7 holes and buttons down the front. It is drafted by the scale corresponding with the breast measure.

Figure 5 is another style of gaiter, and closes at the side with 5 holes; this gaiter is 7 inches in length. It is drafted in the usual way, from the line of construction which runs down the centre. A measure should be taken at the top, neck, and heel of the gaiter, and applied with sufficient allowed for making up.

Figures 7, 8, 9, is the diagram of a pair of leggings or long gaiter. The length of this legging is 17½ inches. Figure 9 is the outside and 8 the inside, 7 is the tongue. The outside from 5⅝-4 and 4¼, joins the inside from 7½-5⅝ to 6¼; and the tongue, Figure 7, is joined from 2¼-6⅝ to 11½ and 4¼, and 0 to 2.

Description of Plate XXII.

WE will commence our description of this Plate with Lady's Habit, as laid down by the system.

Figures 4, 5, 6, 7, 9, 12, 13, 14, are the diagrams of a lady's habit, or rather, four different styles produced by four styles of skirts. This habit is laid down by the system, but has the numbers placed so that it can also be used by the scale. It is drafted to the following measure: diameter lengthwise $4\frac{1}{4}$, crosswise $3\frac{1}{4}$, shoulder measure $11\frac{1}{2}$, blade $15\frac{1}{2}$, syc measure 10, elliptic 11, depth of syc on back $7\frac{3}{4}$, natural waist 14, full length 15, length of skirts $24\frac{1}{2}$ and 28 respectively, breast 17, waist $11\frac{1}{2}$. How to draft back: draw back line from 0 to $24\frac{1}{2}$ the, bottom of syc and natural waist is marked in the same way as frock coat, and the diameter lengthwise applied in the same way; there is $\frac{1}{2}$ inch added to the width of back for making up, as there is no seam under arm, and also in conformity with the principle that ladies' habits or basques require to be cut as wide in back and shoulders as possible, we have also added $\frac{1}{4}$ inch to the diameter of syc, as an allowance for light or very heavy material; the other points of the back are indicated by the numbers on diagram. Figure 12 is the forepart, and is laid out by the measures,—the shoulder, blade, and syc measure being applied in their respective places, and the location of shoulder established by the line depth of shoulder being placed on the centre line, and the application of blade measure the same as frock. In the application of the waist measure the fishes should be taken out in proportion to waist meas-

ure to $17\frac{1}{4}$, and $17\frac{1}{2}$; in half-breast measure it should be hollowed a little from $17\frac{1}{4}$ to $17\frac{1}{2}$; the front is only adapted to close with hooks and eyes; as there are some which close with holes and buttons, $\frac{3}{4}$ of an inch extra should be added in such cases. Figure 9 is the sleeve; it is of the tight-fitting style, and is drafted with the scale by the numbers on the diagram or by the system. Figures 4, 5, 6, represent four different styles of skirt adapted to the same forepart. On Figure 6 is the postilion skirt, very narrow at front and sides, and of moderate length behind. On Figures 4 and 5 are two different styles of skirted habits or basques, the one rounded off and the other pointed. Figure 14 is the train or long skirt. We merely represent the top or width in this diagram. It consists of $2\frac{1}{2}$ breadths of cloth; the line from 6 downwards is the fold of the first breadth, which is sloped off 6 inches in front, graduating to nothing at the seam; the half breadth is placed at the right side; for small sizes 2 breadths may be used instead of $2\frac{1}{2}$. The length is usually ruled according to fashion, but as a general rule it should be 15 inches in front and 24 behind, longer than the skirt of a dress. It is plaited on a waist-band, which fastens by hooks and eyes.

Figures 1, 2, 9, 12, are the diagrams of a basque, which is drafted to the same measure as the habit we have described, excepting the syc measure, which is $\frac{1}{2}$ inch more, or $10\frac{1}{2}$. This basque closes with hooks and eyes down the front, but can be closed with holes and buttons, by an ad-

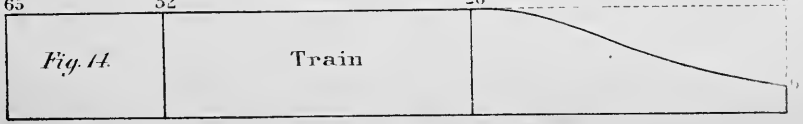
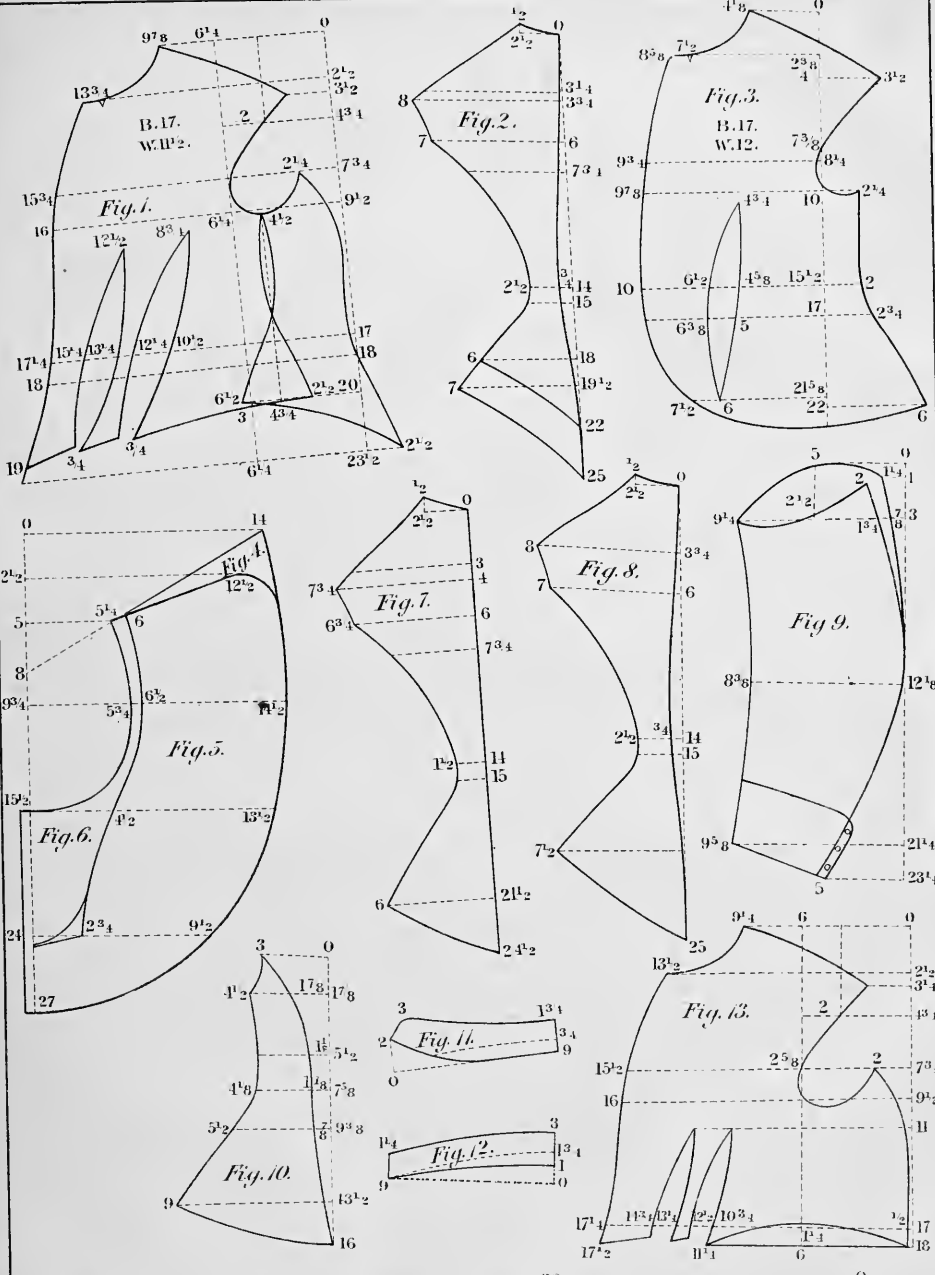



ditional $\frac{1}{2}$ inch added to front. It can be drafted either by the system or the scale corresponding with the breast measure. In the forming of this basque, at waist, the measure should be applied across, as to $17\frac{1}{4}$, back included to $17\frac{1}{4}$; and fishes taken out commensurate with the requirements of the waist measure; an allowance of from $3\frac{1}{2}$ to 4 inches should be allowed for seams and making up, and the balance should be taken out as fishes. The spring at waist under arm commences at natural waist, or $1\frac{1}{2}$ inches above the line, and is about 4 inches at bottom, as from $2\frac{1}{2}$ to $6\frac{1}{2}$; but a larger amount may be required, and in order to meet this emergency, a measure may be taken over the prominent part of

the loins, and an extra allowance as described above applied, and spring given to correspond. This basque is marked $11\frac{1}{2}$ at waist, but would make up $12\frac{1}{2}$; the collar 12, and sleeve 9, is suited to this basque.

On Figures 3, 8, 9, 10, 11, are the diagrams of a very neat style of basque, and to the same breast measure as the others; it is designed to have a short roll of breast, and a step with curved fronts; it may also have a flap at waist when required. This diagram is laid down to be drafted by the scale, and the reader will perceive its points at a glance, and draft it by the scale corresponding with the breast measure.

Description of Plate XXIII.

ON Figures 1, 2, 3, 5, 6, are the diagrams or system for cutting a shirt, and is laid down to the following measure: neck $15\frac{1}{4}$, sleeve $31\frac{1}{2}$, breast 36, waist 33, length of front 35, length of back 37, length of bosom 8. Figure 1 is the sleeve, 2 the back, and 16 the front, 5 the neck band, 6 the wrist band, 7 the yoke. When cut to measure the lengths should be applied by the inch tape, and the other points by the scale corresponding with the breast measure; this shirt is cut whole at front having a bosom inserted from $2\frac{1}{2}$ to 17, and closes behind with an opening marked by a line inside, and marked about $12\frac{1}{2}$ inches down, and closes behind with two holes and buttons. How it is joined together: the point of yoke $5\frac{3}{4}$ and 2 is joined to shoulder at $2\frac{7}{8}$ and $8\frac{3}{4}$, and also from $\frac{3}{4}$ and 0 to 0 and $11\frac{1}{4}$ on back, which should be felled on to back, the joining at side will be understood at a glance. The back arm of sleeve at 0 joins to back at $11\frac{1}{4}$; the point of neckband at 0 joins to $8\frac{1}{4}$ on yoke; all the other points of the diagram are well defined.

Figure 4 represents a little pair of knee breeches, full tops, which should be plaited into a band like Fig. 10, plate XVIII; these breeches are drafted from the line of construction by the scale corresponding with the seat measure. Figure 9 is a pair of Knickerbocker breeches drafted to the following measure: waist 16, hip 19, side 32, leg 22; the bottom should be confined in by a piece of India rubber; the points of bottom are drafted by the scale, and the other portions by the system as described on Figs. 2 and 3, plate XX.

On Figures 8 and 10 we have two different kinds of sleeves, drafted on two different principles, and the reader can adopt

that which he thinks the best. How to draft Figure 8: Draw construction line from 0 to $32\frac{1}{2}$; to 20 is elbow; square the line across from 3 to $8\frac{1}{2}$; to $8\frac{1}{2}$ is half the syc measure; divide the syc measure in two, to $4\frac{1}{4}$; then divide the $4\frac{1}{4}$ in two, to $2\frac{1}{8}$; square up line to $4\frac{1}{4}$ at top; then sweep from $4\frac{1}{4}$ at top by $2\frac{1}{8}$ to 0; draw hair line from 0 to $8\frac{1}{2}$, divide said line say $4\frac{1}{2}$; then square down the line to 3, or $\frac{1}{3}$ the distance from 0 to $8\frac{1}{2}$, and sweep from $4\frac{1}{4}$ at top to $8\frac{1}{2}$, by 3; draw hair line of forearm, from $8\frac{1}{2}$ to $8\frac{1}{2}$ at bottom; sweep from $32\frac{1}{2}$ to $8\frac{1}{2}$ by 0; mark width of cuff from $8\frac{1}{2}$ to $5\frac{1}{2}$; add $\frac{3}{4}$ outside at elbow; and form forearm by $7\frac{3}{4}$, from $8\frac{1}{2}$ to $8\frac{1}{2}$; and outside from 0 by $3\frac{3}{4}$ to $5\frac{1}{2}$, and underside as model.

HOW TO DRAFT SLEEVE, FIGURE 10.— Draw line from 0 to $26\frac{1}{2}$; to 14 is elbow; square in top measure around your syc, say $16\frac{1}{2}$; half of which is $8\frac{1}{4}$; mark down from 0 the half of that, or $4\frac{1}{4}$; square said line across to $8\frac{1}{4}$, and also the line 14; establish the centre of sleeve at $4\frac{1}{4}$, and square it up to top; then measure the distance from the middle of your back pitch when joined to bottom of syc, say 1 inch for half pitch, and $2\frac{1}{4}$ from sidepoint to bottom of syc, added together, making $3\frac{1}{4}$ from $4\frac{1}{4}$ to 1 up at top of sleeve; then form sleeve-head from 1 by $\frac{1}{2}$ — $4\frac{1}{4}$ and $\frac{1}{2}$ to $8\frac{1}{4}$ at forearm to $\frac{1}{2}$, is half the distance to $4\frac{1}{4}$; from front line to $\frac{1}{2}$ at top, is where sleeve-head should touch the line; draw hair line from $8\frac{1}{4}$ to $8\frac{1}{4}$ at bottom; sweep from $26\frac{1}{2}$ to $8\frac{1}{4}$ by 0 at top; mark width of bottom to $5\frac{1}{2}$; mark forearm seam $\frac{3}{4}$ inside from line, and outside at elbow $\frac{3}{4}$; form forearm from $8\frac{1}{4}$ at top, by $\frac{3}{4}$ to $8\frac{1}{4}$ at bottom, and backarm from 0 by $\frac{3}{4}$ to $5\frac{1}{2}$, and underside as model.

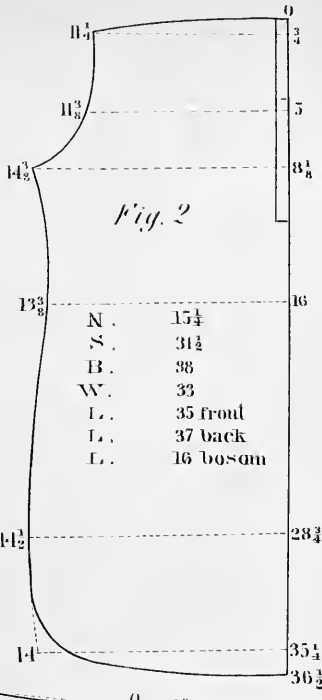

N.	15 1/4
S.	31 1/2
B.	38
W.	33
L.	35 front
L.	37 back
L.	16 bosom

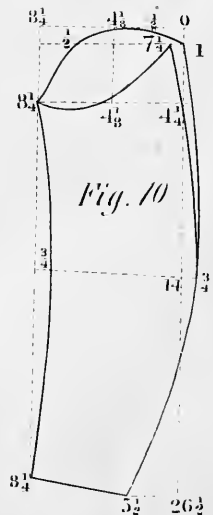
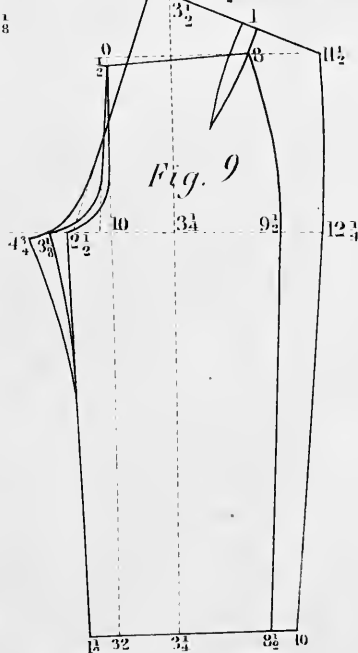
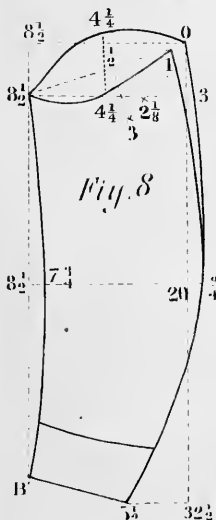
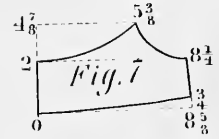
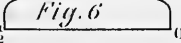
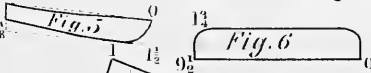
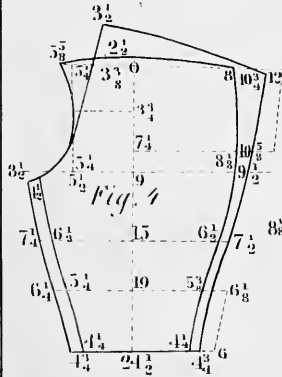
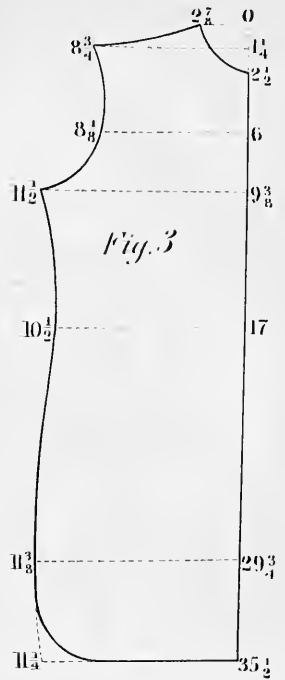

INDEX

Introduction	1
Chapter I	10
Chapter II	25
Chapter III	40
Chapter IV	55
Chapter V	70
Chapter VI	85
Chapter VII	100
Chapter VIII	115
Chapter IX	130
Chapter X	145
Chapter XI	160
Chapter XII	175
Chapter XIII	190
Chapter XIV	205
Chapter XV	220
Chapter XVI	235
Chapter XVII	250
Chapter XVIII	265
Chapter XIX	280
Chapter XX	295
Chapter XXI	310
Chapter XXII	325
Chapter XXIII	340
Chapter XXIV	355
Chapter XXV	370
Chapter XXVI	385
Chapter XXVII	400
Chapter XXVIII	415
Chapter XXIX	430
Chapter XXX	445
Appendix	460
Bibliography	475
Index	490

INDEX.

	Pages		Pages
How to measure.....	6-9		
Figure 1, depth of Proof Centre and of sye on back and natural waist and blade measure, with Measuring Square.			
Figure 2, diameter lengthwise with Centre Point.			
Figure 3, diameter crosswise.			
Figure 4, shoulder, sye, and elliptic measures.			
Figure 5, depth of sye on back and natural waist, taken with the inch measure.			
Figure 6, breast and waist measure.			
Figure 7, illustrating Measuring Square.			
Figure 8, establishing centre all through.			
How to draft Double-breasted Frock Coat and how to apply the measures. Plates II and III	10-12		
Single-breasted Frock, and how to draft Sleeve and Skirt, with Dress Coat, and showing how to use the system without Measuring square.....	Plate IV. 13-15		
Three styles of New York Walking Coat of the Single and Double-breasted form.....	Plate V. 16, 17		
Single breasted Coat of the Register form, with English and New York jackets..	Plate VI. 18-20		
New York Surtout with lapel growing, and with lapel sewed on.....	Plate VII. 21, 22		
Single-breasted Sack Coat, and how to draft.....	Plate VIII. 23		
Two styles of Double-breasted Jacket with a Reefer.....	Plate IX. 24		
Double and Single-breasted Sack Over Coats.....	Plate X. 25, 26		
		Description of two styles of corpulent men's Coats, of the pot-belly and corpulent (all around) structures, with two styles of the stooping structure with high shoulder.....	Plate XI. 27-30
		Description of Garrick or Inverness Cloak with sleeve and without.....	Plate XII. 31
		Description of King William Cloak with sleeve.....	Plate XIII. 32
		Description of King William Cloak without sleeve.....	Plate XIV. 33
		Description of Half and Three-Quarter circular Cloaks.....	Plate XV. 34
		Description of Military Cloak and Coats.....	Plates XVI and XVII. 35-37
		Description of children's suit dresses, cutaway jacket with short breeches, Derby jackets, diagonal blouse, with over-sack.....	Plate XVIII. 38, 39
		Description of Vests, and how to draft.....	Plate XIX. 40, 41
		Description of pants, and how to measure and draft them, tight fitting, with side stripe, with large hips, also small hips..	Plate XX. 42, 43
		Description of corpulent men's Pants, two styles, with knee breeches, long gaiters and short.....	Plate XXI. 44, 45
		Description of two styles of Lady's Basques and Habits.....	Plate XXII. 46, 47
		Description of Shirt system with two styles of Breeches, and two styles of Sleeves.....	Plate XXIII. 48







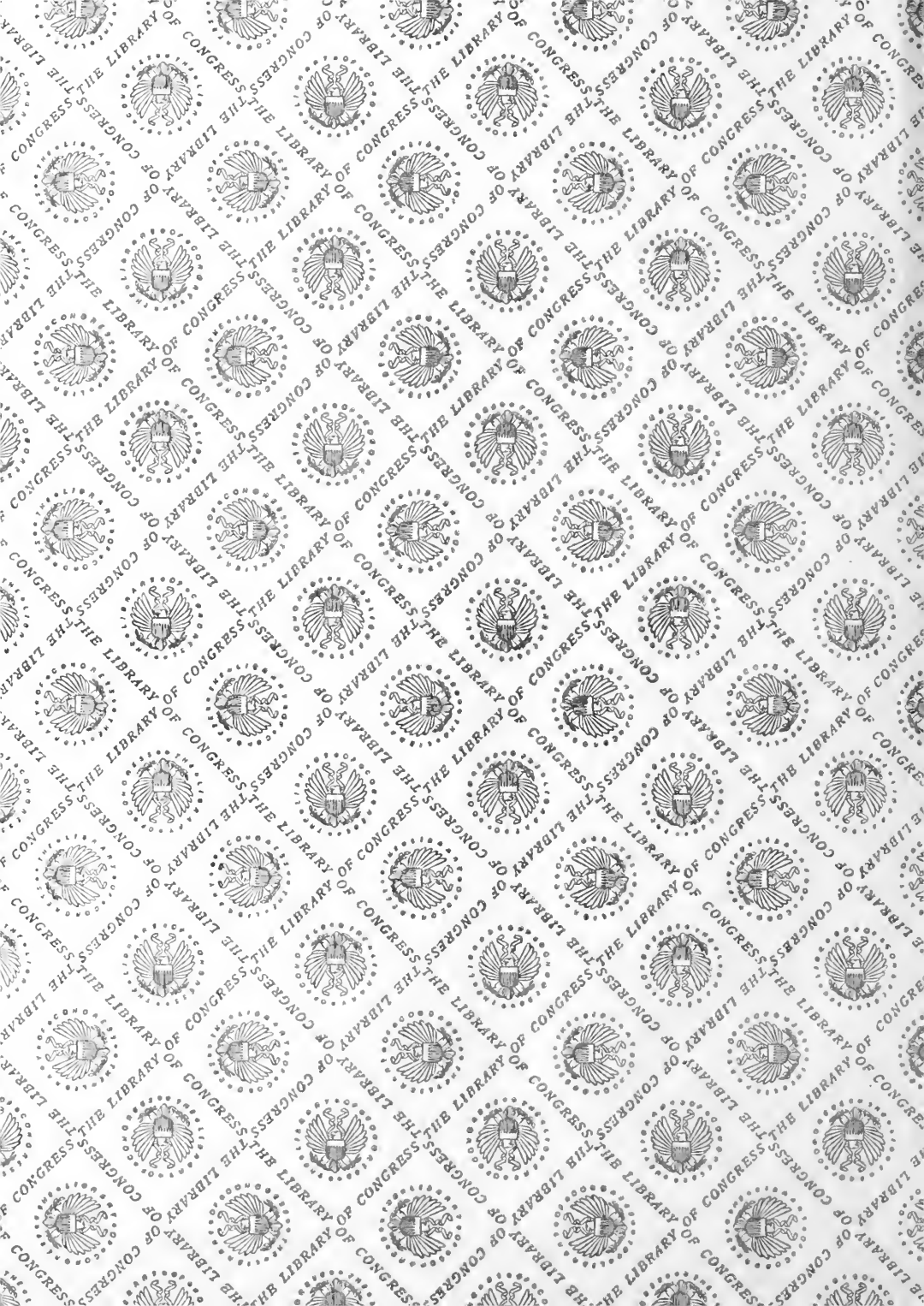



LIBRARY OF CONGRESS



0 014 061 986 3