

73 Magazine

for Radio Amateurs

- 42 **CB-to-10 FM Continued**
—another way to join the fun on
29.6..... **WB2EQG**
- 47 **Sunspot Predictions for 1980**
—whither propagation?..... **WA3NKP**
- 50 **An End to Dials and Meters?**
—nope... but discrete LEDs make an in-
teresting substitute..... **Staff**
- 54 **The Paper, the Station, and the Man**
—a brief history of the New York Times
radio stations..... **W3CFC**
- 63 **QRP from Canton Island**
—proving all things are possible
..... **KH6GB**
- 66 **In Search of Power Line Interference**
—how to find it and get it stopped
..... **W4PZV**
- 70 **Hard Copy from your Xitex Terminal**
—when a video display isn't quite
enough..... **W5SBL**
- 72 **Excavation Litigation**
—don't dig a hole without your lawyer
..... **Hecht**
- 74 **Noise Rejector II**
—an exciting sequel..... **WB6ZYK**
- 76 **Trouble-Free ID Timer**
—for repeaters..... **WA8HEB**
- 78 **So You Want to Build a Beacon?**
—here's how **K9EID**
- 82 **Working with FETs**
—part III: the source follower
..... **WA2SUT/NNNØZVB**
- 86 **IO Microcomputers and Your Satellite
Station**
—part II: ground station antenna
bearings..... **WB8DQT**
- 92 **IO Design Practical PLL and Timer
Circuits**
—program generates standard R and
C values for 567s and 555s.... **N2RG**
- 96 **IO DUPECALL... for Your Next Contest**
—let your SWTP do the duping
..... **K4TSY**
- 103 **Add 'Em Up: An IC-22S Programmer**
—select a frequency by adding the set-
tings of three switches..... **AA4RM**
- 106 **The Oscilloscope Survival Course**
—the finer points of scope usage
..... **McClellan**
- 114 **6m Fun with the FT-625RD**
—six is hot, so why not?..... **W6OJF**
- 116 **Albert and his Momentous Theories**
—a layman's look at Einstein..... **Lutus**
- 134 **Go-Cart**
—wheels for your test equipment
..... **W4MEA**



Never Say Die—4, Looking West—18, DX—20, Awards—28, Contests—30, Microcom-
puter Interfacing—32, New Products—34, Letters—35, Leaky Lines—36, Ham Help—36,
39, 151, 152, 154, RTTY Loop—39, Dealer Directory—102, FCC—112, OSCAR Orbits—
153, Review—153, Corrections—154, Social Events—155, Propagation—177, 1980 Inter-
national SSTV Contest—177



Shown with optional touch tone pad

The new improved Tempo S-1

- The first and most thoroughly field tested hand-held synthesized radio available. 800 channels in the palm of your hand.
- Simple to operate. (You don't need a degree in computer programming)
- Heavy duty battery pack allows more operating time between charges.
- External microphone capability
- The lowest price ever...\$299.00
- The S-1T (With touch tone pad installed)...\$339.00

The Tempo line also features a fine line of extremely compact UHF and VHF pocket receivers. They're low priced, dependable, and available with CTCSS and 2-tone decoders. The Tempo FMT-2 & FMT-42 (UHF) provides excellent mobile communications and features a remote control head for hide-away mounting.

The Tempo FMH-42 (UHF) and the NEW FMH-12 and FMH-15 (VHF) micro hand held transceivers provide 6 channel capability, dependability plus many worthwhile features at a low price. FCC type accepted models also available. Please call or write for complete information. Also available from Tempo dealers throughout the U.S. and abroad.



TOLL FREE ORDER NUMBER: (800) 421-6631
For all states except California.
Calif. residents please call collect on our regular numbers.

11240 W. Olympic Blvd., Los Angeles, Calif. 90064 213/477-6701
931 N. Euclid, Anaheim, Calif. 92801 714/772-9200
Butler, Missouri 64730 816/679-3127

tempo...

the first in synthesized portables gives you the broadest choice at the lowest price

...the new S-5

- * The only synthesized hand-held offering 5 watt output. (Switchable for 1 or 5 watt operation)
- * The same dependability as the time proven S-1 Circuitry that has been proven in more than a million hours of operation.
- * Heavy duty battery pack.
- * External microphone capability.
- * The S-5's exciting low price...only \$349.00
- * With touch tone pad \$399.00

SPECIFICATIONS

Frequency Coverage: 144 to 148 MHz
Channel Spacing: Receive every 5 kHz, transmit Simplex or ± 600 kHz
Power Requirements: 9.6 VDC
Current Drain: 17 ma-standby, 500 ma-transmit
Antenna Impedance: 50 ohms
Dimensions: 40 mm x 62 mm x 170 mm (1.6" x 2.5" x 6.7")
Weight: 17 oz.
Sensitivity: Better than 5 microvolts nominal for 20 db

SUPPLIED ACCESSORIES

Telescoping whip antenna, ni-cad battery pack, charger.

OPTIONAL ACCESSORIES

12 Button touch tone pad (not installed): \$39 • 16 Button touch tone pad (not installed): \$48 • Tone burst generator: \$29.95 • CTCSS sub-audible tone control: \$29.95 • Rubber flex antenna: \$8 • Leather holster: \$16 • Cigarette lighter plug mobile charging unit: \$6 • Matching 30 watt output 13.8 VDC power amplifier (S30): \$89 • Matching 80 watt output power amplifier (S80): \$149

The Tempo S-2

Tempo is first again. This time with a superior quality synthesized 220 MHz hand held transceiver. With an S-2 in your car or pocket you can use 220 MHz repeaters throughout the U.S. It offers all the advanced engineering, premium quality components and exciting features of the S-1. The S-2 offers 1000 channels in an extremely lightweight but rugged case.

If you're not on 220 this is the perfect way to get started. With the addition of the S-25 (25W output) or S-75 (75W output) Tempo solid state amplifier it becomes a powerful mobile or base station. If you have a 220 MHz rig, the S-2 will add tremendous versatility. Its low price includes an external microphone capability, heavy duty ni-cad battery pack, charger, and telescoping whip antenna.
Price...\$349.00 With touch tone pad...\$399.00

TEMPO VHF & UHF SOLID STATE POWER AMPLIFIERS

Boost your signal... give it the range and clarity of a high powered base station. VHF (135 to 175 MHz)

Drive Power	Output	Model No.	Price
2W	130W	130A02	\$209
10W	130W	130A10	\$189
30W	130W	130A30	\$199
2W	80W	80A02	\$169
10W	80W	80A10	\$149
30W	80W	80A30	\$159
2W	50W	50A02	\$129
2W	30W	30A02	\$ 89

UHF (400 to 512 MHz) models, lower power and FCC type accepted models also available.

Henry Radio

Prices subject to change without notice.

FACTORY DIRECT SALE!!

Wilson Electronics



MARK II
Save \$105.90

MARK IV
Save \$112.90

- At greatly reduced prices.
- Mark II and IV accessories.
- Introducing the new Mobile Amplifier Charger.
- Battery and Five free Xtal pairs of your choice with radio.

Mobile Amplifier Charger and Amplifier Specifications

		POWER (Watts)			AMP* 13.8 Vdc
		Useable	In (Typ)	Out (Typ)	
WMH 440TT	Mobile Amplifier Charger	1-6	4	40	5.0
WMH 480TT	Mobile Amplifier Charger	1-6	4	85	15.6
WA 440	Broad Band Amplifier	1-6	4	40	4.8
WA 480	Broad Band Amplifier	1-6	4	85	15.5
WA 2080	Broad Band Amplifier	10-25	20	90	11.0

MOBILE AMPLIFIER FEATURES

- 5-watt audio amplifier for external speaker.
- Automatic fast/trickle charge.
- Front panel Touch-Tone® Pad which allows generation of DTMF tones.
- Over and under mounting bracket for under dash, floor mounting or base station use.
- A Key-locking feature for security.
- Mobile antenna connect.

(Detach Here)

MODEL NUMBER

MODEL NUMBER		SALE PRICE
<input type="checkbox"/> MARK II	1 and 2.5 Watt 2m HH	\$189.00
<input type="checkbox"/> MARK IV	1 and 4 Watt 2m HH Radios (Includes battery and 52/52 plus 5 Xtal pairs of your choice)	212.00
<input type="checkbox"/> BC-2	Desk Battery Charger	31.00
<input type="checkbox"/> BP-4	Extra Battery Pack	19.00
<input type="checkbox"/> LC-3	Leather Case	15.00
<input type="checkbox"/> LC-3P	Leather Case for Touch-Tone® Pad	15.00
<input type="checkbox"/> TTP	Touch-Tone® Pad (Factory Installed)	48.50
<input type="checkbox"/> MC-12	Mobile Charger Only	135.00
<input type="checkbox"/> WMH 440	40W Mobile Amplifier Charger	199.00
<input type="checkbox"/> WMH 480	80W Mobile Amplifier Charger	271.00
<input type="checkbox"/> WMH 440TT	40W Mobile Amplifier Charger with Touch-Tone® Pad	240.00
<input type="checkbox"/> WMH 480TT	80W Mobile Amplifier Charger with Touch-Tone® Pad	309.00
<input type="checkbox"/> WA 440	40W No Tuning Amplifier for Portable Radios	108.00
<input type="checkbox"/> WA 480	80W No Tuning Amplifier for Portable Radio	181.00
<input type="checkbox"/> WA 2080	80W No Tuning Amplifier for Mobile Units	147.00

TO: **Wilson Electronics**
4288 South Polaris Avenue
Las Vegas, Nevada 89103

✓ W2



Ship me all indicated on above chart.

Enclosed is \$ _____

Check Money Order MC VISA

Card Number _____

Expiration Date _____

Xtals 52/52 / / / / /

Name _____

Address _____

City _____

State _____ Zip _____

Signature _____

Shipping Prepaid — Nevada Residents Add 3 1/2% Sales Tax

Info

Manuscripts

Contributions in the form of manuscripts with drawings and/or photographs are welcome and will be considered for possible publication. We can assume no responsibility for loss or damage to any material. Please enclose a stamped, self-addressed envelope with each submission. Payment for the use of any unsolicited material will be made upon acceptance. All contributions should be directed to the 73 editorial offices. "How to Write for 73" guidelines are available upon request.

Editorial Offices:

Pine Street
Peterborough NH 03458
Phone: 603-924-3873, 924-3874

Advertising Offices:

Pine Street
Peterborough NH 03458
Phone: 603-924-7138, 924-7139

Circulation Offices:

Pine Street
Peterborough NH 03458
Phone: 603-924-7296

Subscription Rates

In the United States and Possessions:

One Year (12 issues) \$18.00
Two Years (24 issues) \$30.00
Three Years (36 issues) \$45.00
Lifetime subscription \$240.00

Elsewhere:

Canada—add \$2.00 per year unless paid with U.S. currency.

All other foreign—one year only—\$26.00 payable in U.S. currency through a U.S. bank. (Surface mail).

To subscribe, renew or change an address:

Write to 73 Magazine, Subscription Department, PO Box 931, Farmingdale NY 11737. For renewals and changes of address, include the address label from your most recent issue of 73. For gift subscriptions, include your name and address as well as those of gift recipients. Postmaster: Send form #3579 to 73 Magazine, Subscription Services, P.O. Box 931, Farmingdale NY 11737.

Subscription problem or question:

Write to 73 Magazine, Subscription Department, PO Box 931, Farmingdale NY 11737. Please include an address label.

73 Magazine (ISSN 0098-9010) is published monthly by 73, Inc., Pine Street, Peterborough NH 03458. Second class postage is paid at Peterborough NH 03458 and at additional mailing offices. Copyright (c) 1980 by 73, Inc. All rights reserved. No part of this publication may be reprinted or otherwise reproduced without written permission from the publisher. Microfilm Edition—University Microfilm, Ann Arbor MI 48106.

W2NSD/1 NEVER SAY DIE

editorial by Wayne Green



ASIA FLEW

Next October, if you can get away, you should go on the IEEE tour of Asia. You'll love it.

Sherry and I went in 1979 and it frustrates me to have that much fun without getting others to enjoy it with me. How would you like to get a ham license in Korea and get on the air as a DX station for a while? How would you like to meet the only ham on Taiwan, Tim Chen BV2A? Or get together with most of the active hams in Hong Kong for a dinner... and some operating? A visit to the hundreds of electronics stores in Tokyo's Akihabara section is something you will see nowhere else on Earth.

The tour was set up to coincide with electronic shows in Taipei, Osaka or Tokyo, Seoul, and Hong Kong. These shows have the latest in consumer electronics, including some ham gear, plenty of microcomputers, calculators, digital

watches, hi-fis, TVs, TV cameras, and VTRs. If you are able to come back without some gadgets, you are better than I am. We brought back a Sanyo midget TV/radio/clock, a musical calculator, and a calculator watch exactly like the Seiko, but at about half the \$275 Seiko price.

The hams on Guam are dying to meet you and set up one hell of a party. So are the hams in Hawaii... so you can get some "rest" on the way back. The whole tour was under \$2000 per person, which is very reasonable considering that they put on a lot of free dinner parties and entertainments. If we can get about 20 hams to go on the next trip, I think we can work up hamfests in at least seven countries. Game?

HL9WG

The hams in Korea made my visit there unforgettable. I'd stopped off there on a flight

around the world in 1959, back when Seoul was a large village more than a city. Today it stretches for miles and has a big shopping district, complete with several department stores.

Sgt. Charles Milhans WA7QYI/HL9UN took off several days to show Sherry and me around Korea. He's there with the rather sizeable U.S. contingent. My ham ticket had been arranged ahead of time and was quickly issued by the U.S. Amateur Radio Operations Director, Major Smith. Charlie then got us together with Mike Wengert HM00M, an American living in Seoul as a civilian. Mike is a Korean-speaking radio commentator who runs a weekly radio program telling the Koreans about the reactions of the rest of the world to events in Korea.

Mike and Charlie took us all over town, interpreting for us where needed and introducing us to the marvelous Korean food. I'd heard a lot about kimchee, a fermented cabbage, which is served with almost every Korean meal. Not being a big fermented food fan, I approached it with hesitation. It was great! It had some of the tang you get with hard cider which is fermented.

The most exciting part of the visit to Korea was the trip to put my foot into North Korea. I'm a collector of countries visited, so I hate to make a trip without adding at least one more country, even if it is only a step over the border. In this case, Charlie had been talking with Chris Westrom HL9KL, one of the Swedish team minding the South Korean border at Panmunjom, and had made arrangements for us to come up and visit.

Charlie, Sherry, and I started

HEADQUARTERS UNITED NATIONS COMMAND/
UNITED STATES FORCES, KOREA APO 96301

**CERTIFICATE OF AUTHORIZATION
FOR AMATEUR RADIO STATION**

This is to certify that Radio Station HL9WG is an official amateur radio station authorized by the Commander in Chief, United Nations Command/Commander United States Forces Korea, for operation under the control and supervision of WAYNE GREEN. This authorization is subject to the terms of the current regulations governing amateur radio operations in Korea, and will remain valid for two years from the date of issue unless sooner revoked or modified.

Certificate No. 083775
Date 28 AUGUST 1979

Signal Officer

W2NSD/1 became HL9WG in Korea, courtesy of the UN Command.

New 2-meter direction.



A compact transceiver with FM/SSB/CW plus...

TR-9000

Kenwood's done it again! Now, it's the exciting TR-9000 2-meter all-mode transceiver...complete with a host of new features. Combining the convenience of FM with long-distance SSB and CW in a very compact, very affordable package, the TR-9000 is the answer for any serious Amateur Operator! Versatile? You bet! Because of its compactness, the TR-9000 is ideal for mobile installation. Add on its fixed-station accessories and it becomes the obvious choice for your ham shack!

TR-9000 FEATURES:

- FM, USB, LSB, and CW...all popular modes
- Compact size...only 6 11/16 inches wide X 2 21/32 inches high X 9 7/32 inches deep
- Digital dual VFOs...with selectable tuning steps of 100 Hz, 5 kHz, and 10 kHz, convenient for each mode of operation
- Digital frequency display...five, four or three digits, depending on selected tuning step

- Extended frequency coverage...143.9000 - 148.9999 MHz
- Five memories: M1 - M4...for simplex or ± 600 kHz repeater offset; M5...for nonstandard offset (memorizes transmit and receive frequency independently)
- Scan of entire band...automatic busy stop and free scan
- SSB/CW search...sweeps over selectable 9.9-kHz bandwidth segments, for easy monitoring
- UP/DOWN microphone (standard)..."beep" sounds with each frequency step
- Noise blander...eliminates pulse-type noise on SSB and CW
- Low-noise, dual-gate MOSFET and two-stage monolithic crystal filter for improved receiver front-end characteristics
- RIT (receiver incremental tuning) for SSB and CW...effective even on memory channels
- RF gain control
- CW sidetone
- Automatic selection of AGC time constant with MODE switch (slow for SSB and fast for CW)
- Improved power module for reliable and stable linear RF output
- Selectable power outputs...10 W (HI)/1 W (LOW)
- Mobile mounting bracket...easy to mount, with quick-release levers
- LED indicators...ON AIR, BUSY, and VFO
- Accessory terminals on rear panel...KEY, BACKUP DC, STBY, EXT SP, DC, TONE INPUT, and ANT

See your Authorized Kenwood Dealer now for details on the TR-9000...the new direction in 2-meter all-mode transceivers!

NOTE: Price, specifications subject to change without notice and obligation.

Subject to FCC Approval

MATCHING ACCESSORIES FOR FIXED-STATION OPERATION:

- PS-20 power supply
- SP-120 external speaker
- BO-9 System Base...with power switch, SEND/RECEIVE switch for CW operation, backup power supply for memory retention (BC-1 backup power adaptor may also be used for this application), and headphone jack



Staff

EDITOR/PUBLISHER
Wayne Green W2NSD/1

EXECUTIVE VICE PRESIDENT
Sherry Smythe

CORPORATE CONTROLLER
Alan Thulander

ASSISTANT PUBLISHER
Jeffrey DeTray WB8BTH

ADMINISTRATIVE ASSISTANT
Dotty Gibson

MANAGING EDITOR
John Burnett

ASSISTANT MANAGING EDITOR
Susan Philbrick

NEWS EDITOR
Gene Smarte WB6TOV/1

EDITORIAL ASSISTANTS
Elisabeth Blackmore
Richard Phenix

PRODUCTION MANAGER
Noel Self WB1ARP

ASSISTANT PRODUCTION MANAGER
Robin Sloan

ART DEPARTMENT
Steve Baldwin
Bob Drew
Bruce Hedin
Kenneth Jackson
Michael Murphy
Dion Owens
Nancy Salmon
Patrice Scribner
John White

BOOK PUBLICATIONS
Jim Perry

BOOK PRODUCTION
Emily Gibbs
Chris Brown N1AUI

PRINTING
Gary Steinbach, Mgr.

PHOTOGRAPHY
Bill Heydolph
Tedd Cluff
Terrie Anderson

TYPESETTING
Barbara Latti
Sara Bedell
Rhonda Clapper
Sandie Gunseth

BOOKKEEPER
Knud Keller KV4GG/1

DATA ENTRY
Cathy DeSilva

SUBSCRIPTION SALES MANAGER
Debra Boudrieau

CIRCULATION MANAGER
Harold Stephens

ASSISTANT CIRCULATION MANAGERS
Donna Taylor
Judy Waterman

CIRCULATION
Pauline Johnstone

BULK SALES MANAGER
Ginnie Boudrieau

SHIPPING
Mark Dendy
Bill Barry

RECEPTIONIST
Doni Jarvis

ASSOCIATES
Robert Baker WB2GFE
Sanger Green
Dave Ingram K4TWJ
Larry Kahaner WB2NEL
Joe Kasser G3ZCZ
Bill Pasternak WA6ITF
John Schultz W4FA
Peter Stark K2OAW

COMPUTER PROGRAMMING
Richard Dykema

ADVERTISING
Aline Coutu, Mgr.
Kevin Rushalko
Nancy Ciampa
Marcia Stone
Louise Holdsworth
Jerry Merrifield
Lori Mugford
Rita Rivard



Just after talking with W2NSD/1 from Seoul, using my HL9WG call, this photo was snapped. Next to me is Namil Kim HM1HJ, seated is Mike Wengert HM0OM, our new importer for Instant Software in Korea, and on the right is Hea-Soo Ree HM1BO, the president of the Korean Amateur Radio League. 10:15 at night there is 9:15 am the same day back home.

out early in the morning on a bus and arrived at the demilitarized zone (DMZ) after an hour or so of bussing from one small village to another. It was a bit sobering when we signed the agreement that the U.S. would no longer be responsible for us as we entered the zone.

Chris took us all around the border area, showing us the meeting building, which is right on the border, with the North Koreans taking pictures of us every inch of the way. They had telescopic cameras for slides and movies. We'd been warned not to wave back when they waved

at us, the intent being to have movies of us waving and immediately call for a meeting because our waves were considered as obscene gestures and thus a breaking of the peace agreement. Without waving, we went into the building, and, with the North Koreans watching every move and filming, we walked about twenty feet into North Korea...snapped some pictures as proof...and hastily went back into the South Korean half of the building. Country number 91 for me. Whew!

What I'd like to do next time is have a bunch of hams along and

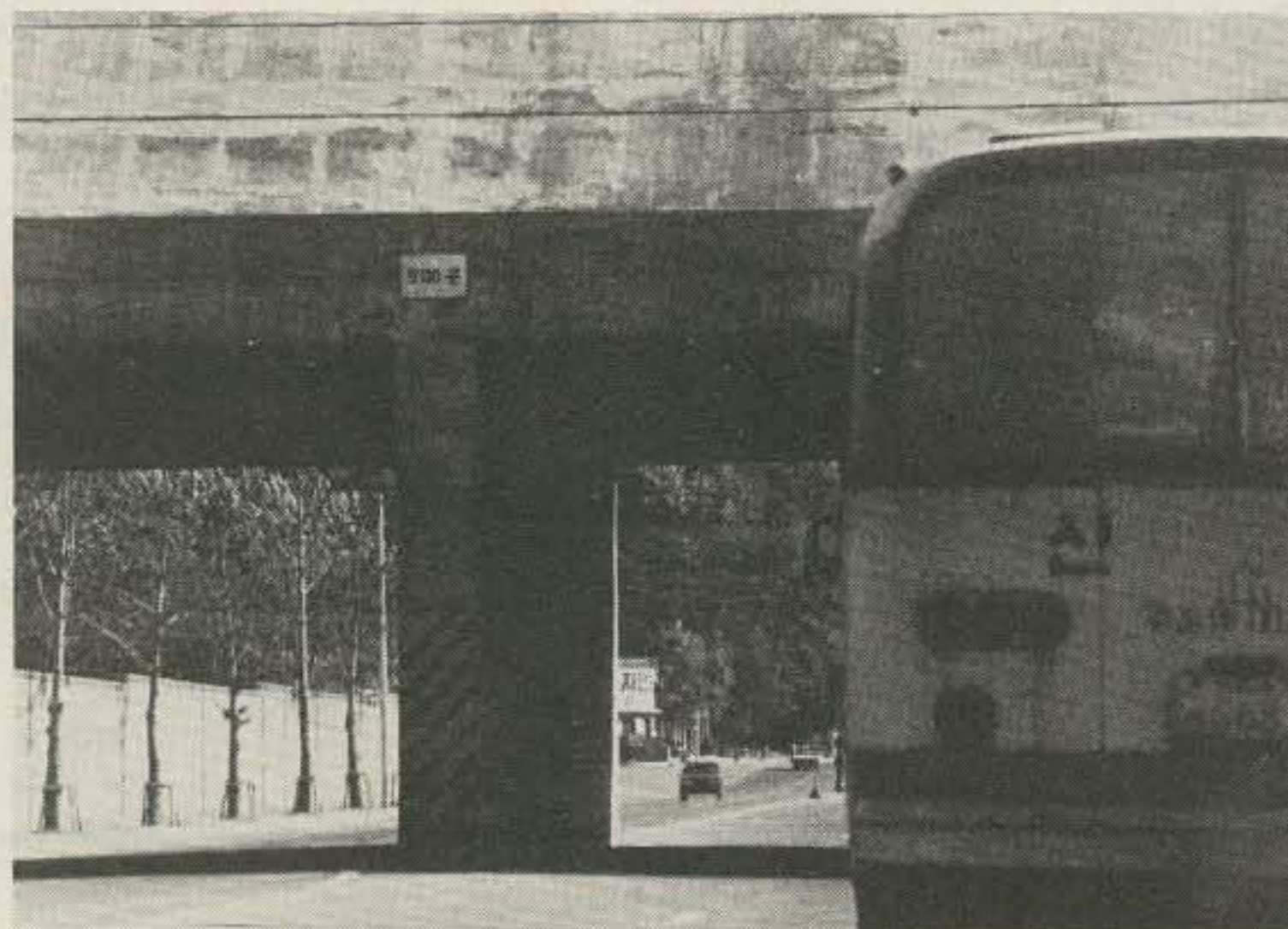

All of the main roads in Korea have these underpasses. The idea is that should North Korea invade the country, explosives in the support columns would blow them away, leaving the roads completely blocked by the debris from above them. This reminded me a bit of the rails which are designed to spring up out of the roads (via radio control) in Switzerland should they be invaded. These are on all mountain roads and would most effectively stop tanks and other traffic.

all bring those glasses with Groucho eyebrows and big noses... and everyone wear those while visiting the place. That ought to drive them crazy... or at least crazier.

We had a very nice lunch with Chris and the Swedish peace-keeping staff. It's much like a little country club up there... with the exception that things could go to hell at any moment. After lunch, I sat down and made a few contacts with Chris's rig. Since someone had just been kidnapped from our side the night before, it was exciting to walk along the border on a wooded path, hoping that this would stay a peaceful visit.

On our first night in Korea, Sherry and I attended a dinner arranged by the tour... a dinner show at the Sheraton Walkerhill Hotel. The dinner was fine, but the show was crummy... not quite up to Gong Show talent. The next night, we had another tour dinner and then went to visit Charlie, where I got on the air and worked a bunch of Ws.

The next night we went to see Mike. The head of the Korean Amateur Radio League (KARL), Hea-Soo Ree HM1BO, came over and visited, as did the KARL Supervisor, Namil Kim HM1HJ. I got on the air for a while using Mike's rig and made quite a few stateside contacts... the best one being with W2NSD, my home station at 73 Magazine, operated by Jeff DeTray, the Assistant Publisher.

No sooner were we getting used to modern day Seoul than we were on the plane for Osaka and a second electronics show. The Japanese didn't have as many incredibly loud hi-fi exhibits as the show in Korea; however, it was a much larger show... spread out in three big buildings. One was devoted mostly to parts and equipment modules and the other two were consumer electronics, including quite a number of microcomputers. The state of the art has progressed in the last year in color home TV cameras. I was particularly interested in that because I'd like to update my theory audio tapes with video... in color.

They had some food booths at the show, so we lunched there and then caught our tour bus for a visit to the big shrine at Osaka. A couple of rolls of film later, we were bussed back to downtown so we could see the department

Buy One Of These Transceivers From Ham Radio Center & Be Guaranteed That You Will Get The Best Price!



DRAKE®



KENWOOD®



TEN-TEC®



SWAN®
ELECTRONICS



YAESU®

Ham Radio Center's Best Price Guarantee

1. Shop any or all the ham dealers with a TOLL-FREE (WATS) Line.
2. Then call HAM RADIO CENTER.
3. HAM RADIO CENTER guarantees to meet or beat any legitimate price* quoted by a factory authorized ham dealer with a TOLL-FREE (WATS) Line on the following equipment:

DRAKE	KENWOOD	TEN-TEC	SWAN	YAESU
TR-7/DR-7 R-7/DR-7	TS-120S TS-180S/DFC TS-520SE TR-7600	509 (Argonaut) 570 (Century/21) 545B (Omni-A) 546B (Omni-D)	100-MX Astro-150	FT-101Z FT-101ZD FT-901DM FT-227RB CPU-2500RK

4. This guarantee on the above transceivers expires February 29, 1980.

*NOTE: HAM RADIO CENTER *limits* legitimate price to current dealer cost plus mark-up!

CALL TOLL-FREE

1-800-325-3636

FOR BEST PRICE GUARANTEE



HAM RADIO CENTER

8340-42 Olive Blvd. • P.O. Box 28271 • St. Louis, MO 63132





Japan Airlines gets you ready for the world of chopsticks on your way to Asia. Here's Sherry getting practice with some noodles.



Here I am shaking hands with Yasushi Oshima, the mayor of Osaka, during my recent visit to that city. That's the key to the city hanging around my neck . . . that and 100 yen got me a ride on the subway. The mayor was most gracious, and, in addition to the key, he laid a beautiful photo book about Osaka on me. His aide turned out to be JE3DTA.



A Japanese subway train is remarkably like those in our country . . . with a few exceptions. First, they are incredibly clean. Even the tracks are clean, with no papers or cans thrown down there. Second, they are filled with Japanese . . . and the ads are all in Japanese. A ride is charged by the distance, much like the London Underground, with short distances costing about 50¢ and longer about double that.



It isn't very prepossessing . . . just a carved wooden sign over the entryway. Upstairs are the offices of the China Radio Association, with all but one of the membership being not licensed. The Association publishes a quarterly magazine, with articles in the most recent issue covering satellite business systems, sunspots, Skylab, the radio and radar facilities at their new international airport, the Marisat satellite system, working ability of computers, biomedical instrumentation, and radio amateur activities.

YOKOTA

COMPUTER

CLUB



YOKOTA AB JAPAN

APO SF 96328

stores. Whoops! There's a McDonald's! I found a number of our tour group inside pacifying Big Mac attacks. I tested the hot fudge sundae . . . just like the ones in Nashua, New Hampshire . . . not very good.

That evening, Mr. and Mrs. Inoue (the president of Icom) picked Sherry and me up for dinner. Naturally, they knew a wonderful restaurant and we had what was beyond a doubt the finest Japanese dinner of our lives. Tempura, Kobe steak, the works. We enjoyed having a chance to talk again, it having been several years since they had visited me in New Hamp-

There are enough Americans with microcomputers to have not just a computer club, but a very active one. They hold meetings weekly and fielded nearly a hundred for my talk.

shire. At that time we took them up to the 73 Magazine repeater site on some snowmobiles, courtesy of Chuck Martin of Tufts Electronics.

Prices are stiff in Japan if you don't know your way around. I made the serious error of having breakfast in the hotel (International) the first day in Osaka. It was not only crappy, it was \$8.25 for just one breakfast. That was a small glass of undrinkable bitter orange juice, one over-easy egg which was hard as a carp, and a thick slice of cold toast. Ugh.

When we decided to venture

out for dinner we took a taxi to the downtown area, first going to the department stores for some shopping (and money changing). The restaurants all have very lifelike plaster models of the foods in their windows, complete with prices. We looked over at least a hundred restaurants before settling on a Chinese restaurant. It was right across the street from a Baskin Robbins and next door to another McDonald's. The food was fine and the prices moderate . . . particularly for Japan. We decided to brave the subway system to get back to the hotel . . . and

ATR-6800



Truly a new dimension in digital communications, the ATR-6800 is more than a superb CW and RTTY machine. It includes a user programmable microprocessor designed to fully automate your station.

Your ATR-6800 is ready to run in a "real world" environment. A shielded metal box and extensive RFI filtering allow side by side operation with your kilowatt, and there is no need for extra attachments or cumbersome program loading.

Direct connection to your transceiver provides total capability on CW and all Baudot and ASCII speeds, both present and future.

For additional performance specs, just use your imagination . . . ATR-6800 with 9' monitor amateur net. \$1,995.

Ask your dealer for a full demo, or drop by. MICROLOG CORPORATION, 4 Professional Drive, Suite 119, Gaithersburg, MD. 20760. telephone (301)-948-5307.

MICROLOG

INNOVATORS IN DIGITAL COMMUNICATIONS



Three bowls of dinner being cooked at one time on large Mongolian barbecue stove. You pick out the meat you want, frozen and sliced thin, add vegetables like you would at a salad bar, put on some hot sauces, and they cook the whole works in about one-half minute. You'll love it.

had no problem. It is easy to use, being well marked, using the French metro system of signs. It's exciting to try something new like that.

We spent a little more time

seeing the electronics show the next morning and then went to see the mayor of Osaka. He presented me with a key to the city plus a gorgeous book of photos of Osaka. His assistant



Like I said, in China you usually have about a dozen to a table, with a lazy Susan in the middle of the table. This is kept full of food, with many meals running to over a dozen different courses. Urp. These people were part of our tour group . . . Bob Chen at right, our tour leader.

turned out to be a ham.

After the key ceremony, we went back to the hotel and had lunch at a nearby American-type restaurant. I had one more meeting with a Japanese group wanting an exclusive license for our Apple programs for Japan. I bought two cups of coffee and one small cake . . . and the hotel bill was far more than for the lunch around the corner. Oh, well, this can happen to you in New York, too. I guess they ship television sets to the U.S. at a loss and make up for it with their hotel restaurants.

Right after lunch, we got on a bus and headed for the airport . . . and Taipei. I was looking forward to seeing Tim Chen BV2A. I'd contacted him from Seoul on 20m and gotten his phone number. The tour schedule was too busy the first day in "China" to see Tim, but we did get together

the second day.

Busy? Right after breakfast we went to the electronics show. You know, they are making a lot of electronic equipment in Taiwan these days. The city, like Seoul, had grown up incredibly since my visit in 1959. Mopeds and motorcycles by the tens of thousands . . . chaos. They had some digital watches that got me to thinking again about importing . . . though the Otron watches I'd seen in Seoul seemed to have a couple more functions. I'd checked over the field a few months earlier at the Premium Show in New York and opted for Otron at that time . . . and had never been disappointed. It was very handy on this trip because it had two time zones at the push of a button . . . alarm, stopwatch . . . all those nice functions. But would hams want to spend \$50 for a



Ever eat a Mongolian? Very good taste . . . when barbequed. The spelling in Hong Kong is not a strong suit.



Alas, even in China they have topless entertainment.



This is the lobby of the Grand Hotel in Taipei. Our tour group is heading upstairs for another fifteen-course lunch, complete with Peking duck. That's Tim on the left.

nice watch like this? There are a lot of others that look similar, though they do not have quite as many functions.

Whoops, time to get on the bus and go to a luncheon put on by the Chinese Products Promotion Center. This was a big one and we were all seated at tables according to the products we were interested in. I sat at the computer table and quickly attracted two young chaps trying to export an inexpensive dot matrix printer. It needed a bit more developing of the driver circuits, but could be competitive. I aimed them at tour member Dave Freeman of Advanced Computer Products (one of our advertisers in *Kilobaud MICROCOMPUTING*).

We were all invited to a Chinese cocktail party that evening,

so we rested up at the hotel for a bit and bussed into downtown and this event . . . arriving just a hair late. I was the first one into the party and grabbed the last hors d'oeuvre as a waiter took away the platters . . . and then the lights went out. We had to grope around in the dark to get back to the elevators and leave the hotel. Don't invite me to another Chinese cocktail party.

The dinner that night was arranged by the tour and it was excellent. The only problem, perhaps, was trying to pick up those big slippery mushrooms with plastic chopsticks. The show after the dinner was Las Vegas quality, not like the bomb in Seoul. Everyone enjoyed it.

The next day was October 10th, the biggest holiday of the year for Taiwan . . . they call it

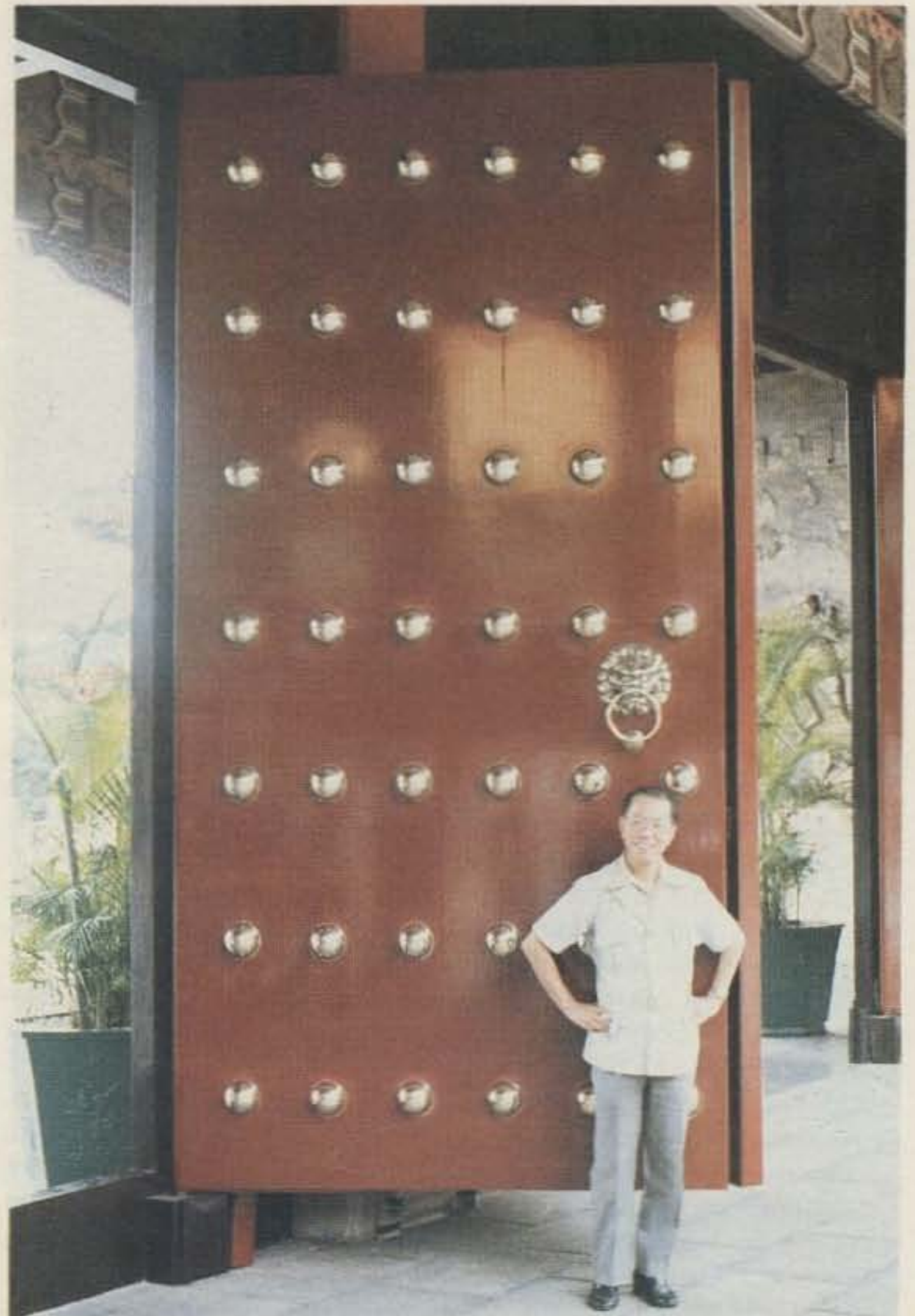

No, Tim Chen BV2A is not a midget; that's one hell of a big door. If you've contacted Taiwan recently, this is the chap you talked with.

Double Ten. There were flags everywhere and balloons by the thousands. We watched the parade for a bit on television and then went out to see the town

with Tim Chen, the only ham on Taiwan. The first stop was the club station, BV2A/BV2B. From there we took a taxi around town and ended at the museum . . .



This picture was taken on the biggest holiday of the year on Taiwan, Double Ten (October 10th) . . . hence the balloon in the center of the circle. That building across from our hotel (the Regency) is a department store. Handy. Still, this is almost two miles from the downtown area, where just a few years ago they had rice paddies.



Over 20,000 people participated in the Chinese Double Ten celebration in this sports arena. About 3,000 girls were used to hold up colored boards to make pictures and designs. They were kept busy with dozens of designs. The errors were surprisingly few considering that there was no way for them to get together to practice before the event.

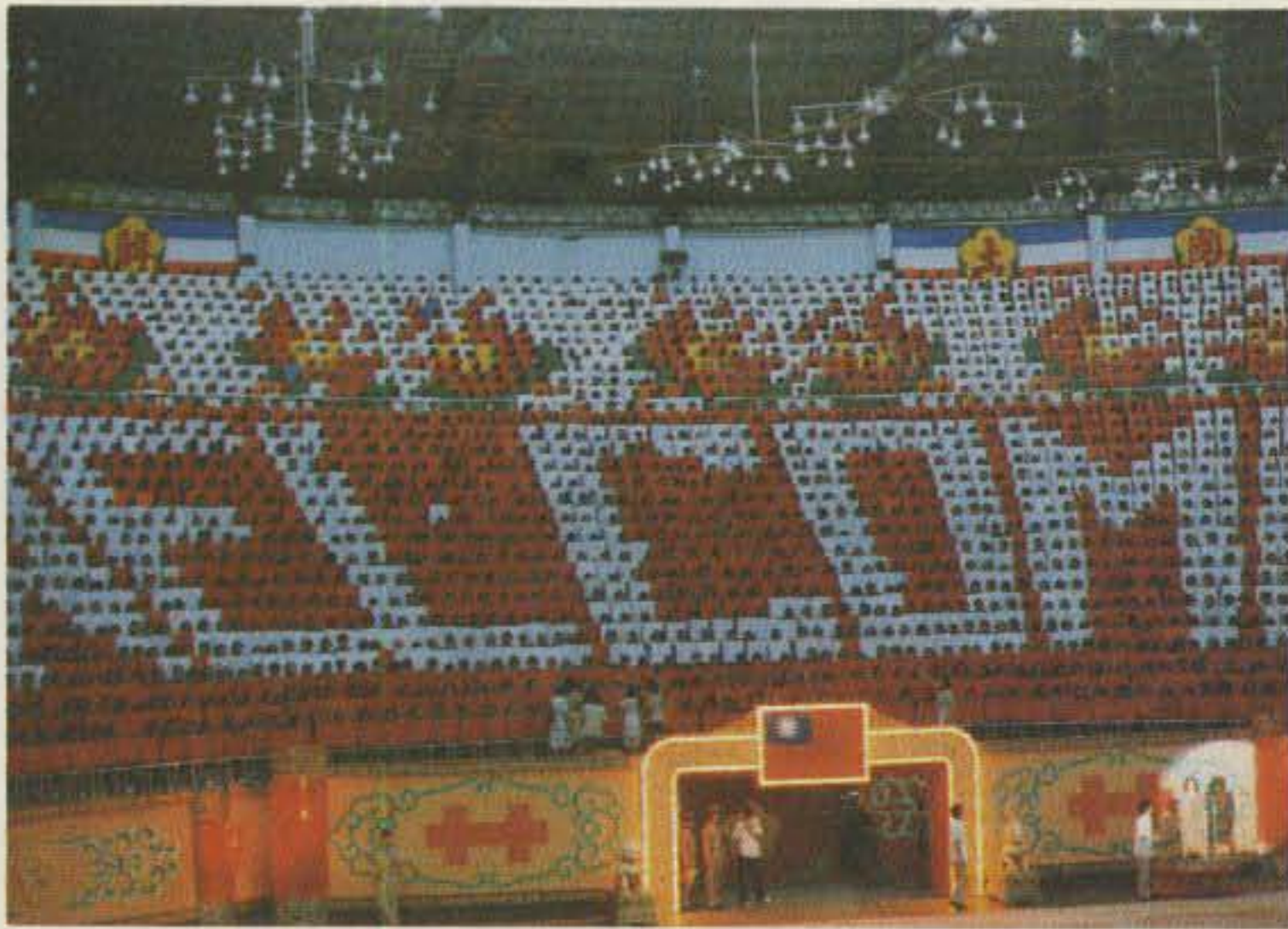

The colored signs spell out a welcome for our group.

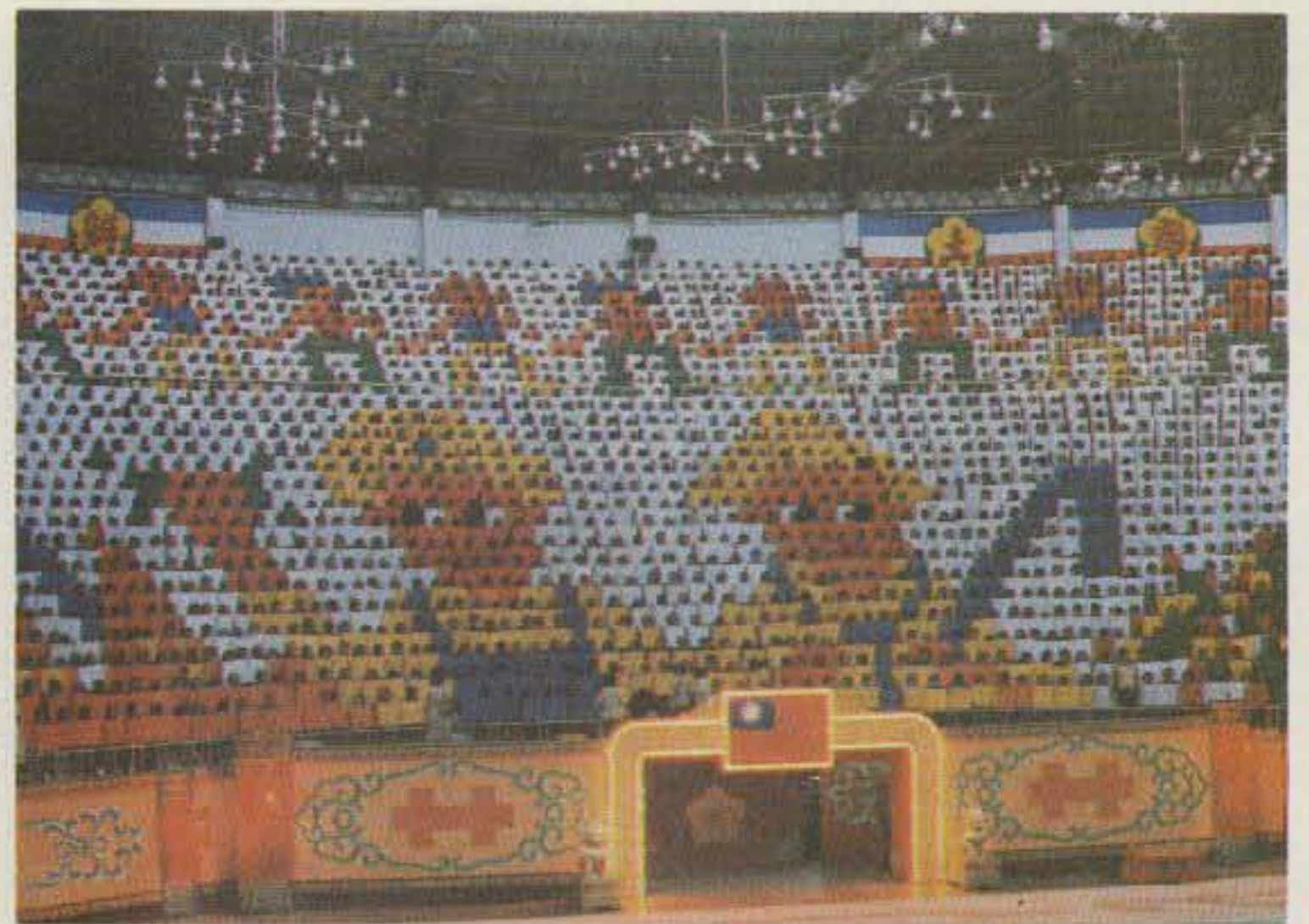

Now we see children at play.

running into our tour group there! This museum is a must.

Not far from the museum was the Grand Hotel, where we all had lunch. Tim didn't seem familiar with Peking duck... perhaps that is more of an American dish. But we had about twenty courses of excellent food, with Tim as our guest. The hotel is opulent.

We went for a visit to a shrine and then saw a bit more of Taipei before Tim had to leave for work. He is a representative for Columbia Pictures in Taiwan. Sherry and I rested a bit, trying the best we could to digest that enormous lunch before going out for another dinner at the expense of the tour. This was to be a Mongolian barbecue.

This was different. You go along a line like a salad bar and pick out the kind of meat you want... from a choice of beef, venison, pork, etc. The meat is frozen and sliced thinly. Then

you add vegetables and sauces to the bowl. They take the whole bowl of food and dump it on a red hot stove top, turning it quickly to cook it... and back into your bowl. It was delicious. They had more meat on the table and some soup in a fondue-like pot so we could cook it at the table.

The biggest surprise was after the meal. We went by bus to a huge auditorium and sat for several hours watching one of the most spectacular shows I've seen. There were about 30,000 people present and groups of children of all ages took turns putting on very well produced and choreographed acts for us. Have you ever seen about fifty youngsters, maybe twelve years old, all juggling something like a badminton shuttle with their feet at once... without anyone making a mistake? They were standing up, not lying down, to do it.

They had some of the most complex rope jumping I've seen, too, with groups jumping rope within other ropes... within other ropes. Have you ever seen a triple rope sine wave with three groups inside jumping rope? Or two sets of double loops at right angles, with others inside all four loops jumping rope?

The networks would do well to get a remote to the Double Ten celebration next year. I know I'm planning on being there... how about you?

We still had one more day in Nationalist China... which meant another big lunch, more trade show, several miles of walking around town in the afternoon, a visit to more Taiwan products on display, and a mammoth Chinese dinner. Sherry passed this one up... I think the walk did her in. The head of the Chinese Chamber of Commerce ate at my table (there are always about ten or twelve to a

table and a lazy Susan for passing the food around). He may just have won the office by being able to drink anyone else under the table. He went for four rounds of drinks at our table, drinking drink for drink with each person at the table... then he moved on to the next table! Amazing capacity.

After an early start from Taiwan, we arrived at Hong Kong (country number 92 for me... I'll get to 100 yet) in the early afternoon. We unpacked quickly and went off to the consumer electronics show in a downtown hotel. This was a smaller show, but certainly interesting. The prices in Hong Kong are about the best of the trip for watches. I was hoping to get some glimpse of the legendary TRZ-80 at this show, but no one admitted even knowing about it. I'd seen pictures of it in an Australian magazine, so I knew it was not imaginary.

Wiping our fingers from the



But no one can forget that not far away is mainland China and the constant threat of war for which Taiwan must be constantly prepared.



With a cheering section of 3,000, it is possible to come up with even the most complicated of Chinese characters.

DSI GOES LCD

TRUE RMS - 3½ DIGITS - DMM - .1% BASIC ACCURACY

149⁹⁵

LC 5000

FACTORY WIRED

**AVAILABLE
JANUARY 1980**



RANGES

- AC TRUE RMS TO 1000V — 200mv, 2v, 20v, 200v, 1000v
- DC VOLTAGE TO 1000V — 200mv, 2v, 20v, 200v, 1000v
- DC CURRENT TO 2 Amps — 200μa, 2ma, 20ma, 200ma, 2A
- RESISTANCE TO 20 Megohms — 200, 2k, 20k, 200k, 2mg, 20mg

AN UNPRECEDENTED DSI VALUE
in a high quality, LSI Design, .1% basic accuracy, 3½ digit DMM and because it's a DSI innovation, you know it obsoletes all competitive makes, both in price and performance.

No longer do you have to settle for small readouts, short battery life, a kit with a bag of parts, a black box with 20 Resistors that need adjustment every time you need to recalibrate, because you only budgeted \$100.00 or \$150.00 for a DMM.

The Model LC 5000 is factory assembled and tested in the USA. DSI has designed in Precision Laser Trimmed

Resistor Networks to provide maximum accuracy, resulting in long time periods between recalibration and a simple two adjustment calibration procedure. The LC 5000 incorporates a fused input circuit to help prevent damage to the DMM. The large .5 inch LCD Readouts are easy to read even in the brightest sunlight and allows for very low battery drain, normally only two battery changes a year is required. The LC 5000 is the perfect lab quality instrument on the bench or in the field — you can depend on DSI LC 5000 to meet all your needs. Buy Quality — Buy Performance — Buy Reliability — Buy DSI.

**FOR INFORMATION — DEALER LOCATION — ORDERS — OEM
CALL 800-854-2049 CALIFORNIA RESIDENTS CALL 800-542-6253**

LC 5000 wired factory burned-in 1 year limited warranty. Prices and/or specifications subject to change without notice or obligation.
TERMS: MC - VISA - AE - Check — M.O. - C.O.D. in U.S. Funds. Please add 10% to a maximum of \$10.00 for shipping, handling and insurance. Orders outside of USA & Canada, please add \$20.00 additional to cover air shipment. California residents add 6% Sales Tax.



✓ D25 **DSI INSTRUMENTS, INC.**
9550 Chesapeake Drive
San Diego, California 92123
(714) 565-8402

Model LC 5000 \$149.95
**LCBA - Rechargeable
Battery Pack Includes
AC Battery Charger . \$24.95**

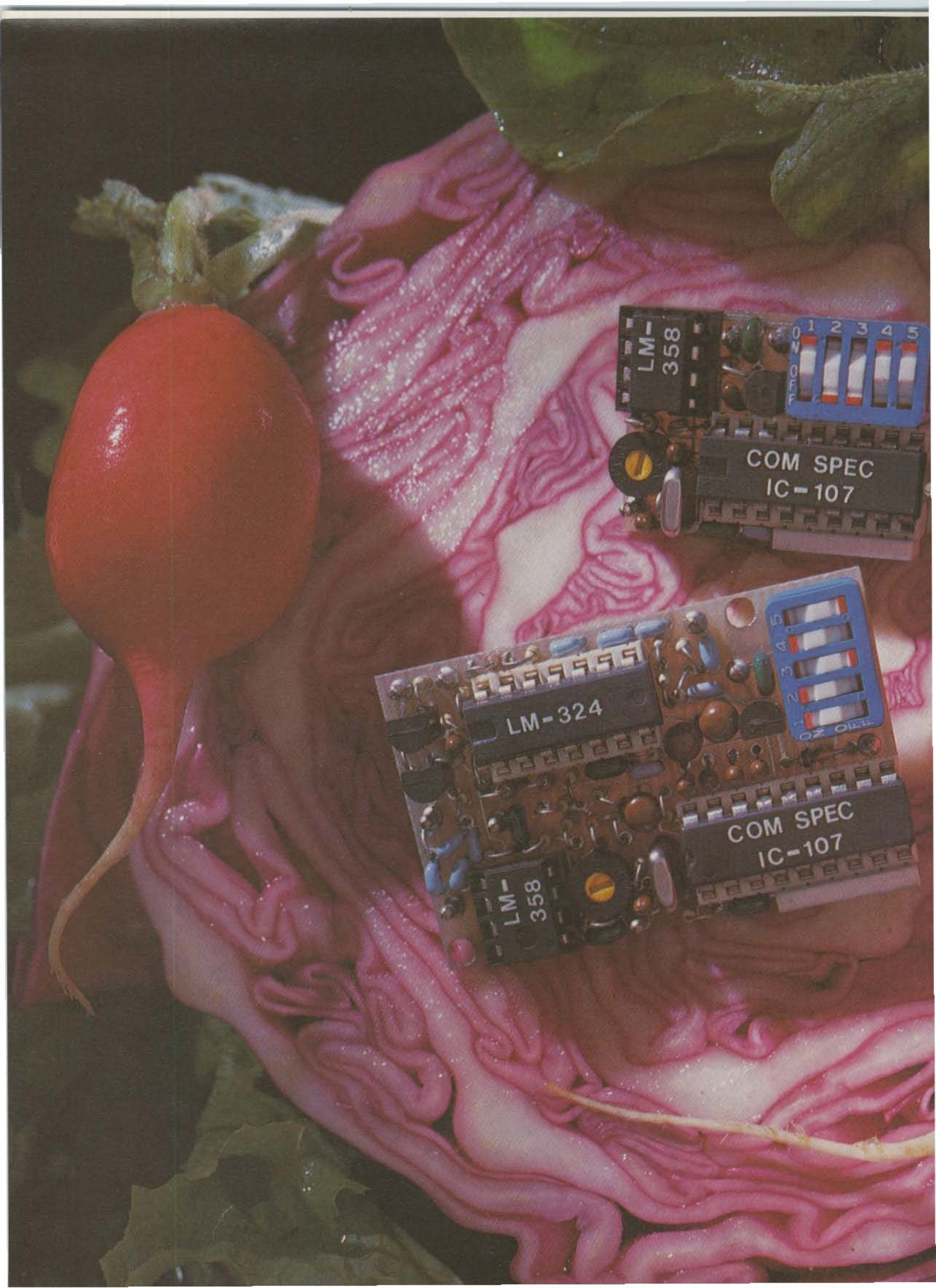

LM-358

1 2 3 4 5
OUT

COM SPEC
IC-107

LM-324

1 2 3 4 5
OUT

COM SPEC
IC-107

LM-358



A fresh idea!

Our new crop of tone equipment is the freshest thing growing in the encoder/decoder field today. All tones are instantly programmable by setting a dip switch; no counter is required. Frequency accuracy is an astonishing $\pm .1$ Hz over all temperature extremes. Multiple tone frequency operation is a snap since the dip switch may be removed. Our SS-32 encode only model is programmed for all 32 CTCSS tones or all test tones, touch-tones and burst-tones. And, of course, there's no need to mention our 1 day delivery and 1 year warranty.



TS-32 Encoder-Decoder

- Size: 1.25" x 2.0" x .40"
- High-pass tone filter included that may be muted
- Meets all new RS-220-A specifications
- Available in all 32 EIA standard CTCSS tones

SS-32 Encoder

- Size: .9" x 1.3" x .40"
- Available with either Group A or Group B tones

Frequencies Available:

Group A			
67.0 XZ	91.5 ZZ	118.8 2B	156.7 5A
71.9 XA	94.8 ZA	123.0 3Z	162.2 5B
74.4 WA	97.4 ZB	127.3 3A	167.9 6Z
77.0 XB	100.0 1Z	131.8 3B	173.8 6A
79.7 SP	103.5 1A	136.5 4Z	179.9 6B
82.5 YZ	107.2 1B	141.3 4A	186.2 7Z
85.4 YA	110.9 2Z	146.2 4B	192.8 7A
88.5 YB	114.8 2A	151.4 5Z	203.5 M1

- Frequency accuracy, $\pm .1$ Hz maximum -40°C to $+85^{\circ}\text{C}$
- Frequencies to 250 Hz available on special order
- Continuous tone

Group B		
TEST-TONES:	TOUCH-TONES:	BURST-TONES:
600	697 1209	1600 1850 2150 2400
1000	770 1336	1650 1900 2200 2450
1500	852 1477	1700 1950 2250 2500
2175	941 1633	1750 2000 2300 2550
2805		1800 2100 2350

- Frequency accuracy, ± 1 Hz maximum -40°C to $+85^{\circ}\text{C}$
- Tone length approximately 300ms. May be lengthened, shortened or eliminated by changing value of resistor

Wired and tested: TS-32 \$59.95, SS-32 \$29.95

 **COMMUNICATIONS SPECIALISTS**

426 West Taft Avenue, Orange, California 92667
(800) 854-0547 / California: (714) 998-3021

Looking West

Bill Pasternak WA6ITF
24854-C Newhall Ave.
Newhall CA 91321

I rarely comment on the work of another author, but in this case I must make an exception to my rule. Why? Because I believe that the November article by Bob Cooper W5KHT entitled "The Satellite TV Primer" was the most interesting piece ever to appear in this or any other amateur radio magazine. I don't say this lightly. I firmly believe that the real future of communications lies "up there" rather than "down here." People like Bob Cooper are aware of this, although it's only been lately that the overall populace of this nation has come to understand the capabilities of geosynchronous satellite communications. We are at the dawning of a new era. This is why it was so important that amateur radio retain its satellite frequencies; it was a truly sad day when most were lost at the ITU conference some years ago. In many ways, it's hard to fault the League for that debacle, since their shortsightedness came from their deep commitment to HF communications. When one is involved right smack dab in the middle of an "in" thing, it is sometimes quite hard to see past the end of one's nose. What is hard for Newington and many thousands of amateurs to comprehend is that the day of long-haul HF communications is fast drawing to a close, to be replaced by geosyn-

chronous satellite relay. An announcement has been made of tentative WARC approval of three new HF bands at 10, 18, and 24 MHz. This has yet to be approved by the overall plenary council. While it may hold some small amount of significance if it is approved, it's far from earth-shattering in overall significance. Oh, it will mean a bit more HF room and probably a new generation of highly touted, highly overpriced equipment, but nothing more important than that. If it would mean the return of the lost satellite frequencies, then it would be meaningful.

With more meetings on the horizon, the ARRL's job is far from over. It must learn and completely understand a totally new communications technology in record time if amateur radio is to survive the space race. The OSCAR program is just the tip of the iceberg. If we can somehow get back even the smallest sliver of what was lost in '72, then that will be a real victory. It might be wise to look toward AMSAT rather than Newington for leadership in this one, since those in AMSAT are the people who really understand the future and where it can lead. Today, we take terrestrial repeater stations for granted. They're everywhere, and a little 1-Watt hand-held radio lets you talk for miles. Someday, transceivers one-fourth that size may permit worldwide "amateur-to-amateur" communications,

through some form of geosynchronous satellite network. The technology is on its way. The only problem left is where there will be amateur spectrum for their use.

THE BAJA 1000 STORY

We close this month with an item that will be of interest to many amateurs. It's the story of the Baja 1000 Off-Road Race and how amateur radio participated in it. The following letter from Earl Grandison K6WS, vice president of the Baja Amateur Radio Racing Association, tells it all.

"I thought that a rundown of the Baja Amateur Radio Racing Association (BARRA) activities in support of the Baja 1000 Off-Road Race between Ensenada and La Paz would be of interest.

"We established eleven radio stations, including remote transmitting and receiving sites for the net control in Ensenada. These stations were located at Ensenada, La Paz, and nine checkpoints along the 985-mile off-road course.

"Besides handling passing times and broken vehicle reports, we also provided three aircraft for rescue purposes, each of which was equipped with amateur radio equipment to communicate on VHF directly with any checkpoint. The race began at dawn on Wednesday, November 7th, and finished Friday evening. The fastest vehicles completed the course in a little over nineteen hours.

"Thursday evening there was considerable concern over reports that a bike rider had suffered a broken arm and was somewhere on the 160-mile stretch between checkpoint 7 and checkpoint 6, and that car 100 had crashed somewhere along that stretch and the driver was out of water. Andrew Acevedo WA6DPR started north from checkpoint 7 in the dark in his four-wheel-drive mobile unit. Several hours later, he encountered a Mexican. Since Acevedo speaks fluid Spanish, he was able to determine that the injured bike rider had been taken to a small fishing village which was not on the map. He headed in that direction and reported via radio that he had the lights of a small village ahead and that a vehicle was approaching. The vehicle was driven by a Mexican citizen who was bringing the injured rider, Jesus Martinez (a resident of Ensenada) to checkpoint 7. He was transferred to Acevedo's vehicle, where it was determined that he had a broken collarbone. First aid instructions were provided by medics in La Paz and Acevedo immobilized the broken collarbone. He also learned from the Mexican citizen that car 100 was located 50 miles south of checkpoint 6, from which a rescue team had been dispatched to pick this driver up later that evening. The Helio Courier *Angel One* was at San Ignacio (checkpoint 6) and

Continued on page 141



When car 204 checked into checkpoint 2, it was interesting to note that the right rear tire was flat and that the driver had 92 miles to go before he reached the next pit crew.



K6W's VW camper contained the high frequency radio station used during the Baja 1000. Members of BARRA used a Ten-Tec 544 running off two large marine storage batteries and a Ten-Tec tuner feeding into a 122' longwire (which can be seen coming out of the insulator behind the driver's door). Mike, the junior op of K6WS who was responsible for the campfire, is shown talking to Dick Hojaboom WA6YCG, the chief operator at checkpoint 2.

THE OMNI SYSTEM — tools of the trade for serious DX operators, contesters, traffic, nets, or just rag chewing — designed to give you the operating edge.

Simply Super. The keynote of a Ten-Tec OMNI is simplicity of operation combined with super performance. No tricky controls, no distracting readings, no fussy adjustments. Your operating is pure enjoyment, unhampered by complexity, enhanced by features that are meaningful, advanced by options that are realistic.

Instant Band Change—to catch the openings. Just flip the bandswitch, no tuning the transmitter. A convenience originated by Ten-Tec in modern transceivers.

Full Break-In—for CW with perfect timing, for a real conversation in code. And slow break-in at the flip of a switch to suit band conditions or quiet mobile operation.

Ultra Selectivity—to fit any band condition. Standard 2.4 kHz 8-pole crystal ladder filter for normal reception; optional 1.8 kHz filter (\$55) operates in series with the 2.4 kHz filter to transform an unreadable signal in heavy QRM into one that gets the message through; optional 0.5 kHz 8-pole filter (\$55) provides steep, deep skirts to the CW passband window to cut out even those strong adjacent signals; standard 150 Hz CW active audio filters have three ranges (450, 300, 150 Hz) for further attenuation of adjacent signals and band noise.

Variable Notch Filter—to eliminate interfering carriers and CW signals. Attenuation is more than 8 "S" units (over 50 dB).

Six-Function Separate VFO—for complete versatility in working DX. Independent transmit and receive frequencies with OMNI; reversible at the touch of a button for full monitoring of the action. Even allows simultaneous reception on both VFO and OMNI with transmission on either. LEDs show status. An optional operating bargain at \$139.

Speech Processor and Microphone—to extend your operating range under adverse conditions by increasing average envelope power without derating the OMNI power limits and with minimum distortion. Model 234 is a true RF processor, model 214 is a peak-free condenser microphone. An optional system for optimum speech energy; 234 is \$124, 214 is \$39.

Electronic Keyer—key to perfect CW. Styled to match OMNI; self-completing; dit and dah memories with individual defeat switches; automatic variable weighting; adjustable magnetic paddle return; and more for just \$85.

Matching Power Supply—to completely power the OMNI system. Regulated, over-current protected, switched from OMNI or front panel, and only \$139.

Plus All These Famous Standard Features of OMNI—All Solid-State, 160-10 Meters, Built-in VOX and PTT, Dual-Range Receiver Offset Tuning, Wide Overload Capabilities, Adjustable Sidetone Tone and Level, Exceptional Sensitivity, 200 Watts Input, Adjustable ALC, 100% Duty Cycle, Phone Patch Interface Jacks, Zero-Beat Switch, "S"/SWR Meter, Dual Speakers, Plug-In Circuit Boards, Complete Shielding, Rigid Light-Weight Aluminum Construction, Comfortable Operating Size (5¾" h x 14¼" w x 14" d).

Model 545 Series B OMNI-A (analog transceiver) \$ 949

Model 546 Series B OMNI-D (digital transceiver) \$1119

Get The Operating Edge — Get The OMNI System. See your Ten-Tec dealer or write for full details.



TEN-TEC, HF equipment supplier to
Winter Olympics Radio Amateur Network (WORAN)

THE OPERATING EDGE



November, 1979, while not as hectic as October, offered a fine assortment of operations and increased activity for the chaser of countries, zones, prefixes, and awards. November is always sandwiched by the two weekends of the CQ Worldwide Contest, each requiring at least a week's recovery for the serious contester and DXer. For most of the world, the only band which allowed one any sleep at all during the contests was 10 meters, and then only five or six hours per night. If you operated 15, you missed some interesting dead-of-night openings if you crashed in bed.

6 meters opened during November, enabling many to complete Worked All States and starting others thinking of nabbing all continents. WL7ACY and AL7C supplied contacts with Alaska while KH6BZF and other Hawaiians worked all comers. On November 17, AL7C reportedly worked all 50 states. EI2W struggled mightily to cross the Rocky Mountains, while JA stations were worked as far east as Philadelphia. At this time, it appears the great barrier to WAC this sunspot peak will be Africa, where there is no activity on 50 MHz except for South Africa (ZS), which is a difficult proposition for North America.

With sunspot counts over 200 and solar flux measurements at 325 and above, all bands 1.8-50 MHz showered the active operator with worldwide opportunities during the autumn and early winter of 1979; DXing has never been better, not even during the sunspot peak of the late 50s, which had more sunspots. The reason? Activity, along with improved equipment. A glance at DX bulletins and reports in the magazines in 1958 and 1959 shows plenty of DX worked on 20, some on 15, but little on 10. Six meters was plied by the dyed-in-the-wool VHF operator, but equipment restraints kept most of the world's amateurs off both 6 and 10 meters. Reports from the old-timers of "10 meters open both short and long path to everywhere in the world 24 hours a day" in 1959 appear to have been greatly exaggerated.

Sunspots and the HF conditions they bring are of greatest value when an important expedition hits the bands, as the Saudi Arabian-Iraqi Neutral Zone 8Z4A operation in mid-November illustrated. While this group did not make their "goal" of 50,000 contacts, surely everyone who needed a contact with this "country" was able to work their S9 signal on at least one band. 8Z4A was everywhere at once, it seemed at times. They were observed on 80-10 meters during their ten days of activity. The expedition was mounted by a group of active Jordanian DXers, who took the best in equipment and antennas to ensure a successful operation. The final ingredient, a long run of operating, ruled out disaster in the form of a two- or three-day propagation wipeout from solar flares or magnetic storms. QSLs for 8Z4A are handled by Mary Ann Crider WA3HUP, RFD 2, Box 5A, York Haven PA 17370.

KH6GB came on from Wake Island (KH9) with an Argonaut during November for a few days; Wake's rareness had already been reduced considerably by an operation by Dan Lynch WD6CDU in July, 1979. KH6GB/KH9's five Watts were readily workable by many who had missed previous operations from Wake Island. QSL to KH6JUO (in the *Callbook*) or Harvey Sandal, 98-1077 Mahola Pl., Aiea HI 96701.

Another good one (two, actually) to get in November was SV0AA operating from, first, Crete, as SV0AA/9, then a week later as SV0AA/5 from the Dodecanese Islands. QSLs are via N2OO in the *Callbook*.

The YASME Foundation is sponsoring more operations by Iris and Lloyd Colvin, W6s QL and KG, respectively. They began a winter trip operating from Grenada, formerly VP2G and now J3. Signing J3ABV, the Colvins logged 10,000 contacts on 160-10 meters. They worked DXCC during the first week and then again during the CQ Phone Contest. Altogether, they worked 152 different countries, the most ever for them during a 3-4 week stay in one place. Grenada had a peaceful revolution and change of government

recently and the Colvins were forced to post a very large cash bond to cover their radio equipment.

The Colvins departed Grenada on November 9 and began operations a few days later from St. Vincent as VP2SAX. They were active during the CQ WW CW Contest and into early December, then were on to J7, St. Lucia. All QSLs for YASME operations go to YASME, PO Box 2025, Castro Valley CA 94546.

While we are on the subject of YASME, here is their latest press release, dated November 26, 1979:

"Effective 23 November 1979, there has been a reorganization of the YASME Foundation QSL-handling personnel. Primary sort of all incoming mail and first response to each operation is being handled by W6BSY, with assistance from WB6DOQ. Continuing response to all YASME Foundation DXpeditions, past and present, is being handled by WA6AKK. Mail for all YASME DXpeditions should continue to be sent to The YASME Foundation, PO Box 2025, Castro Valley CA 94546.

"The previous team of YASME QSL handlers was led by Ferne Hughes and WA6AHF, with assistance on continuing response by K6YK, K6PBT, and WA6CPP. They have now concluded their association with the YASME Foundation, and I wish to thank each of them for their many hours of time and effort.

"The speed of response to your QSL card request is determined by many factors, some of which are beyond your control. However, there are several things which should be done by anyone submitting a QSL card to the YASME Foundation, which will ensure the most expeditious return of the QSL card which is being sought (I cannot presume to speak for other QSL handlers, but I feel these same items would get good results from any source).

"These things to do are: 1) Always send a self-addressed envelope with enough of the sender's postage affixed, or include IRCs, to cover the cost of mailing your envelope back to you; please note that in the U.S., an airmail envelope must have airmail postage affixed to it or it will be returned. 2) Always use UTC, GMT, or Zulu (they're all

the same!) for the date and time of the contact. 3) Always send a separate QSL for each contact you wish confirmed. 4) Never send cards for more than one callsign (being handled at the same location) in the same envelope. 5) Never send more than one request for confirmation of the same contact unless you have waited a reasonable time (six months in many cases) to receive a reply. 6) It is suggested that one return envelope be provided for each card submitted for the fastest possible response. 7) Try to remember that the cards you seek are being answered by volunteers who have jobs, families, and other commitments and activities in their lives, as we all do, and give them the courtesy you would expect were you in their shoes."

Perhaps the above should have been titled "Novice Corner" for this month! Actually, we hear that managers of QSLs still receive 5-10 percent of cards with other than UTC, or the wrong date, or "I worked him sometime the third week of March; can you find me in the log?"

As predicted on these pages last month, the ARRL has indeed changed the format of the winter DX activity they sponsor. It is now called the ARRL International DX Contest. You can read the rules on page 94 of the December issue of *QST*. They aren't even used to the change down in Newington; the name of the activity has been changed from "Competition" to "Contest," yet the person who made out the table of contents in *QST* labeled it a Competition, while the announcement titled it a Contest. They are soliciting donors of plaques; for \$35 you can donate a plaque to be awarded to a fellow contester and deduct it from your taxes as a contribution to a nonprofit organization! ARRL HQ for details.

The WARC will end about a week after this is written; news from Geneva has been virtually non-existent due to pressure from the conference chairman. Calculated guesses at this point on the effect of the conference on DXing would seem to indicate possible new HF bands, opening up of the 50-MHz band in Europe, lowered CW requirements above 28 MHz, and

Continued on page 140

An Extraordinary Offer to introduce you to the benefits of Membership in

ELECTRONICS BOOK CLUB

invites you to take
this 1,442-page
Computer Library
for only

\$ **1.99**

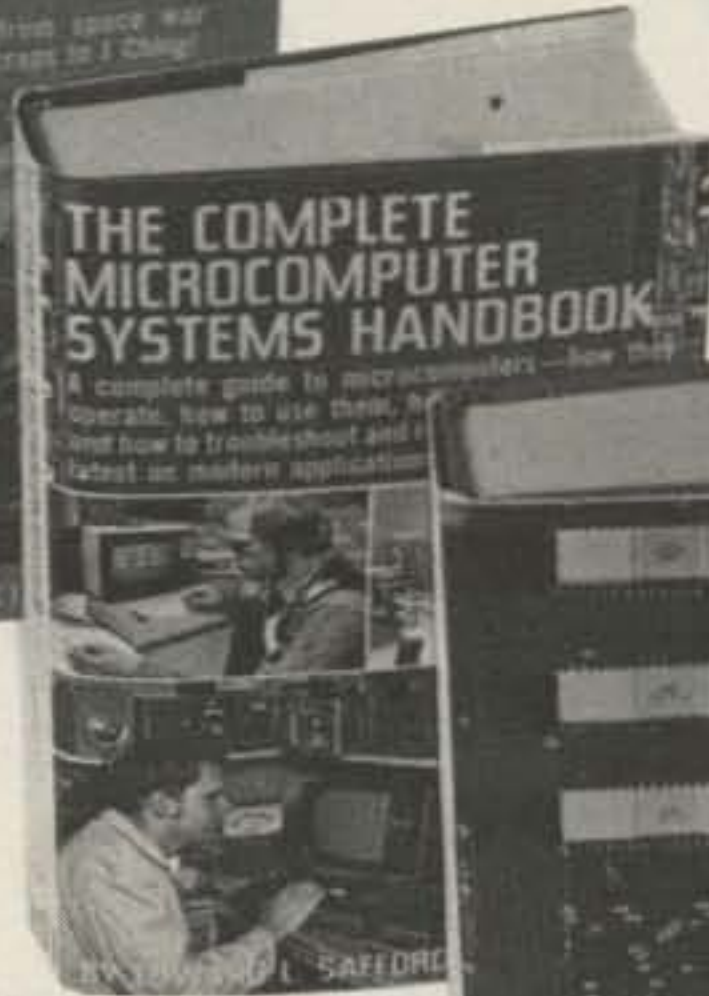
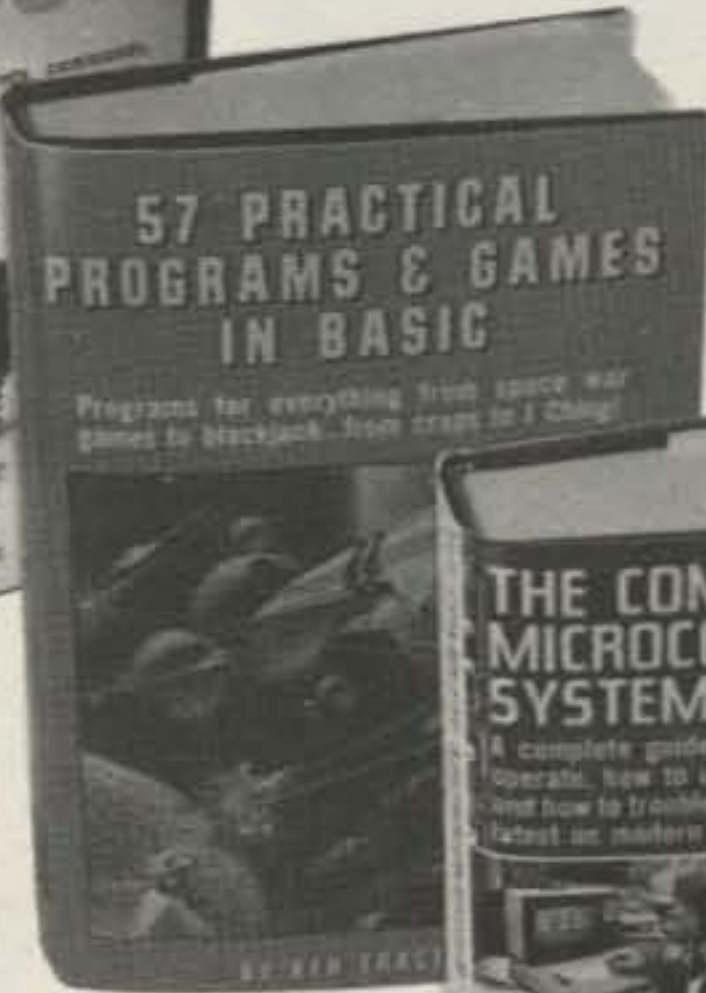

You
Get **ALL**
FIVE of These
Huge Books
For Only
\$1.99

Microprocessor Cookbook

A chip-by-chip comparison of the most popular modern microprocessors—including programming, architecture, addressing, instruction sets, and applications! You get complete data on what makes up the structure of a microprocessor chip and a microcomputer, how to give instructions, the overall organization of a computer system, and more. Then you get a chip-by-chip profile of modern microprocessors—with thorough discussions of applications, architecture, functions, etc. Included are the Intel 8080, Motorola 6800, Fairchild's F8 family, Zilog Z80, TI's TMS 9900, National Semi SC/MP, Intel's 8021, and many more. 266 pps., 124 illus. List \$9.95

The BASIC Cookbook

A complete dictionary of all BASIC statements, commands, and functions—with programming examples and flowcharts. Thoroughly defines the BASIC vocabulary in alphabetical order, illustrates the definitions with sample programs, and further clarifies the programs with matching flowcharts... plus explaining BASIC system commands. You'll learn how to professionally manipulate and use each BASIC term in a workable program. Also defines programming terms that apply to APL, ALGOL, COBOL, FORTRAN, RPG, PL1, etc. 140 pps., 49 illus. List \$7.95

57 Practical Programs & Games in BASIC

57 of the hardest working, most enjoyable BASIC programs you've ever seen... everything from space war games to blackjack, from craps to I Ching, from arithmetic progression to statistical permutations to one-arm bandits! It's an easy-to-use manual that gives you 57 different simplified BASIC programs... all ready to run! You can program your minibrain for all kinds of fun and games, or for solving many different types of problems. 210 pps., 64 illus. List \$10.95

Complete Microcomputer Systems Hdbk.

A complete guide to microcomputers—how they operate, how to use them, how to program them, and how to troubleshoot, test, and repair them... plus the very latest on modern applications like magnetic bubble memories, computers in networks, computer decision making, simulation and forecasting, teaching machines to learn, robot control, speech synthesizers, digital music, mobile computers, etc. There's extensive coverage of computer problems and how to diagnose and repair them, plus lots of hard debugging data. You'll learn how to find and fix all types of mechanical and electronic troubles—plus how to use test signals and closed loop signals, how to replace chips, how to align disc drives, etc. 322 pps., 147 illus. List \$15.95

The Giant Handbook of Computer Projects

This MAMMOTH 504-page step-by-step guide to building modern computers and accessories—CPUs, memories, I/O hardware, etc.—is a HUGE collection of ready-to-use construction info. It's a builder's dream, with projects, complete schematics, parts lists, and step-by-step construction instructions that let you build your own systems. Also contains a thorough discussion of microprocessors, with comparisons of several units, including the Kim-1, the Z-80, and the 8080, etc... plus data on memory boards, RAM checkout, PROM programmers, memory chips, inexpensive input/output devices, paper tape systems, interfacing with clock chips, and more. 504 pps., 217 illus. List \$15.95

Let us send you this 5-volume, 1,442 page Computer Library as part of an unusual offer of a Trial Membership in Electronics Book Club.

Here are quality hardbound volumes, each especially designed to help you increase your know-how, earning power, and enjoyment of electronics and computers. Whatever your interest in electronics/computers, you'll find Electronics Book Club offers practical, quality books that you can put to immediate use and benefit.

This extraordinary offer is intended to prove to you, through your own experience, that these very real advantages can be yours... that it is possible to keep up with the literature published in your areas of interest, and to save substantially while so doing. As part of your Trial Membership, you need purchase as few as four books during

- ✓ Only \$1.99 for ALL FIVE!
- ✓ Regular List Price \$60.75
- ✓ Top-Quality Hardbinding
- ✓ Contains the very latest info on computers!
- ✓ Over 600 illustrations
- ✓ Contains over 500,000 words
- ✓ 1,442 data-packed pages

the coming 12 months. You would probably buy at least this many anyway, without the substantial savings offered through Club Membership.

To start your Membership on these attractive terms, simply fill out and mail the coupon today. You will receive the 5-volume Computer Library for 10-day inspection. YOU NEED SEND NO MONEY. If you're not delighted, return the books within 10 days and your Trial Membership will be cancelled without cost or obligation.

ELECTRONICS BOOK CLUB, Blue Ridge Summit, Pa. 17214

Facts About Club Membership

- The 5 introductory books carry a publisher's retail price of \$60.75. They are yours for only \$1.99 for all 5 (plus postage/handling) with your Trial Membership.
- You will receive the Club News, describing the current Selection, Alternates, and other books, every 4 weeks (13x a year).
- If you want the Selection, do nothing; it will be sent to you automatically. If you do not wish to receive the Selection, or if you want to order one of the many Alternates offered, you simply give instructions on the reply form (and in the envelope) provided, and return it to us by the date specified. This date allows you at least 10 days in which to return the form. If, because of late mail delivery, you do not have 10 days to make a decision and so receive an unwanted Selection, you may return it at Club expense.
- To complete your Trial Membership, you need buy only four additional monthly Selections or Alternates during the next 12 months. You may cancel your Membership any time after you purchase these four books.
- All books—including the introductory Offer—are fully returnable after 10 days if you're not completely satisfied.
- All books are offered at low Member prices, plus a small postage and handling charge.
- **Continuing Bonus:** If you continue after this Trial Membership, you will earn a Dividend Certificate for every book you purchase. Three Certificates plus payment of the nominal sum of \$1.99 will entitle you to a valuable Book Dividend of your choice which you may choose from a list provided Members.

ELECTRONICS BOOK CLUB ✓ E58

Blue Ridge Summit, Pa. 17214

Please open my Trial Membership in ELECTRONICS BOOK CLUB and send my 5-volume Computer Library, invoicing me for only \$1.99 plus shipping. If not delighted, I may return the books within 10 days and owe nothing, and have my Trial Membership cancelled. I agree to purchase at least four additional books during the next 12 months after which I may cancel my membership at any time.

Name _____ Phone _____

Address _____

City _____

State _____ Zip _____

(Valid for new Members only. Foreign and Canada add 15%.) PE-280

Antenna Tuner



\$299.95

Here is a new tuner that puts more power into your antenna, works from 160 through 10 meters, handles full legal power and then some, and works with coax, single wire and balanced lines. And it lets you tune up without going on the air!

WE INVESTIGATED

All tuners lose some rf power. We checked several popular tuners to see where the losses are. Mostly they are in the inductance coil and the balun core.

So we switched from #12 wire for the main inductor to 1/4" copper tubing. It can carry ten times the rf current. And we've moved the balun from the output, where it almost never sees its design impedance, to the input where it always does. Thus more power to your antenna.

IMPOSSIBLE FEAT

The biggest problem with tuners is getting them tuned up. With three knobs to tune on your transceiver and three on the tuner and ten seconds to do it (see the warning in your transceiver manual) that's 1 1/2 seconds per knob.

We have a better way; a built-in 50-ohm noise bridge that lets you set the tuner controls without transmitting. And a switch that lets you tune your transmitter into a dummy load. So you can do the whole tuneup without going on the air. Saves that final; cuts QRM.

BROCHURE AVAILABLE NOW

For further details on this exciting new high-power low-loss, easy-to-use tuner send for our new brochure. Or visit your Palomar Engineers dealer.

To order send \$10 shipping/handling. California residents add sales tax.



Palomar Engineers

Box 455, Escondido, CA. 92025 • Phone: [714] 747-3343

Completely Free
Standing Towers

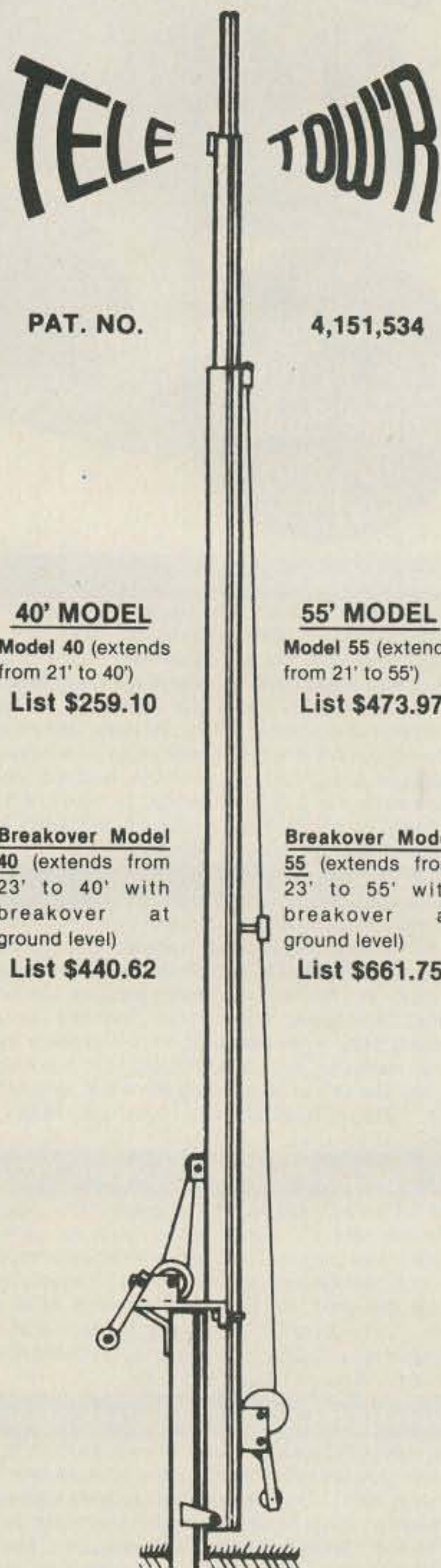

PAT. NO.

4,151,534

40' MODEL

Model 40 (extends from 21' to 40')

List \$259.10

55' MODEL

Model 55 (extends from 21' to 55')

List \$473.97

Breakover Model

40 (extends from 23' to 40' with breakover at ground level)

List \$440.62

Breakover Model

55 (extends from 23' to 55' with breakover at ground level)

List \$661.75

All steel constructed.

Concrete sleeve available for all models.

TELE-TOW'R MFG. CO., INC.

P.O. Box 3412 • Enid, OK 73701

405-233-4412

✓ T52

New, Stronger Wilson Towers



Hinged Base Plate - Concrete Pad, Heavy Duty Winch



Mounting the House Bracket



The Hinged Base Plate allows tower to be tilted over for access to antenna and rotor from the ground.

FACTORY DIRECT
\$279⁹⁵

TT-45B

FEATURES:

- Maximum Height 45' (will handle 17 sq. ft. @ 38 ft. or 10 sq. ft. @ 45 ft.) @ 50 mph
- 1200 lb. winch
- Totally freestanding with proper base
- Total Weight, 243 lbs.

The TT-45B is a freestanding tower, ideal for installations where guys cannot be used. If the tower is not being supported against the house, the proper base fixture accessory must be selected. (Requires 12"x12"x36" of concrete.)

GENERAL FEATURES

All towers use high strength heavy galvanized steel tubing that conforms to ASTM specifications for years of maintenance-free service. The large diameters provide unexcelled strength. All welding is performed with state-of-the-art equipment. Top sections are 2" O.D. for proper antenna/rotor mounting. A 10' push-up mast is included in the top section of each tower. Hinge-over base plates are standard with each tower. The high loads of today's antennas make Wilson crank-ups a logical choice. Prices and specifications subject to change without notice.

FACTORY DIRECT
\$489⁹⁵

NEW IMPROVED FEATURE

A new high strength carbon steel tube manufactured especially for Wilson Systems, is used for the new TT45B and MT61B. 25% stronger than conventional pipe or tubing. Tube size: 3.5" O.D. @ .095, 4.5" & 6" O.D. @ .120.

MT-61B

FEATURES:

- Is freestanding with use of proper base
 - Maximum Height 61' (will handle 17 sq. ft. @ 53 ft. or 10 sq. ft. @ 61 ft.) @ 50 mph
 - 1200 lb. brake winch
 - 4200 lb. raising cable
 - Total Weight, 400 lbs.
- Recommended base accessory: RB-61B, FB-61B

The MT-61B is our largest and tallest freestanding tower. By using the RB-61B rotating base fixture the MT-61B is ideally suited for the SY33 or SY-36. If you plan to mount the tower to your house, caution should be taken to make certain the eave is properly reinforced to handle the tower. If not, one of the base accessory fixtures should be used. (Requires 18"x18"x48" concrete.)

TILT-OVER BASES FOR TOWERS

FIXED BASE

The FB Series was designed to provide an economical method of moving the tower away from the house. It will support the tower in a completely free-standing vertical position, while also having the capabilities of tilting the tower over to provide an easy access to the antenna. The rotor mounts at the top of the tower in the conventional manner, and will not rotate the complete tower.

FB-45B ... \$114.95
FB-61B ... 169.95

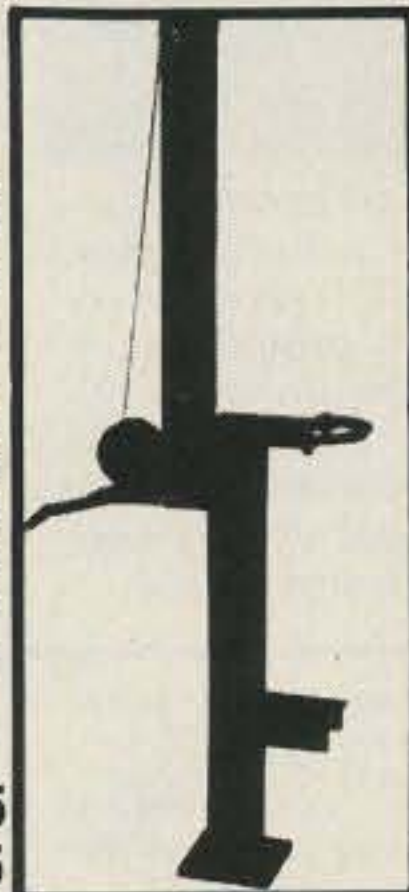

ROTATING BASE

The RB Series was designed for the Amateur who wants the added convenience of being able to work on the rotor from the ground position. This series of bases will give that ease plus rotate the complete tower and antenna system by the use of a heavy duty thrust bearing at the base of the tower mounting position, while still being able to tilt the tower over when desiring to make changes on the antenna system.

RB-45B ... \$179.95
RB-61B ... 249.95

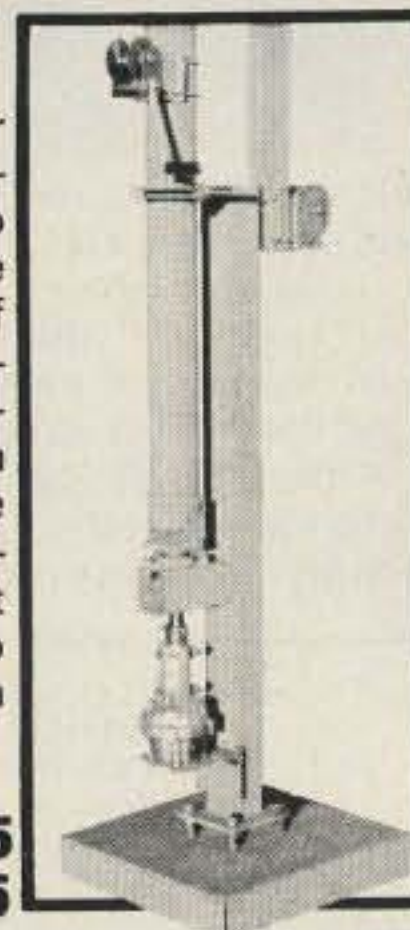

Tilting the tower over is a one-man task with the Wilson bases. (Shown above is the RB-61B. Rotor is not included.)

ORDER
FACTORY DIRECT
1-800-634-6898

W S I WILSON SYSTEMS, INC.

4286 S. Polaris Ave., Las Vegas, Nevada 89103

W33

NEW
ST64 - 64 ft. Stacking Tower
ST77 - 77 ft. Stacking Tower
CALL FOR INFORMATION

WILSON SYSTEMS INC. MULTI-BAND ANTENNAS

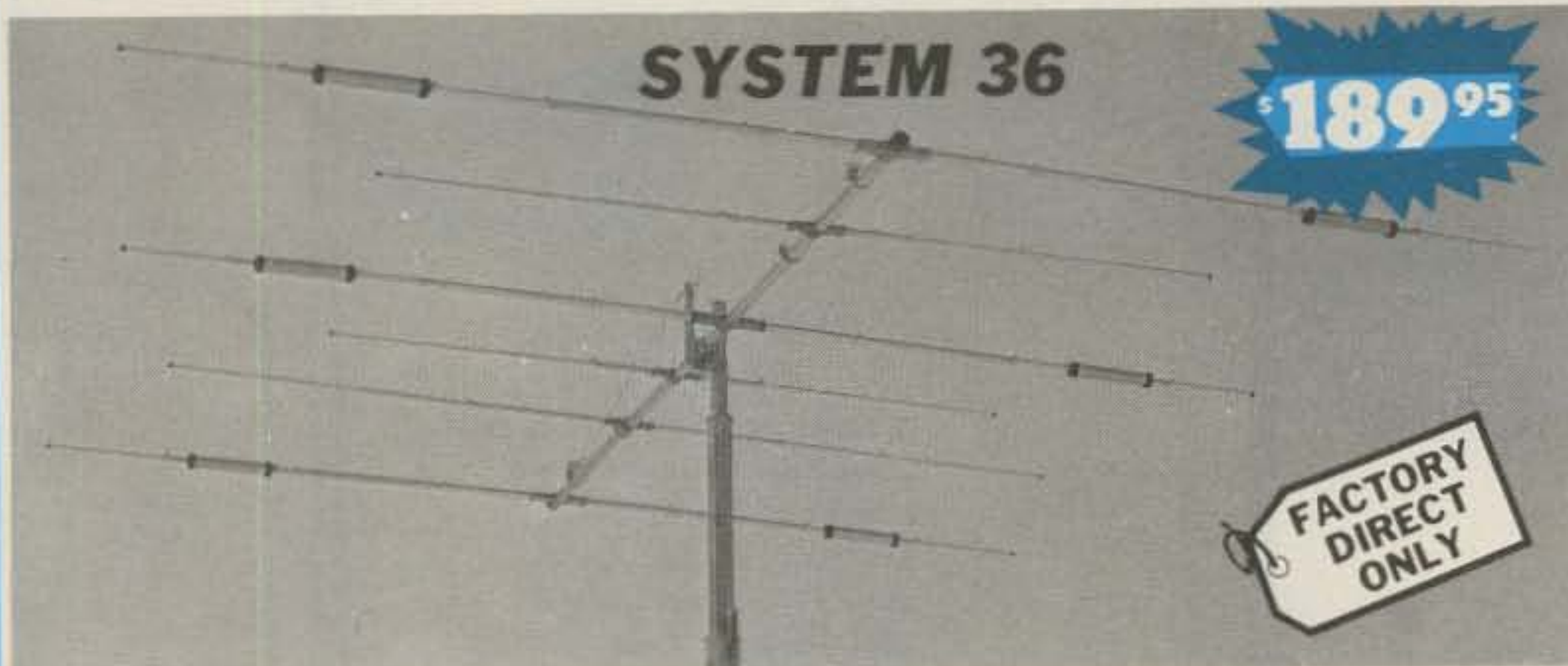

A trap loaded antenna that performs like a monobander! That's the characteristic of this six element three band beam. Through the use of wide spacing and interlacing of elements, the following is possible: three active elements on 20, three active elements on 15 and four active elements on 10 meters. No need to run separate coax feed lines for each band, as the bandswitching is automatically made via the High-Q Wilson traps. Designed to handle the maximum legal power, the traps are capped at each end to provide a weather-proof seal against rain and dust. The special High-Q traps are the strongest available in the industry today.

SPECIFICATIONS

Band MHz 14-21-28
 Maximum power input . . . Legal Limit
 Gain (dBd) Up to 9 dB
 VSWR @ resonance . . . 1.3:1
 Impedance 50 ohm
 F/B Ratio 20 dB or better

Boom (O.D. x Length) . . . 2" x 24' 2 1/2"
 No. of Elements 6
 Longest Element 28' 2 1/2"
 Turning Radius 18' 6"
 Maximum mast diameter . . 2"
 Surface area 8.6 sq. ft.

Matching Method Beta
 Wind Loading @ 80 mph . . . 215 lbs.
 Maximum wind survival . . . 100 mph
 Feed method Coaxial Balun (supplied)
 Assembled weight (approx) . 53 lbs.
 Shipping weight (approx) . . 62 lbs.

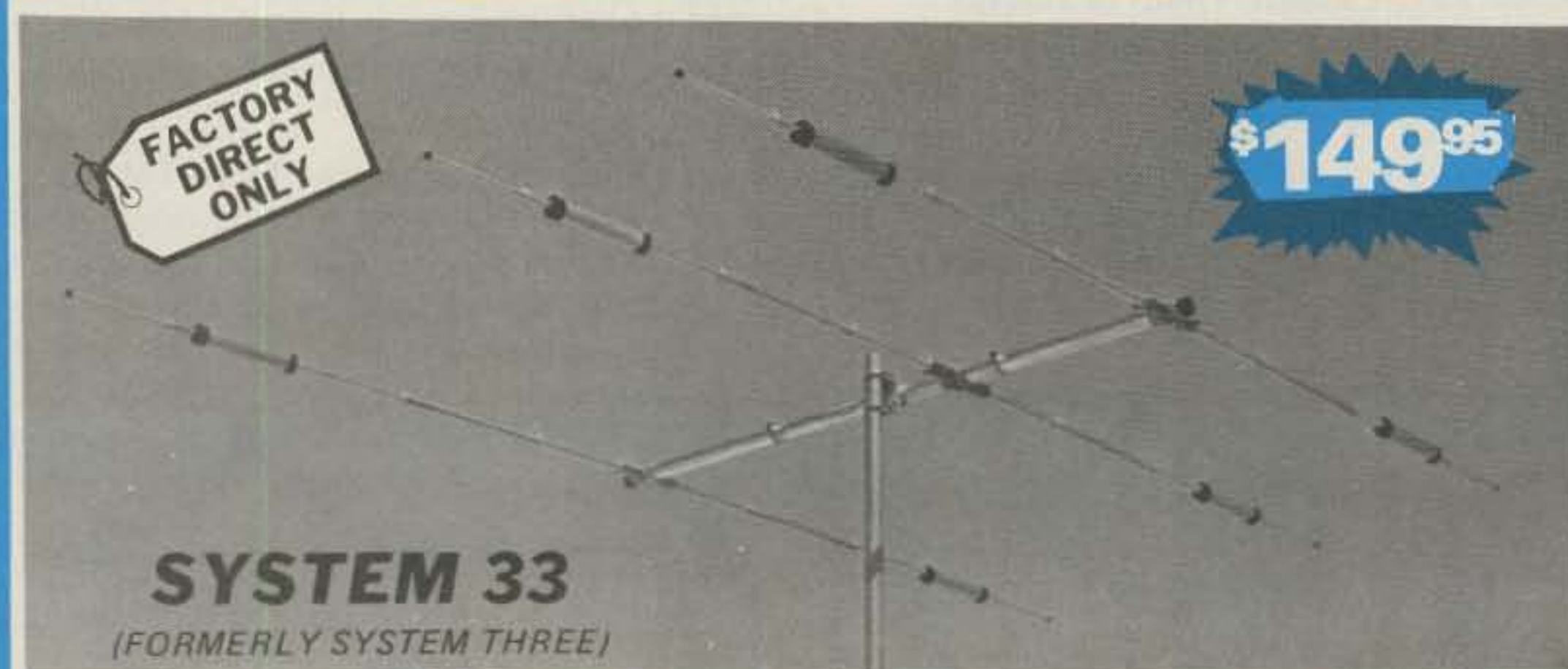
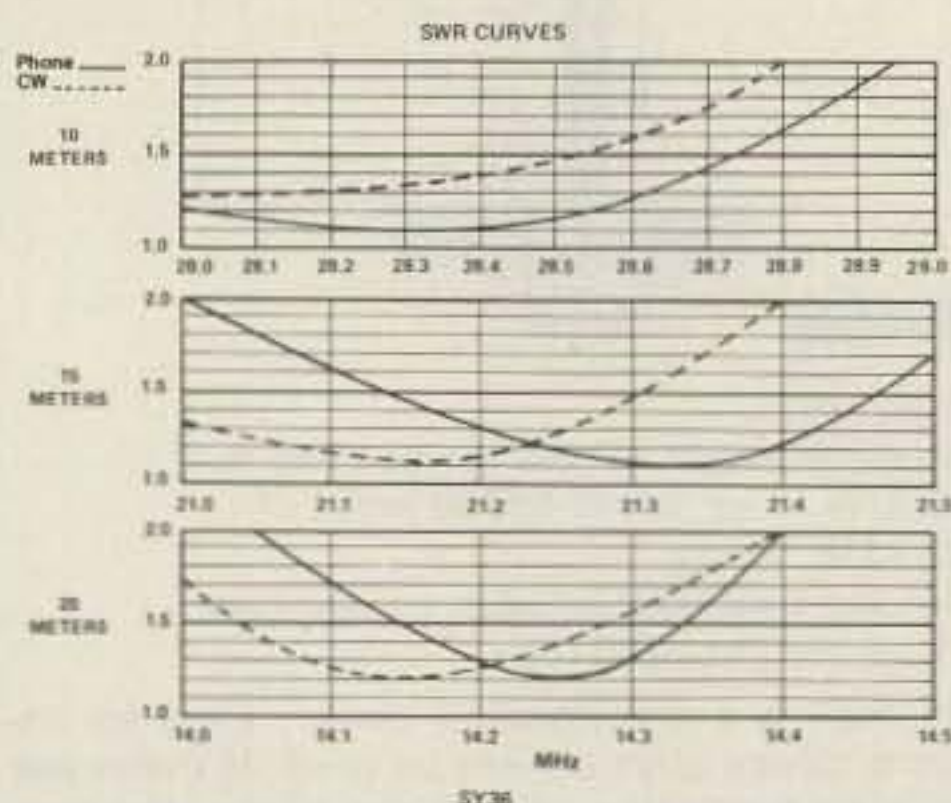

SYSTEM 33 (FORMERLY SYSTEM THREE)

Capable of handling the Legal Limit, the "SYSTEM 33" is the finest compact tri-bander available to the amateur. Designed and produced by one of the world's largest antenna manufacturers, the traditional quality of workmanship and materials excels with the "SYSTEM 33". New boom-to-element mount consists of two 1/8" thick formed aluminum plates that will provide more clamping and holding strength to prevent element misalignment. Superior clamping power is obtained with the use of a rugged 1/4" thick aluminum plate for boom to mast mounting. The use of large diameter High-Q traps in the "SYSTEM 33" makes it a high performing tri-bander and at a very economical price. A complete step-by-step illustrated instruction manual guides you to easy assembly and the lightweight antenna makes installation of the "SYSTEM 33" quick and simple.

SPECIFICATIONS

Band MHz 14-21-28
 Maximum power input . . . Legal Limit
 Gain (dbd) Up to 8 dB
 VSWR at resonance . . . 1.3:1
 Impedance 50 ohms
 F/B Ratio 20 dB or better

Boom (O.D. x length) . . . 2" x 14' 4"
 No. of elements 3
 Longest element 27' 4"
 Turning radius 15' 9"
 Maximum mast diameter . . 2" O.D.
 Surface area 5.7 sq. ft.

Wind loading at 80 mph . . . 114 lbs.
 Assembled weight (approx) . 37 lbs.
 Shipping weight (approx) . . 42 lbs.
 Direct 52 ohm feed - no balun required
 Maximum wind survival . . . 100 mph

W S I WILSON SYSTEMS, INC.

4286 S. Polaris Ave., Las Vegas, Nevada 89103
 Prices and specifications subject to change without notice.

ORDER FACTORY DIRECT 1-800-634-6898



WV-1A 4 BAND TRAP VERTICAL (10 - 40 METERS)

No bandswitching necessary with this vertical. An excellent low cost DX antenna with an electrical quarter wavelength on each band and low angle radiation. Advanced design provides low SWR and exceptionally flat response across the full width of each band.

Featured is the Wilson large diameter High-Q traps which will maintain resonant points with varying temperatures and humidity.

Easily assembled, the WV-1A is supplied with a hot dipped galvanized base mount bracket to attach to vent pipe or to a mast driven in the ground.

Note:
Radials are required for peak operation. (See GR-1 below)

SPECIFICATIONS

- 19' total height
- Self supporting - no guys required
- Weight - 14 lbs.
- Input impedance: 50 Ω
- Powerhandling capability: Legal Limit
- Two High-Q traps with large diameter coils
- Low angle radiation
- Omnidirectional performance
- Taper swaged aluminum tubing
- Automatic bandswitching
- Mast bracket furnished
- SWR: 1.1:1 or less on all bands



The GR-1 is the complete ground radial kit for the WV-1A. It consists of: 150' of 7/14 stranded copper wire and heavy duty egg insulators, instructions. The GR-1 will increase the efficiency of the WV-1A by providing the correct counterpoise.

WILSON MONO-BAND BEAMS

FACTORY DIRECT ONLY

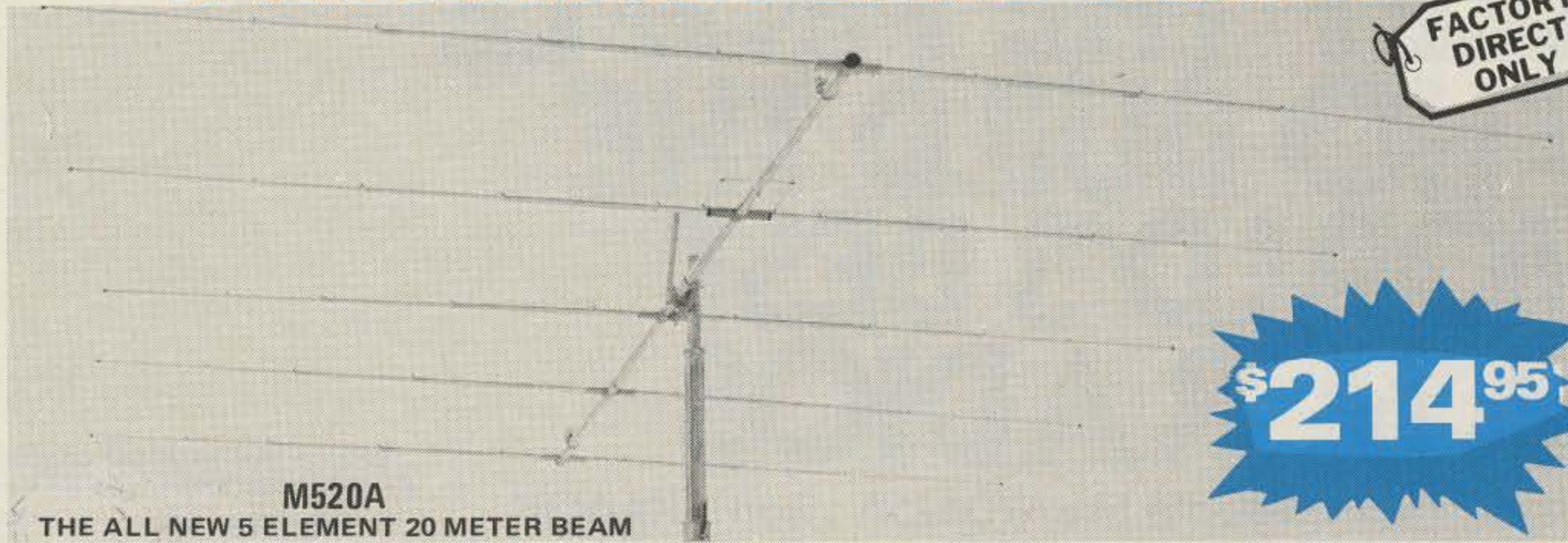

\$214⁹⁵

M520A

THE ALL NEW 5 ELEMENT 20 METER BEAM

At last, the antennas that you have been waiting for are here! The top quality, optimum spaced, and newest designed monobanders. The Wilson System's new Monoband beams are the latest in modern design and incorporate the latest in design principles utilizing some of the strongest materials available. Through the select use of the current production of aluminum and the new boom-to-element plates, the Wilson Systems' antennas will stay up when others are falling down due to heavy ice loading or strong winds. Note the following features:

- 1. Taper Swaged Elements** — The taper swaged elements provide strength where it counts and lowers the wind loading more efficiently than the conventional method of telescoping elements of different sizes.
- 2. Mounting Plates — Element to Boom** — The new formed aluminum plates provide the strongest method of mounting the elements to the boom that is available in the entire market today. No longer will the elements tilt out of line if a bird should land on one end of the element.
- 3. Mounting Plates — Boom to Mast** — Rugged 1/4" thick aluminum plates are used in combination with sturdy U-bolts and saddles for superior clamping power.
- 4. Holes** — There are no holes drilled in the elements of the Wilson HF Monobanders. The careful attention given to the design has made it possible to eliminate this requirement as the use of holes adds an unnecessary weak point to the antenna boom.

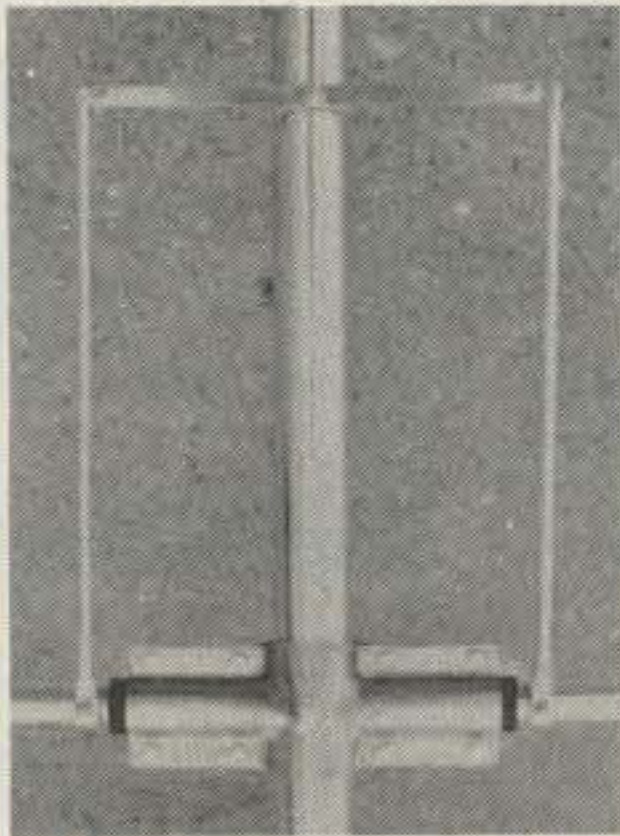

Wilson's Beta match offers maximum power transfer.

With the Wilson Beta-match method, it is a "set it and forget it" process. You can now assemble the antenna on the ground, and using the guide-lines from the detailed instruction manual, adjust the tuning of the Beta-match so that it will remain set when raised to the top of the tower.

The Wilson Beta-match offers the ability to adjust the terminating impedance that is far superior to the other matching methods including the Gamma match and other Beta matches. As this method of matching requires a balanced line it will be necessary to use a 1:1 balun, or RF choke, for the most efficient use of the HF Monobanders.

The Wilson Monobanders are the perfect answer to the Ham who wants to stack antennas for maximum utilization of space and gain. They offer the most economical method to have more antenna for less money with better gain and maximum strength. Order yours today and see why the serious DXers are running up that impressive score in contests and number of countries worked.

SPECIFICATIONS

Model	Band Mtrs	Gain dBd	F/B Ratio	Bandwidth @ Resonance 2:1 VSWR Limits	VSWR @ Resonance	Impedance	Matching	Elements	Longest Element	Boom O.D.	Boom Length	Turning Radius	Surface Area (Sq.Ft.)	Windload @ 80 mph (Lbs.)	Maximum Mast	Assembled Weight (Lbs.)
M520A	20	11.5	25 dB	500 KHz	1.1:1	50 Ω	Beta	5	36'6"	2"	34'2 1/2"	25'1"	8.9	227	2"	68
M420A	20	10.0	25 dB	500 KHz	1.1:1	50 Ω	Beta	4	36'6"	2"	26'0"	22'6"	7.6	189	2"	50
M515A	15	12.0	25 dB	400 KHz	1.1:1	50 Ω	Beta	5	25'3"	2"	26'0"	17'6"	4.2	107	2"	41
M415A	15	10.0	25 dB	400 KHz	1.1:1	50 Ω	Beta	4	24'2 1/2"	2"	17'0"	14'11"	3.1	54	2"	25
M510A	10	12.0	25 dB	1.5 MHz	1.1:1	50 Ω	Beta	5	18'6"	2"	26'0"	16'0"	2.8	72	2"	36
M410A	10	10.0	25 dB	1.5 MHz	1.1:1	50 Ω	Beta	4	18'3"	2"	12'11"	11'3"	1.4	36	2"	20

WILSON SYSTEMS, INC. — 4286 S. Polaris
Las Vegas, NV 89103 — (702) 739-7401

**FACTORY DIRECT
ORDER BLANK**

Toll-Free Order Number

1-800-634-6898

WILSON SYSTEMS ANTENNAS

Qty	Model	Description	Shipping	Price
	SY33	3 Ele. Tribander for 10, 15, 20 Mtrs.	UPS	\$149.95
	SY36	6 Ele. Tribander for 10, 15, 20 Mtrs.	UPS	199.95
	WV-1A	Trap Vertical for 10, 15, 20, 40 Mtrs.	UPS	49.95
	GR-1	Ground Radials for WV-1A	UPS	10.95
	M-520A	5 Elements on 20 Mtrs.	TRUCK	214.95
	M-420A	4 Elements on 20 Mtrs.	UPS	149.95
	M-515A	5 Elements on 15 Mtrs.	UPS	129.95
	M-415A	4 Elements on 15 Mtrs.	UPS	84.95
	M-510A	5 Elements on 10 Mtrs.	UPS	84.95
	M-410A	4 Elements on 10 Mtrs.	UPS	69.95
	WM-62A	Mobile Antenna: 5/8 λ on 2, 1/4 λ on 6	UPS	19.95
	HD-73	Alliance Heavy Duty Rotor	UPS	109.95
	RC-8C	8/C Rotor Cable	UPS	.12/ft.
	RG-8U	RG-8U Foam-Ultra Flexible Coaxial Cable. 38 strand center conductor, 11 guage	UPS	.21/ft.

WILSON SYSTEMS TOWERS

Qty.	Model	Description	Shipping	Price
	TT-45B	Freestanding 45' Tubular Tower	TRUCK	\$279.95
	RB-45B	Rotating Base for TT-45A w/tilt over feature	TRUCK	179.95
	FB-45B	Fixed Base for TT-45A w/tilt over feature	TRUCK	114.95
	MT-61B	Freestanding 61' Tubular Tower	TRUCK	489.95
	RB-61B	Rotating Base for MT-61A w/tilt over feature	TRUCK	249.95
	FB-61B	Fixed Base for MT-61A w/tilt over feature	TRUCK	169.95

NOTE:

On Coaxial and Rotor Cable, minimum order is 100 ft. and in 50' multiples.
Prices and specifications subject to change without notice.
Ninety Day Limited Warranty, All Products FOB Las Vegas, Nevada

PRICES EFFECTIVE FEBRUARY 1, 1980

Nevada Residents Add Sales Tax

Ship C.O.D. Check enclosed Charge to Visa M/C

Card # _____ Expires _____

Bank # _____ Signature _____

Please Print

Name _____ Phone _____

Street _____

City _____ State _____ Zip _____

Prices and specifications subject to change without notice.

WILSON SPECIAL

AIRCRAFT CABLE:

3/16", 1x19: .10/ft (min. 1000 ft)

1/8", 1x19: .06/ft (min. 1000 ft)

Heavy duty 6" turnbuckles: \$1.50 ea. (min. 10)

12" eye bolts, 1/2" stock: .75 ea. (min. 10)

Cable clamps: .25 ea. (min. 50)

MEET THE PEOPLE WHO BUILD THE WORLD'S BEST HAM RADIOS

The Swan Team: People like WD6ESA (Geri), KA6CRI (Boyd), KA6HBW (Frank), N6LT (Tom), N6BMK (Paul), N6OK (Rick), WB6DXW (Ken), W6GBL (Glen), K6TSD (Sam), KA6BRH (Jess), W6TXH (Bob), WB6LEC (Ken), KA4FYE (Bill), W6OML (Dick), K6CAQ (Gary), K6ERW (Chuck), Committed to the best in ham radio.

Swan's professional engineering design team combines 83 years of in-depth experience directly related to the design of high technology communications equipment. From transceivers to computers, this team turns ideas into hardware.

Swan, a division of Cubic Communications, is staffed with a professional team that knows and understands the ham business. As a



member of the Cubic family of companies, we are a financially strong organization, with the latest in manufacturing and test equipment, located in a modern facility in Oceanside, California.

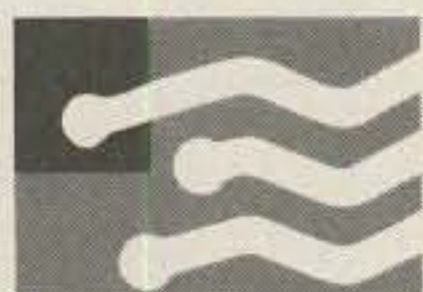

**American Technology,
American Designed,
American Manufactured.**
Your security in long term support for products made by fellow Americans.



Customer Service,
your guarantee of service after sale for all Swan products. We care about your satisfaction.



Each piece of equipment is carefully and thoroughly checked and calibrated by the Quality Control Team before shipment. All this plus a 72-hour bake-in to insure the high reliability that goes with every piece of Swan gear.



A division of Cubic Communications, Inc.

✓ S44 305 Airport Road
Oceanside, CA 92054
714-757-7525

Stop by the Swan Ham Shack on your next visit to Oceanside, California. You can operate on the air the newest and latest Swan equipment at station WB6IML. Ask a fellow ham on the marketing team for a plant tour.

A SWAN FOR EVERY NEED

Take a look at the three hottest new SSB Transceivers this year. They're all made in America and they're all from Swan. Whatever your dreams—from a compact fully synthesized mobile to a full-blown base station with dual PTO's—one of these will bring them to reality today. They're all solid state, all 235 Watts PEP and CW on all frequencies, and most of all they're affordable.

Most Advanced HF Transceiver in the World—ASTRO 150

HF SSB Transceiver featuring "VRS" a knob with a new twist, and over 100,000 fully microprocessor-controlled frequencies on present or envisioned "ham" bands.

- High Power — Full 235 Watts PEP & CW, all bands
- Truly Synthesized in accurate 100Hz steps
- Full CW Break-In with narrow XTAL Filter
- Standby Memory — ALL BANDS
- True PEP output meter
- Model 150 — 80 thru 10 meters
- Model 151 — 160 thru 15 Meters

Most Versatile HF 160M-10M Transceiver in the World—ASTRO 102 BX

Dual PTO's, 235 Watts PEP & CW on all frequencies, IF Passband tuning, with LED position indicators and full break-in.

- All solid state
- Modern design and styling
- Tunable notch filter
- 4 Function Meter
- Speech Processor
- VOX
- Adjustable AGC Decay
- 2 Position CW Wave Shaping
- 16 Pole IF Filter
- Crystal CW Filter
- PLL Synthesized Band Selection

Economy with top SWAN quality and mobility—100MX

235 Watts PEP & CW on all frequencies. The field-proven Rig the whole world's talking about.

- All solid-state
- Modern design and styling
- VOX
- Noise Blanker
- Semi-CW Break-in
- RIT $\pm 1.5\text{KHz}$
- 25 KHz Calibrator, built-in
- CW side tone with adjustable pitch and level
- Internal speaker
- Jack for external counter

Talk State of the art, Versatility, or Economy — SWAN'S famous "world's best" Engineering team has designed a complete line of Transceivers to suit your need.



100 MX



ASTRO 102 BX



ASTRO 150



Look to Swan for Quality Accessories . . . and Service



A division of Cubic Communications, Inc.

305 Airport Rd. • Oceanside, Ca. 92054 • 714-757-7525

Awards

Bill Gosney WB7BFK
2665 North 1250 East
Whidbey Island
Oak Harbor WA 98277

In the November, 1979, issue, I outlined the entire awards portfolio being offered by the Central Radio Club in Moscow. Thanks to Paul Schuett WA6CPP/WA7PEI for pointing out the fact that I failed to mention that both the R-10-R and R-15-R Awards have a 24-hour time restriction. Perhaps our readers would like to pencil in this addition to the rules for future reference. It is my understanding that the applicants may have to wait approximately one year (or even longer) for their awards to be processed rather than the three- to four-month period previously announced.

Last year I confronted the ARRL about their WAS Award Program. Having just completed my 6-band effort and well on my way to Working All USA on 7 bands, I thought for sure they would recognize such achievement by issuing a certificate or plaque. To make a long story short, they do not have any awards, nor did they show any interest in the concept.

As merely a method of gathering support from our readers, I would like to hear from those persons who at this time could qualify for Working All USA on 6 bands, 7 bands, or 8 bands if such awards were made available. This "poll" should not be construed to mean *73 Magazine* is going to sponsor such a program; however, once I can gather support from other amateurs who can qualify at the time this

article appears, I will lead a pursuit to acquire such a sponsor. By the way, I am seeking response from those who've achieved these multi-band goals anytime in their amateur career. There would be no time limit or starting date requirement. Be sure to enclose an SASE if a reply is expected.

DX AWARDS FROM ITALY

A very good DX friend of yours and mine, John Paul 18KDB, recently wrote a very complimentary letter about our awards column and asked that we share the awards program sponsored by the Associazione Radiotecnica Italiana (ARI). John Paul noted that the following general rules apply to all HF awards issued by the ARI and recommended they be read together with the conditions governing each individual certificate.

All inquiries and/or applications shall be addressed to the ARI Awards Manager, G. Nucciotti 18KDB, Via Fracanzano, 31-80127 Napoli, Italy, together with 2 IRCs for airmail reply.

ARI awards will be issued to any amateur who will submit:

- A letter, dated and signed, with applicant's name, address, and call. He must certify to have complied with all rules governing amateur radio in his or her country and to have kept fair play and good sportsmanship in operating toward the award for which the application is claimed.

- The complete list of QSLs, with call sign, date, frequency, reports, time, and type of emission (CW, AM, SSB, RTTY).

- QSLs for checking. QSL cards must be submitted without corrections, erasures, or additions and must be clearly readable.

- US \$1.00 or 10 IRCs for foreign applicants. The Marconi Award is free; only a mailing fee is charged.

To get an award in a specific class, the cards must show the corresponding data in a clear format. Foreign applicants may avoid sending QSL cards by submitting a checklist of the cards duly certified by an appointed or elected official of a national amateur radio affiliated society or club. The ARI Awards Manager reserves the right to check, on request, one or more claimed contacts as necessary.

CERTIFICATO DEL MEDITERRANEO (CDM)

The CDM is issued to those amateurs who can show confirmation of a two-way contact on the HF bands since June 1, 1952, with (a) a fixed station in at least 22 countries of the list shown below, and (b) at least 50 amateur stations located in peninsular Italy, both for an accumulated total of 72 QSLs.

The same station may be worked once only. Two classes of CDM are offered: Mixed (AM, SSB, CW, RTTY) or Phone Only (AM, SSB). The minimum reports allowed to qualify are RS 33 or RST 338.

Countries List: Spain, Balearic Islands, Ceuta and Melilla, Morocco, France, Algeria, Corsica, Sardinia, Sicily, Lebanon, Egypt, Greece, Dodecanese Islands, Crete, Mount Athos, Turkey, Syria, Yugoslavia, Albania, Malta, Gibraltar, Cyprus, Monaco, Tunisia, Israel, and Libya.

WORKED ALL ITALIAN PROVINCES (WAIP)

This province award is issued to those amateurs who can show confirmation of a two-way contact on the HF bands since January 1, 1949, with a fixed station in at least 60 provinces of the Italian Republic for foreign amateurs or in 75 provinces for Italian amateurs. The same station may be worked twice or more if in a different province each time. Minimum reports acceptable are RS 33 and RST 338. Starting January 1, 1978, this award may also be endorsed for single band and/or for all 95 provinces.

List of Italian provinces:

Agrigento, Alessandria, Ancona, Aosta, Arezzo, Ascoli Piceno, Asti, Avellino, Bari, Belluno, Benevento, Bergamo, Bologna, Bolzano, Brescia, Brindisi, Cagliari, Caltanissetta, Campobasso, Caserta, Catania, Catanzaro, Chieti, Como, Cosenza, Cremona, Cuneo, Enna, Ferrara, Firenze, Foggia, Forli, Frosinone, Genova, Gorizia, Grosseto, Imperia, Isernia, L'Aquila, La Spezia, Latina, Lecce, Livorno, Lucca, Macerata, Mantova, Massa, Matera, Messina, Milano, Modena, Napoli, Novara, Nuoro, Oristano, Padova, Palermo, Parma, Pavia, Perugia, Pesaro, Pescara, Piacenza, Pisa, Pistoia, Pordenone, Potenza, Ragusa, Ravenna, Reggio Calabria, Reggio Emilia, Rieti, Roma, Rovigo, Salerno, Sassari, Savona, Siena, Siracusa, Sondrio, Taranto, Teramo, Terni, Torino, Trapani, Trento, Treviso, Trieste, Udine, Varese, Venezia, Vercelli, Verona, Vicenza, Viterbo.

Continued on page 150



HAM RADIO CENTER

for the famous **HAM-KEY*** and **KEYER!**

*TM trade-mark

NEW!



Model **HK-3M**

With anti-tip bracket even a heavy-handed key pounder cannot tip. All the features of the HK-3.

\$19⁹⁵

- Deluxe straight key
- Heavy base — no need to attach to desk
- Navy type knob

CC-3 shielded cable w/plug for HK-3M **\$3.95**



Model **HK-1**

- Dual-lever squeeze paddle

\$29⁹⁵

CC-1 shielded cable w/plug for HK-1 **\$4.49**



Model **HK-2**

- Same as HK-1, less base for incorporation in own keyer

\$19⁹⁵



Model **HK-5A** Electronic Keyer

- New Cabinet Colored-Keyed to match most modern radio equipment
- Iambic Circuit for squeeze keying
- Self-completing dots and dashes
- Curtis 8044 I.C. Keyer Chip

\$69⁹⁵

NEW! Model **AT-B** Anti-Tip Bracket

Converts any HK-3 to HK-3M

\$2⁹⁹

Prepaid



Model **HK-4**

- Combination of HK-1 and HK-3

\$44⁹⁵

CC-1/3 shielded cable w/plugs for HK-4 **\$7.95**

Order today direct or from your favorite dealer • Add \$2.00 shipping & handling per unit (USA) Same day shipment ...

HAM RADIO CENTER



JUST DIAL
8340 OLIVE BLVD.
P.O. BOX 28271

1-800-325-3636

TOLL FREE
ST. LOUIS, MO
63132

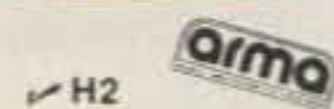

NEW MFJ-410 "Professor Morse" lets you . . .

COPY CW FASTER AND UPGRADE QUICKER

NEW MFJ Random Code Generator/Keyer sends unlimited random code in random groups for practice. Never repeats same sequence. Tailor level to your ability. Vary speed 5 to 50 WPM. Vary spacing between characters. Speed Meter. Full Feature Keyer.

Sends unlimited random code. Never repeats same sequence.

Tailor level to your ability. Vary speed 5-50 WPM.



BRAND NEW

\$149⁹⁵

✓M52

Copy code faster and upgrade quicker. Now you can tailor the level of code practice to your exact needs. Practice copying code anywhere and anytime you have a spare moment. Practice at home, in bed, driving to work, during lunch, etc.

The new MFJ-410 "Professor Morse" is a computer-like random code generator and keyer that sends an unlimited supply of precision Morse Code in random groups.

It never repeats the same sequence so you can't memorize it like code tapes.

Vary speed 5-50 WPM and read on speed meter.

Vary spacing between characters and character groups (for example, copy 5 WPM with 13 WPM characters) to give proper character sound at low speed.

Select alphabetic only or alphanumeric plus punc-

uation (period, comma, question, slash, double dash.)

Tone control. Room filling volume. Built-in speaker. Ideal for classroom teaching. Earphone jack (2.5 mm) for private listening.

Uses 110 VAC, or 9-18 VDC, or 4-C cells (for portable use). Optional cable for car cigarette lighter (\$3.00). 6x2x6 inches.

Built-in full feature keyer. Volume, speed, internal tone and weight controls. Weight control adjusts dot-dash space ratio; makes your signal distinctive to penetrate QRM. Speed meter works for keyer, too. Tune switch keys transmitter for tuning. Reliable solid-state keying: grid block, cathode, solid state rigs. OPTIONAL BENCHER IAMBIC PADDLE.

Dot and dash paddles have fully adjustable ten-



sion and spacing. Heavy base with non-slip rubber feet eliminates "walking". \$39.95.

Order from MFJ and try it — no obligation. If not delighted, return it within 30 days for refund (less shipping). One year unconditional guarantee.

Order today. Call toll free 800-647-1800. Charge VISA, MC or mail check, money order for \$149.95 plus \$3.00 shipping for MFJ-410 and/or \$39.95 plus \$3.00 shipping for Benchier paddle.

CALL TOLL FREE . . . 800-647-1800

Call 601-323-5869 for technical information, order/repair status. Also call 601-323-5869 outside continental USA and in Mississippi.

MFJ ENTERPRISES, INC.
BOX 494, MISSISSIPPI STATE, MS 39762

Contests

Robert Baker WB2GFE
15 Windsor Dr.
Atco NJ 08004

More and more announcements are arriving too late for inclusion in the contest calendar. Material for this February issue had to be received at my QTH no later than November 25th. Please send material as early as possible and send it directly to my home QTH as shown. Sending information via Peterborough only delays delivery as it has to be forwarded to me. If you are still working on the contest rules but have decided on a date, send me a quick note so I can at least list the date as early as possible. I continually try to list contest dates as far in advance as possible to help avoid too many contests being scheduled on the same dates.

CWSP INTERNATIONAL DX COMPETITION

Starts: 0000 GMT Saturday, February 2
Ends: 2400 GMT Sunday, February 3

Amateurs throughout the world are invited to participate in this annual event. Entry classes include single-operator and multi-operator (only club stations, single transmitter), all-band only. All contacts must be on CW.

1980 International SSTV Contest
See page 177!

EXCHANGE:

RST and QSO number starting with 001. CWSP members will add "/CWSP" after the report.

SCORING:

QSOs within the same country count for multipliers only; no QSO points are given. QSOs with other countries in the same continent count 1 point per QSO. QSOs with other continents are 3 points. Multipliers are given for each ARRL DXCC country and for each Brazilian prefix (PY1, PT7, PS8, etc.). Countries and prefixes count only once regardless of band. Final score is the sum of all QSO points from all bands times the final multiplier.

AWARDS:

First place in the world will receive a cup and award. First place in each continent will receive a medal and an award. Awards will also be issued to first place in each country, CWSP members, and clubs.

ENTRIES:

Logs must contain times in GMT, worked station, exchange,

multipliers, and points per band. Logs and summary must be mailed no later than March 15th to: CWSP Contest Committee, Caixa Postal 15098, Sao Paulo, Brazil.

SOUTH CAROLINA QSO PARTY

Starts: 1800 GMT Saturday, February 2
Ends: 2400 GMT Sunday, February 3

Sponsored by WA4SJS, N4AKO, and WA4YUU; all amateurs are invited to participate. The same station may be worked on each band and mode and SC stations may work other in-state stations. Novices and Technicians must sign /N or /T to identify their class.

EXCHANGE:

RS(T) and state, province, country, or SC county.

FREQUENCIES:

Phone—3980, 7280, 14280, 21380, 28580.
CW—3550, 3710, 7050, 7110, 14050, 21050, 21110, 28050,

28110.

No repeater contacts are allowed.

SCORING:

SC stations score one point per QSO and two points for QSOs with Novices or Technicians. Final score is the QSO points times the sum of SC counties, states, provinces, and DX countries worked. For all others, score one point per SC QSO and two points per SC Novice or Technician QSO. Multiply total QSO points by the total number of SC counties worked (46 maximum).

ENTRIES AND AWARDS:

Certificates to top-scoring stations in each SC county, state, province, and DX country. Also to Novice and Technician winners in each SC county and US state. Include a summary sheet with your entry showing the scoring and other information. Logs must be mailed by

Continued on page 143

Calendar

Feb 1-10	ARRL Novice Roundup
Feb 2-3	South Carolina QSO Party CWSP International DX Competition Marconi International DX Contest — Phone
Feb 2-4	New Hampshire QSO Party
Feb 9-10	QCWA QSO Party — CW Two Land QSO Party PA0 Contest
Feb 16-17	ARRL DX Competition — CW
Feb 23-24	French Contest — Phone
Feb 23-25	Vermont QSO Party
Mar 1-2	ARRL DX Competition — Phone
Mar 8-9	QCWA QSO Party — Phone
Mar 9-10	Europe and Africa RTTY Giant Flash
Mar 22-24	BARTG Spring RTTY Contest
Mar 29-30	YL International SSBers QSO Party — CW
Apr 5-7	QRP ARC International QSO Party
Apr 19-20	YL International SSBers QSO Party
Apr 26-27	Helvetia Contest
May 17-18	Florida QSO Party
June 28-29	ARRL Field Day
Sept 13-15	Washington State QSO Party

Results

RESULTS OF THE H26 CONTEST, 1979

European Scores

C31QA	60
DK7XS	30885
DM3PQO	31680
EA7ALG	8103
F9KP	24338
G4FDC	13050
GD4GWQ	1440
GI4GDV	612
GM4FSA	780
GW3INW	5445
HA3KNA	13680
I2LVN	45
LA9HW	9768
LZ1XL	17820
OE1DSA/3	31590
OH2DW	21924
OK3KAG	27216
ON7YD	7425
OZ7SAC	2964
PA2TMS	7200
SM0CCE	17493
SP9PDF	9717
UK3ACR	31155
UA2FCB	16524
UK5IBM	37962
UC2WAZ	6336
UP2BAW	12600
UQ2GEC	3024
UR2RKS	27
YO3CR	17490
YU2CRM	11094
4U1ITU	63

SWL

BRS 32525	29160
<i>Non-European Scores</i>	
K9PNT/DU2	576
EA8TY	864
HS1ABD	2394
JA1ADN	5766
KP4V	5202
LU2DPW	504
OA4ZP	1242
OD5LX	60
PY1BOA	2205
UK9HAC	24300
UD6DHC	2592
UH8BO	240
UJ8JCQ	231
UL7MAR	30246
UM8MBN	2106
VE2FGL	10209
VE3DMC	7437
VO1AW	4059
VK2BAC	1254
N1NA	16983
K2SX	351
W3ARK	7371
W4OEL	17013
W5EIJ	330
W6UA	1581
K7CU	495
W8DA	13500
W0BMM	1104
YV1OB	1581
ZL1AJU	4455
HB9BA/4X	10146

X-RATED

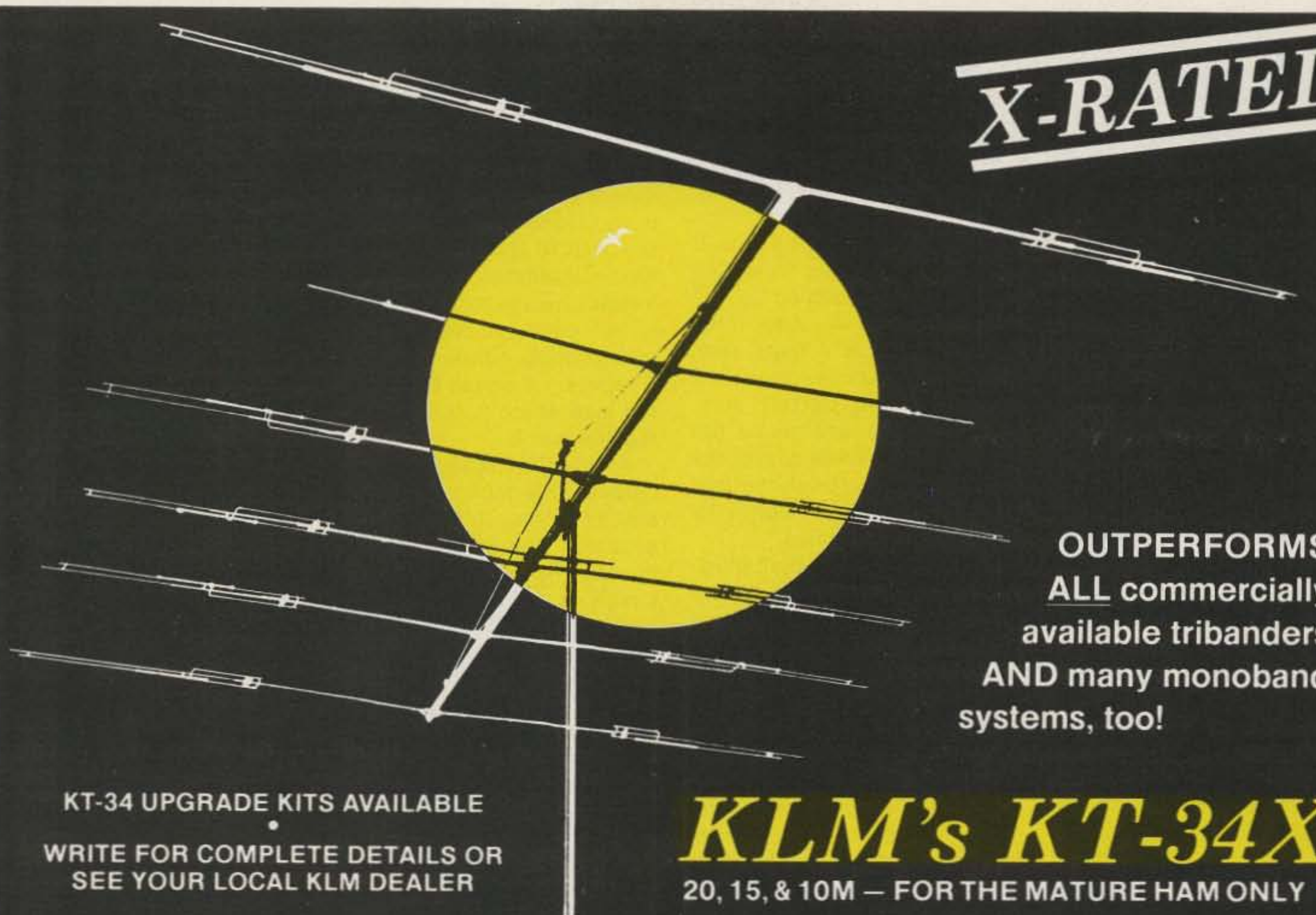

**OUTPERFORMS
ALL commercially
available tribanders
AND many monoband
systems, too!**

KT-34 UPGRADE KITS AVAILABLE
WRITE FOR COMPLETE DETAILS OR
SEE YOUR LOCAL KLM DEALER

KLM's KT-34X

20, 15, & 10M — FOR THE MATURE HAM ONLY

KLM 17025 LAUREL RD., MORGAN HILL, CA 95037, (408) 779-7363

✓K4

New 2 Meter Avanti Mobile Antenna

Mounts on glass — no holes!

- Receives and transmits through glass.
- Superior performance equivalent to 5/8 wave.
- Superior radiation full Omni-Directional.

It's easy to install — No holes to drill, no magnet to scratch the paint, no clamps. Uses an especially developed epoxy adhesive that secures antenna to window like a 1/4" bolt. The capacity coupling box is simply attached with a special adhesive tape to inside of window. Worried about crimping or corroding coaxial cables? It's all inside and out of sight.

AH 151.3G SPECIFICATIONS

Gain	Equivalent to 5/8 wave
2 meter V.S.W.R. Band Width	Better than 1.5:1
Maximum power	150
Nominal Impedance	50 Ohms
Chrome plated casting, Stainless Steel hardware, Swivel whip holder	
Height	33"
Performance and Mechanical Patents Pending	

Buy one from your nearest AVANTI dealer. If your dealer does not have one in stock, have him call the following toll free number and we will ship him one within 24 hours:

(800) 323-9429

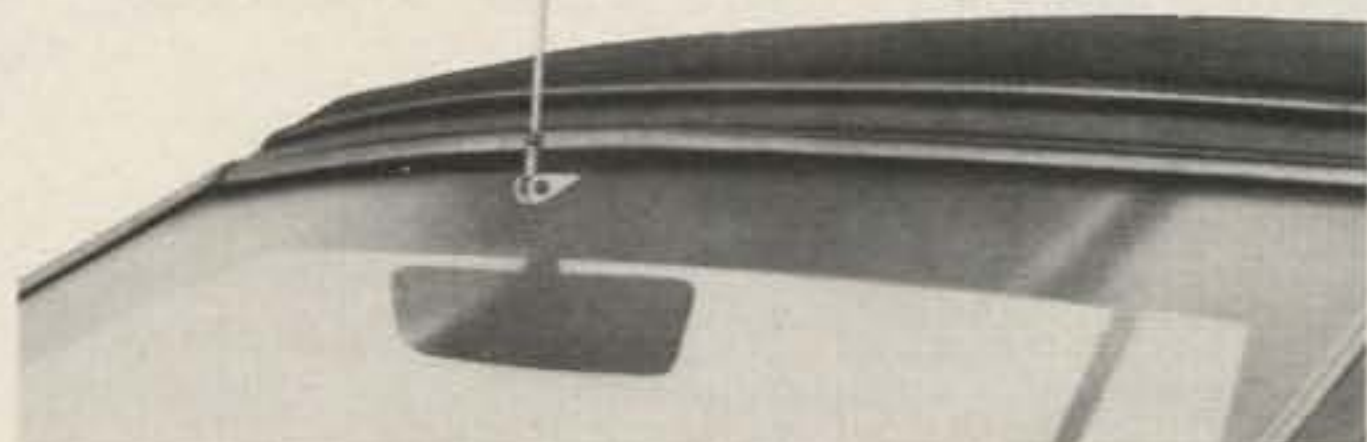
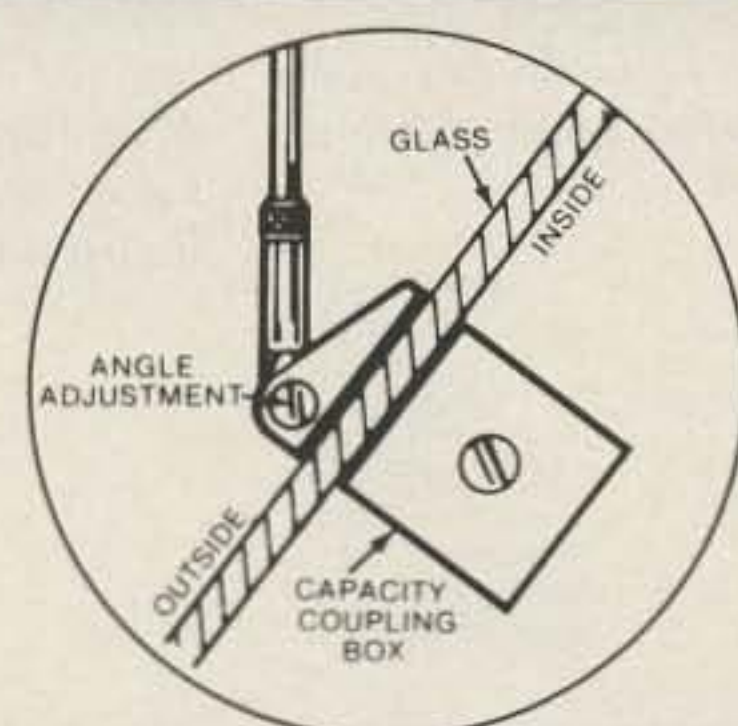

See Avanti's other new amateur mobile and base antennas. Write for new catalog today.

Send 50¢ for handling and postage.

✓A93

avanti antennas

Avanti Research and Development, Inc.,
340 Stewart Ave., Addison, IL 60101
© 1979 In Canada: Lenbrook Ind., Scarborough, Ontario MIH IH5

Microcomputer Interfacing

Jonathan A. Titus
Christopher A. Titus
David G. Larsen
Peter R. Rony

Since microprocessors like the 8080 and 6800 do not have multiplication and division instructions, subroutines (that contain addition and subtraction instructions) must be written to perform these operations. A typical paper-and-pencil decimal and binary multiplication for two different sets of numbers is shown in Fig. 1.

As you can see, the "mechanics" of multiplication are very similar in these two examples. As the multiplicand is multiplied by larger and larger powers of ten or powers of two, the result of the multiplication has to be shifted to the left by one, to increase the significance of the result. For instance, when 1024 is multiplied by the 9 in 596, the result (9216) is shifted to the left by one place, because the multiplication is really 90 x 1024 and the result is really 92,160.

To multiply two binary numbers, the 8080 must examine

```

1024      00100110
x 596      x 00011011
-----
6144      00100110
92160     001001100
+ 512000  0000000000
-----
610304    00100110000
          001001100000
          0000000000000
          000000000000000
          + 0000000000000000
          0000100000000010
    
```

Fig. 1. Decimal and binary multiplication examples.

the multiplier, a bit at a time. If the bit is a logic one, the multiplicand is added to the *partial sum* (initially zero). If the bit examined is a logic zero, then the multiplicand is not added to the partial sum. Regardless of whether or not that addition takes place, the partial sum *must* be shifted one bit position, after each bit in the multiplier is examined.

To keep the 8080 multiplication software example (Example 1) as simple as possible, we will write a subroutine that multiplies two eight-bit numbers. These two numbers must be stored in the 8080's D and E registers and the 16-bit result will be stored in registers B and C (register pair B). When the MP88 subroutine is called, register pair B is cleared because it will be used to store the *partial sum* and finally the 16-bit result of the multiplication. The L register is loaded with the number of bits in the multiplier, octal 010, hexadecimal 08, or decimal 8. At NXTBIT, the multiplier that is contained in register D is moved to register A, shifted once to the right, and saved back in register D. These instructions shift a single bit of

```

          00001110
1011 10011011
- 1011
-----
10000
- 1011
-----
1011
- 1011
-----
00001
    
```

Fig. 2. A binary division example.

the multiplier into the carry, so that the state of the bit (logic one or logic zero) can be tested with software instructions.

If the state of the carry after the shift is a logic zero, this means that the multiplicand is not added to the partial sum, so the JMP to NOADD (NO ADDITION) is executed. If the carry is a logic one, the JMP to NOADD is not executed. Instead, the multiplicand, contained in the E register, is added to the partial sum which is contained in register pair B.

At NOADD, the 16-bit number contained in register pair B is shifted to the right by one bit position. The multiplier's bit count, which is contained in the L register, is then decremented by one. When this bit count is decremented to zero, the 8080 will return from the MP88 subroutine, with the 16-bit result of the multiplication in register pair B. If the bit count is non-zero, the JMP to NXTBIT is executed, so that another bit in the multiplier can be tested and any additions performed.

The multiplication of the two eight-bit binary numbers was performed by an *add and shift algorithm*. Binary division can be performed by a *subtract and shift algorithm*. An example of binary division is shown in Fig. 2. Binary division is more complex than binary multiplication. To divide two binary numbers, the divisor is subtracted from a larger portion of the dividend, which has less and less significance. If the divisor is larger than the part of the dividend that it is being subtracted from, a borrow occurs. In this case, the divisor is added to the *result of the subtraction* to "regenerate" the original part of the dividend that was being

tested. A zero is then entered in the quotient for the bit position being tested. If no borrow occurs when the subtraction is performed, the result of the subtraction is used as the new partial dividend and a one is entered into the quotient since the divisor was successfully subtracted from the dividend. The subroutine listed in Example 2 divides the content of the E register (the dividend) by the eight-bit content of the D register (the divisor) and the eight-bit result (the quotient) is saved in the H register and the remainder is saved in the C register.

The LXIH instruction in the DIV88 subroutine (Example 2) loads the number of bits in the divisor (octal 010, decimal 8) into the L register and the H register is loaded with zero. This is done because the H register will be used to store the quotient. The MVIC instruction loads the C register with zero. The C register will be used to store the *partial dividend*. At NXTBIT, the dividend is shifted one bit to the right. The most-significant bit (MSB) is shifted into the carry and the remaining bits of the dividend are saved back in the E register. The partial dividend in register C is then moved to register A, and the bit from the dividend is shifted from the carry into the least-significant bit (LSB) of register A. The SUBD instruction subtracts the divisor from the partial dividend, which was in the A register. If the divisor is subtracted from a larger or equal number, the JMP to NOADD is executed. If the divisor is greater than the partial dividend, a borrow occurs,

Continued on page 141

```

MP88,  LXIH  /SET THE REGISTER PAIR THAT WILL HOLD THE
      000  /RESULT OF THE MULTIPLICATION, TO
      000  /000 000 (HEXADECIMAL 0000)
      MVIL  /LOAD L WITH 8 (DECIMAL), THE BIT COUNT
      010  /OR THE NUMBER OF SHIFTS TO TAKE PLACE
NXTBIT, MOVAD /MOVE THE MULTIPLIER INTO A
      RAR  /SHIFT IT ONE BIT TO THE RIGHT
      MOVDA /THE CARRY IS EITHER 1 OR 0, SAVE THE MULTIPLIER
      JNC  /IF THE CARRY IS 0, JUST SHIFT THE
      NOADD /RESULT. IF THE CARRY IS A 1, ADD THE
      0    /MULTIPLICAND TO THE RESULT, THEN SHIFT IT
      MOVAB /GET THE MSBY OF THE RESULT
      ADDE  /ADD THE MULTIPLICAND
      MOVBA /AND SAVE THE MSBY OF THE RESULT
      NOADD, MOVAB /NOW SHIFT THE 16-BIT RESULT ONE
      RAR  /PLACE TO THE RIGHT.
      MOVBA /SAVE THE NEW MSBY
      MOVAC /NOW SHIFT THE LSBY TO THE RIGHT.
      RAR
      MOVCA
      DCPL  /HAVE ALL 8 BITS OF THE MULTIPLIER
      JNZ  /BEEN TESTED YET? NO, TEST ANOTHER BIT
      NXTBIT
      0
      RET  /YES, THE ANSWER IS IN REGISTER PAIR B
    
```

Example 1. An eight-bit by eight-bit multiplication subroutine.

```

DIV88, LXIH  /LOAD THE L REGISTER WITH 010 (DECIMAL 8)
      010  /OR HEXADECIMAL 08 AND LOAD THE H
      000  /REGISTER WITH 000 (THE RESULT WILL BE IN H)
      MVIC  /LOAD THE C REGISTER WITH 000
      000  /THIS REGISTER WILL BE USED FOR STORAGE
NXTBIT, MOVAE /MOVE THE DIVIDEND TO A
      RAL  /SHIFT THE MSB OF A INTO THE CARRY
      MOVEA /SAVE THE SHIFTED DIVIDEND BACK IN E
      MOVAC /GET THE PARTIAL DIVIDEND STORED IN C
      RAL  /SHIFT THE CARRY INTO THE LSB OF A.
      SUBD  /SUBTRACT THE DIVISOR FROM THIS NUMBER
      JNC  /IF THE CARRY=0, THE SUBTRACTION DID NOT
      NOADD /PRODUCE A BORROW. THEREFORE, SHIFT THE
      0    /QUOTIENT. OTHERWISE ADD THE DIVISOR BACK TO A.
      ADD  /ADD THE DIVISOR BACK TO THE CONTENT OF A.
      NOADD, MOVCA /SAVE THE PARTIAL DIVIDEND BACK IN C.
      CMC  /COMPLEMENT THE CARRY.
      MOVAH /AND SHIFT THE CARRY INTO THE LSB
      RAL  /OF THE H REGISTER. IF A BORROW, C=0
      MOVHA /IF NOT, C=1
      DCRL  /HAVE ALL EIGHT BITS BEEN SHIFTED YET?
      JNZ  /NO, SHIFT ANOTHER BIT OF THE
      NXTBIT /DIVIDEND AND TRY ANOTHER SUBTRACTION
      0
      RET  /THE ANSWER IS IN H WHEN THE 8080 RETURNS
    
```

Example 2. An eight-bit division subroutine.

DSI STOPS BRANDS A thru Z with more counter for less money

FACTORY WIRED 500 MHz • 1 PPM TCXO • 8 DIGITS

99⁹⁵

Without Battery Capability

119⁹⁵

Includes Rechargeable Battery Pack and AC-9

- Two BNC Inputs
- 1 Meg and 50 Ohm Input
- Factory Wired and Tested
- Made in USA
- 50 Hz to 512 MHz



Compare These Features and You Will Buy DSI

- 8 Digits *Not* 6 or 7 Digits
- 1 PPM TCXO *Not* 1.5 PPM - 10 PPM
- Resolution 1 Hz @ 50 MHz *Not* 10 Hz
- Resolution 10 Hz @ 450 MHz *Not* 100 Hz

FREQUENCY COUNTER STRAIGHT TALK

There are only three functional requirements for a frequency counter: 1. Good accuracy over temperature 2. Resolution 3. Sensitivity

Good accuracy over temperature. Crystal oscillators drift with temperature changes. This change is specified in parts per million (PPM). The 5500 TCXO (temperature compensated crystal oscillator) holds an accuracy of 1 PPM from 17° to 40°C. This corresponds to ± 450 Hz at 450 MHz. Counters with 2 PPM accuracy would read to ± 900 Hz at 450 MHz. Counters with 10 PPM accuracy would read to ± 4500 Hz and so on.

Resolution. What is the value of the least significant digit displayed? A counter with 10 Hz resolution would display 146.52000 MHz as 146.52000 i.e. with the last digit left off. A counter with 100 Hz resolution would display 146.5200. The 5500 with 8 Digits is capable of resolving 1 Hz from 50 Hz to 50 MHz and 10 Hz from 50 MHz to 500 MHz. Counters with only 7 digits usually can only resolve 10 Hz to 50 MHz and 100 Hz to 500 MHz. The above effects, accuracy and resolution are cumulative. Example: a seven-digit counter with 1.5 PPM accuracy reading 450 MHz would only be accurate to ± 675 Hz ± 100 Hz (last digit error) or ± 775 Hz. The 5500 with eight full digits and 1 PPM accuracy would be accurate to ± 450 Hz ± 10 Hz (last digit error) or ± 460 Hz maximum. Not bad for \$99.95. You really need that eighth digit to achieve real accuracy.

Sensitivity. The 5500 requires only 10-15 mv of signal to stabilize and achieve an accurate reading. A one watt hand-held can be read with accuracy at a distance of 15-20 ft. from the counter using the T600 antenna. Counters with 150 mv sensitivity will only stabilize at distances of less than a foot.

The outstanding sensitivity of the 5500, the result of its unique engineering design, and built-in preamp assures stable, accurate readings every time you key up your transmitter.

If you are tired of receiving a plastic bag of sometimes surplus, sometimes defective material only to spend all night trying to solder both sides of the PC Board because the manufacturer chose to use low cost PC Boards without plated-thru holes; if you chose a kit because you only budgeted a hundred dollars for a frequency counter, then the DSI 5500 Counter is the answer. It is 100% factory assembled and tested. DSI strives to purchase the highest quality, prime materials imposing the most rigorous quality requirements possible. Every PC Board that DSI manufactures is plated-thru solder re-flowed, and 100% factory assembled, tested and burned-in in the USA, assuring years of trouble-free service. DSI has worked hard to achieve our worldwide reputation for the best price to quality features ratio in the industry. DSI's 5500 now makes it possible to buy a 100% factory assembled accurate 8-digit frequency counter for under \$100.00. Buy quality — Buy performance — Buy cost effectiveness — Buy DSI.

FOR INFORMATION — DEALER LOCATION — ORDERS — OEM
CALL 800-854-2049 CALIFORNIA RESIDENTS CALL 800-542-6253

Model	Price	Frequency Range	Accuracy Over Temperature	SENSITIVITY			Number of Readouts	Power Requirements	Size		
				@ 100 Hz - 25 MHz	@ 50 - 250 MHz	@ 250 - 450 MHz			H	W	D
5500	\$99.95	50 Hz - 512 MHz	TCXO 1 PPM 17° - 40°C	10 - 15 MV	10 - 15 MV	15 - 50 MV	8	*115 VAC or 8.2 - 14.5 VDC	1 1/2"	5"	5 1/2"

*With AC-9 Adaptor.

5500 wired factory burned-in 1 year limited warranty. Prices and/or specifications subject to change without notice.

TERMS: MC - VISA - AE - Check - M.O. - C.O.D. in U.S. Funds. Please add 10% to a maximum of \$10.00 for shipping, handling and insurance. Orders outside of USA & Canada, please add \$20.00 additional to cover air shipment. California residents add 6% Sales Tax.



DSI INSTRUMENTS, INC.
9550 Chesapeake Drive
San Diego, California 92123
(714) 565-8402

5500 Wired \$99.95
5500/W 55BA 119.95
Includes Rechargeable NiCad Battery Pack
and AC Adaptor.
T600 BNC Antenna 7.95
AC-9 AC Adaptor 7.95

New Products

NEW HF MOBILE ANTENNA

Discoil Corporation has introduced a new high-performance high-frequency mobile antenna that covers a frequency range of 3.5 to 30 MHz without changing coils or adjusting rods.

The DISCOIL is the first mobile antenna to be manufactured utilizing aerodynamic design principles to prevent excessive layback while in motion, reducing detuning effects found in conventional mobile antennas. The "wing" on top of the coil acts as a wing on an aircraft, tending to hold the antenna in a more vertical position. The vertical portion of the antenna (the coil) acts as a rudder reducing sidewobble. The wing also acts as a capacity hat, reducing the amount of inductance required in the coil, increasing antenna efficiency.

The 2½-foot circumference, plated, printed circuit coil is three times larger than any other commercially available antenna coil, allowing more actual radiation from the coil itself.

The 108" overall length, center-loaded antenna features stainless steel upper and lower sections and fits any standard 3/8-24 antenna mount.

Factory-set coil taps are supplied for the center of 15-, 20-, 40-, and 75-meter phone bands. Other taps are easily installed for other frequencies, such as MARS, CAP, etc. Frequencies and bands are simply changed by clipping a lead to the pre-

determined tap.

For further information, write *Discoil Corporation, PO Box 1076, Brackettville TX 78832.* Reader Service number D75.

INFO-TECH M-200E TRI-MODE CONVERTER

For those readers who are not yet aware of it, there is a revolution going on in non-voice two-way communications. While hams still will be required to interpret Morse code reception to pass their exams, they now have another option available to them for on-air operation.

Automatic Morse senders and readers are now available as an operating aid. If you can type, you can send perfect CW, and if you can read, you can copy at incredible speeds! At present, there are two classes of instruments available to accommodate this luxury: the digital reader and the video converter.

As an extra bonus, most manufacturers of these new devices include RTTY capability as well. Info-Tech's M-200E is a luxurious example of just how much fun RTTY and CW can be.

The flexible M-200E is lightweight and compact, especially considering its enormous versatility. 3½ inches high, 9 inches wide, and 12 inches deep, the unit weighs a scant five pounds! Power consumption is 20 Watts at 120 V ac. The front panel is white enamel and the cabinet is black; bright LEDs signal various status conditions during actual operation. An internal

CORRECTION

The Madison Electronics ad for Belden products which appeared in the December issue was incorrect. Please refer to the Madison/Belden ad elsewhere in this issue for the correct prices. 73 apologizes for the error.

character generator provides a full alphanumeric display when used with any standard video monitor. 32 characters per line is standard; 72 is available at extra cost.

In our lab test, we fed the M-200E output into a Radio Shack TRS-80 video monitor (an internal connection must be made to this monitor; it will not take video directly through its interface cable). Video output is a 5 x 7 matrix, positive (white on black), 2.5-volt p-p negative sync.

For those operators who wish hard copy, loop outputs are accessible on the rear apron for an ASCII printer or for conventional RTTY teleprinter. Automatic scrolling (line feed) and carriage return are featured.

Morse Reception

For those of us whose code speed has dwindled over the years, the M-200E puts us up at the head of the pack! Speeds from 5 to 60 words per minute (and higher with an internal adjustment) are automatically copied!

For receivers without tuneable bfo's, a rear-panel fine tuning control permits CW pitch adjustment from 800 to 1200 Hz.

The passband is sharp, so receiver stability is essential.

A phase-locked loop separates the actual CW note from background noise, and a front-panel LED signals the operator when the signal is properly adjusted within the passband.

For CW operators who can't stand noise, there is an input for a key on the rear apron which allows soundless code practice! While the CW reader portion will allow the poor band conditions, it *demand*s a good fist. Erratic keying will be displayed as invalid characters.

RTTY Operation

Perhaps the real beauty of the M-200E is its RTTY flexibility. Speeds may be selectable as 60, 66, 75, or 100 words per minute and 110 baud ASCII. RTTY shift may be selected as 170, 425, or 850 Hz. Non-standard shifts may be copied by straddle tuning, utilizing the panel meter as a tuning indicator.

While proper speed selection may be determined by the classical trial and error method of switching back and forth until legible copy is demodulated, the M-200E has a special feature: By simply pressing the reset button twice in succession, correct speed will be displayed on the monitor (or printer)!

Audio input impedance to the tri-mode converter is nominally 1000 Ohms; it will perform with impedances as low as 4 Ohms, however.

Automatic threshold control may be selected for single-tone copy, an aid to non-standard RTTY signals. Hard limiting is also available to preserve error-

Continued on page 145

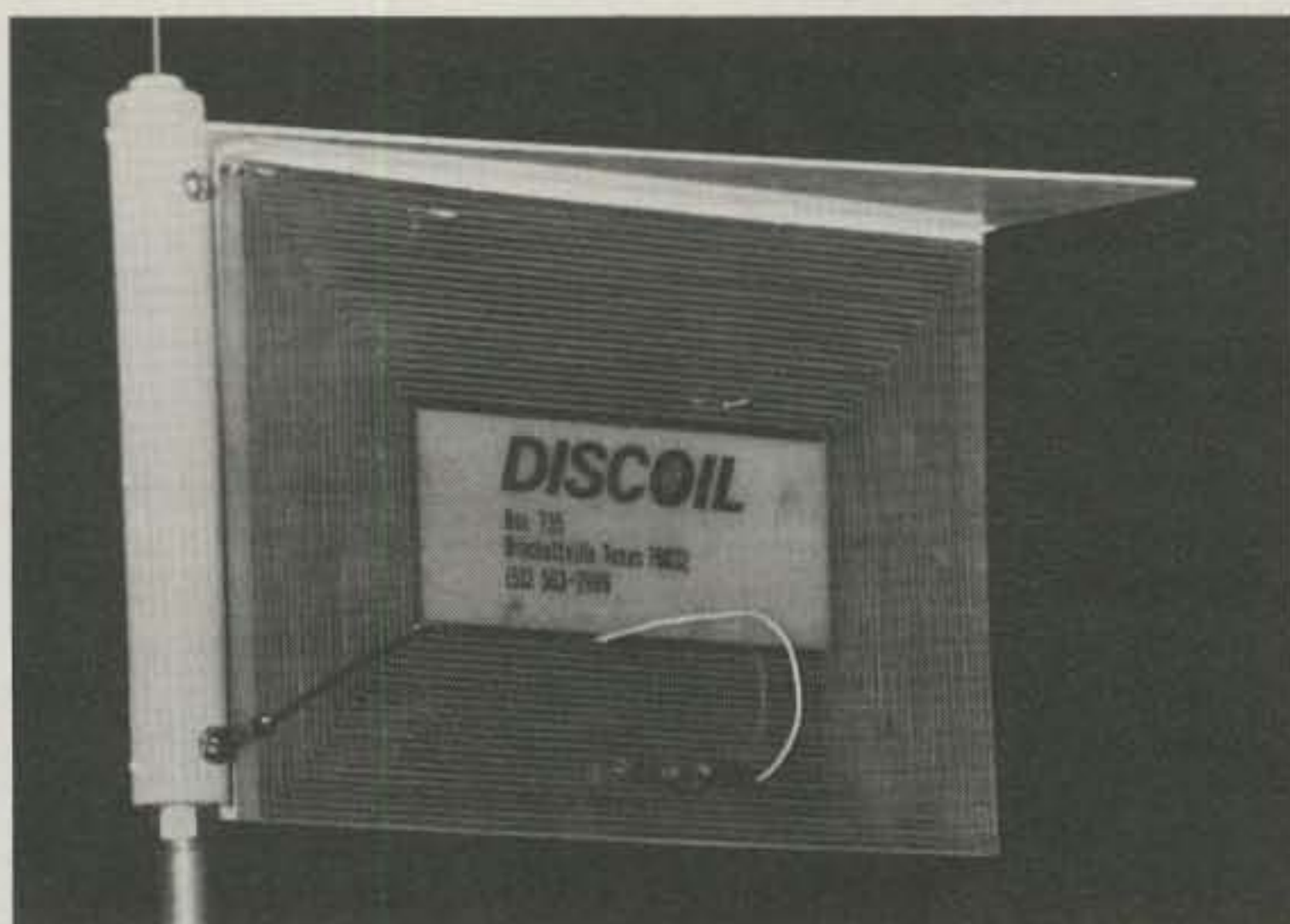

New HF mobile antenna from Discoil.



Info-Tech's M-200E tri-mode converter.

ou goons don't ever proof
lousy manuscripts from bat
burch
you liard
I insist that you print ev
tell Ma Bell that she shou

LETTERS

AED IS OK

Every once in a while, someone comes along with an idea in either kit form or in a completely assembled shape that is so unique and so easy for the average ham to understand and assemble that some mention should be made.

I am writing because I have just put together the standard kit supplied by AED Electronics, 750 Lucerne Road, Montreal, Quebec H3R, for a 220-MHz Midland digital read-out transceiver. The instructions are simple and straightforward. The circuit board is silk-screened for the components, so there is no need to be an electronics engineer to assemble the kit.

When I turned the scanner on, I was amazed at the number of repeaters that are not listed in the book that come up and that I now know are available to me and other hams. There is no way, without the scanner, that you could find these repeaters without a lot of manual manipulation of the dials.

I might add that the scanner for the 220-MHz Midland radio is so ingeniously designed that it fits into a compartment as if it was originally equipped by the manufacturer. The price for it in kit form is less than half of other scanners that I have seen on the market.

I think some mention should be made in the magazine to alert the hams to this very unique and usable item.

Martin D. Shapiro WA3IFQ
Philadelphia PA

OLYMPIC QSLs

The amateurs of Franklin County NY will be distributing special 1980 Winter Olympic QSL cards to each of their contacts for a period before, during, and after the Olympics in Lake Placid NY.

The cards contain the primary Olympic logo, the Franklin

County seal, and the standard QSL information. The Franklin County Legislatures both printed and paid for the cards. Anyone that would like more information on the cards can get in touch with me.

Shawn D. McGovern KA2BSC
117 Webster Street
Malone NY 12953

SSTV DXCC

Not so long ago, during a QSO when I told you I was getting within sight of my 2x SSTV DXCC, you asked me to let you know when this did happen and to send you my photo with details, etc.

By DXCC Award Authorization dated September 28, 1979, I was informed that I had been awarded DXCC Certificate No. 3 for Two-Way SSTV contacts

with 101 countries.

The significance of No. 3 is that it is No. 3 in the world and puts me automatically on the Honor Roll behind W8YEK with 108 countries and G3IAD with 101 countries. Actually, I then had 103 countries but with only 101 confirmed; since then, AP2AD has sent his QSL card and ZK1AA (June 5, 1979) says his QSL is in the direct post!

I have been active with SSTV on all bands from 80m to 2m since November, 1972, chiefly with Robot equipment starting with their 70 monitor and 80 camera, the model 61 fast-scan monitor, and, for the last two years, the 400, the latter with UK modifications designed by G3UEU and G3OQD.

Rf wise, I use a Heath SB-401 transmitter and 303 receiver, an Autek QF-1A filter, and an SB-220 to either a TH6DXX or 40/80m Lazy H at 56 ft. I also run an FT-901 through the SB-220. 2m equipment includes an FT-221R with a Lunar rf-switched preamp through a NAG 144XL linear to a pair of 16-element Tonna yagis stacked vertically above the TH6DXX (at 58 ft.), with the top one at 72 ft.

Richard Thurlow G3WW
March, England



Richard Thurlow G3WW.

GAG ORDER

In the November issue of 73 Magazine, there were two letters pertaining to the atrocious operation on the Hurricane Net during the time hurricane David was approaching the US. The letters regenerated the disgust I felt while I also was monitoring the net.

It seems to me that the biggest violation of good operating habits was that many radio operators could not keep their mouths shut. Whenever an interfering signal appeared, the many unsolicited comments that followed were as damaging to the net operation as was the deliberate QRM. In time of emergency, no station should transmit unless called upon by the net control operator.

Obviously, there are times when the control station cannot hear all the signals on the net and, in such cases, the information must be relayed. But, what I heard on the net wasn't a case of merely relaying information — it was operators who insist on getting their little trivial and redundant comments aired. To such operators, I say "Horsefeathers!" Let the control operators do the chatting.

It was also very ridiculous to hear the continual inquiries for weather data. Instead of calling for the weather information, stations on the net should monitor the circuit and allow the control station to repeat the data at reasonable intervals, thus allowing the net to be clear for more important traffic.

To the net control operators: You did a great job under conditions that were, at times, unbearable and unnecessary. I hope, in the future, we in the amateur radio community will be more considerate and try to cooperate so that not only will emergency conditions be managed efficiently, but also so amateur radio will not be degraded.

Bill Farris K1WF
Chatham MA

MEDICAL ADVICE

Memorial Hospital Medical Center is an 850-bed facility located in Long Beach, California, on the Pacific Ocean. Know-

Continued on page 152

Leaky Lines

Dave Mann K2AGZ
3 Daniel Lane
Kinnelon NJ 07405

Many who have been licensed for years fail to realize that some of our number, being inexperienced, need some patience and understanding. And it is up to us to provide it. If we dig down into those long-forgotten crevices of memory, we will undoubtedly discover, each and every one of us, that someone once gave us encouragement, way back when it really counted. If amateur radio operators constitute a "fraternity," as we are so fond of terming it, then it is difficult to account for some attitudes as expressed on the ham bands.

We proclaim our universal equality. Ham radio brags about the fact that it is so democratic; there are no aristocrats. Oh, to be sure, there are some of us who possess wealth and fame. But, on the air, we like to think of ourselves as equals who are friendly and solicitous of each other. King Hussein of Jordan, JY1, one of the world's most privileged individuals, has never been heard to push his weight around on the bands, lording it over just plain commoners. Neither do hundreds of others like him who enjoy the advantages of position and affluence.

But there are some hams who delude themselves with a totally alien concept. They regard newcomers not as colleagues in a common enterprise, but as interlopers and outlanders. They refer to their inexperience as one might speak of leprosy. They lose no opportunity to treat them with contempt and open hostility, and, in so doing, they reflect poorly on all of us.

There used to be one of these self-styled aristocrats who would call CQ in the following obnoxious manner: "Hello CQ, CQ, CQ. No As, no Bs, no kids, no lids, no space cadets." And he would sign his call (two letters, of course). His reputation was anything but enviable; he made quite a name for himself as some sort of a nut and instead of the approbation and respect he thought himself entitled to, he earned nothing but disdain and the reputation of a latter-day Ebenezer Scrooge.

His disciples are still among us. They constantly berate

others with deprecatory references to CB and some even resort to the foulest language. They show no patience toward others and, undoubtedly, cause much pain and embarrassment.

New amateurs have a right to expect fairness. According to the terms of their class of license, they are entitled to no less than others, and have a right to be properly indignant when they are denied common courtesy by those who have an exaggerated sense of their own importance.

Just to demonstrate how hypocritical some guys are, I'd like to recount a recent incident.

There are thousands of DX chasers who would give their eyeteeth for a crack at a 5R8. So when one of these elusive stations showed up on 20 meters recently, you can imagine the excitement it generated. It began with only a dozen or so stations in the know, but the word spread quickly to the hinterland and, before long, virtually everyone within earshot arrived on the frequency.

Things were cool; no one wanted things to get out of control, for experience clearly demonstrates that if there is anything that will drive a rare DX station away, it is one of those bedlams where you can't even hear yourself think. Everyone on the frequency was circumspect in his behavior, that is, everybody except a certain moron in South Carolina whose call sign I won't repeat, merely in the interest of avoiding becoming involved in lynching or a tar-and-feather party.

The operator of 5R8TV requested that someone take a list so that he could work as many contacts as possible in the limited time available. The moment a list was mentioned, the 4th-district idiot began announcing his pronunciamento. You would have thought that he was speaking from Mount Sinai—all the righteous indignation burst forth from his rotten mouth like lava from a volcano. He fulminated loud and long, polemicized like a filibustering politician, and rent the air blue with invectives.

The others on the frequency were unable to hear anything, and you can imagine what this

sounded like in Malagasy. 5R8TV left for parts unknown, leaving the frequency to the imbecile. And the hopes of hundreds of DXers bit the dust!

About a week later, it became known that Juergen TN0HL was about to work some Americans on either 10 or 15 meters. A German-speaking W9 and a few others from various call areas were slated to assist in the operation and all others were admonished to be on their good behavior, since this DX operator is known to be strongly opposed to boisterous pileups and would probably leave at the first sign of disorder.

On the first day, things went perfectly. Several stations worked the TN (including K2AGZ—how lucky can I get?), and there was fine cooperation from all on the frequency. So much so that Juergen told Bill WB9TTM that he had enjoyed the experience and intended to come back. It was clear that if decorum could be maintained, he would come on a regular basis, and since he is scheduled to remain in TN-land until next June, this would mean that all of us would get a shot at this elusive country.

Well, what do you think happened next?

The very jerk who had maligned list operations so viciously and had created all the chaos which chased the 5R8 away was heard trying to get on the list for Juergen! Imagine, this hypocrite who was so opposed to lists was not above attempting to get on one of them. It was clear that this dogmatic opposition did not apply when it came to a prefix that he needed for himself. He was only against lists for other people.

His arrant hypocrisy angered all who had heard his prior diatribe. Many of them said that even if they had made the list, they would rather pass up the contact than remain on the

same frequency with this boor. Several stated that if Juergen had shown up (which he didn't), they would have seen to it that the South Carolina lid would never have been permitted to hear his signal report from TN-land. I can't say that I blame them a bit.

Someone ought to circulate the idea that anyone who can identify such a creep (and there are many who make speeches without identifying themselves) ought to be urged to divulge his identity and thus expose his stupidity. Maybe that would help to rid us of all the self-appointed policemen and monitors who are forever parking themselves on the frequencies of DX stations so they can issue their orders and comments to everybody else. I don't know what makes these jerks feel that they have a right to act as supervisors, but there is a hard core of such lunatics who systematically show up.

It would be nice if a volunteer goon squad went around the countryside sticking pins into their coax cables. Better still, why doesn't one of those brilliant young geniuses with all the solid-state savvy design a circuit that will send a shot of about 50 kW right into the tank circuit of such offenders? Maybe it's possible to construct a sophisticated rf sniffer that can track down the exact location of radio pests, follow it just like one of those heat-seeking missiles, and wipe it out.

If someone were to come up with such a circuit, I know about a hundred DXers who would pay almost anything to get one. In fact, I'm willing to buy the first one. I guarantee you that a certain jackass in South Carolina would be walking around with frizzled hair-ends and singed eyebrows if ever I got the chance to zap him with a shot of rf! Boy, wouldn't that be just great!

Ham Help

I am looking for manuals, schematics, etc., for an old Clough-Brengle Type CRA "Graphoscope." I would be happy to cover costs of mailing, copying, etc. Can anybody help?

Roy Moses WD5ICY
2002 Cindy Lane
Denton TX 76201

I wish to purchase a 6-meter CW-AM-SSB receiver to match my Heathkit HX-30 transmitter.

I also would like to convert a Royce 640 SSB-AM CB transceiver to 10 meters and need info and a schematic.

Gordon Juveli WB0ZSA
10925 Morris Ave. S.
Bloomington MN 55437

SIGNALCRAFTER INTRODUCES

The Most Advanced Automatic Computing RF Measuring Instrument in Amateur Radio!



MODEL 30

This new Signalcrafters SWR/Power Meter is in a class by itself. Signalcrafters custom-designed integrated circuits compute SWR automatically, thus eliminating need for "set" or "sensitivity" controls. The built-in analog computer operates over the power range of only one watt to several kilowatts with unparalleled accuracy. Our auto-ranging feature automatically selects the proper range of 0 to 20, 0 to 200, or 0 to 2,000 watts according to the RF level detected on the transmission line and indicates the proper range on one of three front panel LED's. The operator can assume manual control of this feature by selecting one of the three basic ranges on the front panel switches. Two large taut-band meters indicate forward power and SWR. Complete hands-off operation! The amateur may also choose between either average or peak RF power. Self-indicating push buttons allow selection of any of three antennas or a dummy load when used with external 12-volt coaxial relays or our Model 50 Antenna Relay/Dummy Load. The 1.5 to 30 mhz coupler is plug-in mounted on the rear apron and can be unplugged and remote-mounted for convenience. The attractive, heavy-duty, low profile metal cabinet complements the latest transceiver designs. DC output receptacles supply analog voltages that track the meter readings. These outputs can be used to control many different accessories, such as analog to digital converters, remote meters, control and alarm devices, as well as the Signalcrafter Model 40 Audio-Tuner for the blind amateur. Operates from 110 volt 60 hz AC. Width: 8½" (216 mm), Height: 4½" (108 mm), Depth: 6" (152 mm).....\$225.00

® **SIGNALCRAFTERS, INC.** ✓S130

5460 Buena Vista Drive
Shawnee Mission, Kansas 66205
913/262-6565; Telex: 42-4171

All Signalcrafters products are designed, engineered and produced in the U.S.A.
Prices include shipping to all U.S.A. — VISA and Master Charge accepted.
Kansas residents please add 3½ percent.





INEXPENSIVELY SUPERIOR

The DS2000 KSR is the lowest priced RTTY terminal available with these advanced features:

- TX/RX operation on Baudot and ASCII RTTY plus Morse Code (Morse RX optional)
- Integrated keyboard and video generator allows editing of transmit text
- Full 24 line by 72 characters per line display
- Bright/dim display of characters differentiates between TX and RX display
- Morse receive option may be added at any time
- Separate CW identification key for RTTY operation
- Status line on top of screen shows terminal operating conditions
- Pretype transmit message into 255 character buffer; edit before transmitting
- 2 programmable "Here Is" messages
- Word-wrap-around prevents word splitting at end of display line
- Word mode allows editing of text to be transmitted
- Quick Brown Fox and RYRY test message keys
- Small size metal cabinet gives effective RFI shielding from transmitters
- Loop compatible RTTY connections and plus or minus CW key connections
- 110 and 300 baud ASCII
- 45,50,57,74,100 baud Baudot
- 1-175 wpm Morse transmit
- 1-175 wpm optional Morse receive
- 120/240 v, 50/60 Hz power
- Internal CW side-tone
- UnShift On Space for Baudot
- Keyboard Operated Switch
- SYNC idle for RTTY
- One year warranty

HAL Communications and amateur radio serving the 1980 Winter Olympics through W.O.R.A.N. (Winter Olympics Radio Amateur Network)

Write or give us a call. We'll be glad to send you our new RTTY catalog.



HAL COMMUNICATIONS CORP.
 Box 365
 Urbana, Illinois 61801
 217-367-7373

For our European customers, contact: Richter & Co. D3000
 Hannover 1 • I.E.C. Interelco, 6816 Bissone/Lugano • Radio
 Shack Ltd., London NW6 3AY • Erik Torpdahl Telecom, DK 3660
 Stenlose Denmark

DS2000 KSR.....\$499.00
ESM-914 Video Monitor...\$169.00
MR2000
Morse receive option....\$159.00

RTTY Loop

Marc I. Leavey, M.D. WA3AJR
4006 Winlee Road
Randallstown MD 21133

In our continuing efforts to inform newly-arrived RTTY addicts of the "stuff" available out there, this month's column will address the question of machine availability. While a comprehensive review is beyond the scope of one column, I hope that readers with specific problems might find some useful information herein.

"Where do I get a Teletype™ machine?" is a question I have heard posed more times than I can count. There are surely several sources for machines, not all of which may be obvious to the newcomer. First of all, open a mouth! Make it known in your area that you are looking for a teleprinter. Tell the guys at the club; if you are not a member—join! Maybe there is a local pub or store where hams congregate. Sally on over there when the crowd is present and ask around. You never know what is sitting in someone's basement. Okay, you say, that's been tried and it is strike one; now what? Start checking the ads on local store bulletin boards and club newsletters. Maybe place a "wanted" ad yourself. When you find a machine for sale, try to find a knowledgeable person to look at it with you, to be sure it works and all that. Then haggle a bit for price, and you've got a machine. Whoops, strike two, you say? Well, it's time to start checking the ham ads in national magazines looking for something reasonably close by to look at. I really would not be too keen on buying a "pig-in-a-poke," that is, a Model 35 shipped sight unseen from California, unless there was some assurance that the machine was worth the money. But that is for the individuals involved in the transaction to work out.

Now, there may be one more

way for the enterprising individual to get a machine at a reasonable price. It's chancy, but can pay off. At the end of most metropolitan newspaper classified ad sections is a list of "auction sales." These usually are companies that went broke and are selling off their inventories, fixtures, and business machines to pay off their creditors. Now, every once in a while, a teleprinter will be part of these sales. Although ASCII machines, such as ASR-33/TELEX machines, are the most common, you never know, and it does not hurt to have one more source. Besides, if you pick up an ASCII machine at a good price, it might pay to convert Baudot to ASCII to use the machine. When ASCII is legal on the ham bands, you would be ready to go. If you have no interest in eight bits whatsoever, you might be able to swap with a Baudot-owner-newly-turned-computerist.

Now, you may notice that I have not said too much about commercial dealers. There is a good reason for that. With few exceptions, and they really are not worth mentioning, no dealer to my knowledge has shown any ongoing concern for the ham market. They might sell you a machine now, but they let letters of inquiry and complaint sit around for a few months. Their prices tend to be a bit higher than buying from another ham, although they tell you they have "reconditioned" the machine. I leave it to you, with a large "caveat," when it comes to dealing with commercial teleprinter firms.

Next month, we will continue with information useful to the neo-RTTY-phyte with a brief survey of some terminal units available: assembled, kit, and scrounge-your-own-parts versions.

Turning to the lighter side, the winner of this month's RTTY Loophole award is the ARRL. It

seems, in an effort to keep all of us in line, QST for October, 1979, carried their "annual updated list of abbreviations," on pages 65-66, to "clip out for easy reference." Trouble is, "RTTY" is listed as meaning "radiotelephone." Thanks to the boys in Newington for that one!

John Bates KA0CCD/8 noted with interest the comments on connecting the TS-820 to run RTTY with most ordinary demodulators. Fig. 1 is the circuit John has been using to connect his TS-180S to a Flesher TU-170. Using a 4N25 optoisolator, John is able to use the TTL level output of the TU to key the transmitter. This should work with any TU that provides a TTL level output. Thanks, John.

Interest in receiving non-ham RTTY signals is quite high and has generated a number of letters. Bud Riegert KØYIP of St. Louis, Missouri, is looking for stations transmitting in ASCII so that he may check out an ASCII-to-Baudot routine for his Apple-II. Anyone with specific information on such stations may forward it along to this column for future inclusion.

Along the lines of the "weather" transmissions covered a few months ago, a letter was received from George P. Firmin WA4FSK (not a bad call for a RTTY enthusiast) who wonders

about decoding transmissions he has received, like this:

66228 05210 05315 05323 04928
66028 06525 06234 05838

Well, George, while I am fairly certain that these, too, are weather information transmissions, I do not have the key to decoding them. I am sure that one of our readers does, however, and hope to be able to pass that along to you in the near future.

The Stark RTTY Group's *Watts Happening* is still coming out of Massillon, Ohio, and contains a new wealth of information, ranging from simple circuits to local sources for RTTY equipment. Write to Joseph Ebner WB8RVM, 138 Page Street N.W., Massillon, Ohio 44646, if you are interested in joining the group.

Don't forget 73's Specialty Communications Achievement Award, mentioned last month. Drop a line to Bill Gosney WB7BFK, care of 73, for information, or check elsewhere in this issue. I am waiting to print the name and call of the first to win this award on RTTY right here in RTTY Loop.

Next month we will cover a few ways to enter the demodulator market. Until then, have a Happy Valentine's Day, and keep those green keys active.

Ham Help

I am a cardiovascular physiologist at the medical school in Recife and a radio amateur (PY7CPC). Teaching physiology with a limited amount of lab equipment is surely a challenge! One of the most useful pieces of equipment is a polygraph recorder (and one of the most expensive items, too).

Can any of my radio amateur colleagues come up with a B/W TV adapter/modulator through which a student could display an EKG or EEG signal? A 1.0-mV/cm vertical display and a sweep of 2.5 cm/sec is what is needed. The EKG has a frequency response of 0.05 to 85 Hz (not very critical for student labs).

This would be a tremendous boon to physiologists and pharmacologists who can't afford to buy expensive recorders for their student labs, and could use their B/W TV as a display. Perhaps somebody could adapt a TV game chip to do the job!

Carlos Peres da Costa, MD PhD
Ave Boa Viagem 4520
Recife PE 50.000 Brazil

I have recently converted a 23-channel CB rig (AM) to 10 meters and am interested in building a mobile linear amplifier for it. I would appreciate receiving copies of schematics of such equipment that others have homebrewed or being referred to recent magazine articles on the subject. The amplifier can be anywhere in the 10- to 50-Watt range. Thanks for any help.

Steve Zahos KR4S
13817 Barne's Spring Rd.
Midlothian VA 23113

I recently acquired a linear amplifier and, after many phone calls, found the successors to the original manufacturer who say that they cannot help me.

I'm looking for an operator's handbook and/or schematic for a Westrex 9200 100 W LPA. It is a rack-mount government style and covers 2-30 MHz. Any help would be greatly appreciated.

Paul T. Petty KB7BP
Box 366
Hawthorne NV 89415

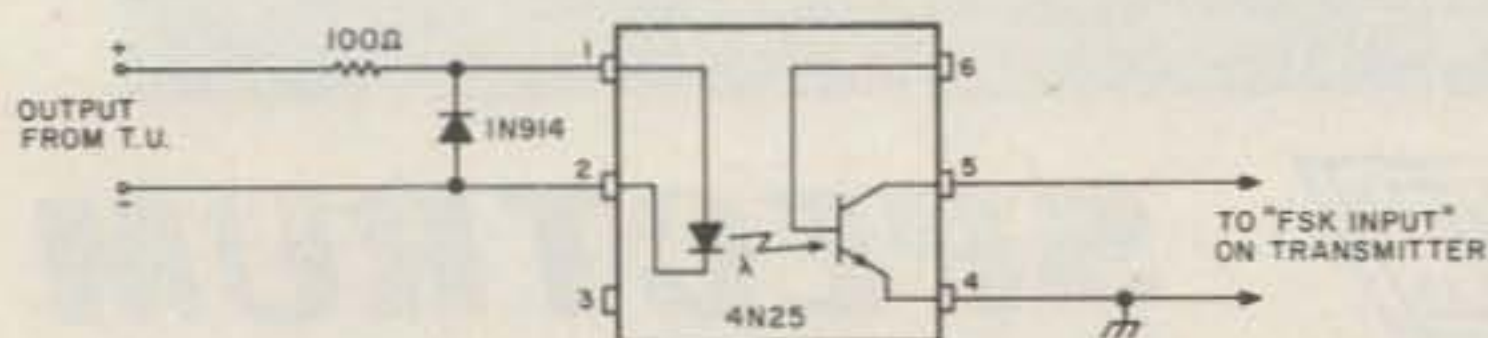

Fig. 1.

SCR1000 VHF—SCR4000 UHF

**For Your New Repeater System,
Or, to Replace Your Old "Klunker"**

*Go First
Class!*

**2 Mtr.
220 MHz
450 MHz**

- 30W Output.
- Low Noise/Wide Dynamic Range Front End for Excellent Sensitivity & IM Rejection.
- Sensitivity: 0.35uV Typ.
- 8 Pole IF Crystal Filter.
- Full Metering, Lighted Status Indicators/Control Push-buttons, Btry. Power Input, AC Pwr. Supply, CW IDer, etc., etc.!

Made in USA

SCR1000 IS FCC
TYPE ACCEPTED
for Commercial
Services

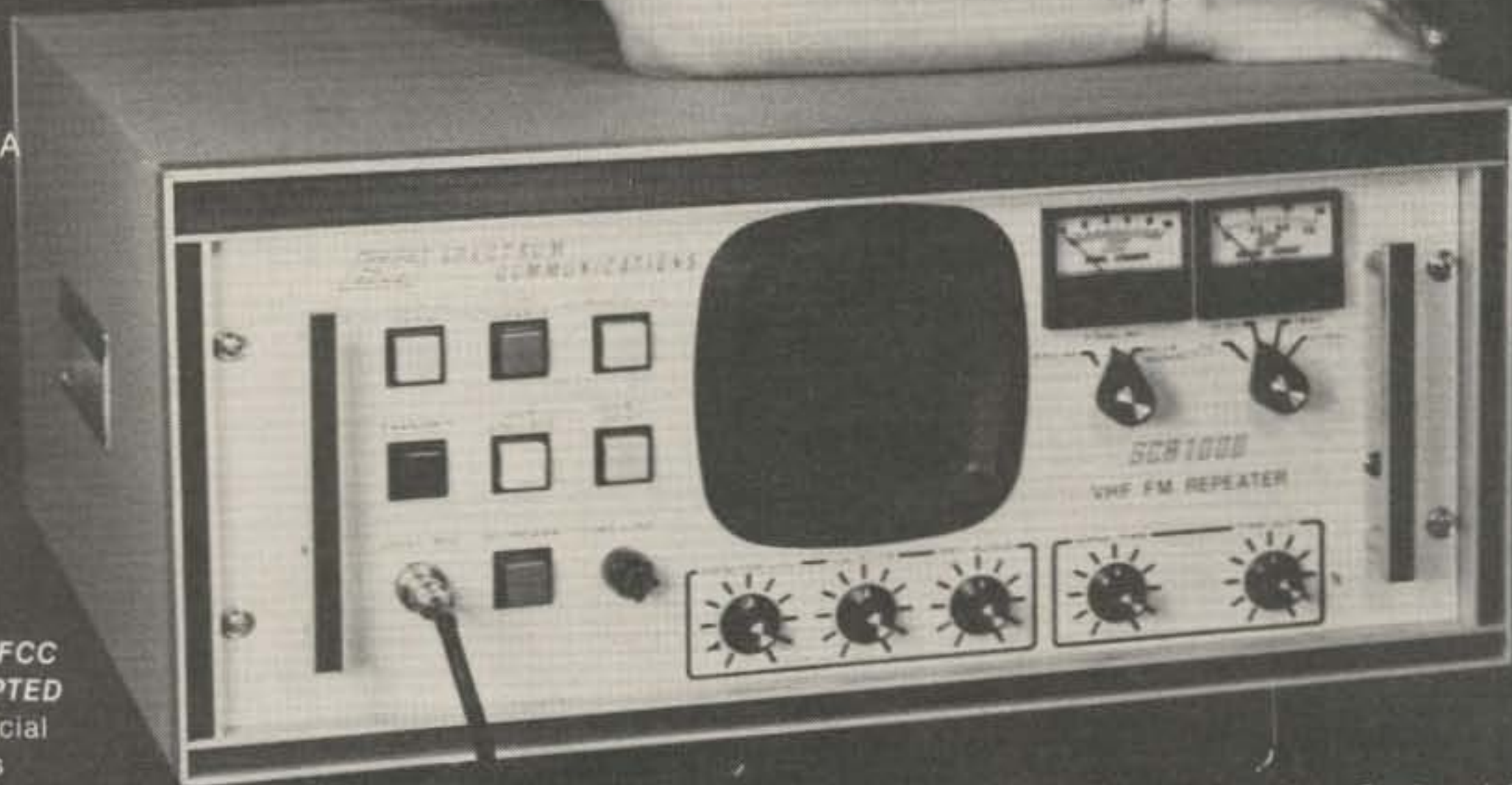

Shown in Optional Cabinet

**30 or 70 WATTS
on 2 Mtrs.!**

Available with Full Autopatch/Reverse Patch/Land-Line Control; Touch Tone Control of various repeater functions; "PL"; "Emergency Pwr. I.D."; various Tone & Timer Units, etc. PLUS—the finest Duplexers, Cabinets, Antennas, Cables, etc. Our Repeaters are sold factory direct only, or through Foreign Sales Reps. Get your order in A.S.A.P.!

180 Day Warranty

Call or write today and get the details!



SPECTRUM

Export Orders — Contact our International Dept.

1055 W. Germantown Pk., Dept. S2

new

COMMERCIAL MOBILE & BASE TRANSCEIVERS

Spec Comm "Professional Communications Line"

Features

- 136-174 MHz & 220-240 MHz (450 soon).
- 6 channels.
- 0.35 uV Rcvr.
- 6 or 8 Pole Crystal Fitr.
- Beautiful Audio—RX & TX.
- Very Reasonable Price!

PCL250 25 Wt. Mobile Unit

- "Super Rugged" Housing
- Solid 1/8" Thk. Aircraft Aluminum!



• Very attractive woodgrain housing.



PCL300 25 Wt. Base Station

- Built-in AC Power Supply.
- Front Panel Status Indicator Lights.
- Optional Rcvr. Scanning Function Available.

SPEC COMM REPEATER BOARD & SUB-ASSEMBLIES

These are Professional "Commercial Grade" Units—Designed for Extreme Environments (-30 to +60° C).

All equipment assembled & tested. For 2M, 220 MHz & New 450 MHz.

SCR100 BOARD

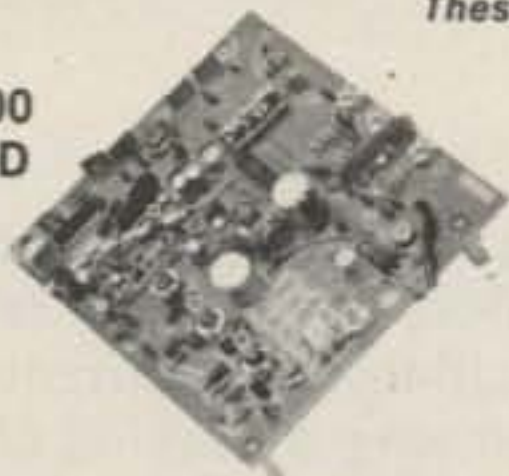

SCR100 VHF Receiver Board

- Wide dynamic range! Reduces overload, 'de-sense', and IM.
- Sens. 0.3 uV/20 dB Qt. typ.
- Sel. -6dB @ ± 6.5 KHz, -110dB @ ± 30KHz, (8 Pole Crystal Fitr.)
- 'S Meter' Output.
- Exc. audio quality! Fast squelch! w/xtal.

SCR100 Receiver Assembly

- SCR100 mounted in shielded housing
- Same as used on SCR1000
- Completely asmbld. w/F.T. caps, SO239 conn., AF GAIN POT, etc.

SCR450 UHF Receiver Bd. or Assy.

- Similar to SCR100, except with 12 Pole IF Fitr. & 8 Resonator Front End Fitr.!
- Discriminator & Deviation Mtr. Outputs
- **Totally New Advanced Design!**

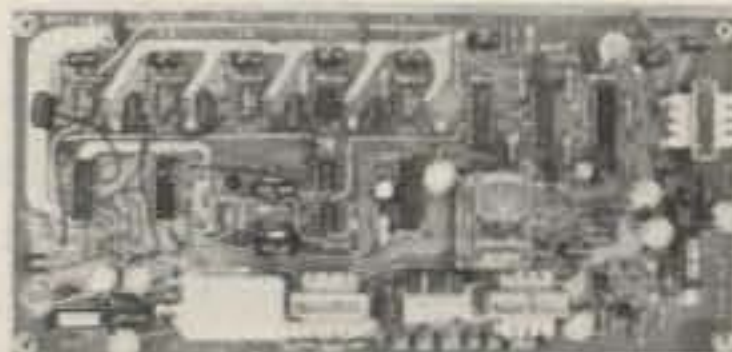

SCAP Autopatch Board

- Provides all basic autopatch functions
- 3 Digit Access; 1 Aux. On/Off function; Audio AGC; Built-in Timers; etc.
- 0/1 Inhibit bd. also available.
- Write/call for details and a data sheet.

RPCM Board

- Used w/SCAP board to provide "Reverse Patch and Land-Line Control of Repeater.
- Includes land line "answering" circuitry



RX ASSY.

TX ASSY.

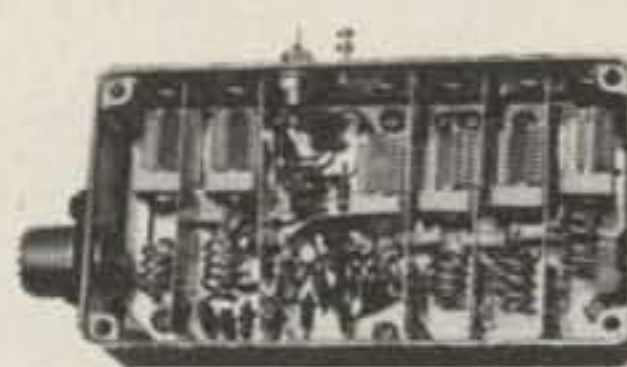

FL-6

FL-6 Rcvr. Front-End Preselector

- 6 HI Q Resonators with FET preamp (2M or 220 MHz).
- Provides tremendous rejection of "out-of-band" signals w/out the usual loss! Can often be used instead of large, expensive cavity filters.
- Extremely helpful at sites with many nearby VHF transmitters.
- Gain: apx. 10 dB.
- Selectivity: -20 dB @ ± 2.0 MHz; -60 dB @ ± 6 MHz (typ.).

TRA-1 Timer Reset Annunciator Board

- Puts out a tone "beep" on rptr. xmtr. apx. 1 sec. after rcvd. signal drops—thus allowing time for breakers.
- Resets rptr. time-out timer when tone is emitted.
- Adjustable time delay and tone duration.
- For use with CTC100 and ID100/250.

TMR-1 Timer Board

- Can be set up for 1 of 2 configurations.
- #1) Time Out Warning Tone.
- #2) "Kerchunker Killer" — initial Rptr. Xmtr. key-up delay.
- For use w/SCR1000, or CTC100/ID250.

CTC100 COR/Timer/Control Board

- Complete COR circuitry.
- Carrier 'Hang' & T.O. Timers.
- Remote xmtr. Inhibit/Reset control.
- Provision for panel control switches & lamps.
- 100% Solid State CMOS logic.
- Many other features

ID250 CW ID & Audio Mixer Board

- Adjustable ID tone, speed, level, timing cycle.
- 4 Input AF Mixer & Local Mic amp.
- COR input & xmtr. hold circuits.
- CMOS logic; PROM memory—250 bits/channel.
- Up to 4 different ID channels!
- Many other features, Factory Programmed

SCT 110 BOARD



SCT110 VHF Xmtr/Exciter Board

- 7 or 10 Wts. Output. 100% Duty Cycle!
- Infinite VSWR proof
- True FM for exc. audio quality
- New Design—specifically for continuous rptr. service
- Very low in "white noise"
- Spurious -70 dB. Harmonics -60 dB.
- With .0005% xtal.
- BA-10 30 Wt. Amp board & Heat Sink, 3 sec. LPF & rel. pwr. sensor.

SCT110 Transmitter Assembly

- SCT110 mounted in shielded housing
- Same as used on SCR1000
- Completely asmbld. w/F.T. caps, SO239 conn.
- 7, 10 or 30 Wt. unit.

SCT410 UHF Transmitter Bd. or Assy.

- Similar to SCT110, 8-10 Wts.
- Avail. w/ or w/o OS-18 Super High Stability Crystal Osc./Oven.
- BA-450 30W. min. Amp. Bd.

new

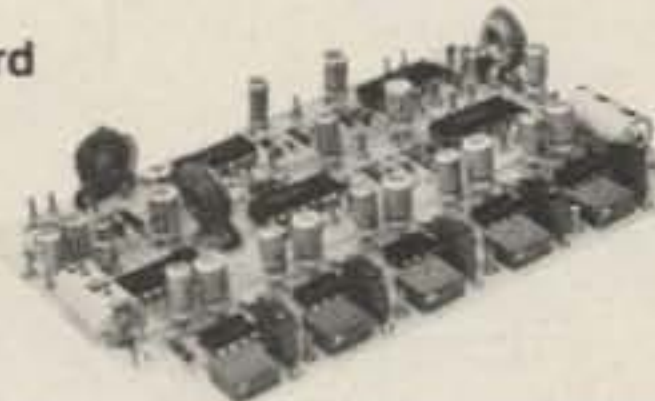

TTC100 Touchtone Control Board

- 3 digit ON, 3 digit OFF control of a single repeater function. Or, (optional) 2 functions (2 digits ON/OFF each).
- Can be used to pull in a relay, trigger logic, etc.
- Typically used for Rptr. ON/OFF, HI/LO Pwr., P.L. ON/OFF, Patch Inhibit/Reset, etc.
- Stable, anti-falsing design. 5s Limit on access.
- For Add'l Function(s)—Add a "Partial TTC" Board.

COMMUNICATIONS CORP.

Send for Data Sheets!

✓ S8

Norristown, PA 19401 • (215) 631-1710

CB-to-10 FM Continued

— another way to join the fun on 29.6

John Sehring WB2EQG
P.O. Box 306
Oradell NJ 07649

Recently increasing FM activity on 10 meters between 29.5 and 29.7 MHz has led me to investigate methods of getting on this interesting

mode. Actually, the thing that got me started occurred one Saturday afternoon as I tuned above 29.5 MHz looking for a local 10-meter FM repeater. Much to my surprise (who in the heck ever tunes up this high on 10 meters, anyhow?), there was plenty of activity. In particular, WR2ANW's 10-meter-to-2-meter crossband link was

hopping, and there were plenty of stations on the simplex frequency (29.6 MHz), too. I noticed that the combination of sometimes terrific 10-meter propagation and the QRM- and QRN-suppressing characteristics of FM was quite intriguing—DX signals often sounded just as clean and quiet as locals. After hearing all this, I thought it would be nifty to talk to the boys on 29.6 as well as the local 2-meter gang via the crossband repeater link. (There are easier ways of getting on 2 meters, though!)

I sat down to figure out the fastest and easiest way of getting on 10-meter FM. Unfortunately, there was no surplus commercial lowband FM (30 to 50 MHz) gear around the shack; such gear would have been relatively easy to convert to 10 meters. The only piece of equipment that covered 10 meters was the main station HF transmitter, a filter-type SSB/CW exciter, a Hammarlund HX-50A. Turning to the "technical library" for some ideas yielded the distinct possibility of FMing a transmitter simply by hang-

ing a variable-capacitance diode (varactor) in the oscillator tank circuit.¹⁴ By applying a varying (audio) voltage to the varactor, it might just be possible to shift the oscillator's frequency at an audio rate—in other words, frequency modulation! Luckily, this method got me on FM in just a couple of hours, using only a few parts. Here's how.

Varactors are small diodes whose capacitance can be controlled by an externally applied voltage; they are used often these days to replace variable capacitors in tuning circuits. Most varactors are rated for their nominal capacitance at about 4 V dc and are typically operated from 2 to 30 volts. See Fig. 1 for a typical varactor operating curve.

A simple circuit using a varactor to supply a voltage-controlled capacitance is shown in Fig. 2. Here, the potentiometer, R, applies a dc control voltage to the varactor, VC, which determines its capacitance. Capacitors C1 and C2 provide rf bypassing and dc blocking, while the RFC keeps rf energy out of

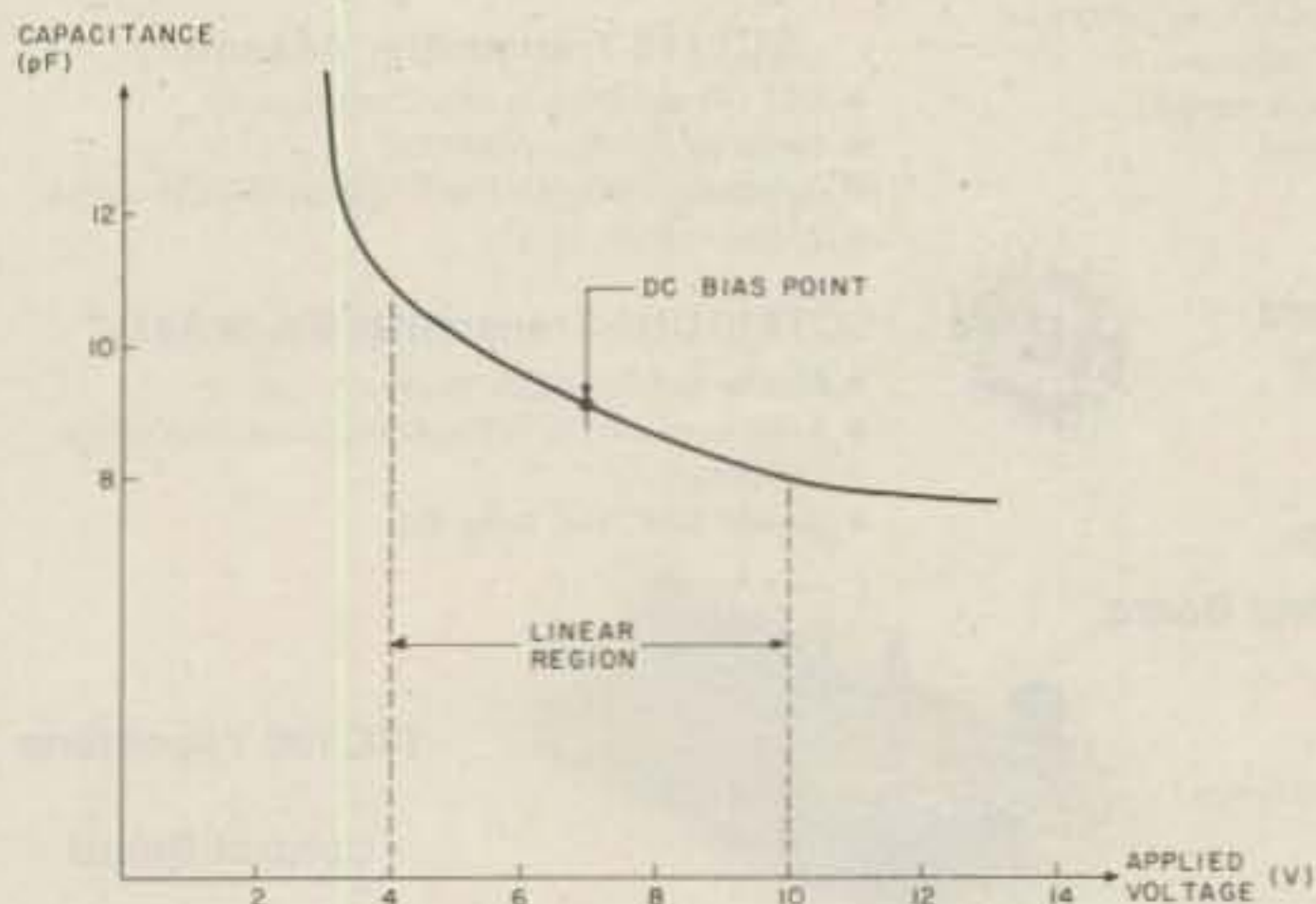

Fig. 1. Typical varactor characteristic curve.

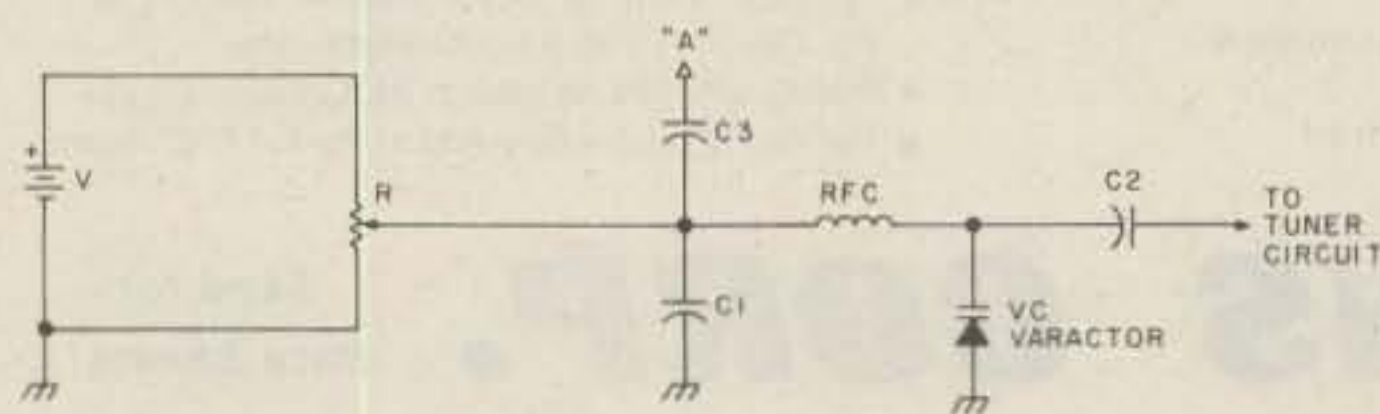

Fig. 2. Basic varactor circuit.

the power supply. Changing the applied dc voltage shifts the varactor's capacitance as per the curve in Fig. 1.

Now, if the varactor circuit were connected to the tuned LC circuit of an oscillator, then the varactor's changing capacitance would shift the oscillator's frequency a certain amount, by adding or subtracting from the total tank circuit capacitance. Let's take this idea one step further. Suppose that we now apply an audio (ac) voltage to the varactor circuit at point A of Fig. 2, through the coupling capacitor, C3. The varactor would then change its capacitance in step with the applied audio voltage. With the varactor connected to an oscillator's tank circuit, the oscillator's frequency would once again be shifted, but this time the frequency shift would be in step with the applied audio voltage. Hence, we would have frequency modulation of the oscillator.

You may wonder why we continue to apply dc voltage to the varactor along with the audio voltage. A look at Fig. 1 shows that the varactor's voltage-capacitance characteristic is linear (straight) only in the center of its curve. That's the part of the curve which we want to use for our frequency modulation scheme, swinging the varactor's capacitance upward and downward from the center of this linear region with our audio (modulating) voltage, to achieve linear frequency modulation. The adjustable dc bias is used to place us at the center of the linear portion of the curve.

My particular rig already has a varactor in its vfo tank circuit (as shown in Figs. 3 and 4), which is typical of vfo circuits. The

varactor's purpose has nothing to do with modulation, though, and is used for shifting the vfo's frequency by about 3 kHz to offset SSB carrier-oscillator shift when switching from USB to LSB. The varactor already has some dc bias voltage on it, so let's see what happens when an audio voltage is also applied. Remember, though, that this technique is applicable to many different kinds of transmitters or transceivers, old or new, CW, AM, or SSB, since they all have oscillator(s) which can be frequency modulated. The basic idea is to get just a bit of audio-modulated capacitance into a suitable point of a variable or crystal-controlled oscillator tank circuit in order to frequency-modulate it. For example, since almost all SSB rigs use frequency heterodyning stages, conceivably any oscillator in the chain (vfo or crystal) could be FMed by the varactor circuit. (If you're a Yaesu FT-101 owner, see Reference 5.)

Fig. 4 shows the actual varactor frequency modulator circuit used. Point B is where the varactor circuit is connected to the vfo of Fig. 3. The audio signal is applied at point A of the varactor circuit, Fig. 4, as before. For a source of audio, I first used an inexpensive cassette tape recorder and microphone. The recorder's speaker output was connected to the varactor circuit at point A of Fig. 4. It worked! However, the first few QSOs revealed that the audio quality was bassy and muffled. The audio coupling capacitor, C3, then was made smaller until acceptable audio quality resulted; the final value of C3 in my particular application was 270 pF.

Actually, some of the bassy audio quality results from the fact that most FM

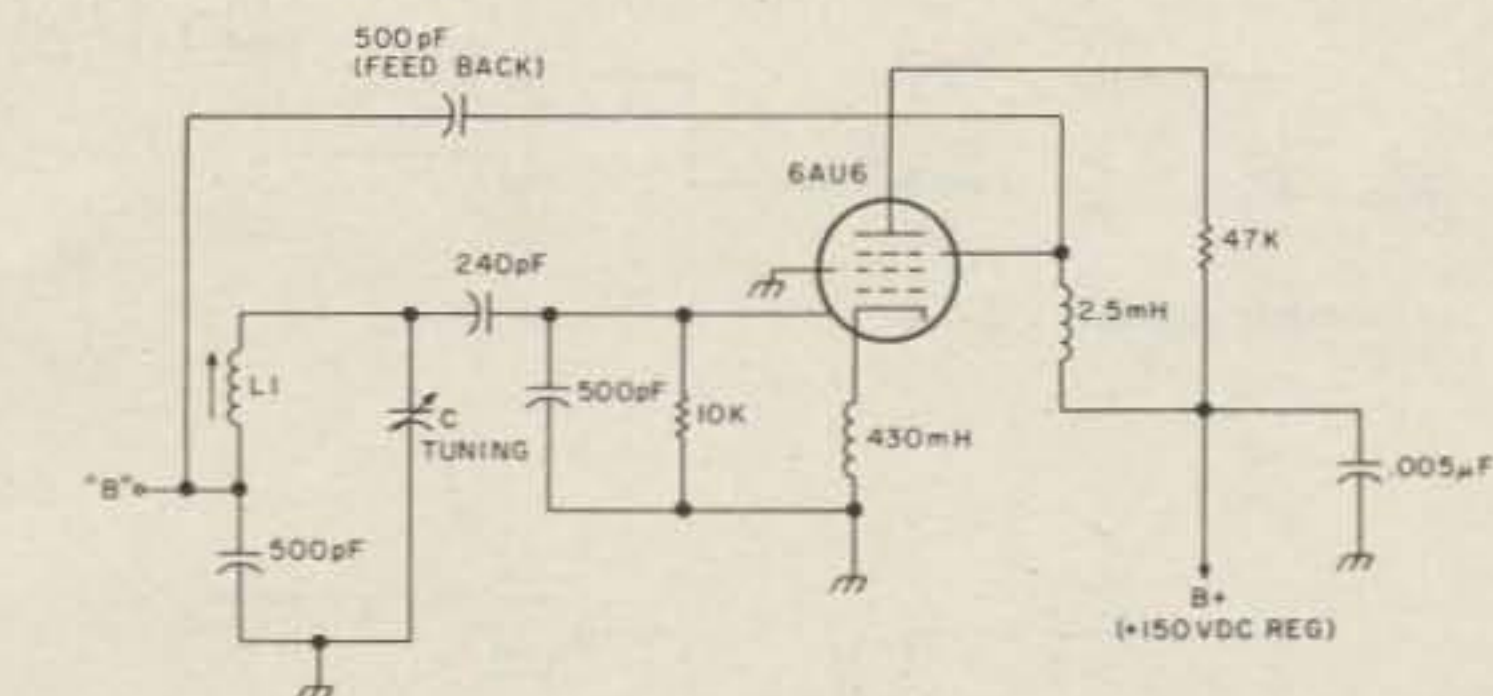

Fig. 3. Typical 6-MHz vfo.

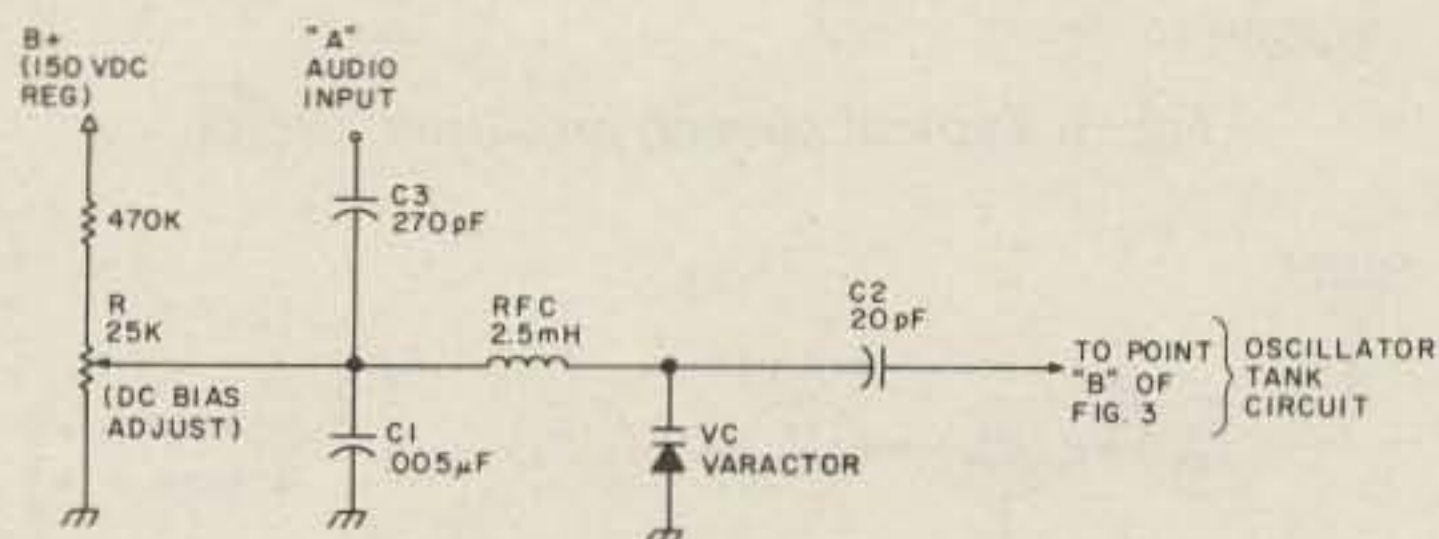

Fig. 4. Varactor frequency modulator circuit. Varactor part numbers: 1. Motorola HEP-R2503 (20-pF nominal capacitance); 2. Motorola MV2205 or MV2209 (swing 15 to 60 pF); 3. Motorola MV839; 4. Amperex H4A/1N4885.

receivers have "de-emphasis" circuits built in, which roll off the audio frequency response at the high end. Such a circuit is intended to complement (cancel out) the opposite kind of circuit built into FM transmitters, "pre-emphasis," which boosts the higher audio frequencies. This scheme is used to enhance the overall signal-to-noise ratio of an FM system by boosting the highs on transmit and cutting them on receive. I don't pretend that a sufficiently small value of coupling capacitor will produce exactly the right amount of pre-emphasis, but it does the job and produces pleasant audio quality on FM receivers.

You'll also have to decide what value to use for capacitor C2 in Fig. 4. If this capacitor is too small, you won't be able to get enough deviation; if it's too large, you'll have too much deviation, and it may throw your vfo way out of calibration and/or load it down excessively. I would suggest starting out with small values of capaci-

tance at first and then increasing them if necessary. Examination of your particular vfo circuit should reveal where to attach the varactor circuit and roughly how big C2 should be.

References 1 through 4 show numerous different types of oscillators and similar methods of FMing them. As a rough guide in setting up your circuit, determine how much \pm dc voltage is needed on the varactor to shift your oscillator by plus and minus 5 kHz; you can check the frequency shift using a receiver with a bfo and an accurately calibrated dial. The value of dc voltage thus determined will then be approximately the peak level of audio voltage you'll need. One of the nice things about FM is that practically no power (only voltage) is necessary for the frequency modulator. I wound up with plenty of deviation to spare.

Although this lash-up worked on the first try, who would want a tape recorder patch cord hanging out of the bottom of the rig permanently? So, a way of

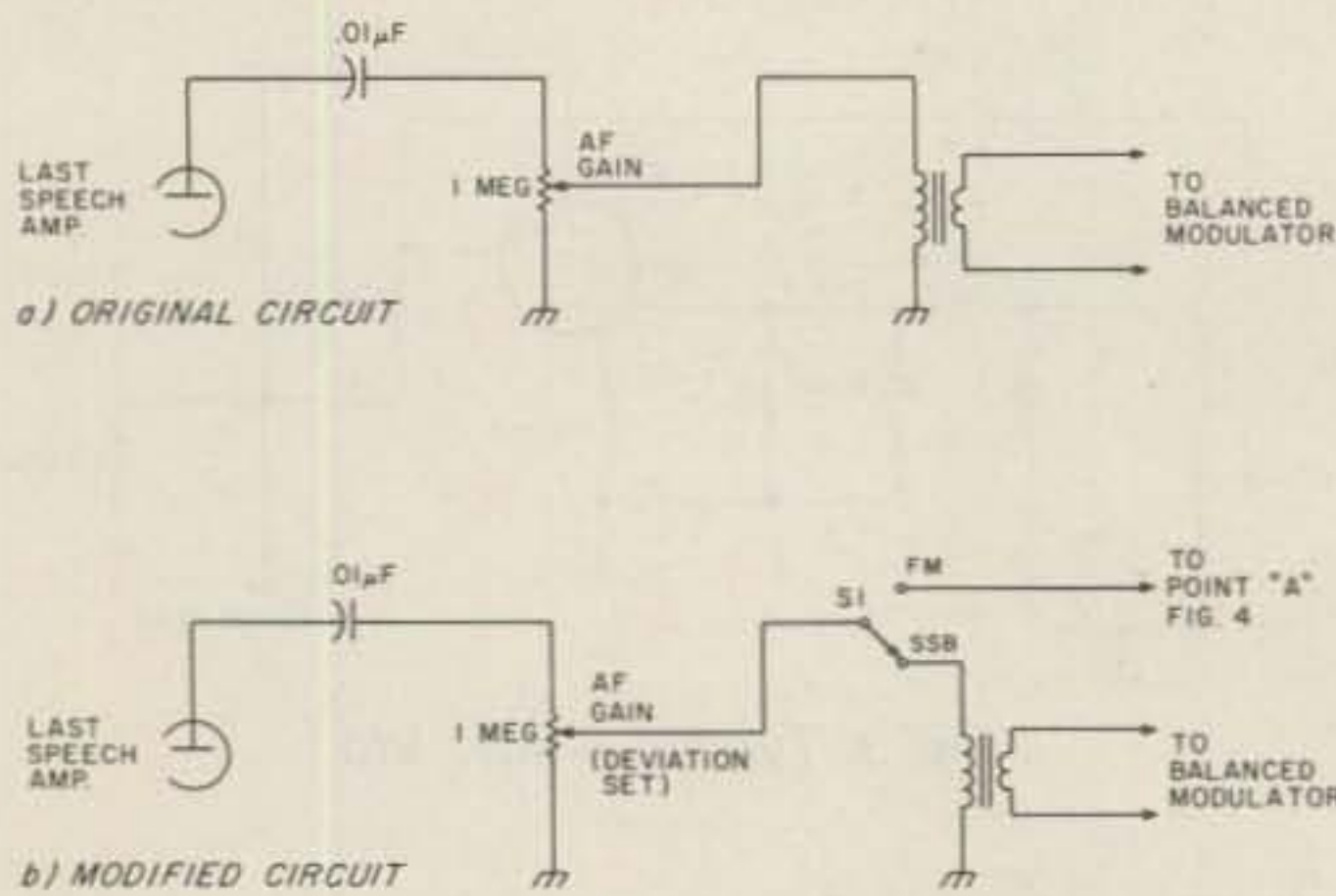

Fig. 5. Typical speech amplifier circuit.

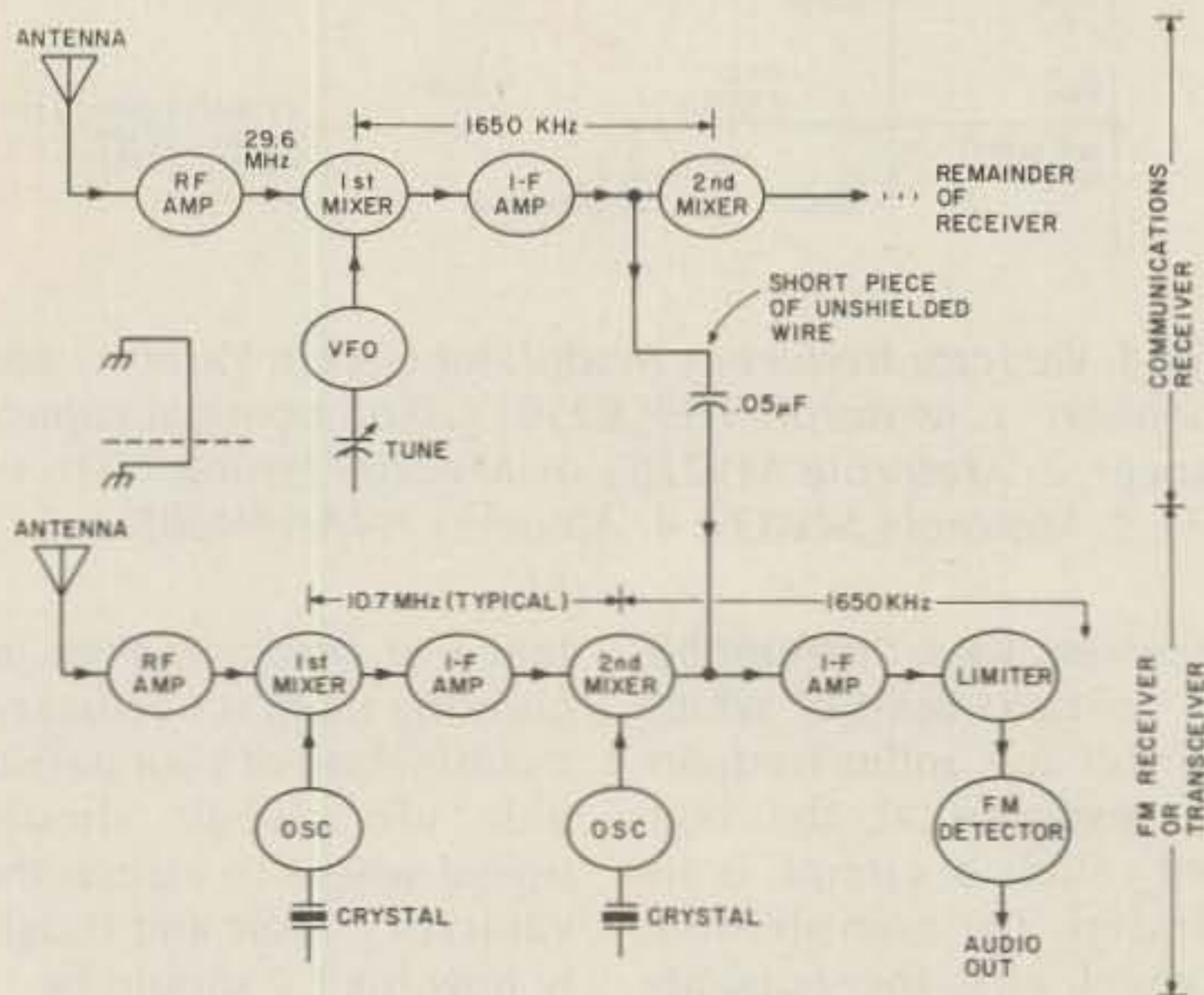

Fig. 6.

using the rig's own built-in speech amplifier was sought. A partial schematic of the Hammarlund's speech amplifier appears in Fig. 5 along with the very simple modification for FM. Once again, the speech amplifier circuit is quite typical; usually only a few volts of audio is needed. The SPDT switch, S1, removes the audio from the balanced modulator and applies it instead to the varactor circuit of Fig. 4. Shielded cable should be used for this modification, to avoid hum and rf pick-up. The beauty of this change is that it in no way alters the other functions of the transmitter.

Operation on FM is simple: Tune up the rig in the CW mode, observing the maximum rated plate current limit for continuous, key-down operation. This is

likely to be less than the rated CW input and equal to the RTTY or SSTV ratings, as we certainly don't want to overstress the final amplifier or power supply. After tune-up, flip S1 to FM and set the microphone gain for the desired amount of deviation. I happen to use an outboard speech processor (af compressor/clipper/low-pass filter combination) intended for SSB use on FM, too—it keeps the average deviation level (analogous to modulation percentage) high, prevents over-deviation, and crispens up the audio somewhat.

Some questions remain, though, about the operation of an FM transmitter: How much deviation is permissible, and how do you correctly adjust your FM transmitter for it? Well, most FM activity is limited

to ± 5 kHz deviation—so-called narrowband FM. First, you can roughly set your deviation based on signal reports from other FM operators. However, since each FM receiver will have somewhat different tolerances to over-deviated signals, you may get inconsistent observations. Generally speaking, your audio should sound about as "loud" (have as much deviation) as most other FM signals on the air, but no greater. Excessive deviation will sound grossly distorted and can cause splatter.

For deviation adjustment purposes, you also can use the following technique: Set FM deviation using an SSB receiver, by tuning the FM signal for zero beat, with no modulation applied. Then, while listening to the FM signal, modulate the FM transmitter normally and advance its deviation control (microphone gain) until the signal thus received becomes grossly distorted; back off on the deviation control until the signal becomes clean again. Use the widest available selectivity setting on the SSB receiver for making this adjustment. For example, a 5-kHz-wide receiver would indicate roughly the ± 5 kHz deviation limit.

For practice, you might try listening to FM signals on the air, to get an idea of what a narrowband FM signal sounds like on your particular SSB receiver; a repeater output would probably be a good bet to be properly adjusted. Note, however, that an FM signal thus detected will obviously not be demodulated properly (it will probably sound garbled), but the onset of distortion caused by excessive deviation will be clearly audible.

The theory behind this technique is that the first pair of FM sidebands of an

FM signal is indistinguishable from the sidebands of an AM signal. FM and AM signals thus considered differ only in that the FM sidebands and carrier are 90° out of phase with one another, whereas the AM sideband and carrier are in phase with each other. Further, for narrowband FM, both the first pair of FM sidebands and the AM sidebands occupy approximately the same bandwidth when using equal modulating signals. By receiving an FM signal on an SSB receiver with its bfo operating ("exalted-carrier" reception), you can replace the FM signal's 90° phase-shifted carrier with the bfo carrier (which is not 90° shifted). This provides an "equivalent" AM signal for our adjustment purposes.⁴

What about the reception of FM signals? Slope-detection in the AM mode works OK on most receivers by tuning off to one side of the FM signal; use the broadcast selectivity available. Ironically, the steeper the sides of the AM receiver's selectivity characteristics are, the harder it is to slope-detect an FM signal. Unfortunately, slope-detection doesn't provide any of the FM reception advantages—quieting and impulse noise rejection, for example. I presently use two different methods for true FM reception.

First method: The main station receiver here is a Hallicrafters SX-101A. This receiver has a double-conversion i-f strip, with a first i-f frequency of 1650 kHz. Also at hand is a Hammarlund FM-50A VHF-FM transceiver that has a 1650-kHz second i-f frequency. To use the SX-101A as a tuneable front end for the FM-50A's FM i-f strip, make these changes: First, remove the SX-101A's second mixer tube (V5, a 6BA6) and insert a short

piece of unshielded, insulated wire into pin 1 (grid circuit) of the now empty 6BA6 socket. Then, connect the other end of the wire to the grid circuit of the FM-50A's first 1650-kHz i-f amplifier via a .05-uF disc capacitor. Removing the FM-50A's receive crystal or mixer tube will disable its front end.⁶ See Fig. 6.

Another such combination I've used consisted of a general coverage receiver having a single-conversion 455-kHz i-f strip, used to feed the latter half of a transistorized FM i-f strip, also at 455 kHz, from a Johnson "Monoscan" UHF scanner.* In addition, numerous FM adapter circuits and ideas may be found in References 1, 2, and 4. With a little experimentation, comparable hybrid arrangements with other sets may be found to be feasible.

Second method: Use a crystal-controlled converter (for example, a VHF Engineering Model RF-28** or Hamtronics Model C25-50***) to convert the 10-meter signals down to the i-f frequency of the FM i-f strip you want to use; for example, 10.7 MHz is a common i-f frequency. Just about any FM i-f strip is usable like this—all that you have to do is select a converter crystal to match the i-f frequency you need. See Fig. 7. The only trick is to select the right spot to inject the converter's output into the i-f strip. The best point seems to be just

before the high i-f band-pass filter; most of these filters have relatively low input impedances (about 500 to 1000 Ohms), making connections relatively un-critical. Fig. 8 shows a common FM i-f strip configuration.

In case you're wondering, yes, Virginia, 10-meter FM operation is channeled. The frequencies are: national simplex—29.6 MHz (don't call CQ though; "QRZed" or "listening on the frequency" is better). Repeater pairs are —input/output, 29.52/29.62, 29.54/29.64, 29.56/29.66, and 29.58/29.68 MHz. Most are open machines. Caution: Don't go below 29.5 MHz using ± 5 kHz FM because the Friendly Candy Company doesn't allow it— ± 2.5 kHz FM is the limit "down below." Lately, I've heard some simplex activity on frequencies between the repeater outputs, e.g., 29.61, 29.63 MHz, etc.

Results: Running 75 Watts output to a vertical antenna and using the first reception method has yielded fine results. I've worked mobiles all over the country with full quieting and some DX, too! Telling the guy at the other end that he's listening to a modified SSB exciter gives him something to think about, too.

Additional applications: There are some other important uses for FM or frequency-shift capability in an HF transmitter. You can achieve very clean frequency-shift keying (FSK) for radioteletype (RTTY) operation by feeding two discrete dc voltages to the varactor circuit (omit the coupling capacitor, C3), to give you the proper frequency shifts. Also, it would appear that better slow-scan television quality (SSTV, which uses frequency-modulated video signals)

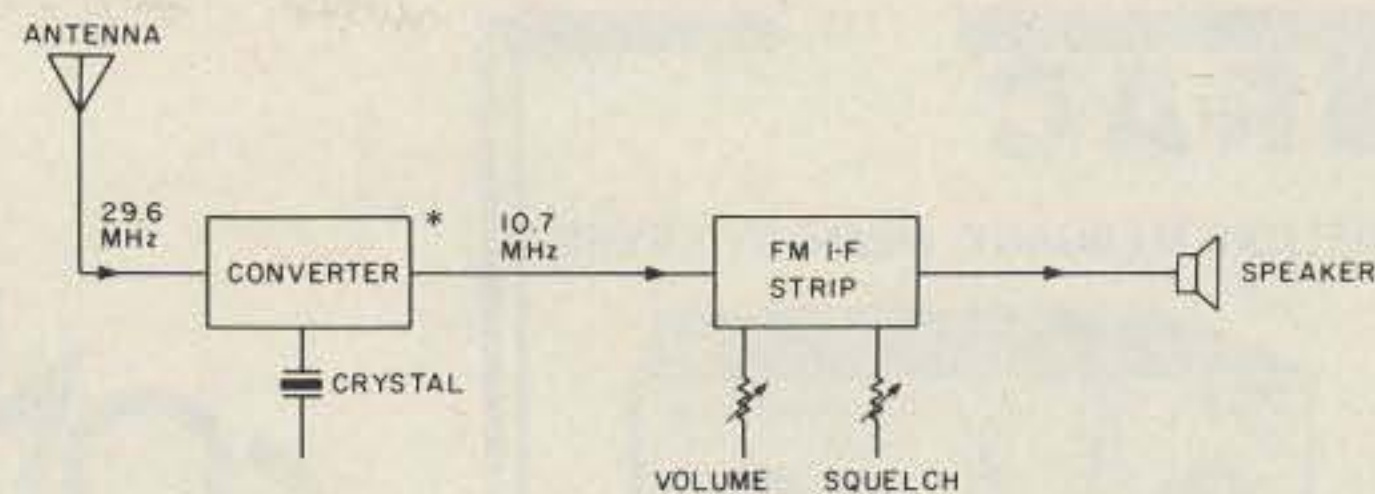

Fig. 7. 10-meter FM reception. (Can be any i-f frequency.)

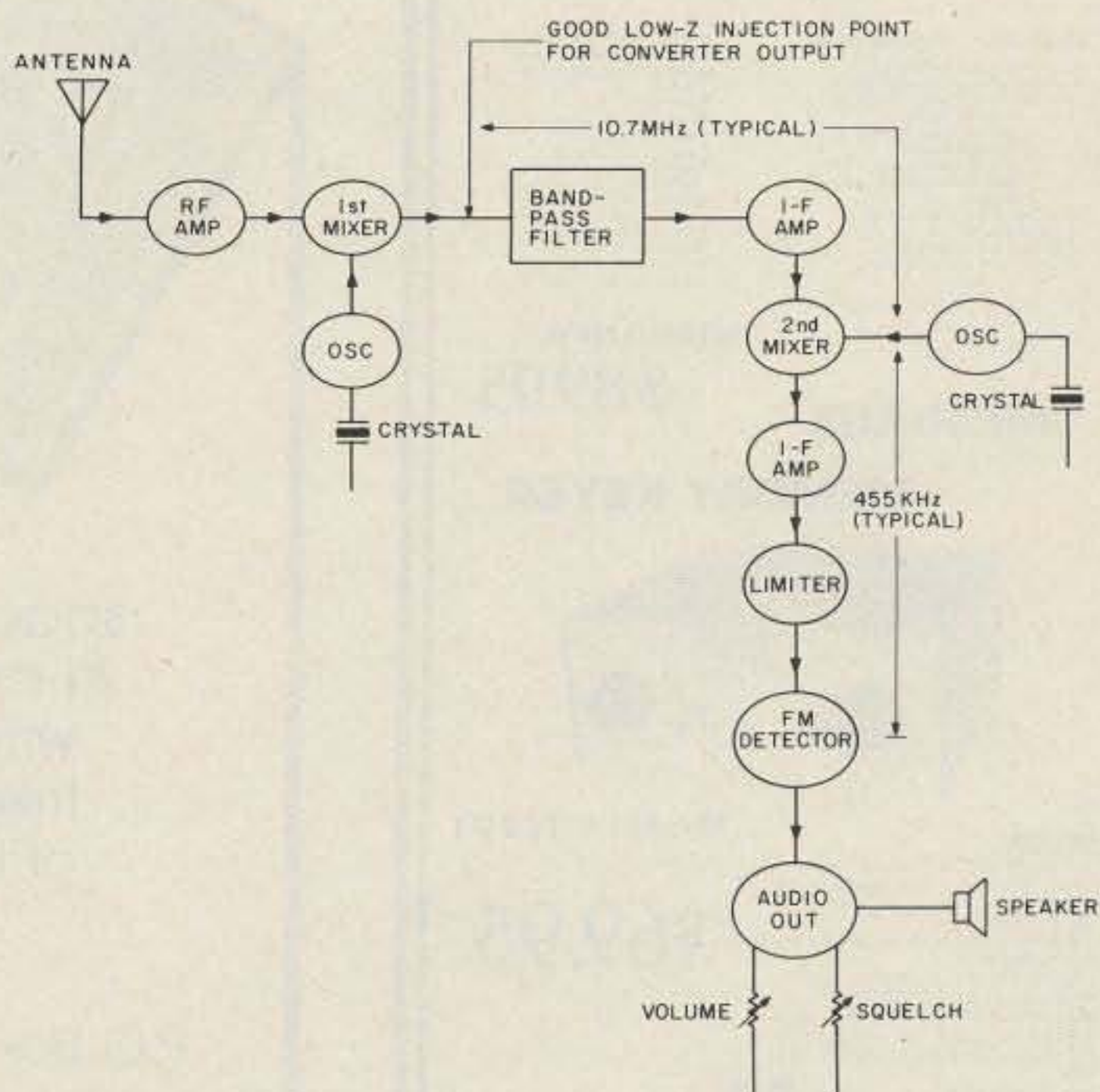

Fig. 8. Typical FM receiver block diagram.

could be achieved by, once again, directly FMing the transmitter, using the varactor frequency modulator instead of feeding the SSTV (or RTTY) signals through the microphone input of the transmitter. In both the RTTY and SSTV modes, nonlinear operation, spurious products, and splatter may result unless: (a) your carrier and unwanted sideband suppression is very good, and (b) your speech amplifier, balanced modulator, filter, and amplifier stages are amplitude- and phase-linear and distortion-free (quite rare!). Direct frequency modulation of the carrier gets around the problem of avoiding the speech amplifier, balanced modulator, and filter stages entirely.

As a final thought, those of you with 10- to 6- or 2-meter transverters could easily get on VHF-FM. And,

of course, the ideas in this article and in the references would be just fine for getting on FM that old VHF-AM/CW rig lying around the shack.

I would welcome your experiences and comments on 10-meter FM operation, and I'll answer questions if you include an SASE. CUL on 29.6 FM! ■

References

1. *The Radio Amateur's Handbook*, American Radio Relay League, 1976.
2. *FM and Repeaters for the Radio Amateur*, ARRL, 1972.
3. *The Radio Amateur's VHF Manual*, ARRL, 1972.
4. *Amateur Radio Techniques*, Radio Society of Great Britain, 1978, p. 199, "Setting N.B.F.M. Deviation," originally from QST, December, 1972, article by D. Collins K4GGI/1.
5. "VHF Transverters and the FT-101," *73 Magazine*, July, 1978, p. 168.
6. *Hints & Kinks*, "Providing a Tunable VHF-FM Receiver," ARRL, 1978, p. 108.

*Available (used) without cabinet, power transformer, or crystals from: Science Workshop, Box 393, Bethpage NY 11714, for \$14.95; a nice item for experimenters.

**Available from: VHF Engineering, 320 Water St., Binghamton NY 13901, in kit form, \$13.95 plus postage.

***Available from: Hamtronics, Inc., 65A Moul Rd., Hilton NY 14468, in kit form, \$25.50 plus postage.

TRAC

DELUXE MESSAGE MEMORY KEYS

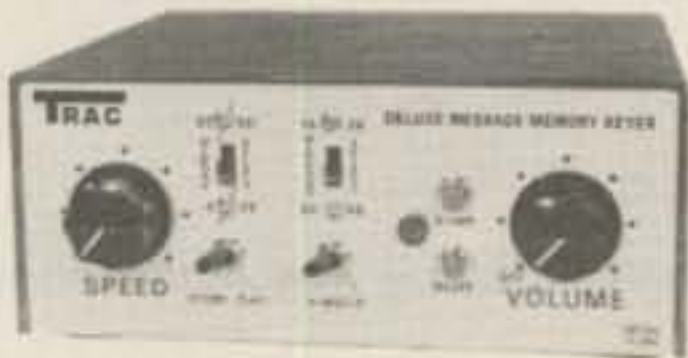

Features: Model TE-284

- State-of-the-art CMOS Circuitry
- Three choices of Message Storage
 - A- Two 25 character each message storage
 - B- Four 25 character each message storage
 - C- One 25 character and two 25 character message storage
- Records at any speed except at any speed
- Memory operating LED
- Use for daily QSO or contests

- PLUS:**
- Self completing dots and dashes
 - Both dot and dash memory
 - Iambic Keying with any squeeze paddle
 - 5-50 wpm
 - Speed, volume, tone, tune and weight controls
 - Sidetone and speaker
 - Low current drain CMOS battery operation—portable
 - Deluxe quarter-inch jacks for keying and output
 - Keys grid block and solid state rigs
 - **WIRED AND TESTED FULLY GUARANTEED—LESS BATTERY**

"BRAND NEW"
\$89.95

MESSAGE MEMORY KEYS



Model # TE201

Features:

- Advanced CMOS message memory
- Two (50 char. each) message storage
- Repeat function
- Records at any speed—plays back at any speed
- Longer message capacity
- Example: send CO CO CO DX de WB2YJM WB2YJM K—then play second message on contact—de WB2YJM GSL NY NY 579 579 Paul K
- Use for daily QSOs or contests

\$69.95

- PLUS:**
- State-of-the-art CMOS keyer
 - Self completing dots and dashes
 - Both dot and dash memory
 - Iambic keying with any squeeze paddle
 - 5-50 wpm
 - Speed, volume, tone, tune and weight controls
 - Sidetone and speaker
 - Low current drain CMOS battery operation—portable
 - Deluxe quarter-inch jacks for keying and output
 - Keys grid block and solid state rigs
 - **WIRED AND TESTED FULLY GUARANTEED—LESS BATTERY**

"BRAND NEW"
Model # TE144
59.95



Features: Deluxe CMOS Electronic Keyer

- State-of-the-art CMOS circuitry
- Self completing dots and dashes
- Both dot and dash memory
- IAMBIC keying with any squeeze paddle 5-50 wpm
- Speed, weight, tone, volume tune controls & sidetone and speaker
- Semi-automatic "bug" operation & straight keying—rear panel switch
- Low current drain CMOS battery operation—portable
- Deluxe quarter inch jacks for keying and output
- Keys grid block and solid state rigs
- Wired and tested—fully guaranteed—less battery

MODEL TE133—same as TE144 with wgt and tone control internal, less semi-auto keying. \$49.95

MODEL TE122—same as TE133 less wgt, tune, solid state keying \$36.50

AT YOUR DEALER OR SEND CHECK OR MONEY ORDER.

TRAC ELECTRONICS, INC
1106 RAND BLDG.
BUFFALO NY 14203

COMPACT RTTY

Flesher Corp offers a selection of compact, economical RTTY equipment and accessories unequalled in quality or function for the price. Flesher units

are designed with minimum space requirements in mind, too. Call or write today for our free 1980 catalog of affordable kits, wired units and accessories.



FLESHER CORP

P.O. Box 976 • Topeka, Kansas 66601 • 913 • 234 • 0198

SCANNERS:

KDK 2015R, KDK 2016A
MIDLAND 13-510, 13-513, CLEGG FM-28
YAESU FT227R, ICOM IC22S,
KENWOOD TR7400A, TR7600, & TR7625

- AED continues to expand its line of quality scanners. All of the above scanners are custom designed for their respective rigs.
- All scanners install completely inside the rig. No obtrusive external connections.
- All are easy to assemble and come complete with a detailed instruction manual.
- Scanned frequency displayed on digital readout (except IC22S).
- In the scanner OFF mode the rig operates normally. In the scanner ON mode the scanner locks on an occupied frequency, pauses for a preset time (about 5 secs.) and then resumes scanning.
- This gives you the ability to eavesdrop all over the band without lifting a finger. When you hear something interesting, you flip the switch to the LOCK mode and the rig is ready to transmit.

AED SCANNER SPECIFICATIONS

	KDK 2015R	KDK 2016A	KENWOOD TR7600 TR7625	KENWOOD TR7400A	YAESU FT227R	MIDLAND 13-510 13-513	CLEGG FM-28	ICOM IC22S
SCAN RATE	Adjustable 100kHz/sec-1MHz/sec			50kHz/sec	200kHz/sec	100kHz/sec	100kHz/sec	100kHz/sec
SWEEP WIDTH	144-148 or only the mHz segment you select on mHz switch	142-149.995	complete band or mHz you want	complete band or mHz you want	adjustable eg. 146-148 144-146 146-147	scans the mHz seg. selected by the mHz switch	same as Midland	145.35-147.99
SCAN CONTROLS	2 mini toggle switches mounted on rig—LOCK switch may be mounted on mic.		2 mini toggle switches mounted on rig.	2 mini toggle switches mounted on rig.	1 mini toggle switch mounted on mic or rig.	2 mini toggle switches mounted on rig.	same as Midland	1 mini toggle switch mounted on mic or rig.
PRICE FOR KIT	\$39.95							
PRICE PRE-ASSEMBLED	\$59.95							

DEALER INQUIRIES INVITED

✓A60

AED ELECTRONICS

750 LUCERNE RD., SUITE 120
MONTREAL, QUEBEC, CANADA H3R 2H6
TEL. 514-737-7293

Add \$1.50 for postage & handling

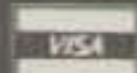

Sunspot Predictions for 1980

— whither propagation?

Editor's Note: The sunspot forecast presented in this article does not agree with the one issued by our own propagation expert, John H. Nelson. In the March, 1977, issue of *73 Magazine*, Nelson predicted that Cycle 21 was going to be a moderate to low cycle. Nelson further predicted in *The Propagation Wizard's Handbook* that both Cycle 21 and 22 would be moderate to low. In the *Handbook*, Nelson explains his forecasting methods and gives us the reasons for his predictions. While we continue to believe that Nelson's is the more accurate forecast, we thought you would be interested in this, another view of the subject.

The Propagation Wizard's Handbook is available from the 73 Radio Bookshop, Peterborough NH 03458. Please include \$6.95 plus \$1.00 postage and handling. You'll find John Nelson's monthly propagation forecast near the back of each issue of 73. ■

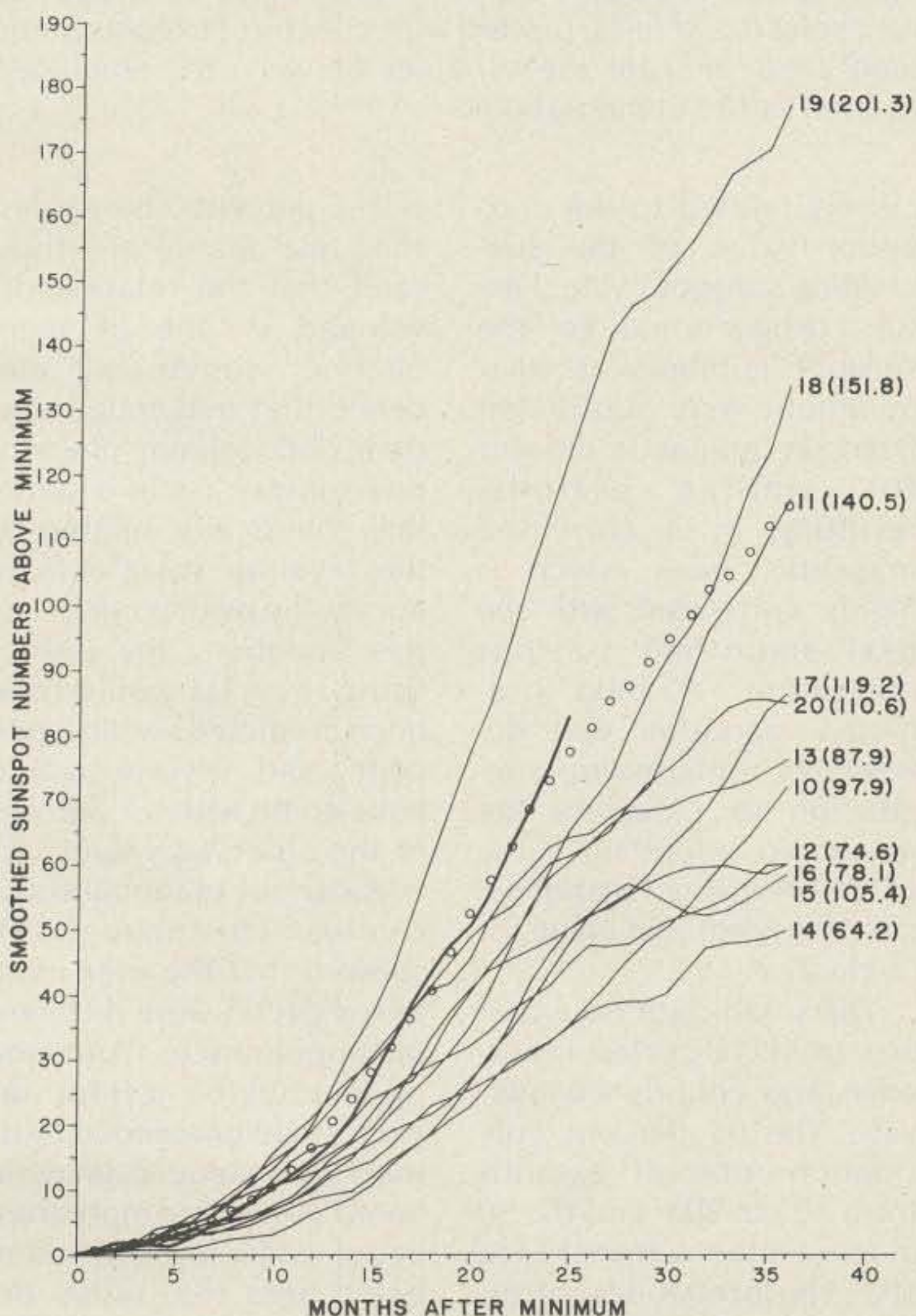

William E. Hardy WA3NKP
 Environmental Data & Information Service
 National Oceanic & Atmospheric Administration
 Rockville MD 20852

The frequency of the occurrence of sunspots varies in cycles averaging around 11 years in length. Twenty cycles have been observed since 1755. We are now approaching maximum activity in Cycle 21, the minimum activity having occurred in 1976. The highest number (201) occurred in Cycle 19 in March, 1958. Radio communications, especially in the 3- to 30-megahertz (high-frequency) band, are vitally affected by sunspot activity, long-distance propagation increasing dramatically as

the cycle approaches its maximum of activity.

Because of this significance, a number of investigators have made their predictions of sunspot maxima for Cycle 21 and the times of their occurrences. Predicted maxima range from as low as 60 to highs of up to 200, to occur in the years from 1979 to 1984. Published during the past two sunspot cycles, investigators used some type of time series or pattern analysis of the sunspot numbers alone to arrive at their predictions. Others

Fig. 1. Sunspot maxima for previous cycles.

have included physical indications such as the tidal effects of the accurately-determined planetary alignments.^{1,2,3,}

Measurements of the horizontal component of the Earth's magnetic field to predict subsequent maximum sunspot activity was such a departure.^{4,5} A strong negative correlation between the number of "abnormal quiet days" of this horizontal component and the sunspot maximum reached during the next half-cycle of solar activity was used. A simpler relationship was employed whereby there was found a high correlation between the value of the geomagnetic sum of the Kps index (average of geomagnetic activity at a number of high latitude stations) during the years immediately preceding solar minimum and the solar maximum reached during the next cycle.⁶

A major limiting factor in the success or failure of predictions is the size of a reliable data base containing, at best, 11 sunspot cycles. Data prior to 1848 is considered to be unreliable. The first seven cycles (starting from about 1755) have been noted to differ statistically from the subsequent cycles, so that some investigators used only the later cycles in constructing an average solar cycle.⁷

Scientist H. H. Sargent III of the U.S. Department of Commerce, National Oceanic and Atmospheric Administration (NOAA), has recently summarized a number of predictions of the time intensity of Solar Cycle 21.* Working in NOAA's Space Environment Laboratory in Boulder, Colorado, Sargent has an-

*Sargent, H. H. III, 1978, "A Prediction for the Next Sunspot Cycle," *Conference Record*, 28th IEEE Vehicular Technology Conference, March 22-24, Denver, Colorado, pp. 490-496.

alyzed the method of A. I. Ohl in predicting the maximum level of sunspot activity (154 in 1980).^{6,8,9} This prediction is unique in that its value for Cycle 21 is considerably higher than most of those made in recent years by a number of investigators.

The method used to make the prediction was founded on a data base of only 11 sunspot cycles. This was done because geomagnetic data not available prior to 1868 was used. It was considered that the cycle of geomagnetic activity which accompanies each sunspot cycle may be separated into two components. One is a sporadic component associated with large solar flares, and one a recurrent component thought to be caused by high-speed solar wind streams. It was found that the size of the recurrent component is

closely related to the maximum value of the succeeding sunspot cycle. Factors proportional to the sunspot numbers at solar minimum were subtracted from the magnetic indexes for similar periods, resulting in a corrected magnetic index which is highly correlated with the next smoothed sunspot maximum. A best predictive equation was determined using multiple regression to calculate the maximum smoothed value of the following sunspot cycle. This predicted value for Cycle 21 is 154.

The small data base that was used (11 cycles) resulted in large confidence intervals. The 95 percent confidence interval extends from 103 to 203, and the 90 percent interval from 113 to 193. The probability of exceeding a smoothed sunspot maximum value of 120

is 92.6 percent. There is less than one chance in a thousand that the relation developed is one of mere chance, convincing evidence that magnetic activity in the declining phase of one sunspot cycle is somehow physically related to the level of solar activity during the next cycle. Using this equation, the past 3 sunspot cycles would have been predicted within 5 percent, and several would have come within 1 percent of the observed values.

A careful examination of Cycles 10 through 20 showed that the even-numbered cycles were different in appearance from the odd-numbered cycles; as each cycle proceeded to its maximum value, even-numbered curves are more truncated while the odd-numbered ones rose rather deliberately to maximum. This suggested two dif-

ILLUSTRATION OF MODIFIED OHL METHOD OF PREDICTION

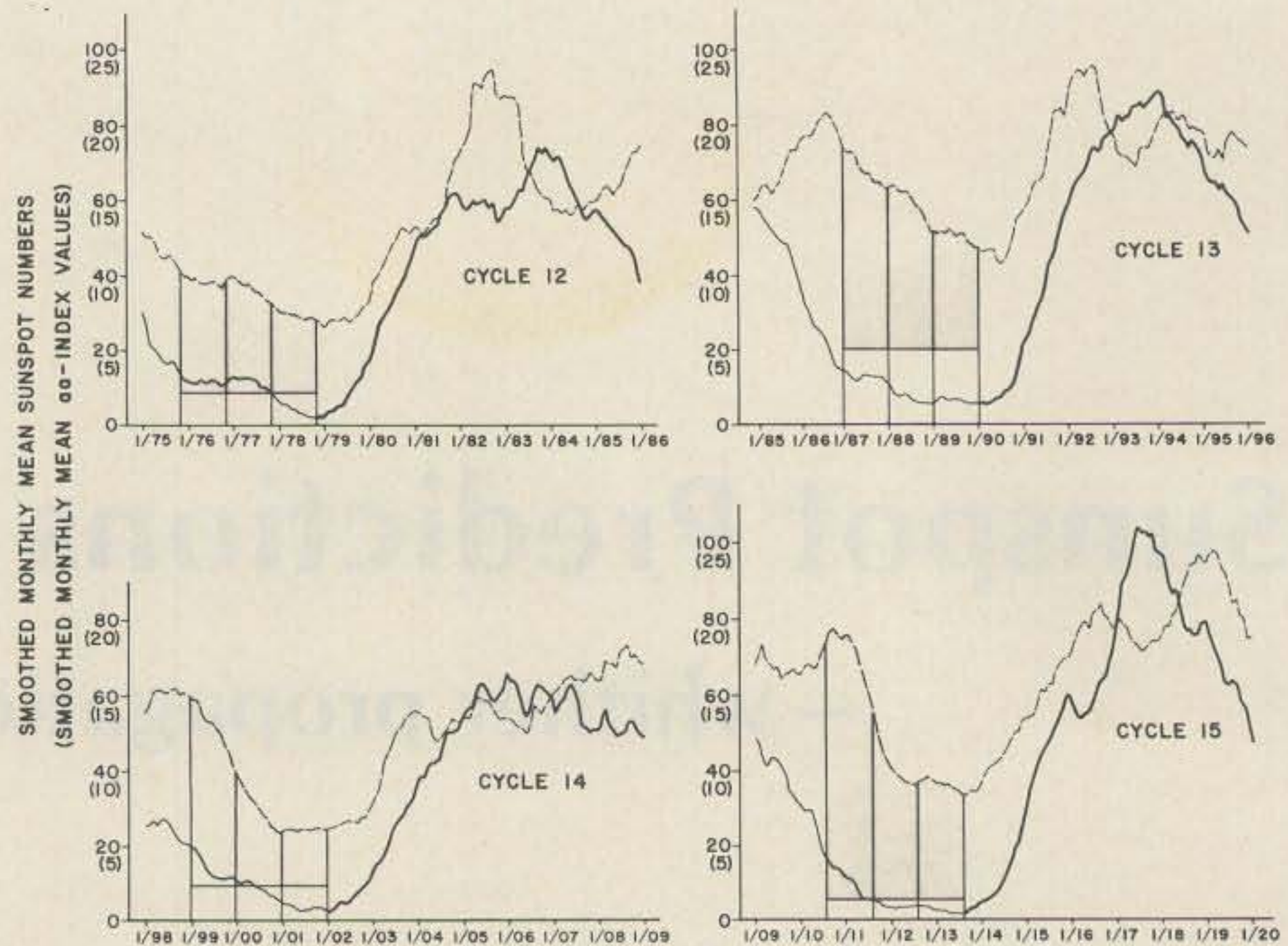

Fig. 2. Most predictions to date have indicated a low sunspot value (120 or less) for the present cycle, Cycle 21. One of these, however, predicts a smoothed sunspot maximum value of 154 to occur in early 1980 which is considerably higher, and earlier, than the others. A high correlation between the value of geomagnetic activity during the years immediately preceding solar minimum and solar maximum reached during the next half-cycle has been found. If accurate, Cycle 21 will be equivalent to, or greater than, the second largest observed in the past century. This would have a profound effect on radio communications, especially in the high-frequency range (3-30 megahertz). The illustration shows pairs of even- and odd-numbered sunspot cycles (solid lines) plotted with concurrent geomagnetic cycles (dashed lines). The shaded areas indicate the variables between the smoothed geomagnetic and sunspot cycles used in the computations.

ferent families of cycles. An average odd-numbered cycle was constructed from the five odd-numbered cycles (Cycles 11-19) and re-scaled between the last observed minimum (12.2) and the predicted maximum value for Cycle 21 (153.6). This made possible the prediction of the monthly values for Cycle 21; the predicted maximum value falls in early 1980.

Also, an analysis showed that the three largest cycles had the steepest emergencies while the smaller cycles proceeded less steeply from the minima. The predicted emergence slope for Cycle 21 correlated well with those of the largest cycles and follows closely the observed values through July of 1978. Each cycle settles down to a smooth and steady upward pace within about 18 months after solar minimum, and the upward slope of Cycle 21 had become well established in the first few months of 1978. This feature should make it possible to confidently predict the maximum value of Cycle 21.

The effects of high sunspot activity on radio communications, especially in the high-frequency part of the spectrum (3-30 megahertz) and the lower end of the very high frequency band (30-300 megahertz) would have both advantages and disadvantages. The more than 350,000 licensees of the Amateur Radio Service will find it possible to conduct extremely consistent, long-distance communications frequently and with relatively low power.

On the other hand, radio operators confined by law to specified frequencies may find them more heavily congested than at the present time, making them much less efficient as methods of intelligible communication. This is

generally the case with increased solar activity.

There are ways such high activity can temporarily worsen propagation conditions, however. Solar-flare events and related geophysical aspects such as sudden ionospheric disturbances and geomagnetic and ionospheric storms can disrupt radio communications for periods of a few minutes to several days. If Cycle 21 is as large as predicted in this analysis, relatively more of such major disruptions can be expected.

Those charged with planning relative to the vital radio communications the world over (especially in the high-frequency range) may find of interest this prediction of sunspot activity in the present cycle, as well as its rationale. ■

1. Jose, P. D., 1965, "Sun's Motion and Sunspots," *Astronomical Journal*, Vol. 70, No. 3, pp. 193-200.

2. Smith, F. M., 1976, "Some New Insight Into the Mechanism of the Sunspot Cycle," *Radio Communication*, July, 1976, pp. 494-500.

3. Wood, K. D., 1972, "Sunspots and Planets," *Nature*, Vol. 240, pp. 91-93.

4. Brown, G. M., 1974, "A New Solar-Terrestrial Relationship," *Nature*, Vol. 215, pp. 592-594.

5. Brown, G. M., 1976, "What Determines Sunspot Maxima?," *Monthly Notices of the Royal Astronomical Society*, Vol. 174, pp. 185-189.

6. Ohl, A. I., 1976, "A Preliminary Forecast of Some Parameters of Cycle No. 21 of the Solar Activity," *Solnechnaya Dannyye*, No. 9, pp. 73-75.

7. McNish, A. G., and Lincoln, J. V., 1949, "Prediction of Sunspot Numbers," *Transactions of the American Geophysical Union*, Vol. 30, No. 5, pp. 673-685.

8. Ohl, A. I., 1968, "Forecast of the Maximum Wolf Number for the Current Eleven-Year Cycle," *Problems of the Arctic and the Antarctic*, No. 28, pp. 137-139.

9. Ohl, A. I., 1971, "Physics of the Eleven-Year Variation of Magnetic Disturbances," *Geomagnetism and Aeronomy*, Vol. 11, pp. 549-551.



GREGORY ELECTRONICS
The FM Used
Equipment People.

OUR 20TH YEAR

START THE NEW YEAR
WITH A COPY OF
GREGORY ELECTRONICS

NEW 1980
CATALOG



GREGORY ELECTRONICS CORP.

251 Rt. 46, Saddle Brook, N.J. 07662

Phone: (201) 489-9000

G36

BELDEN

Part Number	MHz	db/100 ft.	db/100 m
9888 42c/ft	50	1.2	3.9
	100	1.8	5.9
	200	2.6	8.5
	300	3.3	10.8
	400	3.8	12.5
8214 26c/ft.	50	1.2	3.9
	100	1.8	5.9
	200	2.6	8.5
	400	3.8	12.5
8237 23c/ft	100	2.0	6.6
	200	3.0	9.8
	400	4.7	15.4
	900	7.8	25.6
8267 27c/ft	100	2.0	6.6
	200	3.0	9.8
	400	4.7	15.4
	900	7.8	25.6

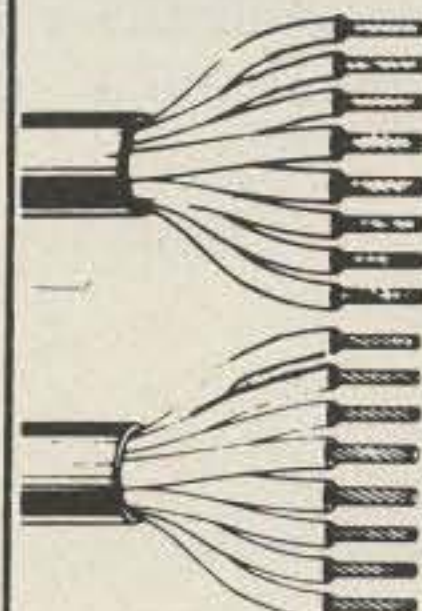

8448
17c/ft

No. of Cond. — 8
AWG (in mm) — 6-22, (7x30), [1.76];
2-18, (16x30), [1.19]

9405
28c/ft

No. of Cond. — 8
AWG (in mm) — 2-16, (26x30), [1.52];
6-18, (16x30), [1.17]

MADISON ELECTRONICS SUPPLY, INC.

1508 MCKINNEY • HOUSTON, TEXAS 77002

713/658-0268

MASTERCHARGE • VISA

M35

An End to Dials and Meters?

—nope . . . but discrete LEDs make an interesting substitute

73 Magazine Staff

One of the items that usually proves to be a bit of a chore in constructing any piece of equipment or accessory item is a dial (and dial scale). Multi-turn dials with an indicating scale can be expensive, and constructing various other forms of dials and scales can require considerable mechanical ability.

There is the alternative, today, of having a digital readout, but digital read-

outs can consume a significant amount of power for portable equipment. Also, in some cases the use of a digital readout is a far more elaborate option than is needed. A case in point might be a roller inductor in an antenna tuner. Usually, one just wants to know approximately where the roller inductor is set, since final tuning would be done using an swr meter or a wattmeter.

This article explores some simple alternatives to ordinary mechanical or

digital-type readouts, using LEDs. Several LED circuits are described, to suit almost any requirement from indicating the approximate position of a roller inductor in an antenna tuner (just using several LEDs) to having a long string of LEDs arranged to form a frequen-

cy scale in which the LEDs light in turn as a receiver or a vfo is tuned. All of the circuits require, however, that a voltage be supplied to the circuit which is proportional to the shaft rotation of the inductor or capacitor being tuned (except for varactor diode-tuned vfos

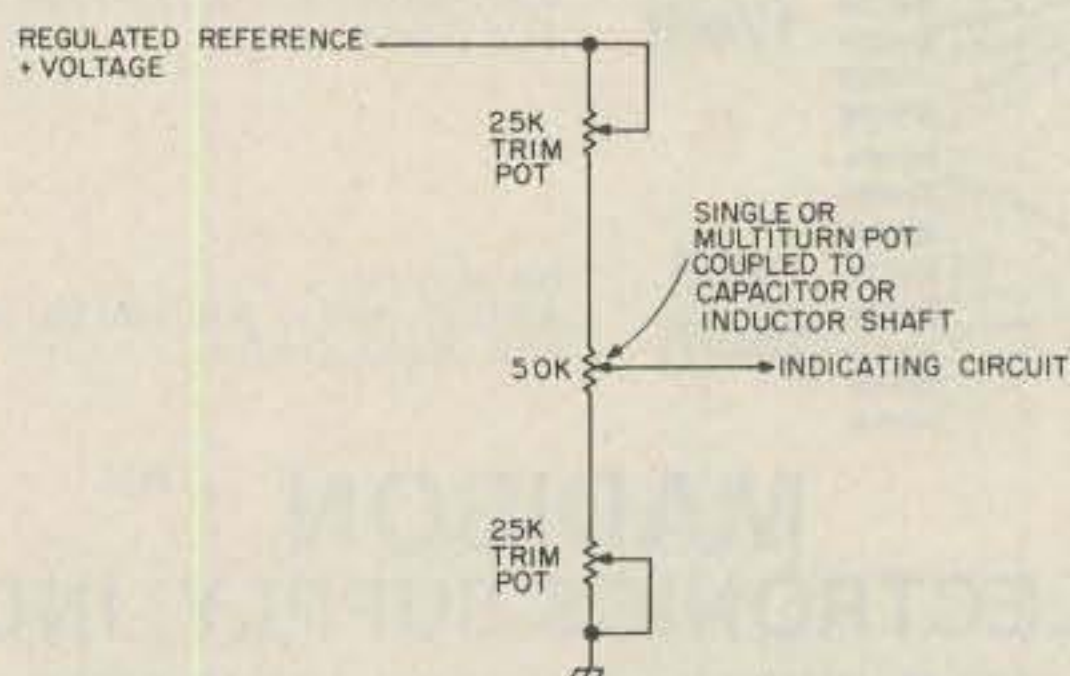

Fig. 1. Typical circuit for a potentiometer coupled to the shaft of a variable capacitor or inductor.

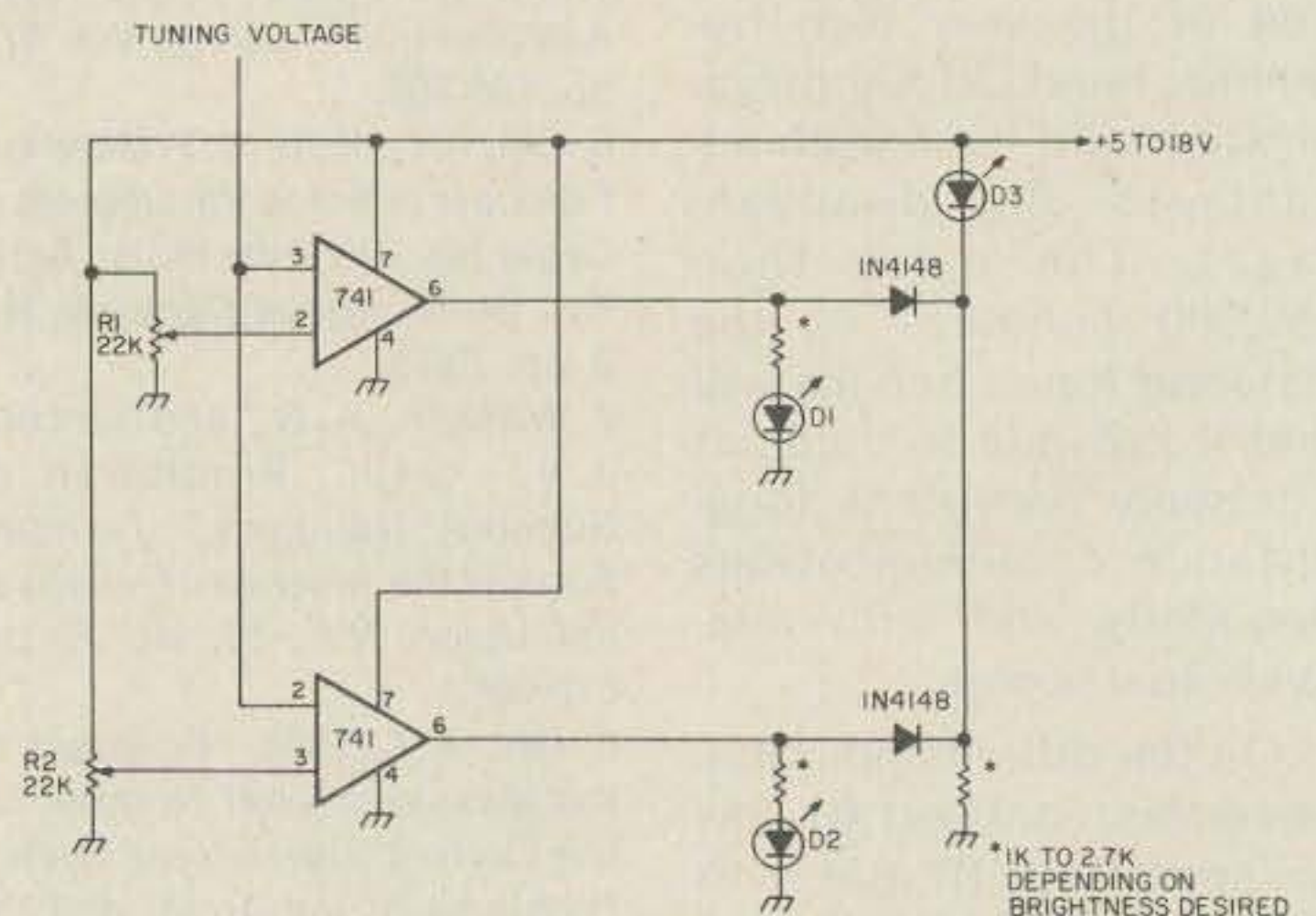

Fig. 2. LEDs D1, D2, and D3 can be set to light in turn according to the value of an applied tuning voltage. R1 and R2 are trim pots and set the voltages at which the LEDs light. The circuit can be easily constructed, especially if a dual 741 is used.

where the dc tuning voltage already is available).

How to do all this will vary from application to application, of course. Usually, one can find some way to couple a single- or multi-turn potentiometer to a tuning shaft. This is the only area in which some mechanical work is required to implement an LED scale. As shown in Fig. 1, it often is handy to add trim-type potentiometers in the circuit so that the voltage range covered by the potentiometer coupled to the tuning shaft can have both its upper and lower range adjusted.

The circuit in Fig. 2 provides only three LED indicators, but it uses readily-available 741 ICs and can still provide some useful tuning indications. For example, it can be used to indicate approximately which third of a roller inductor is active in a small antenna tuner. Also, it can be used as a warning indicator, with a vfo, that one is near the edge of a band, or it can be used to "bracket in" a small portion of a band so that it is readily apparent when one has tuned to the lower, middle, or upper part of the frequency range chosen.

The two 741s operate as comparators, and the potentiometers, R1 and R2, set the points at which either D1 or D2 will light. When the input voltage to the circuit exceeds the voltage set on pin 2 of IC1 to ground, D1 will light. When the input voltage is smaller than the voltage set on pin 3 of IC2, D2 will light. When the input voltage is in between (smaller than the D1 ignition voltage but larger than the D2 ignition voltage), D3 will light. There is nothing at all critical about using the circuit, but to avoid confusion when initially adjusting the potentiometers, be sure that the D1 ignition voltage is set

higher in value than the D2 ignition voltage. Since the LEDs involved are switched separately, they need not have exactly the same characteristics. One can use different colored LEDs if desired, therefore, in each position.

The circuit in Fig. 3 uses a new, inexpensive (about \$1.00) IC from Texas Instruments. Basically, it does the same thing as the circuit in Fig. 2 but contains everything in one IC, drives up to 5 LEDs, and contains a few extra features. At about 0.2 volts input on pin 8, pin 2 goes low and the first LED will light. As the input voltage increases in 0.2-volt steps, pins 3, 4, 5, and 6 will go low in turn and light the LED connected to them. At 1.0 volt input, all the LEDs will be lighted. Note that this is a slightly different action than in the circuit in Fig. 2 where only one LED at a time is active. Also, using this circuit, there is no way to change the 0.2-volt steps needed to light successive LEDs. Further features of the IC are that when the input voltage goes below approximately 0.2 volts, the first LED will flash on and off periodically. Also, the IC contains a built-in voltage regulator so that the supply voltage need not be regulated. Although the circuit shown uses LEDs, the output terminals (pins 2-6) can actually switch currents up to 80 mA at a maximum voltage of 18 volts. One could, therefore, use small lamps for the indicators, or even set up a solid-state buzzer on one of the outputs to indicate aurally that some high or low limit had been reached.

The circuit in Fig. 4 moves into the "big time" with LED displays, in that a string of 10 LEDs is involved. This circuit uses an IC that was specifically designed to drive a string of LEDs in response to a vari-

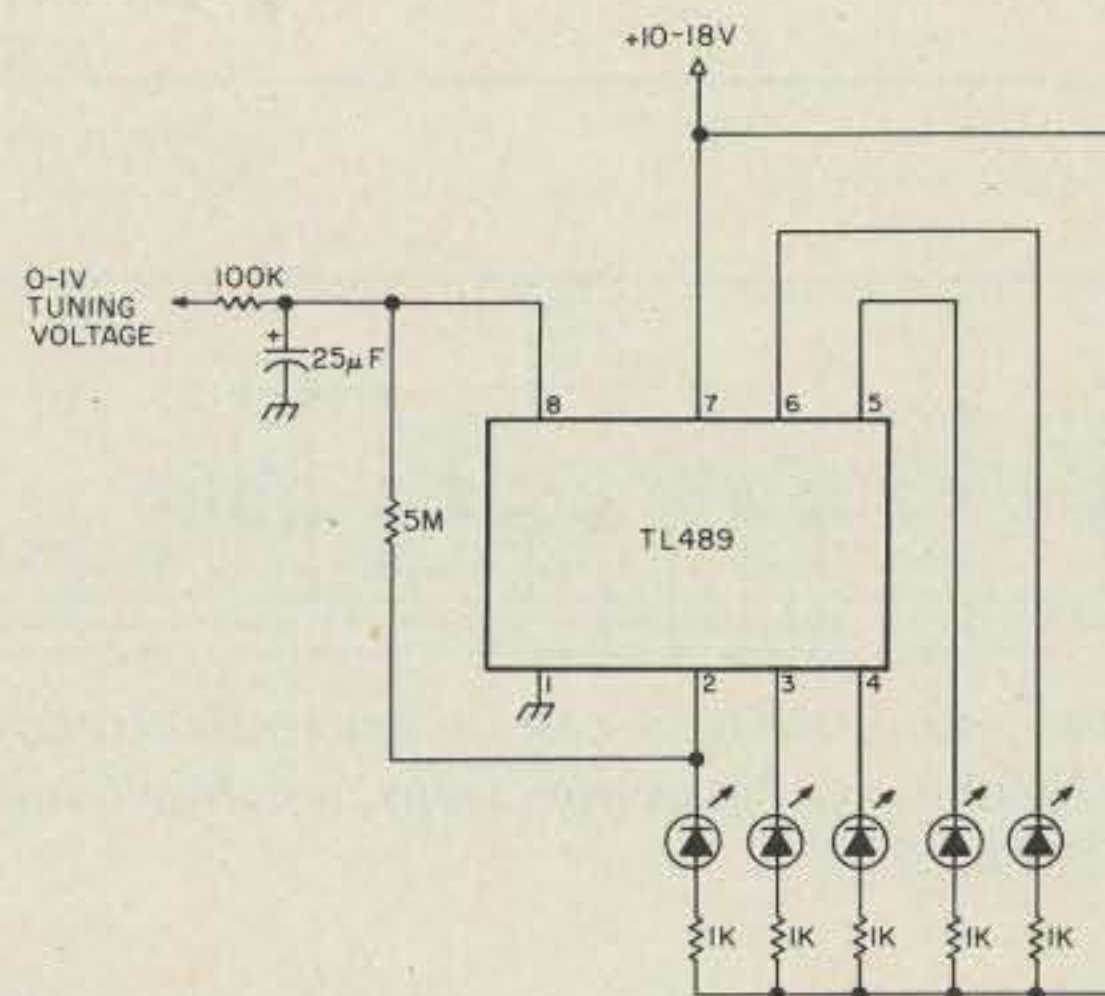

Fig. 3. In this circuit, as the input voltage varies from 0 to 1 volt, one LED will light (and stay lighted) for each 0.2-volt step in the input voltage.

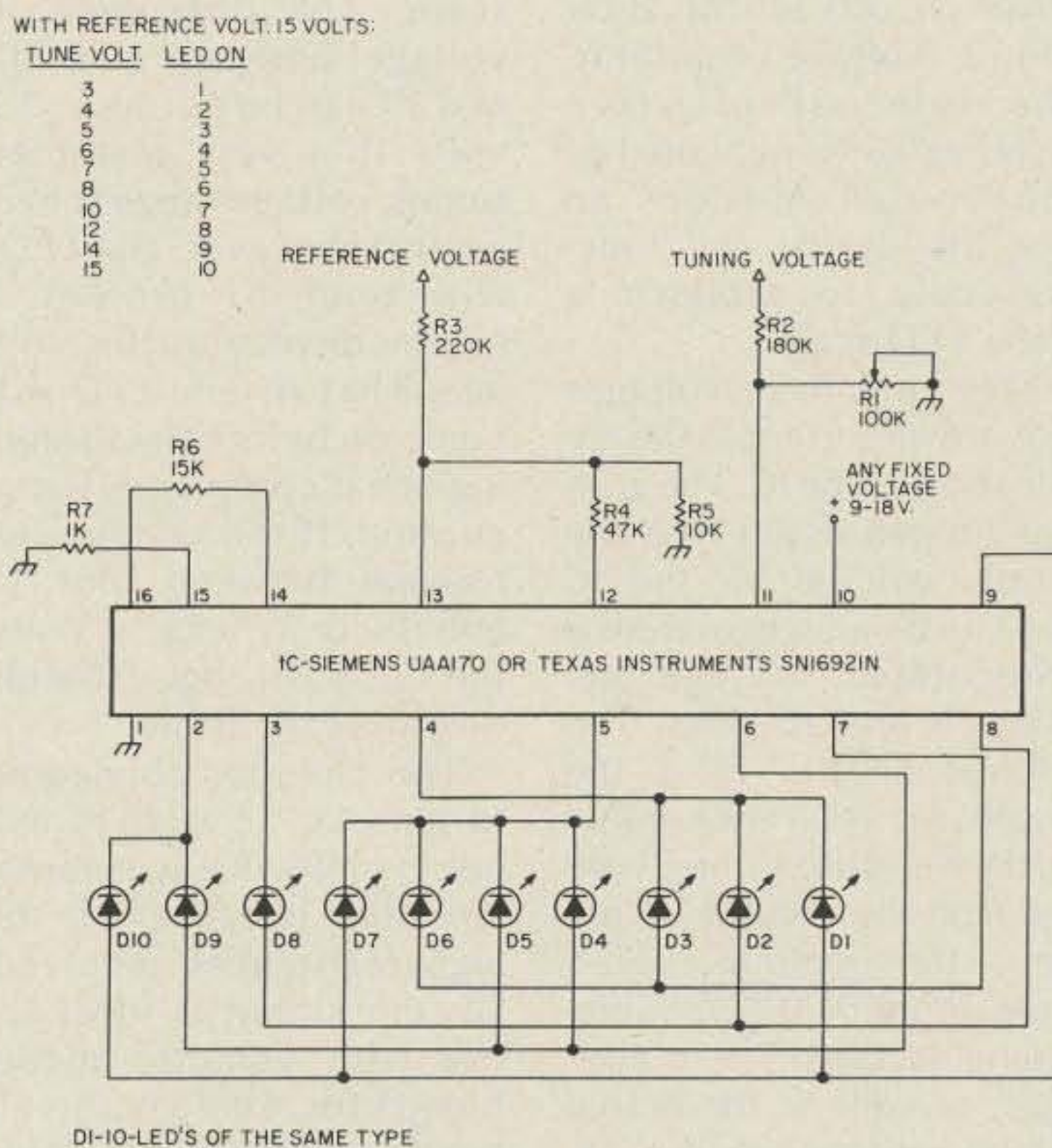

Fig. 4. The circuit of a 10-LED indicator. The size of the IC has been exaggerated for clarity; it is a normal 16-pin type and provides for very compact circuit construction.

able input voltage. The LED action is like the circuit of Fig. 2 in that only one LED is active at a time, depending on the voltage level being sensed. The IC itself will take only a few milliamperes of current, so the main current drain using the circuit will be from the LED that is active. The circuit is suitable, therefore, for many types of portable equipment applications.

This circuit is suited for construction of an electronic LED scale, since the

10 LEDs provide sufficient "spread." For instance, if a receiver had a tuning knob which covered 25-kHz/revolution, a string of 10 LEDs could be used to provide markers every 25 kHz across a 250-kHz portion of a band. If a linear vfo is used, therefore, the combination of having LEDs and the dial skirt divisions marked will provide readout to 1 kHz over a 250-kHz range.

The IC, although it is a small 16-pin type, packs

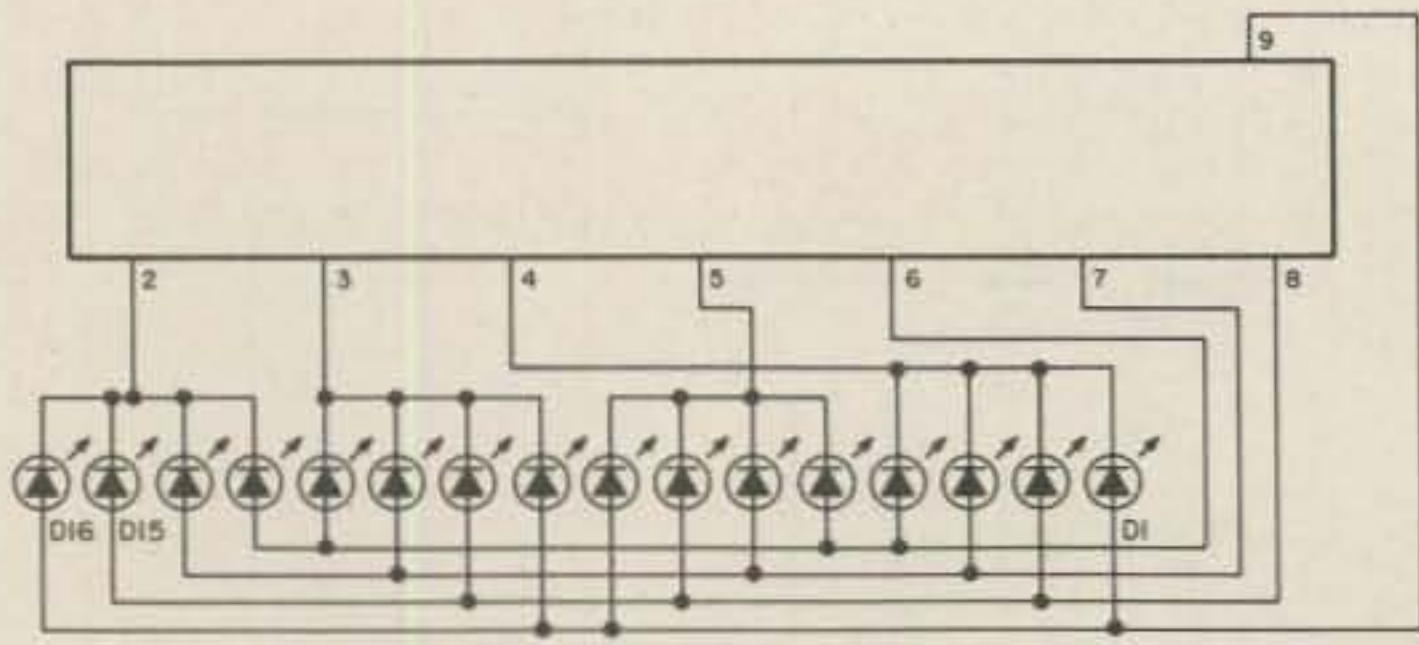

Fig. 5. The circuit of Fig. 4 can be expanded to control 16 LEDs as shown here. Pin connections not shown remain the same as in Fig. 4.

quite a bit inside. There are sixteen differential amplifiers and a resistive voltage-divider network, plus the driver circuits for the LEDs and a voltage regulator. The internal resistive voltage-divider network has equal value resistors, so that the device will function only to produce a linear LED scale.

There are three voltages that are important in the application of the IC. The voltage applied to pin 10 is the supply voltage for the IC and can be any regulated or unregulated voltage between 9 and 18 volts. The voltage on pin 13 is the maximum reference value of the variable-tuning voltage, and the voltage on pin 12 is the minimum reference value of the variable-tuning voltage. These voltages, as well as the actual tuning voltage on pin 11, cannot exceed 6 volts.

In many circuits, such as where varactor diodes are voltage-tuned in an oscillator, however, the maximum value of the tuning voltage will exceed 6 volts. Therefore, voltage dividers have to be employed, as in Fig. 4, where the tuning voltage varies between 4 and 15 volts. R1 and R2 form a voltage divider to limit the voltage on pin 11 to 6 volts maximum. R3, in conjunction with R4 and R5, set the high value of the tuning voltage on pin 13 and the low value on pin 12. The table in Fig. 4 shows which diodes will light for different tuning voltages.

Making R1 variable provides a slight adjustment similar to the mechanical analogy of centering the scale. The difference in voltage between pins 12 and 13 can be as low as 1.2 volts if a very restricted tuning voltage range is necessary. However, the LEDs will tend to present a mushy display at this voltage. That is, one LED will come on before the foregoing one is completely extinguished. If the voltage difference between pins 12 and 13 is at least 4 volts, the LEDs will light sharply one after the other.

The circuitry connected to pins 11, 12, and 13 will not load down any external circuitry because of the high resistances involved. So, the circuit is ideal for use with varactor diode-tuned vfos. There is a 5-volt regulated reference voltage available from pin 14 to ground. In some cases where only low current drain is involved (3 mA maximum), this voltage can be used as the reference voltage on pin 13 and the source of the variable-tuning voltage. Only one external voltage is needed then, to pin 10. R6 controls the brightness of the LED display and can be made variable, if desired, to keep the current drain at a minimum for portable applications or to vary the display brightness according to external lighting conditions. The LEDs used should all be of the same type for the circuit to function smoothly.

Different colored LEDs can be used if their voltage/current characteristics are similar.

The circuit in Fig. 4 actually does not utilize the full capabilities of the IC, but is probably the most useful because of its 10-position scale. Actually, the IC will drive up to 16 LEDs, as shown in Fig. 5. All of the foregoing discussion about setting the voltage levels on various pins of the IC still applies. Again, however, it is worthwhile to emphasize that the LEDs must have the same electrical characteristics.

One may wonder if the circuits in Figs. 4 or 5 can be further expanded to create even longer LED scales. In most cases, this can be done easily if the tuning voltage range is not too small. If it is on the order of 1 to 14 volts, for example, one IC can be set up to respond to 1 to 7 volts and the other from 7 to 14 volts, with their inputs (pin 11) paralleled. The setting up of each IC to respond to a given voltage range is done, as explained previously, by putting the desired low- and high-reference voltages on pins 12 and 13 of each IC. Note that the high voltage of the first IC, which is a nominal 7 volts, should be a bit higher than the nominal low 7 volts of the second IC. The reason for this is to provide a smooth crossover between the LED displays associated with each IC. For instance, if two circuits of the type shown in Fig. 4 were used, when 7 volts or slightly over was reached, the last diode in the first IC (D10) would light simultaneously with the first diode (D1) associated with the second IC. These diodes would not be used in the scale display but must be left in the circuit.

By careful adjustment of the 7-volt overlap point, there will be a smooth step

between diode D9 from the first IC and D2 from the second IC. This overlap adjustment can be achieved by making R7 in the circuit in Fig. 4 a trim pot instead of a fixed value resistor. If one used two circuits of the type shown in Fig. 4, therefore, 18 diodes actually will be available to form a scale; there will be 30 diodes available in the case of the circuit in Fig. 5.

Although the foregoing circuits were presented for use as LED tuning or logging scales, they can be applied to many other uses around the shack. The most obvious might be as battery voltage monitors. The circuits in Figs. 2 and 3 are particularly suited for this purpose. Also, the circuits can be used to replace or to augment analog meter readouts. The circuit in Fig. 4, with or without the additional LEDs shown in Fig. 5, is particularly well suited for this purpose. It has a high impedance input, and the response time is easily fast enough to follow speech peaks once the audio sample has been converted to dc by a suitable rectifier.

The Texas Instrument ICs are available from the usual supply sources, while local availability of the Siemens IC can be determined by writing to Siemens Components Division, 186 Wood Ave., S. Iselin NJ 08830. Siemens actually makes two ICs—the UAA170 and the UAA180. They are similar, except that the UAA180 provides a display such that the LEDs remain lighted once their voltage detection level is reached. The amount of current required with, say, 10 LEDs lighted would make this type of display unsuitable for most portable applications. However, where current availability is not a problem, the display is a very effective one in place of an analog meter display. ■

UNSURPASSED RTTY

No other RTTY terminal made gives you ALL the features of our new DS3100 ASR:



- TX/RX operation with 3 codes: Baudot RTTY, Morse Code, ASCII RTTY
- Storage buffers for 150 lines of RX storage and 50 lines of TX storage
- The HAL "original" split screen shows both RX and TX buffers or whole screen for RX
- Ten programmable "Here Is" messages can be chained from one to next
- The EAROM allows power-off storage of 2 "Here Is" messages and terminal operating conditions
- Programmable WRU answer-back and selective-call features
- Separate CW identification key for RTTY operations
- Automatic TX/RX control with KOS plus 4 keyboard controlled accessory switches
- Internal real time clock keeps 24 hour time plus date
- Newly developed CW receive circuitry and programs give superior CW reception
- New green, P31 phosphor display screen gives clear, eye-easing viewing
- On-screen status indicators give continuous display of terminal operating conditions
- Word-Wrap-Around prevents splitting of words at end of display line
- Continuous, line, and word modes offer flexibility in editing transmit text
- Attractive streamlined metal cabinet gives effective RFI shielding from transmitters

Here Are More DS3100 ASR Specifications that Give You State-of-the-Art RTTY Operation:

QBF and RY test messages ■ Loop and RS 232 RTTY I/O ■ Plus or minus CW key output ■ 25 pin EIA modem connector ■ Half or full duplex ■ Upper-lower case ASCII ■ All ASCII control codes ■ Optional line printer for all codes ■ Selectable ASCII parity ■ 110 to 9600 baud ASCII ■ 45 to 100 baud Baudot ■ 1 to 175 WPM Morse receive and transmit ■ UnShift on space for Baudot ■ SYNC idle for RTTY and Morse ■ Break key for RTTY ■ Tune key for Morse ■ Automatic CR-LF ■ 120/240 v, 50/60 Hz power ■ Custom labeled key tops show control operation ■ Copy receive text into transmit buffer ■ TX flags allow segmenting of TX buffer ■ One year warranty ■ Price \$1995.00



HAL COMMUNICATIONS CORP.
Box 365
Urbana, Illinois 61801
217-367-7373

For our European customers, contact: Richter & Co. D3000
Hannover 1 • I.E.C. Interelco, 6816 Bissone/Lugano • Radio
Shack Ltd., London NW6 3AY • Erik Torpdahl Telecom, DK 3660
Stenlose Denmark

**HAL Communications and
amateur radio serving
the 1980 Winter Olympics
through W.O.R.A.N.
(Winter Olympics Radio
Amateur Network)**

The Paper, the Station, and the Man

— a brief history of the New York Times radio stations

The year was 1920, and the prestigious *New York Times* was in trouble. Communications from England and especially from occupied Germany were in bad shape after World War I. The Navy, still handling messages, had only one land line to NBD, Bar Harbor, Maine. News dispatches from Berlin that were being transmitted by the long-wave station, POZ, Nauen, Germany, were being received at the Bar Harbor installation, but would arrive at the *Times* newsroom 24 to 48

hours later. As everyone knows, nothing is deader than day-old press.

The *Times* had always been interested in wireless communication. Even back in December of 1901, when Marconi had been able to transmit the letter "S" to Newfoundland from the Poldhu station in southern England, the *Times* had not joined the rest of the world in doubting that wireless messages could ever be sent across the Atlantic. Instead, the paper had called the Marconi transmission a

triumph and had written columns about the achievement.

Also, the *New York Times* had been the first to receive a message sent to the west from the newly-established wireless service between Clifden, Ireland, and Glace Bay, Nova Scotia. From that time, January, 1912, until the outbreak of World War I, nearly all *Times* dispatches from London and Paris had come by wireless to the Glace Bay station and then

over special land lines leased by the paper.

When trouble came after the war in the form of unreliable communications, it was decided to establish a long-wave receiving station in the tower of the *Times* building at Times Square; this did not bring the success hoped for in receiving dispatches from POZ, Nauen, Germany, however. So, who better could they turn to for improving this situation



Times receiving sets, 1925.



Times receiving sets, 1926. Note long-wave receiver and two-stage amplifier in background.

than Reginald J. Iverson, a former crack operator at transatlantic Navy receiving stations in Belmar, N.J., Chatham, Mass., and NBD, Bar Harbor, Maine?

Once employed at the *Times*, Iverson began assembling improved equipment for the new receiving station. An antenna was run from the top of the flagpole on the *Times*

building down to the corner of the Flatiron Building at 43rd St., then along the third-floor offset and back up into the radio room. Another antenna went from the top of the tower down to the other side of the building.

Early equipment consisted of a Kennedy long-wave receiver with a two-stage amplifier and Baldwin

phones, later to be supplemented by receivers designed and built by Iverson.

All of this finally brought better reception from Europe so that dis-

BYRD ANTARCTIC EXPEDITION

WINTER QUARTERS: "LITTLE AMERICA," BAY OF WHALES, ANTARCTICA.

<p>Lat. 78°25' S. Long. 160°22' W. The Southernmost Radio Station in the world. In operation February 18, 1929, to February 19, 1930, 288 stat. miles from the South Pole.</p>	<h1 style="font-size: 2em; margin: 0;">WFA</h1> <p style="font-size: 1.2em; margin: 0;">FEB 18 1930</p>	<p>Transmitter: Two 204A tubes. TPTG circuit—500 cycle supply self-rectified. Receiver: G.E. type AR 1406-B; 1 screen grid, det., 2 audio.</p>
--	---	--

Dear *Mr. Iverson* —

Many thanks for all your fine work for us. Best 73 to you all

Sincerely,
Malcolm P. Hanson
 MALCOLM P. HANSON (MP),
 HOWARD F. MASON (MN),
 CARL O. PETERSEN (PETE).

The New York Times
RADIO STATION
 TIMES SQUARE, NEW YORK

U2UO

TRANSMITTER—500 WATTS, TUNED PLATE, TUNED GRID, SELF RECTIFIED, PLATE SUPPLY 500 CYCLES. TRANSMITTER LOCATED ON 17TH FLOOR TIMES ANNEX REMOTELY CONTROLLED FROM 3RD FLOOR RADIO ROOM.

WFA and U2UO QSL cards.

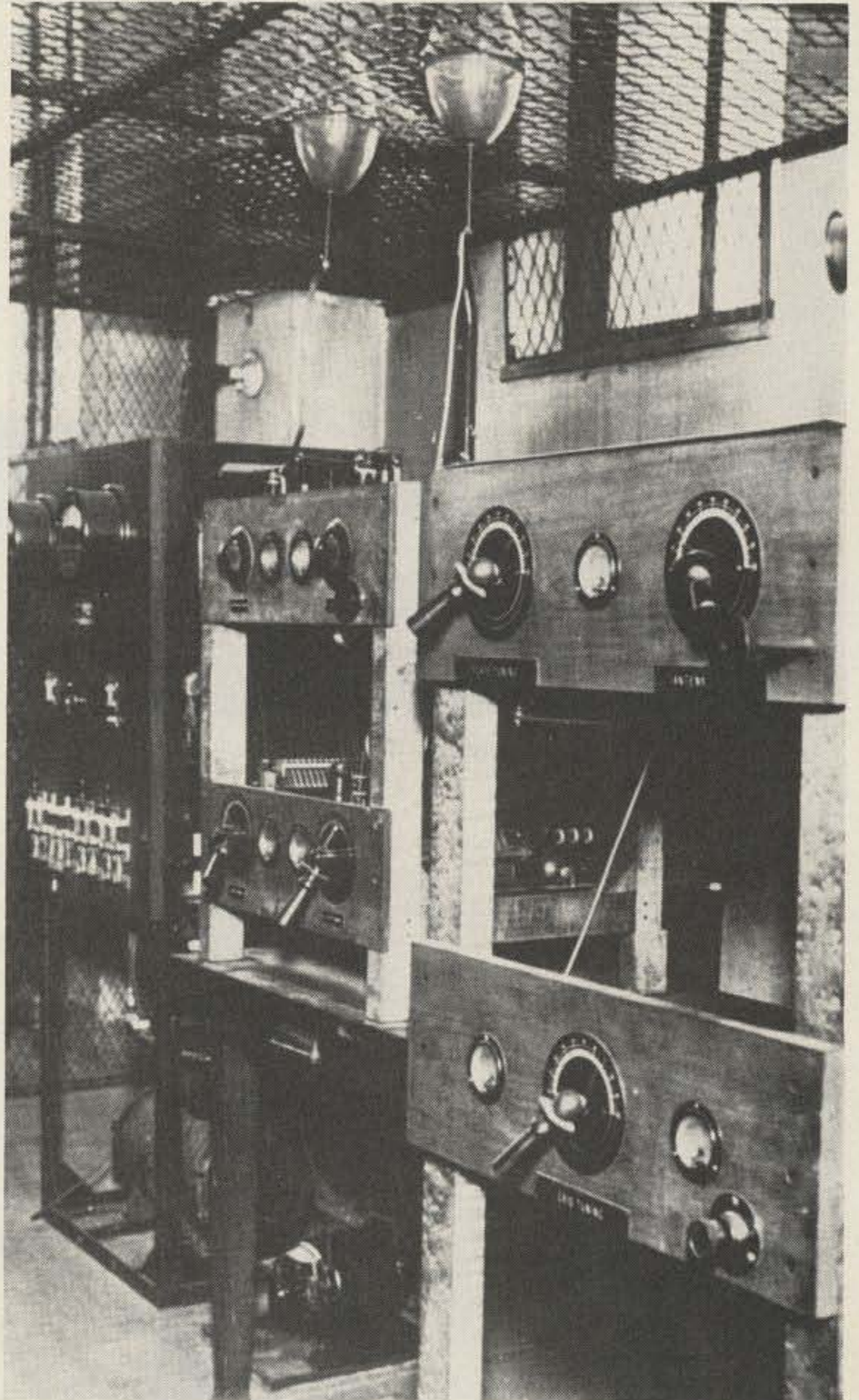

Amateur transmitter using two 204 tubes with motor-generator under table. Note: This same transmitter was used in 1928 with slight modifications at WHD. Located in Times Tower, Times Square, N.Y.

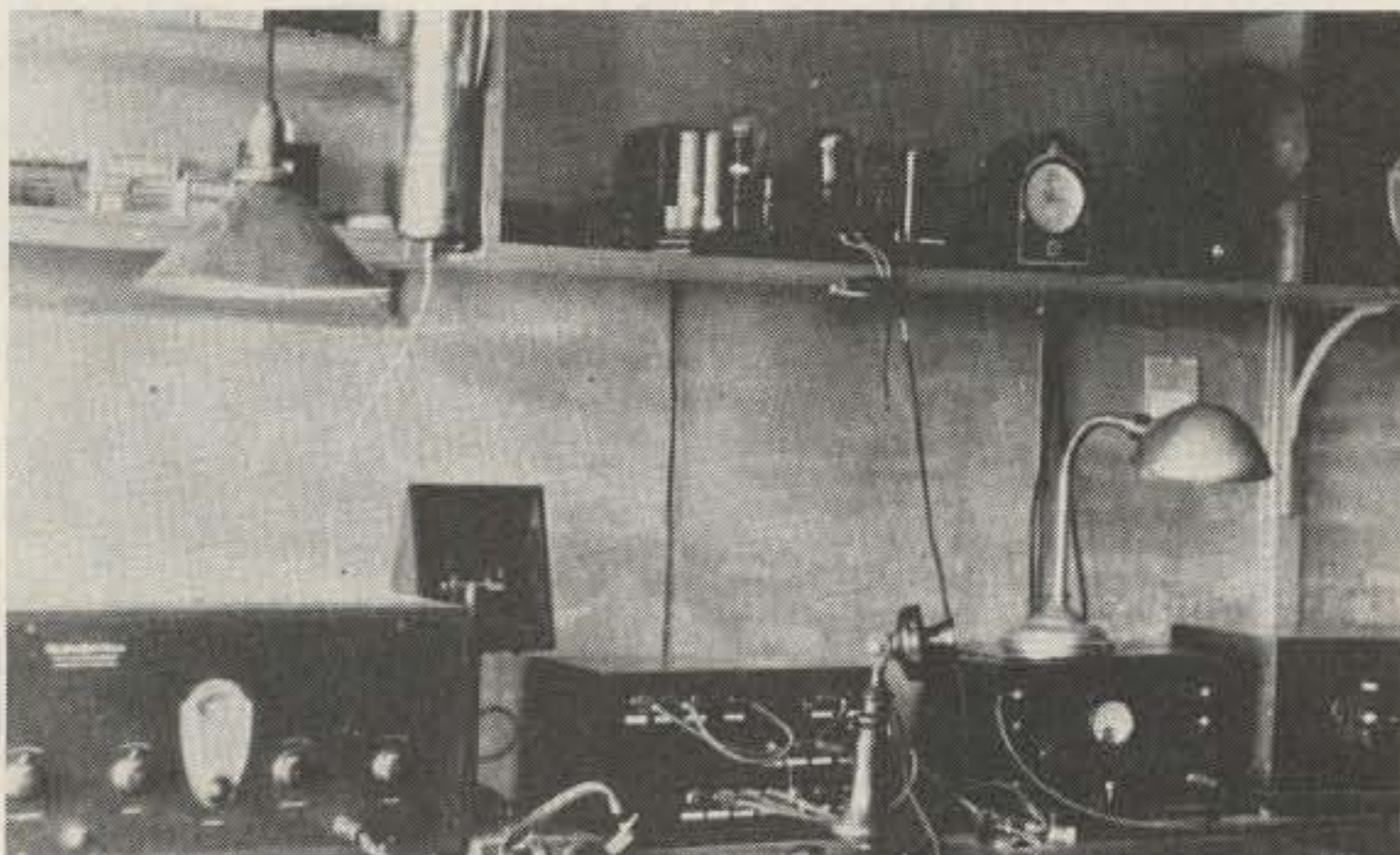

Front view of Byrd expedition receiver.

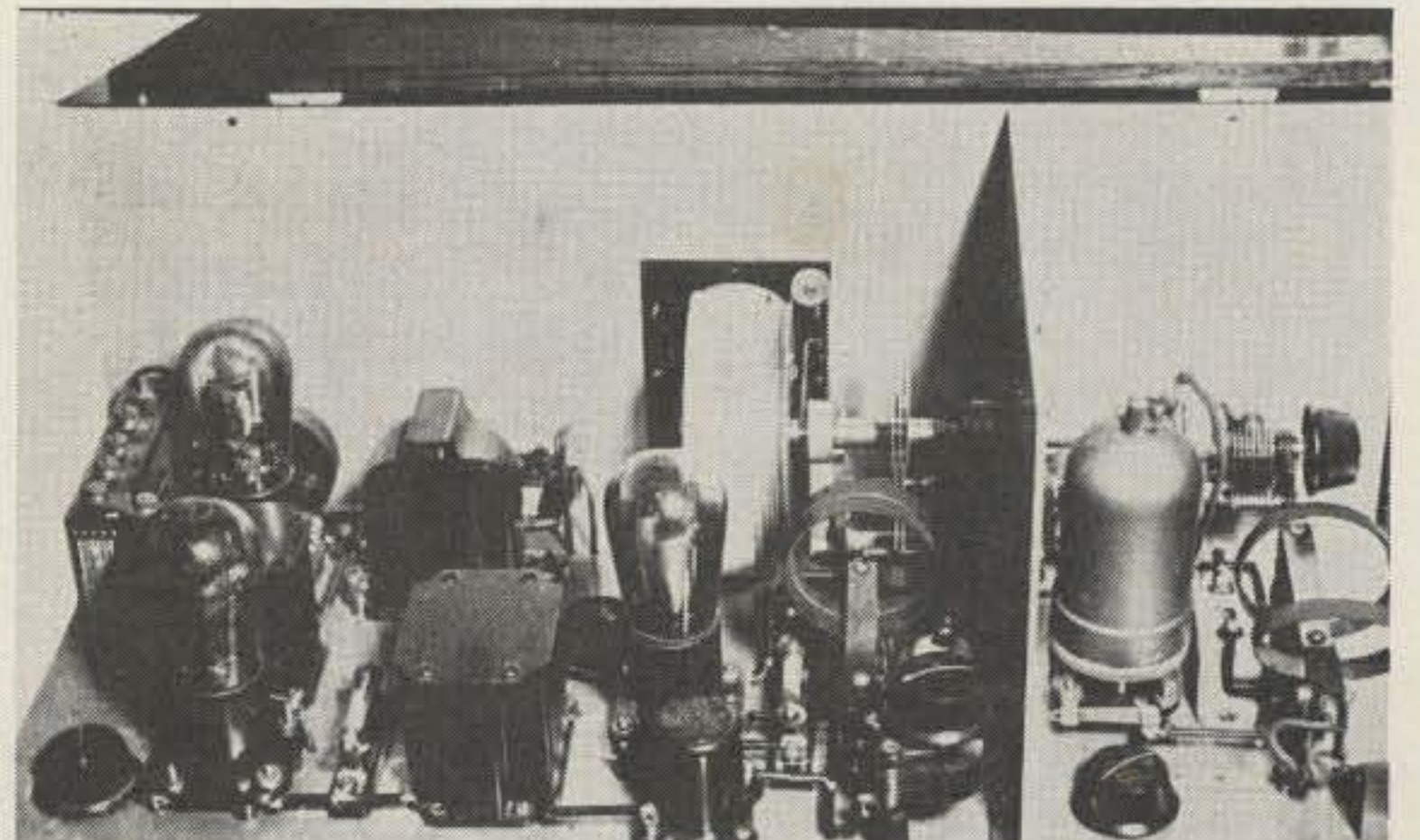

1928 shortwave receiver built by Iverson for reception from the Admiral Byrd 1928 expedition. Back view.

patches received during the day could be printed in the paper that night. Two years later, in 1922, this station was superseded by a completely new installation, and the radio room was

moved from the tower to the new *Times* building on 43rd St. Radiotelephone had become popular, and several broadcast receivers were added at the new installation.

At this time, in order to further improve press reception, Iverson was sent on a lend-lease basis to Halifax, Nova Scotia, to establish another transatlantic receiving station.

This project, to be known as *News Traffic Board, Ltd.*, was a joint venture of the *New York Times*, *Philadelphia Public Ledger*, *Chicago Tribune*, and a Canadian paper.

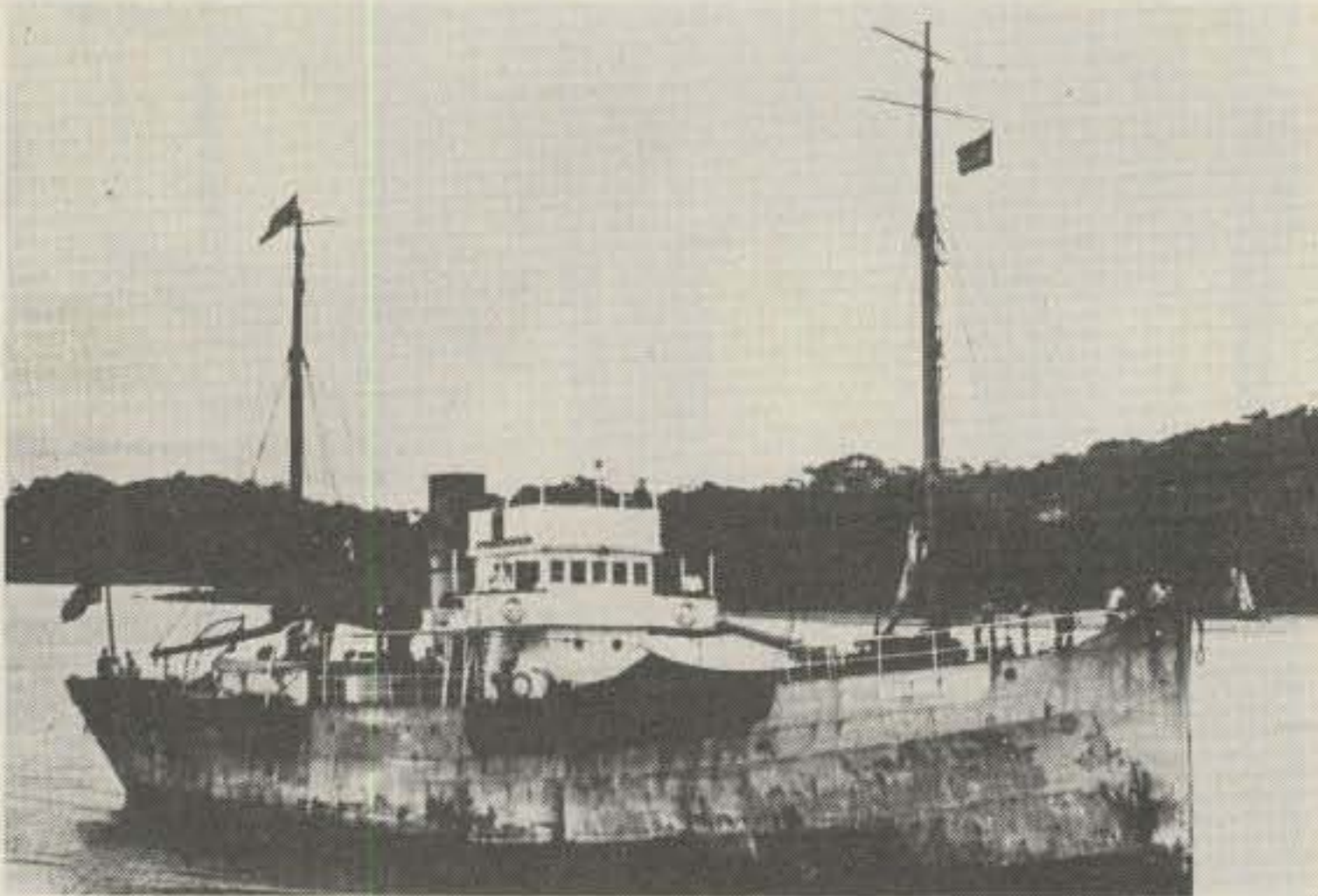

Byrd ship Eleanor Bolling, 1928 expedition.



New York Times headlines, 1929 Byrd flight.

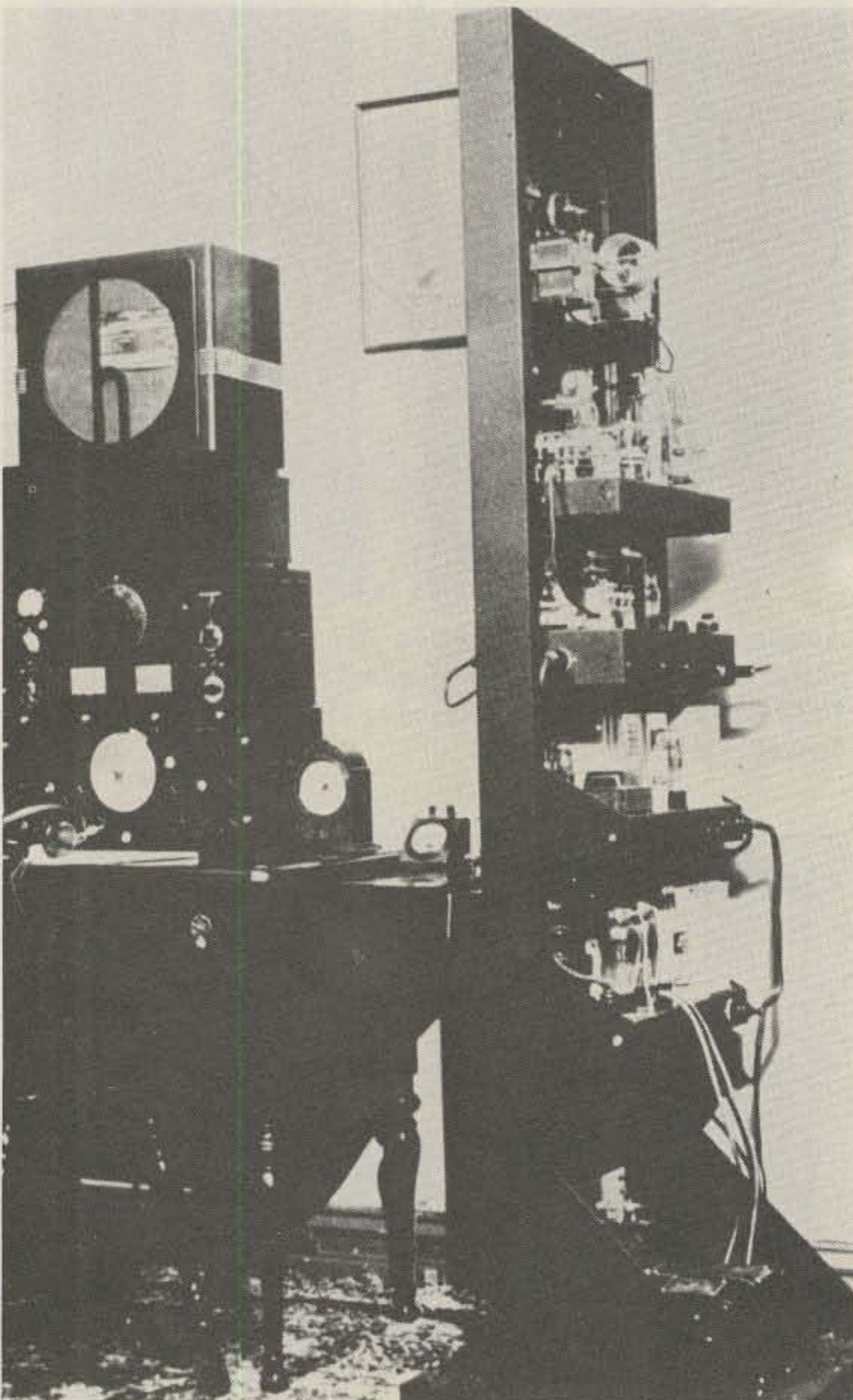

R. J. Iverson W2LDR home station in Astoria, L.I., 1938.



1935 flight: Thor Lothing, N.Y. to Norway, before takeoff. Picture of plane with note to R. J. Iverson of the Times. (Times installed his radio.)

Shortly after completion of the Halifax station, its efficiency and that of Iverson, its only engineer and operator, were sorely tried when Irish rebels cut the transatlantic cables at the repeater stations along the Irish coast. This left in operation only two very slow cables, one of them from France. Since this reduced the communication channels considerably, Iverson sat at the typewriter fifteen hours daily, from 10:00 am until 1:00 am, copying the London long-wave press transmissions until more operators could be recruited. His perseverance greatly expedited copy intended for the United States and Canadian newspapers, and

this experience proved to the papers the value of wireless. They now poured more money into building a better station at Dartmouth, Nova Scotia, with a vastly improved antenna system. Balanced loops and towers were installed. Incidentally, this station was a forerunner of Press Wireless, founded in 1929.

Iverson returned to the *Times* in 1924 as chief engineer. The receiving equipment was updated, long-wave receivers were built with audio bandpass in the outputs, and new antennas were erected. All of this resulted in excellent reception from Europe.

About the time that shortwave frequencies

were coming into use, around 1926, a rash of explorers and fliers were making headlines. When Richard Byrd and Amundsen reached Spitzbergen

Bay in their race to be first to fly over the North Pole, Byrd by plane and Amundsen by the dirigible, *Norge*, the commercial dispatches that came from there were



Press Wireless receiving room, Little Neck, L.I., 1929.

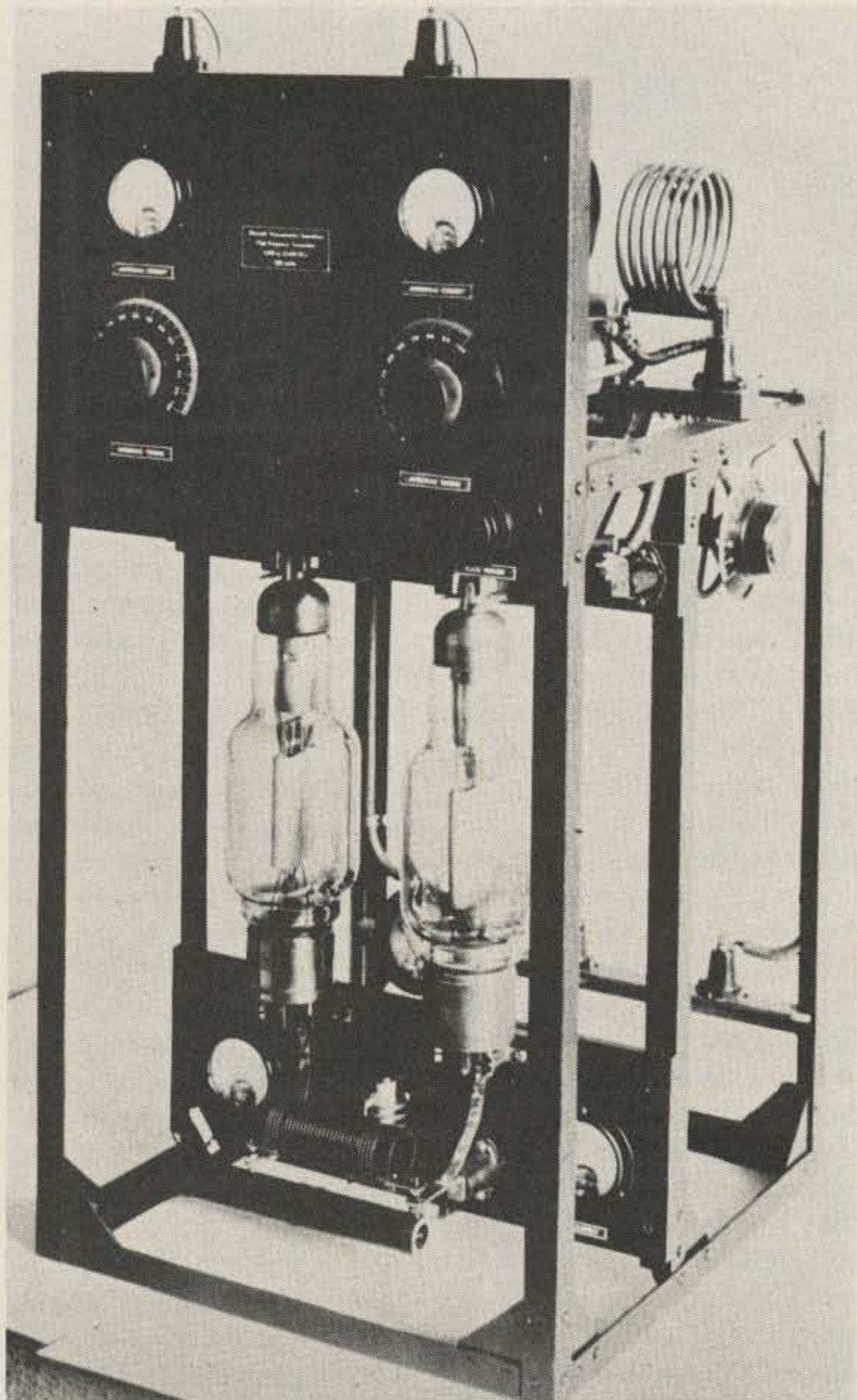

204 transmitter which the Times built for the Ellsworth trans-Antarctic expedition. Front view.

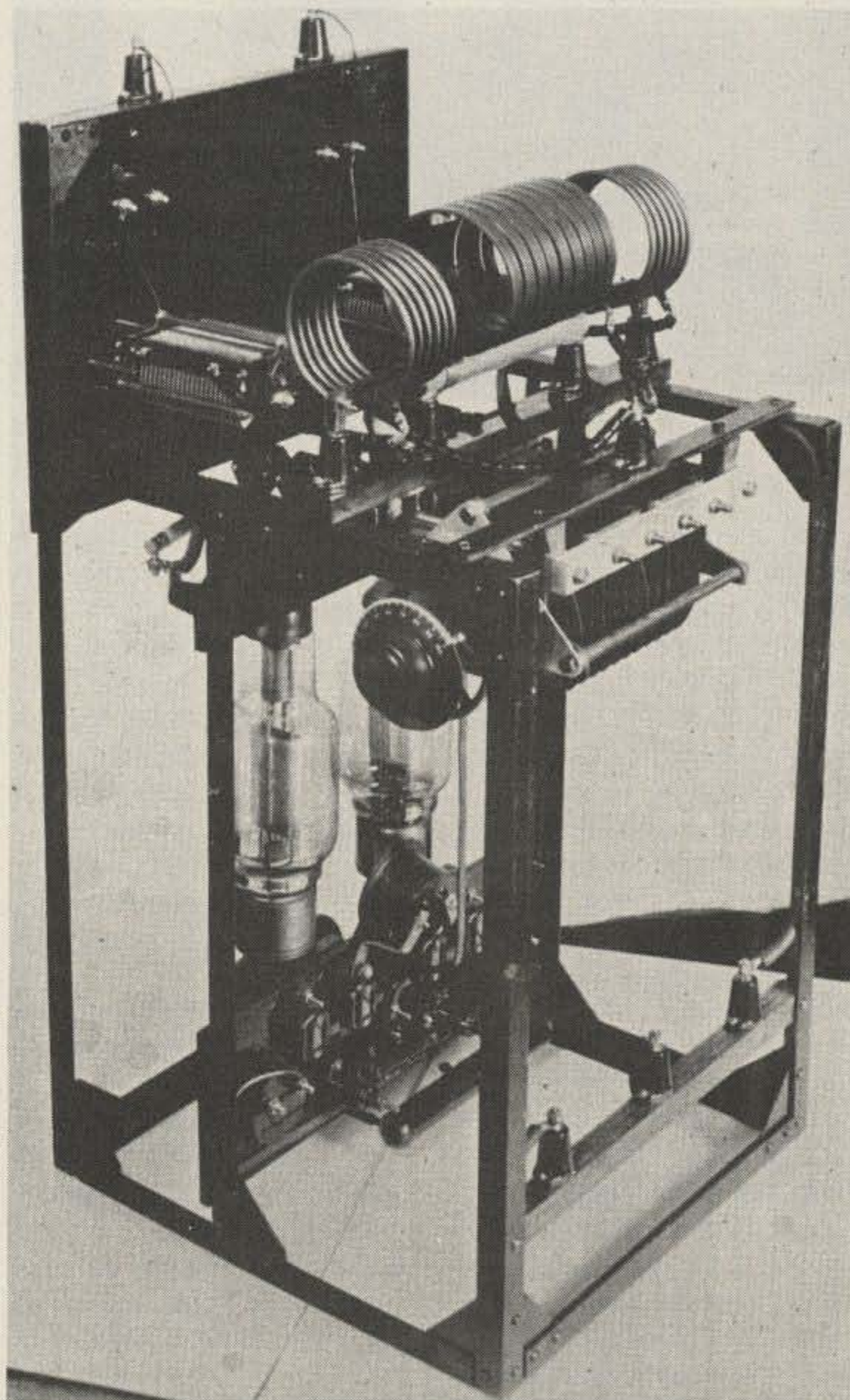

Back view of same transmitter.

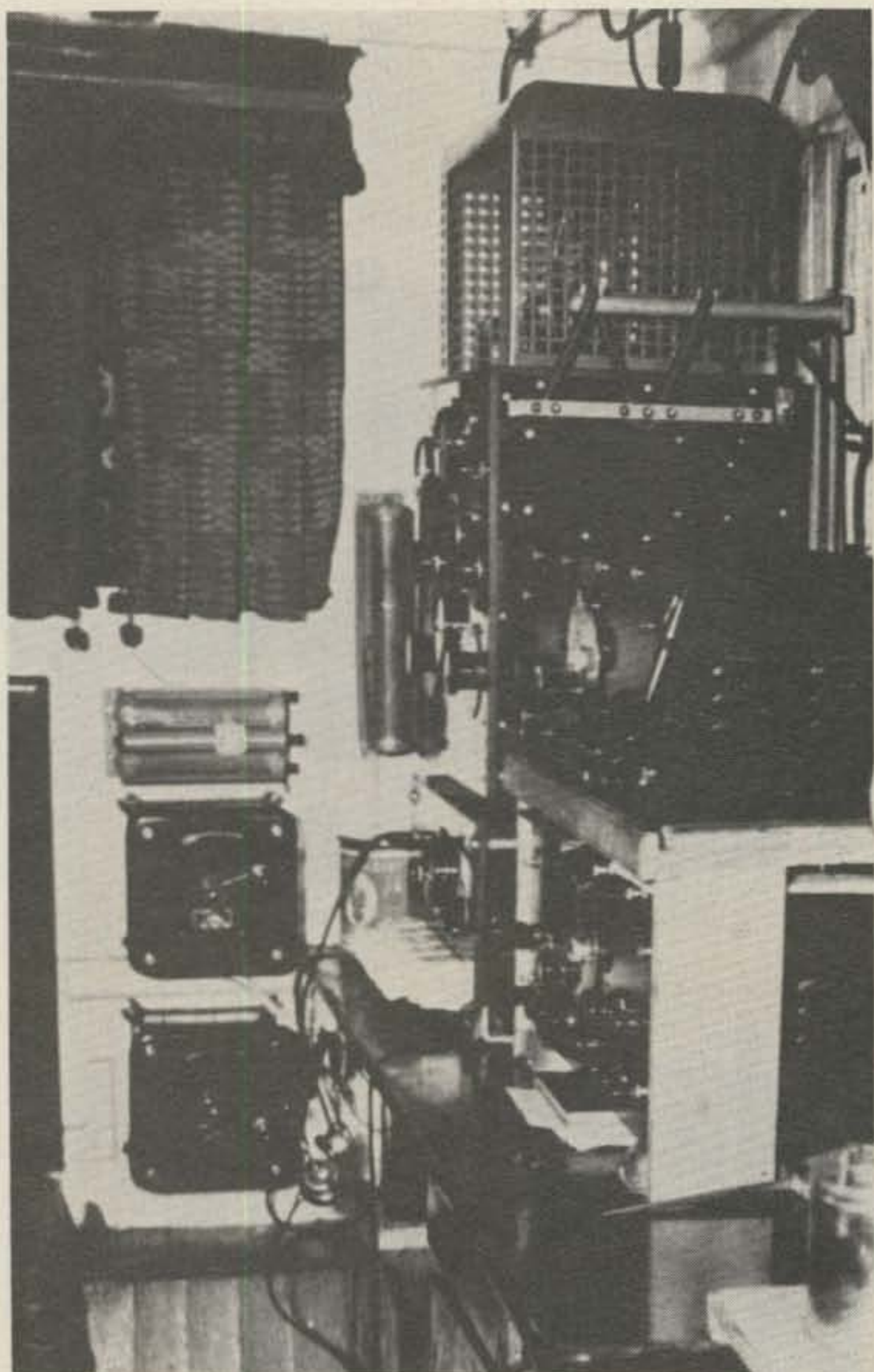

Louise Boyd North Greenland expedition, 1938. Front view.

unsatisfactory even when the *Times* had to pay over \$1.00 a word for them. This prompted the engineering department to build immediately a 500-Watt short-wave transmitter using two 204 tubes in tuned-plate, tuned-grid, with the plate supply furnished by Crocker-Wheeler motor generators. Several high-frequency receivers also were constructed.

In 1926, the *Times* applied for and received an amateur license with the call letters U2UO. From then on, direct press communications were established with expeditions to all parts of the world. Thousands of words of front-page copy appeared under the slug, "By wireless to the *New York Times*." Two

years later, at the insistence of the American Radio Relay League, station U2UO was phased out and a commercial license was issued with the call letters WHD. Frequencies were assigned in the press section of the marine bands.

A partial list of the noteworthy expeditions covered by the *Times* follows:

- The Richard Byrd and the Amundsen flights (already mentioned above).
- The Count Von Luckner 'round the world "Cruise of Good Will" on the yacht *Vaterland*, in 1927.
- Captain William Erwin's flight in the *Spirit of Dallas*, 1927. The *Times* operator in New York heard his last message as his plane fell into the Pacific and was lost.

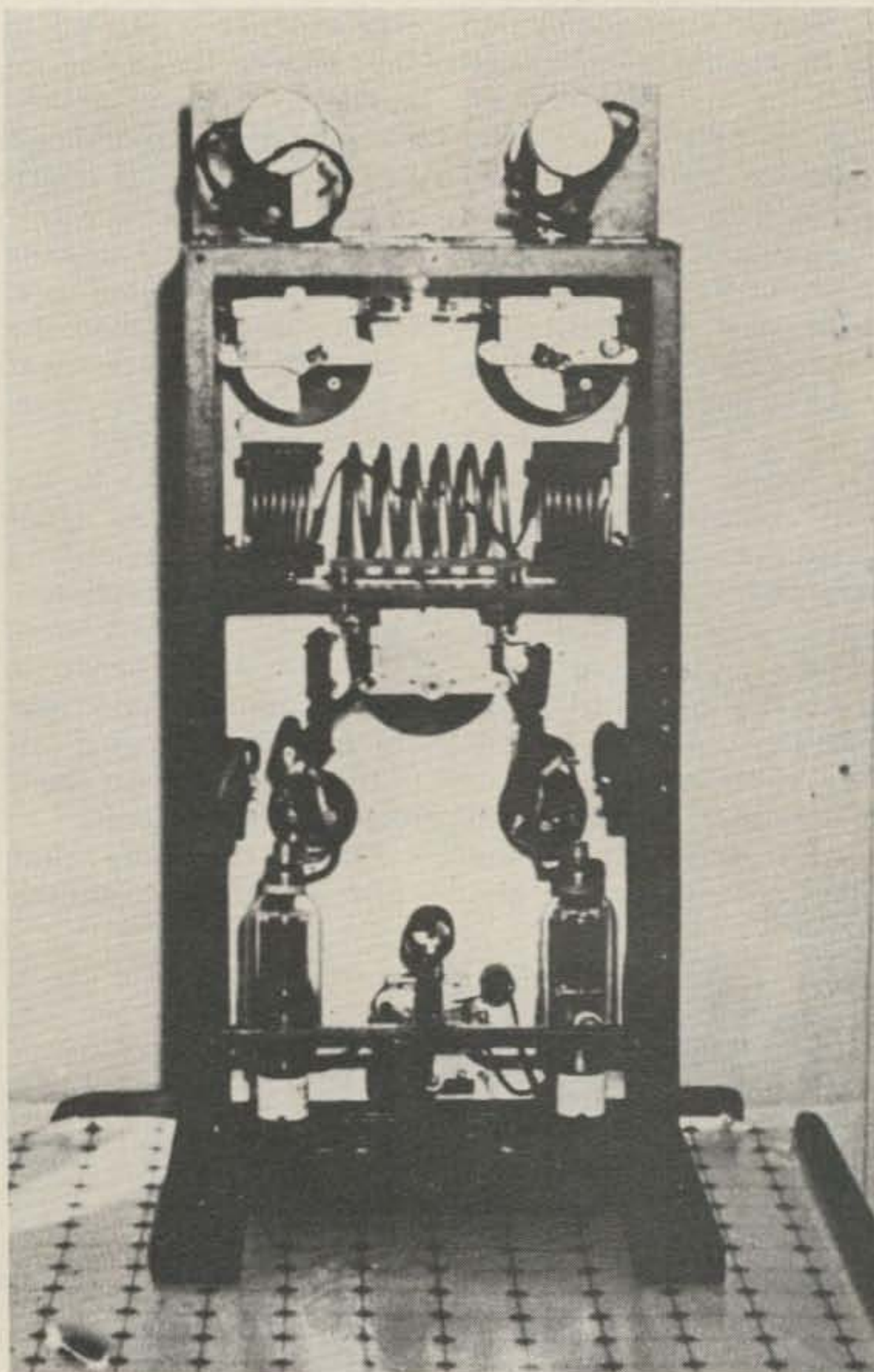

Back view of one of the transmitters. Times-built by R. J. Iverson. Call letters of expedition: LAHR.

● The Byrd Antarctic Expedition to Little America, 1928. Much of the equipment was supplied by the *Times* in exchange for exclusive newsbeats. More than two million words were handled by the stations of the expedition, and communication with Little America was so reliable that it was referred to as "the 9000-mile wire to the South Pole."

● The Hobbs University of Michigan Expedition to Greenland, 1928. An interesting sidelight here was that the Rockford (Illinois)-to-Sweden fliers, Haskell and Cramer, were lost after their last radio signals placed them at the northern tip of Labrador. No word of them was heard until they walked into Hobb's camp

100 miles from their landing site. The first edition of the *Times* that very night carried the story.

During the 1930s, the *Times* station worked closely with many other expeditions and fliers. Some of these were:

- War maneuvers in the far Pacific. The paper had its correspondent on the flagship, *Pennsylvania*, and WHD communicated directly with the fleet through a receiving station in Iverson's home in Astoria. The transmitter was controlled by land line.
- The Russian flier's Moscow-to-Los Angeles flight, lost in the Arctic without a trace. Iverson was commissioned to obtain a complete radio station to communicate with the search expedi-

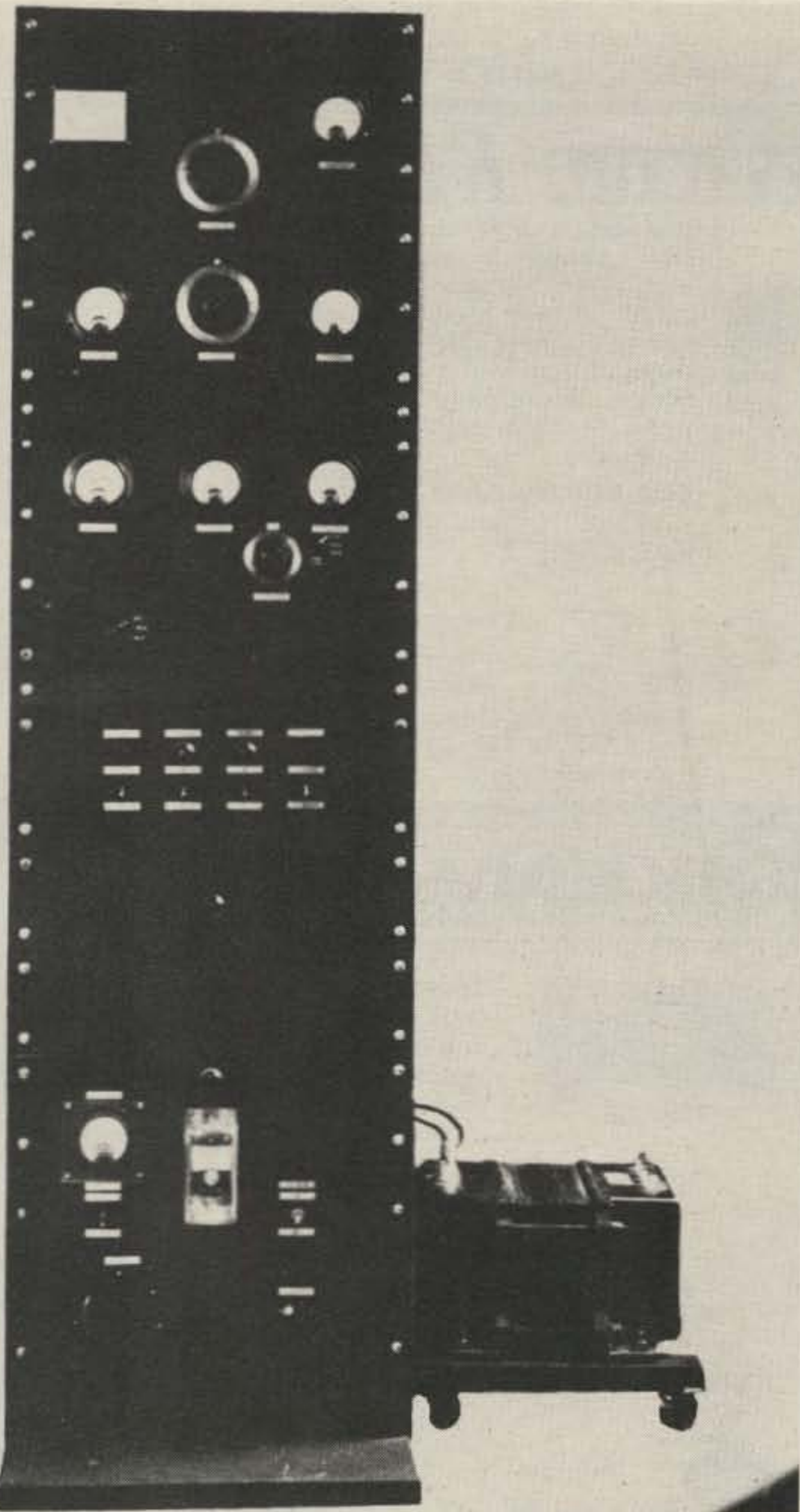

One of WHD's postwar transmitters, 1947.

tion headed by Wilkins and based in Point Barrow, Alaska. The plane was never found.

- The Lincoln Ellsworth trans-Antarctic expeditions under Sir Hubert Wilkins, 1938-9. Iverson built all of the transmitters and organized and secured communications equipment used for two years. At this time he became active in amateur radio as W2LDR to service the expeditions with an outlet for news and personal messages.

- The expedition of San Francisco socialite Louise Boyd to North Greenland. The same services were performed for communica-

tions as in the expeditions above. Her valuable surveys were used by the Navy in World War II.

With the coming of World War II, there were no more explorations. The world had become too small and there were more immediate concerns.

News broadcasts begun by station U2UO were now continued with WHD twice daily on marine frequencies and were heard regularly by Australia, South America, and ships at sea. The reputation of the *Times* was such that it was the only station allowed to transmit its hour-long newscasts without a censor sitting in



News receiving room with printers. Note National HRO in background.

the radio room. Also, half a dozen shortwave receivers were set up to constantly intercept broadcasts from London, France, Berlin, and Rome. This information was important to the reporters and correspondents, although much of the news from the Axis powers was exaggerated or untrue.

Soon after the war, the twenty-five-year-old transmitters of WHD were replaced by two modern crystal-controlled jobs with the increased output of 2 kW. They now had ac in the radio room in the tower where formerly there had been only dc. News summaries were broadcast until the mid-sixties, when it seemed that there was no further need for them.

After the armistice, the Reuters News Agency, Lon-

don, wanted to establish itself in the United States and South America. The *Times* agreed to handle their east-to-west communications into the States. High-speed radio circuits were set up at the London end and receiving time was leased from Press Wireless and ITT. The signals then were piped into the *Times* radio room. Thirty to forty thousand words of press copy from Reuters were handled daily, received on Hellschreibers, facsimile-type printers. These were made in Germany and were capable of taking fifty words a minute.

In 1965, the license of WHD, which had seen such extraordinary service, was allowed to lapse and Iverson, after almost fifty years with the *Times*, retired. ■

Tempo, Ten-Tec, Texas RF, Tonna Antennas, TPL, Tri-EX, Van Gorden, Vibroplex, Vidaire, Vista, VHF Engineering, VOMAX, Wilson, YAESU?

KENWOOD



TR7600: 2m FM XCVR. 10 watts, LED readout, 144-147.995. Fully synthesized, any repeater offset possible, memory channel.

TR7600 VHF XCVR **\$375.00**
 BLC 10/70 VHF Power Amplifier **149.95**



TOTAL REGULAR PRICE **\$524.95**
 SALE PRICE **\$424.95**

Vhf engineering

SAVE \$100.00

Unarco-Rohn

COMPLETE 25G TOWER PACKAGES

50' Guyed Tower: Includes top section, 4 regular sections, base plate, rotor plate, 50' guy wire, 2 guy assemblies with torque bars, 3 concrete guy anchors and other miscellaneous hardware.

TOTAL REGULAR PRICE **\$594.02**
 SALE PRICE **464.02**

SAVE \$130.00

50' Bracketed Tower: Includes top section, 4 regular sections, base plate, rotor plate and universal house bracket.

TOTAL REGULAR PRICE **\$366.15**
 SALE PRICE **266.15**

SAVE \$100.00



BECKMAN



...Beckman Multimeters keep going.

If you've ever been troubled by a faulty multimeter — or had one that wasn't quite up to the tougher jobs — your troubles are over.

Choice of Models
 The TECH 310 has all above features, 7 functions, 29 ranges, plus 0.25% Vdc accuracy.
 The TECH 300 has a 0.5% Vdc accuracy and all the above features, but without Insta-Ohms™ continuity function or the 10 amp current ranges.

Complete Multimeter Capability
 DC volts: 100 μ V to 1500V
 AC volts: 100 μ V to 1000V rms
 Resistance: 0.1 Ω to 20M Ω
 DC current: 100mA to 10A (TECH 310)
 100mA to 2A (TECH 300)
 AC current: 100mA to 10A (TECH 310)
 100mA to 2A (TECH 300)
 Diode/Semiconductor test function
 Continuity function (TECH 310)

TECH 300 — \$100
TECH 310 — \$130

TEN-TEC



574



570

TUFTS NOVICE EXCLUSIVE

Purchase your Century 21 (570 or 574) from us and have up to one year to apply the full purchase price towards a model 540, 544, 545, or 546 when you upgrade your station.

NOVICE SPECIAL

TEMPO KLM YAESU



Syncom S1 with TTP:
 From Tempo — the world's first synthesized 800 channel handheld transceiver. Includes battery pack, charger, telescoping antenna — and 800 channels!

FT207R:
 From YAESU — 2m FM XCVR. Handheld completely synthesized, digital readout, keyboard access, 2 watts, 4 memories and much more.

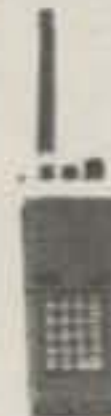

KLM PA2-25B Power Amplifier: 2 watts in, 25 watts out.

PACKAGE 1

Tempo S1 w/TTP **\$339.00**
 KLM PA2-25B Power Amplifier **92.95**

TOTAL REGULAR PRICE **\$431.95**
 SALE PRICE **\$396.95**

SAVE \$35.00

PACKAGE 2

FT207R Synthesized 2m handheld **\$399.00**
 KLM PA2-25B Power Amplifier **92.95**

TOTAL REGULAR PRICE **\$491.95**
 SALE PRICE **\$441.95**

SAVE \$50.00

KENWOOD

...pacesetter in amateur radio



TS520SE

TS520SE: 160-10 meters, 200 watts P.E.P., speech processor, noise blanker, excellent sensitivity and minimum cross-mod.

5BTW

TS520SE **\$629.95**
 Hustler 5BTW Vertical **139.95**

TOTAL REGULAR PRICE **\$769.90**
 SALE PRICE **\$649.90**

SAVE \$120.00

or

TS520SE **\$629.95**
 ATB34 Cushcraft TriBander **\$289.95**

TOTAL REGULAR PRICE **\$919.90**
 SALE PRICE **\$769.90**

SAVE \$150.00

ATB34



KENWOOD



TL922A: 2kW P.E.P., 160-15 meters, 3-500Z tubes.

TL922A: **\$1199.00**
 MBII Tuner **295.00**

TOTAL REGULAR PRICE **\$1494.00**
 Sale Price **\$1294.00**

SAVE \$200.00



Model 43



MBII TUNER: 3kW, 160-10 meters.

TL922A: **\$1199.00**
 Bird Model 43

with 2500H element and carrying case **201.00**

TOTAL REGULAR PRICE **\$1400.00**
 Sale Price **\$1200.00**

SAVE \$200.00

CALL AND CHECK OUR GREAT DEALS ON ALL YOUR AMATEUR RADIO NEEDS.
 DIAL: (617) 395-8280

Stock items shipped within 24 hours. Prices subject to change. Limited quantity on some items.

QUESTION: Who has Advanced Electronics, Alpha, AMECO, Amphenol, Antenna Specialists, Astatic,

Atlas, Bencher, Bird, Bomar, B&W, CDE, CES, CSC, Cushcraft, Daiwa, Datong, DGM, Drake, ETO, F9FT, Finco, Ham Key, Henry Hustler, Hygain,

☆☆☆☆☆☆☆☆ PALOMAR ENGINEERS ☆☆☆☆☆

R-X NOISE BRIDGE \$55.00



- Learn the truth about your antenna.
- Find its resonant frequency.
- Find R and X off-resonance.
- Broadband 1-100 MHz.
- Simple to use. — Self contained.

VLF CONVERTER \$59.95



- New device opens up the world of VLF radio.
- Converts VLF to 80 meters. For use with any shortwave receiver covering 3.5-4 MHz.
- Advanced design for simple operation, high performance.
- Gives reception of the 1750 meter band.
- Also covers navigation radiobeacons, WWVB, ship-to-shore, and LF broadcast band.

LOOP ANTENNA

Loop Amplifier \$67.50
Plug-in loops \$47.50 ea.

- Plug-in loops available for:
1600-5000 KHz (160/80 meter amateur bands)
550-1600 KHz (Broadcast Band)
150-550 KHz (VLF, 1750 meter band)
40-150 KHz (WWVB, Loran)
10-40 KHz (Omega)
- Nulls out interference



ALL BANDS PREAMPLIFIER \$89.50



- Tunes 1.8 to 54 MHz. Covers ALL amateur bands 160 to 6 meters. ALL shortwave broadcast bands.
- For receivers AND transceivers.
- Up to 20 db gain.
- Peps up that tired receiver.
- Reduces image and spurious response.



Model MB II \$295
(with Balun) \$325

MB II provides:
* Constant SWR monitoring. * Precision tuning of final amp. * Harmonic suppression.
* Receiver input impedance-matching. * Maximum power transfer to antenna. * Continuous frequency coverage 1.6 to 30 MHz. * Precision tuning of any wire 1/2 wavelength or longer, with SWR of 1:1.

MB II features:
* Finest quality, made-in-USA components. * Large, precision, easy-to-read dials with 360 readout. * Optional 3000 watt Balun for twin lead antennas.

BIRD
Electronic Corporation

\$94 VHF model 4362 (140-180 MHz)

\$94 HF model 4360 (18-30 MHz)

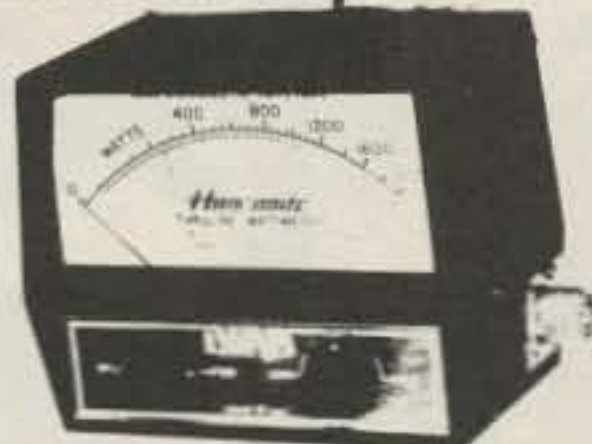

The 4360, 4362 HAM-MATE Directional Wattmeters are insertion type instruments for measuring forward or reflected power in 50-ohm coaxial transmission lines. They are direct descendants of the model 43 THRULINE® Wattmeter — the professional standard of the industry — and will accurately measure RF power flow under any load condition. Each wattmeter is made up of a precisely machined section of 50-ohm line, a rotatable sensing element and meter calibrated in watts, all mounted in a high-impact plastic housing. It is this type of solid construction and the directional THRULINE coupling circuit, without toroids, that account for the superiority of the HAM-MATE Wattmeters.

the indispensable
BIRD 43
THRULINE
WATTMETER



Power Range	Frequency Bands (MHz)				
	2-30	25-60	100-250	200-500	400-1000
5 watts	—	5A	5C	5D	5E
10 watts	—	10A	10C	10D	10E
25 watts	—	25A	25C	25D	25E
50 watts	50H	50A	50C	50D	50E
100 watts	100H	100A	100C	100D	100E
250 watts	250H	250A	250C	250D	250E
500 watts	500H	500A	500C	500D	500E
1000 watts	1000H	1000A	1000C	1000D	1000E
2500 watts	2500H	2500A	2500C	2500D	2500E
5000 watts	5000H	—	—	—	—

MODEL 43
Elements (Table 1) 2-30 MHz \$130.00
Elements (Table 1) 25-1000 MHz 45.00
Carrying case for Model 43 & 6 elements 38.00
Carrying case for 12 elements 27.50
Carrying case for 12 elements 17.00

READ RF WATTS DIRECTLY! (Specify Type N or SO239 connectors) 0.45 — 2300 MHz, 1-10,000 Watts ±5%, low insertion VSWR — 1.05. Unequaled economy and flexibility. Buy only the element(s) covering your present frequency and power needs, add extra ranges later if your requirements expand.



5-BAND TRAP DIPOLE
(80 thru 10 Meters)

Barker & Williamson

Power rated 2k WPEP, approx. 110 ft. span

Complete with: wire, traps, end insulators, 50 ft. RG-8/U, PL-259 connector, heavy-duty cast aluminum and steatite center connector.



Pre-assembled:
Model 370-11
— \$64.95

Kit (illustrated):
Model 370-12 — \$54.95



TWO-METER
CRYSTAL SALE
\$2.25 each
Limited to existing stock.

Standard • Icom • Heathkit • Ken • Clegg • Regency • Wilson • VHF Eng • Drake • And Others!

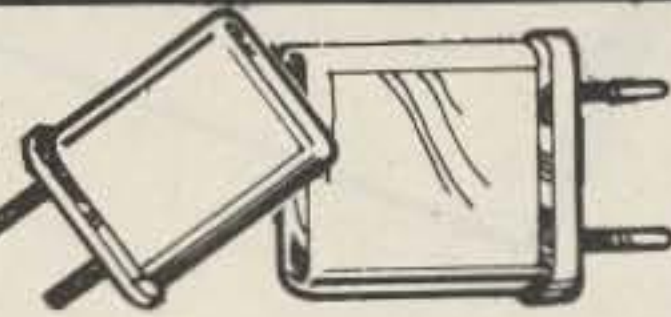

Hy-Gain REEL TAPE PORTABLE DIPOLE
for 10 thru 80 Meters Model 18TD

The most portable high performance dipole ever...

The Model 18TD is unquestionably the most foolproof high performance portable doublet antenna system ever developed. It has proven invaluable in providing reliable communications in vital military and commercial applications throughout the world. Two stainless steel tapes, calibrated in meters, extend from either side of the main housing up to a total distance of 132 feet for 3.5 mc operation. 25 ft. lengths of polypropylene rope attached to each tape permits installation to poles, trees, buildings... whatever is available for forming a doublet antenna system. Integrated in the high impact housing is a frequency to length conversion chart calibrated to meter measurements on the tapes... makes installation foolproof. Feeds with 52 ohm coax. Delivers outstanding performance as a portable or permanent installation. Measures 10x5 1/2 x 2 inches retracted. Wt. 4.1 lbs. Order No. 228 Price: \$94.95



hy-gain

BANDPASS-REJECT DUPLEXER
DPLA-144 FOR 144-174 MHz
Also available for
54, 220, 450 MHz.

THESE BAND PASS BAND REJECT CIRCUIT DUPLEXERS include the use of an exclusive circuit designed for VHF ENG which provides superior suppression of spurious filtered noise between and adjacent to the duplex frequencies. When used with a high Q filter, the Band Pass Band Reject Circuit provides frequency response curves with bandpass cavity characteristics at the frequency to be passed and bandreject cavity characteristics at the frequency to be attenuated. Performance characteristics improve as the frequency separation is increased. Frequency stability of the Band Pass Band Reject Circuit duplexers is excellent — an important factor in close frequency spacing. Each model will handle transmitter powers up to 200 watts and all models are supplied with complete cable harness and mounting brackets.

\$479



WACOM



Name _____ Call _____
Address _____
City _____ State _____ Zip _____
Order: _____

Check Enclosed Visa Master Charge Send for Free Catalog

PRICES SUBJECT TO CHANGE WITHOUT NOTICE

Card no. _____ Card exp. date _____
Signature _____

Prices FOB Medford, MA. MA residents add 5% sales tax. Minimum \$3.00 for shipping and handling on ALL ORDERS.

206 Mystic Avenue, Medford, Mass. 02155, Tel: 1-617-395-8280

TUFTS

Radio Electronics
OPEN DAILY 9-9
SATURDAY 9-5

T3

JMR, KLM, Kenwood, Larsen, MFJ, Microwave Filter, Morgain, Mosley, Newtronics, NPC, Nye Viking,

Radio World

CENTRAL NEW YORK'S FASTEST GROWING HAM DEALER



Featuring Yaesu, Icom, Drake, Ten-Tec, Swan, DenTron, Midland, KDK, MFJ, Microwave Module, Tempo, Astron, KLM, Hy-Gain, Mosley, Larsen, Cushcraft, Hustler, Mini Products, Bird, DSI, Mirage, Vibroplex, Bencher, Info-Tech, Universal Towers, Callbook, ARRL, Astatic, Shure. We service everything we sell! Write or call for quote. You Won't be Disappointed. We are just a few minutes off the NYS Thruway (I-90) Exit 32

Warren K2IXN
Call Toll Free: 1-800-448-7914
ONEIDA COUNTY AIRPORT TERMINAL BUILDING
ORISKANY, NEW YORK 13424
Bob WA2MSH
New York State Residents Call: 315-337-2622 or 315-337-0203

Now — the industry's first truly **super keyboard**

INFO-TECH M-300 TRI-MODE KEYBOARD

A microprocessor controlled keyboard that generates: Morse, RTTY, & ASCII.



Other Features:

- Built in quick brown fox generator on all modes
- Automatic CR/LF
- 700 Character Running Buffer
- 10 recallable user programmable message memories of 120 characters each
- CQ & DE special keys on all modes
- Keyboard control of all functions except shift & buffer control
- 4 row keyboard eliminates figures/letters shifting on RTTY
- Many more features

Morse Features:

- 4 to 125 WPM in 1 WPM increments
- 9 adjustable weight levels
- relay keying
- sidetone with tone and level adjustments
- special keys AS BK BT AR SK CQ DE

RTTY Features:

- 4 speeds
- 2 shifts (170 & 850 hz)
- built in AFSK
- built in CWID
- built in RY generation

ASCII Features:

- 110 & 300 Baud
- 2 shifts (170 & 850 hz)

Best of all, only \$450⁰⁰
F.O.B. Factory

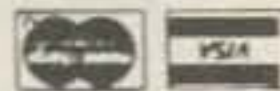

ORDER DIRECT OR FROM THESE DEALERS

A-1 Technik

Blomberg 3
D-5882 Meinerzhagen 2
West Germany

Cohoon Amateur Supply, Inc.

307 McLean Avenue
Hopkinsville, Kentucky 42240
502-886-4534

Dialta Amateur Radio Supply

212 48th Street
Rapid City, S. Dakota 57701
605-343-6127

Emona Electronics

Suite 208 / 661 George Street
Sydney NSW 2000 Australia

Germantown Supply

3202 Summer Avenue
Memphis, Tenn 38112
901-452-4276

Gilfer Associates, Inc.

52 Park Avenue
Park Ridge, New Jersey 07656
201-391-7887

Global Communications

606 Cocoa Isles Blvd
Cocoa Beach, Florida 32931
305-783-3624

Ham Radio Center

8342 Olive Blvd
St. Louis, Missouri 63132
314-993-6060

Marcucci-SPA

Via F.lli Bronzetti
37 20129
Milan, Italy

N & G Distributing Corp.

7285 NW 12th Street
Miami, Florida 33126
305-592-9685

Panacom

P.O. Box 76093
Caracas 107 Venezuela

Radio World

Oneida Co. Airport
Terminal Bldg.
Oriskany, New York 13424
800-448-7914 or
315-337-2622

Universal Amateur Radio Inc.

1280 Aida Drive
Reynoldsburg, Ohio 43068
614-866-4267

INFO-TECH

INCORPORATED

Specializing in Digital Electronic Systems

2349 Weldon Pkwy St. Louis, Missouri 63141 Phone (314)576-5489

JAN CRYSTALS

JAN CRYSTALS KEEP YOU ON THE AIR

- CB
- CB standard
- 2 meter
- Scanners
- Amateur Bands
- General Communication
- Industry
- Marine VHF
- Micro processor crystals

Send 10¢ for our latest catalog. Write or phone for more details.

Jan Crystals
2400 Crystal Drive
Ft. Myers, Florida 33907
all phones (813) 936-2397



easy to charge



IT'S HERE!!

THE AMCODER

4" x 2 3/8" x 6"

A NEW ERA IN CW REGENERATION

- Select any CW signal that's 40 hz away from any other (Tune—400 to 1500 hz)
- Lock and switch to "auto" and you have tape quality audio. One and one only signal reception.
- Only 20 mv of audio above receiver noise required for acquisition.
- A 40 db over S9 signal, 50 hz away cannot come through.
- Reduce operator fatigue by not listening to any other band and/or signal noise except the one you want to work.
- Variable acquisition frequency—400 to 1500 hz.
- Variable output tone frequency—100 to 2000 hz.
- Variable output audio level (drives ear-phones or station speaker).

Kit includes all parts including cabinet, power supply and complete instructions. Epoxy glass boards, plated and pre-drilled.

Available—Factory wired and tested with 1 year warranty on parts and workmanship.

Kit—\$69.95 FWT—\$89.95

301-799-7741

VISA and Master Charge Accepted.

AMC ENGINEERING

P. O. Box 427, Jessup, MD 20794

QRP from Canton Island

— proving all things are possible

Author's note: Since my April, 1979, visit, some changes have taken place which may have an important effect on Canton as a DX location. First, the area has been included in the newly-formed Republic of Kirabati and the military is no longer in charge of the island. Second, while the treaty is being finalized, the US representative on Canton is Larry KS6DV. He has been doing a fantastic DX job as KS6DV/KH1 and VR1PJ (just changed to T3PA). It's possible Canton may soon lose its place on the "rare DX" lists.

Call me naive. I honestly believed my trip to Canton Island would give me a chance to do some late night operating, something I rarely do at my home QTH just outside Honolulu. I thought I might even be able to work some rare DX stations, if I were lucky.

Little did I realize at the time that I was considered by some to be rare DX myself. I still consider myself to be a relative newcomer to amateur radio. My first Novice ticket was WN3CNX, obtained in 1954. I procrastinated a lot, never got on the air, and my unused license expired a year later. Finally, twenty-three years later, in 1977, I tested again and was given KH6JUO. In March, 1979, I upgraded to General and changed my call to KH6GB. As you can see, although I've known a bit about ham radio for quite a few years, my actual association has been very limited. Being basically economy-minded, I decided to try low power for a while and settled on the Ten-Tec Argonaut.

Officially, my Canton trip was Air Force busi-

ness—not a DXpedition. The radio gear was an afterthought, really. I packed more clothes than necessary, a typical fault of mine, but carefully left space for the Argo and its power supply. I casually mentioned my pending journey to a close friend, Marv KH6DL, and he came unglued, asking, among a hundred other questions, if there was room in my luggage for him. He tried to warn me of something called "pileups," but I didn't get the picture. He asked which bands and frequencies I'd be working, and got rather panicky when I truthfully replied that I hadn't thought about it. The afternoon before I departed, Marv provided a hastily-built 20-meter dipole and suggested a frequency I might try. We set up a tentative time to meet on the following Saturday, April 7th. It was the earliest I felt I'd be able to set up, and so I was on my way.

Wednesday, April 4th, arrived and the four and one-half hour flight from Hickam Air Force Base to Canton was routine. We flew on a C-141 Military Airlift Command (MAC) plane. Accompanying me

on the trip was Jim KH6HIT, also an active-duty Air Force member, who, although he chose not to operate, would later prove to be an outstanding engineer.

Around noon, we climbed down from the C-141 aircraft onto the sweltering ramp at Canton. Canton is one of eight small islands and the only inhabited one within the Phoenix Island group. There is a "British" side of Canton, but its only residents are sea birds and hermit crabs which thrive in the aging Pan American Airways clipper station ruins. During and after my trip, I was told I could have used a VR1 call in addition to the KH1. However, since I had very short notice of the journey, I hadn't had time to seek approval from the British government, so I could not and would not use the VR1.

Canton is a closed military installation, with a caretaker force of about thirty government contractor personnel. The temperature upon our arrival was 90° F, and the first order was to unpack and brief the site manager on our visit.

This was accomplished quickly, and almost before we knew it, the day was ending. Jim and I were told that the night life on Canton is virtually nil, so we decided to begin hooking up the radio. Jim took my old, homemade 15-meter dipole and tied it about six feet off the ground, between two coconut palm trees. Orientation was no problem—we simply ran it the same way that the trees ran! We had no idea which direction was north until the setting sun gave us our first clue. Now, where were we in relation to the rest of the world?

Fifteen meters appeared to be a poor choice on my part, for after two hours of intermittent CQing, I had worked one VK and a ubiquitous Japanese station. Jim and I raised the antenna as high as possible, leaving one end dangling in a palm tree while securing the other end to a building eave, but there was no improvement. Jim then fabricated a 10-meter dipole, but a half-dozen QSOs proved it (or the band) to be as unreliable as my previous attempt on 15. Then Jim suggested we try Marv's prefab 20-meter dipole in the same

two trees. Why didn't I think of that?

By now it was totally dark (where did I put that flashlight?). We quickly learned why there wasn't much night life on Canton. It should rate as the sand-bur capital of the world, or at least of the equatorial zone. Our stumbling around in the dark produced many ouches and groans and raised havoc with the many hermit crabs who had decided to investigate the disturbance. Finally, however, the new dipole was up, and a quick front-to-back check showed a nice, low swr; we did *something* right. A rapid CQ (or two) and success—an answer! During the next ninety minutes, I worked thirty-four stations, ranging from W4OOW in Georgia to one each P29, H4, UA0, KC6, 5W1, and several VKs and ZLs. I was in heaven. Little did I know that this was merely the tip of the iceberg.

For the next several evenings, Jim and I (mostly Jim) experimented with different antenna directions and heights, finally settling on a 060° heading with a height of about fifteen feet. This precarious altitude was reached by taking two 2 × 4s found drifting in the nearby lagoon and lashing them to the trees. The dipole ends were then tied to the tops of the 2 × 4s. This arrangement worked fine until one 2 × 4 came tumbling down during a rain squall, taking the dipole with it. (So *that* was why the swr needle jumped to 5:1—funny it didn't affect the ongoing QSOs.)

Somewhere along the way, perhaps during the second evening of operation, I was asked by Bob AA4AR in Tennessee if I could use some help. Well, his offer was a real blessing, because up until this time I had been roughing it, trying to punch through the QRM

alone. Bob and I worked together until QSB did him in, but then Larry W7IUV spoke up and took charge. He, along with several friends from the Central Arizona DX Association, assisted in setting up schedules and such. By the third night, it all began to make some sense to me. We could now move along with about two hundred contacts each evening, covering a three- to four-hour period. Larry, Ned AA7A, or Wayne W7QS would take a list up frequency, while the others maintained order down where I was. It worked perfectly, and we continued this method until my final evening on Canton. I'm firmly convinced that their help enabled many US and DX stations to contact me. Without them, we wouldn't have been able to make contact. Several other operators also were extremely helpful, doing what they could, when they could. Some of these were Walt AG5H, Bill WB7BKF, and Don WB7AQX. There were others whose names,

unfortunately, got lost in the heat of the battle, but I'm sure their QSL cards will straighten that out!

Quite a few QRP stations came through with 5 by 7 to 5 by 9 reports from New York, New Jersey, and the Southeast. Their 5-, 8-, and 10-Watt rigs should certainly help prove that full legal power isn't everything. Don't get me wrong—there were times when I wished for more oomph, but when you don't have it, you do what you can with what you've got. Incidentally, my prime frequency was 14280, up or down a bit, depending on QRM.

The final totals, as yet unverified, show that for twenty-five hours of operation, I worked 1150 stations, all with the 5-Watt Argonaut and the 20-meter dipole. Miraculously, on the last evening, Craig WB7EUT checked in from Wyoming, giving me QRP WAS. I experienced considerable difficulty working into Europe and the Middle East, and it was frustrating to hear the

4X4s, OEs, OKs, and EAs calling, among others. Unfortunately, they couldn't read the Argo. Despite this, I managed to work all continents QRP, thirty-six countries (including G3RCA), several Italian stations, and F6EXV. South America was well represented, and solid contacts were made with JY3ZH and EA8BW.

Would I do it again? Absolutely, but with better preparation. I'd try for approval of a VR1 call. I'd still use the Argonaut, but would look for a small beam and tower to make life easier. An unresolved difficulty is the problem of access approval for Canton and the actual trip itself. Since Canton is still military, only those with a valid, official reason can visit there. Also, the only aircraft authorized to land are military types, and military passengers are limited to sixty-six pounds of luggage each. If and when these difficulties are ever resolved, Canton Island would truly be a DXer's paradise. ■

Photo by James K. Gilman KH6HIT



Harv KH6GB on Canton Island.

LARUE ELECTRONICS ✓ L28 ANTENNA SPECIALISTS HEADQUARTERS

ANTENNA SPECIALISTS: 2-METER, 5/8 WAVE, GAIN MOBILE ANTENNAS: HM-179, 3/8" SNAP-IN HOLE MOUNT, \$31.95; HM-180, TRUNK LID MOUNT, \$35.95; HM-187, MAGNETIC MOUNT, \$39.50. 2-METER, 1/4 WAVE, UNITY GAIN MOBILE ANTENNAS: ASP-692, TRUNK LID MOUNT, \$20.00; ASP-694, MAGNETIC MOUNT, \$23.25. 2-METER, 5/8 WAVE, GAIN MOBILE DISGUISE ANTENNAS: ASP-748, GENERAL MOTORS, \$49.75; ASP-788, CHRYSLER/PLYMOUTH, \$53.50; ASP-798, FORD, \$52.50. COUPLER FOR DISGUISE ANTENNAS, ASP-619, \$18.75. RUBBER DUCKIE ANTENNAS: HM-4, 5/16"-32 MALE THREAD BASE, FOR ICOM IC-215, ETC., \$7.95; HM-5, PL-259 BASE, \$7.95. 2-METER FIXED STATION ANTENNAS: HMR-172, 5-ELEMENT YAGI, \$32.50; HMR-173, 11-ELEMENT YAGI, \$55.95; ASPA-680, REPEATER TYPE "BASE COMMANDER," FIBER GLASS, GAIN, \$118.50. ANTENNA SPECIALISTS 450-MHZ. AMATEUR AND COMMERCIAL, MOBILE AND FIXED STATION ANTENNAS AND ACCESSORIES ALSO IN STOCK. ICOM TRANSCEIVERS: IC-225, IC-202S, IC-211, IC-215, IC-255A, IC-280, IC-402, IC-502, IC-551, IC-551D AND IC-701AC. ICOM ACCESSORIES ALSO IN STOCK. BIRD MODEL 43 AND 4431 WATTMETERS, TABLE-1 ELEMENTS AND CC-1/EC-1 CARRYING CASES. CUSHCRAFT ANTENNAS. CDE ROTATORS. BELDEN COAX AND ROTOR CABLE. W2AU/W2VS ANTENNA PRODUCTS. BARKER & WILLIAMSON COAX SWITCHES AND DIPOLE KITS. VHF ENGINEERING 2-METER BLUE LINE AMPLIFIERS, POWER SUPPLIES AND MANY OTHER KITS AND W/T UNITS IN STOCK. HAM-KEYS: HK-1 \$29.95, HK-2 \$19.95, HK-3M \$19.95, HK-4 \$44.95 AND HK-5A ELECTRONIC KEYS \$69.95. CES 230A MICROPAD \$44.95 AND 235 MICRODIALER \$69.95. THE NEW AVANTI "ON-GLASS" 2-METER, 220-MHZ. AND 450-MHZ. ANTENNAS IN STOCK. SHURE 444 MICROPHONES \$39.00. 1980 RADIO AMATEUR CALLBOOKS: U.S. \$16.95, FOREIGN \$15.95. PRICES QUOTED IN THIS AD WILL INCLUDE UPS/INS. CHARGES. 73, L. GENE LARUE K3HAM.

LaRue Electronics, 1112 GRANDVIEW STREET, SCRANTON, PA. 18509 - Ph. [717]343-2124

Now from J. W. Miller

DAWA DAIWA CORPORATION

Communications Essentials



RF Speech Processor Model RF-660

Increases talk power with splatter free operation. RF clipping assures low distortion. Installs between microphone and transmitter.

Talk Power: Better than 6 dB
Clipping Threshold: Less than 2 mV at 1 kHz
Clipping Level Adjustment: Front panel control
Clipping Level Indicator: LED's
Monitor Jack on front panel
Frequency Response: 300-3000 Hz at 12 dB down

Distortion: Less than 3% at 1 kHz, 20 dB clipping
Output Level: More than 50 mV at 1 kHz
Power Requirement: External source, DC Volts 13.5 at 50 mA no signal
Dimensions: 90 x 25 x 92 mm; 3.56 x 1 x 3.62 in.



RF Speech Processor Model RF-440

Increases talk power with splatter free operation. RF clipping assures low distortion. Simply install between microphone and transmitter.

Talk Power: Better than 6 dB
Clipping Threshold: Less than 2 mV at 1 kHz
Panel Meter indicates clipping level
Bandwidth: 2200 Hz at 6 dB down
Frequency Response: 300-3000 Hz at 12 dB down
Distortion: Less than 3% at 1 kHz, 20 dB clipping
Output Level: More than 50 mV at 1 kHz
Power Requirement: 115V AC, 60 Hz, 1 W, for self contained AC power supply; or 13.5 V DC, 55 mA for alternate external power
Dimensions: 150 x 70 x 150 mm; 6 x 2.5 x 6 in.

**Exclusive USA agent for these units;
inquiries invited.**

Write for literature.



✓ M92



**J. W. Miller Division
BELL INDUSTRIES**

19070 REYES AVE. ■ P.O. BOX 5825
COMPTON, CALIFORNIA 90224

ALDELCO ELECTRONICS COMPANY

RF DEVICES
2N5913 1.7W 175 MHz \$1.70 2N6080 4W 175 MHz 5.40
2N3866 1W 400 MHz 1.25 2N6081 15W 175 MHz 8.45
2N5589 3W 175 MHz 4.75 2N6082 25W 175 MHz 10.95
2N5590 10W 175 MHz 7.80 2N6083 30W 175 MHz 11.75
2N5591 25W 175 MHz 10.95 2N6084 40W 175 MHz 13.30

OVERVOLTAGE PROTECTION OV-12 Provides protection from runaway Power Supply Voltage. Triggers @ 16V 25 Amp rated, 1 piece moulded unit for 12 Volt DC fused Power Supply \$8.95 OV-5 for 5 Volt PS triggers at 7V \$9.95

ACCUKEYER KIT. Similar to Handbook version. Includes PC Board, IC's, Sockets & all parts. Includes sidetone on board, Iambic operation dot dash memory. Only \$21.95

NEW MEMORY KIT. 1056 bit memory expandable to 4224 bits. 1 2102 supplied. Additional chips \$1.25 each. Led indicator. Adaptable to other keyers. Uses 5VDC. Only \$21.95

Dual digital 12 or 24 HOUR CLOCK KIT. NOW WITH A NEW WALNUT WOOD GRAIN CABINET Model ALD 5-W. Six Big 0.5 Displays. Only \$52.95 12 or 24 Hour Operation — Each Clock controlled separately Freeze Feature for Time Set — Easy assembly for clock and Cabinet.

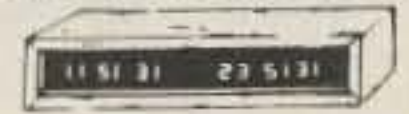

5 Pin Din Accessory Cord and Plug. Fits KDK 60 HZ Crystal time Base Kit \$4.95

ALARM CLOCK KIT. Six 0.5 LED Display Readouts. Elapsed Time indicator. 12 Hour Format with 24 Hour Alarm Snooze feature. AM/PM indicator. Power Supply power failure indicator. Only \$21.95
12 or 24 Hour Clock Kit: 0.5 Display LED's \$19.95
Wood Grain Cabinet \$4.95

TUNABLE AMATEUR TV CONVERTER. Receive Fast Scan ATV in the 420 MHz Band with any TV Set. Low noise high gain Amplifier stage with Varactor Tuned input and output. Built-in 110 VAC Supply. Two Tone Walnut & Beige Cabinet measuring 1-7/8" x 4-1/4" x 4-1/8" Factory Wired & Tested. 2 Year Guaranty. Only \$59.95

Lunch Counter Kit (boards & front panel only) \$14.50
11C90 Prescaler \$19.95 1 MHz crystal \$ 7.95
74C925 Multiplex \$15.95 10-60 PF trimmer \$.60
F9368 Drivers (2) \$15.95 704 displays, each \$ 1.25
Resistor Kit \$ 1.75 Capacitor Kit \$ 6.00

Add 6% for Shipping. Min. Order \$10.00. Out of USA send Certified Check or Money Order. Include Postage.

ALDELCO

2789 A Milburn Avenue, Baldwin, NY 11510
(516) 378-4555

✓ A2 Send 1st class stamp for our catalog.

QUASAR VIDEO TAPE RECORDER SALE!

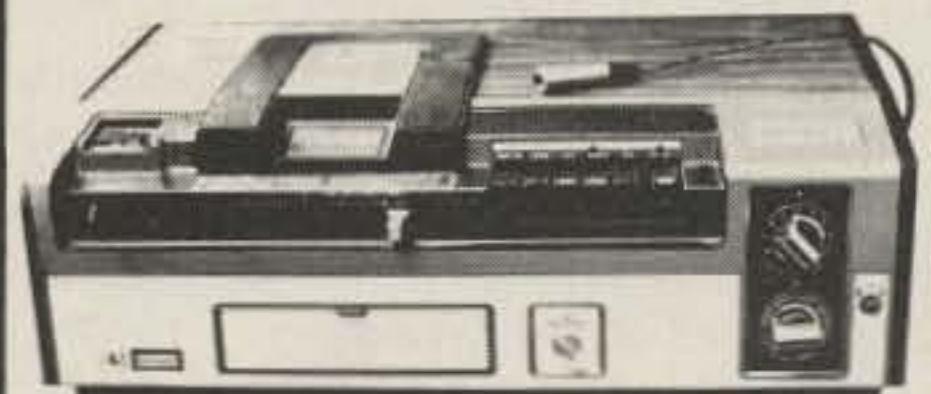

- ★ Records to two hours, color or black & white
 - ★ Records off the air—record one program while watching another
 - ★ Camera input to make your own tapes
 - ★ Can be used with optional timer while you are out
 - ★ Pause control for editing
 - ★ Limited supply—these \$1,000 VTRs were demonstrators & come with new warranty . . . \$499
- \$100 worth of new blank tape will be included at no extra charge!

Send for our new catalog!
\$3 Shipping charge per order • NO C.O.D.s!

Bill: MC Visa

Credit card # _____

Exp. date _____

Signature _____

Name _____

Address _____

City _____ State _____ Zip _____



206 Mystic Ave. ✓ T3
Medford MA 02155
(617) 395-8280

In Search of Power Line Interference

—how to find it and get it stopped

Fortunately for all of us in the United States, there are no minimum limits established for radiation of interference from overhead power lines. Had there been a minimum limit established, we might have had to live with it, no matter how disruptive it was. The Federal Communications Commission is fully responsible for establishing limits of interference for any device that may be causing harmful interference, and at this time, the FCC considers overhead power lines to be "Incidental Radiation Devices." The radiation of interference is incidental to their primary function of transmitting 60-Hz electrical energy. The only requirement the FCC has for incidental radiation devices is contained in Section 15.25, Part 15, of the FCC Rules and Regulations, which reads as follows:

"An incidental radiation device shall be operated so that the radio frequency energy does not cause harmful interference. In the event that harmful interference is caused, the operator of the device shall promptly take steps to eliminate the harmful interference."

The definition of harmful interference is in Section 15.4 (b) of Part 15 of the FCC Rules and Regulations:

"Harmful Interference— Any emission, radiation or induction which endangers the functioning of a radio-navigation service or of safety services or seriously degrades, obstructs or repeatedly interrupts a radio-communication service operating in accordance with this chapter."

Now that you have read the law concerning power line interference (and it amazes me, the number of utilities that profess to have no knowledge of this federal law), what can you do to eliminate RI and TVI caused by gap-type (sparking) sources from power lines and their associated apparatus?

My advice to you is not to sit back after making a phone call to the utility company, registering an interference complaint and expecting the interference to disappear. If you do, you may have a very long wait. There are some power companies which are spending over a hundred thousand dollars per year in their interference programs, but, unfortunately, there are many

which are not meeting moral and legal responsibilities in this area.

I am served by one of only four investor-owned electric utilities in the nation with two million or more customers. It serves approximately 4.5 million people and is the second fastest-growing electric utility in the nation. I make mention of this as it was only two months ago that they purchased a receiver capable of covering all the frequencies between 540 kHz and 30 MHz. I was informed that this equipment was purchased so that they could verify the places I had located and informed them about which were causing low-frequency interference in my area. So don't expect many of the electric utilities to have an all-wave receiver, spectrum analyzer, ultrasonic detector, "Little Snoop" interference locator, yagi antenna interference equipment, loop antenna, etc.

Before going any further, I would like to mention that in many cases of gap-type RI or TVI, the electric company is not at fault.¹ The electric power companies generally are responsible for less than 50% of the sources that cause electrical inter-

ference. (This figure varies, based on the type of program the utility company has instigated for handling interference complaints and how they maintain their lines.) It has been estimated that more than 95% of these power-line sources of interference are due to gap-type discharges. The remaining 5%, or less, are due to corona discharge.

Gap discharges occur on power transmission equipment when metal parts become electrically isolated by corrosion. The parts will then be charged, by the action of the electric field, to different potentials until the gap insulation becomes overstressed, at which time a complete breakdown of the gap takes place. The resultant discharge is termed gap discharge. This gap is usually "operative" during fair weather. As soon as moisture appears, the gap is "shorted out." Consequently, interference caused by gap discharge usually is absent in wet weather. These sources can be located and completely eliminated.

Gap discharges can occur in insulators, at tie wires, in lightning arresters, between neutral or ground

wires and hardware, and in electrical equipment that is defective, damaged, or improperly designed or installed. Gap discharges can and do occur frequently in overhead power lines.

The majority of all interference caused by electric transmission lines, other than line corona, fall into three main categories: (1) improper hardware, (2) faulty apparatus, and (3) physical construction.

The manner and paths by which interference is transmitted to the receiver are the most important characteristics of interference. The interference energy can travel by one, or, simultaneously, by two or three of the following means of transmission: (1) by conductor, via the transformer or by the neutral wire into the receiver power supply, (2) by induction, when the power line carrying the interference energy is near enough to the receiver antenna to be coupled into the receiver, and (3) by radiation, when the energy is transmitted into space with the power line acting as a transmitting antenna. In this last instance, the energy can be radiated from a distant line and be reradiated from a nearby fence, power line, or metallic structure.

Low-frequency interference generally is carried by the first two methods. Conduction currents decrease more slowly with distance along the line as the frequency is decreased. Radiation is generally the cause at high frequencies. Power line interference is roughly in inverse proportion to the frequency. The higher the frequency, the lower the absolute interference level. Above a frequency of 100 MHz, conducted power line interference is quite likely to be only six to ten pole-line spans from your receiver. There have been cases of

radiated power line interference originating from a source as far as 30 miles away. This is the exception and not the rule. Generally, the high-frequency power line noises which will bother you are located less than one mile from your location. If you can see the interference on the screen of your television set, on channel 2, 3, or up to channel 6, the interference source will usually be less than one thousand feet from your QTH.

Since we have touched now on the basic fundamentals of the way power line interference travels, let's see what you can do to track down the location of the source.

For high-frequency noise, you should have a beam antenna—and, preferably, one resonating at ten meters—plus a street map, a 6-pound sledgehammer, and a portable FM receiver. Yes, I said FM receiver, even though you may have been taught that FM discriminates against amplitude noise. On low-frequency noise (160-75 meters), I use a portable AM receiver with coverage from 540 kHz to 4 MHz. Your receiver in the shack must be capable of operating in the AM mode. Listening on a receiver in the SSB position, or with the bfo on, won't permit hearing what the noise sounds like. It is very important to hear the pitch of the noise so that you can distinguish between power line noise and other electrical noise.

Tune your receiver in the shack to a clear frequency, preferably on ten meters. Now turn your beam until the noise peaks (make sure you are not picking the noise up off the back of your beam). Now get your street map out and draw a line on it in the direction your beam is pointed. Get in your car and turn the FM

car receiver on to a clear channel on the low end of the band. (If you do not have an FM receiver in your car, you are in for some walking.) Start driving to the streets you have marked on your map.

As you approach the source, you will start hearing the interference. As the amplitude increases, tune your receiver higher in frequency (again make sure you pick a clear frequency). When you think you have reached the peak noise level, stop your car. Now use your portable FM receiver to locate the pole with the highest noise level. Tap the suspected pole with the sledgehammer. This vibration should cause an intermittent noise in your portable receiver if this is the noisy pole. Report this pole location in writing to your electric utility company as the source of interference.

From experience, I cannot emphasize enough how important it is to reconfirm, in writing, every phone conversation you have with your utility company. Some employees have a very convenient way of not remembering what was discussed. Also, do not hesitate to call them to find out what progress they are making correcting the source of interference. Persistence will pay off.

Tracking down low-frequency noises is an entirely different ball game. I will not go into this method at this time, even though I have been extremely successful in locating these for the electric company. Unless you have a receiver in your car which covers 75 and 160 meters, you are in for a lot of walking. Don't think you can track it down with your AM car radio by itself. What you hear at 540 kHz may not be heard on 75 or 160 meters. Also, what you hear on 75 and 160 meters may not be

heard on the broadcast band. Do not use an AM broadcast-band receiver to track down line noises unless you are well experienced in power line noise technique.

I would like to mention that noises which usually bother all frequencies are generally caused by loose connections, tie wires, lightning arresters, insulators, and hardware. Very seldom are they caused by a transformer. However, most noises generated by power lines that are heard only on 75 and 160 meters are usually from transformers.

Within the past 3 years, I have located 67 sources of power line noise with the above procedure. These locations were reported to the electric utility and 55 have been corrected. (I did have to send the utility company a copy of the FCC rules regarding incidental radiation devices.) The majority of our power line interference has been caused by loose clamps and connections, plus oxidized tie wires and dead-end insulators. A few cases were lightning arresters. 24 of the locations were noisy transformers (mainly caused by a capacity current discharge) that were causing only low-frequency interference. These the electric company replaced. As of this writing, the utility company has work orders written on 12 more noisy transformers that were causing only low-frequency interference.

Since I embarked on this project, my neighbors have a much better image of amateur radio. Many times the power line interference was being blamed on my amateur radio station. One of my neighbors cut my 160-meter antenna down twice, thinking this was causing his TVI when it actually was power line in-

Command Your Frequency

WITH A DATONG MODEL ASP



\$259.⁹⁵

Including Pre-Paid Shipping & Full Insurance
Dealer Inquiries Invited

AUTOMATIC RF SPEECH PROCESSOR

Made in England • 90 Day Warranty • Visa-Mastercharge Accepted

- Gives increased "punch" or "talk power" comparable to a times-ten increase in peak sideband power (SSB or AM) or peak deviation (FM).
- Instant push-button selection of 0, 6, 12, 18, 24 or 30dB of true r. f. Clipping for optimum talk-power enhancement under all conditions.
- No manual input level setting is required; it sets itself, automatically.
- Connects between microphone and transmitter - no internal connections required.
- Unique "TONE" button simplifies transmitter adjustment.
- LO/HI microphone impedance matching.
- Internal or external supply only 15mA at 6 and 16V.
- Eight ICs, eleven transistors, three LEDs.
- Elegantly styled to match any equipment.

Dedicated to Excellence (Exclusive Importers of DATONG FL-1's)

AR Technical Products Corp.

Box 62
Birmingham, Michigan 48012
A105 Telephone 313/644-5698

terference. Many of the neighbors have thanked me for locating the source of the power line interference and for having the electric company eliminate the interference.

There have been some very informative articles published in *QST* and other publications concerning power line and electrical interference. I have listed them below. You should obtain and read them—particularly the first one. Since electrical noises are generated by many sources, one should have the information covered in this article before blaming the power company for the interference.

Although I have been active in amateur radio since the early 1930s, it has been only in the past two years that I have become knowledgeable about EMI. With study and experience, you also can become knowl-

edgeable on the subject. You will experience the pleasure of clearing up not only your reception, but also the reception on your neighbor's TV set. Good hunting! ■

References

1. "Electrical Interference," W.R. Nelson, *QST*, April-May, 1966.
2. "Power Line Interference," Richard M. Smith, *QST*, November, 1959.
3. "Power Line Interference," Robert G. Holloway, *QST*, July, 1970.
4. *The Location and Prevention of RI and TVI Sources from Overhead Power Lines*, Institute of Electrical and Electronics Engineers, 445 Hoes Lane, Piscataway NJ 08854, \$16.00.
5. *Radio Frequency Interference—How to Identify and Cure It*, ARRL publication, \$3.00.
6. *How to Identify and Resolve Radio and TV Interference*, US Government Printing Office, Washington DC 20402, Stock #004-000-00345-4, \$1.25.

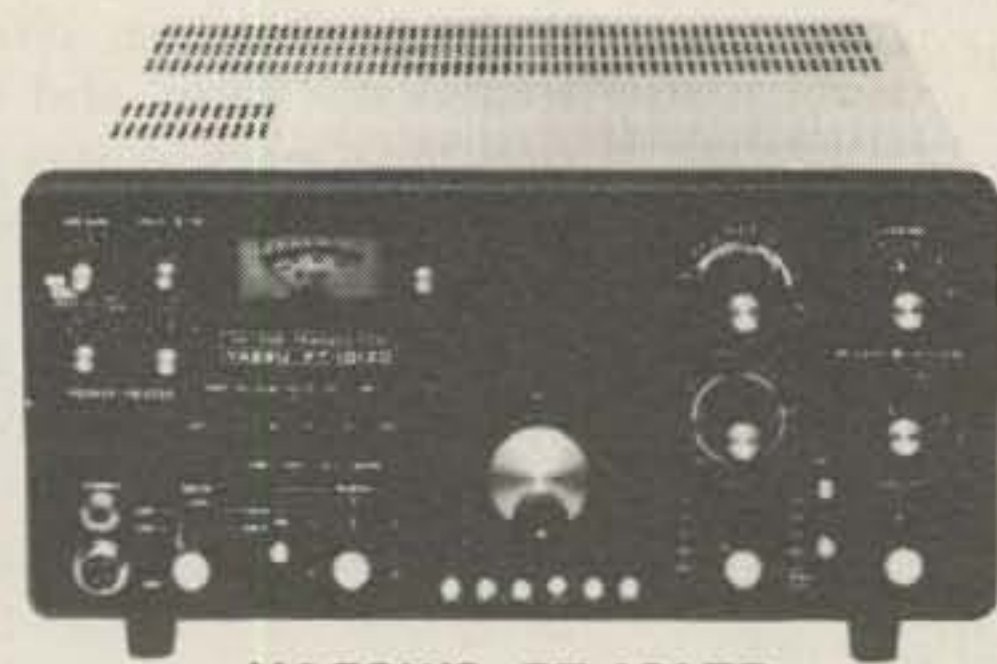

YAESU'S FT-101ZD

Yaesu's FT-101ZD series now at G.I.S.M.O. Variable bandwidth, built-in digital plus analog readout, full coverage, clean output signal, WORLD WIDE POWER CAPABILITY. Interface with 901 series components. Call now!

"Since my XYL discovered G.I.S.M.O. I can't get her out of the shack."

Not long ago, my XYL got her licence. Thought we'd spend more time together if we shared the fun. Then it happened—she discovered G.I.S.M.O.'s toll-free line! Pretty soon she was getting quotes on gear by Kenwood, Icom, Dentron, Ten-Tec and Yaesu and more. Bought that pretty FT-101ZD. Now she's taken over the shack! And the telephone's always tied up because she can't resist phoning G.I.S.M.O. to talk trade. Can't really

blame her, though. My XYL always did have a nose for bargains. Call up Lane Tarleton for Yaesu, Kenwood and more. But don't tell your XYL—you'll never get her out of the shack.

G22
G.I.S.M.O. 1-800-845-6183

In S.C. call 1-366-7157
2305 Cherry Road, Rock Hill, S.C.
29730 (Exit 66-B off I-77)

SOMETHING DIFFERENT

The FT-107 Series with "DMS"*

"It's A Cut Above The Rest"

* **OPTIONAL DIGITAL MEMORY SHIFT ("DMS")**
12 discrete memories. Stores individual frequencies or use as 12 full coverage VFOs (500 kHz each)

- Solid State
- 240 watts DC SSB/CW
- 160-10 meters, WWV
(2 auxiliary band positions are available for future expansion)
- RF Speech Processor
- SSB, CW, AM, FSK
- Built-in SWR Meter
- Excellent Dynamic Range
- Audio Peak/Notch Filter
- Variable Bandwidth
- Full Line of Accessories

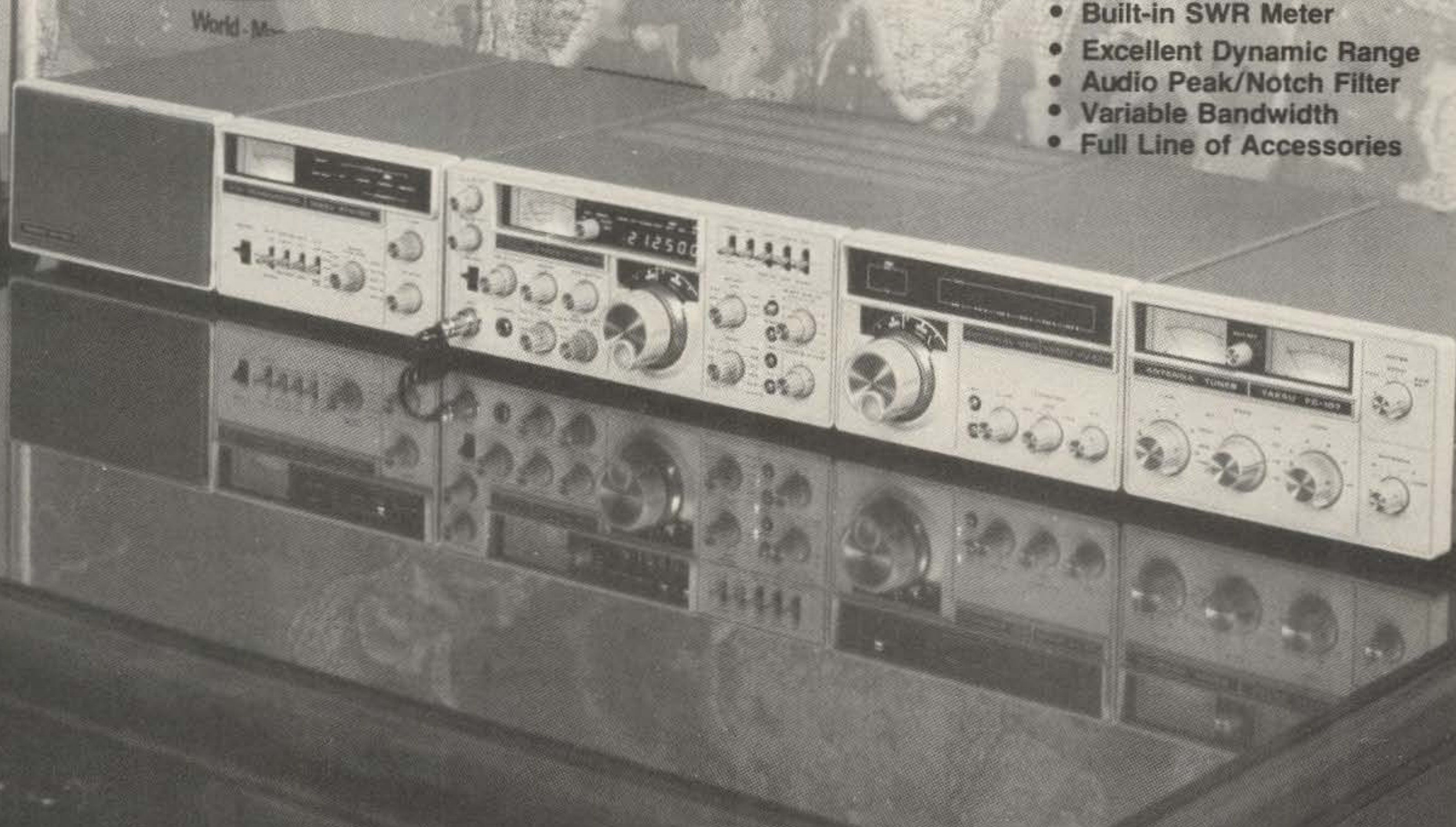

The FT-107 has been created as a result of a blending of technologies — computer, solid state and RF design. By careful utilization of these disciplines and the experience gained from our FT-301 series, YAESU has achieved an HF transceiver which offers unique features (e. g. "Digital Memory Shift"), efficient operation and a level of performance that has been previously unattainable.

(Receiver Section) FT-107 TRANSCEIVER SPECIFICATIONS (Transmitter Section)

Sensitivity: 0.25 μ V for 10dB S/N, CW/SSB, FSK
1.0 μ V for 10dB S/N, AM

Image Rejection: 60dB except 10 meters (50dB)

IF Rejection: 70dB

Selectivity: SSB 2.4 kHz at -6dB, 4.0 kHz at -60dB.
CW 0.6 kHz at -6dB, 1.2 kHz at -60dB.
AM 6 kHz at -6dB, 12 kHz at -60dB
Variable IF Bandwidth

20dB RF Attenuator

Peak/Notch Audio Filter

Audio Output: 3 watts (4-16 ohms)

Accessories: FV-107 VFO (standard not synthesized)
FTV-107 VHF (UHF Transverter)
FC-107 Antenna Tuner
SP-107 Matching Speaker
FP-107 AC Power Supply

Power Input: 240 watts DC SSB/CW
80 watts DC AM/FSK

Opposite Sideband Suppression: Better than 50dB

Spurious Radiation: -50dB.

Transmitter Bandwidth 350-2700 hz (-6dB)

Transmitter: 3rd IMD -31dB neg feedback 6dB

Transmitter Stability: 30 hz after 10 min. warmup
less than 100 hz after 30 min.

Antenna Input Impedance: 50 ohms

Microphone Impedance: 500 ohms

Power Required: 13.5V DC at 20 amps
100/110/117/200/220/234V AC at 650 VA

YAESU Y1 
The radio.

Price And Specifications Subject To
Change Without Notice Or Obligation

1179R

YAESU ELECTRONICS CORP., 6851 Walthall Way, Paramount, CA 90723 • (213) 633-4007
YAESU ELECTRONICS Eastern Service Ctr., 9812 Princeton-Glendale Rd., Cincinnati, OH 45246

Hard Copy from your Xitex Terminal

— when a video display isn't quite enough

Many hams and computer enthusiasts are turning to video terminals to get rid of the noise machines. There are times, however, when hard copy is desirable, and the purpose of this article is to describe how to obtain parallel ASCII data output from a popular video terminal, the Xitex SCT-100 (see 73, December, 1978).

The SCT-100 accepts either ASCII or Baudot serial data, current loop or RS-232, at two selectable baud rates. Obviously, two different printers would be required if both ASCII and Baudot modes are used and if the printers are interfaced with the signal sources. Fortunately, the SCT-100 converts all signal inputs, either ASCII or Baudot, to parallel ASCII; thus, a single printer will suffice for both modes.

The Xitex SCT-100 video terminal board utilizes a single-chip dedicated microcomputer, the Mostek MK3870/14001A/79056, which identifies an MK3870 chip pre-programmed for

video terminal use with either ASCII or Baudot serial data. The MK3870 is a complete 8-bit microcomputer on a single MOS integrated circuit. It executes the F8 instruction set and includes 2K bytes of ROM, 64 bytes of scratchpad RAM, and four 8-bit I/O ports. It requires a single +5-V power supply. All I/O lines are TTL compatible, but each is limited to one TTL load unit.

A partial schematic of how the MK3870 is used in the Xitex SCT-100 is shown in Fig. 1. Port 4 (pins 8-15) is an 8-bit bidirectional data bus used to output parallel ASCII data to the video-screen-refresh RAM and to input parallel ASCII data from the keyboard. Only seven data bits are used for character/control function definition, the eighth data bit being programmed for keyboard strobe input.

Buffers U7 and U15 both enable and buffer keyboard data when U10 pin 31 (KSTB) is scanned by the internal MK3870 firmware.

U10 pin 7 (STRB) is a port 4 strobe, active low when port 4 is used for output. Unfortunately, STRB is also active during other system functions, such as screen clearing, which use printable characters. For use as a printer strobe, STRB must be further qualified to indicate when ASCII data output on the bus is valid for printer input.

U10 pin 32 (K1) is a firmware-generated strobe which, when combined with STRB, will produce the desired output strobe.

With reference to Fig. 1, one IC1 gate inverts STRB to active high, which is then combined with K1 in another IC1 NAND gate. The resulting output strobe (STROBE) is active low and only about 4 μ s wide. My printer will accept a strobe this short, but if yours requires a longer strobe, the optional single-shot IC2 may be added. The other two gates of IC1 invert the respective strobe signals to produce active-high or active-low signals as required by your printer.

Remembering that the I/O lines are limited to one TTL load unit each, I buffered the data lines to my printer with IC3 and IC4. I used 74LS08 AND gates for active-high output and 74LS00 NAND gates for active-low output. One CMOS CD4049 or CD4050 and one unused gate from IC1 or U15 also can be used.

I solved the problem of getting at the required eleven connections (Gnd, +5 V, U10 pins 7, 32, and 8-14) through use of the 16-pin DIP socket, J3, which I do not use otherwise. I had to remove the serial output connection from J3 pin 8. The choice of specific pin connections on socket J3 was arbitrary and has no special significance. Alternately, you can jumper to unused lines on the S-100 edge connector, J4.

I mounted IC1, IC2, IC3, and IC4 on a small PC board near the SCT-100 board. All power is taken from the SCT-100 board.

If you are real fussy about making modifica-

tions on your SCT-100 board, you can escape with having to add only two jumpers. Jumper U10 pin 7 to U15 pin 6, and U10 pin 32 to U15 pin 10. Then, mount U7 and U15 external with IC1-IC4 and connect back to the SCT-100 board with 16-pin DIP plugs in the U7 and U15 sockets.

If your ASCII printer requires serial input, then the addition of a standard UART circuit will turn the trick.

I used the particular chips shown because they were handy at my local Radio Shack. Do not tempt fate with your thirty-five dollar microprocessor by using anything heavier than low-power Schottky chip loads. Bypass the +5-V bus with 0.1-uF discs at each chip. And last, keep the distance from the SCT-100 board to your off-board ICs short: six inches or less if possible.

Incidentally, the MK3870 is virtually a single-chip ASCII/Baudot serial/parallel converter by itself. Costwise, it is competitive with the multi-chip versions. You might wish to consider this if your only printer is a Model 15 or 19 Baudot machine and you need a parallel ASCII/serial Baudot conversion. I have an article in the planning stages on just such applications. I would be interested in hearing about any reader experiences or ideas.

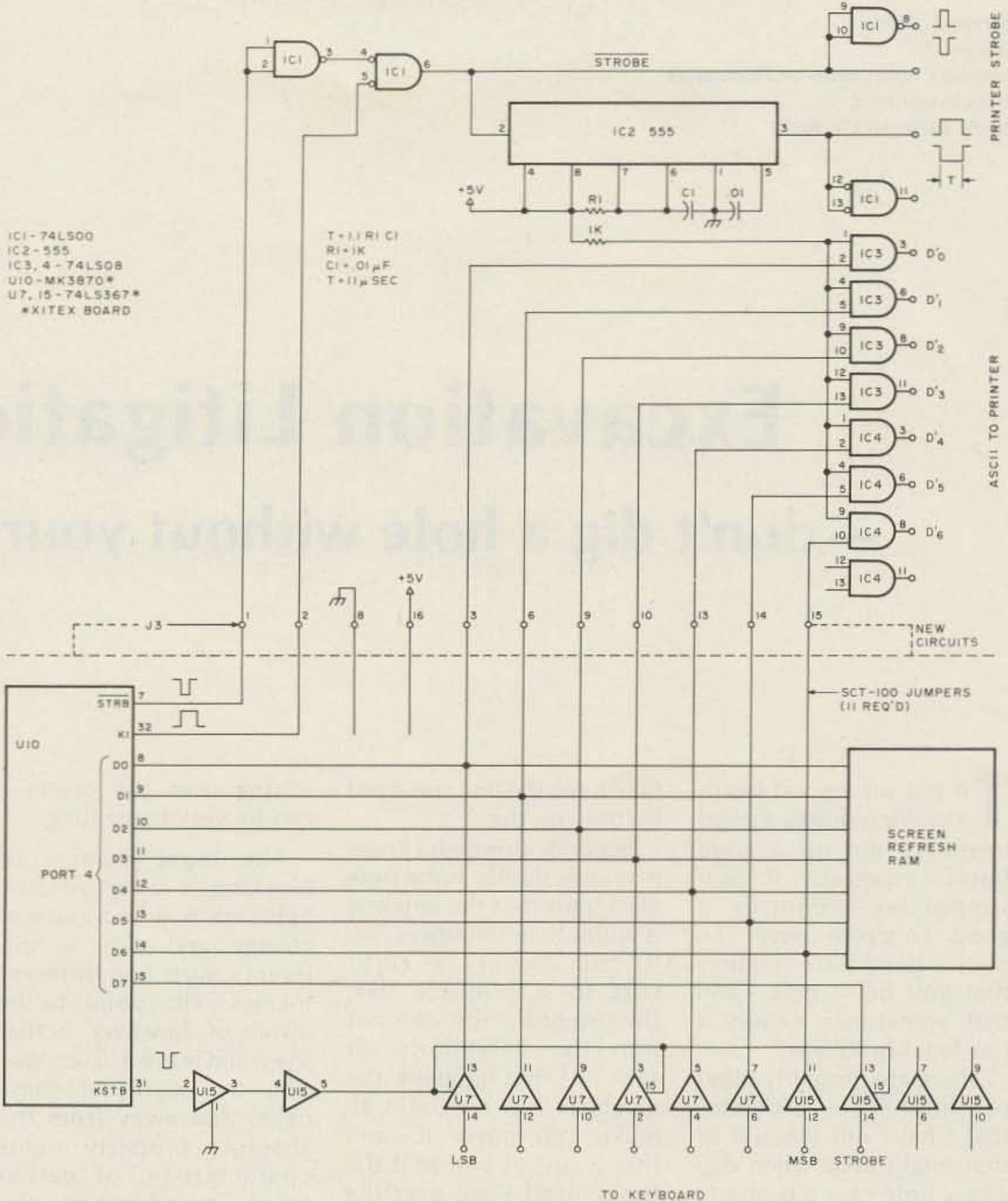

Fig. 1. Partial Xitex SCT-100 schematic showing additional circuits required to generate printer strobe and buffer printer data.

experiences or ideas.

I wish to thank Bob Fer-

rier with Xitex and Mike

Miller with Mostek for their

technical assistance with

this project. ■

There's a new, eighth OSCAR satellite in orbit, and the AMSAT team helped put it there!

Your help is needed for future satellites. Join AMSAT and support the new, advanced Phase III series of OSCARs, engineered to provide communications over transcontinental distances for hours at a time.

Send \$10 membership dues to AMSAT, P.O. Box 27, Washington, D.C. 20044. Life membership is available for a tax-deductible donation of \$100 or more, payable in quarterly installments if you wish.

Phase III satellite solar cells may be sponsored for \$10 each, and we'll send you a certificate specifying the cells you are sponsoring.

For a tax-deductible contribution of \$1,000 or more, we'll even inscribe your name on a plaque to be placed in orbit aboard the Phase III spacecraft for posterity, and we'll send you a replica honoring your contribution.

Dues and contributions may be charged to VISA or Master Charge. Phone us at (202) 488-8649.

Radio Amateur Satellite Corporation
P.O. BOX 27, WASHINGTON, D.C. 20044

AMSAT
AMSAT MEMBER

Excavation Litigation

— don't dig a hole without your lawyer

To put up a good beam usually requires a good tower; to put up a good tower—especially if self-supporting—requires a good concrete base. To pour a good base requires that you dig a hole—and that sometimes causes a few legal problems.

There are probably other potential legal problems that I have not thought of that might arise when digging a hole near a property line, but here are four such problems which have been brought to my attention so far.

Error In Calculating the Property Line

This kind of error can come about in two ways. First, sometimes the property line is not where you think it is, especially on hillside properties. And you would be surprised how expensive it is to move a tower after your neighbor discovers it is on his property and will not let you keep it there! To avoid this problem, if there are no property-line survey marks you can rely on and if the tower is to be positioned anywhere near a property

line, have the line surveyed before you dig.

Second, although I know it sounds dumb, some people forget that the antenna is wider than the tower. So, if the tower is right next to a property line, the antenna could stick out into the neighbor's air space. If that happens, the neighbor has the right to make you move it—and that is just as bad as if the tower itself were over the property line. So do not forget to calculate carefully the radius of the antenna over 360 degrees before planning the tower.

Blocking the Neighbor's View or Sunlight

This problem, too, seems to crop up mainly in hillside properties. It may seem to be the height of reasonableness for the valley dweller with a hillside near his house to place a tower on the hillside and capture a position above the surrounding hills, but to the dweller on top of the ridge, an antenna sticking up at the edge of his yard—so that he has to look between the director and the reflector to see the sun

setting over the ocean—can be very frustrating.

The legal aspects of blocking a view (or sunlight) are now in a state of change and vary in different courts and different locales. The point to be aware of, however, is that the trend is toward recognition by courts of these rights and away from the absolute property rights characteristic of earlier times. The advent of solar power—even in theory, if not yet often in practice—has given an impetus to this trend, as judges, along with other people, have begun to recognize the importance of not allowing sunlight to be blocked or "hoarded" by anyone.

From the radio operator's point of view, the thing to do is recognize the potential problem and try to position the tower and antenna where it will not interfere with any often-used view, particularly some unusual or spectacular view, nor block light to an important area. If there is some problem in avoiding this result, consider other alternatives, such as:

(a) A motorized, or hand-crank tower, to lower the antenna when it is not in use;

(b) A smaller-sized antenna; or

(c) Meeting with the potentially-offended neighbor and obtaining permission to erect the tower on some less offending spot owned by the neighbor. I know of one case where a hillside dweller offered to allow an amateur operator below to put the beam antenna right on the hilltop dweller's house, just to get it out of the beautiful ocean view from his backyard.

Interference With Underground or Property Line Easements

Many property titles are legally "burdened" by deeds to telephone companies, electric companies, cable television operators, and other utilities which give these services various rights. Usually these rights are to install—either under or over the ground—various cables and pipes and often to enter onto the property to replace, ser-

vice, and check these installations. These easements are often so broad that although you "own" the property—and the right to have it included in your property taxes!—you or your predecessor have given up the use of these (usually five-foot) strips.

If you install anything which blocks utility company rights or prevents exercise of the rights granted, you may be required to move your tower. Even if the utility is not using the easement now, it might wish to do so a few weeks after you install the tower, or it might just make difficulties because it is run by people intent on enforcing their rights.

In the western states, you probably can check these easements on a title insurance policy, which often has a map attached to it showing the easement. In the eastern states,

easements are more complicated, and you may have to check with a lawyer to have a basic title search done.

Another aspect of the same problem is the danger of cutting or otherwise damaging cables or pipes when digging the hole. By checking in advance to be sure you are not digging into an easement, you can eliminate your risk of legal liability here. It is not uncommon, however, to find utilities which have run their lines outside of designated easements, so you still may dig up something unexpected.

Causing Damage to the Neighbor's Structure

There are three general ways I have known this to happen:

(a) Mechanical drilling, such as by jackhammer, can cause shock waves potentially damaging to

nearby structures.

(b) Loss of lateral support can cause unexpected (and sometimes almost inexplicable) land movement resulting in damage to nearby structures. In California, there are special statutory duties created which require a person digging near a property line to give advance notice to the neighbor and which create special liabilities for damages which result from taking away lateral support from a neighbor's ground.

(c) By far the most common major problems I have seen resulting from property line excavation are water drainage problems. In an area where there is a rainy season, particular care should be taken not to change any drainage pattern, as the slightest change can cause thousands of pounds of water to accumulate in

unexpected places.

It goes without saying that an equally damaging result can occur from accidentally cutting or blocking a water line or sprinkler feed, as water can build up underground for a long period before discovery.

Have I talked you out of putting up that tower? I have not even mentioned deed restrictions, height limitations, airport clearance and lighting regulations, city permits, covenants running with the land, neighbors running after you with a shotgun, or a host of other problems. I stopped with digging the hole.

Please do not let this discourage you. My only point has been that if you are going to dig a hole, do not dig it very near a property line unless you take special care to avoid the special problems that can arise in that situation. ■

the direct connection

AVANTI • ASTRON • ALLIANCE • ATLAS • ALPHA • BIRD • CUSHCRAFT • COLLINS • CDE • DRAKE • DEN-TRON • HY-GAIN • HUSTLER • ICOM • KLM • KENWOOD • MOSLEY • MICRO-LOG • MOR-GAIN • MIRAGE • MFJ • PALOMAR ENG. • SWAN • TEN-TEC • TAYLOR • TRI-EX • TELE-TOW'R • UNIVERSAL • UNARCO-ROHN ... ALL THESE AND MORE

MIDCOM ELECTRONICS, INC.
2506 S. BRENTWOOD BOULEVARD
ST. LOUIS, MISSOURI 63144

M62

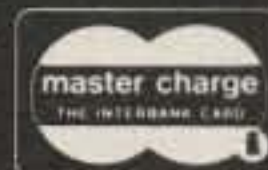

1-800-325-3609

MO. RESIDENTS CALL COLLECT 314-961-9990

Noise Rejector II

— an exciting sequel

The name of the game (particularly on 160 meters for about nine months of the year) is to achieve QSOs through various QRN types and levels—atmospherics, line buzzes, TV and industrial radiations, etc. It is only October through February that nature-made and man-made noises are not the chief deterrent to ham operation on the lower frequency bands, though even on higher bands noises can be a nuisance at times. It has long been easier to QSY upward during the QRN season to escape the problem. And how often—on all bands—are QSOs interrupted by some sort of QRN? To combat the problem successfully, rather than run upward in frequen-

cy in dismay and frustration, I was forced to devise a means of coping with the noise.

QSY-up has not been my favorite tactic in over forty years of hamming. Various loops and low-noise receiving antennas were tried with some success, but there were always drawbacks, such as solid-state circuitry, preamps, etc., getting zapped because of malfunctioning antenna relays or just forgetting to flip the relay switch while gassing away at length on the air. Round tables and DXers just love this sort of thing. Then, too, depending on the time of day, loops often pick up only sky-wave propagation or vice versa. There also have to be adjustments made, such as

tuning, turning, switching, etc. This happens often in the frenzy of a DX pileup. So I tried approaching the problem from the other end, trying many varied devices. Many were built, but I seldom produced a unit which would not materially disturb signal intelligence while overcoming QRN of various sorts. Eventually, I was able to work out circuitry that performed in the manner desired with a minimum of drawbacks. Fig. 1 is the circuit which has proved adequate.

73 Magazine printed my first article on this noise-coping-modifying system in their September, '77, issue. Since that time, several refinements and additions have been made in the cir-

cuitry. This improved circuit has proved most helpful on all bands, and the 3" × 6" × 2½" utility box of the older circuit will take the changes.

As the circuit diagram (Fig. 1) shows, the unit is a succession of af clipper, limiter, filter, and peaking circuits coupled in a simple easy-to-build device. Pleasantly, the circuit layout is uncritical, with common parts used throughout. New parts may be obtained from the catalogs of the big electronics parts supply houses. (I have found all the parts I've needed at neighborhood TV servicemen's supply stores.)

It may be best to begin the project on a 10" piece of 1" × 6" breadboard. This can be fronted by a piece of 3" × 10" aluminum paneling, in order to mount jacks and controls. Breadboarding will give one the opportunity to test the circuit, making adjustments, substitutions, evaluations, and generally improving the project prior to final construction. The circuit values shown in the diagram have suited my particular needs over the years and may serve as an equally good starting point for you. When these values were finally determined and circuit performance was approved, the unit was finalized and made electronical-

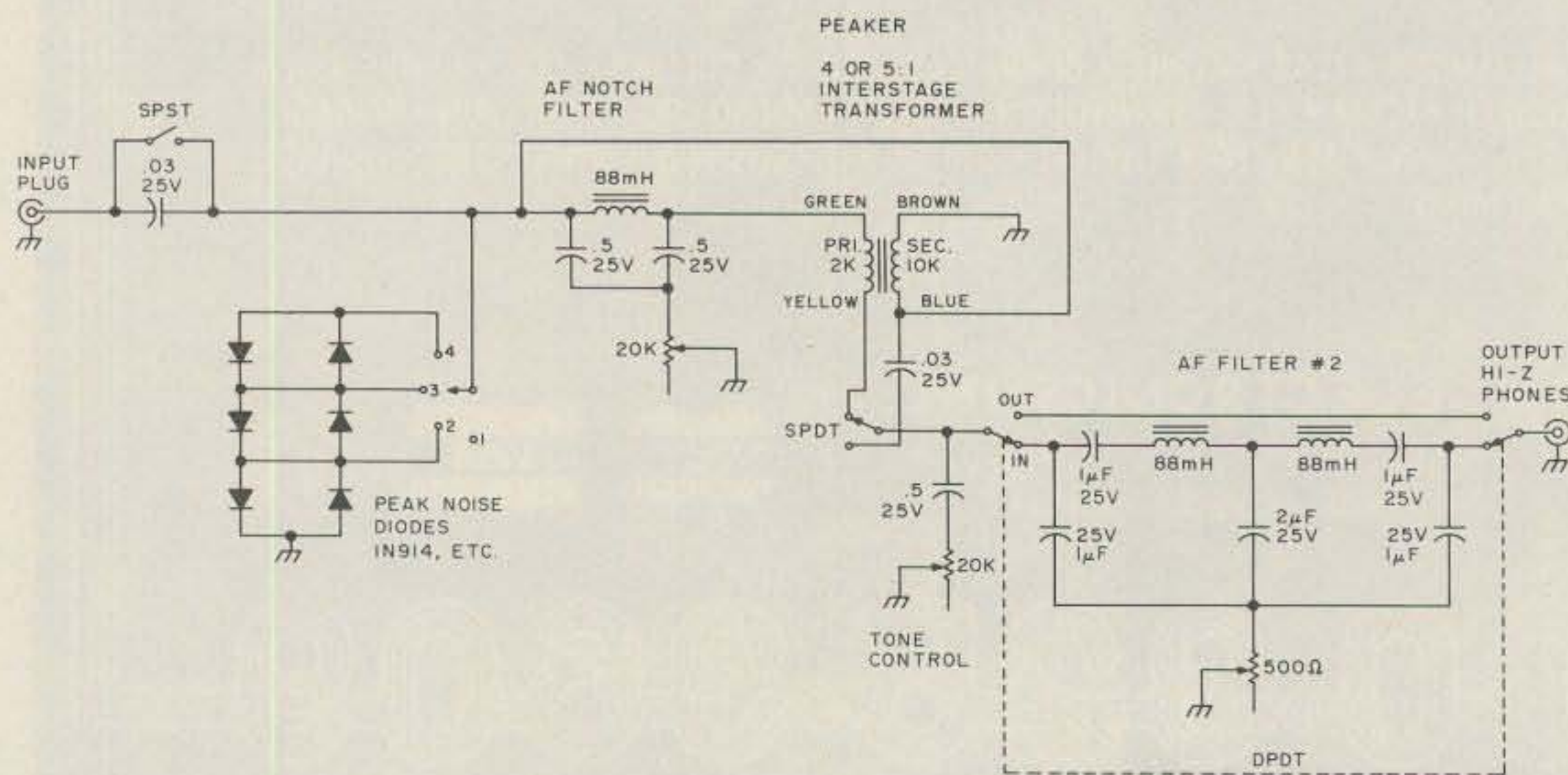

Fig. 1. Circuit diagram.

ly attractive by mounting it in the utility box. A small chassis would do just as well.

Circuit Description

The unit's input phone plug fits into the phone jack of a receiver/transceiver. Hi-Z phones plug into the unit's output jack. The af input feeds into the .03 input capacitor, which is shorted by an SPST toggle switch. This varies the amount of signal/garbage to be passed. When clear atmospheric conditions exist, the switch is put in the closed position so more af can pass any signals and noise. This is particularly useful when copying the weak ones. Other noise can be modified in later circuitry, either by the two filters or by the tone-control, depending on the type of noise. Because signals are just one form of atmospheric disturbance, such filtering devices are designed to overcome noise at the same time that they raise signals to a copyable level. Some circuits accomplish this better than others. This process can be tricky, as the suppression of unwanted noise usually interferes with "good" signals. A slight attenuation is normal, depending on the circuitry. A signal/noise-discriminating circuit is what is needed. There is only slight signal attenuation with this circuit. It doesn't "ring." The signals are lifted above the remaining background noise to a copyable level. Sometimes—under some conditions—the unit effects only

a slight improvement. However, the improvement is usually dramatic, making a QSO possible under otherwise impossible conditions. This logic and unit have proved very successful over the years, dealing with almost all noise types and conditions. As low-noise antennas are often inconvenient, this approach is simplest and most adequate... for this ham.

Cascaded diodes form the clipper-limiter. It clips high-noise pulses in addition to peaks and buzzes at the initial part of the circuit. The clipper-limiter deals with these before signal distortion can get into later circuitry, thus freeing the later circuitry to deal with other types of noises. A four-position rotary switch successively selects the required rejection depth. Next comes af filter #1, an af notch-type filter, which narrows the af passband and exalts and clarifies signals. It is varied by the 20k pot. Like all elements of this unit, this one is also noise-modifying. Then the peaker circuit raises the af level that had been lowered somewhat by previous circuitry. Its transformer primary can be switched in/out, adjusting to still other noise conditions. The tone control handles atmospheric noise most effectively and is probably the most used control in the unit. The final section starts with a DPDT toggle switch which selects or bypasses filter #2. This filter is noise-eliminating as it sharply narrows the af passband, which also contributes to further re-

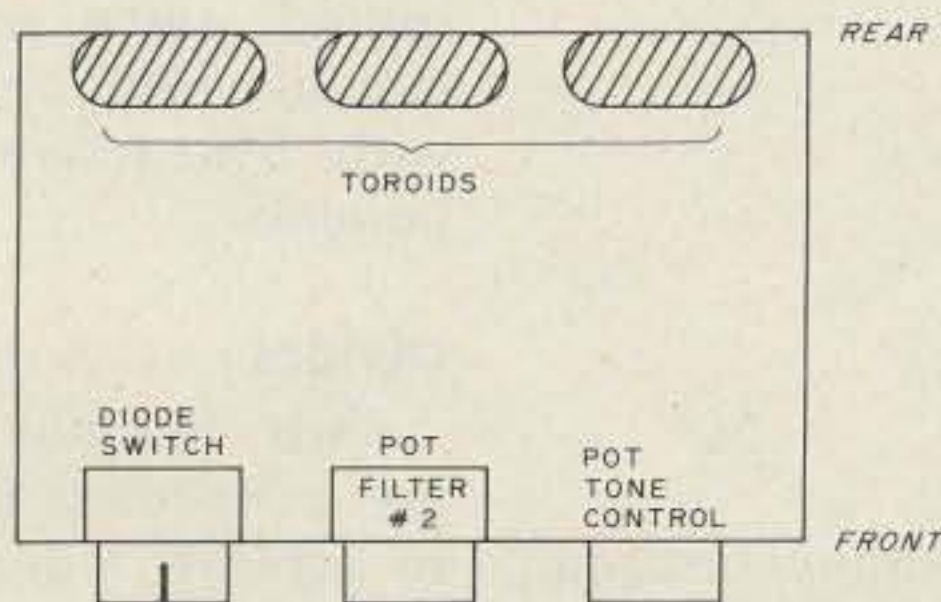

Fig. 2.

DIGITAL MODERNIZATION KIT



\$96.45

Plus \$3.50 ship. & handling
U.S. and Canada - Wash. residents
include sales tax.

THE DMK IS A COMPLETELY WIRED AND TESTED DIGITAL READOUT UNIT, that translates the LMO frequency to a frequency referenced from the HET and BFO oscillators. The DMK has independent calibration for each band. The last two digits are programmed and controlled by the Mode Switch, to correct for the difference in the USB/LSB LMO shift frequency. Both the Counter Clock and the Translation Oscillator are Crystal Controlled. The accuracy of the DMK is determined by the accuracy of your calibration source (Receiver Crystal Calibrator and etc). Installation instructions and mounting hardware is available for the following units:

SB-102 USE DMK-102
SB-300 USE DMK-300
SB-303 USE DMK-303

SB-401 USE DMK-401
HW-101 USE DMK-101
HW-100 USE DMK-100

All DMK's are electronically identical, only the installation instructions and mounting hardware may be different, therefore the DMK will work in units other than those listed above.

Easy step-by-step installation instructions. We will install for \$23.45.

TECHNICAL INFORMATION & PHONE ORDERS:

AL STAGGS, P.E. 1-206-829-0056
Time 0900 - 0200 Local Time

PHONE ORDERS ONLY:

1-206-588-5804
Time 0800-2300 Local Time

PROTRONICS, INC.

MASTER CHARGE

BOX 778
BUCKLEY, WA 98321

VISA

ceiver selectivity. In combination, these circuits increase the range and effectiveness of the unit.

Should you require more audio or desire to get more volume from a speaker, a solid-state op amp could be used, but a larger housing box will be required. I use this unit barefoot, as is, getting completely adequate earphone gain.

While I am sure that this

unit is not the final answer to our noise problems, it still is a valuable step in that direction. At any rate, this is an interesting and helpful approach to our problem. Why not throw these parts on the workbench some evening, and, if you can, improve it. You may be very pleased with its considerable utility, as I have been. See you on 160. ■

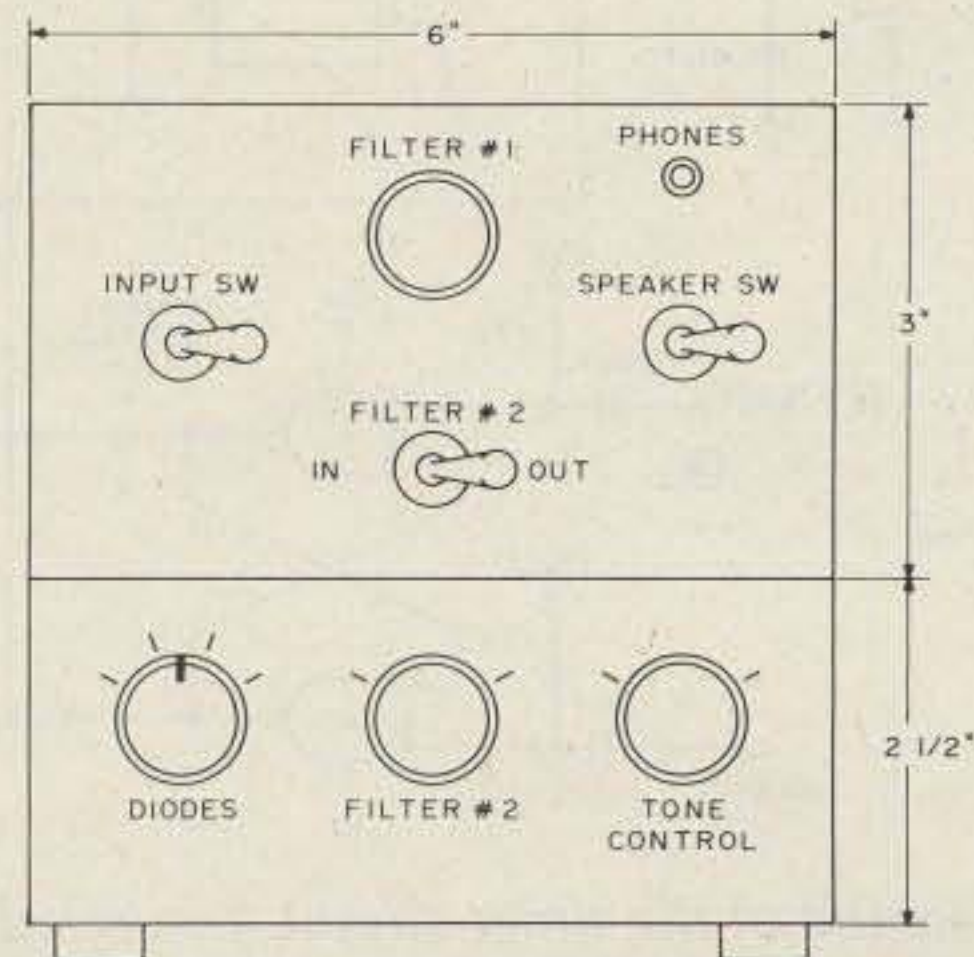

Fig. 3.

Trouble-Free ID Timer

— for repeaters

Does your repeater suffer from an identity crisis? Does it over-identify? If it does, this project is just what you need.

The circuit for this timer evolved from many disappointing experiences with other long-time delay methods used over the years, all of which suffered from glitches on the power or signal lines causing extraneous identifications.

Although the circuit described was designed for a ten-minute timing interval, other intervals can be obtained by changing resistor and

capacitor values. In addition, if a microprocessor is used for control, it can test the timer to ascertain the status and effect an interrupt if desired.

Design Goals

The timer circuit was designed with the following requirements in mind (see schematic in Fig. 1):

1. The timer must be set by a TTL high-to-low transition supplied by the carrier-operated switch.
2. The timer must provide a TTL active-high pulse to initiate the

identification generator circuit.

3. An identification sequence must occur immediately when the repeater is accessed if it has been dormant for longer than ten minutes.

4. An identification sequence must occur once, and only once, during any ten-minute interval while the repeater is in use.

5. The timer circuit must use readily available parts.

Clock

A free-running (astable) multivibrator is used as the clock. It consists of an NE555 integrated circuit and an RC timing network. Values for Ra, Rb, and C were calculated from the following formulas (T denotes the period of the clock):

$$T = 600 \text{ seconds}/100$$

$$T = 0.693 (R_a + 2R_b)C$$

The output of the clock can be monitored by connecting an oscilloscope between TP-1 and ground. Operation of the clock is not affected by the control latch; therefore, a square wave should be observed at TP-1 whenever power is applied.

If you need some other period, the calculated values will probably not work out to be standard EIA resistor values. In this case, use the next higher EIA values. Precision resistors are not required, since satisfactory stability will be achieved with 5% tolerance components.

Divider

Two decade counters are connected in cascade to achieve a divide-by-100 counter. The clock drives the input of the divider

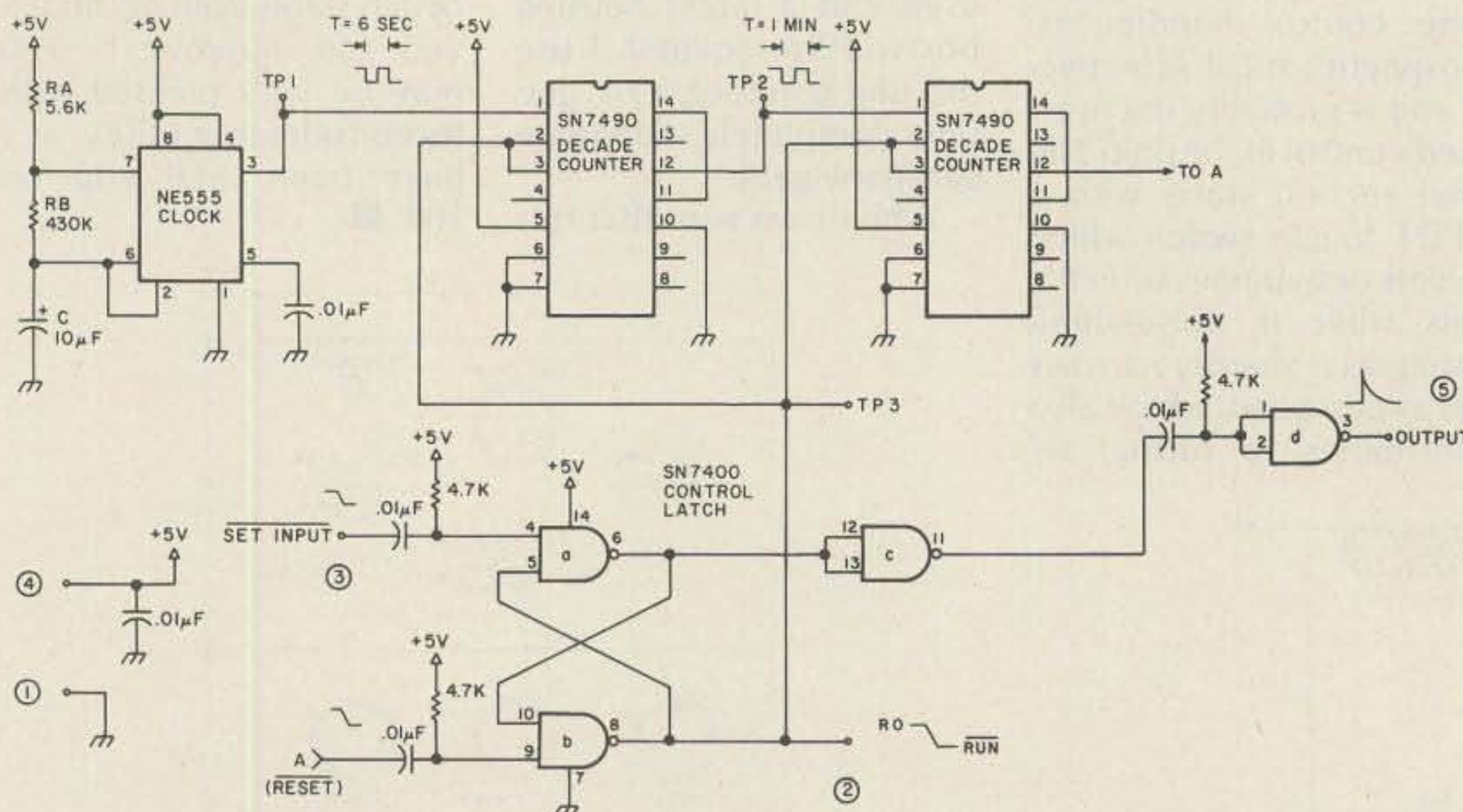

Fig. 1. Schematic of the timer circuit. Encircled numbers are PC board terminal designations. All resistors are 1/4 Watt, 5%. All capacitors are disc ceramic except the timing network capacitor, which is a dipped tantalum type.

chain, and the divider output is used to drive the reset input of the control latch.

Whether or not the divider is allowed to function depends on the status of the control latch. When the control latch is in the reset state, a logic-high condition will be present at pin 2 of each counter. This is a reset-to-zero (R0) state which prevents the counter from incrementing, even though clock pulses are present. When the control latch is placed in the set state, a logic zero is placed on pin 2 of each counter. This permits the counters to increment in response to clock pulses.

Operation of the first counter can be verified by connecting an oscilloscope between TP-2 and ground. A square wave having a period of one minute will be observed when the divider is running.

Control Latch

The control latch consists of an RS latch formed by cross-connecting NAND gates A and B. When an active-low pulse is applied to the set input, the latch is placed in the set state. This causes two events to occur. The output of gate B becomes logic low, which is the run signal for the divider. The output of gate A is inverted by gate C which, in turn, causes gate D to output an active-high pulse which is used to initiate the identification sequence.

Once the latch is set, subsequent pulses at the set input will have no effect on the timer. After the timing interval elapses, which in this case is ten minutes, the divider provides a high-to-low transition to the reset input of the control latch. This causes the control

latch to revert to the reset state and, consequently, the divider is reset to zero. The latch will remain in the reset state until the next set pulse is received; then, the cycle will repeat.

Construction

The circuit was built on a PC board measuring 3-5/8" by 1-1/2" from the artwork shown in Fig. 2. For those of you unable to roll your own, arrangements have been made with Firston Electronics, PO Box 151, Streetsboro OH 44240, to supply etched and drilled boards at a nominal cost. Prices are available for an SASE.

Assembly should proceed quickly by following the component location drawing, Fig. 3. The usual precautions should be observed, such as double-checking the polarity of electrolytic capacitors, inspecting for solder bridges, etc.

Testing

Connect a 5-volt power supply to terminals 1 and 4 while observing proper polarity. Check to verify that the clock is running by verifying the square-wave signal at TP-1.

Apply an active-low pulse to the set input (terminal 3). In order to achieve proper operation, the set input must be nearly +5 volts prior to application of the pulse. Refer to Fig. 4 for suggested methods of accomplishing this. Verify that the latch was set by observing the logic level at TP-3. A logic-high state indicates reset and logic low indicates set.

Connect the oscilloscope to TP-2 to verify that the divider chain is counting when the latch is set.

To verify that an output pulse occurs when the latch

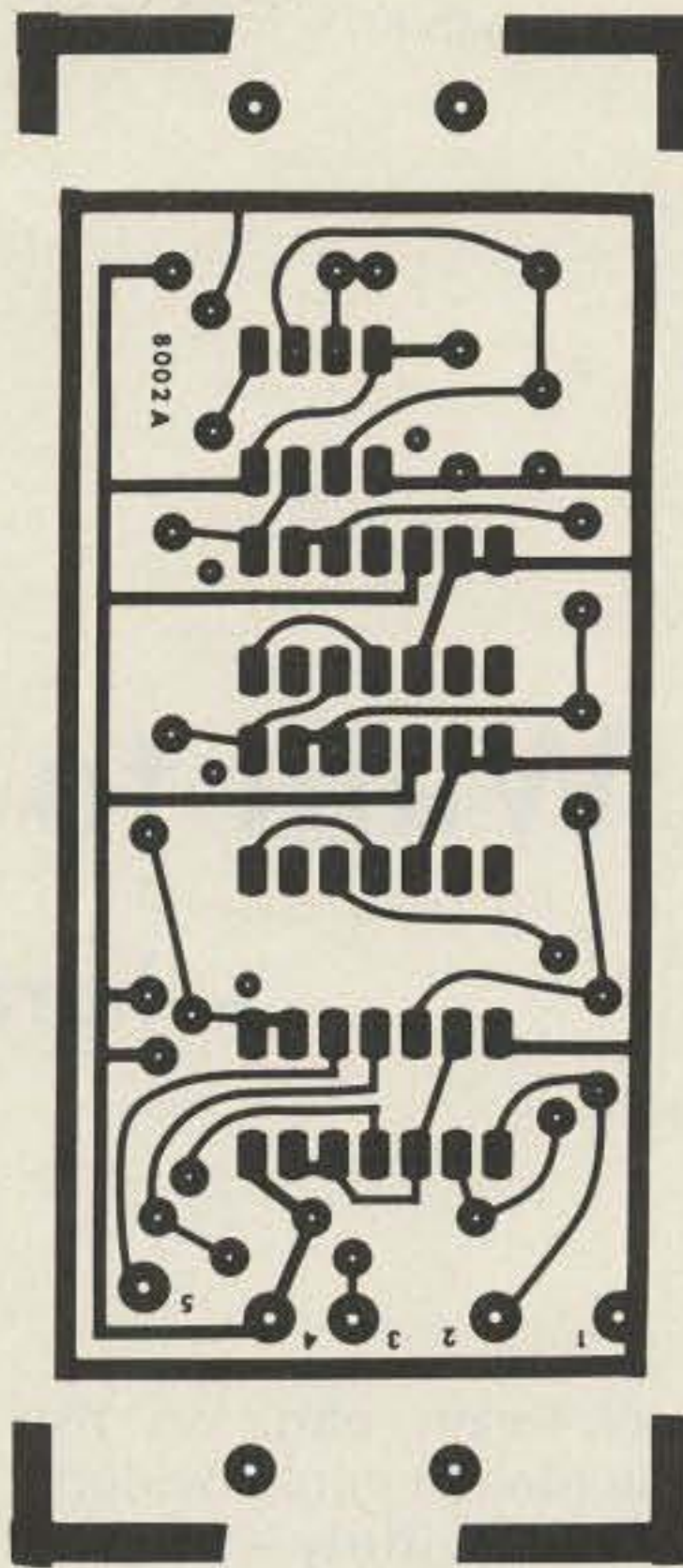

Fig. 2. Actual-size artwork showing the foil side of the PC board.

is set, connect an oscilloscope between terminal 5 and ground. Apply a set pulse and observe a very fast, active-high pulse at terminal 5. Unless you have experience with digital circuits, you may have some difficulty seeing this pulse because of the short duration.

During the testing phase, you may find it annoying to have to wait the full ten minutes for the latch to be reset. You can shorten the timer to one minute by shutting off the power supply and removing one of the counter integrated circuits. In its place, install a jumper wire between pins 1 and 12. Now, the timer interval will be reduced to one minute.

Conclusion

The timer described has been in operation for over a year with excellent results. Elimination of extraneous identifications sure makes the repeater more pleasant to listen to. ■

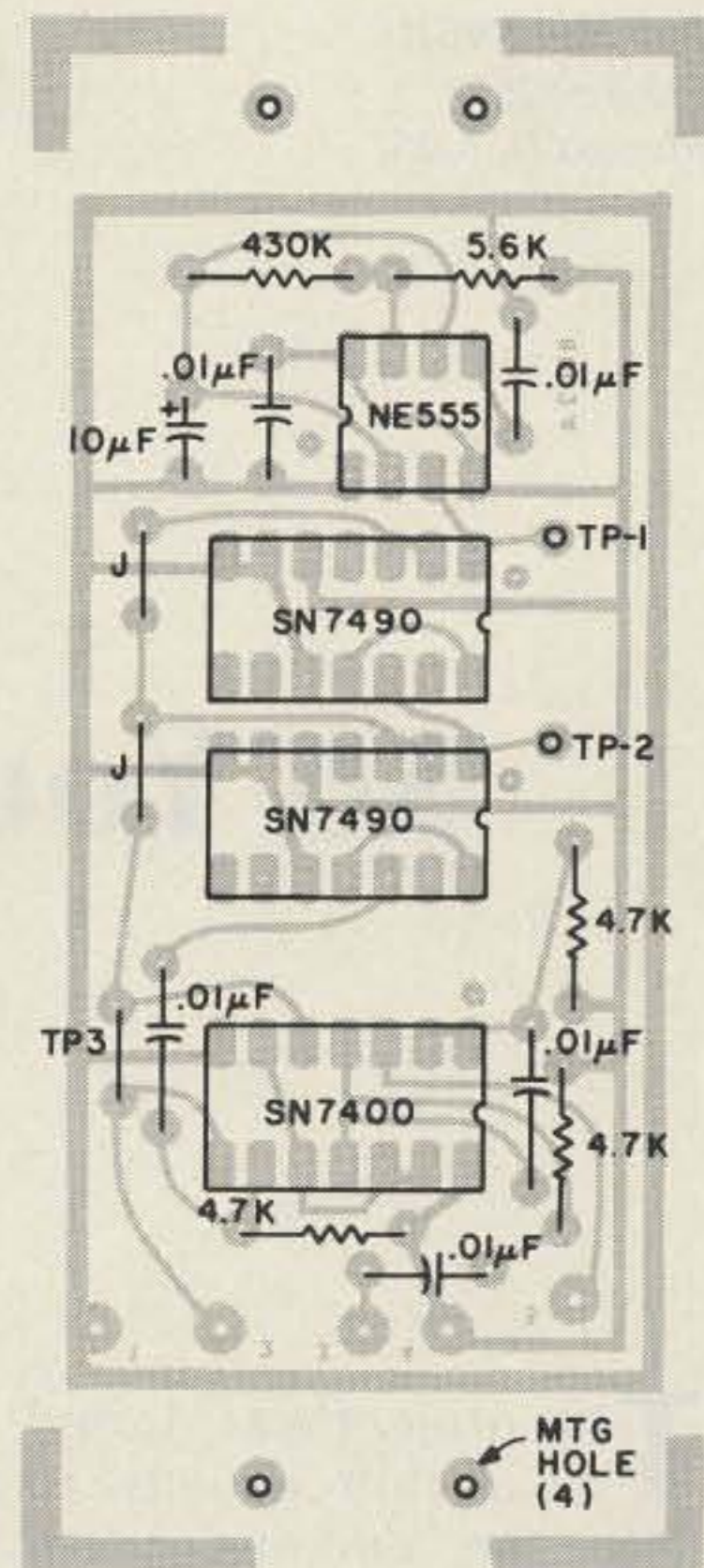

Fig. 3. Component location drawing. A dot is placed near pin 1 of each integrated circuit for identification. TP-1 and TP-2 are made from cut-off resistor leads and have an "eye" formed at one end. TP-3 is a jumper with an "eye" formed in the middle.

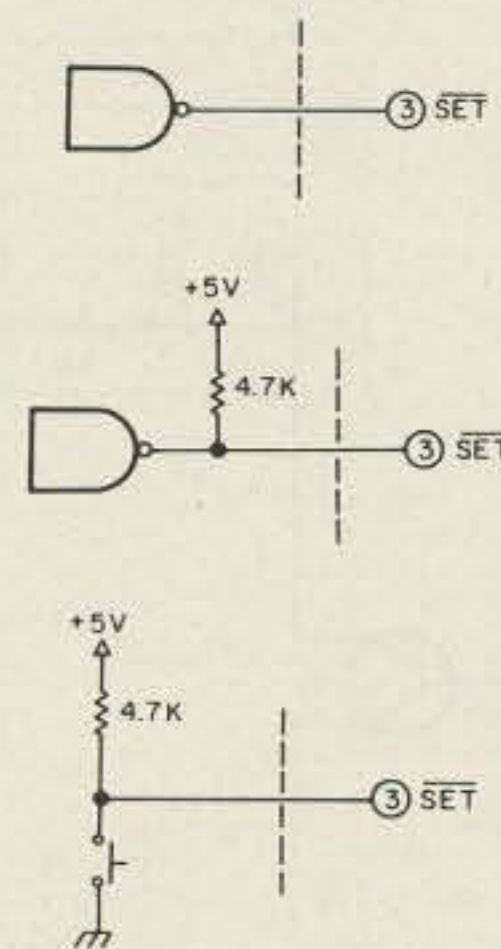

Fig. 4. Totem pole TTL gate, top; open collector, center; hardware switch, bottom. The set input must be held near +5 volts when set pulses are not present. This may require the use of a pull-up resistor if an open collector gate is used to drive this input or if it is driven by a switch.

So You Want to Build a Beacon?

— here's how

This project was started as a club activity to help the two-meter enthusiasts in the Midwest to determine how two-meter propagation varied from day to day. The goal was to set up a 24-hour beacon, battery powered, and vertically and horizontally polarized. This was to be accomplished with very

easy-to-get parts so that the project could be duplicated widely—so that many clubs around the country could follow suit and, perhaps, start a series of beacon systems on the low end of two meters.

The frequency that the Marissa Amateur Radio Club (MARC) set up for the beacon was 144.050. Since

many two-meter operators have only FM equipment, a method was devised so that the signal could be copied with the conventional CW receiver as well as an FM receiver.

Transmitting Strip

The transmitting strip used was one of the one-Watt VHF Engineering

strips. One of their kit versions was used and it was found very easy to assemble and align. Since it would be used to transmit a regular broken-carrier, A1 CW signal, the oscillator and tripler were wired to run all the time while the driver and final were keyed from the identification board. This was done by

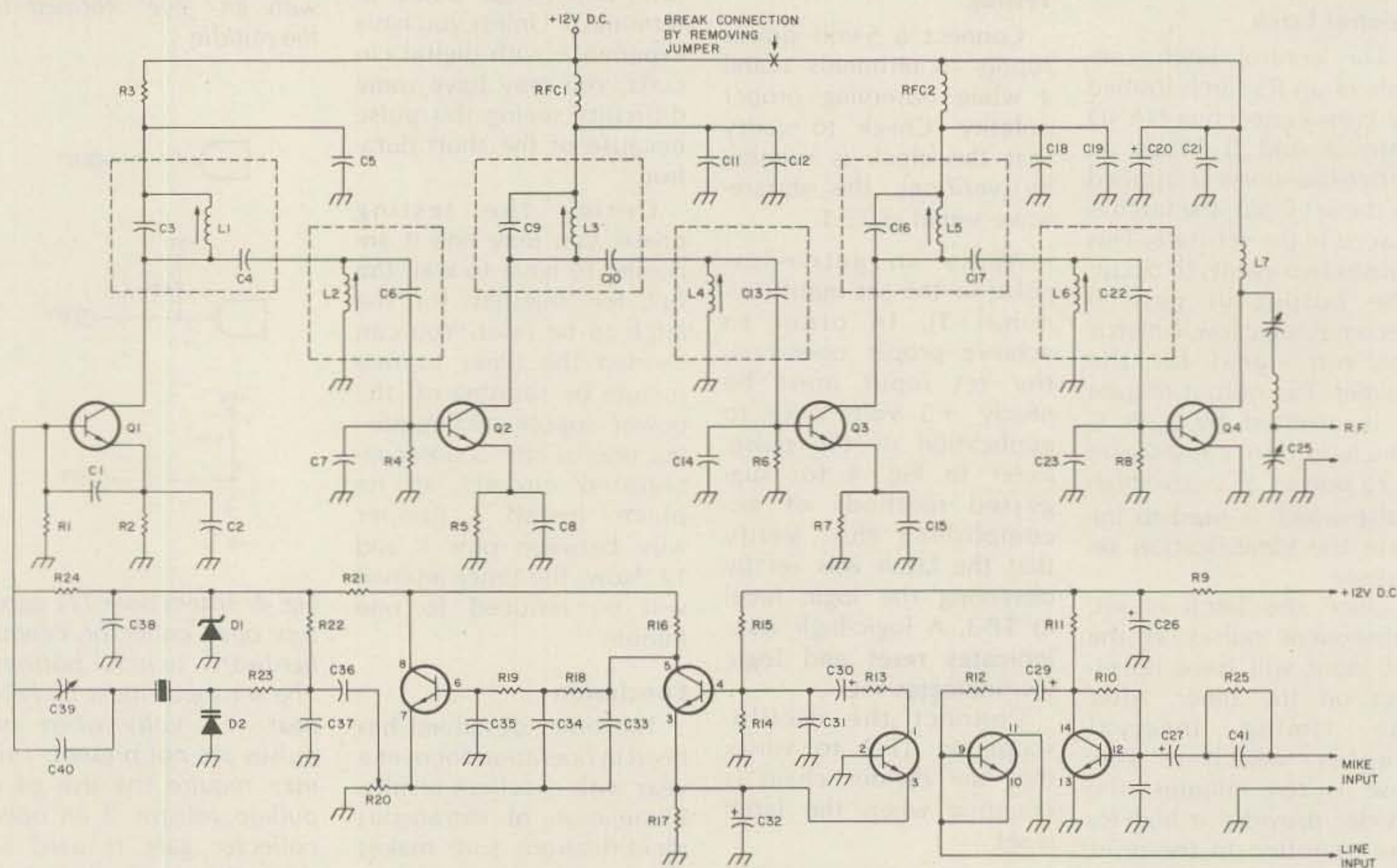

Fig. 1. VHF Engineering TX 144 transmitter.

simply breaking the B+ lead that feeds the driver and final transistors. No problems were encountered. Fig. 1 shows this modification to the regular VHF strip. Fig. 2 shows component location.

CW Ident Board

A system to program the beacon very easily was developed by using one of the CW identification boards from VHF Engineering. This board has a RTTY output which actually is a logic high with each character that the circuit sends. The board is mainly for FM repeater use, and the audio tone from the 555 tone oscillator is used to drive the audio section of repeater transmitters. The system used for the beacon uses *both* outputs. A simple 2N2222 transistor circuit uses the RTTY logic output to drive an electronic switching network that keys the driver and final transistors of the transmitter. This gives us the CW A1 signal for receivers that will be listening in the SSB or CW mode. At the same time this is happening, a very small amount of audio is taken from the normal tone oscillator circuit of the CW ident board to drive the microphone input of the transmitter strip. Adjustment of this audio tone is kept very low so as not to FM the CW signal too much. It takes only a very slight amount of level to make a tone audible when listening to the signal through a regular FM receiver. (See Fig. 3.)

Power Supply

Since we wanted the beacon to run continuously without any failure, it was decided to use a car battery with a charging system so that there would be no need to rely upon the ac line at all times. A small 3-Amp, 12.6-volt regulated dc supply was tapped

across the sealed-type car battery, keeping the battery trickle-charged. The entire transmitter and identification board draw only around 500 mA, so that the battery will run the system for several days should ac power fail. (See Fig. 4.)

An accessory circuit that may be of use is shown in Fig. 5. This circuit senses any 110-volt ac failure, and should the power drop, the battery takes over automatically. When this happens, a low-level beep tone is generated every 3 seconds. This tone is fed to the audio input of the transmitting strip and warns any control operators that the ac power has dropped and the beacon is running on battery power.

This circuit is not necessary but is a nice addition for groups which may have problems with ac power losses. It has been our experience that many operators become dependent on the beacon for checking nightly (or daily) band conditions on two meters; it is best, therefore, that all systems should be made so that power failure will not affect beacon operation.

Control Access

If you remote your beacon, you should have some form of link control to shut the transmitter down should any problems occur. An easy approach to this is to use a Midland 13-509, 220-MHz rig. This is a natural for link use. It takes about one hour to get the unit split up and ready for action. The receiver board is mounted with four screws. Remove the squelch and volume pots and cut out all of the crystal wires from the 12-channel switch. Since you will use it only on one frequency, the 12-channel switch and socket assembly also can be removed.

The transmitter board is left in the original case and chassis. Simply remount

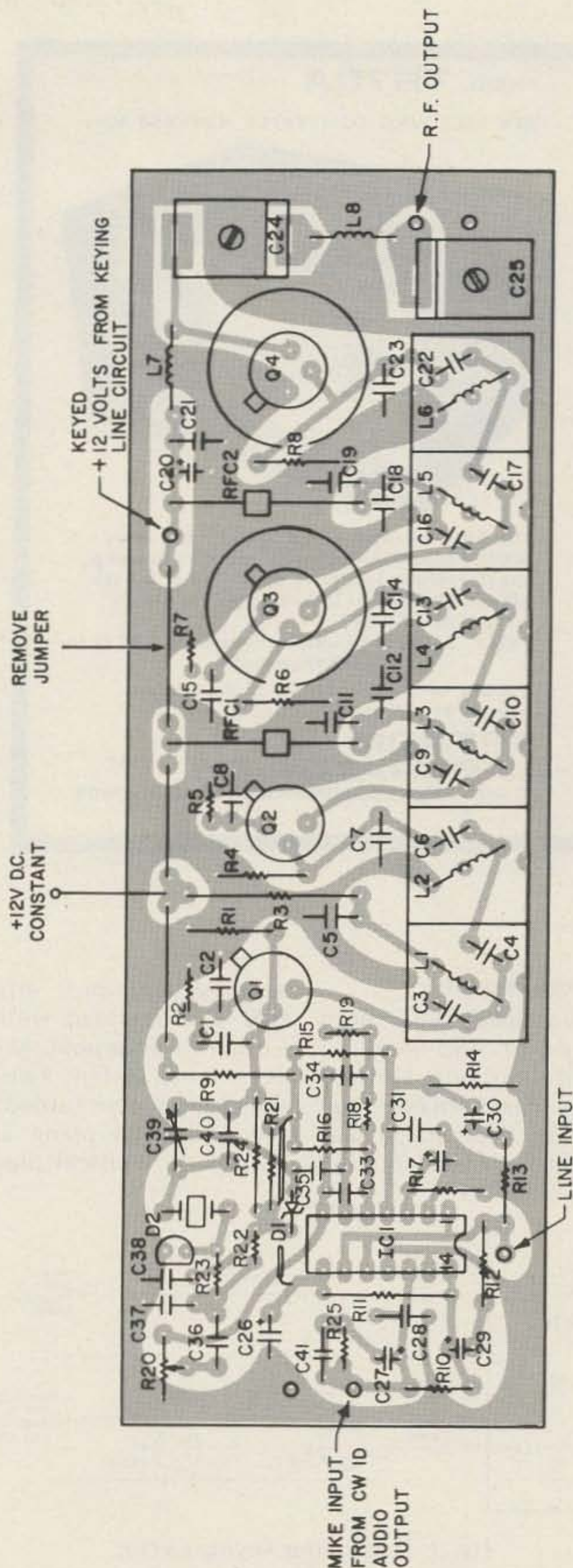

Fig. 2. Component location (component side).

the receiver board along with the beacon equipment and connect the logic system that you choose to do your controlling. This should take care of any link control situations that you might need for this or

any other project. There have been numerous articles in 73 Magazine describing various logic control systems that can be used over the 220-MHz link, so there is no need to cover that subject here.

MODEL TR70A
ATV RECEIVING CONVERTER, 420-450 MHz



- **TUNABLE**-vernier tuned, 420 to 450 MHz
- **HIGH PERFORMANCE**-low noise RF preamp., mosfet mixer, mosfet IF amp. [Ch2 or 3 out]
- **SELF-CONTAINED**-including power supply
- **1 YEAR WARRANTY**
- **PRICE: \$ 88.00** [includes shipping. Add \$ 1.15 for COD shipment]

To order, or receive detailed information, write us or call us at 1-812-336-4775

APTRON LABORATORIES ✓ A6
 PO BOX 373, BLOOMINGTON, INDIANA, 47402

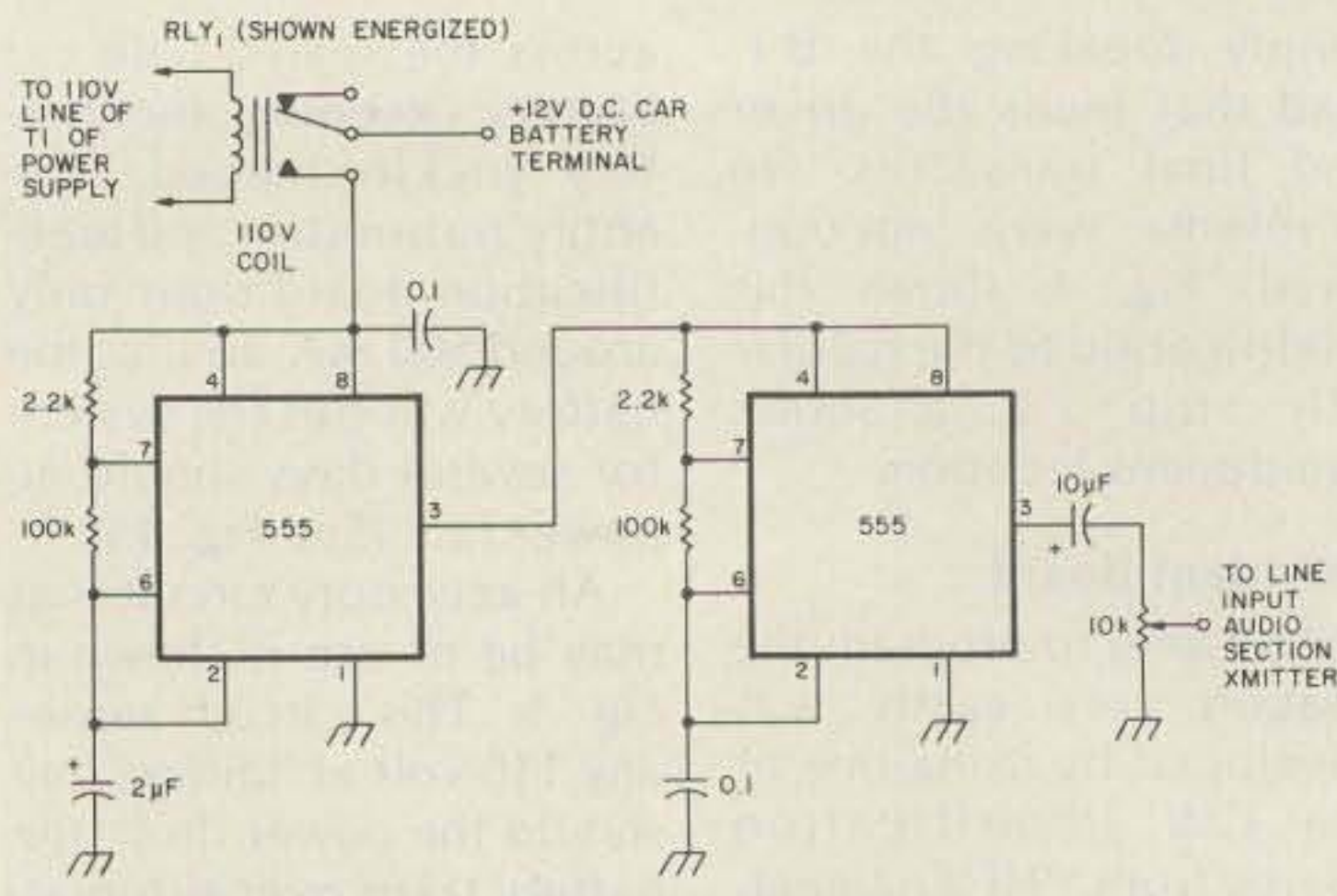

Fig. 5. Power failure beeper.

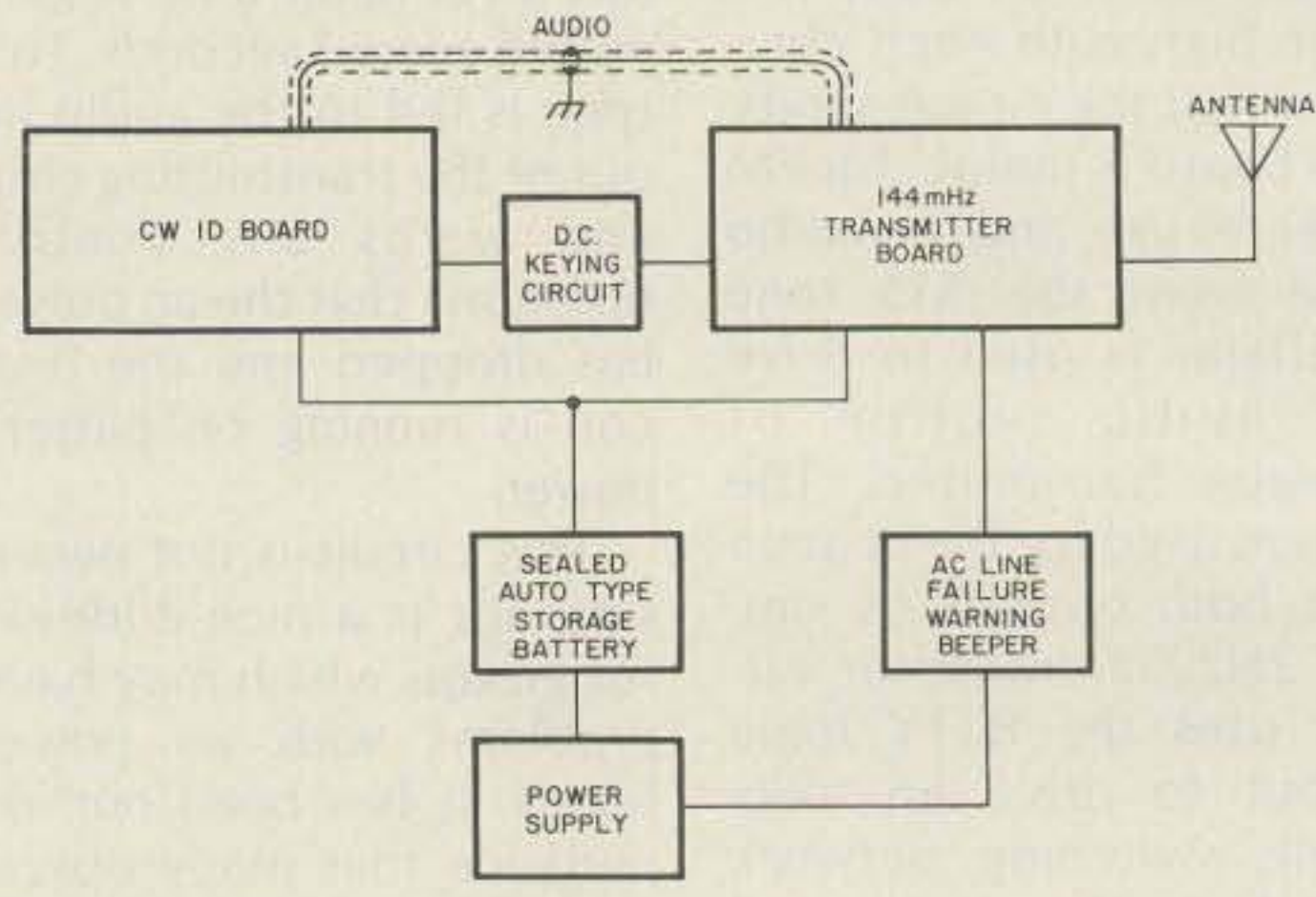

Fig. 6. Block diagram, WD9GOE beacon.

Antenna System

It was decided that both horizontal and vertical polarization must be used to give maximum coverage with the beacon. Several systems were tried, but the

simplest and most effective was obtained with a Cushcraft four-pole AFM-4D antenna system. Two of the dipoles were turned to the horizontal plane and two to the vertical plane.

The regular phasing harness was used, and the antenna seemed to work beautifully. It gave us the necessary pattern with ease in connecting and mounting.

diode matrix could be expanded, but this would be quite involved and really is not necessary since all of the necessary information can be programmed on the regular board.

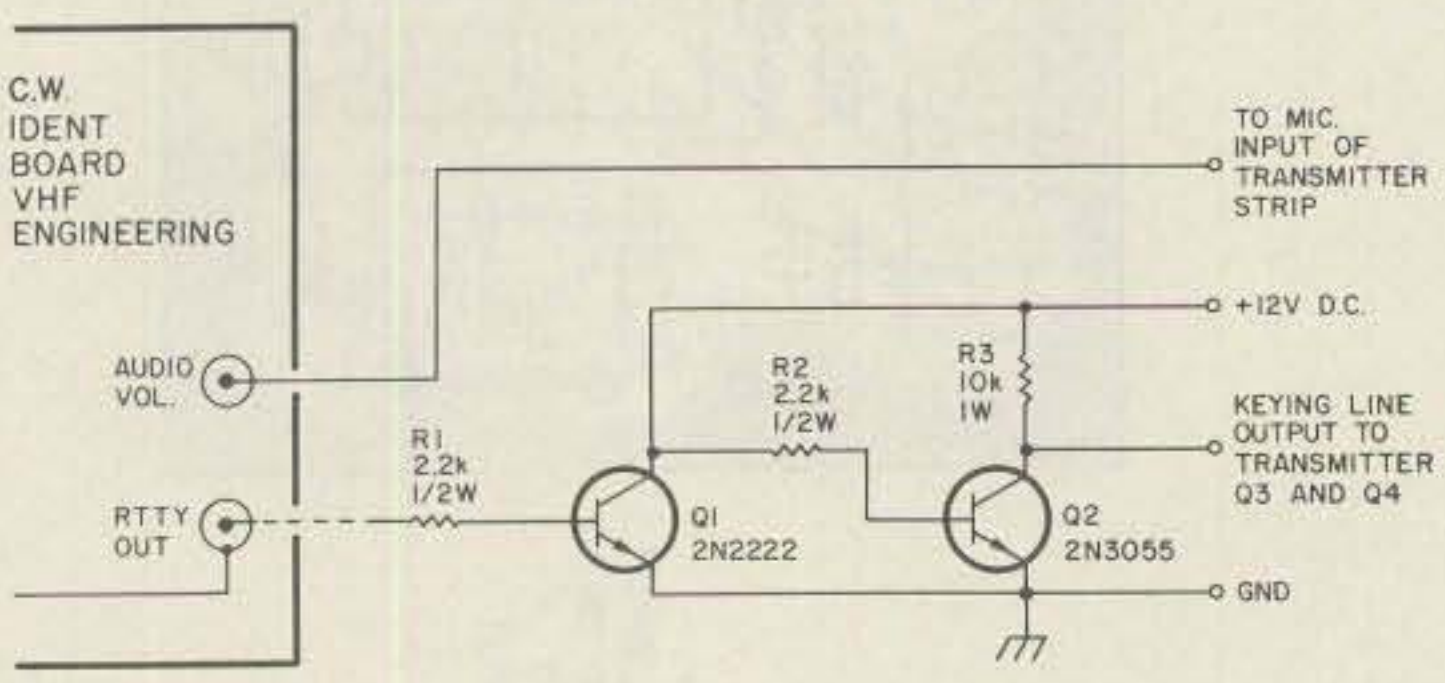

Fig. 3. Transmitter keying circuit.

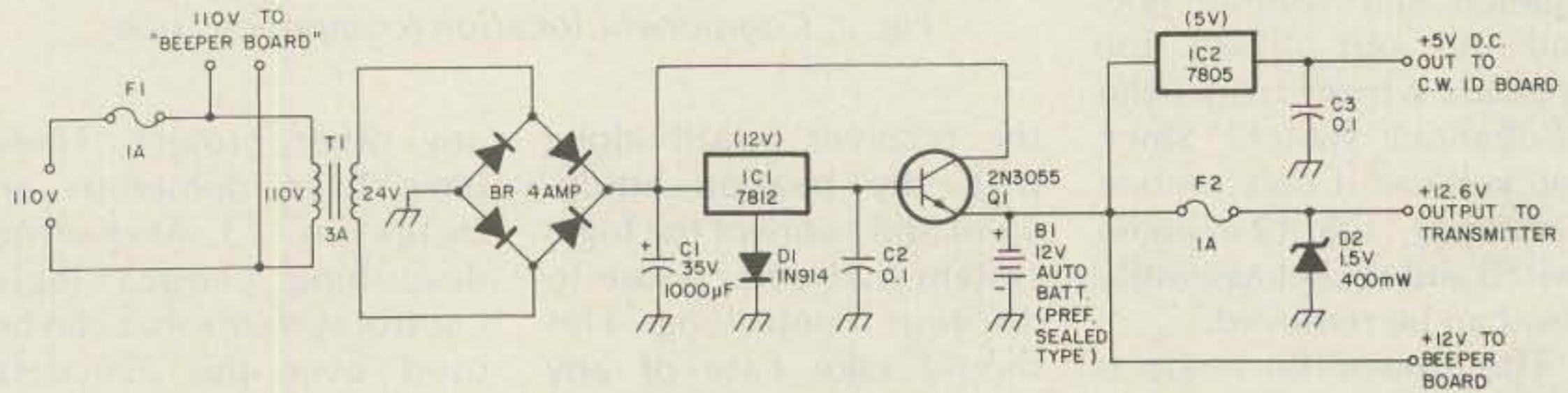

Fig. 4. Power supply for the beacon.

Results

The MARC beacon group has programmed the identification CW board with a long, three-second steady tone followed by the club call, WD9GOE, and the word "beacon." This then repeats after a two-second stand-by. The VHF Engineering CW ident board has just the correct number of bauds for all of this. The

The beacon committee of MARC asked that all stations receiving the beacon QSL to WD9GOE; they were going to send a report to the FCC at the end of December. Several of the reports received to date are from 300 miles out, and many of the SWOT group (Side Winders On Two) have done a great job in passing the word of the beacon's existence. Many of these serious two-meter operators rely on the Marissa beacon to plot a propagation each day. Some of them are even using a time recorder coupled to a tape recorder and are monitoring the beacon on a 24-hour basis so that they can chart the paths. ■

Tomorrow's Technology—Here Today!

THE YAESU FT-207R

The "horse-and-buggy" days of crystal-controlled handies are gone! Yaesu's engineers have harnessed the power of the microprocessor, bringing you 800 channels, digital display, memory, and scanning from a hand-held package. Only with Yaesu can you get these big performance features in such a compact package.

- 4 bit CPU chip for frequency control.
- Keyboard entry of all frequencies
- Digital frequency display.
- 800 channels across 144-148 MHz.
- Up/Down manual scan, or auto scan for busy/clear channels. 10 kHz scanning steps.
- Five channels of memory
- Priority channel with search-back feature.
- Keyboard lock to prevent accidental frequency change.
- Memory backup
- \pm 600 kHz or odd repeater splits.
- Display ON/OFF switch for battery conservation.
- Equipped with rubber flex antenna, wallmount battery charger, earphone, shoulder strap, and belt clip.
- Switchable RF output 2.5 watts (minimum) or 200 mW
- Earphone for private listening
- 2 Tone (Touchtone[®]) Input from Keyboard
- Highly reliable LED frequency display (works in cold temperatures and does not fade with age)



SPECIFICATIONS:

GENERAL

Frequency coverage: 144-148 MHz
Number of channels: 800
Emission type: F3
Batteries: NiCd battery pack
Voltage requirement: 10.8 VDC
 \pm 10%, maximum
Current consumption:
 Receive: 35 mA squelched (150 mA unsquelched with maximum audio)
 Transmit: 800 mA (full power)
Case dimensions: 68 x 181 x 54 mm (HWD)
Weight (with batteries): 680 grams

RECEIVER

Circuit type: Double conversion superheterodyne intermediate frequencies.
 1st IF = 10.7 MHz
 2nd IF = 455 kHz
Sensitivity: 0.32 μ V for 20 dB quieting
Selectivity: \pm 7.5 kHz at 60 dB down
Audio Output: 200 mW at 10% THD

Price And Specifications Subject To Change Without Notice Or Obligation

Hi-Low Power Switch (Bottom of Case)

TRANSMITTER

Power Output: 2.5 watts minimum / 200mW
Deviation: \pm 5 kHz
Spurious radiation: -60 dB or better
Microphone: Condenser type (2000 ohms)

OPTIONS

LC-C7 Leather Carrying Case
 YM-24 Remote Speaker/Microphone
 Tone Squelch Unit
 NB-P9 Battery Pack
 NC-2 Quick Charger

YAESU
The radio.



180

Working with FETs

— part III: the source follower

In part II of this article, I continued a discussion of audio amplifiers which use the FET, the transistor that thinks it's a tube. Let's finish up by examining more of the functions these devices can be made to perform.

Let's look at the output signal from our basic FET amplifier (Fig. 1). Usually it

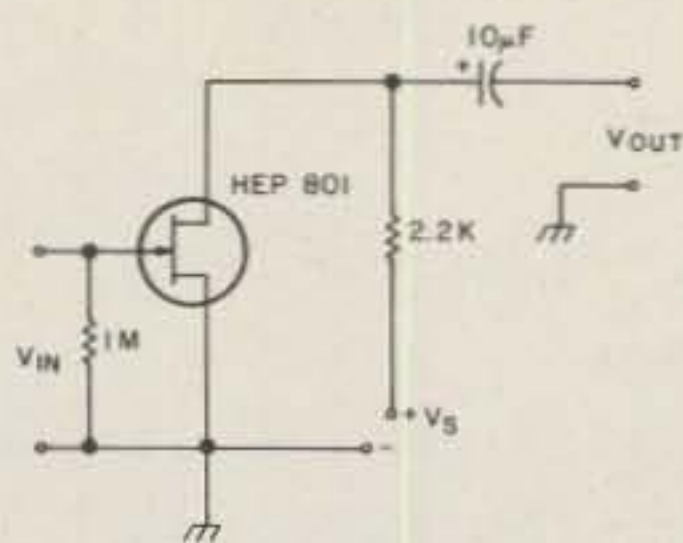

Fig. 1. FET triode circuit.

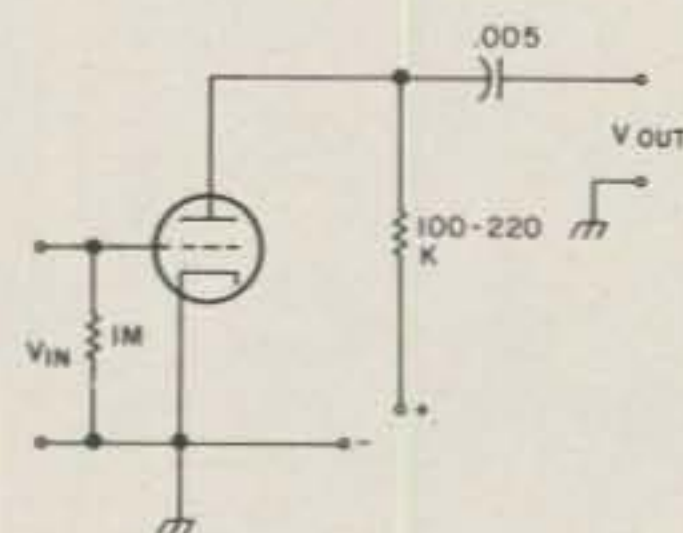

Fig. 2. Triode tube voltage amplifier stage.

is coupled through a medium-value electrolytic, such as 10 μ F. This is higher than the tube circuit of Fig. 2. A word about why: While the input impedance of the FET is high, even close to a tube, the circuit resistances are often lower, such as in the drain circuit. The coupling circuit in an RC (resistance-capacitance) coupled circuit is frequency-sensitive. The resistance and capacitance values form a tuned circuit at audio frequencies.

This is related to the time constant of the R and C combination. As a practical matter, it usually is a factor at low frequencies in interstage coupling. The effect is used in tone controls to form circuits to pass or reject frequencies. It is usually the low-frequency cutoff, however, that is the main factor. This is not so critical for communications use, but you may want to make circuits for other uses.

If the tube circuit uses 220k and 0.05 μ F as its cir-

cuit, then obviously your 10k or 20k, or even less, drain resistance will require more capacitance to do the frequency-coupling job. 10 μ F is easy, but there are circuits where you might want 100 μ F or more for low-frequency use. The output from the FET drain is still considered high impedance, however. There is a low-impedance output stage. In tubes, this is the common cathode follower. In FETs, it's called a source follower. It is so simple you can't miss.

The basic circuit is shown in Fig. 3. The major difference here is that there is no load resistance in the drain circuit and the drain is bypassed to ground. I used 10 μ F for test purposes, but it probably should be more. The input circuit is the same as for the other amplifier, only the output is taken from the source resistor instead of the drain circuit. The coupling capacitor was another 10 μ F. I have lots of them, but here, too, it could be

larger in value for best low-frequency response.

Now then, the resistance value is shown as 2.2k. This is very commonly the same value as for a tube circuit, and it is the same as in the standard FET amp circuit.

A few things about the source follower. The gain is unity. Come again? That means the gain is one, or more accurately, there is no gain at all. In fact, the gain is less than that. You don't ever get as much out as you put in. It usually can run about 95% of the input, though. Now why would anyone go to the trouble of building an amplifier that doesn't amplify? Oddly enough, the circuit is popular because it doesn't amplify. It has other uses. Let's start with its ability to non-amplify.

There are circumstances where you want a circuit to perform a function, but you don't want gain. The source follower is often used as a mixer circuit. In-

puts of various levels are given to the circuit and the output is a smaller signal, but all the inputs come out at the same level. Here gain is not needed, but the ability to control varying signal levels is. This is not the real reason for the follower circuit, however. Its real claim to fame is as an impedance transformer. Here we gain some pragmatic advantage with the circuit.

The normal triode gain-type circuit had a high output impedance. It also had a high signal-output voltage compared to the input. Let's look at what happens to that output when it goes any distance.

The best way to send a signal any distance from the amplifier is with shielded cable of some sort. Right away, we have a problem. Over any appreciable distance, that cable will have a certain amount of distributed capacitance. This will form a trap circuit that will affect the high frequencies. You will start to cut off your audio high frequencies if you use a long cable at the output of the amplifier.

You also will attenuate the signal strength. Sure, your regular amplifier has a higher output voltage than input, but at high impedance, the loss is more as the distance increases. A high-impedance line is also more susceptible to hum and other noise pickup, even though it is shielded.

So, you lose high frequencies, you lose more signal, and you get more hum and noise using a high-impedance output and shielded cable.

That's why you need an impedance-transforming circuit. It takes a high-impedance signal in the gate circuit and turns it into a low-impedance signal at the source. But what does this do for us?

Well, at the lower impedance, you don't have the problem of high-frequency loss that you do with the other circuit. At the lower impedance, you do not have as much signal loss. At low impedance, you stop thinking in voltage terms and start thinking in current terms. You are trying to put some audio power through the cable; even though it is low power, it is not just a matter of signal voltage. Still, your losses will be much less at the lower impedance than the same power at high impedance would be. Also, the lower impedance is less susceptible to stray hum and noise pickup. That is one of the major reasons for using low impedance and why so much fancy audio equipment is geared to a 600-Ohm line or even lower impedances.

What does it mean? Well, if you have a tuner and made the output to the amplifier a high-impedance triode stage, it wouldn't work well when you hooked it up by cable to your amplifier. If you made it a cathode follower or FET or transistor equivalent, you would be able to run a cable of reasonable length and avoid a number of problems. You also may have had trouble when you ran a long cable from a high-impedance microphone to your tape recorder. It picked up hum and noise. That's why many modern recorders use low-impedance mikes. There are some ham rigs that are sporting low-impedance mikes, too. Same reason.

Start with the 2.2k value shown, but play around with a few values to see how the circuit works. You might monitor the current with a VOM so you don't hurt the FET. For most uses, if you go much less in value, you will cut down on the output voltage; you will get much less than the

input. Past a certain value, you will not get any more output from the circuit, so you don't get anything using too big a value, either.

While this circuit is good to work with to learn, I really don't recommend a small-signal FET for this particular application. It's a matter of power. At low impedance, you need more current to drive the line and the FET is not designed for current, or at least this one isn't. From a practical viewpoint, a bipolar transistor would be the choice here, but the operation is much the same.

You might have a finished circuit that has two transistors. Your first stage would be a gain stage, as was described. This would build up your signal voltage. The next stage would be the follower stage. You already have your gain, so its job is to change the signal to a low impedance for the cable. This stage may have a gain control to adjust the actual output. This would allow you to set the output to a specific value.

Apart from cable use or where a long run has to be made, there is one other common use such a stage might have. This would be to change a high-impedance signal to a low-impedance signal to go with a transistor. A bipolar transistor is comparatively low impedance, and you might have too much loss trying to ram some signals right into the transistor.

A FET is sometimes used between the signal and transistor stages to make a better match. The same condition can happen with ICs, too. The follower circuit is a handy circuit to keep in mind. It's so easy to make and work with, and when you need it, you have it.

One other effect was noted during experimentation with the regular amplifier. At a certain point, the

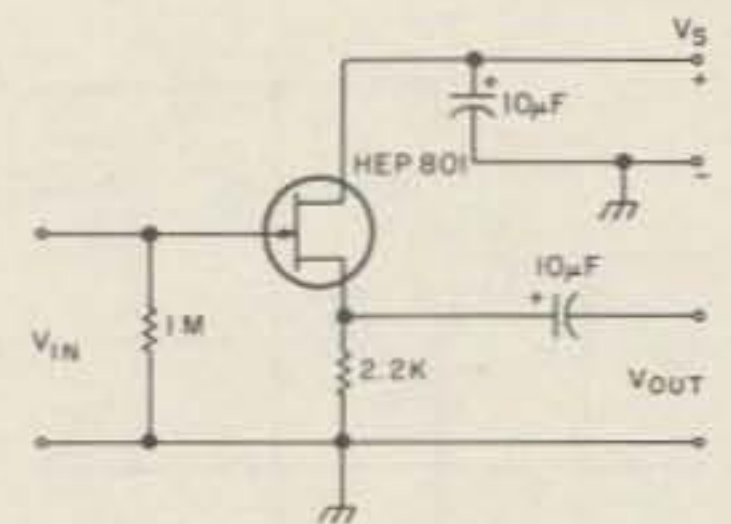

Fig. 3. Source-follower circuit.

output signal exceeded the supply voltage and the signal peaks cut off. Under ordinary circumstances, this is just plain garden-variety distortion, but it does have some useful applications. If you increase the input, the peaks get flatter and flatter. With the best-gain circuit (bypassed resistor), you can adjust the output waveform so that you get a fairly symmetrical square-wave pattern with about 4 volts peak-to-peak input. This is well within the allowable input for the FET, and you get something very close to a square-wave output.

So who needs a circuit that clips the peaks? Well, sometimes it's nice to have square waves, but if you're going to get critical, there are better ways to do that job. There are some applications where this type of circuit is used. It is very similar to the input circuit of many frequency counters. This is often two-stage, the first to give gain, and a clipper stage to precondition the ac input signal so that it looks like a square wave to the ICs to follow.

The FET is high impedance and won't be as much of a load to a sensitive input signal as would a low-impedance IC. There's our impedance match again. This is also similar to the circuits used in musical-instrument amplifiers to get fuzz sounds and long, sustained distortion effects. The square wave will have a fuzzy sound to start with, and, if you really clip hard, the note will decay as the signal decreases. But

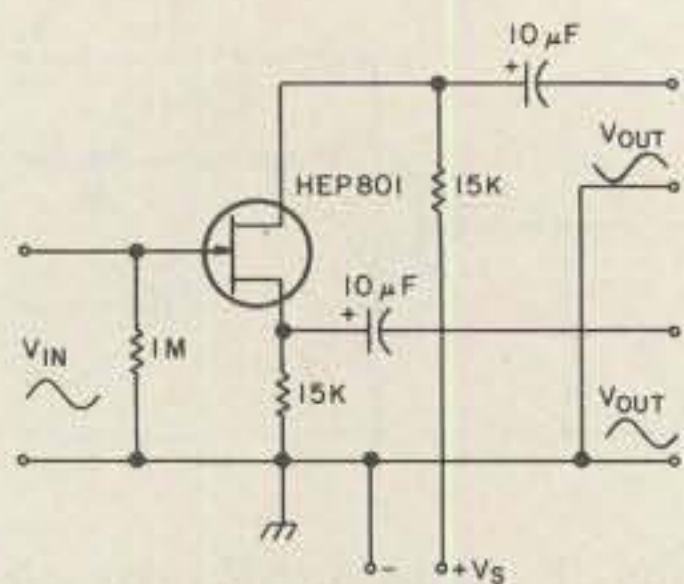

Fig. 4. Basic phase-inverter circuit.

because only a tiny input is needed to get the square-wave output, the same output can continue for quite some time before the note will die out.

Since the square-wave output will remain about the same amplitude for most of the time, it seems like the note just hangs in there forever. Normally, the note would decay rapidly to the ear as the amplitude died down. It's a handy little circuit for some purposes and not too hard to get running. Another one to keep in the back of your mind.

There is one tricky little application of the follower circuit which often has been used in audio work. This is the phase inverter. The output signal of your standard triode amplifier is 180 degrees out of phase with the input signal. The output signal of the follower circuit is in phase with the input signal. Thus you can get two signals that are 180 degrees out of phase with each other. The trick is in how you do it. I played around with adjusting back and forth until it suddenly fell into place and was obvious.

Start with your high-gain circuit values. Make the source resistor the same value as your load resistor and take off the two outputs. You now should be in business—see Fig. 4. I found that the circuit would work with values of less than these, but as you go down, the output voltage goes down, too.

It should be mentioned

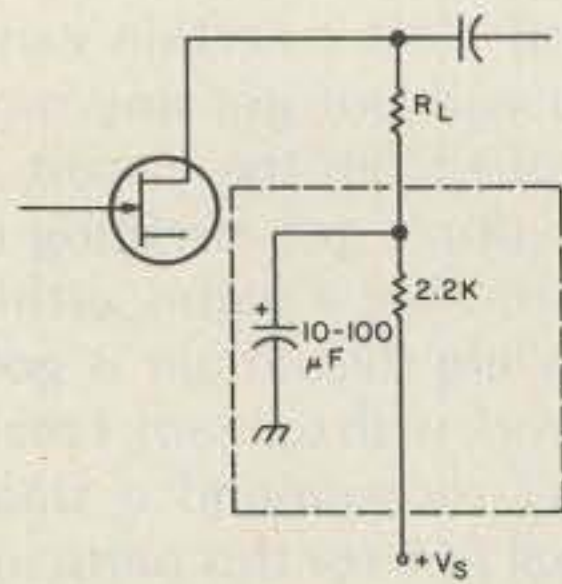

Fig. 5. Decoupling circuit.

that this is another non-gain circuit. It has the characteristics of the ordinary source-follower circuit. The outputs from both points will be slightly less—or more than slightly less depending upon resistance values—than the input. Its function is to split phase, not provide gain. You either get the gain beforehand, or you get it back after the two channels split up.

Still, you have to admit that it is an easy circuit to try. When you are done, you will have a circuit that will give you two outputs that are 180 degrees out of phase with each other. It is the key circuit for feeding a push-pull amplifier stage. There is also a tube and a bipolar equivalent for power amplifier use. If you have a dual-trace scope or an electronic switch for your scope, you can see both signals at once and see the phase difference. With a simple scope, you may not be able to see the inversion, and it will look like something is wrong as you go back and forth between the outputs.

My scope wouldn't show it, so here is an easy test for use with a basic scope. Feed your audio input signal to both the vertical and horizontal inputs. Adjust the controls for a convenient trace size at your normal amplifier input level. This should yield a straight line slanting diagonally across the face of the CRT. If there is more than a little bend, you may have scope trouble. This will show you what two in-

phase inputs will look like.

Now connect the signal to both the input of the amplifier and the vertical input of the scope, and connect the source output to the horizontal input. It should look just like your first test—in phase. Now switch the horizontal scope lead from the source to the drain output. The line should now slant diagonally across the CRT from the other two corners. If both were on at the same time, it would look like the letter X, each output forming one stroke of the letter. If you remember your geometry, the two lines are at right angles to each other and, therefore, 180 degrees out of phase.

You will get the out-of-phase single line also if you connect the two outputs to the two scope inputs, so keep in mind which slant represents in-phase and which represents out-of-phase.

There are other uses for such an inverter besides a class B amplifier stage. Often you will see an input stage for gain feeding this type of circuit.

There is one other common circuit feature which may be most helpful in many applications. This comes under the heading of power-supply filtering, but is usually referred to as a decoupling filter. It serves two purposes: It does the final job you can do on power-supply hum, and it prevents the signal from the circuit from trying to sneak in somewhere else through the supply wiring.

Remember that most of these circuits are used at extremely low levels. This is where any hum or feedback getting in is going to be amplified by later stages and cause all kinds of trouble. Even though the follower circuit is not a gain circuit, it can carry the false signal through just as well.

The circuit is simple—just one additional resistor and a bypass capacitor, as shown in Fig. 5. The resistor is usually a fairly low value. The most popular value is 2.2k, with a bypass capacitance of the same value as the others in the circuit. I used 10 uF because that's what I had a handful of, but I would recommend more than that. 100-uF capacitors are almost as cheap at these power levels.

The filter serves as the final filter in the power-supply lead and also doesn't like to let anything come back the other way from the circuit. At the low current the FET draws, the 2.2k has only slight voltage drop, not enough to bother circuit operation, but it does a great deal to handle hum. If you are having a hum problem, you may even get some benefit from a higher resistance value, but don't just do that as a precaution.

You will be surprised what decoupling can do to some of the crud you will pick up bench-testing. I have a habit of using multi-foot test leads and can't abide a circuit lead less than a foot long, so if the circuit is tame that way, it may work great done right. Then again, it may not, but that's another story. Even a good supply can give you some trouble at that distance, and I found that batteries can be a headache. When they get weak, they are not the steady hum-free power source they are cracked up to be. I have gotten some really inspired feedback and oscillation with the same circuit using batteries, and yet it worked well with the supply.

Ordinarily, I don't recommend putting in parts just in case they might be useful, but there is a strong case to be made for decoupling circuits in

any finished audio circuit you might want to build. That's a decision you will have to make for yourself. I would probably put it into any test gear circuits I made, but I might skimp on some other gear I made.

I found working with the FET circuits one of the easiest transitions to make with solid state. You get the advantage of working with familiar tube concepts, but you also are working with solid state. That can give you the confidence you need while getting hands-on experience with solid state work. While you may not apply these circuits exactly as shown or with this FET, the experience you get working with them will help you with all triode designs, tube, FET, or bipolar. I would recommend playing around with these circuits or breadboarding with a different

FET, if you have one, until you become comfortable working with them.

Your scope and the VOM (for safety) are the key test gear items. Then you can really see what is happening inside the circuit. Almost any available input signal can be adapted for use, but a mike and an audio sine wave (even 60 Hz through a potentiometer) will make it easier.

A few weeks of work with these circuits will give you a feel for operation that no amount of book theory can equal. You will see the effects of troubles and of proper operation, and your impressions will carry over when you work on any gear.

I hope that this has given you a solid, pragmatic tour of circuit operation that will take away a lot of the theoretical mystery about what goes on inside of these standard circuits. ■

Call or Write for Delivery or Quote

RF POWER LABS V-350



Other Models in stock
2 Meter Base Amplifier
15W In — 400W Out

LEAVE A MESSAGE & WE'LL CALL YOU BACK!

MADISON ELECTRONICS SUPPLY, INC.

1508 McKINNEY • HOUSTON, TEXAS 77002

713/658-0268

AG5K, W5VVM, WD5EDE, K5ZD, WA5TGU, WB5AYF, K5RC, K5BGB,
W5GJ, W5MBB, K5AAD, N5JJ, WB5USV.

MASTERCARD • VISA



Lunar's new 2M 4-40P Linearized Amplifier makes your hand-held synthesized transceiver a GIANT!

1 to 4 WATTS IN— 10 to 40 WATTS OUT.

- Can be used with any 1-5 watt radio.
- Linearized so it's compatible with SSB.
- Remote control capability.
- Regulated voltage output as required by the FT 207R and TR2400 to conserve battery pack.
- Turns your 1-4 watt transceiver into a higher powered base or mobile station.
- Made with the quality and care that has made Lunar the leader in linearized amps.
- Has pre-amp for receiver portion to increase power and clarity of incoming signals.
- Amp and pre-amp functions independently controllable.

2785 Kurtz Street, Suite 10, San Diego, CA 92110
Telephone 714 299-9740
Telex 181747

Louis N. Anciaux
WB6NMT



Microcomputers and Your Satellite Station

— part II: ground station antenna bearings

In the first article in this mini-series (January, '80), I described a program for the TRS-80 microcomputer from Radio Shack that takes the drudgery out of computing polar orbit satellite crossings. One of the nice things about cozying up to your own personal computer is that the machine soon loses its exotic aura and you begin to appreciate it for what it really is—a very versatile, general-purpose, problem-solving machine. As far as the

satellite station is concerned, there are lots of other jobs that can be handled quite nicely by a microcomputer. In this second of three articles, we will discuss one of these—the job of computing ground station antenna bearings for receiving signals for geostationary satellites.

Geostationary orbit is a phrase used to define a special category of orbit in which the satellite remains permanently in position

over a given point on the Earth's surface (known as the satellite subpoint). Since the satellite does not appear to move in relation to the Earth below, the position of the satellite as seen by a ground observer does not shift. The satellite appears to remain fixed in the sky, making antenna alignment quite simple. If the proper bearings are known, the antenna can simply be fixed in place. This makes such spacecraft highly useful for relays to ground-

based stations since one doesn't have to worry about tracking large directional arrays.

The trick of achieving a "fixed" orbit is possible because of the fact that distance from Earth determines the time required by a satellite to complete an orbit. It follows that there is an altitude at which a circular orbit would require precisely 24 hours (1440 minutes). This magic altitude turns out to be about 35,900 km (22,300 miles). If we have a circular orbit (located over the equator) with a period of 24 hours and a direction of rotation that matches that of the Earth, we have a situation where the satellite's movement in space matches precisely the rotation of the Earth below, making the satellite geostationary.

Unfortunately for amateurs, we have no geostationary communications satellites now, nor will we have any in our immediate future. The polar orbiting NOAA communications satellites are in orbits with a mean altitude of around

Given:

A (station latitude; + for ° N, - for ° S).

L_0 (station longitude; + for ° W, - for ° E).

L_S (satellite subpoint longitude; + for ° W, - for ° E).

(1) $L = L_0 - L_S$.

(2) $D = \arccos(\cos L \times \cos A)$.

(3) IF $D = 0$, then E (elevation) = 90° and no azimuth bearing is required; if $D \neq 0$, then go to step 4.

(4) Elevation = $\arctan[(\sin(90 - D) - 0.1513)/\cos(90 - D)]$

(5) $C = \arccos[-(\tan A/\tan D)]$.

(6) IF $L = 0$, then azimuth = C.

IF $L \neq 0$, then go to step 7.

(7) Azimuth = $360 - C$.

Fig. 1. Given the geographic coordinates of the ground station (A and L_0) and the longitude of the satellite subpoint (L_S), it is possible to calculate the antenna bearings with a maximum of seven steps as shown above. The reason for the $D = 0$ option in step 3 is that if $D = 0$, you will be right under the satellite and the antenna must be pointed straight up (elevation = 90°). The reason that no unique azimuth bearing exists in this situation will be obvious if you point your arm straight up and then try to determine what its compass bearing is. It's anything or nothing—take your pick!

1400 km (840 miles), and they have orbital periods of about 115 minutes. (In contrast, the moon, which is located almost a quarter of a million miles away, requires a period of 28 days to complete one Earth orbit.)

Weather Satellites and OSCAR

If you would like a taste of what the future holds, simply listen in with an FM receiver on 135.6 MHz while the ATS-1 satellite is doing its thing out over the equator at 140° W. If you think your local repeater is hot stuff, you have yet to hear low-powered stations scattered all over the Pacific Basin communicating with all the advantages of noise-free FM! Virtually all commercial communications satellites (telephone, Telex, TV, etc.) utilize geostationary orbits, as do the GOES weather satellites which transmit their pictures at a frequency of 1691 MHz. (See "Be A Weather Genius," 73 Magazine, November, 1978.)

The problem, of course, is to know where to point the antenna. The *Weather Satellite Handbook* (a 73 publication) presents a simplified graphics approach to determining antenna bearings, and while this approach is adequate for the relatively wide beamwidth yagis used in the VHF range, it is not precise enough for use with the high-gain dishes used for GOES weather satellites or for those never-say-die experimenters who are even higher in frequency who want to snatch first-run movies and other interesting TV fare from the commercial satellites.

The solution to finding precise antenna bearings involves some spherical trig exercises. A most lucid discussion of the mathematics involved is included in an article by Shuch (*HR*, May, '78), which also includes a program for implementing

the equations on the HP-25 calculator. An ordinary scientific calculator can be used to solve the equations, but you do have to watch the mathematical progression quite carefully, lest you get lost! Programmable calculators are a big advantage, but they require loading the program prior to execution, and you do have to follow the associated instructions carefully as to loading data and registers.

A microcomputer is an ideal tool for these calculations because its programming can be made interactive. All you have to do is supply data for some very specific questions, with any special notes actually incorporated in the program. Since the program can be loaded from cassette, you eliminate the time and possible errors associated with manual program entry in a programmable calculator.

See the box accompanying this text, which deals with the mathematical approach taken in bearing calculations. All this is derived from Shuch's article.

The Computer Program

Since one of my aims is to interest you in the applications of consumer microcomputers (without requiring a second mortgage), the program is such that it will run on a machine with only the minimal 4K memory and the bottom-line Level I BASIC. As we shall see, it can be done quite easily, although I had my doubts at first. If you have a TRS-80 with Level II BASIC, there will be little problem with this series of calculations, as the Level II dialect incorporates the various trig functions directly. My goal in this series, however, is to show how to get the best possible use out of the less expensive Level I BASIC.

The problem is that since Level I does not have integral trig functions, you must use subroutines which

Calculating Antenna Bearings

The calculation of the antenna bearings has been organized into a series of seven steps in Fig. 1. I won't go through an explanation of the exercise in trigonometry because it is explained very well in Shuch's paper. Although it may look difficult at first glance, you can run off a demonstration exercise on any pocket calculator equipped for trig functions. Let's run through a sample, using the following set of data referenced to GOES E (Fig. 3).

Station latitude (A) = 45° N.

Station longitude (L₀) = 85° W.

Satellite subpoint longitude (L_S) = 75° W.

Following through with the steps of Fig. 1, we would proceed as follows:

$$(1) L = (85) - (75) = 10.$$

$$(2) D = \text{arc cos} [(\cos 10) (\cos 45)].$$

$$= \text{arc cos} [(.9848) (.7071)].$$

$$= \text{arc cos} (.6964).$$

$$D = 45.864^\circ.$$

D is not really so mysterious for the non-math types — it is simply the hypotenuse of a spherical triangle and happens to represent the angular distance between the ground station and the satellite subpoint. With a few more operations (and the use of a constant), we can use this distance to compute the elevation angle for a spacecraft at geostationary altitude.

(3) If D should happen to be 0, it would mean that you were living under the satellite and would require a 90° elevation angle with no worries about azimuth. Obviously, our D is not equal to 0, so we must plug on to step 4.

$$(4) \text{Elevation} = \text{arc tan} [(\sin(90 - 45.864)) - .1513] / \cos(90 - 45.864)].$$

$$= \text{arc tan} [(\sin(44.136) - .1513) / \cos(44.136)].$$

$$= \text{arc tan} .6963 - .1513 / \cos(44.136).$$

$$= \text{arc tan} .5451 / .71769.$$

$$= \text{arc tan} .7595.$$

$$\text{Elevation} = 37.22^\circ.$$

After that expression, moving on to the azimuth calculation is a piece of cake.

$$(5) C = \text{arc cos} [- ((\tan 45) / (\tan 45.864))]]$$

$$= \text{arc cos} [- (1 / 1.0306)]$$

$$= \text{arc cos} - .9703.$$

$$= \text{arc cos} - .9703.$$

$$C = 166.01^\circ.$$

(6) If L is equal to or greater than 0, then C is our azimuth. Since 10 (L) satisfies this condition, then azimuth = 166.01° (true).

Now, if all you want is one or two bearing sets, you can go right ahead and use the manual technique, or even adapt it to a programmable calculator. If you want to be able to snap the calculations off for other operators, or need the convenience of being able to run a set of bearings off quickly (as I do), then the computer is the answer. In my case, I run a small business, building satellite ground station hardware. Finding antenna bearings for geostationary satellites is a service that I provide for customers who purchase antenna hardware. It was simply getting to be too much trouble to program the HP-25, and I decided to put the TRS-80 computer to work.

Radio Shack kindly supplies in the back of the Level I user's manual. The required trig subroutines used up almost half the available memory, so some

work was needed to fit a completely interactive program into the remaining memory. The resulting program just fits (only 577 bytes are left over); it is

shown in Fig. 2. I will not attempt to go through the program step by step, but I will make a few observations.

First, although the general program structure parallels the manual problem-solving procedure, a more extensive array of variables is used to adequately slide in and out of the various subroutines. On occasion, other dodges are used to get around limitations in the trig subroutines.

Second, be sure to type it exactly as printed—particularly with the 30XXX subroutines. If you don't, you will run out of line in some cases. Also, there is a bug at some point in the arc sin subroutine that is required to run the arc cos subrou-

tine. I never could determine where it was, but it affects the calculation of all negative arc cos operations for numbers larger than .707—resulting in a situation where the resulting value is the same as if the number were positive—not so good. In any case, a small addition was made to take care of this problem, so be sure to type it as shown.

Hopefully, Radio Shack will remove the problem in future editions.

Using the Program

After the drudgery of pounding out numbers on a calculator, the computer run is a breeze. Once in RAM, the program actually executes as quickly as the

HP-25 version. With the computer, however, you have no instructions to consult, nor need you double check to make sure that the correct number is loaded into a specific register. All you have to do is answer some simple questions for the first run, with even simpler entries into later runs, if desired.

When you hit RUN for the first time, the computer will print out the heading data (I love bylines and wouldn't dream of burying the brag lines in REM statements) and then ask for the name of the spacecraft. Once you enter this, it will ask for the station longitude, satellite subpoint longitude, and, finally, the station latitude. The machine then rapidly computes the bearings and prints them as shown in Fig. 3. Fig. 3 is, in fact, what you should get if you plug in the data used for our sample calculation.

Note that following the

data printout, you are presented with three options, terminate program, get data for another spacecraft, or get data for a new station.

If you enter 0, the program ends. If you hit 1, the computer retains the station location data and asks for the name and subpoint longitude of the new spacecraft and then goes on to display the data. If 2 is entered, the computer retains the spacecraft name and location, requests the new station longitude and latitude, and then displays the bearing data. If the requested spacecraft is out of range, the computer will announce that fact and give you the three options.

Summary

Despite the fact that it occupies most of the 4K memory, the program can be loaded fairly quickly. Once on line, it is as fast or perhaps faster than a programmable calculator. The

Fig. 2. Interactive program, written in Level I BASIC for the TRS-80 microcomputer, for the computation of antenna bearings for reception of signals from geostationary spacecraft. Data required to run the program are the satellite subpoint longitude and the longitude and latitude of the ground receiving station.

```

10 CLS
20 P."GEOSTATIONARY SPACECRAFT ANTENNA"
21 P."BEARING PROGRAM"
22 P.
23 P."BY DR. RALPH E. TAGGART"
24 P.
25 IN."WHAT IS THE NAME OF THE SPACECRAFT";A$:CLS
30 P."LONGITUDE AND LATITUDE ENTRY NOTES"
31 P.
32 P.TAB(10);"W LONG. IS ENTERED AS A POSITIVE NUMBER"
33 P.TAB(10);"E LONG. IS ENTERED AS A NEGATIVE NUMBER"
34 P.
35 P.TAB(10);"N LAT. IS ENTERED AS A POSITIVE NUMBER"
36 P.TAB(10);"S LAT. IS ENTERED AS A NEGATIVE NUMBER"
37 P.
38 IN."ENTER STATION LONGITUDE";M
39 IN."ENTER SPACECRAFT SUBPOINT LONGITUDE";N
40 IN."ENTER STATION LATITUDE";K
100 L=M-N:P=.1513
110 X=L:GOSUB 30360:Q=Y
120 X=K:GOSUB 30360:R=Y
130 IF (L=0)*(K=0) THEN E=90:GOTO 180
140 D=Q*R:GOSUB 30520:D=Y
150 X=90-D:GOSUB 30376:F=Y-P
160 X=90-D:GOSUB 30360
170 X=90-D:GOSUB 30690:E=C
180 E=E+.05:E=INT(E*10)/10
200 X=K:GOSUB 30320:Q=Y
210 X=D:GOSUB 30320:R=Y
211 IF (L=0)*(K>0) THEN I=180:GOTO 500
212 IF (L=0)*(K<0) THEN I=0:GOTO 500
213 IF (K=0)*(L>0) THEN I=90:GOTO 500
214 IF (K=0)*(L<0) THEN I=270:GOTO 500
220 S=Q/R:S=-S:J=S:GOSUB 30520
225 IF (J=0)*(ABS(J)>.707107) T. I=180-Y:GOTO 250
250 IF L=0 T. 270
260 I=360-I
270 I=I+.05:I=INT(I*10)/10

```

```

500 CLS
510 P.TAB(25);A$
520 P.
525 IF E<0 T.P.TAB(25);"OUT OF RANGE":GOTO 550
530 P.TAB(10);"ANTENNA ELEVATION = ";E;" DEGREES"
535 IF E=90 T.P.TAB(10);"NO UNIQUE AZIMUTH":G.550
540 P.TAB(10);"AZIMUTH + ";I;" DEGREES TRUE"
550 P.
560 P.TAB(20);"STATION LOCATION:"
570 IF K>=0 THEN P.TAB(25);K;" N":GOTO 580
575 IF K<0 THEN P.TAB(25);ABS(K);" S"
580 IF M>=0 THEN P.TAB(25);M;" W"
585 P.TAB(25);ABS(M);" E"
610 P."FURTHER OPTIONS:"
620 P.TAB(10);"TERMINATE PROGRAM - 0"
630 P.TAB(10);"ANOTHER SPACECRAFT - 1"
640 P.TAB(10);"NEW STATION - 2"
650 IN."OPTION #";Q
660 CLS:IF Q=0 THEN 800
670 IF Q=1 THEN 710
680 IN."STATION LONGITUDE";M
690 IN."STATION LATITUDE";K
700 GOTO 100
710 IN."WHAT IS THE NAME OF THE SPACECRAFT";A$
720 IN."WHAT IS THE SUBPOINT LONGITUDE";N
730 GOTO 100
800 END

```

To this listing must be added the subroutines on p.218,219, and 220 of the Radio Shack Level I BASIC manual:

```

TANGENT: enter lines 30320-30340
COSINE:   enter lines 30360-30365
SINE:     enter lines 30376-30455
ARCCOSINE: enter line 30520
ARCSINE:  enter lines 30550-30650
ARCTANGENT: enter lines 30690-30760
SIGN:     enter lines 30810-30840

```

GOES E

ANTENNA ELEVATION= 37.2 DEGREES.

AZIMUTH= 165.7 DEGREES TRUE.

STATION LOCATION:

45 N.

85 W.

FURTHER OPTIONS:

TERMINATE PROGRAM - 0

ANOTHER SPACECRAFT - 1

NEW STATION - 2

OPTION#? _

Fig. 3. Sample printout, given the following input data: Name of spacecraft: GOES E; Station longitude: 85; Satellite subpoint longitude: 75; and Station latitude: 45.

trig subroutines are certainly more involved than having the functions directly available in the BASIC dialect, but you will notice this only for your first run prior to storing the program on tape. Once the program is in RAM, it runs so fast that you will find it hard to be-

lieve that it is actually using the involved subroutines. The results are accurate and fast, becoming another useful tool for the active satellite station.

My third and final article will outline an antenna tracking program for polar orbiters. ■

Computer **RTTY** Demodulator

FSK-1000
\$449.00

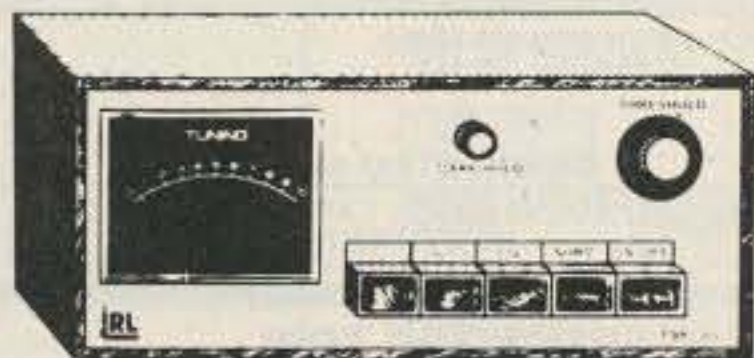
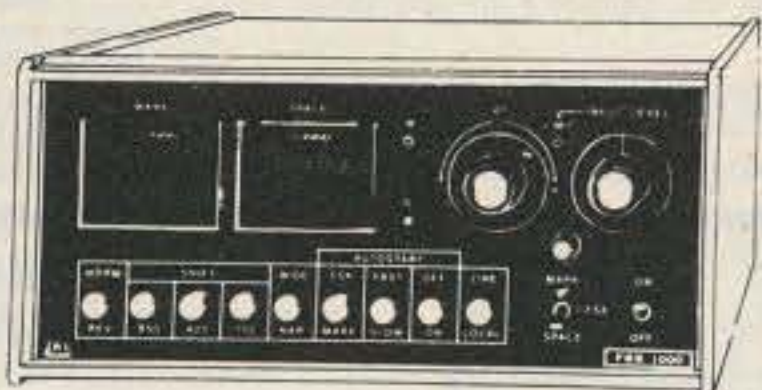

FSK-500
\$197.00

✓ I27

iRL will now ship your FSK-1000 within 48 hours on Visa or MC. No need to wait for months to enjoy the finest RTTY demodulator. For those with the TRS-80 or other microcomputer, iRL has the FSK-500: the quality demodulator with no hassel interface and the low price tag. TRS-80 software is \$46.00 or \$20.00 with above units.

Call or write for full details or see our ad in the December, 1979 issue of 73 Magazine.

iRL
T.M.

700 TAYLOR ROAD
COLUMBUS,
OHIO 43230

Clegg is VHF Headquarters!

SELECTED PRODUCTS FROM CLEGG AND FRIENDS!!

CLEGG FM-88

Fully synthesized
143-148.995 in 5 KHZ steps.
CAP & MARS coverage
Variable power (1-25w)
1 year warranty

ANTENNAS BY:
ASP, CUSHCRAFT,
HUSTLER, KLM, TONNA

AMPLIFIERS BY:
MIRAGE AND
KLM

CLEGG FM-88S

All of the great features of the FM-88 Plus
800 channel programmable scanner

POWER METERS BY:
MIRAGE

CLEGG MARK-3 & FM-76

12 channel crystal controlled
MARK-3 — 146-148 MHZ
FM-76 — 220-225 MHZ

SSB TRANSCEIVERS BY:
ICOM AND YAESU

CLEGG POWER SUPPLIES

Four popular models
PS-7A-7 Amp
PS-12A-12 Amp
PS-20A-20 Amp
RS-35A-35 Amp

HAND-HELDS
YAESU & WILSON

ROTATORS, TOWERS
& CABLES
ALLIANCE
CONSOLIDATED
TIMES WIRE
BERK-TEK

CLEGG ALL BANDER AB-144

Converts your "ALL-MODE"
2 meter transceiver to General
Coverage Receiver.
100 KHZ to 30 MHZ

CLEGG TT-2
Solid State Touch Tone
encoder featuring
automatic transmitter
keying.

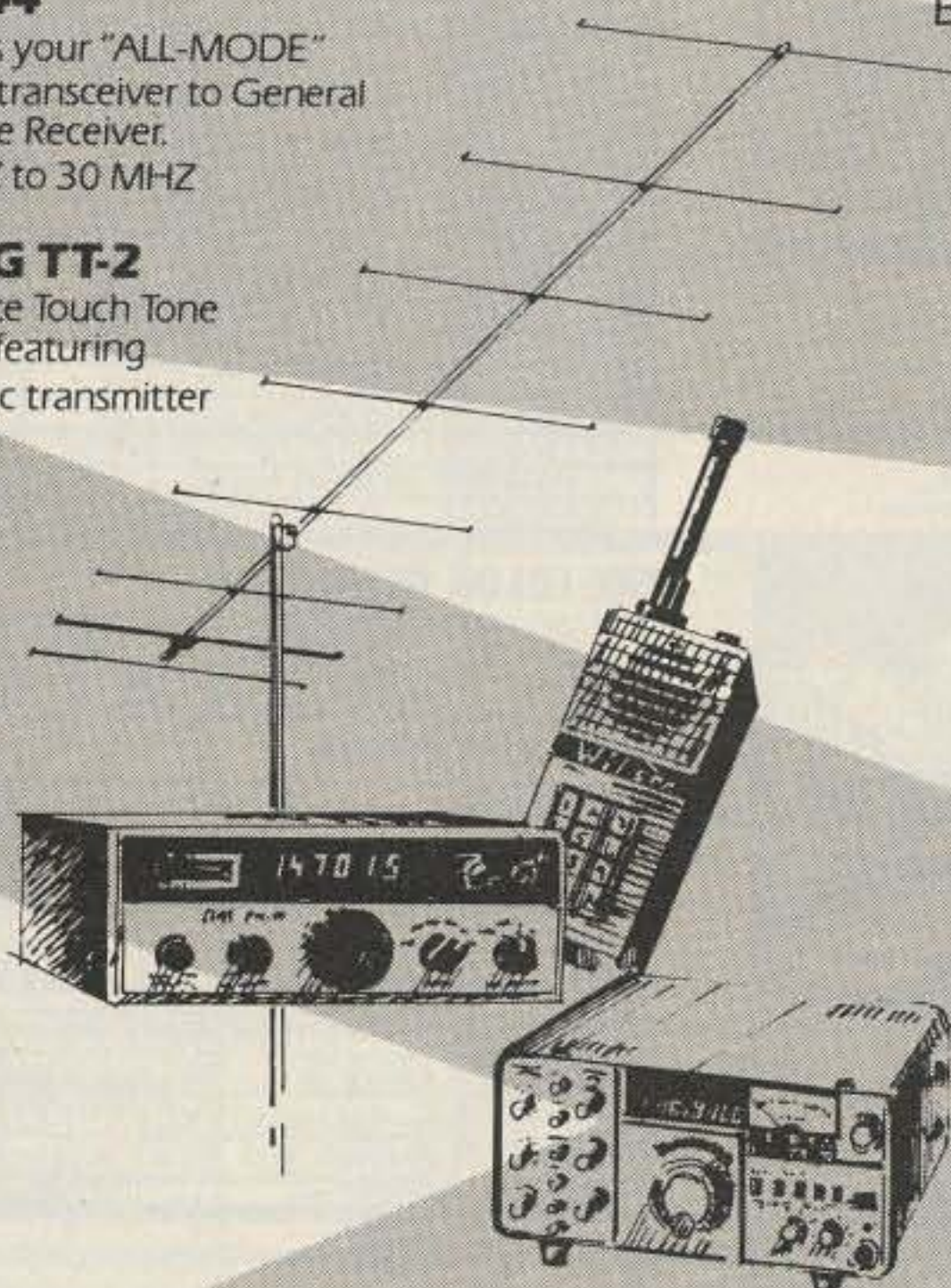

**IF YOU'RE GOING TO DO IT ON VHF
YOU'LL DO IT BETTER WITH CLEGG AND FRIENDS!**

CALL OR WRITE FOR DESCRIPTIVE LITERATURE:

Clegg Communications Corp.
1911 Old Homestead Lane
Greenfield Industrial Park East
Lancaster, PA 17601
(717) 299-7221

✓ C3



JUST WRAP™ WIRE WRAPPING TOOL

WHY CUT? WHY STRIP? WHY SLIT?
WHY NOT JUST WRAP?

JW-1-B	BLUE WIRE	\$14.95
JW-1-W	WHITE WIRE	\$14.95



RIBBON CABLE ASSEMBLY SINGLE END

26 AWG Rainbow Coded flat cable.

SE 14-24	WITH 14 PIN DIP PLUG 24" LONG (609MM)	\$3.55
SE 14-48	WITH 14 PIN DIP PLUG 48" LONG (1218MM)	\$4.25
SE 16-24	WITH 16 PIN LONG DIP PLUG	\$2.75

Design Practical PLL and Timer Circuits

— program generates standard R and C values for 567s and 555s

Ralph A. Giffone N2RG
111 Bay State Road
Boston MA 02215

I recently set out to design a circuit centered around the 555 timer-oscillator and the 567 tone decoder. I was immediately confronted by a problem that is not uncommon among amateur designers: ridiculously obscure ca-

pacitance values (or resistance values) calculated from standard design formulas. To obtain these capacitances, one must then hook up two or more capacitors in various series-parallel combinations. This is often tedious and impractical. I therefore went to my newfound friend, the computer, and sought a program that would give me a practical solution to this problem.

Fig. 1 is the schematic diagram and frequency design formula for the 567 tone decoder. The frequency of the decoder is determined by the formula, $f=1/RC$. It is obvious that for a given frequency there are an infinite number of possible RC combinations. We do not, however, have access to all values of R and C, but only to those standard values that are

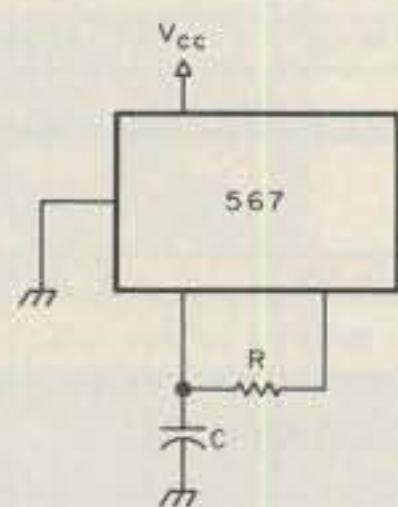

$$f = \frac{1}{RC}$$

$$C = \frac{1}{Rf}$$

f = HERTZ

```
list
05 dim a(25), R(77)
10 print "This program is designed to select the"
15 print "proper values of resistance and capa-"
20 print "citanace for the proper operation of the"
25 print "567 tone decoder."
30 print
35 print "Enter the desired frequency of operation"
40 input f
45 print
50 print
60 let s=1
65 for I=1 to 13
70 read a(I)
75 next I
76 print
77 print "The following values of resistance"
78 print "and capacitance determine the fre-"
79 print "quency of *f* Hz"
80 let A=1
85 for J=2 to 7
90 for I=3 to 13
95 let R(A)=a(I)*10^J
100 let A=A+1
105 next I
110 next J
115 for A=1 to 66
120 let C=1/(R(A)*f)
125 if C<10^(-9) then 175
130 for H= 1 to 9
135 let d=C/10^(-H)
140 if 1>d then 150
145 if d<10 then 155
150 next H
155 for I=1to6
160 if .95*a(I)>d then 170
165 if d<1.05*a(I) then 190
170 next I
175 next A
180 goto 350
190 print
195 print
200 print "Set *s*:"
205 print "R1 = *R(A)* ohms"
210 print "C1 = *1000000*C* uf"
215 let s=s+1
```

resistance and, at a given frequency, calculate C for all those values. The computer would then select those values of C which were within 5% (or any given tolerance) of standard capacitance values. Thus, the aforementioned pains of design could be alleviated!

In Fig. 2, the program I used for the 567 is listed. The program is in BASIC and essentially performs three very basic tasks:

1. Input:

(a) The computer receives the design frequency specified by user.

(b) The computer internally determines all standard values of resistance.

2. Calculation:

(a) The computer takes the first resistance and calculates C at the given frequency.

(b) If C is a *standard value* of capacitance greater than .001 uF (why mess with low-value capacitors?), then C is sent to the output section.

(c) If C is less than .001 uF or not a standard value, the computer takes the next value of resistance and performs instruction 2.(a) with this resistance.

3. Output:

(a) The computer receives value of R and prints R.

(b) The computer receives value of C and prints C.

Now let's get to the meat of the program.

Lines 10-30 are merely the introductory print statements. At 40, the user inputs the frequency "f". At 65, the values of a(1) through a(13) are read from the data statement at line 230 (see Fig. 3). Note that the values of a(1) through a(6) are the significant digits of the more common standard values of capacitance and that a(3) through a(13) are the significant digits of the common standard value of resistance. These values of a(1) through a(13) will be used first to obtain all the standard resistance values, and then to determine whether the calculated capacitance is indeed a standard value.

Lines 80-110 take the subscripted variable R(A) and make it equal to the significant digit a(I) multiplied by a power of 10 (10^I). Essentially, it does *this* (starting from 80):

```
A=1
J=2
I=3
R(1)=a(3) x 102 = 1.0 x 100
= 100 (Ohms)
A=2
I=4
R(2)=a(4) x 102 = 2.2 x 100
= 220 (Ohms)
A=3
I=5
R(3)=a(5) x 102 = 3.3 x 100
= 330 (Ohms)
```

You can see that we will be able to store up to 66 values of resistance in R(A), ranging from 1.0 x 10² to 8.2 x 10⁷ Ohm. (Note that for my purposes, I didn't want values of R less than 100 Ohms. This is up to the designer and can be altered according to his needs.)

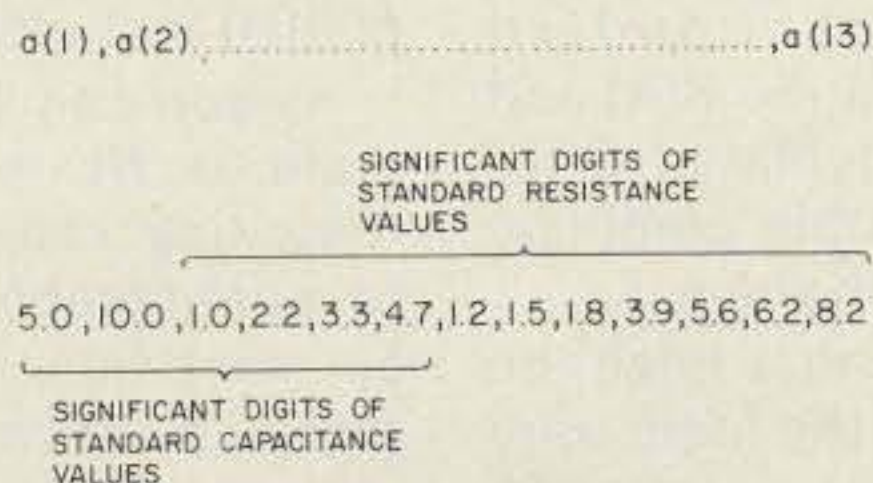

Fig. 3.

At line 115, we get a little more complex. Within a "for-to-next" loop, we have two more "for-to-next" loops! We begin with the first of 66 values of resistance and at line 120 we calculate C. If C is less than 10⁻⁹ (.001 uF), then it is bypassed and the next value of resistance is used to calculate yet another value of capacitance. If C is greater than .001 uF, then we must determine the significant digits of that capacitance and see if they

are close to the standard values we desire.

At 130, we start dividing C by the various powers of 10 until we get to the power of ten corresponding to the one of the capacitance. This will be when d is greater than 1, yet less than 10. For example, if C is 5.0 x 10⁻⁸ (.05 uF), when it is divided by a power other than 10⁻⁸, it will yield a quotient less than 1. However, when H=8, C/10^{-H} will be equal to 5.0. Thus, d will be equal to

```
run
This program is designed to select the
proper values of resistance and caps-
citance for the proper operation of the
567 tone decoder.
```

```
Enter the desired frequency of operation
? 10000
```

```
The following values of resistance
and capacitance determine the fre-
quency of 10000 Hz
```

```
Set 1 :
R1 = 100 ohms
C1 = 1 uf
```

```
Set 2 :
R1 = 220 ohms
C1 = 0.454545 uf
```

```
Set 3 :
R1 = 470 ohms
C1 = 0.212766 uf
```

```
Set 4 :
R1 = 1000 ohms
C1 = 0.1 uf
```

```
Set 5 :
R1 = 2200 ohms
C1 = 4.54545 E-2 uf
```

```
Set 6 :
R1 = 4700 ohms
C1 = 2.12766 E-2 uf
```

```
Set 7 :
R1 = 10000 ohms
C1 = 0.01 uf
```

```
Set 8 :
R1 = 22000 ohms
C1 = 4.54545 E-3 uf
```

```
Set 9 :
R1 = 47000 ohms
C1 = 2.12766 E-3 uf
```

```
Set 10 :
R1 = 100000 ohms
C1 = 0.001 uf
```

```
Edit.
```

Fig. 4. 567 sample run.



**choose your terms . . .
choose your savings!!**

Send me one year of
80 Microcomputing for
just \$15. (I save over 37%.)

I prefer 2 years for \$24. (I save 50%.)

I prefer 3 years for \$36. (I save 50% off the newsstand price.)

80 MICROCOMPUTING

The magazine for today's
biggest selling computer.

New subscription Renewal
 Payment enclosed \$ _____ Bill me
 Visa Master Charge Am Express

Card # _____ Exp. date _____

Signature _____

Name _____

Street _____

City _____ State _____ Zip _____

Canada: same as US rates, in US funds.
Other foreign: \$20 one year only, US funds.

302B56

80 Microcomputing • POB 981 • Farmingdale NY 11737

list

```

05 dim a(25),R(77)
10 Print "This program is designed to select the "
15 Print "proper values of resistance and capa-"
20 Print "citanace for the proper operation of the"
25 Print "555 timer-oscillator."
30 Print
35 Print "Enter the desired frequency of oscillation"
40 input f
45 Print
50 Print
60 let s=1
65 for I=1 to 13
70 read a(I)
75 next I
76 Print
77 Print "The following values of resistance "
78 Print "and capacitance determine the fre-"
79 Print "quency of 'f';Hz."
80 let A=1
85 let B=1
90 for J=2 to 7
95 for I=3 to 13
100 let R(A)=a(I)*10^-J
105 let R(B)= R(A)
110 let A=A+1
115 let B=B+1
120 next I
125 next J
130 for A=1 to 66
135 for B=1 to 66
140 let C=1.44/((R(A)+2*R(B))*f)
145 if C<10^(-9) then 195
150 for H= 1 to 9
155 let d=C/10^(-H)
160 if 1>d then 170
165 if d<10 then 175
170 next H
175 for I= 1 to 6
180 if .995*a(I)>d then 190
185 if d<1.005*a(I) then 210
190 next I
195 next B
200 next A
205 goto 350
210 Print
215 Print
220 Print "Set 'f';":
225 Print "R(A)=';R(A);'ohms"
230 Print "R(B)=';R(B);'ohms"
235 Print "C=';1000000*C;uf"
240 let s=s+1
245 Print
250 goto 195
260 data 5.0,10.0,1.0,2.2,3.3,4.7,1.2,1.5,1.8,3.9,5.6,6.2,8.2
350 end

```

Fig. 6. 555 program listing.

the significant digits of capacitor C.

Next we go to 155 and begin a process which will determine whether d (the significant digits of C) is within 5% of the significant digits of any of the common standard capacitance values. These, as explained previously, are stored in variables a(1) through a(6).

Let's see how it runs.

When I=1, the first value of a(I), or a(1), will be 5.0. The instructions in 160 and 165 are such that if d is 5% above or below the

standard value (5.0 in this case), C will be transferred to the output section beginning in 190. If it is not, the computer will see if d is within 5% of the next standard value, and so on. If it is not within 5% of any standard values, C is bypassed, the next value of R(A) is selected, and the whole process begins once more. Please note that one may select capacitors that are even closer to the standard values if he makes the tolerance less than 5%. You'll note that in the program for the 555 timer, the capacitance selected is within .5% of the standard values. However, if you make the tolerance too precise, you may find that there are no capacitors that close to the standard values and thus there will be no output from the computer.

The program ends with some print statements, giving

us the results of the computer's long, hard work. (It takes a few seconds!) All we need to do is enjoy the fruit of its labor!

Fig. 4 shows the printout as the program is run.

In Fig. 5, we have a more complex design formula. For the oscillation frequency of the 555 timer, we need to use two resistors and a capacitor. Fig. 6 shows the program for this circuit. Note that the program is identical except for some additional lines. What I've done is generate two sets of standard resistance values, R(A) and R(B), and calculated C for the 66² possible combinations between them.

One thing that might be confusing is the logic used in selecting the order of the data in a(1) through a(13).

Studying Fig. 3 may clarify it for you. Some values are needed only for the capacitors, some only for the resistors, and some for both. Thus, it was necessary to order the data statement that way. If you wish to write your own program, consider these things. (Also be certain to make one of the values of a(I) equal to 10.0. Even though you have the digits 1.0 for the lower values of capacitance, the program will not work for significant digits of 9.99, etc., unless you have a data of 10.0 included.)

As you can see, the program is flexible and the reasoning can be applied to more complex formulas. So, next time you have a design problem, put away your scratch pad and take out your computer! ■

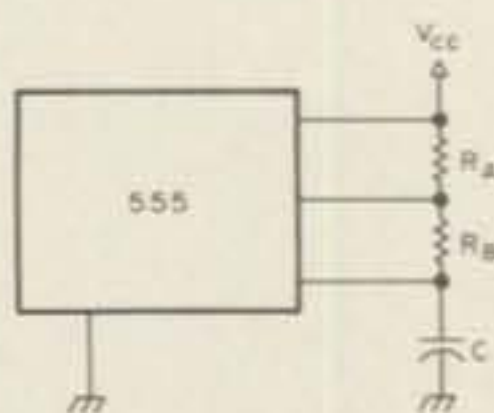

$$f = \frac{1.44}{(R_A + 2R_B)C}$$

$$C = \frac{1.44}{(R_A + 2R_B)f}$$

Fig. 5. 555 oscillator circuit.

Call 1-203-667-0811

ORDER YOURS TODAY!

*****NEW...CLOSE-OUTS*****

ATLAS	
RX110 Receiver	\$173.00
RX110S Receiver	203.00
PS110H Power Supply	68.00
MM-110 Mobile Mnt.	27.00
215X w/NB	599.00
ALLIANCE	
HD-73 Heavy duty rotor	119.95
ALDA	
I03 w/NB, Xtal cal., mike, bracket, PS 115 Power Supply	479.95
CDE	
CDE-44 Rotor	95.00
DENTRON	
GLA-1000 1KW Amp	299.00
MLA-2500B 2KW Amp	839.00
Clipperton L 2KW Amp	549.00
MT-2000A 3 KW Tuner	154.95
MT-3000A 3KW Tuner	329.00
WV-1 VHF Power/SWR Meter	59.95
WP-2A-HF Peak Reading Power/SWR Meter	84.95
PS-20-VOM/SWR/Power Meter	59.95
PS-10-VOM/SWR/Power Meter	41.95
ICOM	
IC-701 w/Power Supply	1199.00
IC-211 2 meter/all mode	699.00
IC-215 2MFM Portable	175.95
IC-202S 2M SSB/CW Port.	272.95
IC-402 430MHZ SSB/CW Port.	361.95
IC-3PS Power Supply	82.95
IC-3PE Power Supply	82.95
IC-EX1 701 Interface	29.95
IC-30L 430 MHZ Amplifier	121.95
IC-EX106 FM Option (551/551D)	117.95
IC-EX107 Vox Option (551)	102.95
IC-EX108 P. B. Tune (551)	51.95
KLM	
I5-160 BL 2 M Linear Amp.	229.00
SWAN	
FS-2 Field Strength/SWR Meter	16.50
FS-1 Field Strength Meter	15.50
SWR-3 SWR Meter	15.50
WM-2000A H. F. P. E. P. Meter	83.95
HFM-200 Mobile Power/SWR Meter	41.95
WM-6200 VHF Power/SWR Meter	76.95
WM-2000 HF Meter	59.95
TEN-TEC	
KR-20A Keyer	55.00
YAESU	
FV-901 VFO	339.00
FT-101DC Converter	42.00
YC-500S 500 MHZ Freq. Counter	265.00
YC-500J 500 MHZ Freq. Counter	199.00
YO-101 Scope	259.00
YC-221 Display	99.00
FT-127RA 220 MHZ Mobile	399.00
FT-7B Transceiver	599.00
FT-101Z Transceiver	669.00
CPU-2500R/K 2 Meter mobile	499.00

****USED EQUIPMENT****

ALLIED	
A-2517 Xcvr. w/PS/Spkr.	\$429
ATLAS	
210X (Special Edition) w/N. B.	429
215X w/N. B., DMK	429
200PS Power Supply	69
COLLINS	
75S-3B Rcvr.	649
75-S-3 Rcvr.	479
KWM-2 (Round Emblem) Xcvr.	1099
KWM-2 Xcvr.	599
KWM2-A Xcvr.	795
516F-2 Power Supply	149
LC-1-32S Processor	69
CLEGG	
Zeus 331 6 & 2 meter Xmtr.	89
C. T. G.	
Magnum Six Speech Processor	69
DRAKE	
2B Rcvr.	189
R-4B Rcvr.	349
T-4X Xcvr.	339
TR-6 w/N. B.	589
MS-4 Speaker	19
AC-4 Power Supply	89
7075 Desk Mike	25
2BQ Qmult/spkr.	39
DENTRON	
WP-1A 2KW Power/SWR meter	99
HF-200A Xcvr. w/HF-ACS P. S., Mike	559
80-10 AT Tuner	39
ELECTRONIC RESEARCH CORP.	
SL-55 Audio Filter	49
HAMMARLUND	
HW-170 Rcvr.	169
HENRY	
100 AL10 w/PS 1220B Supply & Cabinet	249
HEATHKIT	
SB-303 Rcvr.	\$259
DX-60 Xmtr.	59
SB-220 2 KW Amp	499
HW-104 w/P. S., Spkr., CW Filter, N. B., Mike	549
SB-634 Station Console	169
ICOM	
IC-22S Xcvr.	199
IC-22S Xcvr. w/5/8 wave ant.	219
IC-215 w/BC-20, xtals	159
IC-202S SSB/CW Port.	159
IC-3PA D. C. Supply	49
IC-245 Xcvr.	299

JOHNSON	
275 Watt Matchbox	59
275 Watt Matchbox w/SWR Meter	119
KENWOOD	
R-300 Rcvr.	239
TS-600 Xcvr.	549
R-820 Deluxe Rcvr.	759
KLM	
I0-160BL Linear Amp.	189
NATIONAL	
NCX-5 Xcvr. w/PS/Spkr.	359
REGENCY	
HR-6 Xcvr.	115
HR-2 Xcvr	99
SBE	
Model 36 Xcvr. w/digital readout, P. S./Spkr.	429
TEN TEC	
Triton IV Xcvr. w/CW Filter	519
Triton II Xcvr. w/252 P. S.	499
244 Digital Display	139
Argonaut w/210 P. S.	219
TEMPO	
Tempo One Xcvr. w/AC One, P. S.	429
YAESU	
FT-301SD Xcvr w/CW Filter, Processor	\$499
FT-301D Xcvr w/FP-301, PS & Spkr.	696
FR-101S Rcvr. w/6 meter Conv., FM, Xtals	499
FT-901DM Xcvr. w/CW Filter	1029
FT-7 Mobile Xcvr.	379
FTV-650B 6 meter Transverter	169

We Sell and Service the Following New and Used Equipment:

- | | | |
|------------|-----------|-------------------|
| Alda | DSI | Mirage |
| Alliance | ETO Alpha | Mosley |
| Ameco | Ham Key | Murch |
| ARRL | Hustler | PIPO |
| Atlas | Hy-Gain | Robot |
| Benchner | ICOM | Rohn |
| Bird | JW Miller | Saxton Wire |
| B & W | KDK | Shure |
| Callbook | KLM | SST Electronics |
| CDE | Larsen | Swan |
| CES | MFJ | Telex |
| Covercraft | Microlog | Ten Tec |
| Cushcraft | | TET Antennas |
| Dentron | | Trac |
| Drake | | Unadilla |
| | | VHF Engineering |
| | | Vibroplex |
| | | Wilson |
| | | Wilson Commercial |
| | | Yaesu |

WE TAKE PHONE ORDERS OR SHIP C.O.D.

**Call
or Write
for your
super quote
today!**



WE EXPORT
(Sub-Dealers
wanted in
foreign countries)

THOMAS COMMUNICATIONS

95 Kitts Lane, Newington, Conn. 06111
"Near ARRL Headquarters"

Connecticut Residents Call: 203-667-0811
OPEN MON-FRI 10-6 • THURS 10-8 P.M. • SAT 10-4
EASY DIRECTIONS: Rt. 15 South — 2 blocks past McDonald's (Berlin Turnpike)

SUB-DEALER INQUIRIES INVITED! (Send letterhead for complete package)

DUPECALL . . . for Your Next Contest

— let your SWTP do the duping

"CQ contest, CQ contest. This is K4TSY calling . . . K4TSY, this is K4HTU, over . . . Err, uh . . . K . . . 4 . . . H . . . T . . . U. Um, let me see now, have we worked before? (Much scrambling follows.) Just a minute, OM, I'm checking to see if we have worked earlier in the contest (more fumbling). Gee, I can't seem to . . . oh yeh, looks like we already worked earlier. Do you agree? Over. This is K4HTU . . . well, if you say so . . . but I'm not sure either . . ."

Does this sound familiar? For me, it was all too often the case. I do keep a dupe sheet, but I find it very hard to keep up during a rapidly moving contest. (For the uninitiated, a dupe sheet is a list of the stations worked, organized to facilitate the checking of station calls during the contest.) This sheet is normally arranged by call area, or simply alphabetically for DX.

I never found a good way to do it by hand, so I thought of using my micro-computer (an SWTPC 6800 machine) to help the cause.

The result is the program that is presented in this article. I call it DUPECALL (Listing 1).

How To Use It

The program has two start-up modes, cold and soft. The cold start is like starting with a clean piece of paper; it clears memory and starts you at the beginning. The soft start just lets you jump back in where you left off (more about that later).

When loaded and started at \$0100 "cold start," DUPECALL will respond with a prompt, a "greater than" sign, ">". This tells you that the program is waiting for an input. You type in the call to be recorded (up to 6 characters long) and end the field with a carriage return (CR). The CR tells the program that you have completed that particular call. Then, upon receipt of the CR, a check is made through all preceding memory. If no dupe is found, the prompt is changed to a plus, "+". If you want to add it to the list, type another CR; if not, type a minus, "-". The program will delete the last entry from the file and return

the prompt ">" to indicate that it is ready for the next entry.

The input field is limited to 6 characters, so if you try to type 7 characters, the program will respond with "ERROR." Erase that entry from the file and return the prompt. This is also the way to correct a mistake. Just fill the field to "overflow," accept the "error" message, and try again after the prompt. You are forgiven.

The program's response to a dupe is a message to that effect, but the last call is left on the screen and the dupe message is typed under it for later reference. The duplicate call is erased from the file, as with the error mode above.

If you want to exit the program, just respond to the prompt with a "less than," "<", character. The LT will cause the program to make a clean exit. The top of file address is recorded at the beginning of the file and control is returned to MIKBUG.

The idea of a clean

program exit is useful for more than just the soft start. The memory, loaded with calls (your file), can then be recorded on cassette tape. Then, with another program, like TYPECALL (Listing 2), the same data can be printed out. Actually, it's a good idea to stop once in a while to record the data file on tape, just to protect it. Use MIKBUG PUNCH and save DUPECALL and its file together. Put \$00B3 into locations \$A002-3, the contents of \$0200 into locations \$A004-5, and type P.

The soft start point allows you to get back into DUPECALL wherever you left off. Just type "G", and when the prompt is returned, you are back in DUPECALL, ready to continue entering calls for more duplicate checks. If you have used TYPECALL, be sure to reset the restart vector to \$0113 before typing "G" Start TYPECALL at \$0030.

The program as presented runs in 4K of memory and holds just under 600 calls in that much memory. If you have more memory avail-

INNOVATION IN AMATEUR RADIO

73

For over 18 years, 73 Magazine has been the innovator in amateur radio. 73 led the way to developing the use of solid-state circuitry, and was the first to promote such things as SSTV, radioteletype, computer applications for radio communications, and single sideband.

Radio electronics has changed as 73 has changed. Ever notice how other magazines published in the field of radio electronics are just like the ones before them? Same old subjects in every issue, same predictable views, same old editorials . . . try to find it in 73 . . . you won't. In one issue you might find building projects and information on antennas, moonbouncing and mountaintopping; in the next issue you might read about computers, radioteletype, or traffic handling.

FREE TRIAL COPY

Write today and we'll send you your first copy with absolutely no obligation . . . that's right, if you're not completely satisfied after you've read your first issue, just write "CANCEL" on your invoice and send it back to us . . . the first issue is yours to keep — on us! In addition, we'll guarantee every issue of your subscription . . . if you're not satisfied with your first — or your eleventh — issue, we'll refund your money on all remaining issues. Call in your order today and get your new subscription started for \$15 . . . half the price you'd pay on the newsstand. Have your credit card handy and call us toll-free at (800) 258-5473.

\$15 one year

\$45 three years

If you enjoy driving, you're going to get a **COMPUCRUISE**. Once you see what it can do, you just won't be able to live without it.

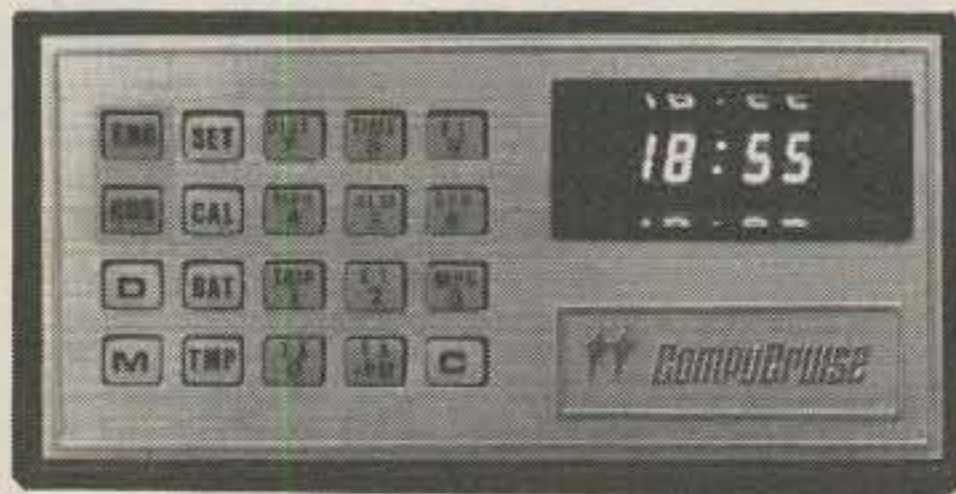

This gadget fits into most dashboards... no strain even in a tiny sports car like the Mazda RX-7... and once you have it, every trip is like flying a 747. The darned thing tells you the time, how fast you're going, how far you've been on this trip or since the last regassing, how many miles per gallon you're getting, either at the instant or the average on the trip... or gallons per hour at the moment or for the trip... temperature outside... inside (or coolant temperature, if you prefer)... oh, it has an elapsed time for the trip, a stop watch, lap time, an alarm... how much further for your trip, how many gallons more the trip will take, how much longer for the trip at your present average speed... yes, it gives you your average speed for the trip. You prefer it in metric, no strain... liters remaining, etc. Did we mention that it also has cruise control either at a speed set on the control board or at whatever speed you are traveling? The Compucruise will keep you busy and entertained during any trip... telling you more than you will ever want to know.

The Compucruise is not difficult to install... though it does connect to everything except the cigarette lighter. Until you've tried computerized travel, you haven't found out how much fun driving can be. It will work on any car not having fuel injection... and there is a front-wheel drive accessory gadget available for only \$4.40-#P001 (regularly \$5.50).

The price for the Compucruise is regularly \$199.95... and a bargain at that price. We'll sell you one of these fantastic gadgets for \$159.95 with cruise control (Model 44-#P002), and \$127.95 without (Model 41-#P003). Send money... and start having fun!

MOM'S

MAIL ORDER MICROS ✓ M128

Dept F73 • PO Box 427 • Marlboro NH 03455
Phone: (603) 924-3041

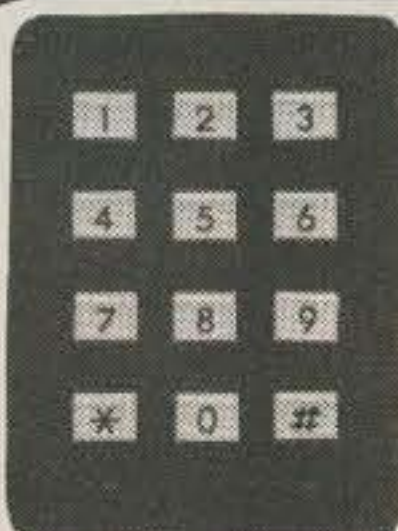

Steal Stopper

Ever had your car stolen?
The first reaction is one of disbelief...
... you know it was right there!

What you want is a modern combination lock on your ignition... The Steal Stopper. It's easy to install and almost impossible to defeat. You can by-pass it, if you want, for parking attendants or a car wash. Other than that, you set up a secret four-digit code and only you will then be able to start the car... even if you leave the keys in the ignition. Of course, if you forget the number...

This protection retails for \$50... but we have a special for you at \$39.95. Don't procrastinate. Order #P004.

PROCESSOR TECH HARDWARE

- 9 **Processor Tech Video Display Module**—Memory mapped video for S-100, excellent condition. #D009-\$144 each.
- 1 **Processor Tech ROM/RAM card**—Contains 1K RAM, empty slots for 12K ROM, S-100, excellent condition. #D007-\$76.
- 3 **Processor Tech 3P + S I/O card**—Three parallel ports, one serial port, S-100, excellent condition. #D008-\$116 each.
- 2 **Processor Tech 16K Static RAM card**—450 nanoseconds, S-100, excellent condition. #D010-\$199 each.
- 4 **Processor Tech 2K ROM card (kit)**—Empty board, S-100, new. #D011-\$17.20 each.
- 4 **Processor Tech 2K ROM card**—Empty board, S-100, excellent condition. #D012-\$25.20 each.

PROCESSOR TECH SOL

- 4 **SOL Computers**—8K Memory, S-100, excellent condition. #D004-\$980 each.
- 19 **TREK-80** on cassette for SOL—This is one of the best real time space games available today; needs 8K. #D005-\$11 each.
- 9 **Electric Pencil** on cassette for SOL—Word processor, needs 8K. #D006-\$80 each.

LIMITED SUPPLY 73 MAG. AUG. '79

Contains controversial article "You Can Watch Those Secret TV Channels." Order #M001-\$5 each.

COMPUCOLOR HARDWARE

- 2 **Compucolor Computer 8001** (use as computer or 75 MHZ Color Monitor)—8K RAM, BASIC and DOS in ROM, good condition. #S025-\$1500 each. **SPECIAL PRICE.**
- 2 **Compucolor MiniFloppy**—5 1/4 inch, good condition. #S026-\$525 each. **SPECIAL PRICE.**
- 4 **Compucolor 8K RAM card**—Static RAM, good condition. #S027-\$200 each. **SPECIAL PRICE.**
- 3 **Compucolor Floppy Tape Drive**—Uses eight track cartridges, good condition. #S028-\$70 each. **SPECIAL PRICE.**

BALLY GAMES

- 2 **Bally VideoCode Cassettes**—They consist of two games: Speed Math and Bingo Math. #D029-\$16 each.

ABACUS

- 112 **Abacus Paperweight**—Hefty, brass, excellent condition. #S024-\$3 **SPECIAL PRICE.**

POLYMORPHIC HARDWARE

- 8 **PolyMorphic Video Terminal Interface**—Memory mapped video for S-100 bus, good to excellent condition. #S044-\$150 each. **SPECIAL PRICE.**
- 1 **PolyMorphic Video Terminal Interface (used)**—As above. #S045-\$100.00. **SPECIAL PRICE.**
- 3 **PolyMorphic CPU**—8080 CPU for S-100 with Poly monitor in ROM, excellent condition. #S046-\$100 each. **SPECIAL PRICE.**
- 4 **PolyMorphic Cassette Interface**—Plugs into Poly CPU only, new. #D047-\$29.60 each.
- 4 **PolyMorphic Printer Interface**—Plugs into Poly CPU only, new. #D048-\$29.60 each.
- 4 **PolyMorphic S-100 Cabinets**—Nice 5 slot S-100 mainframe, good to excellent condition. #D049-\$248 each.

POLY-88 ACCESSORIES

- 3 **Parallel Keyboard**—Good condition. #S001-\$50 each. **SPECIAL PRICE.**
- 1 **Software on 5 1/4"**—This is system software that requires a PolyMorphic Disk Controller in a System 88 Cabinet. #D002-\$100.
- 1 **Electric Pencil**—#D003-\$80.

NORTH STAR HARDWARE

- 1 **North Star Floating Point BASIC card**—With special BASIC, new. #D0059-\$287.
- 2 **North Star Floating Point BASIC card (kit)**—With special BASIC, S-100, new. #D0060-\$207.
- 8 **North Star Floppy Disk Controller card**—Single density, S-100, new. #D0061-\$248.
- 120 **S-100 Edge Connector**—Gold Contacts, new. #D050-\$20 each.
- 6 **Extender Card for S-100 (kit)**—New. #D051-\$24 each.

QUASAR VIDEO TAPE RECORDER

Records color or black and white up to 2 hours, off the air, or records one program while you watch another. Camera input to make your own tapes, pause control for editing. These \$1,000 VTRs were demonstrated and come with new warranty. **SPECIAL PRICE** is \$475—extra bonus—free \$100 worth of new tape with each order. Limited supply. Order #P005.

MUSIC

- 2 **Software Technology S-100 Music system** on cassette—This is an S-100 Music system; contains the proper hardware. #D0058-\$19.60 each.

COMPUTER TRAINER

- 1 **IASIS COMPUTER-IN-A-BOOK**—8080 Microcomputer, comes built into training manual, excellent condition. #D020-\$240

ICOM DISK DRIVE ACCESSORIES

- 1 **ICOM Dual Disk Drive**—Single density, 512K storage, S-100 controller, includes CP/M ROM, good condition. #S030-\$1500. **SPECIAL PRICE.**
- 1 **ICOM PROM and 8" Disk for SOL FDOS**—This disk requires an ICOM S-100 Disk Controller installed in an S-100. #D031-\$160.
- 1 **ICOM CP/M on 8" Disk for S-100**—Requires an ICOM S-100 controller in an S-100 cabinet. #D032-\$100.
- 2 **ICOM FDOS-II on 8" Disk for S-100**—Requires an ICOM S-100 controller in an S-100 cabinet, no documentation. #D033-\$180 each.
- 1 **ICOM FDOS-II on 5 1/4" Disk for S-100**—Requires an ICOM S-100 Mini-Floppy Controller in an S-100 cabinet. #D034-\$168.

PROCESSOR TECH SOFTWARE

- 2 **Processor Tech Extended Disk BASIC**—This is full disk BASIC on 8" disk for HELIOS II disk controllers with PTDOS and greater than 16K. #D015-\$80 each.
- 1 **Extended Disk BASIC on cassette**—This is the same as previously mentioned for the Disk BASIC from Processor Tech. Needs more than 16K. #D017-\$72.
- 8 **Extended Cassette BASIC**—This includes all file operations, advanced functions for doing more than playing games; for SOLOS, CUTTER, and CONSOL Monitors. #D016-\$22 each.
- 19 **BASIC 5 from Processor Tech**—This is a simple BASIC for a SOLOS, CUTTER, or CONSOL Monitor and 8K of RAM. #D013-\$11.60 each.
- 4 **Processor Tech GAMEPAC**—for above BASIC—Various simple games. #D014-\$11.60 each.

IMSAI HARDWARE

- 1 IMSAI 8800 Mainframe S-100—Excellent condition. #D0047-\$839.
- 1 IMSAI 80/15 S-100 Development System—Partially assembled, needs a CPU card, excellent condition. #S0048-\$525 as is. **SPECIAL PRICE.**
- 1 IMSAI 80/15 S-100 Development System—Kit, mainframe cover missing, needs a CPU card, excellent condition. #S0049-\$500 as is. **SPECIAL PRICE.**
- 2 IMSAI 4K RAM card—S-100, good condition. #D0055-\$89.60

IMSAI SERIAL I/O CARDS

- 1 IMSAI Serial I/O card 2-2—Two serial ports, full RS-232 control, S-100, good condition. #D0050-\$188.
- 5 IMSAI Serial I/O card 2-2 (kit)—Two serial ports, full RS-232 control, S-100, new. #D0051-\$124.
- 2 IMSAI Serial I/O card 2-1 (kit)—One serial port, full control RS-232 control, S-100, new. #D0052-\$100.

IMSAI PARALLEL I/O CARDS

- 1 IMSAI Parallel I/O card 4-4—Four parallel ports, S-100, excellent condition. #D0053-\$186.
- 1 IMSAI Parallel I/O card 4-1 (kit)—One parallel port, S-100, new. #D0054-\$74.40.

IMSAI SOFTWARE

- 2 IMSAI IMDOS V2.02 on 8" Disk for S-100—No documentation, but this is apparently IMSAI's version of CP/M for S-100 systems with an IMSAI Disk Controller. #D0056-\$96 each.
- 2 IMSAI BASIC 9A—This BASIC is for an S-100 system with a TARBELL cassette interface. #D0057-\$22.
- 1 TARBELL Cassette Interface (kit)—Kansas City Interface, Tarbell Phase encoding, S-100, new. #D0064-\$96.

Prices include 20% discount. **SPECIAL PRICE** includes more than 20% discount.

Quantities are limited, immediate refund if ordered item is no longer available. Please read terms below.

TERMS: FOB Marlboro, NH USA. Limited stock; everything guaranteed as described; you pay postage on returns. PRINT orders clearly. Minimum order \$10 plus \$2.50 shipping and handling charge in USA only. **DOUBLE THAT ELSEWHERE.** Orders over \$50 add 5% for shipping in USA; 10% elsewhere (we will refund excess). Orders shipped UPS or insured mail only. Send US funds by check or money order. For credit card purchases, add 4%, list AE, MC or VISA, number, and expiration date. Mail to MOM's, Department F73, PO Box 427, Marlboro NH 03455

Condition of Inventory:
 New = original container
 Excellent = new, but not in original container
 Good = tested or used in store

MOM'S

MAIL ORDER MICROS M128
 Dept F73 • PO Box 427 • Marlboro NH 03455
 Phone: (603) 924-3041

20% OFF
Inventory Clearance SALE

PHONE INTERFACE

- 6 Novation Modem #3102A—Connects to any phone, originate only, good condition. #S021-\$165 each. **SPECIAL PRICE.**
- 2 Novation Modem #3103A—Connects to any phone, answer/originate, good condition. #S022-\$200 each. **SPECIAL PRICE.**
- 1 Novation Modem #43—Connects to any phone, originate only, good condition. #S023-\$165. **SPECIAL PRICE.**

VECTOR GRAPHIC S-100

- 3 Vector Graphic ROM/RAM card—12K empty ROM sockets, 1K RAM, excellent condition. #D0078-\$119.60.
- 5 Vector Graphic Analog Interface—Allows hobbyist to interface analog experiments, S-100, new. #D0079-\$79.20.
- 1 Vector Graphic Analog Interface (kit)—As above, S-100, new. #D0080-\$55.60.

TDL ZAPPLE

- 2 TDL Z-80 8K BASIC—This is for a Z-80 system with a ZAPPLE Monitor. #D0071-\$30.
- 1 TDL ZAPPLE 2K Monitor—Nice monitor to start a system with. #D0072-\$16.
- 3 TDL ZAP 1K Monitor—Simple monitor. #D0073-\$12.

TDL HARDWARE

- 2 TDL ZPU Z-80 CPU—S-100 CPU with adjustable clock 0-4 MHz, good condition. #D0062-\$159.
- 1 TDL Systems Monitor Board—Contains system software including monitor, S-100, good condition. #D0063-\$140.

HONEYWELL

- 15 Honeywell ASR-33 Communications Consoles with TTY, paper tape reader and punch. Used, working when removed from service. Shipped freight collect or you pick up. Weight 300 lbs. \$395. Order #P006.

TDL TEXT PROCESSOR

- 2 TDL Text Output Processor—Text processor. #D0074-\$16.
- 1 TDL Text editor—Nice editor. #D0075-\$12.
- 1 TDL Memory Test—Simple utility. #D0076-\$4.

TDL SOFTWARE-DISK

- 1 TDL FDOS & SuperBASIC on 8" Disk—This requires an ICOM Disk Controller and at least 20K of memory, plus a ZAPPLE Monitor in an S-100 Cabinet (Altair, IMSAI, etc.). #D0065-\$137.
- 1 TDL System Software on 5 1/4" disk—This set of system software requires a North Star Disk Controller, a TDL Systems Monitor Board I, and consists of 12K BASIC, Relocator/Linking Loader, Z-80 Editor, and Text Processor. #D0066-\$183.
- 1 TDL System Software on 5 1/4" disk—This is the same as above, but does not require the Systems Monitor Board I. #D0067-\$200.
- 1 TDL System Software on 5 1/4" disk—Again, as above, but requires a HELIOS Disk Controller and the TDL Systems Monitor Board II (not I). #D0068-\$183.

TDL SOFTWARE-CASSETTE

- 1 TDL 12K BASIC V2.1 on cassette—Same as disk version. #D0069-\$22.
- 1 TDL System Pack—This is the same as the Disk Pack. #D0070-\$136.

MOUNTAIN HARDWARE

- 7 Mountain Hardware AC Controller—Remote AC outlet control, S-100, new. #D040-\$100 each.
- 4 Mountain Hardware remote outlet—Remote module for above, two channels, new. #D041-\$72 each.

HEURISTICS SPEECH LAB

- 1 Heuristics Speech Lab—S-100, used, fair condition. #S042-\$100 as is. **SPECIAL PRICE.**
- 4 Heuristics Speech Labs—S-100, new. #D043-\$151 each.

SHUGART MINIDISK DRIVES

- 1 Shugart MiniDisk Drives—With case and power supply, includes cable for North Star, good condition. #S036-\$320. **SPECIAL PRICE.**
- 4 Shugart MiniDisk Drives—No cabinet, good condition. #S037-\$300 each. **SPECIAL PRICE.**
- 4 Power Supplies for above—good condition. #S038-\$30 each. **SPECIAL PRICE.**

Qty	Catalog #	Description	Unit Price	Total

Enclosed \$ _____

Bill: AE MC VISA

Signature _____

Name _____

Address _____

City _____

Ship: UPS

Insured mail



Shipping & Handling _____

Credit Card (+ 4%) _____

Total _____

Exp Date _____

State _____ Zip _____

NEW MFJ Dual Tunable SSB/CW filter

lets you zero in SSB/CW signal and notch out interfering signal at the same time.

**Ham Radio's
Most Versatile Filter**



**BRAND
NEW**

\$79⁹⁵

The MFJ-752 Signal Enhancer is a dual tunable SSB/CW active filter system that gives you signal processing performance and flexibility that others can't match.

For example, you can select the optimum Primary Filter mode for an SSB signal, zero in with the frequency control and adjust the bandwidth for best response. Then with the Auxiliary Filter notch out an interfering heterodyne... or peak the desired signal.

For CW, peak both Primary and Auxiliary Filters for narrow bandwidth to give skirt selectivity that others can't touch. Or use Auxiliary Filter to notch out a nearby QSO.

The Primary Filter lets you peak, notch, low-pass, or highpass signals with double tuned filter for extra steep skirts. The Auxiliary Filter lets you notch a signal to 70 db. Or peak one with a bandwidth down to 40 Hz.

Tune both Primary and Auxiliary Filters from

300 to 3000 Hz. Vary the bandwidth from 40 Hz to almost flat. Notch depth to 70 db.

MFJ has solved problems that plague other tunable filters to give you a constant output as a bandwidth is varied. And a linear frequency control. And a notch filter that is tighter and smoother for a more effective notch.

Works with any rig. Plugs into phone jack. 2 watts for speaker. Inputs for 2 rigs.

Switchable noise limiter for impulse noise; trough clipper removes background noise.

Simulated stereo feature for CW lets ears and brain reject ORM. Yet off frequency calls can be heard.

Speaker and phone jacks. Speaker is disabled by phones. OFF bypasses filter. 110 VAC or 9 to 18 VDC, 300 ma. 10x2x6 inches.

Every single unit is tested for performance and inspected for quality. Solid American construction, quality components.

The MFJ-752 carries a full one year unconditional guarantee.

Order from MFJ and try it — no obligation. If not delighted, return it within 30 days for a refund (less shipping).

To order, simply call us toll free 800-647-1800 and charge it on your VISA or Master Charge or mail us a check or money order for \$79.95 plus \$3.00 for shipping/handling.

Don't wait any longer to use Ham Radio's most versatile filter. Order your MFJ Dual Tunable SSB/CW Filter at no obligation, today. ✓ M52

MFJ ENTERPRISES, INC.
P. O. BOX 494
MISSISSIPPI STATE, MS 39762
CALL TOLL FREE . . . 800-647-1800
For technical information, order/repair status, in Miss., outside continental USA, call 601-323-5869.

DEALER DIRECTORY

Fontana CA

We carry the following: ICOM, Midland, Amcom, DenTron, KLM, Swan, Drake, Ten-Tec, Wilson, SST, MFJ, Hy-Gain, Lunar, Nye-Viking, B&W, Redi-kilowatt, CushCraft, Mosley, Big Signal, Pipo, etc. Full Service Store Fontana Electronics, 8628 Sierra Ave., Fontana CA 92335, 822-7710.

Santa Clara CA

Bay area's newest Amateur Radio store. New & used Amateur Radio sales & service. We feature Kenwood, ICOM, Wilson, Yaesu, Atlas, Ten-Tec, VHF Engineering & many more. Shaver Radio, Inc., 1378 So. Bascom Ave., San Jose CA 95128, 998-1103.

Denver CO

Experimenter's paradise! Electronic and mechanical components for computer people, audio people, hams, robot builders, experimenters. Open six days a week. Gateway Electronics Corp., 2839 W. 44th Ave., Denver CO 80211, 458-5444.

New Castle DE

ICOM, Ten-Tec, Swan, KDK, NDI, Tempo, Wilson; Authorized dealer: 1 mile off I-95. No sales tax. Delaware Amateur Supply, 71 Meadow Road, New Castle DE 19720, 328-7728.

Columbus GA

KENWOOD—YAESU—DRAKE
The world's most fantastic amateur show-room! You gotta see it to believe it! Radio Wholesale, 2012 Auburn Avenue, Columbus GA 31906, 561-7000.

Preston ID

Ross WB7BYZ, has the Largest Stock of Amateur Gear in the Intermountain West and the Best Prices. Call me for all your ham needs. Ross Distributing, 78 So. State, Preston ID 83263, 852-0830.

Terre Haute IN

Your ham headquarters located in the heart of the Midwest. Hoosier Electronics, Inc., 43B Meadows Shopping Center, P.O. Box 2001, Terre Haute IN 47802, 238-1456.

Littleton MA

The ham store of N.E. you can rely on. Kenwood, ICOM, Wilson, Yaesu, DenTron, KLM amps, B&W switches & wattmeters, Whistler radar detectors, Bearcat, Regency, antennas by Larsen, Wilson, Hustler, GAM. TEL-COM Inc. Communications & Electronics, 675 Great Rd., Rt. 119, Littleton MA 01460, 486-3040.

Laurel MD

Kenwood, Drake, ICOM, Ten-Tec, Swan, DenTron, Tempo and many ham accessories. Also computers by Apple and Exidy. Call toll free 1-800-638-4486. The Comm Center, Inc., Laurel Plaza—Rt. 198, Laurel MD 20810.

St. Louis MO

Experimenter's paradise! Electronic and mechanical components for computer people, audio people, hams, robot builders, experimenters. Open six days a week. Gateway Electronics Corp., 8123-25 Page Blvd., St. Louis MO 63130, 427-6116.

Camden NJ

X-band (& other frequencies) Microwave Components & Equipment. Laboratory Grade Test Instruments, Power Supplies, 1000's in stock at all times, BUY & SELL all popular makes—HP, GR, FXR, ESI, Sorensen, Singer, etc. Lectronic Research Labs, 1423 Ferry Ave., Camden NJ 08104, 541-4200.

Syracuse—Central NY

We deal, we trade, we discount, we please! Yaesu, Ten-Tec, Cushcraft, Drake, DenTron, KLM, Midland, B&W, ICOM, Hygain, Swan, Amcom, Telco, Mirage, DSI etc. Complete 2-way service shop! Ham-Bone Radio (Div. Stereo Repair Shop) 3206 Erie Blvd. East, Syracuse NY 13214, 446-2266.

Syracuse—Rome—Utica NY

Featuring: Yaesu, ICOM, Drake, Atlas, DenTron, Ten-Tec, Swan, Tempo, KLM, Hy-Gain, Mosley, Wilson, Larsen, Midland Southwest Technical Products. You won't be disappointed with equipment/service. Radio World, Oneida County Airport-Terminal Building, Oriskany NY 13424, 337-2622.

Phila. PA/Camden NJ

Waveguide & coaxial microwave components & equipment. Laboratory grade test instruments, power supplies. Buy, sell & trade all popular makes, HP, GR, FXR, ESI, Sorensen, Singer, etc. Lectronic Research Labs., 1423 Ferry Ave., Camden NJ 08104, 541-4200.

Scranton PA

ICOM, Bird, CushCraft, VHF Engineering, Antenna Specialists, Barker & Williamson CDE Rotators, Ham-Keys, Belden, W2AU/W2VS, Shure, Regency, CES Touch-Tone pads, Radio Amateur Callbooks. LaRue Electronics, 1112 Grandview St., Scranton PA 18509, 343-2124.

Houston TX

Experimenter's paradise! Electronic and mechanical components for computer people, audio people, hams, robot builders, experimenters. Open six days a week. Gateway Electronics Inc., 8932 Clarkcrest, Houston TX 77063, 978-6575.

San Antonio TX

Complete 2 way service shop. Call Dee, W5FSP. Selling Antenna Specialists, Avanti, Azden, Bird, Hy-gain, Standard communications, Genave, Henry, CushCraft, Hustler, ICOM, KDK, MFJ, Nye, Shure, Swan, Tempo, Ten-Tec and others. Appliance & Equipment Co., Inc., 2317 Vance Jackson Road, San Antonio TX 78213, 734-7793.

Davenport WA

Preassembled all band antennas 160m/10m. Trap models start at \$36.50, no trap models start at \$54.50. Complete ham radio repair and parts. Electronic Communications Service Co., Rt. 1-78K, Davenport WA 99122, 725-6822.

Port Angeles WA

Mobile RFI shielding for elimination of ignition and alternator noises. Bonding straps. Components for "do-it-yourself" projects. Plenty of free advice. Estes Engineering, 930 Marine Drive, Port Angeles WA 98362, 457-0904.

DEALERS

Your company name and message can contain up to 25 words for as little as \$150 yearly (prepaid), or \$15 per month (prepaid quarterly). No mention of mail-order business or area code permitted. Directory text and payment must reach us 45 days in advance of publication. For example, advertising for the April issue must be in our hands by February 15th. Mail to 73 Magazine, Peterborough NH 03458. ATTN: Aline Coutu.

73

Add 'Em Up: An IC-22S Programmer

—select a frequency by adding the settings of three switches

Like many other IC-22S owners, I soon tired of the diode matrix rat race. It began to look as though I was just going to have to

live with about twelve programmed frequencies. A dozen channel frequencies is about all that I can commit to memory, and I don't

like fumbling for a cross-reference table when amnesia strikes. However, I couldn't sit still for this limitation, since I'd just

replaced a twelve-channel rock rig.

At the suggestion of friends, a literature search for alternatives was begun. The hunt disclosed what are essentially two schemes. The first was to install a switch calibrated for 50 or 100 common splits. The other was any of a family of external programmers that used a switch register employing binary toggle or DIP switches, BCD, or octal thumbwheel switches, etc. Option 1 was slick, but I wanted as near to all 256 frequencies available as possible. Option 2 returns us to the translate-table arena and, to me, was as unsatisfactory as ever.

I went back to head-scratching, but not for long, because—Eureka!—an appealing symmetry quickly appeared. Here's what I saw: Take the programming number, N, which is made up of 8 binary digits set with your diodes. Note that if N is 108, the synthesizer fre-

Photos by N4ZM



Photo A. The IC-22S at AA4RM.

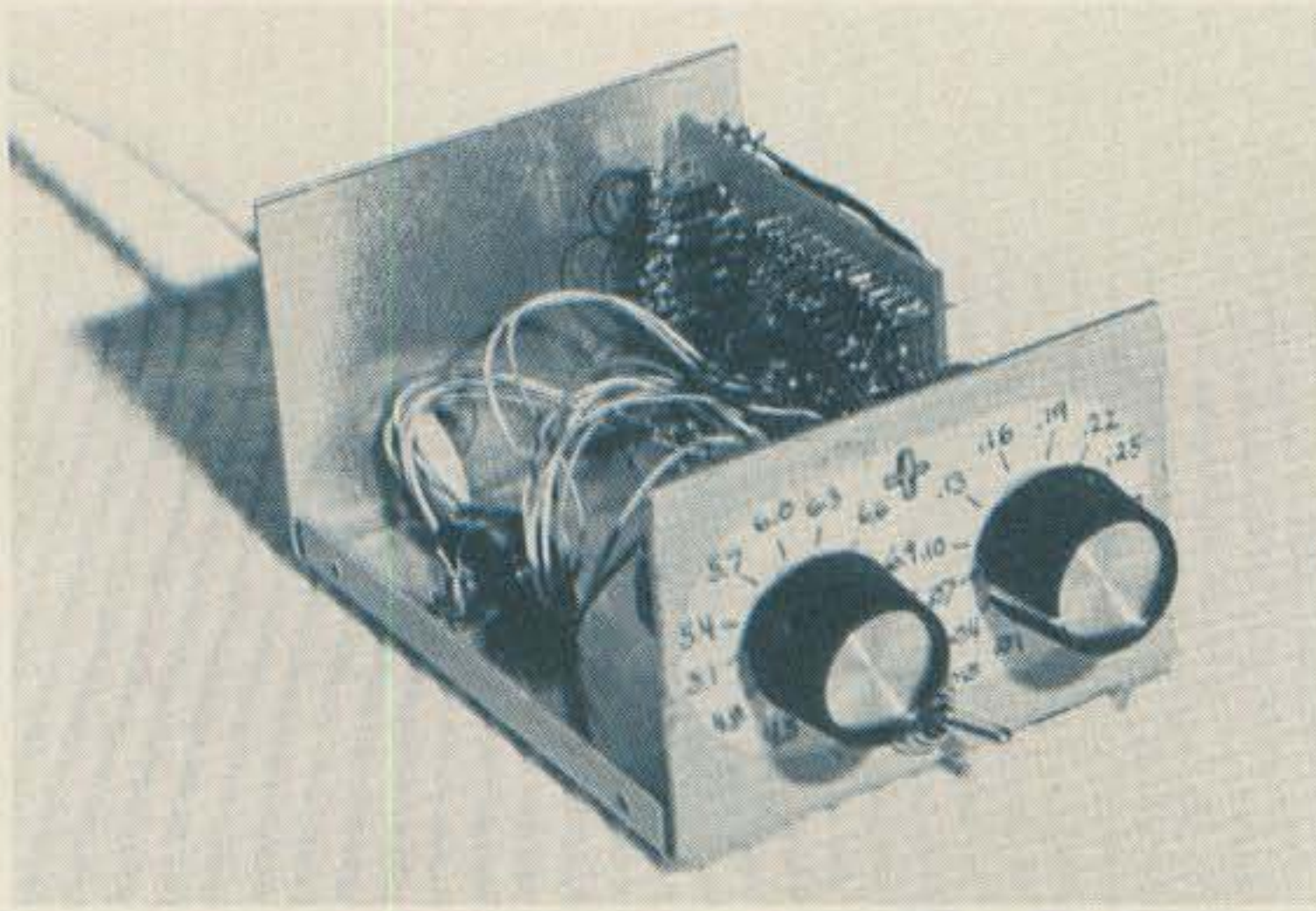

Photo B. Option one.

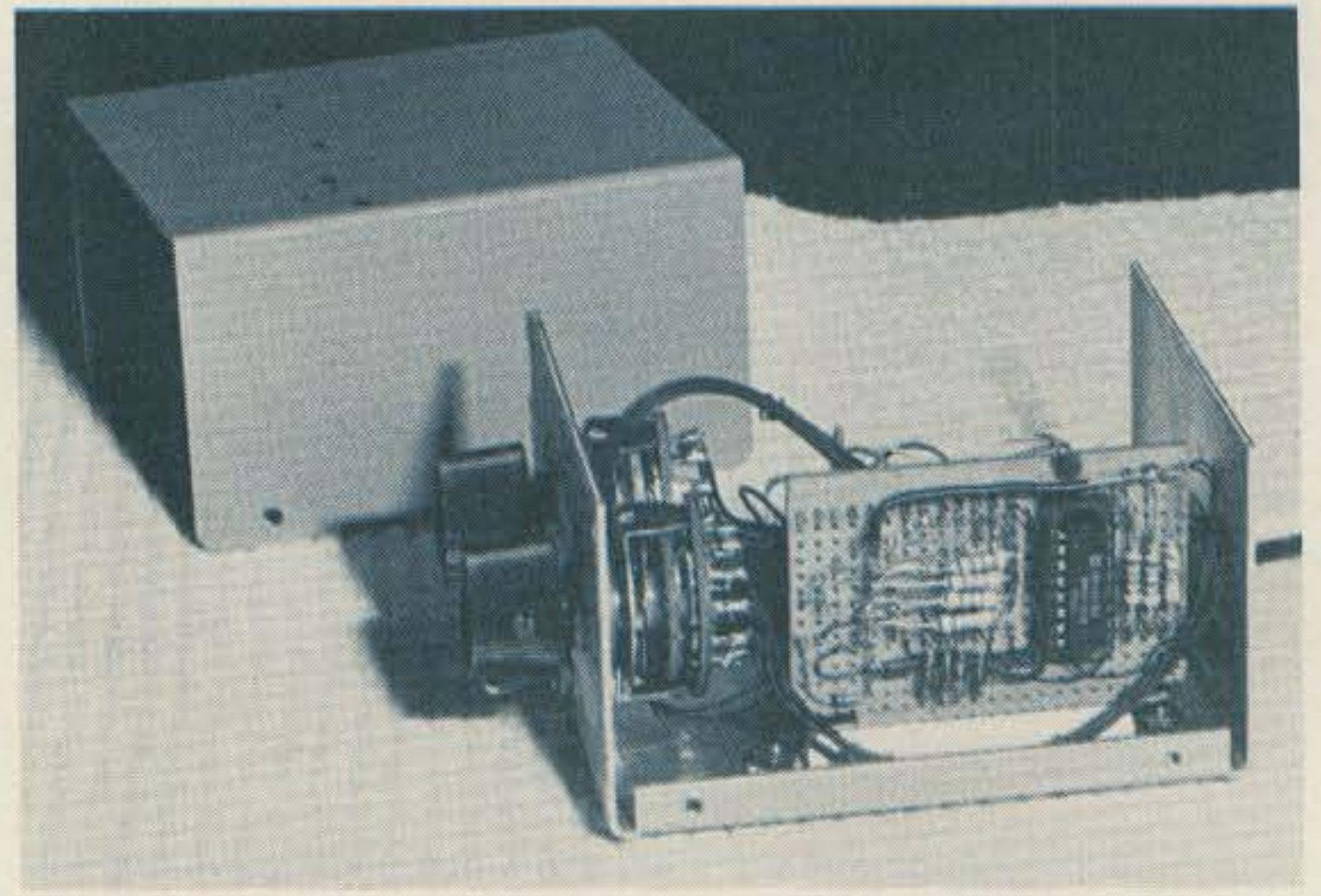

Photo C. Option two.

quency is 146.01 MHz. Check that if 20 is added to N, we go up 300 kHz to 146.31 MHz. And a scheme then emerged. What if I built a system using two diode matrices? One would select 300-kHz steps and the other would fill in the intermediate twenty 15-kHz intervals. Somehow I could then add them together and send the result to the IC-22S. I'd have but two simple switch readings calibrated directly in frequency to mentally add together to determine where I was operating. (Example: 146.31 MHz + .06 MHz = 146.37 MHz.) Bliss would reign.

What I actually built works this way: The 22S gets an N made up of the sum $N1 + N2 + N3$ (instead of $N1 + N2$ as above). I have a single-pole, 12-position rotary switch calibrated from 144.51 MHz ($N1 = 8$) through

147.81 MHz ($N1$ interval = 20). There is a second rotary switch with 10 positions starting at .00 MHz ($N2 = 0$) through .27 MHz ($N2 = 18$), with 30-kHz intervals ($N2$ interval = 2). 15-kHz settings are made with a toggle switch setting $N3$ equal to 0 or 1. This setup allows selecting 240 of the 256 possible frequencies.

I admit that doing the addition initially sounded like a job for a bagful of logic. However, it turns out that only one chip is needed to do the deed. It's called a four-bit full adder and has two names: 74C83 or 4008. Before going further, you may note that these are the very low-current CMOS numbers. Well, the 22S already uses CMOS logic and has 9 volts regulated to match. One more chip on that line seems to bother no one.

Back to the operational aspects. It takes eight bits

or binary digits to represent any number in the range 0-255. Icom uses a notation wherein D0 is the least significant bit (coefficient of 1) and D7 the most significant (coefficient of 128). Refer now to Fig. 1. Generally, to add a selection from the $N1$ matrix to a selection from the $N2$ matrix requires operations on all bit positions from the first which is common to both, D2, up through D7. Note here that the $N3/15$ -kHz bit, D0, is common to neither $N1$ nor $N2$ and doesn't enter into

these adding considerations.

Regardless, working with D2 through D7 is working with 6 bits, not 4. However, by picking 128 as one of the "stops" for $N1$, we get around the need for having bits D7 and D6 added. Stated another way, D6 will never be simultaneously "on" in any pair of $N1$ and $N2$ matrix selections. Hence there will be no "overflow" or "carry" out of the summed D6 values into D7. The resultant D6 (that sent to the 22S) is formed from a

SWITCH	FREQ. (MHz)	DIODE SETTINGS					
		VALUE NAME					
		128	64	32	16	8	4
		D7	D6	D5	D4	D3	D2
1	144.51	8				X	X
2	144.81	28			X	X	X
3	145.11	48		X	X		
4	145.41	68	X				X
5	145.71	88	X	X	X	X	
6	146.01	108	X	X		X	X
7	146.31	128	X				
8	146.61	148	X		X		X
9	146.91	168	X	X		X	X
10	147.21	188	X	X	X	X	X
11	147.51	208	X	X	X		
12	147.81	228	X	X	X		X

a) N1 MATRIX

SWITCH	FREQ. (MHz)	DIODE SETTINGS			
		VALUE NAME			
		16	8	4	2
		D4	D3	D2	D1
1	.00	0			
2	.03	2			X
3	.06	4		X	
4	.09	6		X	X
5	.12	8	X		
6	.15	10	X	X	
7	.18	12	X	X	
8	.21	14	X	X	X
9	.24	16	X		
10	.27	18	X		X

b) N2 MATRIX

Fig. 1. Diode matrix layouts.

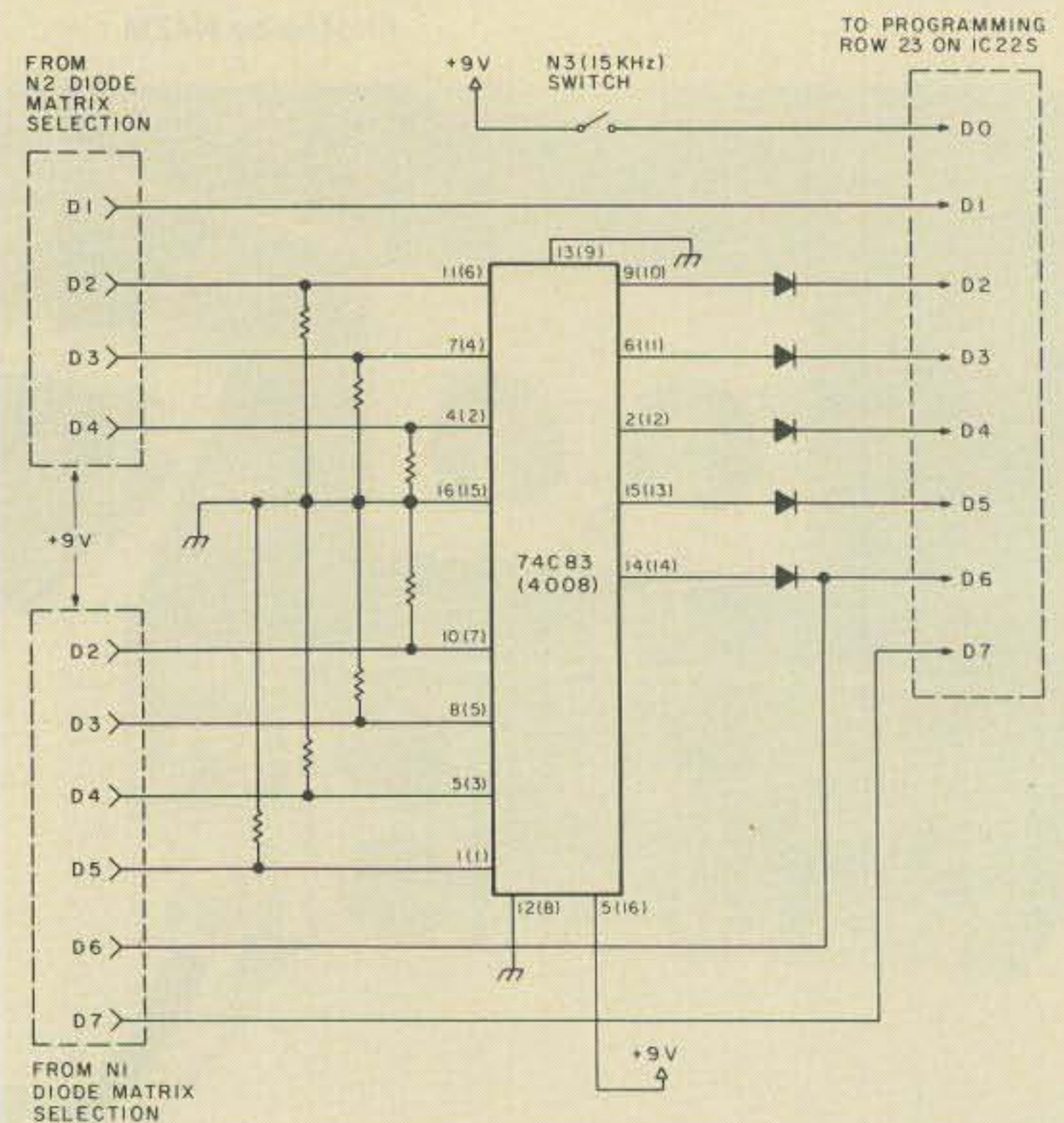

Fig. 2. Programmer schematic. All diodes are 1N918, 1N4148, etc. All resistors (pull-downs) are 27k, 1/4 W. +9V is taken from diode supply voltage in the 22S at board position 23 (channel "0").

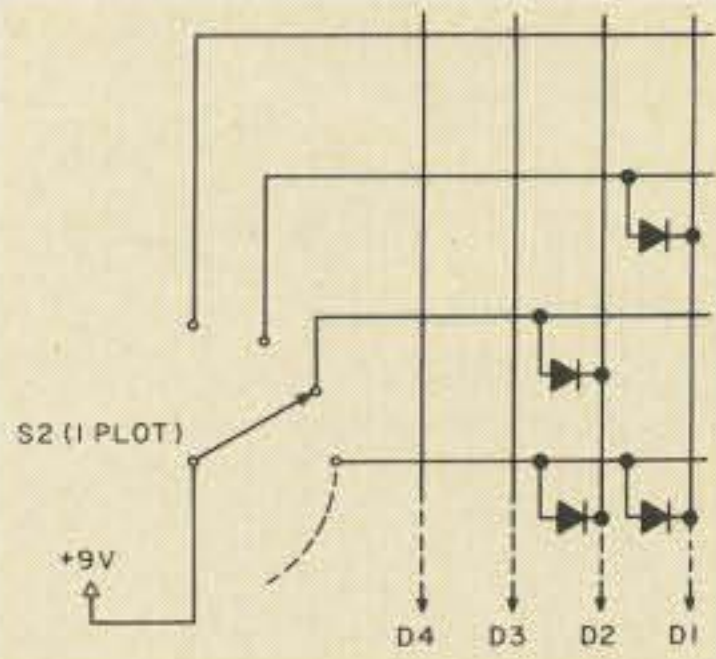

Fig. 3. First four elements of the N2 diode matrix. Refer to Fig. 1 for the remainder of N2 and all of N1 diode placements. All diodes are 1N918, 1N4148, etc.

"wired diode OR" of the carry out line of the 4-bit adder with the D6 line from the N1 matrix. The four-bit adder has lines D2 to D5 input from the N1 matrix, and lines D2 to D4 from the N2 matrix (N2's D5 is "made" zero since it doesn't exist).

Fig. 2 shows the electrical connections for the programmer. Pin connections in parentheses are for the

4008 chip; the others are for the electrically interchangeable 74C83. Fig. 3 is a schematic excerpt of the smaller diode matrix and switch.

I built the programmer into a small 3-3/8" x 3" x 2-1/8" utility box (LMB CR332). The photos show the construction used. All electronics are on a little piece of perfboard. The diode matrices are fabricated by pushing a "row" of cathodes through the board and tying them together with one strand of a piece of 7 x 22 hookup wire. The column anodes are similarly terminated. The connections to the IC-22S internal diode matrix board are made through a 10-conductor cable (8 logic lines, +9 volts, and ground). Logic and +9 V go through the 9-pin accessory socket. The ground connector is anybody's choice (I used two pieces out of a wrecked

Molex plug). I might point out that I get +9 V from the diode matrix supply connection for the channel where the programmer will be selected. This means that the only IC-22S internal connections are to the diode matrix board. Additionally, it means that when you move off the programmer channel, the programmer is disabled and it's business as usual in the 22S.

The parts count for the little beauty is low. About 51 diodes, 7 resistors, 2 switches, the chip, etc. The buck count is commensurately small, as I spent just under \$8 for all new parts. Design, layout, and debugging took 3 nights. However, I might note that this was my first foray into the area of CMOS and at first I omitted the pull-down resistors, which caused some very puzzling results. Also, I had never used perfboard/push-terminal

construction before. After parts accumulation, I think an experienced person should be able to build the programmer in one evening.

A final note about dial calibration. All N1 settings are scribed with the 1-kHz suffix omitted, and N2 readings have 1 kHz added. That is, 144.51 MHz on N1 is written 144.5, and .00 kHz on N2 is called .01 kHz, etc. This greatly improves one's ability to mentally add the N1 reading to the N2 (and N3, if "on") to get the effective frequency selected.

The programmer has a side advantage in that you (as I do) can use it as a remote tuning head. The 22S can skulk under the seat where one can "braille-read" the relatively large power and frequency-split front-panel toggle switches. You may never see the 22S face-to-face again until the car is traded. ■

NEW!

HAL

PS-1.0 GHZ

PA-19

WIDEBAND PREAMPLIFIER

- 1.00 GHZ pre-scaler ÷ by 1000
- Broadband operation 10HZ to 1.25 GHZ
- High sensitivity
- Standard T2L or ECL power supply
- Dual mode operation—VHF/UHF
- Independent VHF and UHF inputs
- Divide by 1000 so it can be used with any counter having seven digits or more.
- Circuit uses only four chips.
- Fully assembled and tested.

- 2 to 200 MHz band width (– 3db points)
- 19 db gain
- 50 ohms input & output impedance
- Tiny PC Board size (7/8" × 1-5/8")
- Absolutely no tuning required
- Extremely stable
- Draws only 20MA at 12 v dc
- Great way to increase sensitivity of receivers, counter, etc.
- Fully assembled and tested
- Instructions provided, full warranty.



"HAL" HAROLD C. NOWLAND
WBZXH

\$79.95

HAL-TRONIX

P.O. Box 1101
Southgate, MI 48195
(313) 285-1782



\$8.95

SHIPPING INFORMATION ORDERS OVER \$15.00 WILL BE SHIPPED POSTPAID EXCEPT ON ITEMS WHERE ADDITIONAL CHARGES ARE REQUESTED. ON ORDERS LESS THAN \$15.00 PLEASE INCLUDE ADDITIONAL \$1.00 FOR HANDLING AND MAILING CHARGES. SEND SASE FOR FREE FLYER.

The Oscilloscope Survival Course

— the finer points of scope usage

Let's face it; in this day and age, one of the handiest pieces of electronic equipment you can own is an oscilloscope, and there is a good chance that if you do much building, you either own a scope or want to buy one. That's great, because there is nothing like a scope picture to show you what a signal looks like. However, you must know the finer points of using a scope to get the full benefit of the instrument, and that is what this article is all about.

If you have read my other "Survival Course" article you will understand that I am trying to discuss the finer points of using modern electronic test equipment. Most of my hints are based on actual hands-on experience with the latest electronic gear, plus the observations I have made as an engineer. Thus, I am in a position to offer you operating hints that will help you to get more out of your

equipment, and, I hope, to make it last much longer. You might not find many of the things I discuss mentioned in the user manuals that come with your equipment, as the manufacturer often takes for granted you have some knowledge of the equipment or chooses to ignore the basics of the product. I feel that since many changes are taking place in the instrument industry, it is especially important to discuss the often-overlooked fine points of test instruments. With that, let's spend some time with the oscilloscope.

Let's limit our discussion of oscilloscopes to the more common units with single-ended vertical-input amplifiers. There are so many different types of scopes and combinations of plug-ins, that there just isn't room to discuss the samplers, spectrum analyzers, logic analyzers, and umpteen more combinations of scopes. It would take several books just to

cover the use and care of such exotic devices! If enough readers are interested in a particular type of scope, perhaps I can oblige with another article, but for this one our discussion is limited to the simpler models.

One of the biggest weaknesses of most scopes is the signal-handling overload ability of the vertical input—and often the horizontal (often labelled "Ext. Sweep") input is even less tolerant. You must exercise reasonable caution when connecting a signal to your scope. What happens if you don't? Depending upon the type of signal (pulse, dc, ac, etc.) and its level, you can expect to blow an FET amplifier and possibly part of the vertical attenuator. Needless to say, watch what you apply to the input jack, because if you don't, you may end up shelving the scope for parts or sending it back to the factory. Let's look at some of the types of voltages to

handle with care and to avoid putting on the input of your scope.

One of the most common ways to kill a vertical amplifier is to put more voltage on the input than it is designed to take. Often the input attenuator will be set to the lowest range, compounding the problem. Thus, the input stage will connect directly to the input jack via any overload protection circuitry. At the first sign of overload, out goes the amplifier! Good sources of high voltage include any form of vacuum tube equipment, power transformer secondaries, and tuned circuits in transmitters. One way that you easily can cause damage to your scope is by using it to tune up your car's engine. Invariably, the input connection will be a turn of wire around one of the spark plug leads; all that's necessary is one arc through the wire—and scratch one scope! This method of tuning up an

engine is fine, but some basic precautions must be taken. It should be mentioned that you can kill an input amplifier with less than a cycle of an overload signal if it is great enough.

The precautions that you can take to save your scope from overloads are simple and easy to implement. First, you should know the capability of your scope. Dig out the manual, if necessary, and look in the specifications section for the rated maximum input voltage on the vertical input. Note that if only one voltage is given, it must be the total of any dc plus the peak value of any ac signal. Thus, if you are looking at the plate of a tube and see 150 volts dc and a 15-volt ac signal, the total voltage to the scope is 165 volts. Remember this total value, as sometimes it is easy to forget how the voltages combine and can exceed the maximum input of your scope. If you can't find how much voltage your scope can take, simply check the vertical attenuator for a clue. If the highest range is 20 volts per division and there are 10 divisions, you can safely apply $20 \times 10 = 200$ volts. Generally, there's a 150% or greater overload factor, so you can apply up to 300 volts peak-to-peak.

If there is a switch-selectable coupling capacitor on the input of your scope, you are limited to the total dc plus peak ac voltage equal to the working voltage of that capacitor, so bear this in mind when you work with large dc offsets. In practice, the lesser of the two (attenuator + overload vs. capacitor working voltage) determines the maximum signal you can safely apply to the vertical input of your scope.

The horizontal input (or Z-axis, or other input) is often less defined as to

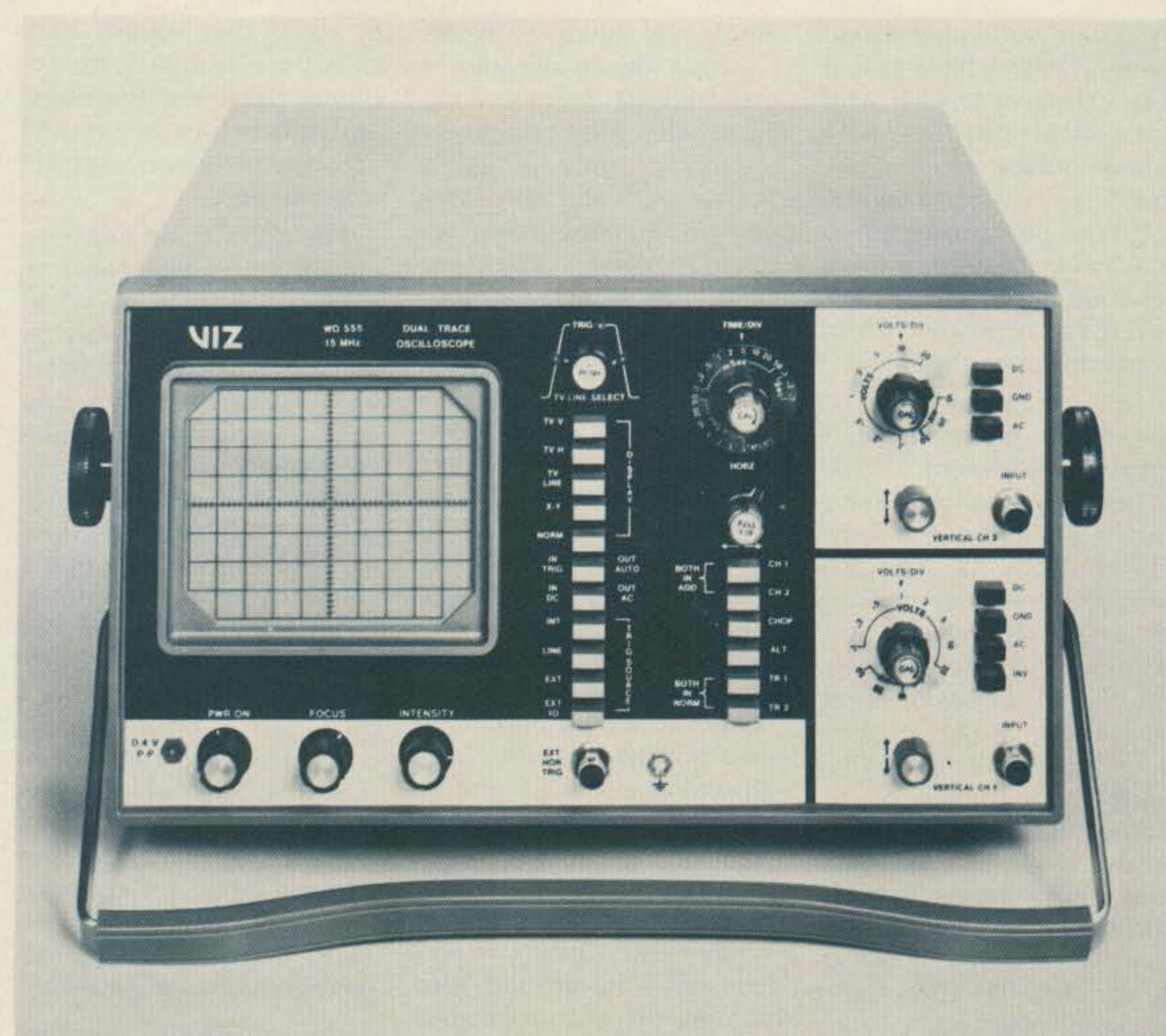

Photo A. VIZ WO 555 15-MHz dual-trace oscilloscope.

what voltage levels it can take. The manual is the best source of information, as there generally is no attenuator on this less-used input. That's unfortunate, because commercial scopes—especially the cheaper ones—do not always have good input protection. Play it safe and limit your input voltages to under 10 volts peak-to-peak if you can't find the voltage rating.

It's easy to avoid damaging input overloads. You should always use scope probes with your unit. Not only are they easy to use, but they are also much safer than alligator clips. Also shielded probes are a must when looking at very low level signals in high-impedance circuits where hum can play havoc with the signal. If you are unsure about the level of the signal, use a X10 probe and set the vertical attenuator to the highest range. Then

connect the probe and adjust the attenuator accordingly for a reasonable display. Avoid exceeding the probe's voltage ratings (usually 500-600 volts) when you make your measurement. Also, the use of a X10 probe offers more protection to the scope due to the attenuating effect of the probe. This is because damaging current is limited by the 9-meg resistor in the probe cable. Watch how you connect the probe to the equipment. If possible, power the equipment first, connect the probe, adjust the attenuator, and then read. Remove the probe, turn off the power, and you are all set.

This method allows you to quickly remove the scope from the circuit in case of an overload, minimizing any damage. Also, any equipment turn-on/turn-off surges won't reach the scope and fry the front end circuitry. To be com-

pletely safe, check the schematic of the equipment you are working on and avoid any point with voltages higher than the scope/probe combination can handle. This includes power transformer secondaries (tube equipment), tank coil circuitry in transmitters, and so on. Let me wrap this up by saying that overvoltage is still one of the more common ways to kill a scope, and despite low-voltage logic circuitry becoming more common, it can be a problem. With just a few simple precautions, you shouldn't have problems.

Another sort of input overload problem is more subtle and needs explanation. That is the effect high pulse voltages have upon a scope input circuit. Often you can be measuring a signal containing a pulse big enough to damage your scope and not know it. If you do much

TV repair, you know what I mean! TV sets have stages like the vertical and horizontal outputs with skinny pulses, plus signal, that can exceed several kV! Your best protection is to check the equipment schematic and avoid measurement on any point marked "Do Not Measure."

Now you know why this phrase turns up in electronic equipment. What happens when you measure one of these points? The pulse gets into the probe, sometimes causing internal arcing. It may damage the internal resistor on X10 probes or break insulation in X1 probes, and the result is always permanent change of accuracy. If the signal gets into the scope attenuator, it may cause arcing in resistors and capacitors, changing the accuracy of the attenuator. If that isn't enough, the pulse may reach the input FET, knocking it out and—get this—often *without* harming the over-voltage protection circuitry! This is because the over-voltage protection circuitry may act too slowly to save the FET, which must be a fast device.

So play it safe, and keep away from those "Do Not Measure" points. Also, be wary of any part of a circuit where there is an inductive component (transformer, choke, etc.) involved, plus any power handling circuitry. These combinations are good candidates for big pulses. Prime types of equipment to be careful around include radar (naturally), any TV, most transmitters with tubes, and unloaded power transformers. Transformers are mentioned because they generate horrendous spikes when power is removed. Either put a load on them or use the scope only when power is on.

While on the subject of

inputs and signals to avoid, I would like to mention a situation that comes up occasionally that damages the cables only. I call it "cable-itis," and the story on this ailment goes like this: On good scopes, the case is grounded to earth through the 3-wire power cord and the building wiring. Not to be forgotten is the fact that it is sometimes necessary to check either the power line or some piece of equipment not containing a power transformer. So, with conditions like these, it is inevitable that the ground clip on the cable is connected to the ground in the equipment. Since that ground is either ground or 120 volts, depending upon which way the equipment plug is inserted, the result is *boom!* Scratch one scope cable. Often you will lose only the ground wire coming off the probe, but more important is the harm that can be done to you when the wire explodes. Play it safe and always use an isolation transformer on the equipment in such a case. Never use an adaptor plug on the scope, since the case still will be hot—and that can be just as dangerous as a wire exploding.

Your input cables and probes are just as important as the scope itself. Let's take a quick look at the different types and what they can do for you. Coax cable is used for most general-purpose connections to the scope. It offers shielding to the signal and not much more. A pitfall you should know about is that the capacitance of coax cable is high—and that means increasing attenuation as your input frequency goes up. In fact, if you use just three feet of any coax cable, your input impedance (standard scope impedance) of 1 meg will drop quickly as you check frequencies above 1 MHz

or so. If that sounds bad, substitute ordinary microphone cable for the coax, and the higher losses will attenuate your signals even further!

The point is, an ordinary coax cable is best for only general-purpose low-frequency use. If you want to work at high frequencies, you either shorten the cable or terminate it at the scope end with a resistor. Commercial scope probes offer a way around these limitations. While there is a standard X1 scope probe, its primary purpose is for general low-frequency applications. Most X1 probes offer little improvement over the coax-and-clip-leads lash-up, electrically. Mechanically, however, a X1 probe offers a safer and easier method for connecting to a piece of equipment. Thus, that X1 probe is recommended for most uses.

Of course, if you are looking at the output of, say, a signal generator, you would find a coax cable with mating connectors on each end a much more desirable way to go. But the choice is yours. The most useful probe, and one that offers a higher degree of safety to the user, is the X10 probe. Not only does it divide input signals by 10, but it raises the input impedance to 10 megs at dc levels. These features allow you to read higher voltages with your scope while providing a greater safety margin, and you can work with sensitive circuits with reduced loading. And, to top that off, good X10 probes have extended frequency response and less capacitive loading so that you can look at rf voltages with vastly reduced loading due to the probe. This means less disruption of the circuit and more accurate waveforms on the scope. Typical X10 probes have responses to within a few dB from dc to 60 to 100

MHz. This probe is thus a necessity to anyone working with signals in the rf range, and you should have one.

There is a very good X10 probe on the market—the Heath PKW-105. Made in England, it offers switchable X1-ground-X10 positions, plus a bunch of adaptors for making different types of connections. At \$28.00, it's not cheap, but that's better than half the cost of other probes.

To get maximum performance out of a X10 probe, you should be aware that they all have a compensation trimmer to null out cable capacitance. You connect the probe to your scope and touch the probe tip to a square wave signal source. Then you adjust the compensation trimmer to make the corners of the waveform as square as possible. This simple step will give you maximum bandwidth out of your probe/scope combination.

Let's continue by discussing the controls on the front panel of your scope. Since all scopes are slightly different, I can describe only the common controls among them. You will note, however, that the controls I mention are for a scope with triggered sweep. If you have the asynchronous type of scope, you can probably relate some of the things we are talking about—then someday they will mean more when you get a better scope. If you get the impression that I don't care for the free-run sweep scope (asynchronous), you are right. Their uncalibrated vertical amps, unstable sweep, and nonlinear trace have precluded their use in serious electronics work. About the only thing asynchronous scopes are good for is as modulation monitors, and that's fact! They are toys. If you are buying a new scope, avoid this type

of scope and you will avoid being sorry. Spend the extra money to get a decent unit.

Let's start with the vertical controls. These include the vertical sensitivity switch (sometimes called Vertical Attenuator), vertical gain adjust (sometimes called Vert. Sens. Vernier), and the vertical centering control.

Basically, the vertical sensitivity is a coarse gain adjust with typical positions labelled 1-2-5, for 1 mV, 2 mV, and 5 mV. It is used to set the gain of the vertical section of the scope to what is appropriate for your signal. This control is one of the most-used on your scope.

The vertical gain vernier is just a pot that fine-tunes the sensitivity of the vertical input over a small range. In short, it is a calibration control, as it affects the sensitivity of your input. Normally, there is an off or CAL position at which to set this knob, so that the vertical input is calibrated and the sensitivity is equal to the numbers on vertical sensitivity knob.

The vertical centering knob is used to move the trace around the screen, or center it, as the name implies. That takes care of basics with which you already should be familiar.

There are a number of things to consider when setting the vertical controls on your scope. For longer life, it is wise to keep the vertical attenuator set at the highest range, even when the scope is not used. As mentioned before, one of the easiest ways to kill a scope is to put a 200-volt signal on it when it is set to the 2-mV position. Play it smart and keep that switch set to the highest voltage position if you don't know your input voltage. And, better yet, use a X10 probe. The vertical gain vernier pot is always left in

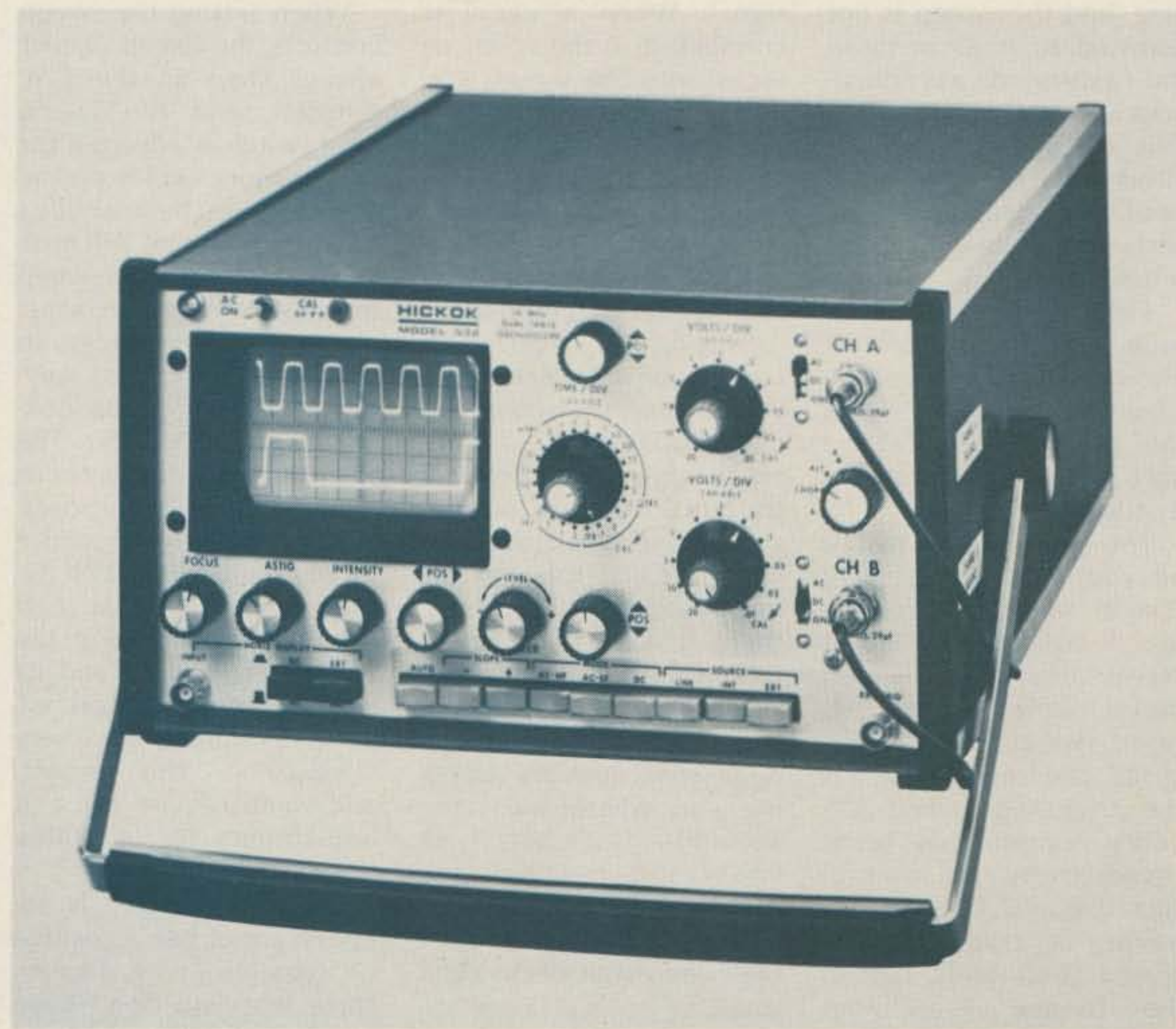

Photo B. Hickok Model 532 30-MHz dual-trace oscilloscope.

the CAL position, of course. The only exception to this is when you want to look at the top of a waveform just slightly larger than the screen and don't want to change the attenuator position. Turning the knob reduces the gain and allows you to see all of the waveform.

This knob also is useful when setting your scope up for Lissajous figures and X/Y measurements, where you are comparing two signals and want them to be the same size. The vertical centering control is used to position the trace and waveform at a convenient place on the screen. This is done, of course, so that the waveform can be positioned on the graticule (illuminated crosshair on screen) for measurement.

If your scope is left on unattended for long times, it is wise either to turn the

centering control so the trace is off the screen or to turn the intensity control down to extinguish the screen. This will save you from burning a hole or creating a dim spot in the CRT. CRTs are expensive, so always take a moment to move or dim the trace before leaving the scope unattended.

The next important controls are the horizontal sweep controls. These include the sweep time switch, sweep time vernier, and the triggering controls. The sweep time switch is the most often used of the group, and its function is to set the sweep speed, or the rate at which the spot moves across the screen. Typically, this switch is calibrated in a 1-2-5 sequence like most vertical attenuators, and the numbers correspond to values like 1 ms, 2 ms, 5 ms, and so on. Note that these

values are always in time-per-division on your scope. If you set the switch to 10 ms and you have 10 divisions, your total sweep time is 100 ms. This is important when estimating frequency of a signal off your scope.

The sweep time vernier is a pot, and its function is to change the calibration. Like the vertical vernier, it allows fine tuning of the sweep, and, also like the vertical vernier, the sweep time vernier normally stays in the CAL position.

The trigger controls consist of the slope switch, trigger level, and auto/manual trigger switch. These controls get almost as much use as the sweep time switch, so you should be familiar with them. The slope switch selects the point at which the sweep starts on your input signal. Remember that in a scope with triggered sweep, the signal starts the sweep run-

ning, and the sweep is not adjusted to it as in those old-fashioned asynchronous scopes. The switch tells the sweep to trigger either when the signal goes positive or negative and is nothing more than a coarse setting.

The trigger level is a fine-tune adjustment, and it allows you to move the trigger point up or down the positive or negative part of the waveform (set by the slope switch).

The auto/manual switch on your scope may have several names, but regardless of what it is called, it serves one purpose and that is to select normal triggered sweep or a free-run mode. The free-run mode is the triggered sweep circuitry continuously being triggered by an internal signal source. This ensures having a trace on the screen at all times, even in the absence of an input

signal. When a signal is connected to the scope, it locks onto the signal, triggering properly. This free-run mode is valuable for when you are looking at a dc signal or a steep-sided ac signal that may not trigger the scope properly in the manual-trigger mode.

Setting the horizontal sweep controls is easy. If you turn on the scope and can't find the trace, simply set the auto/manual switch to auto to bring on the sweep and adjust the centering controls. On the more expensive scopes, there is a switch marked Beamfinder to minimize knob-tweaking. You simply press the button and a large spot appears showing you where the trace should be. If it's not where you want it, you adjust the centering controls to put it where you want and adjust the sweep controls to get a trace.

When setting the sweep controls, the sweep vernier always stays in the CAL position, and the sweep time switch is adjusted for two or more cycles on the screen. If you have no idea of what the signal will look like, always start the sweep time switch on its lowest position (slowest sweep) so that you don't miss anything. This is fine for looking at dc levels, too. The 100 ms/div position is about right for most purposes. You probably will spend a lot of time fiddling with the triggering controls, as their positions may vary with the size of your signal and its shape. Even the most expensive scopes are very "tweaky" in this respect, and some require a lot of adjustment for a stable trace.

The slope switch is adjusted for either a positive or negative going display. Note that you don't have much choice if your signal is a logic level, swinging from ground to plus 5 volts!

The auto/manual switch is set to suit you—or, if you can't trigger on your input signal, try auto. Then, the trigger level control is adjusted for a stable trace. If you have trouble locking in the signal, a good rule of thumb is to check the slope switch, then switch to the auto sweep (auto/manual switch), and adjust the trigger level. This should do it. If you are looking at many signals at once, like a line of TV composite video, for example, remember that you will be able to lock in only the vertical or horizontal sync pulses, and not the video or all signals at once. The fact that a triggered scope can lock only one signal at a time is overlooked at times!

The remaining scope controls are few and easy to adjust. The intensity control is adjusted to show the trace in normal am-

bient light. Excessive brightness usually broadens the trace, making identification of narrow pulses difficult, so use minimum brightness. If necessary, move the scope away from bright overhead lights, or cut a lightshield for the CRT to screen out glare.

The focus control is adjusted for the sharpest trace, or course, but you can sometimes expose a narrow pulse in a signal by defocusing slightly; try it! That takes care of the scope panel controls.

Your scope has many important physical features of which you may not be aware. First, most low-cost scopes are very sensitive to magnetic fields. The most sensitive areas are the face of the CRT and the back of the scope. If you get too close to a magnetic field, you will bend the trace, and that can goof up your readings. Keep away from large power transformers, for example. Also, high-performance scopes generate quite a bit of heat, so for longer life allow plenty of ventilation. That means you should never stack equipment next to and over your scope if it generates a lot of heat. Finally, you should know that scopes are very sensitive to drops. If you drop it, or if it falls off a bench, you probably will damage something (not the CRT, one hopes). At the least, the calibration may have changed, so always check after a drop. It is wise to open the case and visually check the chassis for anything that has broken loose. Then, resolve to put it in a more secure place next time!

Let's hope this article enables you to get a little more out of your scope. It's tough to cover a subject like this in such a short article, but high spots have been discussed and pitfalls exposed, and that should help. ■



**Germantown
Amateur
Supply,
Inc.**

MEMPHIS, TENNESSEE



NO MONKEY BUSINESS!

- (A) Complete Service Facilities
- (B) Good Deals on most Brands
- (C) Shipping within 24 Hours
- (D) All inquiries handled by Active Hams with over 20 years experience in ham radio

CALL TOLL FREE
1-800-238-6168

IN TENNESSEE, CALL 901-452-4276
MONDAY - SATURDAY 8:30-5:30
FOR YOUR SPECIAL.

Write: 3202 Summer Ave., Memphis, Tennessee 38112

When quality counts

Do not be fooled by the low prices, these brand new lab quality frequency counters have important advantages over instruments costing much more. The models 7010 and 8010 are not old counters repackaged but 100% new designs using the latest LSI state-of-the-art circuitry. With only 4 IC's, our new 7010 offers a host of features including 10 Hz to 600 MHz operation, 9 digit display, 3 gate times and more. This outperforms units using 10-15 IC's at several times the size and power consumption. The older designs using many more parts increase the possibility of failure and complexity of troubleshooting. Look closely at our impressive specifications and note you can buy these lab quality counters for similar or less money than hobby quality units with TV xtal time bases and plastic cases!

Both the new 7010 and 8010 have new amplifier circuits with amazingly flat frequency response and improved dynamic range. Sensitivity is excellent and charted below for all frequencies covered by the instruments.

Both counters use a modern, no warm up, 10 MHz TCXO [temperature compensated xtal oscillator] time base with external clock capability - no economical 3.579545 MHz TV xtal.

Quality metal cases with machine screws and heavy gauge black anodized aluminum provide RF shielding, light weight and are rugged and attractive - not economical plastic.

For improved resolution there are 3 gate times on the 7010 and 8 gate times on the 8010 with rapid display update. For example, the 10 second gate time on either model will update the continuous display every 10.2 seconds. Some competitive counters offering a 10 second gate time may require 20 seconds between display updates.

The 7010 and 8010 carry a 100% parts and labor guarantee for a full year. No "limited" guarantee here! Fast service when you need it too, 90% of all serviced instruments are on the way back to the user within two business days.

We have earned a reputation for state-of-the-art designs, quality products, fast service and honest advertising. All of our products are manufactured and shipped from our modern 13,000 square foot facility in Ft. Lauderdale, Florida.

When quality counts...count on Optoelectronics.

MODEL 8010 1 GHz

MODEL 7010 600 MHz



- 100% U.S.A. FACTORY ASSEMBLED
- 100% PARTS & LABOR YEAR GUARANTEE
- CERTIFIED NBS TRACEABLE CALIBRATION
- EXTERNAL CLOCK INPUT

- DISPLAY HOLD FUNCTION
- 9 RED LED DIGITS 4" HIGH
- .1 Hz RESOLUTION
- 0.1 PPM 10 MHz TCXO TIME BASE

- LAB/PORTABLE-AC ADAPTER INCLUDED
- 1 MEGOHM & 50 OHM INPUTS
- STATE-OF-THE-ART LSI DESIGNS
- COMPREHENSIVE USER MANUAL PROVIDED

• COMPACT SIZES—7010- 1-3/4" Hx4-1/4" Wx5-1/4" D 8010- 3" Hx7-1/2" Wx6-1/2" D

MODEL	\$ PRICE	RANGE 10Hz to	LED DIGITS	SENSITIVITY			HI-Z INPUT 10Hz - 60 MHz	GATE TIMES	RESOLUTION			TCXO TIME BASE		EXT. CLOCK INPUT	NI-CAD BATT PACK
				25-250 MHz	250-450 MHz	450 MHz-1GHz			12 MHz	60 MHz	MAX. FREQ.	20°-40° C	FREQ.		
7010 *7010.1	145.00 225.00	600 MHz	9	5-20 mV	10-30 mV	20-40 mV to 600 MHz	1-10 mV	{3} .1, 1, 10 SEC	.1 Hz	1 Hz	10 Hz 600 MHz	1 PPM 0.1 PPM	10 MHz	YES OPTION \$25.	YES OPTION \$15.
8010 *8010.1	325.00 405.00	1 GHz	9	1-10 mV	5-20 mV	10-25 mV	1-10 mV	{8} .01-20 SEC	.1 Hz	1 Hz	10 Hz 1 GHz	1 PPM 0.1 PPM	10 MHz	YES STD	YES OPTION \$39.

* Has precision 0.1 PPM TCXO time base.

MODEL 7010
#7010 600 MHz Counter - 1 PPM TCXO \$145.00
#7010.1 600 MHz Counter - 0.1 PPM TCXO \$225.00

OPTIONS
#Ni-Cad-701 Ni-Cad Battery Pack & charging circuitry
Installs inside unit \$ 15.00
#EC-70 External Clock input, 10 MHz \$ 25.00
#CC-70 Carry Case, Padded Black Vinyl \$ 8.95

MODEL 8010
#8010 1 GHz Counter - 1 PPM TCXO \$325.00
#8010.1 1 GHz Counter - 0.1 PPM TCXO \$405.00
#8010.1-13 1.3 GHz Counter - 0.1 PPM TCXO \$495.00

OPTIONS
#Ni-Cad-801 Ni-Cad Battery Pack & charging circuitry
Installs inside unit \$ 39.00
#CC-80 Carry Case, Padded Black Vinyl \$ 9.95

ACCESSORIES
#TA-100 Telescope Ant with Right Angle BNC \$ 9.95
#P-100 Probe, 50 ohm, 1x \$13.95
#P-101 Probe, Lo-Pass, Audio Usage \$16.95
#P-102 Probe, Hi-Z, General Purpose \$16.95



ORDER FACTORY DIRECT • CALL TOLL FREE



Optoelectronics inc

5821 N.E. 14th Avenue, Fort Lauderdale, Florida 33334

1-800-327-5912

FROM FLORIDA (305) 771-2051/2

TERMS: Orders to U.S. and Canada, add 5% for shipping, handling and insurance to a maximum of \$10.00. All other orders add 10%. C.O.D. collection fee \$1.00. Orders under \$15.00 add extra \$1.00 handling. Regular checks must clear before order is shipped. Florida residents add 4% sales tax.

47 CFR Part 97

(Docket No. 19852; FCC 79-758)

Providing for the Amateur-Satellite Service

AGENCY: Federal Communications Commission.

ACTION: Notice of Proposed Rulemaking.

SUMMARY: The Commission orders a Notice of Proposed Rulemaking to revise Part 97 of the Commission's rules and regulations. It is evident that the amateur satellite service has become an important facet of amateur radio, thus, it is now time to develop rules for the service. Hence, a statement of the amateur satellite service requirements in the rules would give notice to the amateur community on procedures to follow when engaging in amateur satellite service operations.

DATES: Comments must be received on or before February 5, 1980 and reply comments must be received on or before March 6, 1980.

FOR FURTHER INFORMATION CONTACT: Roy C. Howell, Federal Communications Commission, Private Radio Bureau, Personal Radio Branch (202) 254-6884.

ADDRESSES: Federal Communications Commission, 2025 M Street NW, Washington, D.C.

Adopted: November 20, 1979.

Released: December 4, 1979.

In the matter of amendment of Part 97 of the Commission's Rules to provide for Amateur-Satellite Service, Docket No. 19852. See Also 39 FR 1643, January 11, 1974.

Background

1. On February 14, 1973, the Commission adopted amendments to Part 2 of the Commission's rules in Docket No. 19547. These amendments incorporated into the rules the Amateur-Satellite Service (AMSS) as established by the World Administrative Radio Conference for Space Telecommunications in Geneva, 1971. Certain frequencies already allocated to the Amateur Radio Service were also allocated to AMSS. Furthermore, AMSS frequency bands 435-438 MHz are also shared with the Government Radiolocation Service on a secondary basis.

2. On October 25, 1973, the Commission adopted a Notice of Inquiry in Docket No. 19852 which was published in the *Federal Register* on November 6, 1973, 38 FR 30566 (1973). In our Notice of Inquiry, we indicated the desire to receive comments from interested parties concerning: The structures of the new Amateur-Satellite Service: the technical standards licensees in the Service should have to meet; and, the qualifications licensees should possess.

3. The Commission received approximately fifteen comments in response to the October 25, 1973 Notice of Inquiry. All comments received have been carefully analyzed by the Commission's staff and we are now prepared to issue formal proposals in this proceeding.

4. Prior to WARC-ST, five amateur space stations licensed by the FCC were placed in operation. Since WARC-ST, three more space stations licensed by the FCC became operational. These stations were operated pursuant to waiver of the Commission's rules for amateur radio stations (Part 97). It is evident that AMSS has become an important facet of Amateur Radio; thus, it is now time to develop rules for the service. Hence, a statement of the AMSS requirements in the Rules would give notice to the amateur community on

procedures to follow when engaging in AMSS operations. Therefore, the Commission could discontinue its present system of granting waivers on an individual basis. Consequently, the end result would be uniform regulations of AMSS operations.

International Regulations

5. As a result of WARC-ST, a new paragraph was added to Article 41 *Amateur Stations*, of the Radio Regulations of the International Telecommunication Union (ITU) (see 156A Spa2 § 6, and the Appendix to this Notice). This paragraph requires space stations in AMSS to be fitted with devices for controlling emissions in the event harmful interference is reported. Furthermore, it requires FCC to inform the International Frequency Registration Board (I.F.R.B.) of all space stations to be authorized in AMSS. Additional, Article 7 of the ITU provides that "space stations shall be fitted with devices to ensure immediate cessation of their radio emissions by telecommand, whenever such cessation is required under the provisions of these regulations" (see 470 Spa2 § 24).

6. Elsewhere in the Radio Regulations of the ITU, definitions of terms related to space station operations were added, as were the requirements for advance publication coordination and notification.

Experience in Licensing Space Stations

7. F.C.C. experience in licensing space stations has brought Commission attention to various problems encountered when attempting to operate a space station pursuant to rules enacted to regulate other types of amateur radio stations, via Part 97. These are:

(A) § 97.79 *Control operator requirements and § 97.88 Operation of a station by remote control.* These rules require a control operator to be at an authorized control point whenever the station is in operation. For low earth orbit satellites, the station is not in view of any telecommand station for extended periods. Therefore, no single control operator, or any reasonable number of control operators, could possibly be at all times at a control point(s), able to command the space station, as required by the general rules.

(B) § 97.84 *Station identification.* This rule requires every amateur radio to transmit its assigned call letters. None of the amateur satellites authorized by the F.C.C. have had this capability. Furthermore, based on the F.C.C.'s experience in this area, the nature of space operation would seem to make such a requirement meaningless.

To date, F.C.C. licensed amateur space stations have simply identified themselves with the letters "HI" in Morse Code telegraph. Except for the first few amateur satellites, even this identification probably, serves no useful purpose.

Another area of concern regarding station identification is telecommand operation. To maintain the integrity of the telecommand capability, knowledge of the location and identity of such stations must be limited to only those persons engaging in controlling the space station. Otherwise, information on controlling the space station could fall into the hands of persons who could use it to effect improper operation of the station, possibly resulting in interference to other services or damage to the station.

For this reason, telecommand stations are not required to identify with F.C.C. assigned call signs. Their transmissions are brief, (time required to transmit a call sign could exceed the time required to transmit a series of commands), and their transmissions are directed skyward making the causing of interference unlikely.

(C) § 97.85 *Repeater operation and § 97.128 Retransmitting radio signals.* The only amateur radio station permitted to automatically retransmit the radio signals of other amateur radio stations are stations in repeater operation or auxiliary operation. This capability is one of the principal

features of amateur satellites, so provision has to be made to permit it.

(D) § 97.91 *One-way communication.* This rule lists the types of one-way transmissions permitted in amateur radio which are not considered broadcasting (amateur radio stations may not broadcast). One-way space-to-earth telemetry transmissions from a space station, and one-way earth-to-space telecommand transmissions to a space station are not covered by this rule.

(E) § 97.117 *Codes and ciphers prohibited.* This rule prohibits the use of codes and ciphers in the Amateur radio service, where the intent is to obscure the meaning. Telemetry transmissions must use codes to transfer data, as do telecommand transmissions. While telemetry codes are only to facilitate communications, telecommand codes must also obscure the meaning of the message for the same reasons discussed under § 97.84 Station identification.

The Comments

8. Generally, very few comments expressed opposition to the establishment of an Amateur-Satellite Service. Only one comment expressed total opposition to the establishment of an Amateur-Satellite Service,¹ and, the rationale for this opposition was the following: "Whenever rules are issued governing a rapidly growing field, progress in that field inevitably slows or stops completely." Hence, according to the one negative comment any regulations for AMSS would hinder technological growth in this area. The Rules proposed herein are fundamentally the same set of rules AMSS has been operating under. We are proposing to move from a procedure based on a series of waivers, to one which is premised on rules developed via the rule making process.

9. One comment suggested that amateur communication achieved by reflection from the moon, should not be governed by the rules adopted for AMSS.² Such communication, it is claimed, does not represent a significant source of interference to other radio services, and is better regulated by the existing rules governing the Amateur Radio Service. Article 1 of the Radio Regulations of the ITU defines AMSS as "a radiocommunication service using space stations on earth satellites for the same purposes as those of the amateur service" (see, 84ATA, Spa2). This definition is used for the purpose of AMSS in the proposed rules. Therefore, communications conducted by passive reflection of signals off the moon would not constitute operation in AMSS.

The Proposal

10. The Commission proposes to add a new Subpart H, *Amateur-Satellite Service*, to Part 97 of the rules. The rules for the Amateur Radio Service would apply except in those instances specifically covered by the proposed Subpart. Generally, all amateur stations and amateur radio operators would be authorized to operate in the Amateur-Satellite Service to the extent of the privileges authorized by their amateur radio licenses, without any additional authorization by the Commission. Space operation would be limited to holders of the Amateur Extra Class operator license. Examination material related to the Amateur-Satellite Service is incorporated only in Examination Element 4(B), a requirement for the Amateur Extra Class license.

11. Any amateur radio station licensed by the Commission, having a control operator holding an operator license with the necessary frequency privileges, could be designated by the space station licensee to conduct telecommand operations. Certain privileges not afforded other amateur stations would be permitted authorized telecommand operations for the above-discussed reasons. Furthermore, the licensee of the space station could authorize amateur

radio stations in other countries to conduct telecommand operations, subject to the regulations of the licensing authority in the other country. In regard to space stations licensed by the Commission, however, there would have to exist the capability to effect an immediate, permanent cessation of emissions from the space stations via telecommanded operations conducted by one or more stations licensed by the Commission.

12. We are proposing to exempt both space stations and telecommand stations from the station identification requirement for the reasons given in paragraph 7, above. Article 19 § 2 of the Radio Regulations of the ITU provides:

"A station shall be identified by a call sign or other recognized means of identification. Such recognized means of identification may be one or more of the following necessary for complete identification: name of station, location of station, operating agency, official registration mark, flight identification number, selective call number or signal, selective call identification number or signal, characteristic signal, characteristic of emission or other clearly distinguishing features readily recognized internationally."

Instead of transmitting their call sign, information of the type specified by Article 19 § 2 would be filed with the F.C.C. by the station licensee.

13. In addition to Article 41 (see paragraph 5, above), Article 7 provides that "space stations shall be fitted with devices to ensure immediate cessation of their radio emissions by telecommand, whenever such cessation is required under the provisions of these Regulations" (see 470V Spa2, § 24). All of the frequency bands allocated to AMSS are shared with the Amateur radio service. Furthermore, AMSS frequency band 435-438 MHz is also shared with the Government radiolocation service. We are proposing to incorporate these requirements into the Rules.

14. Article 9A § 2 (see, 639AA, Spa2) of the Radio Regulations of the International Telecommunication Union (ITU) sets out the procedure for the Advance Publication of information on planned Satellite Systems. The procedure is the following:

"An administration (or one acting on behalf of a group of named administrations) which intends to establish a satellite system shall, prior to the co-ordination procedure in accordance with No. 639AJ where applicable, send to the International Frequency Registration Board not earlier than five years before the date of bringing into service each satellite network of the planned system, the information listed in Appendix 1B."

Article 9A, § 2, No. 639AJ provides the following:

"Before an administration notifies to the Board or brings into use any frequency assignment to a space station on a geostationary satellite or to an earth station that is to communicate with a space station on a geostationary satellite, it shall effect co-ordination of the assignment with any other administration whose assignment in the same band for a space station on a geostationary satellite or for an earth station that communicates with a space station on a geostationary satellite or for an earth station that communicates with a space station on a geostationary satellite is recorded in the Master Register, or has been co-ordinated or is being co-ordinated under the provisions of this paragraph. "For this purpose, the Administration requesting co-ordination shall send to any other such Administration the information listed in Appendix A."

We are proposing that informational filings be at: two years, and three months (the three months are to allow for processing); updates one year, and three months. Further, we anticipate the first filing period could be waived where justified. However, amateur satellites placed into orbit prior to receiving international sanction may be required to discontinue operation in favor of a prior request, or to avoid interference to other radio services.

¹ This comment was filed by Amateur radio operator Mark Zimmerman.

² This comment was filed by amateur radio operator K. D. Tentarelli.

15. We seek comment on the proposal and on the desirability of the information requirement, particularly in terms of clarity of the questions, instructions, and format. The information requirements included herein are subject of General Accounting Office clearance.

Comments Solicited

16. The specific amendments we are proposing are set forth in the Appendix. Authority for issuance of this Notice is contained in Sections 4(i) and 303(r) of the Communications Act of 1934, as amended 47 U.S.C. 154 (i) and 303(r). Pursuant to procedures set out in § 1.415 of the rules and regulations, 47 CFR 1.415, interested persons may file comments on or before February 5, 1980, and reply comments on or before March 6, 1980. All relevant and timely comments will be considered by the Commission before final action is taken in this proceeding. In reaching its decision, the Commission may take into consideration information and ideas not contained in the comments provided that such information or a writing indicating the nature and source of such information is placed in the public file, and provided that the fact of the Commission's reliance on such information is noted in the Report and Order.

17. In accordance with the provisions of § 1.419 of the rules and regulations, 47 CFR 1.419, formal participants shall file an original and 5 copies of their comments and other materials. Participants wishing each Commissioner to have a personal copy of their comments should file an original and 11 copies. Members of the general public who wish to express their interest by participating informally may do so by submitting one copy. All comments are given the same consideration, regardless of the number of copies submitted. All documents will be available for public inspection during regular business hours in the Commission's Public Reference Room at its headquarters in Washington, DC.

18. For further information concerning this rule making, contact Roy C. Howell, Rules Division, Private Radio Bureau, Federal Communications Commission, Washington, DC 20554, (202) 254-6884.

Federal Communications Commission.

William J. Tricarico,

Secretary.

Appendix

Part 97 of Chapter I of Title 47 of the Code of Federal Regulations is proposed to be amended as follows:

§ 97.3 [Amended]

1. In § 97.3, paragraphs (i) and (k) are deleted and designated (Reserved).

2. A new Subpart H is added, as follows:

Subpart H—Amateur-Satellite Service

General

- 97.401 Purpose.
- 97.403 Definitions.
- 97.405 Applicability of rules.
- 97.407 Eligibility for space operations.
- 97.409 Eligibility for earth operations.
- 97.411 Eligibility for telecommand operation.
- 97.413 Space operation requirements.

Technical Requirements

- 97.415 Frequencies available.

Special Provisions

- 97.417 Space operation.
- 97.419 Telemetry.
- 97.421 Telecommand operation.
- 97.423 International advance publication.
- 97.425 International coordination.
- 97.427 Notification required.

Authority: Secs. 4(i) and 303(r) of the Communications Act of 1934, as amended, 47 U.S.C. 154(i) and 303(r).

Subpart H—Amateur-Satellite Service

General

- § 97.401 Purposes.

The Amateur-satellite Service is a radio communication service using stations on earth satellites for the same purposes as those of the Amateur Radio Service.

§ 97.403 Definitions.

(a) *Space operation.* Space-to-earth amateur radio communication from a station which is beyond, is intended to go beyond, or has been beyond the major portion of the earth's atmosphere.

(b) *Earth operation.* Earth-to-space-to-earth amateur radio communication by means of radio signals automatically retransmitted by stations in space operation.

(c) *Telecommand operation.* Earth-to-space amateur radio communications to initiate, modify, or terminate functions of a station in space operation.

(d) *Telemetry.* Space-to-earth transmissions, by a station in space operation, of results of measurements made in the station, including those relating to the function of the station.

§ 97.405 Applicability of rules.

In all cases not specifically covered by the provisions of this Subpart, stations in space operation, telecommand operation, and earth operation, shall be governed by the provisions of the rules governing amateur radio stations and operators (Subpart A through E of this part).

§ 97.407 Eligibility for space operation.

Amateur radio stations licensed to Amateur Extra class operators are eligible for space operation.

§ 97.409 Eligibility for earth operation.

Any amateur radio station is eligible for earth operation, subject to the privileges of the operator's class of license.

§ 97.411 Eligibility for telecommand operation.

Any amateur radio station designated by the licensee of a station in space operation is eligible to conduct telecommand operation with that station in space operation.

§ 97.413 Space operation requirements.

An amateur radio station may be in space operation where:

(a) The station has not been ordered by the Commission to cease radio transmissions.

(b) The station is capable of effecting a cessation of radio transmissions by commands transmitted by station(s) in telecommand operation whenever such cessation is ordered by the Commission.

(c) There are in place, sufficient amateur radio stations licensed by the Commission capable of telecommand operation to effect cessation of space operation, whenever such is ordered by the Commission.

(d) The notifications required by § 97.423 (b) & (c) are on file with the Commission.

Technical Requirements

§ 97.415 Frequencies available.

The following frequency bands are available for space operation, earth operation, and telecommand operation.

Frequency Bands

- kHz*
- 7000-7100
- 14000-14250
- MHz*
- 21.00-21.45
- 28.00-29.70
- 144-146
- 435-438(1)
- GHz*
- 24-25.05

Stations operating in the Amateur-satellite Service shall not cause harmful interference to other stations between 435 and 438 MHz

Special Provisions

- § 97.417 Space operation.

(a) Stations in space operation are exempt from the station identification requirements of § 97.87 on each frequency band when in use.

(b) Stations in space operation may automatically retransmit the radio signals of other stations in earth operation, and space operation.

§ 97.419 Telemetry.

(a) Telemetry transmission by stations in space operation may consist of specially coded messages intended to facilitate communications.

(b) Telemetry transmissions by stations in space operation are permissible one-way communications.

§ 97.421 Telecommand operation.

(a) Stations in telecommand operation may transmit special codes intended to obscure the meaning of command messages to the station in space operation.

(b) Stations in telecommand operation are exempt from the station identification requirements of § 97.87.

§ 97.423 International advance publication.

All stations to operate on earth satellites or to communicate with stations on earth satellites are subject to the international advance publication procedure for the purpose of informing foreign administrations, in advance, of the intended operation. The proposed technical parameters of planned stations are to be published internationally (generally from 2 to 5 years prior to the commencement of space operations). The data required for this purpose are set forth in Appendix 1B of the international Radio Regulations.

§ 97.425 International coordination.

All stations proposed for earth and space operations and which utilize an earth satellite in a geostationary orbit are required to be prior coordinated with affected foreign administrations pursuant to the provisions of Article 9A of the international Radio Regulations. For this purpose, the Commission is obligated to collect and forward the data specified in Appendix 1A of the international Radio Regulations. No coordination is required for operations utilizing non-geostationary orbits.

§ 97.427 Notification required.

(a) The licensee of every station in space operation shall give written notifications to the Private Radio Bureau, Federal Communications Commission, Washington, D.C. 20554.

(b) Pre-space operation notification. (1) Three Notifications are required prior to initiating space operation. They are:

(i) *First Notification.* Required no less than twenty-seven months prior to initiating space operation.

(ii) *Second Notification.* Required no less than fifteen months prior to initiating space operation.

(iii) *Third Notification.* Required no less than three months prior to initiating space operation.

(2) The pre-space operation notification shall consist of:

(i) *Space operation date.* A statement of the expected date space operations will be initiated, and a prediction of the duration of the operation.

(ii) *Identity of satellite.* The name which the satellite will be known.

(iii) *Service area.* A description of the geographic area on the Earth's surface which is capable of being served by the station in space operation. Specify for both the transmitting and receiving antennas of this station.

(iv) *Orbital Parameters.* A description of the anticipated orbital parameters as follows:

Non-geostationary satellite

- (1) Angle of inclination
- (2) Period
- (3) Apogee (kilometers)

- (4) Perigee (kilometers)
- (5) Number of satellites having the same orbital characteristics

Geostationary satellites

- (1) Nominal geographical longitude
- (2) Longitudinal tolerance
- (3) Inclination tolerance
- (4) Geographical longitudes marking the extremities of the orbital arc over which the satellite is visible at a minimum angle of elevation of 10° at points within the associated service area.
- (5) Geographical longitudes marking the extremities of the orbital arc within which the satellite must be located to provide communications to the specified service area.
- (6) Reason when the orbital arc of (5) is less than that of (4)

(5) *Technical Parameters.* A description of the proposed technical parameters for the station in space operation and all other stations to engage in satellite communications; however, recognizing that a wide variety of amateur radio stations would be transmitting and receiving from a station on an earth satellite, only the parameters of a "typical" such station should be indicated. The description where possible, shall include the following:

- (1) Carrier frequency ¹
- (2) Necessary bandwidth ²
- (3) Class of emission ²
- (4) Total Peak Power ²
- (5) Maximum power density (watts/Hz)
- (6) Antenna radiation pattern ²
- (7) Antenna gain (main beam) ²
- (8) Antenna pointing accuracy (geostationary satellites only) ²
- (9) Receiving system noise temperature ⁴
- (10) Lowest equivalent satellite link noise temperature ⁵

(c) *In-space operation notification.* Notification is required after space operation has been initiated. The notification shall update the information contained in the pre-space operation notification. In-space operation notification is required no later than seven days following initiation of space operation.

(d) *Post-space operation notification.* Notification of termination of space operation is required no later than three months after termination is complete. If the termination is ordered by the Commission, notification is required no later than twenty-four hours after termination is complete.

* * * * *

3. In Appendix 2, the undesignated paragraph following the headnote is revised, and a new paragraph SEC. 6 is added as follows:

Appendix 2

Extracts From Radio Regulations Annexed to the International Telecommunications Convention (Geneva, 1959), as revised by the World Administrative Radio Conference for Space Telecommunications, Geneva, 1971.

Article 41—Amateur Stations

Sec. 6. Space stations in the Amateur-satellite Service operating in bands shared with other services shall be fitted with appropriate devices for controlling emissions in the event that harmful interference is reported in accordance with the procedure laid down in Article 15. Administrations authorizing such space stations shall inform the International Frequency Registration Board (I.F.R.B.) and shall ensure that sufficient earth command stations are established before launch to guarantee that any harmful interference that might be reported can be terminated by the authorizing Administration.

¹ Only the frequency range in which the carrier frequencies will be located need be submitted for international advance publication purposes if carrier frequencies have not been determined.

² Not required for international advance publication but should be included if this information is available.

³ These antenna characteristics shall be provided for both transmitting and receiving antennas.

⁴ For a station in space operations.

⁵ The noise temperature at the input of a typical amateur radio station receiver corresponding to the radio frequency noise power which produces the total observed noise at the output of the satellite link excluding noise from other non-associated radio systems.

6m Fun with the FT-625RD

— six is hot, so why not?

Glenn W. Malme W6OJF
9337 Gotham Street
Downey CA 90241

Probably 95% of the current ham population knows that six meters is one of their bands, and that's about all. Others have heard about TVI problems—and gave up before they started. Those days are now gone, for the most part.

After World War II, six meters became my first love. It all started when Pappy Dow, who ran a surplus store in Pasadena, sold a group of us the Collins MBF. The name Collins did the trick. All we had to do was move that ac/dc transceiver to the six-meter band. TV was just starting out here on the coast. W6XAO was the station call for Channel Two. To say that we had TVI prob-

lems was putting it mildly. I recall one neighbor walking around the block getting signatures on a petition to have me forced off the air.

About this time I met Faust Gonsett. Faust had introduced his world-famous two-meter Communicator. Why not one for six meters, I asked Faust? Sure enough, his little company in Burbank soon gave birth to the six-meter version.

Six meters was as hot as the proverbial two-dollar pistol. It was open worldwide every day and sometimes late into the night. I recall putting my six-meter Gonset (one T for the product, two Ts for Faust's name) in my 1953 Plymouth, connecting the antenna from the car's radio to the rig, calling CQ, and literally working the world. Each noon I had regular skeds on my way home for lunch with LU9MA in Argentina. He'd give me 40 over 9 reports for my little "4-Watts-out" Gonset while mobiling. The car antenna pulled out to 55 inches, which was just right for six. And, in just one

weekend in the early 1950s, I worked all 48 states. This was before Hawaii and Alaska joined the group.

So why am I telling you all this? Simply because it's about to happen again. Six meters is again coming into its own and along with 10 meters will be the hottest of the ham bands. I had been reading the propagation reports, and my blood pressure began to build up. Could it really be? I dusted off my Gonset Com 3, checked it over, fired up the old girl, and connected it to a makeshift CB ground plane which I had hurriedly chopped down for six meters. The old Gonset tuned up just fine. The output was about 4 Watts, and the swr was 1.5:1 after a bit of tinkering.

The band was dead, not a signal to be heard. So I did some more tinkering and then QRZed the band. Now I heard a carrier. To make my story short, it was a KH6.

He was as surprised as I was. "I think everyone just sits around and listens; no one ever calls CQ," he observed. He flipped his two-meter rig on one of the



The Yaesu FT-625RD.

island repeaters and rousted up two others who quickly fired up on six. When we were through, I tuned the band and found several sideband stations down around 50.1, but as the old Gonset is strictly AM, I couldn't do much.

So that started me looking about, and the end result is that I now have a new do-everything Yaesu all-mode FT-625RD transceiver on my operating desk. This beautiful little rig will do everything but make a cup of coffee. The FT-625RD covers 50-54 MHz in four one-MHz switch positions. Frequency readout is in red-colored LEDs. The rig offers a memory system which provides for storage and recall of any transmit, receive, or transceive frequency. A 600-cycle CW filter is available for CW operators.

Built into every FT-625RD is an rf speech pro-

cessor, a noise blanker which just can't be beat, VOX, semi-break-in CW with sidetone, and offset tuning (clarifier) for both receive and transceive frequencies. It has a novel automatic mike gain control (AMGC) which acts as a microphone squelch to minimize transmission of random noises in the operating room.

Hey, I forgot to tell you appliance operators that once you peak the receive signal on a multipurpose S-meter (one knob does it), you are all set to transmit—no tuning, dipping, and loading! And, there's a knob which varies the output anywhere from one to 25 Watts.

For FM enthusiasts, the FT-625RD includes a plus or minus 1-MHz repeater split plus an auxiliary split for use with a crystal. Tone burst and a discriminator center meter are included for maximum versatility.

For you guys who want to lift the hood and see what the motor looks like, you're in for a pleasant surprise. Completely solid state, all circuits are on plug-in computer-type circuit boards. Rear panel connections are for relay control, ALC input, PTT (for foot-switch control if you wish), CW jack, and connection for an external speaker if you so choose.

The front panel has every conceivable goody you can ask for. The mode switch provides LSB, USB, FM, AM, and CW. While the rig is vfo controlled, there is provision for 5 crystal positions and any split up to 4 MHz is possible with optional crystal.

And, like all Yaesu products, the transceiver will accommodate any 50-to-60-cycle line voltage, thanks to a tapped power transformer, from 100 volts to 234 volts. The FT-625RD transformer in the US

models is set for 117 V ac. And, if you want to run the rig mobile, a second power cord is provided for 12 V dc. It takes 700 milliamps on receive and 7 Amps on transmit. On AM, you'll get 8 Watts of rf output, and, as I said, up to a comfortable 25 Watts on other modes. All you need to get on the air is an antenna. All power cords, PTT mike, and built-in speaker are furnished.

I just signed with WB6WOX, WB6JBC, and WB6DLR, each of whom praised the transceiver's performance at the receive end. After we signed, I tried to call WB6DLR back, only to be told that he was on his way to "the local candy store"—no doubt to get his FT-625RD.

Six meters will be a new frontier for most of the hams today. So, why not join the gang and, as the band gets better each day, work the world? ■

ANTENNA SYSTEMS/TOWER HARDWARE

HY-GAIN ANTENNAS

TH5DX	New 5-Element Triband Beam	\$195
TH6DXX	6-Element Triband Beam	\$225
TH3MK3	3-Element Triband Beam	\$165
TH3JR	3-Element Triband Beam	\$119
TH2MK3	2-Element Triband Beam	\$109
HY-QUAD	2-Element Triband Quad	\$199
402BA	2-Element 40-mtr Beam	\$175
205BA	5-Element 20-mtr "Long John"	\$225
155BA	5-Element 15-mtr "Long John"	\$145
105BA	5-Element 10-mtr "Long John"	\$94
204BA	4-Element 20-mtr Beam	\$175
153BA	3-Element 15-mtr Beam	\$64
103BA	3-Element 10-mtr Beam	\$54
DB1015A	3-Element 10/15-mtr Beam	\$115
64B	4-Element 6-mtr Beam	\$42
66B	6-Element 6-mtr Beam	\$89
18HT	Hy-Tower 80-10 mtr. Vertical	\$249
18AVT/WR	80-10 mtr Trap Vertical	\$75
14AVQ/WB	40-10 mtr Trap Vertical	\$55
208	8-Element 2-mtr Beam	\$24
214	14-Element 2-mtr Beam	\$29
28DQ	80/40 mtr Trap Dipole	\$49
58DQ	80-10 mtr Trap Dipole	\$85
BN86	80-10 mtr KW Balun	\$14

KLM ANTENNAS

KT34A	4-El Tribander	\$299
KT34XA	New 6-El Tribander	\$449
160V	160-mtr Vertical	\$89
7.0-7.3-4A	4-El 40-mtr Beam	\$589
7.2-1	40-mtr Dipole	\$139
10-30-7A-LP	7-El 10-30 MHz Beam	\$599
13.9-14.4-6A	6-El 20-mtr Beam	\$629
21.0-21.5-6A	6-El 15-mtr Beam	\$379
28-30-6A	6-El 10-mtr Beam	\$199
50-52-11	11-El 6-mtr Beam	\$169
144-148-13LB	13-El 2-mtr Long Boomer	\$69
219-226-14	14-El 220 MHz Beam	\$49
432-16LB	16-El 432 MHz Beam	\$59
3-60-1:1	1:1 4-KW PEP Balun	\$24
3-60-4:1	4:1 4-KW PEP Balun	\$24

CUSHCRAFT ANTENNAS

ATB-34	4-Element Triband Beam	\$209
ATV-4	40-10 mtr Trap Vertical	\$78
ATV-5	80-10 mtr Trap Vertical	\$85
15-4CD	New 4-Element 15-mtr Beam	\$89
10-4CD	New 4-Element 10-mtr Beam	\$67
A50-5	5-Element 6-mtr Beam	\$55
A617B	New 6-Element 6-mtr Beam	\$149
ARX-2	2-mtr "Ringo Ranger"	\$30
A-3219	19-Element 2-mtr "Boomer"	\$66
A-214B	14-Element 2-mtr "Boomer"	\$53
A-214FB	14-Element 2-mtr FM "Boomer"	\$53
A-228FB	28-Element 2-mtr FM Power Pack	\$165
A-147-11	11-Element 2-mtr FM Beam	\$30
A-147-22	22-Element 2-mtr FM Power Pack	\$90
DX120	20-Element 2-mtr Colinear	\$45
ARX-450	450 MHz "Ringo Ranger"	\$30
A-144-10T	10-Element 2-mtr "Oscar" ant.	\$37
A-144-20T	20-Element 2-mtr "Oscar" ant.	\$53
A-432-20T	20-Element 432 MHz "Oscar" ant.	\$49
LAC-1	"Blitz-Bug" Male/Female	\$5
LAC-2	"Blitz Bug" Female/Female	\$5

ANTENNA ROTORS

Alliance HD-73	Rated for 10.7 sq. ft.	\$99
Alliance U-100	Ideal for Elevation Rotor	\$39
CDE CD-45	Rated for 9 sq. ft.	\$115
CDE HAMIV	Rated for 15 sq. ft.	\$149
CDE Tailtwister	Rated for 30 sq. ft.	\$209
8 Conductor Rotor Cable		\$15/ft.
Heavy Duty 8 Conductor Rotor Cable		\$36/ft.

For a quote on your antenna system needs, call today!

TEXAS TOWERS

✓ T77 1309 Summit Ave. Plano, Texas 75074
9 a.m. - 6 p.m. Mon-Fri, 9 a.m. - 1 p.m. Sat

TELEPHONE: (214) 423-2376

A Texas Communications Products Company (TEXCOM)

ROHN TOWERS

20G	\$29.50	25G	\$38.50	45G	\$67.50	55G	\$104.50
HDBX48	Free-standing 48-ft. tower (18 sq. ft) . . . \$305						
HBX56	Free-standing 56-ft. tower (10 sq. ft) . . . \$335						
FK2548	48-ft 25G Foldover tower . . . \$599						
FK2558	58-ft 25G Foldover tower . . . \$666						
FK2568	68-ft 25G Foldover tower . . . \$729						
FK4548	48-ft 45G Foldover tower . . . \$839						
FK4558	58-ft 45G Foldover tower . . . \$929						
FK4568	68-ft 45G Foldover tower . . . \$999						

(Freight paid on all foldover towers. Prices 10% higher west of Rocky Mountain states.)

GALVANIZED STEEL TOWER HARDWARE

3/16" EHS (3990 lb rating)	\$9.50/100 ft	\$90/1000 ft.
1/4" EHS (6000 lb rating)	\$12/100 ft	\$111/1000 ft.
5/32" - 7 x 7 Aircraft cable (2700lb)	\$8/100 ft	
3/16 CCM cable clamps (3/16" or 5/32" cable)	\$0.30	
1/4 CCM cable clamps (1/4" cable)	\$0.40	
1/4 TH Thimble (fits all sizes)	\$0.25	
3/8 EE (3/8" Eye and eye turnbuckle)	\$5.50	
3/8 EJ (3/8" Eye and jaw turnbuckle)	\$6.00	
1/2 EE (1/2" Eye and eye turnbuckle)	\$7.50	
1/2 EJ (1/2" Eye and jaw turnbuckle)	\$8.00	
3/16" Preformed guy deadend	\$1.45	
1/4" Preformed guy deadend	\$1.65	
6"-dia. 4-ft long earth screw anchor	\$10.50	
2"-dia 10-ft long heavy duty mast	\$35.00	
500D Guy insulator (5/32" or 3/16" cable)	\$0.85	
502 Guy insulator (1/4" cable)	\$1.80	

COAXIAL CABLE AND CONNECTORS

RG-213/U (Mil-spec RG-8/u)	\$29/ft
RG-8X new 1/4" diam. low loss foam	\$15/ft
1/2" 50-ohm Polyjacketed Hardline	\$65/ft
Male Hardline Connector (PL-259)	\$8.00
Female Hardline Connector (SO-239)	\$9.00
Male Hardline Connector (Type N)	\$10.00
Female Hardline Connector (Type N)	\$10.00

HY-GAIN TOWER MASTER AND TELE-TOWER CRANK-UPS

Direct factory shipment to save freight expenses. Call for our competitive quote on these towers. We can ship tower bases from stock to allow you to complete foundation work while tower is being prepared for shipment.

Albert and his Theories

— a layman's look at Einstein

"I do not know how I may appear to the world; but to myself I seem to have been only like a boy playing on the seashore, and diverting myself in now and then finding a smoother pebble or a prettier shell than ordinary, while the great ocean of truth lay all undiscovered before me."
—Isaac Newton

"In the light of knowledge attained, the happy achievement seems almost a matter of course, and any intelligent student can grasp it without too much trouble. But the years of anxious searching in the dark, with their intense longing, their alternations of confidence and exhaustion, and the final emergence into the light—only those who have themselves experienced it can understand that."—Albert Einstein

You might as well discard the belief that relativity theory is too complex for mortal man or woman to comprehend, be-

cause you will have a good understanding of its physical and philosophical implications in a few more pages—perhaps in spite of yourself. You may then join in some speculations about those matters which lie beyond the theory, areas about which little is known for sure. If you are clever enough, you may someday make a fundamental contribution to that frontier of knowledge, as Einstein did in his own time. He, after all, was mortal, rumors to the contrary notwithstanding.

Some History

Someone once defined science as not so much knowing, but knowing that we know, in the sense of testing each theory exhaustively and inventing hypotheses to tear down existing beliefs. It is hoped that, by straining ideas this way, only those unshakable ones will survive and win general acceptance. It doesn't always work that way. Sometimes the the-

ories include hidden assumptions that are themselves not subjected to test, assumptions so intrinsic in our thinking that we don't realize that they can be questioned.

While all his friends were out getting the plague, Isaac Newton was hiding in his mother's house in Woolsthorpe, England. He had some prisms to play with, among other things. He was very clever, and experimented at length with the prisms, until he was sure that the prevailing theories of light were wrong. He had few hidden assumptions, which was very helpful. The young are like that.

It was then thought that colors appeared from prisms because thin glass passed only red, and hence through the colors to the thickest part of the prism, passing violet. Newton disproved this in a simple way: He divided a beam of sunlight into its component colors with one prism, and then placed a second

prism in the colors which resulted. He saw that there were no further changes in the colors, which would have been required by the prevailing theory. He foolishly printed this proof, which, among other things, made all the existing physicists look silly for having swallowed the old belief without test. One of them, Robert Hooke, literally argued with him until he (Hooke) was dead. The old are like that.

The important thing to come out of Newton's work with light, however, was the idea that it consisted of waves, not particles. (It may turn out that neither is true, but that's another story.) This had important consequences, for a particle can just fly along, but a wave must have a medium through which it passes. When you watch spreading ripples on a pool of water, you aren't watching a physical thing, after all—you are watching energy transfer itself through the water accord-

ing to some rules having to do with, for example, the water's density and the gravitational force acting on the water. The water must be there for the ripples, and air is needed for sound waves, and so forth.

As a result of Newton's finding, therefore, it was seen that some kind of medium must permeate all of space, to carry the waves of starlight to us. It was named ether, and within a short time everybody called it The Ether (doubtless, named by the same guy who called fluxions "The Calculus"), as if it was a sure thing and nobody would call it wrong. Lots of experiments seemed to confirm its existence, and after a while people got tired of talking about it. It became a hidden assumption. So everybody was happy and went home. Very human. Don't forget: Scientists are human.

But a man named Maxwell rocked the boat in the late 1800s. He didn't mean to: In fact, his theories about electromagnetism included the ether assumption. He just thought it would be fascinating to measure the Earth's speed through the ether. He saw that this could be done by measuring the speed of light in different directions, for, by so doing, one could find the direction and speed through the ether.

An American, Albert Michelson, saw a way for this to be done with sufficient sensitivity to detect the motion, using two beams of light, one moving out and back in the presumed direction of travel, one moving perpendicular to this direction. These two beams could be combined after their trips, and compared. By measuring the two beams, it was possible to get around the problem of actually measuring the speed of light directly; one

measures instead the difference in travel time for the beams, using, in other words, one beam to test the other.

This can be done in the following way: If one drops two stones in a pond, the waves will meet in the center and create an interesting pattern of bumps, elongated areas, and quiet areas. The quiet areas are those places where the two waves oppose exactly, peak to trough. This is called interference, and it works for all waves.

When two light waves (of a single color) are made to meet in this way, the areas of opposition are dark. This results in a pattern of light and dark bars, each dark bar indicating an interval of distance nearly as small as that of light waves themselves. This makes the method very sensitive, sensitive enough to measure the difference between the two beams in their journeys.

The difference Michelson intended to measure was to be the result of the different travel time taken by a beam of light moving along the direction of travel versus one moving across the path. (See Fig. 1.) At first glance, it would seem that a beam moving out and back would be slowed down on the outward trip, then speeded up equally as it came back, pushed forward by the ether. But it turns out that the outward trip takes longer, because it is slower, and this results in a measurable difference when compared with the crosswise beam. If such a difference existed, this device would detect it. Michelson intended to rotate the entire apparatus, so that the out-and-back and the crosswise beams would trade places, and look at the interference pattern to see if it changed appearance.

Poor Mr. Michelson! He was so upset. No matter how he turned his apparatus, there was no change in the appearance of the light and dark bars. As if there were no ether! But, of course, there had to be.

He repeated his experiment with better equipment, in collaboration with Edward Morley. (Scientists always gang up when they get nervous; very human.) This was a beautiful piece of equipment, a huge slab of marble (to minimize the effect of vibration on the interference pattern), floating in a pool of mercury (to facilitate turning). All this served to reinforce the original conclusion: no difference.

Michelson considered the experiment a failure, but some saw the other, more frightening possibility, that of no ether. Immediately, however, it was decided to try to save the ether (a term actually used at this time) by developing an explanation for Michelson's null result. Perhaps the ether is dragged along by the Earth, like a sheath, so that experiments con-

ducted at the surface would not reveal the motion? Experiments ruled this out. Maybe the Earth doesn't move? Such was the state of panic.

George FitzGerald proposed a really strange explanation: Everything gets shorter in its direction of travel through the ether, using the following formula: $L' = L\sqrt{1 - (V^2/C^2)}$, where C is the velocity of light, V is the speed of travel in compatible units, L is the original length (at rest) and L' is the length that comes about by moving at velocity V . This would explain the null result of Michelson's experiment: Everything gets a little shorter, just compensating for the expected difference in travel time of the light beam!

Hendrik Lorentz later expanded on this idea (thus perhaps saving FitzGerald from the nuthouse), including an even stranger correction for a problem he foresaw: No test at that time could distinguish between the forward-moving travel-time problem, and the smaller crosswise problem, which also would

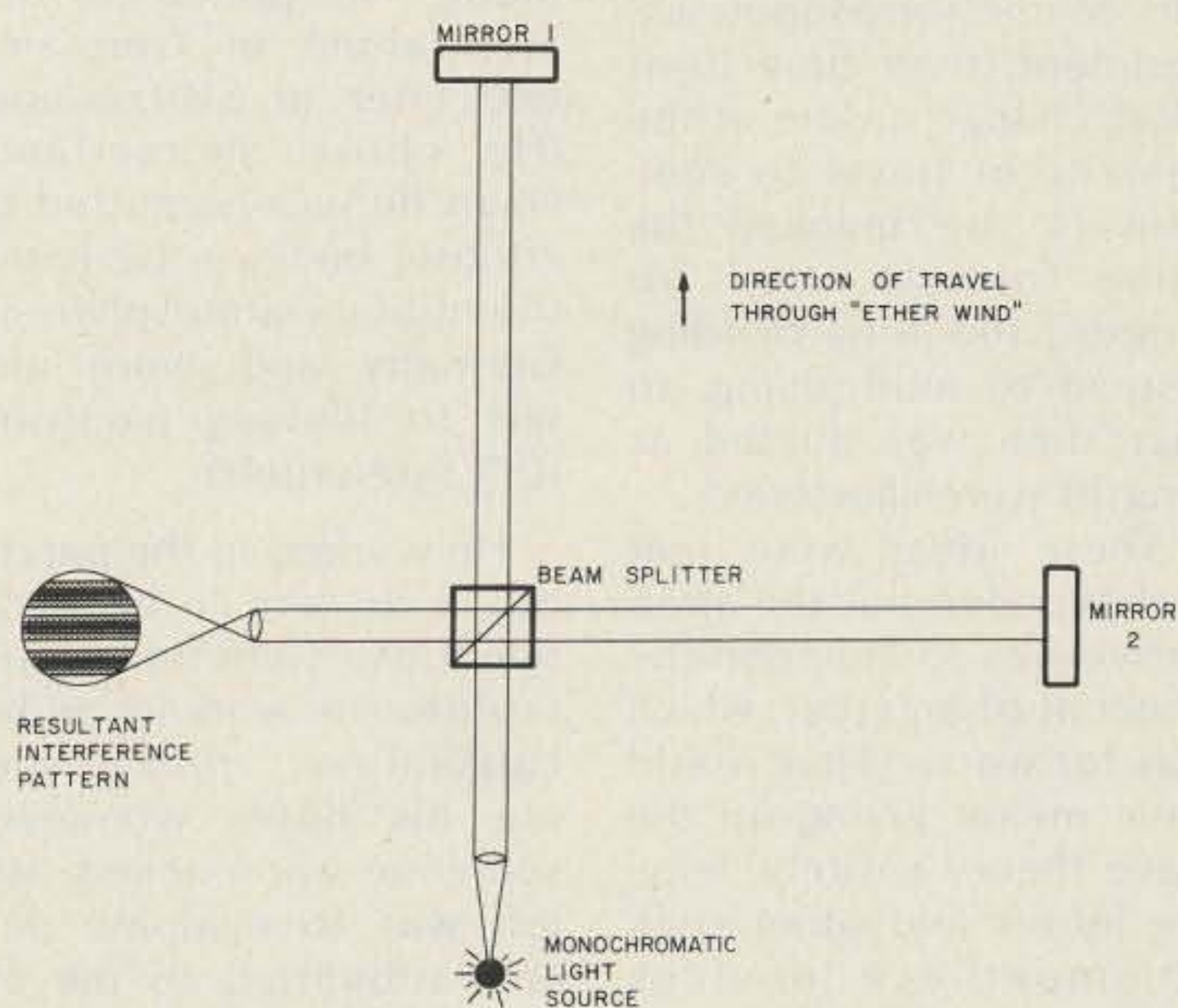

Fig. 1. The Michelson-Morley Interferometer. The travel time for forward case (mirror 1): $t' = t/[1 - (V/C)^2]$; for perpendicular case (mirror 2): $t' = t\sqrt{1/[1 - (V/C)^2]}$, where t = travel time "at rest," t' = travel time when apparatus is at velocity V through "ether wind," and C = speed of light in compatible units.

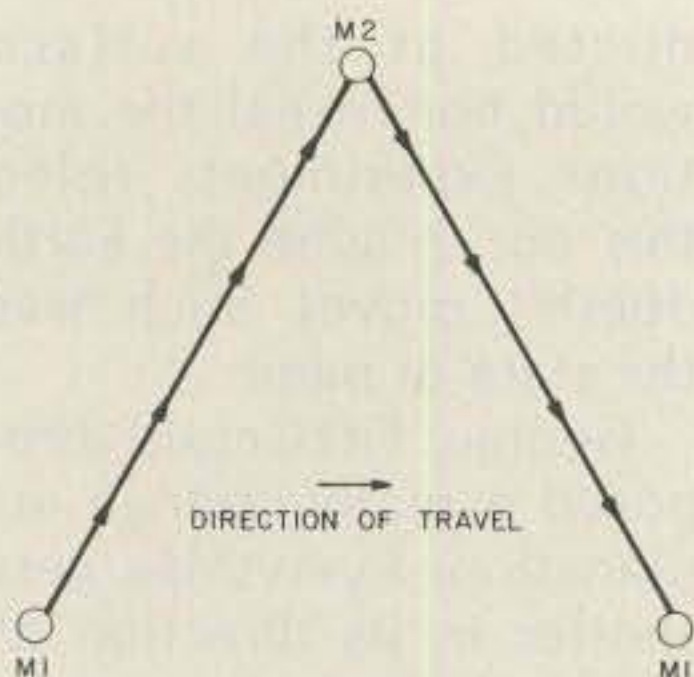

Fig. 2.

have to be explained eventually. The crosswise problem is illustrated in Fig. 2.

A beam leaves mirror 1, and travels to mirror 2, then back again. An observer who is "not moving" relative to the experiment sees it as drawn. Instead of the distance being straight between the two mirrors, the beam must move at an angle, and, more importantly, move over a greater distance, than if the system were "at rest." For some involved reasons, the shrinkage used in the forward direction cannot be invoked here. So what's left? What else can we bend, in order to save the ether? Time, said Lorentz; time is all we have left. If the beam moves over a greater distance, and takes no longer, which was shown in the Michelson-Morley experiment, then time itself must change nature at the velocity of travel to compensate. He invoked the same formula used for lengths, this time dividing instead of multiplying, so that time was dilated as lengths were shortened.

These ideas were met with wonder, but the alternative was to abandon the concept of an ether, which was far worse. That would have meant giving up the wave theory entirely, leaving lenses and other such commonplace devices without an explanation. Light, after all, had been shown to faithfully propagate at a specific and constant velocity. Particles move at all kinds of speeds, depending on their

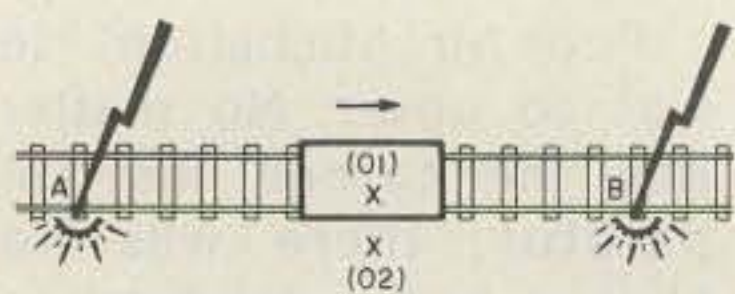

Fig. 3.

nature and energy, but light was constant.

Nobody wanted to give up the ether—the world would have become a scary place. So they listened nervously as Lorentz explained about the effect of traveling at the speed of light. Lengths in the direction of motion would shrink to zero, he said, and time would stand still. Lorentz was a physicist, remember, not a diplomat.

The Special Theory of Relativity

When Albert Einstein was 16, he asked himself the question, what would the world look like if I were traveling on a beam of light? No one could have helped him at that time, there being a great fuss about the threatened "loss" of the ether, and a lot of new theories were trying to rescue it, some simple, some complex, none subject to experiment. He pondered this idea alone in Germany, and later in Switzerland. (He chose Switzerland, when he was permitted to choose, because he hated the military atmosphere in Germany, and swore himself to lifelong pacifism; isn't fate cruel?)

He worked in the patent office in Bern in his early twenties, sometimes surreptitiously working on his calculations, quickly hiding his notes whenever someone approached. His job was to evaluate patents submitted to the office for worth. I have a copy of one before me now that he may have had occasion to see. It is an improved popgun. Isn't that great? "Hey, Sam, Al Einstein over at the patent of-

fice likes your popgun!"

The job at the patent office followed a so-so academic career; his salary was augmented by tutoring positions, in which he taught mathematics and physics to private individuals for small fees. His attempts to enter the universities as a teacher, hoping eventually to become a professor, were not successful. The pile of notes in his desk grew more voluminous as time passed.

In 1905 Einstein submitted a paper to a famous German journal of experimental physics, *Annalen Der Physik*. The title of the paper was "On the Electrodynamics of Moving Bodies." The contents of this paper were later to become known as the theory of special relativity. Special relativity deals with the theory that uniform (non-accelerated) motion cannot be detected in the sense of being compared with some universal frame of reference, such as an ether. In this theory, Einstein explains the apparent failure of the Michelson-Morley experiment (without referring to it specifically) and gives the Lorentz contraction theory a new interpretation. Essentially, he kept all of Lorentz's formulas, but explained them differently.

In his theory, it is postulated that there is no experiment which can be conducted inside a closed, uniformly moving vessel to detect motion. Newton's theory stated that no mechanical experiment would reveal any motion which might exist; Einstein's theory extended this to include optical or other experiments.

Think about this for a minute. If no optical experiment can reveal the speed of travel (inside the closed frame of reference), then Michelson's ether either doesn't exist, or is of

no use in establishing speed. This means that every experiment ever conducted that gave a speed for light referred that speed to something other than the ether, or the background stars, or the sun's environment. What, then?

It was Einstein's genius that revealed to him the hidden assumption of those before him: that the speed of light existed apart from the truly basic things that make up the universe of the senses, space in three dimensions, and time. He explained that the speed of light is as basic to the structure of space as up, down, or sideways. And, in some cases, if it came to a necessary change in one of these, the speed of light would bend the others to fit its own constant velocity. It was shown to be as fundamental in the structure of space as any of these, to be, in essence, a yardstick of time, although that specific description was to come later.

Besides expanding on Newton's mechanical relativity, therefore, Einstein included the requirement that the speed of light be constant, regardless of the motion of its source. A spacecraft traveling at half the speed of light, sending a beam of light out in the direction of travel, would be seen by another spacecraft (which was at rest, relative to the first) to be sending a beam of light at the normal velocity. But measurements onboard the first would reveal that the beam is traveling at the usual velocity of light, which, in the world before Einstein, would have meant a speed 1½ times that of light!

One may ask, which is the true speed? Which spacecraft is "right"? In the world of Einstein, there are no longer absolute answers

1-800-228-4097

CALL TOLL FREE

Hy-Gain 3806 2-Meter Hand-Held Amateur Transceiver



SPECIAL PRICE
\$109.95

- Low cost, 5-channel hand-held provides superb voice transmission over short to medium distances
- Sharply tuned on-frequency selectivity in the RF amplifier stages plus FET's in the 1st and 2nd mixers for virtual immunity to out-of-band signals intermodulation distortion and cross-modulation
- Separate microphone and speaker elements for enhanced audio
- Internally adjustable mic preamp—a Hy-Gain exclusive
- Specially gasketed case seals out water, dirt and corrosive salt air
- Watertight, high-impact ABS plastic case—ribbed for non-slip grip
- Top-mounted controls for instant access

Accessories:

Model No.	Description	Price
3807	Nicad Battery Pack	\$31.95
1104	Touch Tone Pad	\$44.95
1106	AC Battery Charger	\$ 9.95
1107	Cigarette Lighter Adaptor Cord	\$ 9.95
1108	Antenna Adaptor Cord	\$ 9.95
1110	Carrying Case (Leather)	\$17.85
1111	Carrying Case (Vinyl)	\$ 9.95
269	Rubber Duck Antenna	\$ 5.95
	Crystal Certificates	\$ 3.95

PLEASE ENCLOSE \$2.50 FOR SHIPPING AND HANDLING PER UNIT

CALL TOLL FREE

1-800-228-4097

for Quality Ham Radio Products at Discount Prices

- | | | | |
|-----------|-----------|---------|-----------------|
| KENWOOD | DENTRON | MIRAGE | E.T.O. ALPHA |
| YAESU | HY-GAIN | SWAN | VHF ENGINEERING |
| DRAKE | MOSLEY | TEMPO | BERK-TEK CABLE |
| ICOM | CUSHCRAFT | TEN-TEC | ROBOT-SSTV |
| AEA | WILSON | MIDLAND | SAY |
| PANASONIC | HUSTLER | CDE | SHURE |
| BENCHER | LARSEN | AUTEK | TELEX |

Our Mail Order Hours (CST)

M-F 8 am to 10 pm
Saturday 8 am to 5 pm
Sunday Noon to 8 pm

Call and Talk to

Don	WBØYEZ		
Denny	WØQR	Blaine	WBØQLH
Bill	WBØYHJ	Bob	WBØRQZ
Joe	WAØWRI	Jim	KAØCRK



Communications Center

443 N. 48th, Lincoln, Nebraska 68504

In Nebraska Call (402)466-8402



CALL TOLL FREE

1-800-228-4097

Communications Center
443 N 48th Street
Lincoln, Nebraska 68504
In Nebraska Call (402)466-8402

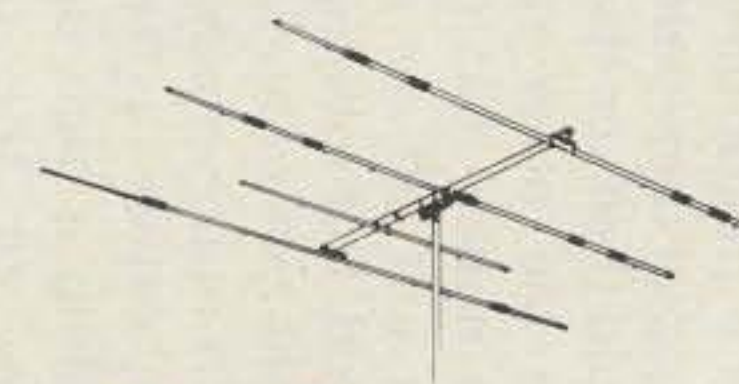

Antenna Sale!

HY-GAIN

	Regular	Special		Regular	Special		
TH6DXX	Super Thunderbird	\$329.95	\$259.95	18HT	Hy-Tower 80-10M vertical	\$359.95	\$289.95
TH3MK3	3 el. 10-15-20M beam	222.95	179.95	18AVT/WB	80-10M Trap vertical	105.95	84.95
TH3JR	3 el. 10-15-20M beam	169.95	139.95	14AVQ/WB	40-10M Trap vertical	69.95	57.00
Hy-Quad	2 el. 10-15-20M Quad	274.95	219.95	12AVQ	20-10M Trap Vertical	42.95	34.95
205BA	5 el. "Long John" 20M beam	329.95	259.95	14RMQ	Roof Mounting kit (verticals)	33.95	29.95
155BA	5 el. "Long John" 15M beam	199.95	159.95	5BDQ	80-10M Trap doublet	109.95	89.95
105BA	5 el. "Long John" 10M beam	129.95	109.95	2BDQ	80-40M Trap doublet	59.95	49.95
204BA	4 el. 20M beam	249.95	199.95	66B	6 el. 6M beam	119.95	99.95
204MK5	5 el. conversion kit	99.95	79.95	203	3 el. 2M beam	15.95	14.95
153BA	3 el. 15M beam	89.95	79.95	205	5 el. 2M beam	21.95	19.95
103BA	3 el. 10M beam	74.95	59.95	208	8 el. 2M beam	29.95	26.95
402BA	2 el. 40M beam	239.95	189.95	214	14 el. 2M beam	34.95	29.95
BN-86	Balun for beam antennas	15.95	15.95	LA-1	Deluxe lightning arrestor	59.95	49.95
TH2MK3	2 el. 10-15-20M beam	149.95	119.95	TH5DX	5 el. 10-15-20M beam	269.95	209.95

MOSLEY

	Regular	Special	
Classic 33	3 el. 10, 15, 20 Mtr. beam	304.75	209.95
Classic 36	6 el. 10, 15, 20 Mtr. beam	392.75	249.95
TA-33	3 el. 10, 15, 20 Mtr. beam	264.00	189.95
TA-36	6 el. 10, 15, 20 Mtr. beam	392.75	249.95
TA-33 Jr.	3 el. 10, 15, 20 Mtr. beam	197.00	149.95
TA-40KR	40 Mtr. Add On	119.95	89.95

CUSHCRAFT

ATB-34	4 ele. 10, 15, 20 Mtr. beam	289.95	229.95	A147-11	11 ele. 146-148 Mhz. beam	39.95	32.95
ATV-4	10, 15, 20, 40 Mtr. Vertical	99.95	84.95	A147-22	22 ele. Power Pack	119.95	95.95
ATV-5	10, 15, 20, 40, 80 Mtr. Vertical	109.95	89.95	A144-10T	2 Mtr. "Twist" 10 ele.	49.95	39.95
ARX-2	2 Mtr. Ringo Ranger	39.95	32.95	A144-20T	2 Mtr. "Twist" 20 ele.	69.95	56.95
AR-6	6 Mtr. Ringo	39.95	32.95	A147-20T	2 Mtr. beam	67.95	54.95
ARX-220	220 Mhz. Ringo Ranger	39.95	32.95	A430-11	432 Mhz. 11 ele. beam	37.95	31.95
ARX-450	435 Mhz. Ringo Ranger	39.95	32.95	A432-20T	430-436 Mhz. Beam	59.95	49.95
A144-11	11 ele. 144-146 Mhz. beam	39.95	32.95				

HUSTLER

3-TBA	3 ele; 10, 15, 20 Mtr. beam	259.95	189.95
4-BTV	10-40 Mtr. Vertical	109.95	79.95
5-BTV	10-80 Mtr. Vertical	139.95	99.95
RM-75	75 Meter Resonator	18.95	15.95
RM-75S	75 Meter Super Resonator	38.95	29.95
G6-144B	2 Mtr. Base Colinear	89.95	69.95
G7-144	2 Mtr. Base Colinear	139.95	99.95
G7-220	220 MHz Base Colinear	129.95	89.95

ROTORS

HAM 4 \$159.95 T2X Tailtwister \$219.95 Alliance HD 73 \$109.95
Call for prices on rotor cable, Coax, Towers, and Accessories. All prices do not include shipping.

We carry all major brands of ham radios AT DISCOUNT PRICES



Kenwood — Yaesu — Drake — ICOM — DENTRON —
Ten-Tec — Swan — Tempo — Midland — E.T.O. — Wilson



to such questions, because time and space are themselves no longer absolute.

The best example of this uncertainty is a thought experiment used by Einstein himself. Consider the following and see Fig. 3: Two observers (O1 and O2 in the illustration) are passing one another. One is standing on the embankment of a railroad track, the other is riding in the train. At the instant that the two observers are across from one another, two lightning bolts strike equidistant points along the railroad track, one in front of, one behind the train. The observer on the embankment sees the two flashes as simultaneous. The moving observer, since he is moving towards one flash and away from the other, sees the forward flash first. The observer on the embankment concludes that since he was stationary and saw the two equidistant flashes simultaneously, they really were simultaneous. The observer on the train, aware of his motion, calculates the difference between the arrival times of the flashes and he, too, concludes that they were simultaneous.

This all precedes Einstein, of course. In Einstein's relative view of these events, the observer on the embankment has just as much right to assume that he is the one in motion, he and the rest of the world, backwards in relation to the train, and that the observer on the train is stationary. Now the embankment observer concludes that since he is actually moving backwards toward the flash behind the train and he saw them simultaneously, the forward flash happened first and caught up. The train observer, using the same logic, agrees, since he is now "at rest" and saw the forward flash first.

So we can no longer say with absolute certainty whether two such events are simultaneous, or have any other order, and this uncertainty increases as the distances between events increases. Absolute determinism of the old kind remains only for events which have no spatial separation. Two colliding ice skaters still *really* collide simultaneously.

In some cases, it can be said that event B *followed* event A, such as a case where a radio signal (which travels at the speed of light) arrives, delivering a message to turn off the bath before it overflows. This case meets the requirement that the space-distance, measured as an ordinary distance, is less than the time-distance, measured with the new yardstick of the speed of light. This has important consequences other than baths, for, if the space-distance is greater than the time-distance, event B cannot have been caused by event A (the sending of the signal), because no signal or material particle can move with a velocity greater than that of light. Imagine a sphere of causality, spreading out through space at the speed of light, within which volume events *may* be caused by the original signal, but outside which, events *cannot*.

The interesting effects predicted by Lorentz now are part of the geometry of Einstein's universe, but for quite different reasons than originally formulated. In Lorentz's view, the shrinkage in the direction of travel was a change in an object's true dimensions, due to the pressure of the ether wind. In Einstein's view, whatever dimension is taken is the true dimension, because an object's reality is defined as much by velocity as by space coordinates and

sizes. The time dilation described by Lorentz to save the ether is used in the same proportion to describe a geometric change in space-time, in which time and space are on an equal footing, and in accord with the requirement that the speed of light be the same for all observers in all states of motion.

Consider Fig. 4. Here, a rowboat moves across a river, seen (A) from the frame of reference of the riverbank, and (B) from the frame of reference of the flowing water. Clearly, an observer on the bank sees a larger distance traveled than the observer on the boat itself. If the boat were a beam of light, and its transit time were clocked both by a waterborne and beached observer, there would be two different velocities recorded for light, because velocity is distance per unit of time. To complicate matters unnecessarily, let us say that there is a helicopter flying overhead at three times the stream flow rate. This observer would see the boat moving backwards at twice the rate seen by the bank observer!

One might generalize and say that there are an infinite number of frames of reference, each giving a different value for the speed of light.

In the case of light beams, however, there is no "water" and no preferred frame of reference. A nosy spacecraft occupant, peeking into the window of another which is moving at a different rate of speed,

—might watch a test of the speed of light,

—might see just such an elongated light path brought about by the difference in the speeds of the two craft,

—might see the other's clock timing the transit of the beam,

—and might smugly note that, as far as *he* is concerned, the beam moved over a greater distance than the other crew perceives. He would then see the clock inside the other spacecraft, and notice that it is slow. Not just off, as in maladjusted, but running at a different rate entirely.

To make matters worse, the other astronaut is holding a sign up to him now, in the porthole through which he watched the experiment. It reads: "*Your Clock Is Slow.*"

A final, and important effect of the special theory is the one having to do with mass. Let us say that one wants to measure the mass of a cannonball inside one of our disagreeing spacecraft. On Earth, one may simply weigh it, but in space we must employ a more roundabout method: We measure its inertia, its resistance to change. After all, Newton and Galileo showed that inertia is proportional to mass. So we push against the cannonball with a measured force, and see how much time it takes for the ball to get moving at a specified rate.

From the standpoint of our own clock, the mass is the same as on Earth. But our friends are waving another sign from the other ship: "*Your Clock Is Slow And That Cannonball Is Heavier Than You Think.*" That other crew, who used their own clock to judge the mass of the ball, found it to be heavier since it took more time, as they perceived it, to get it rolling.

This is the real limitation to an approach to the speed of light: The mass of the craft would approach infinity, requiring infinite energy to make the final push to the speed at which photons move. And they seem so ordinary!

This mass increase rounds out the effects of

AZDEN ★ NEW! ★ AZDEN ★ NEW! ★ AZDEN ★ NEW! ★ AZDEN

AZDEN®

REVOLUTIONIZES THE STATE OF THE ART AWE AND AZDEN. INTRODUCE THE BRILLIANT NEW PCS-2000 MICROCOMPUTER CONTROLLED

NEW!



2 METER FM TRANSCEIVER

NOT \$550.00
WINTER
SPECIAL

\$339⁰⁰

NOW AVAILABLE!!

PCS-2800 10-meter FM transceiver 28-30 MHz with all features of PCS 2000. 10 watts output, selectable simplex or + 100 KHz offset.

Introductory Price \$299⁰⁰



COMPARE THESE FEATURES
WITH ANY UNIT AT ANY PRICE

- **FREQUENCY RANGE:** Receive and transmit: 144.00 to 147.995 MHz, 5Khz steps + MARS-CAP* and MULTIPLE OFFSET BUILT IN.
- **ALL SOLID STATE-CMOS PL DIGITAL SYNTHESIZED.**
- **SIZE:** UNBELIEVABLE! ONLY 6¼" x 2¾" x 9¾". COMPARE!
- **MICROCOMPUTER CONTROLLED:** All scanning and frequency-control functions are performed by microcomputer.
- **DETACHABLE HEAD:** The control head may be separated from the radio for use in limited spaces and for security purposes.
- **SIX-CHANNEL MEMORY:** Each memory is re-programmable. Memory is retained even when the unit is turned off.
- **MEMORY SCAN:** The six channels may be scanned in either the "busy" or "vacant" modes for quick, easy location of an occupied or unoccupied frequency.
- **FULL-BAND SCAN:** All channels may be scanned in either "busy" or "vacant" mode. This is especially useful for locating repeater frequencies in an unfamiliar area.
- **INSTANT MEMORY-1 RECALL:** By pressing a button on the microphone or front panel, memory channel 1 may be recalled for immediate use.
- **MIC-CONTROLLED VOLUME AND SQUELCH:** Volume and squelch can be adjusted from the microphone for convenience in mobile operation.

- **ACCESSORY OFFSET:** Provides three additional offset values: +0.4 MHz, +1 MHz and +1.6 MHz. Other offsets may also be obtained.
- **25 WATTS OUTPUT:** Also 5 watts low power for short-distance communication.
- **DIGITAL S/R F METER:** LEDS indicate signal strength and power output. No more mechanical meter movements to fall apart!
- **LARGE ½-INCH LED DISPLAY:** Easy-to-read frequency display minimizes "eyes-off-the-road" time.
- **PUSHBUTTON FREQUENCY CONTROL FROM MIC OR FRONT PANEL:** Any frequency may be selected by pressing a microphone or front-panel switch.
- **SUPERIOR RECEIVER SENSITIVITY:** 0.28 uV for 20-dB quieting. The squelch sensitivity is superb, requiring less than 0.1 uV to open. The receiver audio circuits are designed and built to exacting specifications, resulting in unsurpassed received-signal intelligibility.
- **TRUE FM, NOT PHASE MODULATION:** Transmitted audio quality is optimized by the same high standard of design and construction as is found in the receiver. The microphone amplifier and compression circuits offer intelligibility second to none.
- **OTHER FEATURES:** Dynamic Microphone, built in speaker, mobile mounting bracket, external remote speaker jack (head and radio) and much, much more. All cords, plugs, fuses, microphone hanger, etc. included. Weight-6 lbs.
- **ACCESSORIES:** 15' REMOTE CABLE... \$29.95. *MARS-CAP KIT... TBA. PCS-6R A/C POWER SUPPLY... \$49.95. TOUCHTONE MIC. KIT... \$39.95.



AMATEUR-WHOLESALE ELECTRONICS

8817 S.W. 129th Terrace, Miami, Florida 33176

Telephone (305) 233-3631 • Telex: 80-3356

U.S. DISTRIBUTOR DEALER INQUIRIES INVITED

ORDER NOW TOLL-FREE

Credit card holders may use

our toll-free ordering number

Ask for operator 701

(800) 824-7888

In California (800) 852-7777

Alaska and Hawaii (800) 824-7919

✓ A21



the special theory: Time dilates, length in the direction of travel shortens, mass increases; all as seen by a relatively stationary observer, and all in accord with the quantity: $\sqrt{1-(V^2/C^2)}$.

It is important to understand that everything, not just clocks, slows down on the moving frame. After all, the reason clocks slow down is because the paths by which atoms communicate with one another (at the speed of light) are lengthened by the above formula, and all the messages about mechanical state or energy level therefore take longer to deliver. In a balance-wheel clock, for example, the pressure of the spring can be transmitted to the wheel at no greater than the speed of light, and the path of travel is now longer. The present state of inertia of the wheel itself is transmitted back at the same speed, also over a greater distance. It doesn't require magic, it just required an Einstein to think of it in the first place!

If you happen to have a fantastic sense of rhythm, you still won't notice the change in the clock's ticking, because your body will slow down by the same amount. You will age less quickly than those at rest. Of course, if you look out a porthole, you will see everything happening at a faster pace than usual, and all inside the craft will seem completely normal.

Einstein kept on thinking, after the publication of the special theory. Three months later, he published another paper in which he showed that if a body gives off energy, it loses mass by the relation: $M' = E/C^2$, in which M' is the "lost" mass. During the next two years he realized that the reverse must also hold: that all mass has energy, and, finally, that they are equivalent. He expressed

their equivalence this way: $E = mc^2$.

A proof of this equality was, at the time, difficult. Later on, it became easier.

Learning to resist the temptation to re-prove Einstein's mass-energy equivalence theory involving large groups of civilians has become the most important task facing us.

The General Theory

The special theory won Einstein wide recognition, although some physicists refused to accept the ideas—which is as it should be. Many changes came about for him as a result, but he was busy with a new problem. You will remember that the special theory dealt with the equivalence of uniformly moving bodies, those that are not being accelerated. Einstein wanted to prove that these, too, were equivalent, and that no test could distinguish between them, using the same rules as in the case of uniform motion.

This was going to be tough. After all, if a rocket's motors are pushing the rocket forward, it is very likely that the occupants will be pushed into their seats as a result of the inertia of their bodies, and they will realize, in the absence of any other clues, that they are being accelerated.

True, said Einstein, but can they distinguish between, say, a 32-foot-per-second acceleration in a spacecraft, and just sitting on the ground? He began to think about the similarity of gravitational and inertial effects.

Galileo had shown that the force of inertia is proportional to the force of gravity—that is, for a given mass, the force of gravity drawing it to the ground is in proportion to the inertial force resisting the move-

ment. Thus, objects of greatly differing masses, ignoring air resistance, fall at the same rate. Isn't it strange, thought Einstein, that these forces are exactly proportional?

In 1916, after 11 years of study, he published the general theory of relativity, so named because all forms of motion, not just uniform, are shown to be equivalent as far as any test or special effects are concerned.

To accomplish this, it was necessary to deal with some very difficult questions. For example: In an accelerating spacecraft, an astronaut is being pushed into his seat by inertia. If we now take the spacecraft as the frame of reference, and assume the universe to be moving backward all around it, how does the inertial force arise then?

Einstein explained it this way: Inertial forces arise equally between any two material bodies which are accelerated relative to one another. Once the two bodies are in uniform motion, or at rest, the force disappears. Try to change the state of motion between them, and the force appears resisting the acceleration. Therefore, he said, inertia comes about as an interaction between the spaceship and all the rest of the matter in the universe, and one might as well think the universe is in motion, as the spacecraft—the force would be the same.

As for the relationship between inertia and gravity, Einstein had something wonderful to say about it, which will take a little telling.

In Fig. 5, a light beam is shown passing from one side of the spacecraft to the other, while the craft is being accelerated. This makes the beam, as seen from the spacecraft, take the path shown.

Does this remind you of something? The astronauts, measuring the time the beam takes, will find a different result than those not accelerating, and this would violate the constancy of the speed of light. But, as in the special theory, because of the curved path, the clocks used to measure the time are slowed down. (The formulas are more involved because the path is curved, but time-dilation is the result in either case.)

Now take the case of a laboratory on Earth, being accelerated by gravity at 32 feet per second. According to the general theory, there is nothing special about the frame of reference of the lab that can distinguish it from a spacecraft being accelerated by the same amount. Doesn't that mean the clocks will be slowed down in the lab on Earth, just as in the spacecraft? Yes, says Einstein. Time passes more slowly in a gravitational field than out in space.

And it happens in much the same way as in the special theory: by bending space itself, and time, so that the constancy of the speed of light is maintained.

Having said all that, we now come to the crowning achievement of the general theory: Gravity and inertia are the same thing. They're the same force! Because of the change of geometry of space near large masses like the Earth, objects move towards it, "thinking" themselves to be in uniform motion. This is important: The moon, traveling in its orbit, "thinks" that it is moving in a straight line, and no acceleration is required to make it move in a circle, or ellipse. How can this be?

Try this thought experiment. Two observers are on the moon, one on the far side, one on the

near side. They are required to operate little rocket motors so that both sides of the moon move forward at the same speed, so that it moves in a straight line. (They obviously were hired by Newton.) Every second, each pulses his rocket by a measured amount. This would seem to move the moon off and away in a straight line (in the absence of gravity, which we haven't yet invoked).

But the observer on the near side is nearer to the Earth than the other, and, as was shown above, his clock therefore is giving fewer ticks. His rocket motor is, therefore, operated less frequently, and the moon moves around and around the Earth, and the observers are mystified. (The actual geometry is more complicated than this, involving space as well as time changes.)

Another important effect of this equivalence between gravity and inertia is that a gravitational field will bend light waves! Look again at the diagram of the accelerated craft and the curved beam of light. It was shown that the same effect can be observed on Earth, therefore a beam of light that passed near the surface would also be curved, and take off in a new direction. This idea was tested in a very dramatic way in 1919 by the English astronomer, Eddington. It was realized that starlight would be deflected a measurable amount when it passed close to the sun. This effect might be perceptible during an eclipse of the sun, after which comparisons might be made of the stars' positions without the effect of the sun.

Eddington made an expedition to Brazil to photograph the stars' positions during an eclipse. Einstein had predicted a deflection

of 1.7 seconds of arc. Newtonian physics also predicted a deflection, but one about half as large as that suggested by Einstein. No test of this kind had ever been conducted, and there were at least three possible outcomes: Einstein's value would be seen, Newton's would win out, or there would be no deflection of the starlight. According to a story of the time, two astronomers are discussing these possibilities. "What if there turns out to be a deflection twice as large as Einstein predicts?" "That's simple," says the other. "Eddington will go mad."

Despite some bad weather, some photographs were taken and compared with standard observatory pictures of that part of the sky, and the results agreed with Einstein.

It was chiefly because of the result of this experiment that the public became aware of the theory, and Einstein became famous. He later said about it, "Fate has punished my hatred for authority by making me an authority."

Some Consequences and Speculations

We have seen that inertia and gravity result from the interaction of matter, and are not independent of it. It therefore is possible that the force of inertia might be related to the total amount of mass in the universe and its distribution through space. An Austrian physicist, Ernst Mach, suggested that in an empty universe there would be no inertial forces. One could shine a flashlight out the back of the Queen Mary and it would get moving in a hurry! The only moderating influence in this case would be the negligible mass of the ship itself. In practice, investigators have used this concept (called Mach's

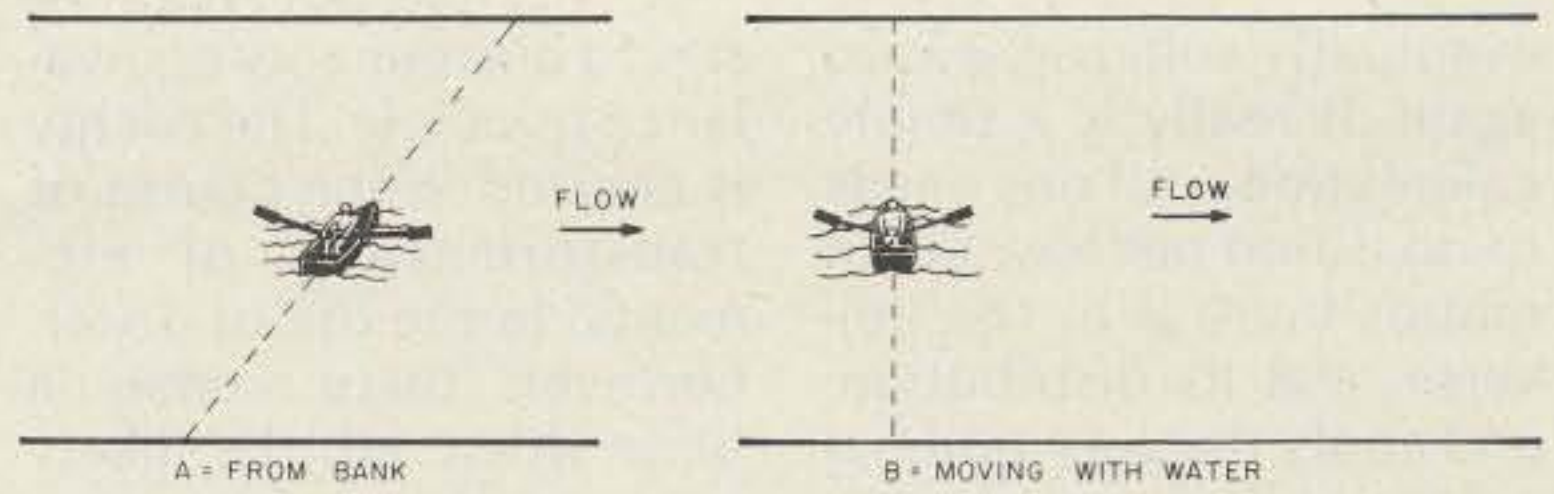

Fig. 4.

Principle) to estimate the total mass of the universe, assuming that local forces are the result of this interaction.

Einstein was aware of this possibility, and saw that his universe would tend to spread outward or fall inward rather than stay put, because any tendency to fall inward, for example, would increase the inertial, and therefore the gravitational, forces between the galaxies, thus increasing the speed of collapse. His universe was like a coin balanced on edge. He introduced a cosmological constant, therefore, the effect of which was to hold widely separated masses apart, thus balancing the forces.

In the 1920s, Edwin Hubble discovered that the universe is expanding, and the need for a cosmological constant went away. If the universe is expanding, it no longer must maintain any balance. (Einstein hadn't liked the cosmological constant, anyway; it was inelegant.)

Now, if the universe is expanding, which seems likely, it must have been all together at once sometime in the past, and started moving apart. George Gamow, a Russian-born physicist, proposed what is now known as the big bang theory, in which the present state of the universe was initiated by a tremendous explosion, throwing energy and matter all over. Wow, said just about everybody. And various experimental evidence has supported the theory. Distant galaxies are receding

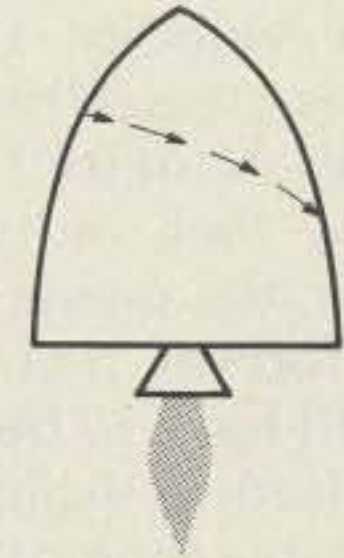

Fig. 5.

from us in proportion to their distance, the farthest ones moving the fastest. Gamow predicted that there would be a small thermal residue of the original big bang, sort of a cloud of thermal energy all over the universe. He guessed that it would be at about 5 degrees Kelvin, and recent tests using airborne microwave detectors are in good agreement with this prediction: about 2.7 degrees Kelvin.

One of the possible consequences of this expansion is that inertia, and therefore gravity, gets slowly weaker, because the density of matter is declining. This might explain planetary cracking and fissuring as forces other than gravitation begin to get the upper hand. This idea is being subjected to experimental test in devices made to measure the force of gravity with great precision. Some theories have gravity and inertia changing in different proportions, so that orbits would slowly move outward and take longer. A study of the moon is presently underway to try to detect this effect.

Other studies are underway to try to decide whether the universe will continue to expand, or

eventually collapse inward again. It really is a simple calculation—all one needs to do is find out how much matter there is in the universe, and its distribution, and apply the gravitational rules including Mach's Principle (if it turns out to be so) to the results. If the average velocity of the masses is greater than the "escape velocity" mandated by their mutual attractions, the universe will expand forever. If not, then there will have to be a theory devised to explain the collapse (big thump?). Finding and tallying all the matter that exists is another problem. Some galaxies may be receding from us so fast that we can no longer see their light. Some may be hidden behind dust clouds.

We now know (or assert, arrogantly) that stars emit energy by way of nuclear processes according to Ein-

stein's mass-energy equivalence principle. The energy is emitted in the course of transformations of elements. In the life of a star, however, there comes a time when all the likely candidates for transformation are used up and truly basic matter remains which won't give up any more energy. When this happens, the star begins to collapse to a smaller, denser configuration. This comes about because the energy emission, which used to maintain the size of the star through thermal turbulence and sheer pressure, has greatly decreased.

If a star is somewhere between three and ten times the size of our sun, it can collapse into such a small, dense configuration that the escape velocity required is greater than the speed of light. This means that no light can escape it, nor any other kind of sig-

nal. And if a stray bit of light or matter should come by, it will be sucked up and never heard from again. The star itself and all that is captured by it are literally crushed into nothingness.

These things, called "black holes," are thought to exist; in fact, there are some candidates in the night sky, but they do present a paradox: Matter and energy can be changed only in form. It isn't permitted to take it away entirely! Some people claim that the stolen mass-energy must pop up somewhere else, say, out of a "white hole" in another universe. In which case there might be white holes in this one from black holes in that one; all we need to do is figure out which of our new, fascinating observations is actually a white hole.

People who have to believe in relativity (there are always some of those, for any theory) are made nervous by the idea of antimatter. There are lots of versions of the theory in which antimatter is at least possible, and the existence of certain antiparticles is taken for granted in the high-energy physics labs, where electrons and positrons (the antimatter equivalent of an electron) are made to collide in huge storage rings. But if a ball of regular antimatter were proven to exist (or coexist, to be more specific), then relativity would be in a big jam.

Consider the following two cases: In one, the ball of antimatter is floating inside a craft, and the craft's motor is started. The floor starts to rise toward the ball. Of course, the ball stays in place until the floor hits it since it has no forces acting on it until then. In the other case, the craft is assumed to be sitting on Earth instead of fir-

ing its rocket. Antimatter is repelled by ordinary matter, so the ball takes off toward the ceiling. These two frames of reference are therefore no longer equivalent, as required by the theory. A space crew could keep a little bit of antimatter around on their journeys, and use it to find out things not permitted by Einstein!

A group of theorists once came up with a mathematical treatment of the universe in which matter is no more than a local space-time irregularity, instead of creating such irregularities, as presented here. After all, it's the chicken-and-egg problem: Did the matter or the local distortions in space-time appear first? And what does "first" really mean, in the world of Einstein? These guys were sure that they had lost their collective minds, and were all set to commit themselves. Moral: Understanding relativity too well is almost as bad as not understanding it at all. ■

Bibliography

- Albert Einstein, Creator and Rebel*, Hoffman-Dukas, New American Library, 1973.
One Two Three . . . Infinity, George Gamow, Bantam, 1972.
The Relativity Explosion, Gardner, Vintage, 1976.
Relativity, the Special and General Theory, Einstein, Tr. Lawson, Crown, 1961.
An Introduction to the Special Theory of Relativity, Katz, Van Nostrand, 1964.
The Ascent of Man, Bronowski, Little, Brown, 1973.
"The Search for Black Holes," Thorne, *Scientific American*, December 1974.
"The Quantum Mechanics of Black Holes," Hawking, *Scientific American*, January, 1977.
"Is Gravity Getting Weaker?", Van Flandern, *Scientific American*, February, 1976.
"Will the Universe Expand Forever?", Gott, Gunn, Schramm, Tinsley, *Scientific American*, March, 1976.
"Positrons as a Probe of the Solid State," Brandt, *Scientific American*, July, 1975.

FAST SCAN ATV

WHY GET ON FAST SCAN ATV?

- You can send broadcast quality video of home movies, video tapes, computer games, etc, at a cost that is less than sloscan.
- Really improves public service communications for parades, RACES, CAP searches, weather watch, etc.
- DX is about the same as 2 meter simplex — 15 to 100 miles.



ALL IN ONE BOX

TC-1 Transmitter/Conv
 Plug in camera, ant, mic and you are on the air \$399 ppd



HITACHI HV-62 TV CAMERA
 High performance closed circuit camera just right for atv. with lens \$239 ppd

PUT YOUR OWN SYSTEM TOGETHER



TVC-1B CONVERTER tunes 420 mhz down to ch 2 or 3 . . \$49.50 ppd
 TXA5 EXCITER \$69 ppd
 PA5 10 WATT LINEAR . . \$79 ppd
 FMA5 Audio Subcarrier . \$24.50 ppd

SEND FOR OUR CATALOG, WE HAVE IT ALL

Modules for the builder, complete units for the operator antennas, color cameras, repeaters, preamps, linears, video ider and clock, and more. 19 years in ATV.

Call 213-447-4565 5-6 pm

✓ P41



P.C. ELECTRONICS

Maryann
 WB6YSS

2522 PAXSON
 ARCADIA, CA 91006

Tom
 W6ORG



TET[®]

ANTENNA SYSTEMS 1-800-654-3231

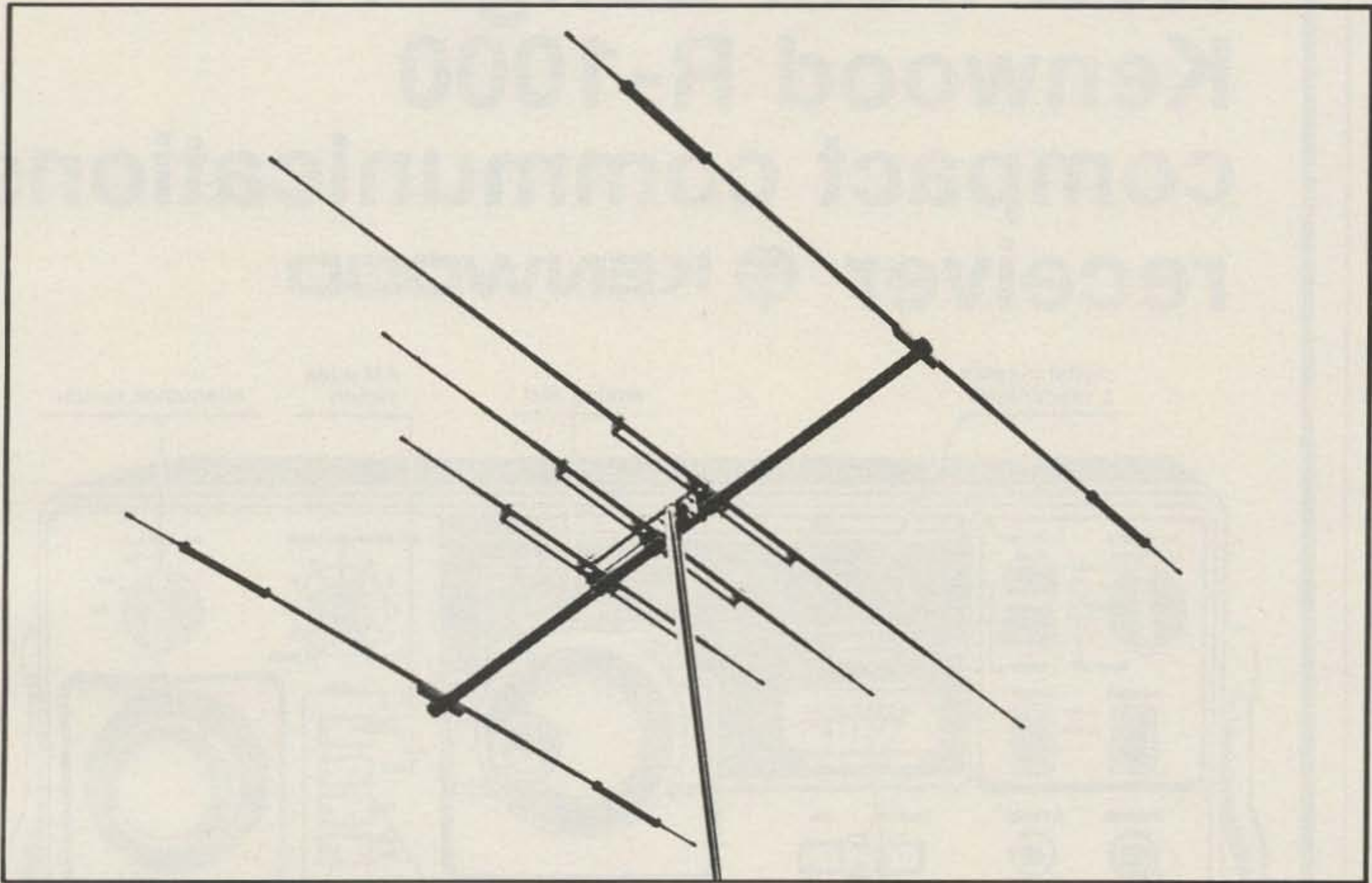

The Super DX Series Triband beams employ a hybrid system combining separate full size driven elements and Hi-Q parasitic trap elements. These features allow for high radiation efficiency with excellent VSWR over the entire length of each band.

FACTORY DIRECT

182.95

3F35DX

3F35DX	Super DX Series 10/15/20M Yagi	182.95
3F37DX	Super DX Series 10/15/20M Yagi	234.95
SQ-22	Swiss Quad 2M	45.95
TE35A	Roof Mounted Tower 11.6'	135.95
TE55B	Roof Mounted Tower 18.0'	199.95
TE75C	Roof Mounted Tower 25.0'	253.95
KR-400	Rotator	84.95
KR-600	Rotator	139.95
KR2000	Rotator	289.95
KR500	Elevation Rotator	149.95
KS065	Thrust Bearing	20.95
KS050	Thrust Bearing	14.95

ORDER DIRECT

CALL TOLL FREE

1-800-654-3231



✓T55

TET U.S.A., INC.



425 HIGHLAND PARKWAY, NORMAN, OKLAHOMA 73069 TEL: 405-360-6410

New from Longs . . .

Kenwood R-1000

compact communications receiver

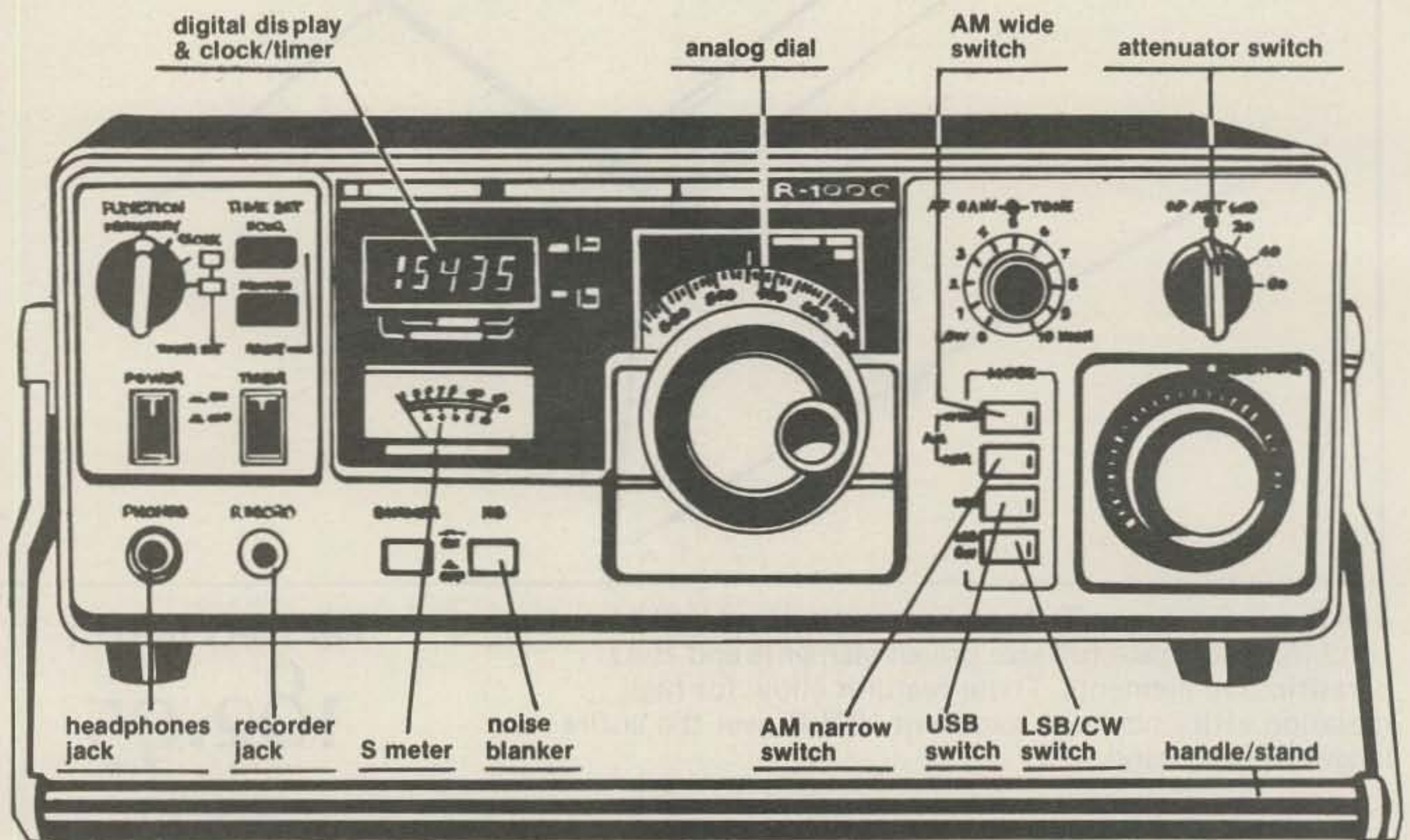
KENWOOD

The new, compact (12 $\frac{3}{4}$ "W x 4 $\frac{1}{2}$ "H x 8-9/16"D) R-1000 is a high class general coverage receiver covering 30 bands from 200 KHz to 30 MHz. It features: PLL synthesizer, digital display readout (1 KHz step) and analog dial calibrated at 10 KHz intervals from 0 to 1,000 KHz. The 12 hr. quartz digital clock with timer can be set to go on or off at any time. A stepped RF attenuator provides 20, 40, and 60 dB attenuation to protect the unit from damage by high input power signals. Also features: 3 stage IF filter, tone control, built-in noise blanker, dimmer switch, recording terminal, selectable AC power voltage (100, 120, 220 or 240 VAC), wire antenna terminals and UHF connector (SO-239 for coax cable), large 10 cm built-in speaker, external speaker jack, 2 position antenna selector switch, accessory terminals for timer and muting circuit. Has calibrated S meter, AF gain control, 4 mode switches. Selects LSB/CW, USB, narrow AM or wide AM.

Sensitivity (S + N/N 10 dB or more): SSB 200 KHz - 2 MHz: 5 micro V, AM 50 micro V. SSB 2 MHz - 30 MHz 0.5 micro V, AM 5 micro V. Frequency stability: ± 2 KHz Max. from 1-60 min. after power on, + 300 Hz max. in every subsequent 30 min. Selectivity: AM (wide) 12 KHz at -6dB, 25 KHz at -50dB. AM (narrow) 6 KHz at -6dB, 18 KHz at -50dB. SSB/CW 2.7 KHz at -6dB, 5 KHz at -60dB.

499.00

List Price. Call for quote.

L9
Long's



Use your Master Charge or BankAmericard/VISA when you order.

Ham Radio Department Store

MAIL ORDERS: P.O. BOX 11347 BIRMINGHAM, AL 35202 • STREET ADDRESS: 2808 7TH AVENUE SOUTH BIRMINGHAM, ALABAMA 35233

UNDER \$100.00!

HY-GAIN 3806 2-meter handheld transceiver

\$89.95

SAVE \$100!

~~List 189.00~~

While supply lasts.

Add 2.50 shipping & handling.
Item No. 8386.

- Buy a new, lowcost 6 channel handheld which provides superb voice transmissions.
- Sharply tuned on-frequency selectivity in the RF amplifier stages plus FET's in the 1st and 2nd mixers for virtual immunity to out-of-band signals, inter-modulation distortion and cross modulation.
- Separate microphone and speaker elements for enhanced audio.
- Internally adjustable mic preamp—a Hy-Gain exclusive.
- Specially gasketed case seals out water, dirt and corrosive salt air.
- Watertight, high-impact ABS plastic case-ribbed for non-slip grip.
- Top mounted controls for instant access.
- Comes complete with 146.52 crystals only.
- 1 watt output (12 VDC input)
- Operates on 8 "AA" batteries or optional NiCad battery pack.

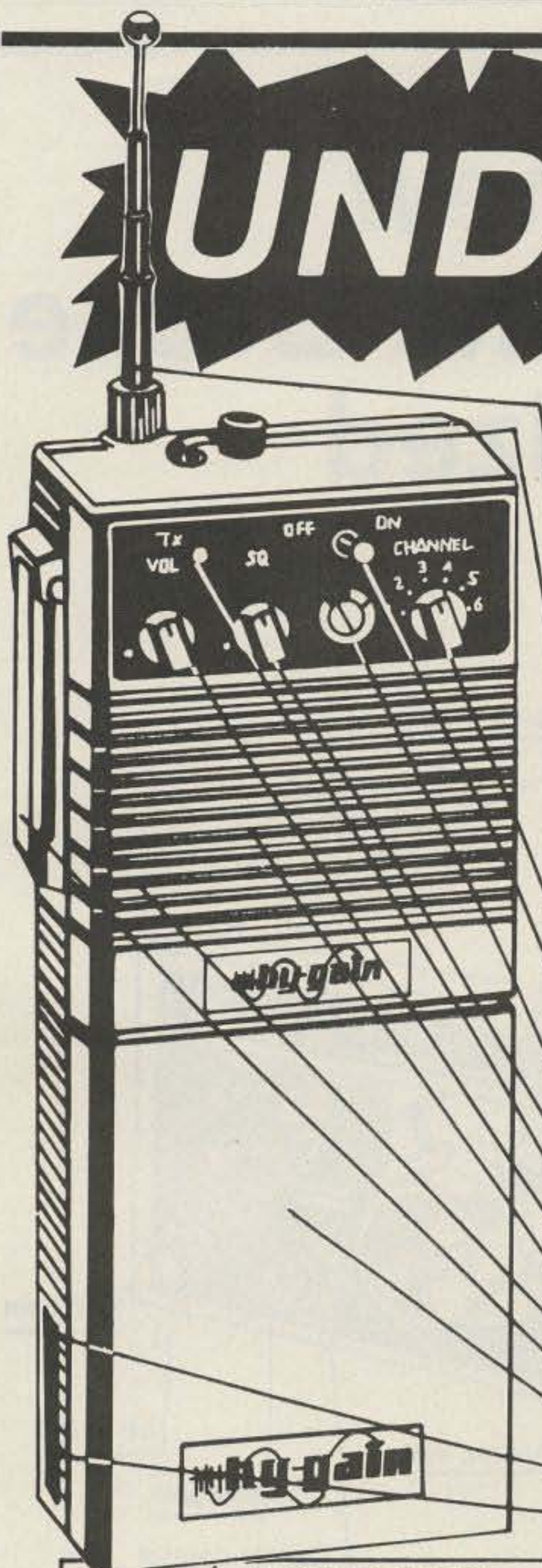

- Interior antenna
- Exterior antenna
- Channel selector
- DC power ON/OFF switch
- Transmitting voltage and receive signal strength indicator
- Squelch volume
- Transmit indicator
- Audio volume
- Internal speaker
- Microphone
- Transmit/receive switch
- Battery case
- Earphone jack
- External DC 12V jack

Item Number	ACCESSORIES Description	Price
A8302	NiCad battery pack	24.95
A8327	Touch tone pad	29.95
A8304	AC battery charger	4.95
A8309	Cigarette lighter adapter cord	4.95
A8305	Carrying case	14.95
A8328	34/94 crystals	7.95 a pair
A8329	16/76 crystals	7.95 a pair

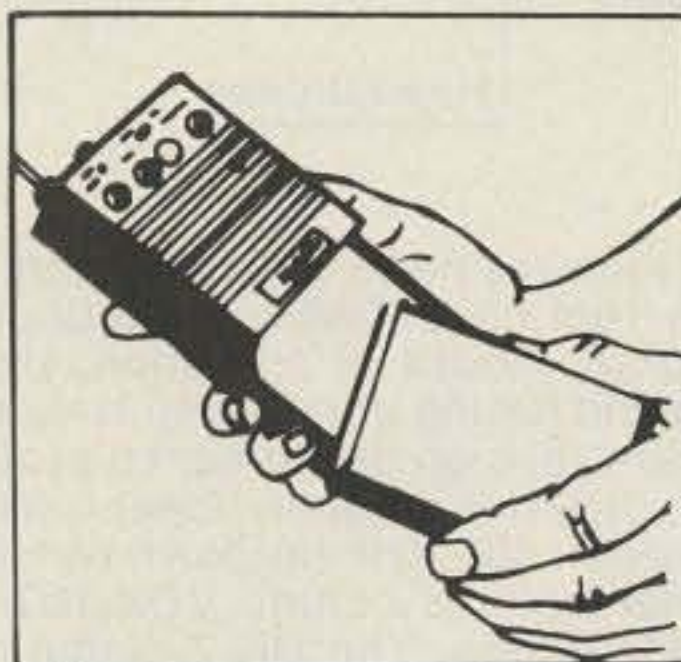

Optional NiCad battery pack **\$24.95**



Optional touchtone pad (not installed) **\$29.95**

Call Toll Free **1-800-633-3410**

IN ALABAMA CALL 1-800-292-8668 9 AM TIL 5:30 PM CST, MONDAY THRU FRIDAY

Be ready for the new ham bands with the Drake TR/DR7 synthesized HF transceiver!

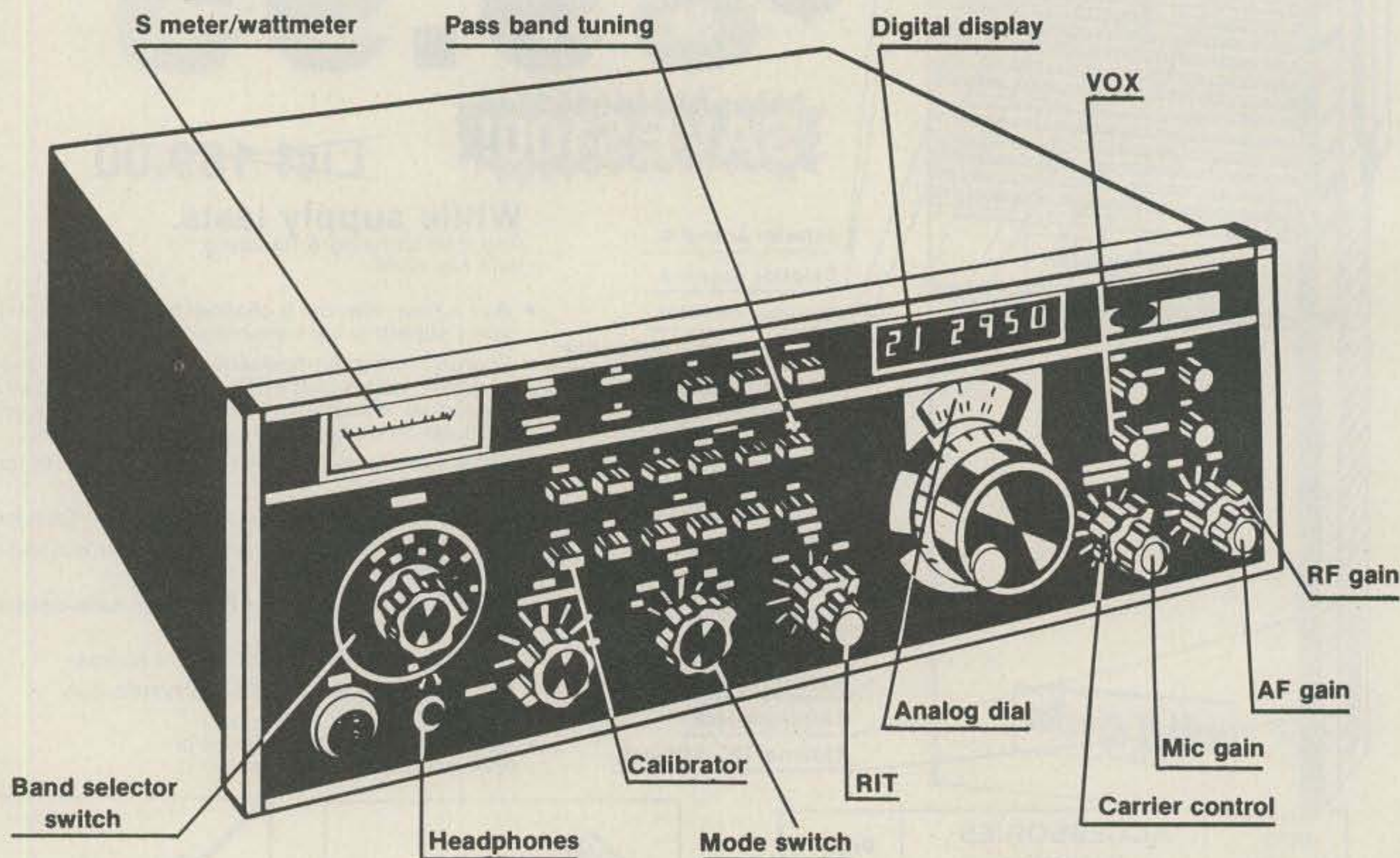

The all solid state TR/DR7 requires no tune up. It covers all bands 160 thru 10 meters and receives from 1.5 to 30 MHz continuous and 0 thru 30 MHz with the optional Aux-7. Modes of operation: USB, LSB, CW, RTTY, and AM. True passband tuning greatly improves receiving performance in heavy QRM. Special high performance synthesizer, combined with the Drake PTO, provides smooth, linear tuning with 1 KHz dial and 100 Hz digital readout. 500 KHz up/down range switching is pushbutton controlled. Other features include: VOX, RIT, S-meter, and built-in RF wattmeter/VSWR bridge. The DR-7 digital counter reads frequencies to 150 MHz for test purposes. Wattmeter accuracy $\pm 5\%$ at 100 watts (50 ohm load). Power input: SSB 250 watts PEP, CW 250 watts, AM 80 watts (carrier), plus upper sideband. Power supply required for AC operation. PS-7 120/240 V power supply available. **249.00** list price.

Frequency stability: less than 100 Hz after warmup. Sensitivity: SSB, CW less than 0.5 micro V for 10 dB S/N, AM less than 2.0 micro V for 10dB S/N. Selectivity: 2.3 KHz at -6dB and 4.1 KHz at -60dB (1.8:1 shape factor).

1395.00

List Price. Call for quote.

Long's



Use your Master Charge or BankAmericard/VISA when you order.

Ham Radio Department Store

MAIL ORDERS: P.O. BOX 11347 BIRMINGHAM, AL 35202 • STREET ADDRESS: 2808 7TH AVENUE SOUTH BIRMINGHAM, ALABAMA 35233

A full 2KW PEP amplifier at a price you can afford — The DENTRON Clipperton L linear amplifier! *Dentron*

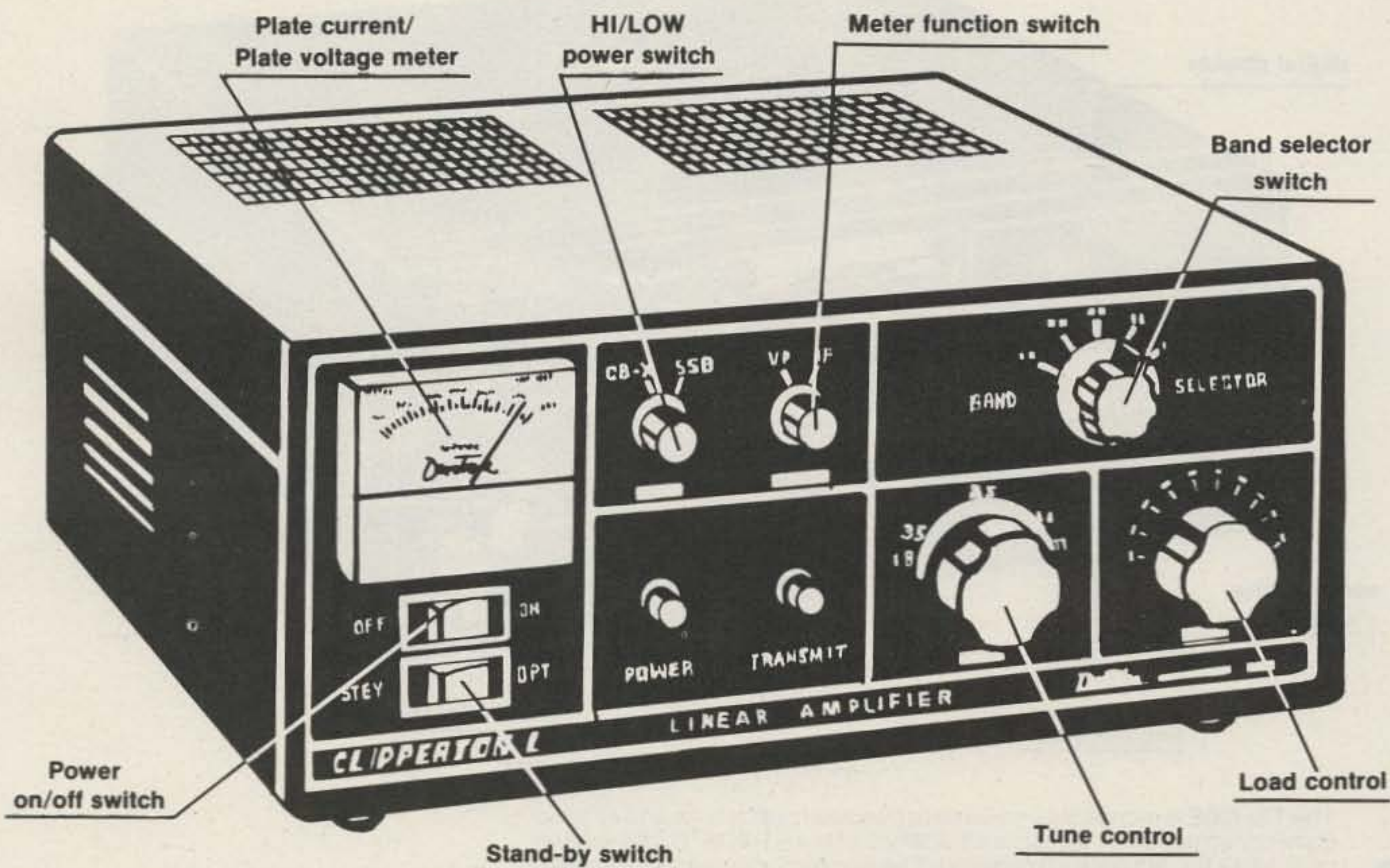

The Clipperton L linear amplifier covers 160-15 meters and most MARS frequencies. It delivers 2000 watts PEP input on SSB and 1000 watts DC input on CW, RTTY, or SSTV; all continuous duty. There are four 572B triodes operating in grounded grid, hi/lo power switching and linear bypass from the front panel, a large illuminated meter for monitoring plate current and plate voltage, a built-in continuous duty power supply—2500 volt idle SSB — 1800 volt idle CW approximately with rear panel selection of 117 volts or 234 volts primary transformer taps and adjustable ALC. The Clipperton L also features forced air cooling for longer tube life, harmonic suppression that meets or exceeds FCC requirements, 50 ohm impedance unbalanced at better than 1.5 to 1 VSWR and 50 ohm output impedance. Size: 6"H x 14½"W x 14½"D. Weight: 42 lbs.

CALL NOW!

699.50

List Price. Call for quote.

Call
Toll Free **1-800-633-3410**

IN ALABAMA CALL 1-800-292-8668 9 AM TIL 5:30 PM CST, MONDAY THRU FRIDAY

Kenwood TS-120S compact all solid state HF SSB transceiver

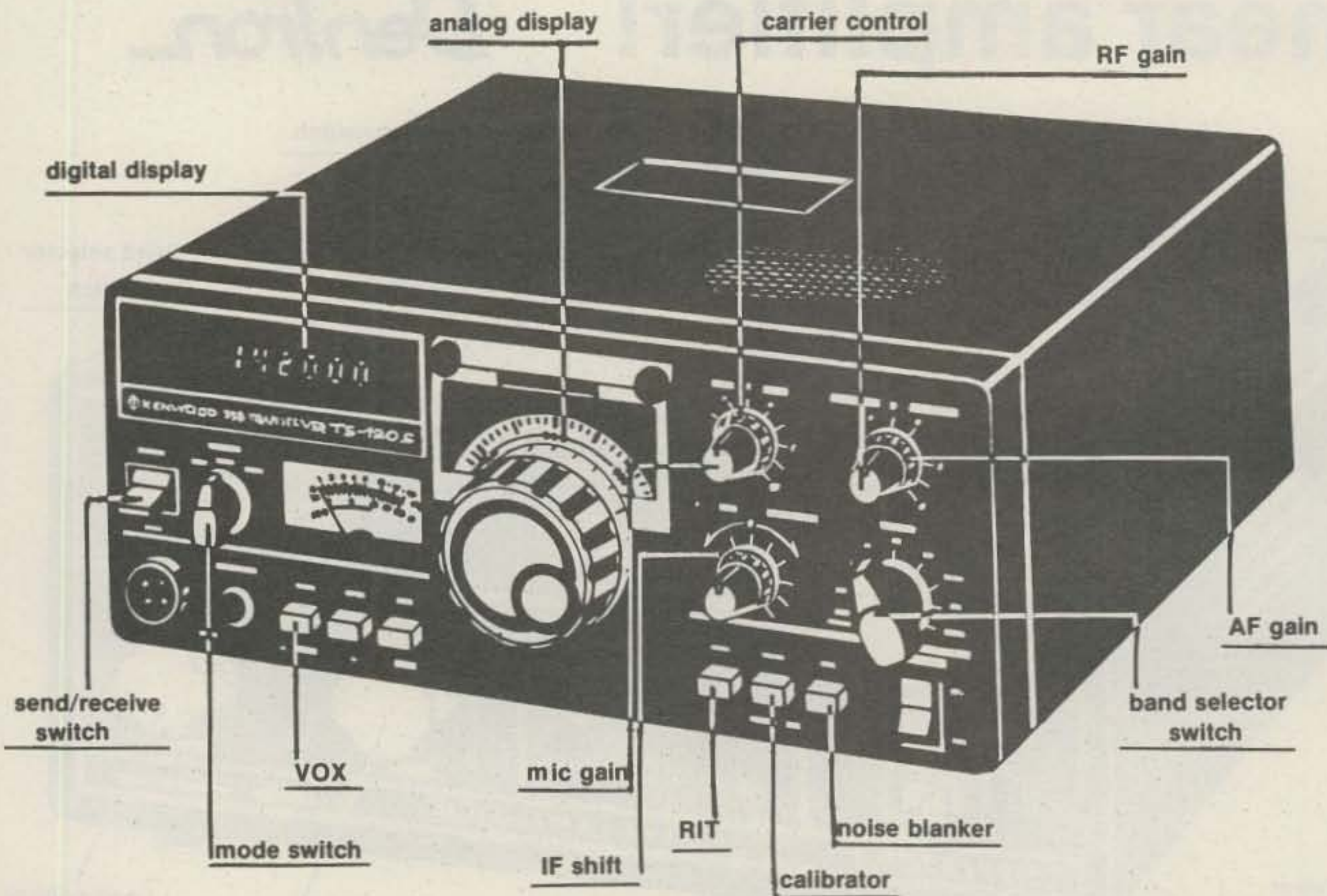

The TS-120S is incredibly small due to miniaturized circuits and all solid state construction. It measures 9½"W x 3¼"H x 11-9/16"D and weighs only 12.32 lbs. No tune up required. The single-conversion PLL system improves transmission and reception and makes IF shift operation and mono-dial indication available on any mode. A built-in 6-digit digital frequency display indicates the operating frequency to 100 Hz on any band and in any mode without recalibration. Four fixed channels available. One crystal element can be added to each of the 7, 14, 21, and 28-MHz bands. Fixed-channel operation is also possible on the 3.5-MHz band by changing an inside connector. Features 200 watts PEP, IF shift, final transistor protection, built-in cooling fan, VOX, built-in noise blanker, and built-in 25 KHz marker. The front-panel meter functions as an "S" meter on receive and as an IC meter and ALC meter on transmit. Any impedance mic, from 500 ohms to 50 K, may be used with the TS-120S. It covers 80 to 10 meters and WWV, modes: SSB and CW. Power requirements: R: 0.7A 13.8 VDC, T: 18A 13.8 VDC. Power supply PS-30 optional **139.00** list price.

 **KENWOOD**

Frequency stability: Within 100 Hz during any 30 min. period after warmup. Within ± 1 KHz during the first hr. after 1 min. warm up. Sensitivity: 0.25 micro V at 10 dB S/N. Selectivity: SSB 2.4 KHz (-6dB) 4.2 KHz (-60dB), CW 0.5 KHz (-6dB) 1.8 KHz (-60dB).

699.95

List Price. Call for quote.

Long's



Use your Master Charge or BankAmericard/VISA when you order.

Ham Radio Department Store

MAIL ORDERS: P.O. BOX 11347 BIRMINGHAM, AL 35202 • STREET ADDRESS: 2808 7TH AVENUE SOUTH BIRMINGHAM, ALABAMA 35233

Save \$85 on the KENWOOD TR-7625 2 meter 25 watt FM transceiver

SAVE \$85!

KENWOOD



The TR-7625 high-performance transceiver with memory is designed to permit multichannel (800-channel) operation. It features full 4 MHz coverage on 2m (144.00-147.995), digital PLL synthesizer in 5-KHz steps, large 4-digit digital and analog display, and dual concentric knobs for fast frequency selection. The memory circuit with simplex or repeater operation ± 600 KHz transmitter offset stores your favorite operating frequency for instant recall. The memory circuit can also be programmed for odd splits for nonstandard repeaters. It also features mode switch for switching the transmit frequency up or down, MHz selector, and unlock indicator for transceiver protection. The TR-7625 is compact in size (6-5/16" x 2-3/8"H x 9-1/16" D) and weighs only 3.85 lbs. Complete with Kenwood MC-30S noise canceling handheld mic. Adaptable for MARS repeater operation with optional MARS-7600 kit \$20. When combined with the optional RM-76 micro processor control unit (\$125 list) a whole new dimension unfolds in channel memory and scanning capability.

Sensitivity: less than 0.4 microV for 20dB quieting (less than 1 micro V for 30 dB S/N) RF output power: 25 watts min. HI, 5 watts adjustable to 10 LOW. Current drain: 6 amps on HI power transmit, 3 amps LOW.

339.95

List Price 425.00.

Call Toll Free **1-800-633-3410**

IN ALABAMA CALL 1-800-292-8668 9 AM TIL 5:30 PM CST, MONDAY THRU FRIDAY

Signalcrafters Presents The Most Advanced Automatic Computing Power Meters In Amateur Radio!



MODELS 31 and 32*

Our portable Models 31 and 32 feature the same state-of-the-art technology that is incorporated in their Big Brother, the Model 30. Never again will you have to bother with SWR "calibrate" controls and switches! Signalcrafters' custom integrated circuit makes power and SWR measurement a "handsoff" operation by automatically computing SWR. The result is unparalleled accuracy and ease of operation.

FEATURES:

- **CUSTOM IC**—Computes SWR from the level sensed on the transmission line independent of the power level. This analog computer operates over a range of only one watt to the full scale of the meter with unequalled accuracy.
- **RUGGED TAUT-BAND METERS**—Provide accuracy and readability that must be seen to be appreciated.
- **HEAVY DUTY CABINETS**—Handsome heavy duty metal cabinets complement virtually every transceiver on the market today.
- **TWO MODES—PEAK OR AVERAGE**—The amateur may choose between either peak or average power readings.
- **POWER REQUIREMENTS**—Due to the advanced low current design, battery life is truly outstanding, making this meter a natural for portable or field day operation. Uses standard 9 volt battery or 120V AC with optional AC adaptor.
- **ATTRACTIVE AFFORDABLE PRICING**
*Model 31A (0 to 200w)
31B (0 to 20w)
..... only \$149.00
Model 32A (0 to 200w, 0 to 2000w)
32B (0 to 20w,
0 to 200w)
✓S130 only \$169.00

SIGNALCRAFTERS, INC.®
5460 BUENA VISTA DRIVE
SHAWNEE MISSION, KANSAS 66205
913/262-6565; TELEX 42-4171

All Signalcrafters products are designed, engineered, and produced in the U.S.A. Prices include shipping to all U.S.A. VISA and Master Charge accepted. Kansas Residents please add 3% percent.

Directional RF wattmeters from Dielectric

The new 1000-A Wattmeter from Dielectric accepts plug-in elements that permit RF measurements from

100 mW to 5000 watts full-scale and from 2 MHz to 1 GHz. The large 4½" meter face is easy to read and has ±5% full scale accuracy and great resolution.

The 1000-A is available in a convenient all-purpose kit that includes a SNIFFER adjustable RF signal sampler, spare UHF connector and patch cable. All contained in a durable carrying case.

RF Instruments for Professionals

For the name of your local distributor, call Toll Free 800-341-9678.

A limited number of distributor locations are currently available; inquiries welcomed.



DIELECTRIC COMMUNICATIONS ✓ D29

A UNIT OF GENERAL SIGNAL
RAYMOND, MAINE 04071 • TEL. 207-655-4555 • 800-341-9678



TRS-80 OWNERS!

M800 Deluxe RTTY for the TRS-80

Adds these additional RTTY features to the M80.

- Split-screen display. Full ASR.
- Save all text on cassette.
- Instant Replay - RCV and XMT text.
- Instant break operation - preserves buffers.
- WRU - save on cassette - automatically.
- Execute external programs - interactive graphics.
- One-time callsign insertion.
- Auto line numbers, margin labels, CR / LF, CR suppress, XMTR control.
- 4 small messages (255 char. ea.) plus big message (up to max. RAM).
- Additional RY, FOX, CQ messages.
- UT4 output speed control.
- Baudot (4speeds) plus ASCII (110 baud).

Requires the **\$99**
M80 Ham
Interface.

M80 Ham Interface Send-Receive RTTY & CW

- Auto send. & receive: RTTY & CW
- Complete hardware & software.
- Connects to TRS-80 User Port & Key / headphone jacks.
- 10 message memories - 255 char. ea.
- Keyboard buffer - allows typing ahead.
- Uses built-in PLL or external TU.
- Includes hardware, cassette & manual.
- Morse trainer - random 5 letter words.
- Requires Level II Basic & 16K RAM.

NEW FEATURES★

- MORSE tutorial-10 lessons-corrects mistakes-Simplest, fastest way to learn the code!
- Auto-numbering contest keyer.
- Interactive Graphics-Custom PIX.
- Auto transmitter control-PTT.

Assembled **\$149.**
& Tested

■ PET, APPLE, SORCERER versions available.

Write or Call for Complete Catalog.



MACROTRONICS, inc.®

1125 N. Golden State Blvd./Suite G (S)
Turlock, California 95380/(209) 667-2888/634-8888 California residents
✓ M48 add 6% tax

We are experiencing telephone difficulties, please keep trying.

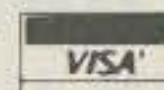

This MFJ RF Noise Bridge . . .

lets you adjust your antenna quickly for maximum performance. Measure resonant frequency, radiation resistance and reactance. Exclusive range extender and expanded capacitance range gives you much extended measuring range.



• Exclusive range extender • Expanded capacitance range • Series Bridge

\$54⁹⁵

This new MFJ-202 RF Noise Bridge lets you quickly adjust your single or multiband dipole, inverted Vee, beam, vertical, mobile whip or random system for maximum performance.

Tells resonant frequency and whether to shorten or lengthen your antenna for minimum SWR over any portion of a band.

MFJ's exclusive range extender, expanded capacitance range (± 150 pf) gives unparalleled impedance measurements, 1 to 100 MHz. Simple to use. Comprehensive computer proven manual.

Works with any receiver or transceiver. SO-239 connectors. 2 x 3 x 4 inches. 9 volt battery.

Other uses: tune transmatch; adjust tuned circuits; measure inductance, RF impedance of amplifiers, baluns, transformers; electrical length, velocity factor, impedance of coax; synthesize RF impedances with transmatch and dummy load.

Order from MFJ and try it — no obligation. If not delighted, return it within 30 days for a refund (less shipping). This bridge is unconditionally guaranteed for one year.

To order, simply call us toll free 800-647-1800 and charge it on your VISA or MasterCard or mail us a check or money order for \$54.95 plus \$3.00 for shipping and handling.

Don't wait any longer to enjoy maximum antenna performance. Order today.

CALL TOLL FREE . . . 800-647-1800

Call 601-323-5869 for technical information, order/repair status. Also call 601-323-5869 outside continental USA and in Mississippi. ✓ M52

MFJ ENTERPRISES, INC.
BOX 494, MISSISSIPPI STATE, MS 39762

New! Amateur Upgrade™



Upgrade today!
Great for
ham parties
and clubs,
\$9.95 each

Kantronics Amateur Upgrade is an educational board game that familiarizes players with FCC rules governing amateur radio and elementary radio concepts. The game comes complete with playing surface, playing pieces — coil, grommet, etc —, a die, exam cards and answer sheets, over 100 Novice, General, Advanced and Extra questions in all.

Players roll the die to determine the number of spaces to move. Some spaces players land on have a consequence such as "exceeded 1000 watts — answer question, if wrong go to start." When a player lands on an exam space, he must take an exam card. After three cards have been collected by one player, he must take the exam, hoping to upgrade. The first person to progress through all levels to obtain the Extra-class WINS! Novice exam cards may be used exclusively for beginner play.

KANTRONICS

The Training Company

1202 East 23rd Street
Lawrence, Kansas 66044

We accept Visa, Master Charge, check and money orders.

Phone: 913-842-7745

DOOZIES

Cushcraft "boomer"	\$ 69.95
OMNI-J 2 Meter Antenna	39.95
Tonna F9FT Antennas 144/16 el.	59.95
Klitzing VHF-UHF Amplifiers	
2M 10W in - 100W Out	179.95
432 10W in - 50W Out	189.95
Bird 43 and slugs, UPS paid in USA	stock
Microwave Modules, less 15% off list stock	
Telrex TB5EM, in stock	415.00
New Telrex TB5ES, 2 KW pep version	315.00
New Palomar Engr. Trans. Preamp	89.50
Bencher Paddles — \$39.95 Chrome	49.95
Vibroplex paddles in stock, plus bugs, write for prices.	
ETO 76 Amplifiers	stock
Lunar 6M-2M-220 In Line Preamps	49.95
Janel QSA-5	41.95
HAM-X Tailtwister Rotor	189.95
HAM-4 Rotor	139.95
Cetron 572B	29.50
New HDI HC-1400 144/148MHZ, 25 watt, Synthesized 2 meter transceiver	349.00
Remote digital readout	49.95
Motorola HEP170	0.29
Mallory 2.5A/1000PIV epoxy diode	0.19
Aerovox 1000PF/500V Feed thru cap	1.95
Technical Books: Ameco, ARRL, Sams, Tab, Rider, Radio Pub., Callbook, Cowan, WRTVH, etc.	Call
NEW Belden 9405 (2#16/6#18) 8 wire rotor cable, heavy duty for long runs	0.32/ft
8448 8 wire rotor cable	0.20/ft
9888 double shield RG8 Foam	0.46/ft
8214 RG8 Foam	0.26/ft
8237 RG8 Regular	0.23/ft
8267 RG213	0.30
Amphenol Silver Plate PL259 (831SP)	0.69
Belden 14 ga. stranded antenna wire #8000	0.06/ft
Times 1/2" Foam Hardline \$0.65/ft. — Connectors, ea.	15.00
Berktek RG8X, 52 ohm, KW, per ft.	0.16
Robot "Slow Scan" Now in Stock	Call
Alliance HD73 Rotor	109.95
Teletow'r-self support: 55 ft/w breakover	549.00
40 ft/w breakover	399.00
Telrex antennas? In Stock! Monobanders? You bet!	

Looking for antique parts?
Write specific need to W5GJ.

THIS MONTH'S SPECIALS:

Icom IC701, AC, MIC —	\$1,195.00
NEW ICOM IC255A, 2M —	\$349.00
Dentron GLA 1000 Amp.	\$319.00
Dentron Clipperton L —	\$499.00
(Limited Qty.)	
New Price \$599.00 after current supply runs out.	
Kenwood TS700SP	\$599.00;
TR7625	\$399.00;
TR7600	\$299.00; RM76 \$99.95.
Limited Qty.	

MASTERCARD • VISA

All prices fob Houston except where indicated. Prices subject to change without notice, all items guaranteed. Some items subject prior sale. Send letterhead for Dealer price list. Texas residents add 6% tax. Please add postage estimate \$1.00 minimum.

MADISON
ELECTRONICS SUPPLY, INC.
1508 McKINNEY
HOUSTON, TEXAS 77002
713/658-0268 ✓ M35

Go-Cart

— wheels for your test equipment

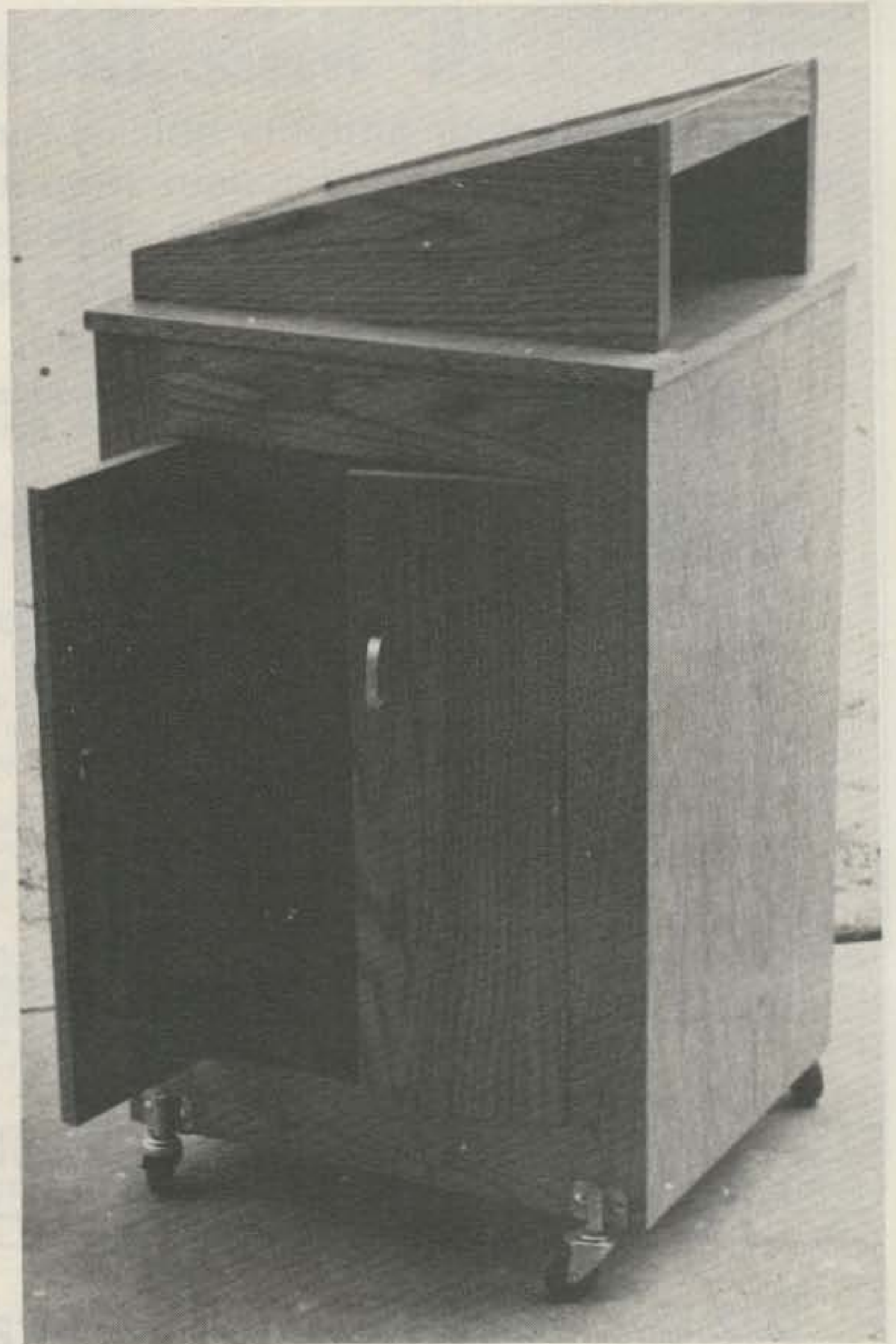

Max Holland W4MEA
Rt. 3, Rawlings Lane
Madisonville TN 37354

If you would like to combine the hobby of amateur radio with woodworking, then this might be the project for you. The original cart was designed for a graphic display terminal. It will be approximately the right size for even the largest oscillo-

(OAK NATURAL FINISH)

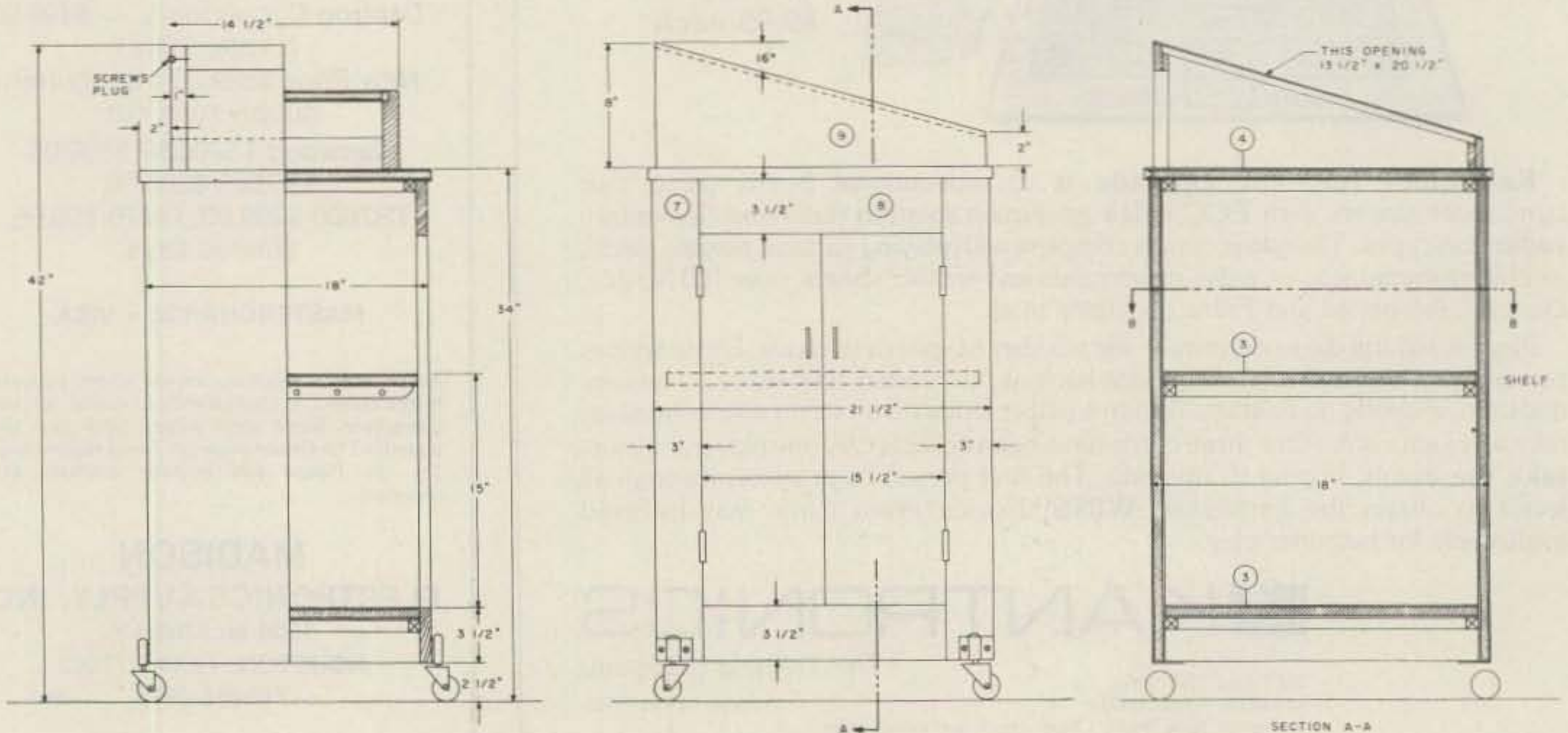

scope. The doors on the cart could be left off; however, they do not add much to the total cost and do keep the items inside secure. The good quality wheels are worth the extra expense.

The cost of materials will be approximately \$30.00. Compare this with the cost of a commercially-manufactured cart. The prices of other carts vary between \$135.00 and \$300.00. Very few would try to duplicate this cart exactly, so the drawing is used only to show some of the construction in this unit. The plywood is press-type wood with a thin veneer on both sides. G1S means "Good 1 Side," which means that one side is knot-free; however, the other side is often very good. This type of plywood can be used in place of G2S ("Good 2 Sides") if you want to save some money. ■

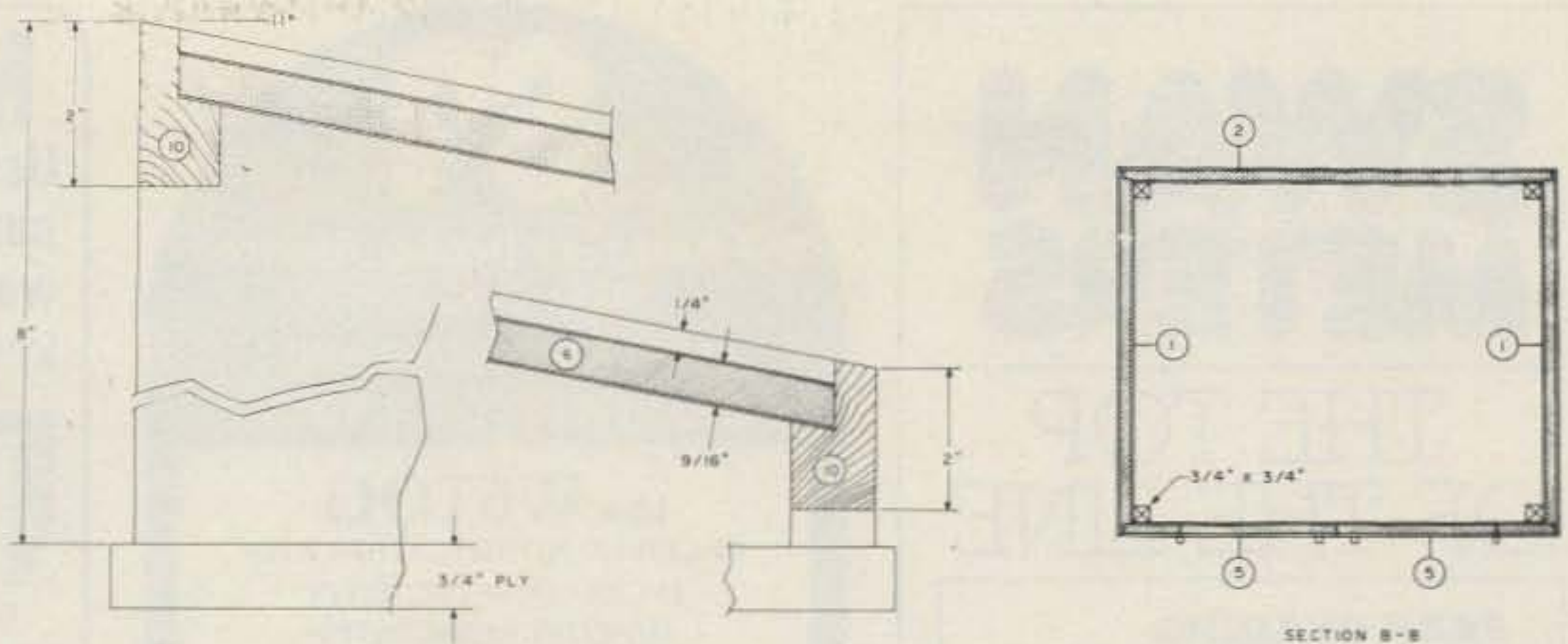

Part No.	No. Units	Size	Part Description
1	2	3/4" x 18" x 30 3/4"	front and back, ply G1S
2	1	3/4" x 21 1/2" x 30 3/4"	left side, ply G1S
3	2	3/4" x 16 1/2" x 20"	shelf and bottom, ply G1S
4	1	3/4" x 18 1/2" x 22"	top, ply G1S
5	2	3/4" x 7 3/4" x 23 3/4"	doors, ply G2S
6	1	1/2" x 13 1/2" x 20 3/4"	sloping top, ply G1S
7	2	3/4" x 3" x 30 3/4"	sides of frame for doors, oak, solid
8	2	3/4" x 3 1/2" x 17 1/2"	top & bottom for door frame, oak, solid
9	2	1" x 8" x 20 5/8"	side of top unit, oak, solid
10	2	1" x 2" x 14 1/2"	ends of top unit, oak, solid
	4	12 linear feet of 3/4" x 3/4" strips as required	casters and mounting brackets
	4	hinges 2 1/2" x 2 1/2"	
	2	roller catches for doors	
	2	handles	

ALL-MODE VHF amplifiers

FOR BASE STATION & REPEATER USE

MODEL: V350



- ☆ Built-in 115/230 VAC Supply
- ☆ AM-FM-CW-SSB-RTTY
- ☆ 60dB Harmonics
- ☆ 60dB Spurious
- ☆ Heavy Duty Design

MODEL: V180

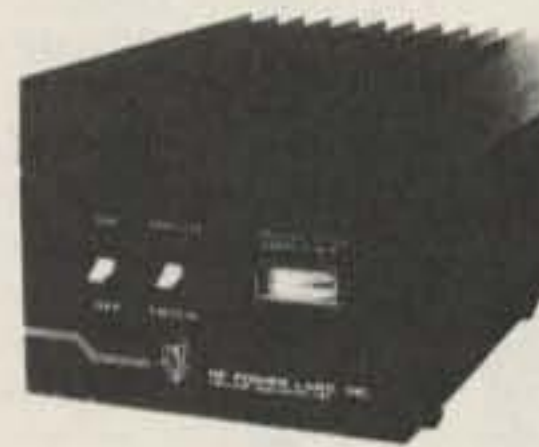

- ☆ Illuminated Panel Meter
- ☆ Automatic T/R Switching
- ☆ VSWR Protected
- ☆ + 13V/3A Accessory Socket
- ☆ U.S. Manufactured

All Solid-State!

MODEL	FREQUENCY	INPUT	OUTPUT	SIZE WxDxH	WEIGHT	FAN KIT REQUIRED	PRICE
V76	50-54MHz	8-15W	100-120W	216x330x178mm	11.7 kg (26 lbs)	No	\$339.00
V360	50-54MHz	2-10W	400-450W	432x330x178mm	23.4 kg (52 lbs)	Yes	\$895.00
V70	144-148MHz	10-15W	75-90W	216x330x178mm	11.7 kg (26 lbs)	No	\$315.00
V71	144-148MHz	1-3W	75-90W	216x330x178mm	11.7 kg (26 lbs)	No	\$349.00
V180	144-148MHz	5-15W	170-200W	216x330x178mm	13.5 kg (30 lbs)	CW & FM	\$539.00
V350	144-148MHz	10-20W	350-400W	432x330x178mm	23.4 kg (52 lbs)	Yes	\$895.00
V130B	220-225MHz	10-15W	70-85W	216x330x178mm	11.7 kg (26 lbs)	No	\$329.00
V135B	220-225MHz	25-35W	140-160W	216x330x178mm	11.7 kg (26 lbs)	CW & FM	\$469.00
F110		Fan Kit, 115VAC		135x135x50mm	1 kg (2.2 lbs)	—	\$ 33.00
F220		Fan Kit, 230VAC		135x135x50mm	1 kg (2.2 lbs)	—	\$ 33.00
*F135		Fan Kit, 115VAC		381x140x89mm	3.2 kg (7 lbs)	—	\$ 59.00
*F235		Fan Kit, 230VAC		381x140x89mm	3.2 kg (7 lbs)	—	\$ 59.00
RM-1		19 Inch Rack Adaptor		483x3x178mm	1 kg (2.2 lbs)	—	\$ 25.00
*RM-2		19 Inch Rack Adaptor		197x32x28mm	.5 kg (1.1 lbs)	—	\$ 12.00

* Used with the V360 & V350 Amplifiers

Other Frequencies Available on Request

Dealer Inquiries Invited

Meeting all applicable FCC Requirements.

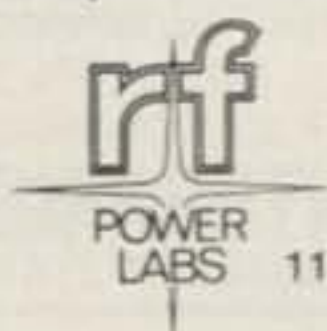

RF POWER LABS, INC.

✓ R27



11013-118th Place N.E. • Kirkland, Washington 98033 Telephone: (206) 822-1251 • TELEX No. 32-1042

SWAN METERS

THE TOP OF THE LINE

PEAK READING WATT METER WM-2000A reads power in 200, 1000, 2000 watt ranges. 3.5-30 MHz. Reads average or PEP power output. Includes expanded VSWR scale.



IN-LINE WATT METER WM-2000 reads power in 200, 1000, 2000 watts. 3.5-30 MHz. Incl. expanded VSWR scale.



MOBILE WATT METER HFM-200 with remote directional coupler reading 20 or 200 watts. 3.5-30 MHz. Illuminated, with VSWR scale.



SWR BRIDGE SWR 1A with dual reading meters. 1000 watts RF. 3.5-150 MHz. Reads relative power output.



Available only through authorized dealers.



✓ S44

A division of Cubic Communications, Inc.
305 Airport Rd. • Oceanside, Ca. 92054
(714) 757-7525

SF

S-f Amateur Radio Services
(213) 837-4870
4384 KEYSTONE AVE.,
CULVER CITY, CA. 90230

the W6TOG RECEIVER MODIFICATION KITS

INCREASE SELECTIVITY
IMPROVE SENSITIVITY
LOWER INTERNAL NOISE
COMBAT BLOCKING
FROM LOCAL SIGNALS

TS-520 KIT	\$27.50
TS-520S KIT	32.50
TS-820 & 820S KIT	34.50
TS-820 MIXER KIT	27.50
TS-120S KIT	32.50
R-820 KIT	34.50
FRG-7000 KIT	32.50
FT-101 SERIES KIT	32.50
FT-101ZD KIT	34.50
FR-101 SERIES KIT	34.50
FT-301 SERIES KIT	34.50
FT-901 SERIES KIT	34.50
ATLAS-210 OR 215X KIT	34.50
ALDA-103 OR 105 KIT	32.50

* MAGICOM PROCESSOR MODIFICATION KIT

INCREASES AUDIO PUNCH
IMPROVES
PROCESSED SPEECH QUALITY

TS-520/S	42.50
TS-820/S	27.50

NEW

TS-120/S	42.50
DRAKE T4XC	52.50
DRAKE TR7	42.50

The "MAGICOM" provides up to 6dB increase in output with smooth, clean, non-distorted audio and more penetration for those pile-ups. Easy installation. (No front panel alteration)

* HI POWER KITS

INCREASE OUTPUT POWER BY 30%

Set of (2) 6146-W final tubes
Plate rating 40W per tube

GET MORE DRIVE FOR
THOSE HI POWER AMPLIFIERS!!!

TS-520 / 520S QRO KIT	\$39.50
TS-820 / 820S QRO KIT	39.50

10% OFF ON KIT ORDERS
TOTALING \$75.00 OR MORE

SEND FOR PRICING
AND INFORMATION ✓ S33

ALL PRICES POSTPAID
IN CALIF. ADD 6% SALES TAX
MASTERCARD & VISA ACCEPTED
SATISFACTION GUARANTEED
OR MONEY REFUNDED

MFJ KEYERS

Uses Curtis 8044 IC. All have dot-dash memories, weight control, solid state keying. RF proof.



BRAND
NEW

\$69⁹⁵

The NEW MFJ-406 Deluxe Electronic Keyer sends iambic, automatic, semi-automatic, manual. Use squeeze, single lever or straight key.

Socket for external Curtis memory, random code generator, keyboard. Optional cable, \$3.00.

Iambic operation with squeeze key. Dot-dash insertion. Semi-automatic "bug" operation provides automatic dots and manual dashes.

Dot-dash memory, self-completing dots and dashes, jam-proof spacing, instant start. RF proof.

Solid-state keying: grid block, solid state xmtrs.

Front panel controls: linear speed, weight, tone, volume, function switch. 8 to 50 WPM.

Weight control adjusts dot-dash space ratio; makes your signal distinctive to penetrate QRM.

Tone control. Speaker. Ideal for classroom.

Function switch selects off, on, semi-automatic/manual, tune. Tune keys transmitter for tuning.

Uses 4 C-cells. 2.5 mm phone jacks for external power (6-9 VDC). Optional AC adapter \$7.95.

Eggshell white, walnut sides. 6x2x6 inches. Optional Bencher Iambic Paddle, \$39.95.

\$49⁹⁵



The MFJ-400 8044 IC Econo Keyer is a reliable, full feature economy keyer for squeeze, single lever or straight key.

Sidetone, speaker, volume, speed, internal weight and tone controls. Pull-to-tune switch. On-off, iambic operation. Dot-dash memories. 8 to 50 WPM. Uses 9 V battery. 2x3x4 inches.

Reliable solid state keying: grid block, cathode solid state transmitters.



\$59⁹⁵



\$44⁹⁵

MFJ-404 8044 IC ECONO KEYSER at \$59.95 has adjustable single paddle, sidetone, speaker, weight, tone, volume, speed controls. Dot-dash memories. 8 to 50 WPM. Solid state keying. 2x3x4 inches. Uses 9 V battery. Switch for TUNE, OFF, ON, SIDETONE OFF. Jacks for external key, iambic with squeeze key.

MFJ-402 8044 IC ECONO KEYSER. \$44.95. Paddle, weight, speed controls. Dot-dash memories. 8 to 50 WPM. 2x3x4 inches. Uses 9 V battery. No sidetone and jacks for external key.

Order from MFJ and try it. If not delighted, return within 30 days for refund (less shipping).

One year unconditional guarantee.

Order yours today. Call toll free 800-647-1800. Charge VISA, MC. Or mail check, money order. Add \$3.00 each for shipping and handling.

CALL TOLL FREE ... 800-647-1800

Call 601-323-5869 for technical information, order/repair status. Also call 601-323-5869 outside continental USA and in Mississippi.

MFJ ENTERPRISES, INC.
BOX 494, MISSISSIPPI STATE, MS 39762

When it comes to
**AMATEUR
RADIO QSL's...**



it's the
ONLY BOOK!
US or DX Listings

**1980
callbooks
NOW READY!**

Here they are! The latest editions. World-famous Radio Amateur Callbooks, the most respected and complete listing of radio amateurs. Lists calls, license classes, address information. Loaded with special features such as call changes, prefixes of the world, standard time charts, world-wide QSL bureaus and more. The new 1980 Radio Amateur Callbooks are available now. The U.S. Edition features over 400,000 listings, over 120,000 changes from last year. The Foreign Edition, over 315,000 listings, over 90,000 call changes. Place your order now.

	Each	Shipping	Total
<input type="checkbox"/> US Callbook	\$16.95	\$1.75	\$18.70
<input type="checkbox"/> Foreign Callbook	\$15.95	\$1.75	\$17.70

Order both books at the same time for \$34.65, includes shipping.

Order from your favorite electronics dealer or direct from the publisher. All direct orders add \$1.75 for shipping. Illinois residents add 5% Sales Tax.



SPECIAL LIMITED OFFER!
**Amateur Radio
Emblem Patch
only \$2.50 postpaid**

Pegasus on blue field, red lettering. 3" wide x 3" high. Great on jackets and caps. Sorry, no call letters.

ORDER TODAY!

✓ R1

**RADIO AMATEUR
callbook INC.**



925 Sherwood Drive
Lake Bluff, IL 60044

FOR THE EXPERIMENTER

CRYSTALS & KITS/OSCILLATORS • RF MIXERS • RF AMPLIFIER • POWER AMPLIFIER

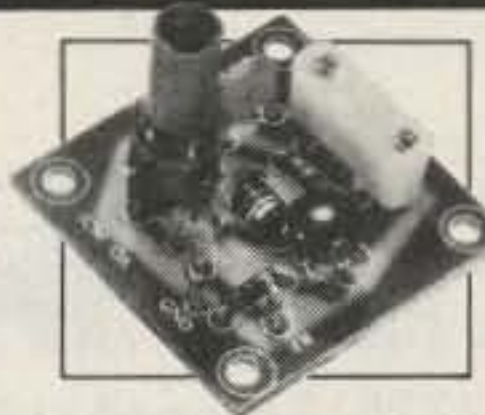

OX OSCILLATOR

Crystal controlled transistor type. 3 to 20 MHz, OX-Lo, Cat. No. 035100. 20 to 60 MHz, OX-Hi, Cat. No. 035101.

Specify when ordering.

\$5.74 ea.

MX-1 TRANSISTOR RF MIXER

A single tuned circuit intended for signal conversion in the 3 to 170 MHz range. Harmonics of the OX or OF-1 oscillator are used for injection in the 60 to 170 MHz range. 3 to 20 MHz, Lo Kit, Cat. No. 035105. 20 to 170 MHz, Hi Kit, Cat. No. 035106.

Specify when ordering.

\$6.38 ea.

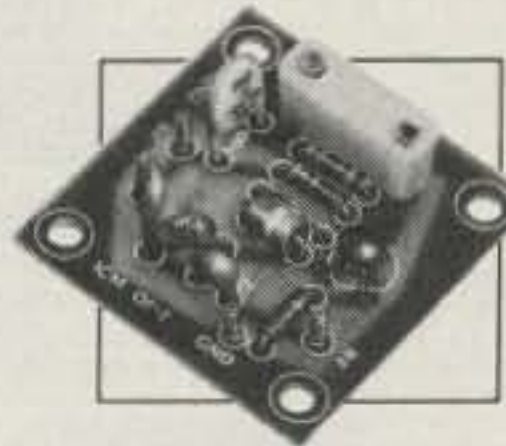

OF-1 OSCILLATOR

Resistor/capacitor circuit provides osc over a range of freq with the desired crystal. 2 to 22 MHz, OF-1 LO, Cat. No. 03t108, 18 to 60 MHz, OF-1 H Cat. No. 035109.

Specify when ordering.

\$4.93 ea.

PAX-1 TRANSISTOR RF POWER AMP

A single tuned output amplifier designed to follow the OX oscillator. Outputs up to 200 mw, depending on frequency and voltage. Amplifier can be amplitude modulated 3 to 30 MHz, Cat. No. 035104.

Specify when ordering.

\$6.67 ea.

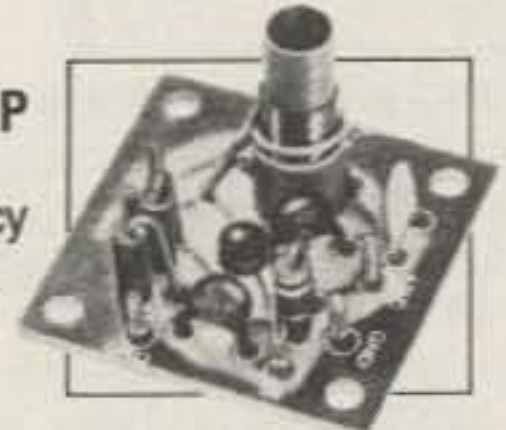

SAX-1 TRANSISTOR RF AMP

A small signal amplifier to drive the MX-1 Mixer. Single tuned input and link output. 3 to 20 MHz, Lo Kit, Cat. No. 03512. 20 to 170 MHz, Hi Kit, Cat. No. 035103.

Specify when ordering.

\$6.38 ea.

BAX-1 BROADBAND AMP

General purpose amplifier which may be used as a tuned or untuned unit in RF and audio applications. 20 Hz to 150 MHz with 6 to 30 db gain. Cat. No. 035107.

Specify when ordering.

\$6.67 ea.

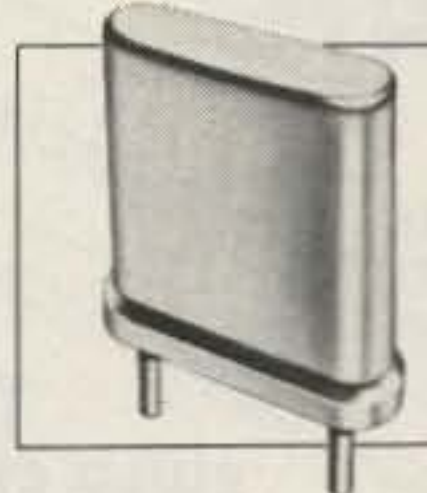

.02% Calibration Tolerance

EXPERIMENTER CRYSTALS (HC 6/U Holder)

Cat. No.

Specifications

031080 *3 to 20 MHz — For use in OX OSC Lo \$6.88 ea.

031081 *20 to 60 MHz — For use in OX OSC Hi \$6.88 ea.

031300 *3 to 20 MHz — For use in OF-1L OSC \$5.74 ea.

031310 *20 to 60 MHz — For use in OF-1H OSC \$5.74 ea.

*Specify when ordering

Shipping and postage (inside U.S., Canada and Mexico only) will be prepaid by International Prices quoted for U.S., Canada and Mexico orders only. Orders for shipment to other countries will be quoted on request. Address orders to: M/S Dept., P.O. Box 34297, Oklahoma City, Oklahoma 73132



INTERNATIONAL CRYSTAL MFG. CO., INC.
10 North Lee / Oklahoma City, Okla. 73102

MFJ ^{✓M52} ANTENNA TUNERS



\$69⁹⁵

NEW MFJ-940 VERSA TUNER II matches coax and random wire 1.8 to 30 MHz.

Up to 300 watts RF OUTPUT. SWR, dual range wattmeter (300 and 30 watts full scale).

Six position antenna switch on rear. Select 2 coax lines direct or thru tuner, random wire, and tuner bypass for dummy load.

New efficient airwound inductor (12 positions) gives you less losses than tapped toroid for more watts out. 8x2x6 inches. SO-239 coax connectors. 208 pf, 1000 volt capacitors.

Optional mobile mounting bracket, add \$3.00.

Beware of imitators. When you buy MFJ you buy proven MFJ quality . . . and a one year unconditional guarantee.



\$39⁹⁵

MFJ-900 ECONO TUNER matches coax, random wires. Full band coverage 1.8 to 30 MHz. Up to 200 watts RF OUTPUT. Efficient airwound inductor gives more watts out than tapped toroid.

SO-239 coax connectors. 5x2x6 inches. One year unconditional guarantee.

MFJ-901 Versa Tuner available. Same as MFJ-900 but has 4:1 balun for balanced lines. \$49.95.

Beware of imitators. Some are still copying our earlier models. MFJ has made improvements.

For example, a new efficient airwound inductor gives you less losses than a tapped toroid for more watts out and plenty of inductance for full band coverage 1.8 to 30 MHz.

\$29⁹⁵



MFJ-16010 RANDOM WIRE TUNER lets you operate 1.8 to 30 MHz with random wire. Up to 200 watts RF OUTPUT. Small enough to carry in your hip pocket. Ultra compact 2x3x4 inches.

Match low and high impedances by interchanging input and output. SO-239 coax connectors.

One year unconditional guarantee.

Order from MFJ and try it. If not delighted, return within 30 days for refund (less shipping).

Order yours today. Call toll free 800-647-1800. Charge VISA, MC. Or mail check, money order. Add \$3.00 each for shipping.

CALL TOLL FREE . . . 800-647-1800

For technical information, order/repair status, in Miss., outside continental USA, call 601-323-5869.

MFJ ENTERPRISES, INC.
BOX 494, MISSISSIPPI STATE, MS 39762

DUPLEXER & CAVITY DIGEST

- ★ 6 Meters, 2 Meters, 220 MHz, 450 MHz
- ★ CONSTRUCTION DETAILS, OPERATION
- ★ CONFIGURATIONS, CHARACTERISTICS
- ★ COUPLING, CASCADING, ISOLATION
- ★ APPLICATIONS, MEASUREMENTS
- ★ NOISE, DESENSE, INTERMODULATION
- ★ PROBLEMS, SOLUTIONS, FIGURES

\$8.50 POST PAID

✓C162

Castle Publishing



Box 17778 • Tucson • Az • 85731

✓D76

Digitrex Electronics

PA-19 Wideband Preamplifier

- 2 to 200 MHz Bandwidth (3dB Points)
- 19 dB Gain!
- 50 Ohms Input & Output Impedance
- Tiny PC Board Size (7/8" x 1-5/8")
- Absolutely No Tuning Required
- Extremely Stable
- Draws only 20mA @ 12VDC
- Great Way to Increase Sensitivity of Receivers, Counters, etc
- Fully Assembled and Tested
- Instructions Provided, Full Warranty



only **\$8.95**
- 50 Shipping/Handling

Portable 600 MHz Frequency Counter

- 1-600 MHz Range
- 1 KHz or 100 Hz Resolution
- Assembled and Tested
- Full Lifetime Warranty
- Size: 5" L x 2 1/2" W x 1 1/4" H
- BNC Whip Antenna Opt. \$8.95



\$59.95 ppd. (less ant.)

C.O.D. Orders Welcome

Digitrex Electronics

4412 Fernlee, Royal Oak Michigan 48073 313-651-9247

• 75 mV Sensitivity

LATEST ADDITIONS! ASSEMBLED AND TESTED!

PS 300	300 MHz Prescaler - 10 Output	14.95
PS 600	600 MHz Prescaler - 10 and 100	28.95
PS 1250	500 MHz / 100, 1250 MHz / 1000 (the cast case)	79.95
RD 430	4 Digit Recv. Display, 100 Hz resolution, works with any Recv. with 1MHz or less VFO range per band. Simple hook up.	49.95
Model 81250	8 Digit Frequency Counter, Range: 2-1250 MHz in two ranges. Smaller than Cigarette pack (less supply)!	99.95

THE LITTLE GIANT BRAKE BEND & FORM .060 ALUM. & STL.

CLEAN SMOOTH BENDS TO 90°



EASY TO USE

BUILD CUSTOM CABINETS YOU'LL BE PROUD OF! COMMERCIAL QUALITY AT 1/10 THE COST!

GUARANTEED! 19⁹⁵

Z ASSOCIATES
P O BOX 757
3050 NE 55 TH AVE. ✓Z5
SILVER SPRINGS, FLA. 32688

+1.50 SHIPPING
SORRY! NO CODA

New SATELLITE For the TV home.



Supersharp Reception—Color Like Never Before

Get over 50 channels of television directly from the satellite! HBO, Showtime, the Superstations, and sports from around the world!

Works Anywhere!

Buy complete or build and save. Our book tells everything! Send \$7.95 today or call our 24 hr. C.O.D. Hotline!

(305) 869-4283

SPACECOAST RESEARCH ✓S117

P.O. Box 442, Dept. G, Altamonte Springs, FL 32701

HAM SCAN-1: YAESU MEMORIZER

* Scans 145-148 MHz in 10 sec., stops 3 sec. on active channels, simple 7 wire installation.

ORDER HAM SCAN-1.....\$39.95

HAM SCAN-2: K'WD 7625, 7600,

7400A, KDK 2015R, 2016A, CLEGG FM-28 MIDLAND 13-510, HW-2036, Others soon.

* Adds one channel of memory to any above rig
* Scan range selectable by position of radio's MHz switch. Up to full 4 MHz width.

* Scan rate 200 kHz/sec at 10 kHz steps with a 3 second pause on all active channels

* Mike-mounted switch provides 3 functions: start/stop, remote freq. incrementing and xmit interlock while actively scanning

* Scanner mounts inside radio, no external box

* Assembled, tested and guaranteed \$59.95

ORDER HAM SCAN-2 and specify type of radio

Technical Clinic

P.O. BOX 636

✓T64

STERLING HTS. MI 48078

Phone Orders Call: (313) 286-4836

AN/APR-4Y AM & FM Receiver—115 Volts 60 Cycle for Frequencies 38 to 4000 megacycles. **\$79.50**

(Tuning Units Available P.U.R.)

AN/ART-13 Transmitter for 80, 40, 20 and 10 meters. 100 Watts Output on AM, CW & MCW.

With all tubes **\$47.50**

SCR-522 TRANSMITTER-RECEIVER 100-156 mc. Crystal Controlled on 4 Channel. Excellent condition.

All tubes **\$42.50**

ARC-5 TRANSMITTER with all tubes and crystal Brand new (BC-457-4.5.3mc. . . . BC-458-5.3-7mc.) **\$16.95**

AC POWER SUPPLY for above transmitter completely wired and tested. New **\$26.50**

R-28/ARC-5 VHF RECEIVER Crystal Controlled on 4 channels. 100-156 MC Excellent used cond. **\$27.50**

T-23/ARC-5 VHF Transmitter. Crystal Controlled on 4 channels. 100-156 mc. **\$29.50**

DM-32 Dynamotor, New **\$3.95**

R-23/ARC-5 RECEIVER 190-550 KC continuous tuning used, with all tubes **\$16.95**

ARR-2 RECEIVER 234-238 MC. New **\$10.95**

Write for catalog—send 50¢ for postage.

Terms: F.O.B. NYC. 25% deposit with order, balance COD or remittance in full. Subject to prior sale and price change.

G&G Radio Electronics CO.

✓G26

45-47 WARREN ST.

NEW YORK, NY 10007 Ph. 212-267-4605

DUPLEXERS



US PATENT
4080601

W15

OUR NEW BANDPASS-REJECT DUPLEXERS WITH OUR EXCLUSIVE

BpBr CIRCUIT*

... provides superior performance, especially at close frequency spacing.

Models available for all Ham bands. Special price for Amateur Repeater Clubs

CALL OR WRITE FOR DETAILS:

WACOM PRODUCTS, INC.



Box 7307
Waco, Texas 76710
817/776-4444

The QSL Organizer™ Holds 240 QSL's



FREE ALBUM with every 40 pages.

Tired of cluttering up your walls, stuffing QSL's in drawers and boxes? A great new way to organize, preserve and display your QSL cards is in clear vinyl pocket pages. Each specially designed, crystal clear heavy duty page, holds 6 cards (back to back). The roomy 4" x 6" pockets even hold those extra large Japanese QSL's. With every 40 pages (minimum) ordered, you'll receive, Free, a handsome 9" x 14" sturdy 3-ring album, fully padded, in durable 'Brown-Hide' vinyl.

As gifts for friends, as valuable club prizes, or as a treat for yourself - the QSL Organizer is a must, for every radio shack. Try it for 30 days. If you're not delighted, return it for full refund.

1 FREE Album and 40 pages at .47 ea.
plus \$1.95 shipping. Total \$20.75
2 FREE Albums and 80 pages at .45 ea.
plus \$3.45 shipping. Total \$39.45

Pages, pkgs of
40 only
CA residents
add 6% tax

Send Check, Money Order, Mastercharge, Visa to:

MIL INDUSTRIES Dept 3

P. O. Box #44457 Panorama City, CA 91402

M109

* ... at last ...
your shack organized!
A beautiful piece of furniture — your XYL will love it!

\$16450 S-F RADIO DESK
Deluxe - Ready to Assemble

Designed with angled rear shelf for your viewing comfort and ease of operation.

FINISHES: Walnut or Teak Stain.
Floor Space: 39" Wide by 30" Deep

Additional Information on Request. **SF**

Checks, Money Orders, BankAmericard and Master Charge Accepted. ✓ S33

F.O.B. Culver City. (In Calif. Add 6% Sales Tax.)
— DEALER INQUIRIES INVITED —

S-f Amateur Radio Services
4384 KEYSTONE AVENUE • CULVER CITY, CALIF. 90230 — PHONE (213) 837-4870

Radio equipment not included

Also Available
Floor Space: 51" Wide by 30" Deep
\$192.50



THE FIRST CHOICE IN REPEATER CONTROL

The Power and Flexibility of Microprocessor Technology

AUTOPATCH, REVERSE PATCH, SMART ID, ACCESS CODE
MUTING, MORSE CODE ANNOUNCEMENTS, FLEXIBLE
FUNCTION TIMEOUT, COURTESY TONE, LINKING,
CONTROL OP. FUNCTIONS, TWELVE USER FUNCTIONS,
... AND MUCH MORE.

Call or write for specifications:

MICRO CONTROL SPECIALTIES (617) 372-3442

✓ M69

23 ELM PARK GROVELAND, MA. 01834

new COAX SWITCHES

from Barker & Williamson

Model 593

- **Single Pole 3 Position** with grounding of all unused positions
- **Crosstalk** (measured at 30 MHz) is -45db between adjacent outlets and 60 db between alternate outlets



Model 594

- **2 Pole 2 Position**
- **Crosstalk** 45db (measured at 30 MHz)



Specifications for both switches

- **Power** 1 KW-2 KW PEP
- **Impedance** 50-75 ohms
- **VSWR** 1.2:1 up to 150 MHz
- **Dimensions** 1 3/4" high, 5" wide, 3" deep
- **Weight** 1 lb.
- **Mount** Wall or desk

✓ B23 Available at your B&W dealer



Barker & Williamson, Inc.
10 Canal St. Bristol, Pa. 19007
Telephone: (215) 788-5581

AHF ANTENNAS

INTRODUCES
OUR NEW
EXCLUSIVE

MOBILE ANTENNA

- ★ GREATER FIELD STRENGTH
- ★ GREATER TUNING RANGE
- ★ ALL NON-CORROSIVE PARTS
- ★ ALL THREADS U.S. STANDARD 3/8 x 24
- ★ MADE ENTIRELY OF QUALITY MATERIALS

Radiator, Mast, 10 Meter Adaptor, and
1 ea. 75, 40, 20 and 15 Meter Coils
(Parts may be purchased separately)

Common 2 - 4 - 6 and 8 MHz MARINE
frequency coils also available

2 to 30 MHz Custom Frequency
Coils, made to order

✓ A92 Contact your favorite dealer or
Write for brochure

AHF / ANTENNAS

2814 S. Baywater Ave.
San Pedro Ca. 90731
Phone (213) 831-5444

Dealerships available

from page 20

no relief from the problems created by the shared status of 3.5 and 7 MHz with HF broadcasting. These guesses, due to the lack of word from the conference, are like trying to bet Sunday's football games on Saturday with half the football league down with the flu.

Bits and pieces now from November's DX happenings:

Alex Kasevich W1CDC announced that the Caribe DX Association has had to scrap its plans for an expedition in August, 1980; Hurricane David last fall wiped out the group's sea-plane, which was based in Florida.

USSR stations, including UB5WF, UT5BN, and UC2AAK, are operating on 160 meters, most often at 0400 between 1850 and 1855.

K1MM operated from Mauritius (3B8), then from Reunion as FR0MM during the CQ CW Contest, putting in a single-band 10-meter effort; he went next to Malagasy Republic (5R8), but failed in attempts to obtain a license to operate. Word is that no American will be granted permission there in the foreseeable future. Bill (K1MM) operated from the Hong Kong QTH of VS6DO in the CQ Phone Contest and racked up 2,000 contacts in a short operating session.

More pulse-type interference was heard on 20 meters in early November and continued intermittently for a month or so. While it was not as bothersome as the "woodpecker," we note that its source was reported to be the US government in the form of the US Air Force. Senator Goldwater K7UGA entered a note about the USSR woodpecker in the Congressional Record.

The 1S1DX Spratly expedition is still in the red; they have photographs of Amboyna Cay, from which the operation took place, available for \$3.00 (3.5" x 5") and \$10.00 (8" x 10"). Proceeds will go to the fund set up for the expedition. Orders to Bob Schenck N2OO, 212 Oak Leaf Drive, Tuckerton NJ 08087.

The US personnel on Diego Garcia Island ("Chagos" on your Countries List) have a new club callsign, VQ9CI, which made its

debut during November.

N4HX/TT8 came on from Chad in mid-November and expects to be there for some time. "Bull" is active almost exclusively on SSB on the higher bands, although some operation on 40 and 80 meters is promised during contests. QSL to ON5NT, not the *Callbook* address, but rather Ghislain Penny, Box 5, Aalter, Belgium.

ON4LS appeared aboard ship off the Somalian coast, signing 6O4LS and claiming to be anchored at the shore. No word as we write on DXCC status, but the heavy betting is that it won't count until he sets foot on shore.

Jim Smith P29JS traveled in the Pacific and operated from the Solomons (H44) and Nauru (C21); he has been mentioned as one of the possible operators on a rumored upcoming operation from Heard Island.

TN8AJ, who opened up from the Congo in October, says he has become an avid DXer and is looking for new countries; after the initial shock of QSO demands, he has settled down and tries to work the pile-ups as best he can. He did not have a DM license when he left East Germany, so he is, in fact, a Novice. Two new Congolese licenses, TN8AH and TN8BF, both await equipment. An operation proposed for early December from both TN and TL by KA1BQ, KA1BOH, and I8MPO may have reduced the demand for the "Terrible Ts."

The *National Contest Journal* "has been reorganized. A board of directors has been formed to manage the business and publicity activities of the *NCJ*, in hopes of making the magazine a more viable and timely publication. The Board members are W2GD, K5RC, N6SF, and K0TO (a former editor of *NCJ*). The new editor is Randy Thompson K5ZD... There is an issue in distribution and another issue will be printed in late December with all the high-claimed scores of the fall contests. The December issue will be the first under the new management and will be mailed to all subscribers and all former subscribers. A new PO Box will also be announced, along with subscription infor-

mation." The *NCJ* has been published more-or-less regularly, six times per year, over the past half decade; it is must reading for serious contesters and has DX information relating specifically to DX contests.

S2BTF showed almost nightly from Bangladesh, on the W7PHO "Family Hour" gathering on 21340; a list is taken at 0045 with two stations from each US call area making the list each night. Occasionally, S2BTF could be found answering CQs a half hour or so before his official appearance on the "net."

4N0MP was a special call from Yugoslavia, honoring the 125th anniversary of the birth of Michael Pupin, a Yugoslav/American inventor who taught at Princeton University for many years.

K7ZCW/3C1 showed up on 20 meters in late November for a brief operating stint; October's 3C1AA extravaganza had cleaned up much of the demand for Equatorial Guinea QSOs.

VE3HRS/TZ continues his on-again, off-again, activities from Mali; he is not particularly interested in working pile-ups, as much as DXers would like. Harassment will drive him from the bands, as it has others over the years.

If EI8H had actually been in all the places the bootleggers have had him the past year or two, he would have made DXCC in person. There was a reason why he was picked on, and many have wondered why so many of amateur radio's unofficial policemen made life difficult for him. The following report appeared in the September, 1979, issue of *Break-In*, the Official Journal of the New Zealand Association of Radio Transmitters:

"EI8H—This station, one of the biggest sources of QRM to DX for years, has been silenced. The operator, an aging Patrick, has finally been tricked into being caught for his blatantly stupid action on the bands. His consistent jamming, bugging, and illicit operation have resulted in him losing his EI8H call. It all came about after Patrick bugged so many DX nets with his high power signals. If one had worked in or listened in on any DX net, it would be found that sooner or later he would show up. He created chaos by placing a carrier on the net frequency; on many occasions, it

was associated with music, bells, chiming, or buzzsaw noises which completely disrupted the operation. European stations could not work weak Pacific or other DX because of the bedlam. He certainly achieved his goal. On another operation, his call would appear with EI8H/A, GT, GJ, HB0, and many other areas. All of which cost DX dollars, IRCs, and postage for no end result. His operation was also linked with many other bogus calls as well.

"His downfall came about on August 1st, when P29JS and several European operators put their plan to the test. They gave advance notice about a special station which was to show up on the P29JS (Jim Smith) Net. SM5BBC made arrangements at the European end with the EI Post Office officials to be ready. Tracking stations in South West England, CT2, and SM soon confirmed their suspicions.

"Patrick duly came on as they expected and the Post Office officials swooped in, catching him red-handed. His license was cancelled, but they could not confiscate his station. If he were to operate again without a license, the officials could then take all of his station away.

"The person largely responsible for the closing down of EI8H has been SM5BBC, who has brought diplomatic pressure to bear on the EI Post Office to do something about the mess being created by EI8H's actions.

"SM5BBC is to be commended for his action which has nearly made him bankrupt. Financial remuneration is recommended to ZLs. If you can spare a dollar or IRCs, I suggest you send it; it will give confidence to those who are prepared to fight for the clearing of our DX bands of unwarranted, selfish operators who mean to cause hardship to amateur radio."

We couldn't have said it better. The above was written by Arthur Law ZL2HE, one of New Zealand's most active DXers and editor of *Break-In's* "DXing" column.

The information for this column, with the exception of the above excerpt, was from *The DX Bulletin* out of Vernon CT. Please support the DX bulletin of your choice by sending information when you have it. Better yet, send it to *all* the bulletins, plus, of course, to 73 for inclusion in this column.

Looking West

from page 18

arrangements were made over the amateur radio circuit for the pilot (Bob Morefield WA6FTN) to fly down at dawn, pick up Martinez, and fly him to the hospital in Ensenada, 700 miles to the north. During the rescue of Jesus Martinez, his mother and family were kept fully informed by Chuck Reiter WA6IWS and John Sidler WA6OZF, who were translating in Spanish at Ensenada net control.

"Once again, amateur radio operators proved that they could provide effective emergency communications across difficult terrain and distances."

LINKING DEPARTMENT (CONT.)

Let me say a few words about

Bob Couger W6KPS, a human dynamo.

Bob is a person who believes that cooperation with others is the key to accomplishing his objectives. For example, a few years ago Bob pulled off what I consider an amazing feat. He placed into operation an open 146.34/.94 repeater, complete with autopatch facilities, and did so with the blessings of the remote-base owners who had been opposed to such a system until that time. How did he do it? He worked *with* the amateur community, rather than as an independent entity trying to conquer the world. It took quite a few years for him to reach his goal of setting up an open .34/.94 repeater in his area, but when it did go into operation, it was welcomed by everyone — including the remote owners who

had originally been opposed to its establishment.

The latest venture that Bob is involved in is another "cooperative" open interlinked system between his own repeater, the WR6AFR Juniper Hills-Lancaster system and the WR6ACE system. At the WR6AFR site, Kitt Clover (the system's owner) has installed equipment that permits accessing other open repeaters as far away as Las Vegas, Nevada.

Bob explains the operation this way: "To operate this radio system, all that is necessary is to think of it as a string of dominoes. For example, if you are in Santa Maria, California, and want to talk to Las Vegas, you first dial your two-meter radio to the W6KPS/RPT repeater on 147.81/.21. You then enter a touchtone code that links you to WR6ACE, followed by another code that activates the link to WR6AFR. Entering yet another code turns the WR6AFR equip-

ment to .28/.88 transceive and you have thereby gained access to the Las Vegas .28/.88 repeater. By sending the codes in reverse order, the link is terminated."

Bob stresses two important factors. First, that users of the interlink should identify themselves both before and after sending any control codes. Second, they should always remember that courtesy while operating is of paramount importance. To again quote Bob: "We are only guests on these other systems and do not own them."

Will this system ever be extended into Los Angeles and further south? I doubt it — unless the problems with jamming we have here can be dealt with and a semblance of order restored to LA two-meter operation.

More information about this interlinked system and its operation can be obtained by sending an SASE to Bob Couger W6KPS, 1095 McCoy Lane, Santa Maria CA 93454.

Microcomputer Interfacing

from page 32

so the divisor is added to the result of the subtraction by the ADDB instruction. The A register now contains the original partial dividend.

When the 8080 executes the instructions at NOADD, it must

enter a logic zero or logic one into the quotient. Therefore, the state of the carry is complemented by the CMC instruction and then saved in the H register. If the subtraction did not generate a borrow, then the carry is a logic zero, but a logic one must be entered in the quo-

tient. If a borrow was generated, the carry is a logic one. This means that a logic zero must be entered into the quotient. The CMC instruction complements the state of the carry to the state needed in the program. Finally, the content of the L register is decremented by the DCRL instruction. If more bits within the dividend must be tested, the 8080 jumps back to NXTBIT; otherwise, it returns from the subroutine with the quotient in the H register and the remainder in the C register.

There are a number of *software tricks* that can be used to simplify these two mathematical subroutines. However, unless your microcomputer can execute multiply and divide instructions or has special *multiply/divide hardware*, multiplication and division operations will have to be performed using these or similar algorithms.



W2NSD/1 NEVER SAY DIE

editorial by Wayne Green

from page 14

er, but which for some reason never was used.

From the lab, we were taken to dinner at a special chicken restaurant (no, not Colonel Sanders, though there are a number of them around Tokyo). The dinner started with raw chicken, served the same as they do raw fish, with a tare

sauce. It was delicious. From there, we went through a series of chicken dishes . . . it seemed like dozens . . . until I wasn't sure I would be able to get up. Have I mentioned that you sit on the floor in most Japanese restaurants? It was a wonderful meal and I hope to have another chance at one next year.

The world is full of very good food if you are game to try.

Some people can't even try these things and find out whether they are good or not. Some things don't taste good to me . . . some being an acquired taste . . . like beer. Some things are fine in the right setting. I am not much of a tea drinker, yet I do enjoy the Chinese green tea served in a glass, or even the most British of tea served with biscuits for afternoon tea. I can almost get into liking beer when I'm in a German beer hall, surrounded by people singing and having a good time, drinking beer by the liter.

The next afternoon, we stepped off the Pan Am plane in hot, humid Guam. I'd visited there for a few hours in 1959, but had not had a chance to see

much on that trip. The trip before that was when my submarine, the *Drum*, pulled into Apra Harbor on Guam on January 17, 1945, after our 12th war patrol. We'd been patrolling around Okinawa and had had some very close calls during that patrol run. We'd been depth-charged enough so the Japanese had reported us sunk . . . news which went out on the radio in the U.S., but which fortunately my folks had missed.

When we cruised into Guam, the fellows on the other submarines in for refit and refueling were amazed. The Navy was amazed, too . . . they didn't even have our mail there for us, which made our Christmas presents even later . . . we got most of

them in February, which was tough on the cakes and cookies. The fruit cakes survived, but who cared?

As soon as the arrival orgy of eating fresh fruit, tomatoes, and ice cream was over, we packed our seabags and headed for Camp Dealey, a rest camp over near Talofofu village. We had two weeks of "rest" there. The rest consisted of distilling as much torpedo alcohol as possible in a converted coffee urn and mixing it with canned grapefruit juice. It got awfully drunk at times.

The crew quickly found other potables than their "gilly" (torpedo alcohol). The Guamanians had a pleasant-tasting lethal drink made from palm sap. They would cut off the top of a coconut palm, collect the sap, and distill it . . . lightning.

Bill Davis K7IRC/KH2 met us at the airport and drove us to the Guam Hilton. Guam has grown up. That almost completely devastated town of Agana in 1945 now looks more like the outskirts of Phoenix, with some tall buildings and a lot of stores and industries. The thatched huts are now ranch-style houses.

We had just time to unpack a few clothes and then get to a nearby hotel for a dinner with the hams and computer hobbyists of Guam. 114 of them turned out, with their wives, and we had a real fun dinner. After the meal, I talked everyone to sleep alternately on amateur radio and computers. I mentioned that I wanted to get a couple dozen hams to come on the tour next year and their enthusiasm was high . . . be sure to bring HTs to use the local repeater and be prepared to pair off with local hams to get in some rare DXing.

The next morning we were driven all over the island, including a try at finding old Camp Dealey. The camp was completely gone, remembered only by a gas station with the name on it. There are a few houses where the camp used to be and a whole lot of jungle. I talked over old times with some of the people in Talofofu, which used to consist of a few dozen grass huts and now looks like a small town in California.

The next stop was for a couple hours in Hawaii. I quickly got on the local repeaters and was called by Katashi Nose KH6IJ, a

very old friend. He sounded surprisingly well and was obviously enjoying being able to get back on the air after his illness. He is still writing his column for the *Honolulu Advertiser* . . . it's been a fixture of the paper for many years.

That evening we arrived in San Francisco and an overnight rest before continuing to Boston and Peterborough. Sako had presented me with his latest HT, the 207, and I finally had an opportunity to get it charged up so I could try it out. I had a ball scanning all of the channels with it . . . imagine a scanner built into an HT! But for some reason I couldn't get it to transmit above 145.99 MHz. Hmmm, it can't be a Japanese model, because it has the 600-kHz split for repeaters, and it isn't an American model . . . what went wrong? I checked with Yaesu in California after getting back and found that it was a European model. They will send me an American model as soon as they get a new batch. I can hardly wait . . . the rig looks fantastic.

For some reason, I had no problem adjusting to the twelve hours of time difference when we arrived in Asia, but after getting back, I found myself struggling not to have six-hour afternoon naps and one-hour nightly naps. It took a couple of weeks before I was really back to normal.

The trip was more fun than I can ever describe . . . and I hope some of you readers will be able to make three weeks available next October and come along for some hamfests, a lot of Chinese food, and a wonderful time.

GOVERNMENT AT IT AGAIN

A newspaper clipping sent in by WB2EQG was so preposterous that I had to read it twice to be sure that it wasn't a joke in poor taste.

It seems that our government has such a desperate need to spend more and more money that they are now asking for recommendations on mandatory safety standards to prevent CBers from electrocuting themselves by leaning towers against power lines. This is being done by the U.S. Product Safety Commission, 1111 18th Street NW, Washington DC 20207.

Granted that some CBers managed to electrocute them-

selves . . . and possibly a few hams, though I have yet to get word of a ham fried this way . . . is this any reason to insulate the power lines? Or to force tower manufacturers to insulate them? Common sense has to be counted on somewhere. This, claims the bureau, is now the single largest cause of electrocution in our country. I don't believe it.

If this is a problem, it needs to be made more of in magazine articles. But with the continuing drop in CB . . . particularly in DXing, which was big a few years ago . . . I suspect that the tower biz for CBers is way down.

Again, if it is a problem, every CBer has to buy his tower from a dealer . . . so make sure that dealers remind the customers that such a danger is a real one. Ham dealers reading this: Be sure to mention this when a ham buys a tower . . . or anyone else . . . even a CBer.

In the meanwhile, Washington is going to move ahead on this serious problem and come up, at great expense, with a target deadline for the proposed standard set for April 30, 1981. Can't anyone stop this crap?

ON THE RADAR FRONT

Preliminary tests of the latest Radio Shack Micronta (\$200) show it to be as good or even perhaps a tad more sensitive than any of the other detectors I've tested . . . and that's getting to be quite a bunch by now. I have it in parallel with the Fox in our RX7 and it is nip and tuck between the two. One thing is for sure: With this detector, your chances of getting clocked by a radar unit without knowing it are nil.

For those of you who are sanctimoniously mumbling that speeders ought to be caught anyway and that radar detectors should be outlawed, let me give you a piece of information: The estimates of speeding tickets given in error run as high as 30%, according to testimony in courts. That means that some percentage of perfectly innocent motorists who were driving under the posted speed limit were read inaccurately by a patrolman and given tickets. More and more non-speeders are seeing the light and arming themselves with detectors so they will know before getting into radar reading range and thus can lower their speed substan-

tially below the posted limit.

For those readers who have managed to get a ticket, either through the 30% mischance mentioned, or even by operating your rig near a radar unit and thus giving it a false speed reading, you'll want to get a kit from Electrolert to help you fight the case. You may be able to find *The Ticket Book* in a local bookstore (\$6.95) . . . if not, Electrolert has 'em available. But their \$30 kit is a very big book . . . 1 3/4" thick and packed with information which will help your lawyer . . . or you, if you want to try the case yourself. There is a very complete deposition guide, plus detailed technical data on every radar unit . . . and data on many court cases which have been won. With lawyers running around \$50 to \$75 per hour, you really want this bundle of data. Electrolert, Inc., 4949 South 25A, Troy, Ohio 45373.

This same firm has just announced a new detector which they claim is as sensitive as the famed Escort. I haven't gotten delivery on our Escort as yet, though we've had one on order for several months. It's due in soon. Then, if I can get one of the new Fuzzbuster elite, I'll have a chance to see how they compare. We have plenty of radar in New Hampshire. It's the moving-car type, which has the very worst reputation for accuracy and falsing.

Of the units I've tested, I've found the \$100 Micronta Road Patrol to be fairly good. It does false a bit more than I like, causing momentary panic. The \$200 Micronta falses now and then, too, which is a common problem. The Fox is a very small unit and can be had with a remote control so it is invisible to the world . . . which is nice. Why aggravate the bears? It has not yet given a false alarm.

I've had nothing but miseries with the Whistler. The Fuzzbuster II works quite well . . . as does the Bearfinder. Both the Snooper and Super Snooper false so much that I just ignore them. The Centurion rarely speaks up until we are going by the radar unit, far too late for anything useful. One of the better units tested was the Long Ranger. Someone swiped it from my car and I haven't seen them advertised again, so I've lost track of the firm making them.

Other than as a very good

money-maker for towns, police radar serves little useful purpose. Most of the radar units are poorly designed and built, and those that are good cost so much that the police won't buy them. The units, even the best of them, require a lot of training of the officers... which also rarely happens. So you have a poor unit in the hands of an untrained officer... and you're the pigeon.

NONPROFIT

One of the reasons names are being changed on familiar things, such as "maintenance engineer" instead of "janitor," is that this also changes the way we feel about these things. Some recent letters from readers indicate that because *73 Magazine* is not a nonprofit organization, it must therefore be a profit organization. I don't think anyone with any familiarity with the magazine would describe it that way. The real case could be better described as a non-nonprofit organization.

The socialist and fascist camps preach that making a profit is a bad thing and making

a larger profit is obscene (which I always thought had something to do with sex). I don't have anything against profits or even obscene profits, it's just that I have never been much oriented in that direction. I do have a thing about trying to break even... a little passion which developed when I got behind and had the aggravation of putting off creditors. That's a real bummer.

I don't really understand this whole business of nonprofit corporations. I belong to one nonprofit club which keeps from making a profit by paying delightful salaries to its top officers... and which has salted away close to two million dollars in cash and securities. I suspect that if I tried something like that with my non-nonprofit corporation, I would soon be hanging by the thumbs in court.

Most corporations have a bunch of stockholders who are forever pushing for profits... which are then (after taxes) distributed as dividends. Back when I started *73*, I had in mind going public and thus permitting the readers to share in the

ownership of the magazine. But, as I looked into it, I found that this would put the pressure on for "performance" of the stock... the need for profits, which could then be shared. I felt it was better to share any projected profits in the form of a larger magazine. And why not spend any possible profits on payments for articles, making it so the hams with the drive to write, and thus benefit all of us, would benefit?

I started *73*, not as a way to make a lot of money, but as a way to publish a magazine which would be enjoyed by hams and would encourage them to build equipment and try new ideas. I think my goal has been accomplished.

Aha, but what about starting new magazines? Certainly that takes a big investment from somewhere? Oddly enough... and please don't let this get out... once you know what you are doing, you can start a new magazine for virtually nothing. I've done it several times recently. The only investment needed to get *Kilobaud MICROCOMPUTING* started was a \$10 post-

er at a computer show. The 1,000 subscriptions sold paid for further subscription mailings and putting together the first issue. The ad revenue from the first issue paid for the printing and mailing of the magazine... and it was just a question of pulling on the bootstraps to build it up.

Unlike a nonprofit organization, *73* does not have one share of stock invested in securities. Nor are there any six-figure bank accounts kicking around. We still invest any probable profits in a bigger magazine and payments to authors. It will probably continue that way as long as I last.

OCTOBER WINNER

As much as we hate to, this month we will actually be giving money to one of our advertisers. Frank Kalmus WA7SPR, president of RF Power Labs, Inc., had the audacity to write "Easy-to-Build 220 Transverter," which our readers sagaciously voted October's best article, so we are forced to send him a \$100 bonus check. Save us the the embarrassment, Frank: Hold the articles!

Contests

from page 30

March 8th to: SC QSO Party, Elliott Farrell, Jr. WA4YUU, PO Box 994, Walterboro SC 29488. Include an SASE with your entry for a copy of the contest results.

NEW HAMPSHIRE QSO PARTY
Operating Periods:
2000 GMT February 2 to 0500 GMT February 3
1400 GMT February 3 to 0200 GMT February 4

This year's contest will be sponsored by the Nashua ARC to promote the Worked New Hampshire Award. Stations may be worked once per band per mode. NH stations may work each other.

FREQUENCIES:

Novice - 3730, 7130, 21130, 28130.

CW - 1810, 3555, 7055, 14055, 21055, 28130.

Phone - 1820, 3935, 3975, 7235, 14280, 21380, 28575.

VHF - 50.115 and 145.015 FM simplex.

Suggested times - phone on

the hour, CW at 30 minutes past. No CW QSOs allowed in the phone band.

EXCHANGE:

NH stations send RS(T) and county. Others work NH only and send RS(T) and ARRL section or country.

SCORING:

Score 1 point per QSO. NH stations multiply QSO points by the number of NH counties plus ARRL sections and countries. Others multiply by the number of NH counties.

AWARDS:

NH club competition awards will be certificates signed by the governor of NH with a trophy for the winning NH club. Mark your summary sheet with the club's name for any club entries. Other certificates and the Worked NH Award will be issued.

ENTRIES:

Mailing deadline for entries is March 16th. Send your entry with a large SASE for results and/or awards to: NARC, R. Lint, 10 Hartwood Drive, Merrimack NH 03054.

ANNUAL QCWA QSO PARTY CW

Starts: 0001 GMT February 9
Ends: 2400 GMT February 10

Phone

Starts: 0001 GMT March 8
Ends: 2400 GMT March 9

Each contact made with another QCWA member will count as a single point. Contacts with the same station on more than one band can be scored only once. Contacts made with captive stations, such as when operating in local nets, are not valid. Remember this is a QSO party and not a contest. There will be no multipliers. All contacts are equal. The total number of contacts with QCWA members, wherever they may be, is your score. The QCWA certificates which you can earn are your "bonus." Put the activities manager to work with your request for certificates you were able to earn during the QSO Party.

FREQUENCIES:

Any authorized amateur frequency is permissible. The following suggested frequencies have been selected to minimize interference to others: Phone - 3900-3930, 7230-7260, 14280-14310, 21350-21380,

28600-28630; CW - 3530-3560, 7030-7060, 14030-14060, 21040-21070, 28040-28070.

EXCHANGES:

A valid QSO must contain the following minimum information exchange between both parties: QSO number, operator's name, chapter identification (official number or name). Members not affiliated with a chapter may use "AL" to so identify.

ENTRIES:

It is the responsibility of each contestant to provide a legible log, no carbon copies, and to list all claimed contacts. The total contacts for each page will be recorded at the bottom of each page in an appropriate place. The total contacts for the party should be recorded on the top-right of the first page of the log. Include your name, address, call, QCWA number, and chapter on each page. Log sheets will not be returned. Make sure you have correct postage when sending in your logs. Send your logs no later than March 31st to: Yankee Chapter, QCWA, Walter Woodward W1RCJ, 14 Emmett Street, Marlboro MA 01752. Separate logs and scores must be submitted for both the CW and phone parties.

Results

RESULTS OF WASHINGTON STATE QSO PARTY FOR 1979 sponsored by Boeing Employees' Amateur Radio Society (BEARS)

K4ZGB	Alabama	134	29	8,932
AI70	Alaska	3	4	36
W7ZMD	Arizona	86	26	6,032
N6PE	California	78	23	4,761
K0KV	Colorado	29	14	1,022
W1TEE	Connecticut	42	16	1,904
W4KFA	Florida	18	9	324
N4NX	Georgia	137	32	10,496
K7TAK	Idaho	5	4	60
W9QWM	Illinois	19	12	600
K0TJB	Kansas	24	14	672
WA4QMQ	Kentucky	40	14	1,218
W5WG	Louisiana	89	24	5,664
W1DLC	Maine	37	15	1,455
K3KX	Maryland	11	7	147
WB1ANT	Massachusetts	10	7	147
WD8QBB	Michigan	26	11	605
WB0LNO	Minnesota	27	11	594
W7RIR/0	Nebraska	35	16	1,376
KA1EP	New Hampshire	15	10	300
WA2DFC	New Jersey	18	12	564
WB2NDE	New York	66	20	2,640
K4YFH	North Carolina	15	9	387
WA2DJM/0	North Dakota	1	1	2
N8FU	Ohio	24	11	572
K7DRD	Oregon	17	9	441
WA3ISG	Pennsylvania	20	11	440

WA4YUU	South Carolina	20	10	440
WA0BZD	South Dakota	42	16	1,472
WA4CMS	Tennessee	19	10	530
W5NR	Texas	25	14	1,050
W4KMS	Virginia	30	15	1,155
K8KVX	West Virginia	19	12	456
W9YT (WB9PYE opr.)	Wisconsin	17	11	462
VE3CEF	Ontario, Canada	77	20	3,920
PY1BOL	Brazil	2	2	8
JA7KE	Japan	33	13	1,072
WASHINGTON				
N7RC	Chelan	35	21	2,205
*VE7ZZ/W7	Clark	533	76	98,040
WA7PMW	Cowlitz	448	53	47,488
W7WMO	Grant	221	43	27,391
AI7J	Island	870	70	124,950
K7UR	King	129	43	13,330
W7IIT	Kitsap	50	20	4,350
WA7FMT	Kittitas	68	30	6,120
W7BUN	Pierce	787	61	96,197
K7EQ	San Juan	112	32	9,504
WA7JUJ	Skagit	406	58	47,720
*VE7ZZ/W7	Skamania	533	76	98,040
N7ABA	Snohomish	359	45	32,355
W7RVQ	Spokane	76	30	4,560
N7RV	Thurston	97	39	11,349
WA7LOQ	Walla Walla	140	36	10,080
WB7CAO	Whatcom	1,513	63	190,764

*Operated from Clark/Skamania county line.
Numbers after calls are: QSOs, multipliers, and total score.

**ARRL INTERNATIONAL DX
CONTEST
CW
February 16-17
Phone
March 1-2**

A number of significant

changes have been made to this year's rules for the DX contests. The new rules are as follows, as received in an advance copy from the ARRL.

The contest is open to all amateurs worldwide. The object

is for amateurs worldwide to work as many amateur stations in as many DXCC countries of the world as possible using the frequency bands of 1.8 to 30 MHz. The contest periods are as shown above, starting at 0000

GMT on Saturday and ending at 2400 GMT on Sunday on the dates shown.

CATEGORIES:

Single operator — one person performs all operating and logging functions. Use of spotting

nets is not permitted. Single-operator categories are further classified as allband or single-band (one only) entries. It is recommended that single-band entrants who make contacts on other bands submit logs for checking purposes for the other bands.

Multi-operator—more than one person operates, checks for duplicates, keeps the log, etc. Multi-operator categories are further classified as single-transmitter or multi-transmitter. For single-transmitter, only one transmitter on any one band during the same time period is permitted. Stations must remain on a band for 10 minutes once a contact is made on that band, with one exception. One other band may be used during the 10-minute period if the stations worked are new multipliers only. Multi-transmitter has no limits other than only one signal per band.

QRP—single-operator stations with 10 Watts input or less.

EXCHANGE:

W/VE stations (includes 48 contiguous United States and does not include Canadian islands of St. Paul and Sable) exchange signal report and state or province. DX stations send signal report and power as a three-digit number indicating the approximate transmitter input power. The same station may be worked once per band. Crossmode, crossband, and repeater contacts will not count for contest credit. Incomplete

contacts (includes callsign and exchange) do not count for points or multipliers. Aeronautical and maritime mobile stations may be worked for QSO credit only.

SCORING:

Contacts with your own country count for multiplier credit only. W/VE stations count three points per DX QSO. DX stations earn three points per W/VE QSO and two points per other DX QSO. The DXCC countries worked on each band count as multipliers. Multiply QSO points by the sum of multipliers per each band.

CLUB COMPETITION:

ARRL-affiliated clubs compete for gavels on three levels: unlimited, medium, and local clubs. Details can be found in the January *QST*.

AWARDS:

Plaques and certificates will be awarded in various classes; see *QST* for the complete list. DX entries making over 1000 QSOs receive certificates.

ENTRIES:

All entrants are encouraged to use forms available from the ARRL in reporting contest results. Include a large SASE or IRCs and send as early as possible. Logs should indicate times in GMT, bands, calls, and exchanges. Multipliers should be clearly marked in the log the first time worked. Entries with more than 500 QSOs must include cross-check sheets (dupe sheets). All logs must be in chronological order except for

multi-multi entries. All operators of multi-operator stations must be listed. Entries must be post-marked within one month of the last contest weekend. All stations are requested to send their entries as early as possible. Entries received after mid-July may not make *QST* listings. Regular ARRL disqualification rules apply.

VERMONT QSO PARTY **Starts: 2100 GMT Saturday,** **February 23** **Ends: 0100 GMT Monday,** **February 25**

Sponsored by the Central Vermont Amateur Radio Club, everyone is urged and invited to join in the fun. The same station may be worked on different bands and modes for additional QSO points. Vermont mobile stations may be worked considering each new county they enter as a new station.

EXCHANGE:

Vermont stations send QSO number, RS(T), and county. Others send QSO number, RS(T), and ARRL section.

FREQUENCIES:

3685, 7060, 14060, 21060, 28100, 50260, 144-144.5.

3932, 7265, 14290, 21375, 28600, 50360, 145.8.

3909, 7290, 14325.

SCORING:

Out-of-state stations score 3 points per VT station worked and multiply this total by the number of Vermont counties worked on each band. VT sta-

tions score one point per contact and multiply by the number of ARRL sections and countries worked.

AWARDS:

A certificate will be awarded to the highest-scoring station in each ARRL section and foreign country submitting logs. A trophy will be awarded to the highest-scoring station outside of VT. The highest-scoring single-operator station in VT will have his/her name and call engraved on the Doris McGrath memorial plaque. This award, donated by Mrs. Doris McGrath in memory of her husband, W1EQB, will be awarded in this manner for a ten-year period. The operator winning the QSO party the most times, or the station with the highest score during the period, will receive the plaque. A special certificate will be awarded to the 2nd, 3rd, and 4th highest-scoring stations in VT. The W-VT (Worked Vermont) Award will be issued to stations working 13 out of Vermont's 14 counties, provided the station has not previously been issued this award. A special certificate will be awarded Vermont multi-operator stations.

ENTRIES:

Send logs or facsimiles together with an SASE no later than March 31st to: Gerald W. Benedict W1BD, 23 Foster Street, Montpelier VT 05602. Winners of awards will be announced the 3rd Thursday in April at the regular meeting of CVARC.

New Products

from page 34

free copy with poor signal conditions like fading. A rear apron scope jack provides 10 volts p-p at 100k Ohms for critical tuning applications.

The M-200E is designed to work alone for reception, or with a matching Info-Tech keyboard for transmission as well.

Construction

Info-Tech is not a newcomer to the scene of digital communications, and their quality control shows it. Double-sided, plated-through glass epoxy circuit boards are used throughout. All ICs are fitted with sockets. Extensive MOS circuitry reduces

power consumption and keeps heat dissipation low. Tight power-supply regulation further increases reliability.

On the Air

The performance of the M-200E is very impressive. It is obviously designed by engineers who know ham radio requirements as well as commercial standards. We couldn't resist the temptation to connect the M-200E to a general-coverage receiver to see what was going on among the utilities. CW and RTTY reception was a snap. 66 and 100 wpm RTTY signals were copied with no problem. Even when used in conjunction with an inexpensive receiver, the

unit performed flawlessly, so long as the signal was drift-free. The passband of the active audio filters is extremely tight... it has to be... and tolerates little off-frequency input.

We recommend the Info-Tech M-200E to anyone seriously considering digital communications. M-200E tri-mode converter, \$500. Available from *Info-Tech*, 2349 Weldon Parkway, St. Louis MO 63141. Reader Service number I45.

Robert B. Grove
Grove Enterprises, Inc.
Brasstown NC

REVIEWING THE YAESU **FT-207R — AND MORE**

The present overwhelming popularity of 2-meter FM seems to be situated between craze and epidemic proportions throughout the United States

and the world in general. Almost every amateur holding a Technician or higher class license owns at least one 2-meter FM mobile rig, and it appears that an almost equal number of amateurs are beginning to also enjoy the pleasures of 2-meter handie-talkie operations. Judging by the unlimited capabilities of these hand-held portables, one can logically assume that personal portable communications will reach new peaks of success during the 1980s. Likewise, we can expect to see crystallized hand-helds give way to more sophisticated synthesized units of comparable size. That will create an open market for older crystal-controlled units while providing all the advantages of "big rigs" in the newer style hand-held units.

During previous years, I have owned one of almost ever avail-



The Yaesu FT-207R and assorted items used by K4TWJ. Vinyl case was cut from FT-202R item. Klitzing amplifier boosts handie output to 50 Watts. Full-length pull-up antenna significantly extends handie's range. Adapter at left mates PL-259 to BNC. Battery tester described in text placed beside 207. Finally, 207's battery pack is in front of unit. A Yaesu speaker mike and length of coax with PL-259 and BNC were secured in the car and thus omitted from this photo.

able 2-meter FM hand-held unit. Included in this list are Motorolas (the 100 is a gem), Wilson, Drake (TR-22 styles), Standard, Clegg, Tempo, and the Yaesu FT-202R. I recently purchased a new Yaesu FT-207R microprocessor-controlled, frequency-synthesized handie, however, and the results have created a whole new ball game of 2-meter fun.

The 207 is an 800-channel hand-held unit which is exactly the same size as the 202, except its upperfront section (speaker grill/mike area) is approximately 1/2 inch thicker. Since this extra size is placed in the handie's top front, it is practically unnoticeable. The unit fits my small hand exactly like a 202; the speaker/mike section doesn't interfere with handling or carrying. Rather than using a handful of penlight batteries, the 207 employs a 10.8-volt battery pack similar to that used in the Wilson units. The handie is well balanced and bears a striking resemblance to Motorola units. Audio quality is similar to the Standard: clean and natural.

Operation

Using a 207 is similar to operating a Yaesu CPU-2500 or Kenwood 7600 (complete with microprocessor unit) right from your hand. The last 3 digits of a frequency are entered on the touchpad and the red ENT/DIL bar is depressed. This frequency is LED-displayed in the area ad-

acent to the mike. The display automatically shuts off after 2 or 3 seconds unless the DISP switch is on, but the selected frequency is maintained. This frequency (or any other frequency appearing in the readout) can be placed in memory by depressing a number, 1 through 4 (memory address), and M. The other 3 memories can be loaded in a similar manner, and a 5th frequency can be programmed by stopping the previous procedure at the ENT/DIL bar depression. A selected memory can be recalled by depressing its address and MR, or the unit can be stepped through its memories with MR and UP or DWN. The memories can be automatically scanned by holding UP or DWN for two steps (approximately one second). A miniature slide switch on top of the handie determines if the scan stops on a clear or busy frequency or straight scans, letting you hear all the action at once (great for watching drive-time activity build). The scanning function may be manually canceled when desired by depressing UP or DWN or by squeezing the push-to-talk once. Subsequent use of the push-to-talk activates the transmitter as usual. Complete tuning of the 2-meter band is accomplished by selecting a bottom or top limit, if desired, and/or depressing ENT/DIL and UP or DWN once for each 10-kHz step. Holding UP or DWN for 2 steps

(approximately 1 second) moves the handie into scan mode. Again, the scan is similar to that previously described and UP, DWN, or push-to-talk cancels the function. There are also 3 or 4 other ways of programming and using the handie, but that's the general concept. Incidentally, the LED readout is illuminated during scanning. If the DISP switch is off, the readout shuts off 1 second after scanning stops. The rig also holds that particular frequency until the UP or DWN button reactivates scanning.

The priority mode functions are as follows: Assume you want to listen or become involved in a conversation on, for example, .16/.76, and you want to monitor, say, .52 for a call. Let's further assume that .52 is programmed in memory 1. Press 676 and ENT. The rig is now on .76 and that frequency is displayed. Next, press 1 and MR. The rig switches to .52 and that frequency is displayed as 6.521, meaning memory 1 recalled. Now press # and the priority is enabled. If the DISP is on, the readout shows 6.76 P again. This cycle will continue until a call is received on .52. The rig will then halt on .52. The priority can be reinitiated by pressing #, if desired. The clear, manual, busy switch can also be used with priority functions.

If you make a mistake when punching frequencies on the

handie, the display lights E. Punching the CE button clears your bungle and you can start again. The SET button is used for programming oddball splits. During transmit only, the keyboard becomes a touchtone™ pad. The LOCK switch disables the keyboard to prevent butterfingering amateurs from accidentally changing frequencies when handling the rig. A small switch on the handie's bottom selects 250-mW or 3-Watt rf power levels, and an external earphone jack is mounted on top of the rig. An earphone is included on the transmitter offset switch for maintaining or removing power on the unit's memory when the main switch is OFF (backup OFF position). A removable belt clip is mounted on the handie's back. I'm sure the kitchen sink is also in there somewhere, but I haven't yet found it.

Personal Evaluation

Personally, I was sold on the 207 from the time I saw its first advertisement. It's small enough to fit in a coat pocket (its weight, however, gives people the illusion that you're carrying a .38). The LED display is great, since I seem to either be in an indirectly-illuminated room or outside at night when using the handie. The channel-busy LED can be noticed at a glance from across a large room, and that's quite convenient. The selectable power levels (250 mW or 3 W out-

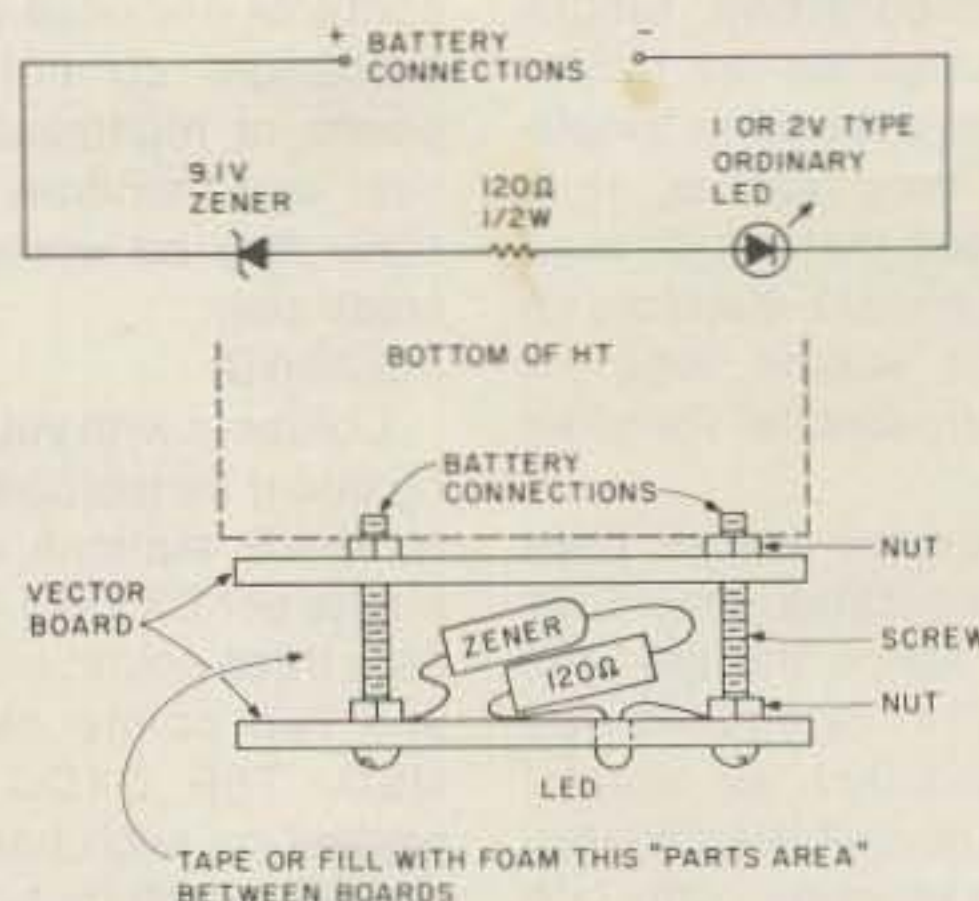

Fig. 1. HT battery monitor as described in text.

Conditions	Total Current
Receiver on, squelched, readout Off	38 mA
Receiver on, signal present, readout Off	70 mA
Receiver on, signal present, readout on LED readout	77 mA
Frequency memory	7 mA
Transmitter on, low power	2 mA
Transmitter on, high power	255 mA
	915 mA

Table 1. Current drains of FT-207R.

put) have been enough reason in themselves for many amateurs to select a 207. Make no mistake: 250 milliwatts is the perfect rf level for using nearby repeaters or driving amplifiers at relaxed, lower levels. The 3 Watts is also beneficial for those "fringe" periods.

One of my main considerations when selecting an HT is microphone and antenna location. Possibly, this is a spin-off from recent propaganda concerning biological effects of rf, but I don't want rf radiating broadside into my eyes. This dictates the HT's mike being located at least midway of the unit rather than at its top, plus the ability to maneuver the antenna behind the ear and toward the back of my head (rig canted when transmitting). The 207 fits this requirement very smoothly.

The 207 uses a 10.8-volt (450 mA) nicad battery pack rather than a handful of rechargeable penlight cells. Thus, if the battery dies while you're in some strange airport, you can't simply purchase dry-cell penlights and continue on your way. On the other hand, an extra nicad battery pack is easily carried and exchanged, provided Yaesu produces more than one per radio. Since the battery situation is a main focal point of 207 discussions, I decided to measure current drains for myself. The results are shown in Table 1. Since I use the 207 on more of an occasional rather than a constant basis, the ability to switch off memory backup voltage is quite beneficial. It takes less than 30 seconds to reload the memories, but if this becomes a hassle, you can simply leave the memory backup on. The cost of memory retention is 2 mA, which theoretically drops a 450-mAh battery to half charge in approximately 115 hours or 4½ days. The receiver in my particular handie pulls substantially less than specified in the Yaesu manual, and the LED readout pulls a mere 7 mA. Thus, there's absolutely no concern about leaving the LEDs on continuously. I usually get between 3 and 5 days occasional use from the battery pack in my 207, which confirms the 207 is not a battery eater. Yaesu failed to discuss battery-charging considerations in the manual, and the 207 doesn't have a meter, so you're on your own. If you try watching the transmit LED, you'll probably be unexpectedly

hit with dead batteries during an important QSO. This irritated me, so I rigged the circuit shown in Fig. 1 for battery monitoring. A discussion of this circuit appears at the end of this article.

I use the 207 either fixed, mobile, or portable while moving around during the day or night, and it has performed flawlessly. The receiver is "hotter" than any HT I've seen (it picks up 2 local repeaters without any antenna!). The transmitter measures 3.1 or .3 Watts (Hi/Lo) output. A Klitzing 3-Watt in/50-Watt out 2-meter amplifier and Yaesu remote speaker-mike round out the fixed/mobile setup. Since I carry the handie with me when leaving the car (and the amplifier is mounted out of sight), the chance of theft is minimized.

207 Battery Monitor

The circuit of Fig. 1 uses a common 9.1-volt zener, 120-Ohm ½-Watt resistor, and a garden-variety LED to accurately indicate the 207's battery-pack condition. The 120-Ohm resistor varies LED brightness to the point that battery-pack voltages between 11 and 10.2 volts produce bright LED illumination. The LED becomes quite dim at 10.1 volts and extinguishes at 10.0 volts. Approximately 30 minutes of use later, battery voltage drops below 10.0 volts, and recharging is required (all voltages measured on transmit: highest power level). This circuit (which costs approximately 45 cents to build) has proven more effective than any HT-installed meter I've seen. Quite simply, it uses the zener's avalanche point to accurately detect the "knee" of the nicads' discharge curve. Other HT nicad supplies could be monitored using a similar circuit. Merely select a zener with a voltage rating near your power supply's "knee" and calibrate the circuit using a variable voltage power supply.

My battery monitor is enclosed between 2 pieces of vectorboard + as shown in Fig. 1. The screws holding this "sandwich" together mate with battery contacts on the rig's bottom. The tester is then merely held in position when needed.

Conclusion

All aspects being considered, I honestly feel the 207 is a great little rig. If I didn't own a handie-talkie, there would be no reservations or time wasted—I would purchase an FT-207R. Once you

become accustomed to handies, you'll truly feel undressed without one.

Yaesu Electronics Corporation, 15954 Downey Ave., Paramount CA 90723; (213)-633-4007. Reader Service number Y1.

Dave Ingram K4TWJ
Birmingham AL

DSI INTRODUCES 50 HZ-500 MHZ POCKET-SIZE LSI DIGITAL FREQUENCY COUNTERS

A new series of hand-held digital frequency measurement instruments that provide all the accuracy and high readout legibility of the full-scale types—yet are not much larger than a 120-millimeter cigarette pack—has been announced by DSI Instruments, Inc., San Diego, California. Two models, the 500HH that has a frequency range of 50 Hz to 500 MHz and the 100HH that has a frequency range of 50 Hz to 100 MHz, are offered.

Their large 8-digit LED display, with characters that measure a full 0.4" high, features automatic decimal point shifting and zero blanking. Total case dimensions (excluding antenna) are only 3.5" wide x 1.25" deep x 5.75" high—about the

same as a typical pocket-size calculator.

They're accurate to within 1.0 ppm (TCXO timebase) over a wide temperature range of +17° C to +40° C. The Model 500HH has a high sensitivity that is typically 30 mV at 100 Hz to 250 MHz and 50 mV at 250 MHz to 450 MHz, while the typical sensitivity of the 100HH is 30 mV at 100 Hz to 50 MHz. What's more, they have pre-scale input resolutions of only 10 Hz in just 0.1 second (or 1.0 Hz in 1.0 second).

They have BNC direct inputs of 1.0 megohm (50 Ohms pre-scaled). Utilizing low-drain LSI circuitry, they operate from a built-in rechargeable 8.2 to 14.5 V dc battery pack or 115 V ac using an external ac adapter that also trickle-charges the battery pack.

Applications cover a broad variety of service, testing, adjustment, and calibration uses where precise performance and high reading legibility across wide frequency range requirements—along with pocket-size convenience—are prime considerations.

Deliveries can be made immediately from local or factory

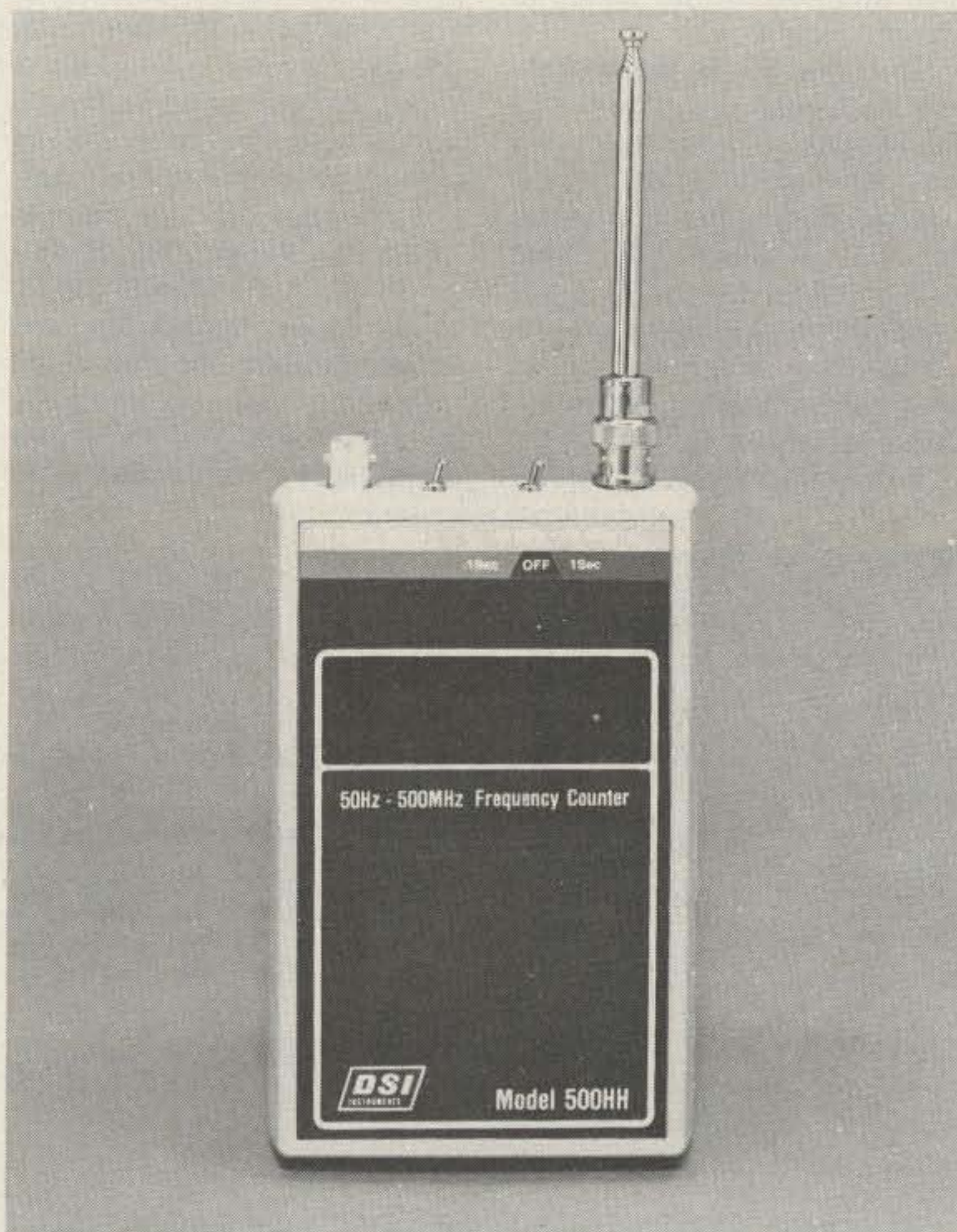

Pocket-size LSI digital frequency counter from DSI.

inventories. All the units are 100% factory pretested before shipment, and they carry a full one-year limited warranty.

For complete technical data, quantity pricing, and local outlet information, contact *DSI Instruments, Inc.*, 7914 Ronson Road, San Diego CA 92111; call toll-free (800)-854-2049, or from California exchanges call collect (714)-565-8402. Reader Service number D25.

HEATH INTRODUCES AMATEUR RADIO RECEIVER AND MATCHING CW TRANSMITTER

Heath Company, the world's largest manufacturer of electronic kits, has announced the availability of a new amateur radio transmitter and matching receiver.

The new HX-1681 CW transmitter combines solid-state technology with vacuum tube finals to give a transmitter said to be capable of 100 Watts minimum output on 80 through 15 meters and 75 Watts out on 10. It features full break-in CW operation (QSK), built-in vfo, solid-state TR switching, side-tone output with adjustable tone and level, and receiver muting. Keying is provided for the addition of an external power amplifier.

The matching solid-state HR-1680 receiver covers the 80- through 10-meter band. It is said to feature a preselector-tuned dual-conversion front end for .05 uV sensitivity. Also featured are solid-state diode bandswitching, built-in 100-kHz calibrator, and switchable wide/narrow active audio circuitry for SSB or CW operation.

Both transmitter and receiver

are offered in kit form and include instruction manuals said to be so complete and concise even a novice builder can complete either project. For more information on these and nearly 400 other electronic kits you can build yourself, write for the latest free Heathkit Catalog at: *Heath Company, Department 350-940, Benton Harbor MI 49022*. Heath is a subsidiary of Zenith Radio Corporation. Reader Service number H5.

FOX-TANGO CRYSTAL FILTERS

Fox-Tango Corporation, sponsor of the 4000-member, eight-year-old International Fox-Tango Club for owners of Yaesu amateur radio equipment, announces the expansion of its quality line of eight-pole crystal filters and related accessories to include not only popular models produced by Yaesu, but also those of Kenwood, Heath, Drake, and Collins.

Noting that most manufacturers of amateur radio equipment were content to supply relatively few filters to supplement the SSB unit supplied as standard equipment, and these as extra cost options of six poles or even less, Fox-Tango decided it was time to offer the worldwide amateur fraternity true "freedom of choice" by making available a variety of filter types and bandwidths never previously obtainable or adaptable to their rigs. For example, for its popular FT-101 line, Yaesu offered only a single 600-Hz bandwidth CW filter for direct installation, and while a 6000-Hz AM filter could be bought, it could be used only by sacrificing the CW filter whose spot it pre-empted. Both

optional Yaesu filters were of six-pole construction. By contrast, for the same set, Fox-Tango now offers 250-, 500-, 600-, 1800-, 2400-, and 6000-Hz bandwidths—all carefully designed and manufactured eight-pole units made up of specially treated Hi-Q high quality quartz crystals. Moreover, to compensate for the lack of space in the original design for more than one optional filter, Fox-Tango offers inexpensive diode switching boards (both single and dual types) for most Yaesu and Kenwood models which permit the addition of up to three filters more than those for which the manufacturer provided room. Thus owners of older models can "update" their sets either by the "drop-in" installation of superior filters to supplant original units or can supplement them by adding selectable bandwidth filtering, often using switches already existing on front panels. All filters are custom-made to perfectly match the sets for which they are designed, both physically and electronically, so installation is a simple matter of tightening two nuts and soldering two connections. Fox-Tango filters are guaranteed on a money-back or replacement basis, as preferred, for one year.

The following filters are currently available for the brands indicated:

Yaesu: FT-101 (to F), FR-101, FT-301, FT-7/B, FT-901/101Z, FT-200, FT-401. Bandwidths: 250, 500, 600, 1800, 2400, 6000 Hz.

Kenwood: TS-520/R-599, TS-820/R-820. Bandwidths: 250, 400, 1800, 2100.

Heath: All but SB104. Bandwidths: 250, 400, 1800, 2100 Hz.

Drake: R-4B/C only. Broad 1st i-f (6- or 8-kHz BW). Narrow 1st i-f (600- or 800-Hz BW) with relays for switching from broad to narrow i-f for CW only. Very sharp 2nd i-f (plugs in) 125 Hz. Product detector kit: converts existing units to superior double-balance type.

Collins: 75S-3B/C. For superior CW. 250-Hz bandwidth.

Since not every bandwidth is available for every listed model, write for detailed specifications to: *Fox-Tango Corporation, Box 15944, West Palm Beach FL 33406; (305)-683-9587*. Reader Service number F24.

MAGNETIZED SIGNS FROM FOTOGRAFIX

Now, any amateur radio club can receive the recognition for public service work it deserves. Fotografix announces the introduction of amateur radio public service signs for emergency and mobile use. The signs are entirely magnetic and are guaranteed safe at highway speeds. They have been wind-tested at above 70 miles per hour. Because the entire sign is made of a flexible magnetic material, it attaches securely to magnetic metallic surfaces without room for air pockets.

The signs are available with "AMATEUR RADIO Emergency Communications Unit" or "AMATEUR RADIO Public Service Volunteer" slogans and can be personalized with club names in quantities of 25 or more sets.

Each sign carries a special logo with radio operator, head-



Heath's HX-1681 transmitter and HR-1680 receiver.



Crystal filter from Fox-Tango Corporation.



Fotografix' magnetic sign.

phones and handie-talkie, and storm cloud in the background. The signs are waterproof and wash easily with mild soap and water. They will not fade, peel, or crack in hot sunlight.

For more information or to order, write to *Fotografix*, PO Box 202, 522 Arizona St., Lawrence KS 66044. Reader Service number F25.

NEW CATALOG FROM HAMTRONICS

Hamtronics, Inc., has announced a new 1980 catalog, which is yours for the asking. The 24-page catalog features many types of kits of interest to the radio amateur or two-way shop. Exciting new products in the catalog include a 435-MHz transmitting converter, a new UHF FM receiver, an AM receiver for aircraft and DX warning, a weather tone alert receiver module, a new low-noise VHF converter, and several new linear power amplifiers for VHF and UHF. These new products follow in the tradition of other fine Hamtronics kits, including their famous VHF and UHF converters and preamps and FM transmitters and receivers.

For your free copy of this informative catalog, call (716)-392-9430 or write *Hamtronics, Inc.*, 65F Moul Rd., Hilton NY 14468. (For overseas airmail delivery, please send 4 IRCs.) Reader Service number H16.

BATTERY-POWERED WIRE-WRAPPING TOOL

The new BW-2630 is a revolutionary battery-powered wire-wrapping tool. The tool operates on 2 standard "C" size nicad

batteries (not included) and accepts either of two specially designed bits. Bit model BT-30 is for wrapping 30 AWG wire onto .025" square pins; BT-2628 wraps 26-28 AWG wire. Both produce the preferred "modified" wrap.

Designed for the serious amateur, BW-2630 even includes both positive indexing and anti-overwrapping mechanisms—features usually found only in industrial tools costing five times as much. Pistol-grip design and rugged ABS construction ensure performance and durability. In stock at local electronic retailers or available directly from *OK Machine and Tool Corporation*, 3455 Conner Street, Bronx NY 10475. Reader Service number O5.

NEW CLOCK KIT FROM BULLET

The new 6-digit mobile/fixed station Zulu clock kit is now available from *Bullet Electronics*. The kit features quality G-10 plated and drilled PC boards, detailed step-by-step instructions with illustrations and schematics, and all the required parts.

The kit nomenclature will be ZULU II and has as standard features large 1/2" character LED readouts, a quartz crystal timebase, battery backup, 12 V dc operation, readout blanking and brightness control, noise rejection circuitry, and a calendar-on-demand feature.

The ZULU II will be sold either without a case or with an attractive injection molded case in either blue or beige. The addi-

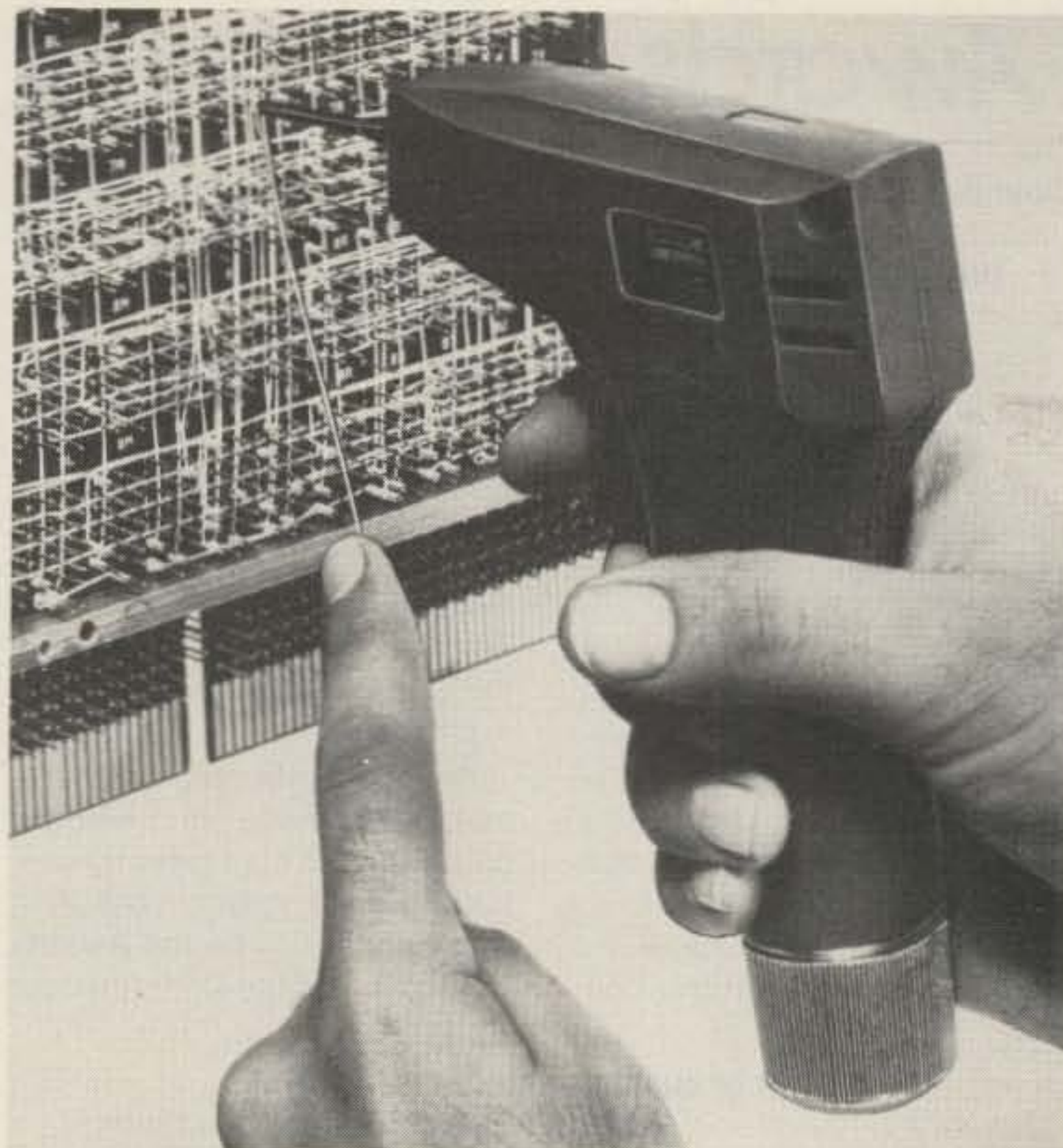

BW-2630 wrapping tool from OK Tool.

tion of a small 12 V ac transformer allows standard ac operation. The kit is aimed at the amateur radio market and is the result of numerous customer requests for a clock of this design.

For more information, contact *Bullet Electronics*, PO Box 401244-E, Garland TX 75040; (214)-278-3553. Reader Service number B8.

MULTI-FREQUENCY ENCODER

Selectone Corporation announces a versatile new multi-frequency encoder for both CTCSS and burst tone signaling applications. The miniature circuit board measures only 1" W x 2.85" L x .38" H and will accommodate up to eight (8) fully tunable tone frequencies. If fewer frequencies are required, the board may be sheared off to reduce the overall length.

Two standard configurations are available: the Model ST-105 CTCSS encoder and the Model ST-115 burst tone encoder. The ST-105 operates over the standard CTCSS frequency range of 67.0 to 250.3 Hz, while the ST-115 will generate burst tones with the range of 800 to 3000 Hz with field selectable burst durations of 300 ms, 500 ms, 1 second, or continuous. Other frequency ranges are available on special order.

The ST-105 and the ST-115 are furnished with complete installation instructions and 18" flying leads for wiring to a multi-frequency selector switch (customer provided).

For more information, contact *Selectone Corporation*, 26203 Production Ave., Suite 6, Hayward CA 94545; (415)-887-1950. Reader Service number S110.

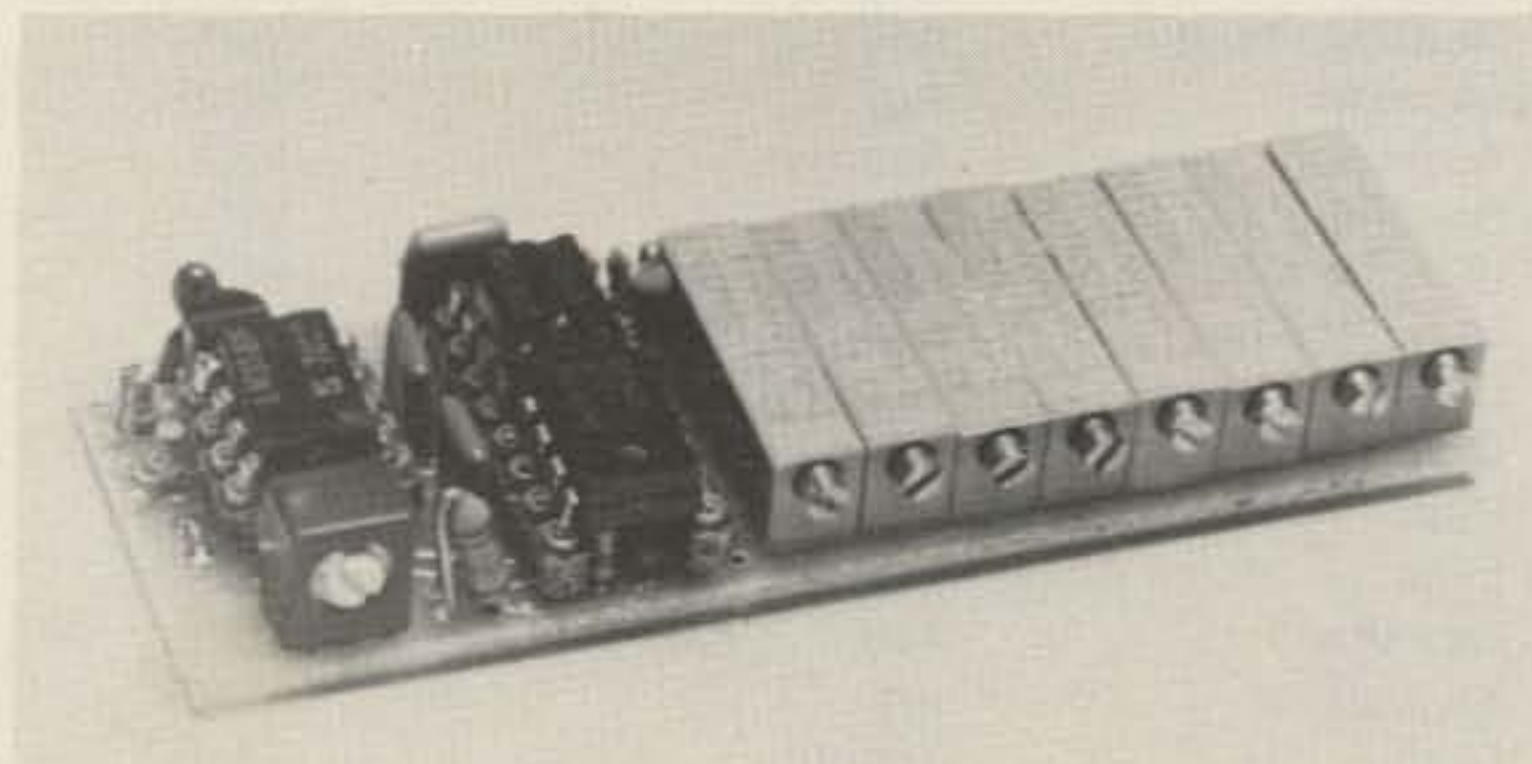

Multi-frequency encoder from Selectone.

Awards

from page 28

DIPLOMA GUGLIELMO MARCONI (DGM)

This award is to celebrate the experiments carried out by Marconi in various parts of the world and bring them once again to the attention of radio amateurs. The DGM will be awarded to those who make contact with the localities in which Marconi once conducted his experiments. To qualify, it is necessary to forward to the ARI all details of your contacts and a) 40 QSLs chosen from the localities listed below, or b) 35 QSLs chosen from the list below plus the QSL from the official com-

memorative station, I14FGM, and one from any other G. Marconi memorial stations for a total of 37 QSLs.

When required (i.e., G = London, I4 = Bologna), the QSLs must indicate the city or region of the locality as required below. The DGM is made available for AM, SSB, CW, RTTY, SSTV, and mixed modes. There is no band limitation; however, all contacts must be made on or after January 1, 1973.

Being somewhat of a 10-meter QRP enthusiast using a converted CB rig, I recently contacted Hugh Aeiker WA8CNN, who happens to be the Awards Custodian for the QRP Amateur

List of qualifying contacts for DGM

Country	Specific Region or City	Prefix
Capo Verde Island	Any	D4C
Portugal	Lisbona	CT1
Madeira Island	Any	CT3
Morocco	Any	CN8
Spagna	Cadice	EA7
Ireland	Any	EI
France	Any	F
Corsica	Any	FC
England	London	G
England	Fiatholm Island	GB
England	Wight Island	G
Northern Ireland	Any	GI
Scotland	Any	GM
Switzerland	Any	HB
Vatican	Any	HV
Italy	Bologna	I4
Italy	Any	I5
Italy	Roma	I0
Italy	Fondaz G. Marconi	IY4FGM
Italy	Torre, Tigullio Marconi	IP1TTM
Italy	Sicilia	IT9
Italy	Sardegna	IS0
Japan	Any	JA
Argentina	Buenos Aires	LU-A-B-C
Belgium	Any	ON
Brazil	Rio de Janeiro	PY
Sweden	Stockholm	SM
Sweden	Gotland Island	SM1
USSR	Leningrad	UA1
Canada	Any	VE1
Newfoundland	Any	VO1
Labrador	Any	VO2
Australia	Sydney	VK2
Bermuda	Any	VP9
USA	Massachusetts	W1
USA	New York State	W2
USA	New Jersey	W2
USA	Missouri	W0
USA	Illinois	W9
India	Any	VU
Gibraltar	Any	ZB
Yugoslavia	Any	YU2
Libya	Tripoli	5A
Any	Memorial Stations	Any

Radio Club International. After hearing everyone on the band claiming to run QRP or QRPP, I figured once and for all I would get the true definition of these terms from one of the originators of an organized QRP group. Not only did I get this group's point of view as stated in their Constitution and By-laws, but I became the recipient of a full packet of information concerning their awards program.

It appears that this QRP fraternity, founded in 1961 by K6JSS, set the QRP standard to mean 100 Watts CW/AM or 200 Watts PEP... input. As for QRPP status, we find the group recognizing this power only in the 5 Watts or less range. Now this is not to be confused with standards set by other QRP societies, such as the Michigan QRPP Club International, which also defines QRPP as under 5 Watts output, yet QRP is much less than 100 Watts.

As for their awards program... it is packed full of incentives, as you'll witness by reading on.

The main objective of the QRP

ARC International Awards Program is to demonstrate the use of limited power which creates less QRM on the amateur bands, while still allowing us to enjoy the usefulness of the hobby. The club issues the following awards which are available to any amateur meeting the requirements as set forth for each below.

QRP-25

This award is issued to any amateur working at least 25 members of the QRP ARC International. Endorsements are issued for 50, 100, 200, and every additional increment of 100. To apply, send copies of logbook data, \$1.00 or 5 IRCs, and a signed statement that you limited your power to 100 Watts input (200 Watts PEP SSB). Your list should also include the membership numbers of each station worked. There are no restrictions on band or mode recognition.

WAC-QRP

This award is issued to any



amateur for confirmed contacts with low power stations in all six (6) continents. Power inputs again must be carefully adhered to and a statement must be made certifying the power was within rules governing the program. Keep in mind also that both your own station and the station you are contacting must be using QRP to qualify. Your QSL cards received must state the station's power used. Fee is \$1.00 or 5 IRCs.

WAS-QRP

This WAS award is issued to any amateur who makes contact with QRP power and contacts stations, one in each of the 50 US states, who are also using QRP power or less. Award fee is \$1.00 or 5 IRCs. GCR apply.

DXCC-QRP

This DX award is issued to any amateur who utilizes QRP power and contacts 100 different countries, each of which must also be using low power

and so stating such on their QSL card. To apply, send log data and \$1.00 or 5 IRCs. GCR apply.

KM/W 1000-MILE-PER-WATT AWARD

Issued to any amateur transmitting from or receiving the transmissions of a low power station, such that the Great Circle Bearings between both sides divided by the power input of the low power station equals or exceeds 1000 miles per Watt. Confused? Ah, it's not all that bad! Special endorsements are given for single band or mode achievements. To apply, send copies of full log data including power used on both sides, signal reports exchanged, band and mode, and specific location of QTH on both sides. Include \$1.00 or 5 IRCs. GCR apply.

DXCC-QRPp

Issued to any amateur for confirmed contacts with stations in 100 DX countries; power levels of 5 Watts or less must be

used by the applicant. Reading the rules closely, I find no power restriction on the stations you must work. To apply, send log-book data, including power used and type of equipment used. Enclose \$1.00 or 5 IRCs. GCR apply.

WAS-QRPp

Issued to any amateur for confirmed contacts with each of the fifty (50) US states while operating five (5) Watts maximum output. To apply, forward all pertinent log data and \$1.00 or 5 IRCs to the Award Manager. GRC apply. Special endorsements will also be issued for states contacted for levels of 20, 30, 40, and 50 states.

As with all awards offered by the QRP ARC International, should you wish to apply, in order not to delay processing of your award, please furnish not only the data, but also the power levels used for each award and the type of equipment used.

All award applications should be sent to: Hugh Aeiker WA8CNN, 5 Keiffer Drive, St. Albans WV 25177.

My special thanks go out to Ade WØRSP/K8EEG, QRP editor for *CQ Magazine*, who recently provided me with the latest up-to-date information concerning some very popular QRP awards being offered by amateur fraternities.

DXCC-QRPp

This award, initiated by the *MILLIWATT: National Journal of QRPp* in 1971, offers a very distinctive challenge to dedicated QRPp stations the world over.

The award requires contacts with DX stations in 100 different countries of the world with the aid of list- or net-type operations. The rules clearly state power must be limited to five Watts or less output. To apply, the applicant must submit a log list in alphabetical order of callsign prefix of the station

worked, indicating date, time, and frequency of each contact. QSL cards must accompany your listing and a signed declaration must be made as to the maximum power and type of equipment used. Application fee is \$15.00 to help defray the cost of the large 30-inch trophy suitably engraved.

DXCC MILLIWATT

This award is also sponsored by the *MILLIWATT: National Journal of QRPp*. The same rules apply for this award as for the DXCC QRPp except that all indications of power level should read "under one Watt output." Applications are the same as for DXCC-QRPp.

THE MILLIWATT FIELD DAY TROPHY

Initiated in 1970, this trophy is awarded to the highest-scoring QRPp station in the ARRL Field Day event held each year in the month of June. To enter, you must submit an ARRL summary sheet, or similar, plus a listing of the stations you work band by band. You must state in your application the power level used, the type of equipment, as well as your method of measuring output power. If you use 1-5 Watts, you may multiply your score by four.

For power level under one Watt output, you may multiply your score times 5. In addition, another 1.5 times your score may be added for operating your QRPp station independent of power mains. Another 150 bonus points are earned for full portable setup away from your QTH.

All three awards, the DXCC-QRPp, DXCC Milliwatt, and the Milliwatt Field Day Trophy, are obtainable by making application to: Adrian Weiss WØRSP, 83 Suburban Estates, Vermillion SD 57069.



Ham Help

I am interested in becoming a radio operator. Does anyone know of any radio classes near me?

Herbert E. Scott
84 Torrey St.
South Weymouth MA 02190

Although our Michigan Technological University Amateur

Radio Club has a long history, any records of the club prior to 1971 are not known to us. If someone knows anything about the early days (before 1971) of our club, please contact me. Any help will be appreciated.

Hideki Yumoto AG8C
133ECH MTU
Houghton MI 49931

ou goons don't ever proof-
lousy manuscripts from bat-
burh...
you...
I insist that you print ev-
tell Ma Bell that she sho-

LETTERS

from page 35

ing that your publication is one of the most widely read among hams, I thought your readers might be interested in a recent experience we had which has resulted in our offering a new service.

Our emergency department became involved with a distress call at sea that was picked up by a local ham. They needed medical advice and called Memorial Hospital. We agreed to accept the collect call and our emergency department physician was able to provide the appropriate medical advice.

W6CRD's phone patch, which we received last month from VP5TJ/MW, Region 3, from the 77-foot motor vessel *Tin Ajo* to our hospital's emergency room, was what precipitated our getting involved. Via the patch, Dr. Allen Hooper was able to successfully treat the vessel's chief engineer for severe coral-induced infection though he was across the Pacific at the time. W6CRD ran follow-up contacts between the ship and Dr. Hooper until the infection subsided and the patient was out of danger.

Fortunately, these situations arise infrequently, but when they do, medical advice is a necessity. In the aftermath of this recent incident, we are now offering to accept collect calls from amateur radio operators in California, Nevada, Oregon, and Washington who are in contact with maritime mobile stations

who have medical emergencies. All they need do is call our hospital's emergency department, which is (213)-595-2133.

William J. Loveday
Vice President,
Memorial Hospital
Medical Center
Long Beach CA

PARANOIC

I read with interest Mr. Conklin's letter in the November, 1979, Letters (p.16). First of all, my actions concerning the Russian woodpecker were not booboos. The Russians are obviously experimenting with their point-to-point 14-MHz band. I and hundreds of others were merely trying to verify the reports we read in 73.

I chased the woodpecker on three occasions, and my excursions into this mess were experimental in nature; they were intended to help determine the nature of the phenomenon. I am now drafting a report to the FCC detailing my experiences (mostly of a monitoring nature) and if they feel that my actions were not useful or warranted, they may take any action they desire. They will decide points of legality.

My position on this matter is that I (and the others) was emitting signals of an experimental nature regarding an unusual phenomenon found on the 14-MHz ham band. My references to using SSTV and other modes were, of course, frivo-

lous. Any other images created by my letters are incorrect (and in some cases paranoid!).

The reason Mr. Conklin could not find me in the ARRL Intruder Watch program is that I prefer direct action. The record of the Watch program is well known. I cannot speak for the other hams mentioned in Mr. Conklin's fascinating letter.

Steve Baumrucker WD4MKQ
Durham NC

WORTH WAITING FOR

The November 73 was a little late in arriving, but the splendid article by W5KHT entitled "The Satellite TV Primer" was well worth waiting for.

This is an upcoming technology that will change long-distance radio transmissions as well. Many thanks.

Paul G. Stecher
Westwood NJ

GREAT HELP

For some time, I have been intending to write you and tell you how much I enjoy 73. Your November issue was the best yet. Your timely article on satellite reception was excellent and well done.

Another factor that really interests me is the amount of advertising. Receiving 73 is like receiving a ham catalog every month. The ads are tremendous and always well done.

This is my last renewal for QST. I'm just plain disgusted with the ARRL. I have been a member for 56 years and during that time the ARRL has watched our ham bands be nibbled away and done little or nothing. Every time you criticize them, the headquarters staff draws up the drawbridge, fills the moat, and shoots arrows at you.

Keep up the good work — your 73 Magazine and policies have really been a great help to amateur radio.

Wells Chapin W8GI
Kingsley MI

Thanks for the letter, Wells. Your many articles on the history of amateur radio have been extremely well done. You obviously have been keeping much closer track of events than most amateurs and have things in perspective. We don't really know how the results of WARC will work out, though I join amateurs everywhere in hoping for the best. If we do luck out, it will be galling to see any group crow about the results and try to claim credit. The pattern of events leading to WARC held no reason for optimism for amateur radio, despite years of golden opportunities to do the needed groundwork. You have written about this many times, with your ideas and helpful suggestions falling on deaf ears. — Wayne.

PROGRESS

The "Bad Taste" letter from Dale Richman (November, 1979, p. 190) leaves me with deep concern, also. If it were not for 73, I would not find out the latest in solid-state technology and how MDS and satellite TV works.

As an avid fast-scan ATV operator, I am interested in the challenge of receiving a picture from distant sources. If 73 did not publish such material, I couldn't learn and progress in amateur radio.

So, please keep publishing all kinds of articles, like home-brew UHF and microwave devices. After all, where would we be if no one had info on how to build these receivers?

John Du Bry K6KDO
Yucaipa CA

Ham Help

First, I'm interested in getting in touch with a net for disabled amateurs, if there is one. If not, is anyone interested in forming such a net?

Second, I need information and specifications on the following pieces of equipment:
•Link VHF high- and low-band transmitters, receivers, and transceivers (2210, 1623, 2552,

1905 ED-2, 2240 ED-18, and 2365);
•Teleprinter TT-4;
•Test set CPR-60 AAB, a two-band VHF-UHF test receiver;
•ARC-1, Command Sets (ARC-5), VHF ARC-5;
•BC-1206 and BC-1306 receivers;
•Western Union Telefax transceiver (no model number). It has

three push-buttons: "incoming," "stop," and "outgoing";
•Hickok vacuum tube volt-ohm-milliammeter, made for the Department of the U.S. Navy;
•ARB receiver;
•Realistic Timekubé®, model 12-159;
•Realistic Jetstream AM-AIR Band receiver.

Any help would be very much appreciated.

John C. White WB6BLV
560 N. Indiana St.
Porterville CA 93257

I am in need of a schematic and operating instructions for a Hammarlund HQ-180A. I would be happy to pay copying and shipping costs. Any help would be greatly appreciated.

Dante H. Ventriere KA4JRE
17831 NW 18 Avenue
Hialeah FL 33015

The Kenwood International Users' Club is now operational. Send an SASE for details.

Robert A. Pohorence N8RT
9600 Kickapoo Pass
Streetsboro OH 44240

OSCAR Orbits

Courtesy of AMSAT

Any satellite placed into a near-Earth orbit suffers from the cumulative effects of atmospheric drag. The much publicized descent of the Skylab space station was a graphic demonstration of these effects.

The OSCAR satellites are subject to atmospheric drag, of course, and the present period of intense solar activity has accentuated the problem. During this period, our sun has been expelling huge numbers of charged particles, some of which find their way into the Earth's upper atmosphere, increasing the density (and thus the drag) there. It is through this region that the OSCARs must pass. OSCAR 8, in a lower orbit than OSCAR 7, is the more seriously affected of the two.

If the drag factor is not considered when OSCAR calculations are performed, long-range orbital projections will be in error. For example, by the end of 1979, OSCAR 8 was more than 20 minutes ahead of some published schedules. The nature of orbital mechanics is such that extra drag on a satellite causes it to move into a lower orbit, resulting in a shorter orbital period. Thus, the satellite arrives above a given Earthbound location earlier than predicted.

Using data supplied to us by Dr. Thomas A. Clark W3IWI of AMSAT, the equatorial crossing tables shown here were generated with the aid of a TRS-80™ microcomputer. The tables take into account the effects of atmospheric drag and should be in error by a few seconds at most.

The listed data tells you the time and place that OSCAR 7 and OSCAR 8 cross the equator in an ascending orbit for the first time each day. To calculate successive OSCAR 7 orbits, make a list of the first orbit number and the next twelve orbits for that day. List the time of the first orbit. Each successive orbit is 115 minutes later (two hours less five minutes). The chart gives the longitude of the day's first ascending (northbound) equatorial crossing. Add 29° for each succeeding orbit. When OSCAR is ascending on the other side of the world from you, it will descend over you. To find the

equatorial descending longitude, subtract 166° from the ascending longitude. To find the time OSCAR 7 passes the North Pole, add 29 minutes to the time it passes the equator. You should be able to hear OSCAR 7 when it is within 45 degrees of you. The easiest way to determine if OSCAR is above the horizon (and thus within range) at your location is to take a globe and draw a circle with a radius of 2450 miles (4000 kilometers) from your QTH. If OSCAR passes above that circle, you should be able to hear it. If it passes right overhead, you should hear it for about 24 minutes total. OSCAR 7 will pass an imaginary line drawn from San Francisco to Norfolk about 12 minutes after passing the equator. Add about a minute for each 200 miles that you live north of this line. If OSCAR passes 15° east or west of you, add another minute; at 30°, three minutes; at 45°, ten minutes. Mode A: 145.85-95 MHz uplink, 29.4-29.5 MHz downlink, beacon at 29.502 MHz. Mode B: 432.125-175 MHz uplink, 145.975-925 MHz downlink, beacon at 145.972 MHz.

At press time, OSCAR 7 was scheduled to be in Mode A on odd numbered days of the year and in Mode B on even numbered days. Monday is QRP day on OSCAR 7, while Wednesdays are set aside for experiments and are not available for use.

OSCAR 8 calculations are similar to those for OSCAR 7, with some important exceptions. Instead of making 13 orbits each day, OSCAR 8 makes 14 orbits during each 24-hour period. The orbital period of OSCAR 8 is therefore somewhat shorter: 103 minutes.

To calculate successive OSCAR 8 orbits, make a list of the first orbit number (from the OSCAR 8 chart) and the next thirteen orbits for that day. List the time of the first orbit. Each successive orbit is then 103 minutes later. The chart gives the longitude of the day's first ascending equatorial crossing. Add 26° for each succeeding orbit. To find the time OSCAR 8 passes the North Pole, add 26 minutes to the time it crosses the equator. OSCAR 8 will cross the imaginary San Francisco-to-Norfolk line about 11 minutes after crossing the equator. Mode A: 145.85-95 MHz uplink, 29.4-29.50 MHz downlink, beacon at 29.40 MHz. Mode J: 145.90-146.00 MHz uplink, 435.20-435.10 MHz downlink, beacon on 435.090 MHz.

OSCAR 8 is in Mode A on Mondays and Thursdays, Mode J on Saturdays and Sundays, and both modes simultaneously on Tuesdays and Fridays. As with OSCAR 7, Wednesdays are reserved for experiments.

OSCAR 7 ORBITAL INFORMATION FOR FEBRUARY

ORBIT #	DATE	TIME (GMT)	EQ. CROSSING (DEGREES WEST)
23845	1	0118:54	87.9
23857	2	0018:13	72.8
23870	3	0112:29	86.4
23882	4	0011:49	71.2
23895	5	0106:05	84.8
23907	6	0005:24	69.7
23920	7	0059:40	83.2
23933	8	0153:56	96.8
23945	9	0053:16	81.7
23958	10	0147:32	95.3
23970	11	0046:51	80.1
23983	12	0141:07	93.7
23995	13	0040:27	78.6
24008	14	0134:43	92.1
24020	15	0034:02	77.0
24033	16	0128:18	90.6
24045	17	0027:37	75.4
24058	18	0121:53	89.0
24070	19	0021:13	73.9
24083	20	0115:29	87.5
24095	21	0014:48	72.3
24108	22	0109:04	85.9
24120	23	0008:24	70.8
24133	24	0102:40	84.3
24145	25	0001:59	69.2
24158	26	0056:15	82.8
24171	27	0150:31	96.4
24183	28	0049:50	81.2
24196	29	0144:06	94.8

OSCAR 8 ORBITAL INFORMATION FOR FEBRUARY

ORBIT #	DATE	TIME (GMT)	EQ. CROSSING (DEGREES WEST)
9728	1	0127:32	71.1
9742	2	0132:31	72.4
9756	3	0137:30	73.6
9770	4	0142:29	74.9
9783	5	0004:16	50.4
9797	6	0009:15	51.6
9811	7	0014:14	52.9
9825	8	0019:13	54.2
9839	9	0024:12	55.4
9853	10	0029:11	56.7
9867	11	0034:10	58.0
9881	12	0039:09	59.2
9895	13	0044:08	60.5
9909	14	0049:06	61.8
9923	15	0054:05	63.0
9937	16	0059:04	64.3
9951	17	0104:03	65.6
9965	18	0109:01	66.8
9979	19	0114:00	68.1
9993	20	0118:59	69.4
10007	21	0123:57	70.6
10021	22	0128:56	71.9
10035	23	0133:55	73.2
10049	24	0138:53	74.4
10062	25	0000:39	49.9
10076	26	0005:37	51.1
10090	27	0010:36	52.4
10104	28	0015:34	53.7
10118	29	0020:33	54.9

OSCAR 7 ORBITAL INFORMATION FOR MARCH

ORBIT #	DATE	TIME (GMT)	EQ. CROSSING (DEGREES WEST)
24208	1	0043:26	79.7
24221	2	0137:42	93.3
24233	3	0037:01	70.1
24246	4	0131:17	91.7
24258	5	0030:36	76.5
24271	6	0124:52	90.1
24283	7	0024:12	75.0
24296	8	0118:28	88.6
24308	9	0017:47	73.4
24321	10	0112:03	87.0
24333	11	0011:23	71.9
24346	12	0105:38	85.5
24358	13	0004:58	70.3
24371	14	0059:14	83.9
24384	15	0153:30	97.5
24396	16	0052:49	82.3
24409	17	0147:05	95.9
24421	18	0046:24	80.8
24434	19	0140:40	94.4
24446	20	0040:00	79.2
24459	21	0134:16	92.8
24471	22	0033:35	77.7
24484	23	0127:51	91.2
24496	24	0027:10	76.1
24509	25	0121:26	89.7
24521	26	0020:46	74.5
24534	27	0115:02	88.1
24546	28	0014:21	73.0
24559	29	0108:37	86.6
24571	30	0007:56	71.4
24584	31	0102:12	85.0

OSCAR 8 ORBITAL INFORMATION FOR MARCH

ORBIT #	DATE	TIME (GMT)	EQ. CROSSING (DEGREES WEST)
10132	1	0025:31	56.2
10146	2	0030:29	57.5
10160	3	0035:28	58.7
10174	4	0040:26	60.0
10188	5	0045:24	61.3
10202	6	0050:22	62.5
10216	7	0055:21	63.8
10230	8	0100:19	65.0
10244	9	0105:17	66.3
10258	10	0110:15	67.6
10272	11	0115:13	68.8
10286	12	0120:11	70.1
10300	13	0125:09	71.4
10314	14	0130:07	72.6
10328	15	0135:05	73.9
10342	16	0140:03	75.2
10355	17	0001:40	50.6
10369	18	0006:46	51.9
10383	19	0011:44	53.1
10397	20	0016:42	54.4
10411	21	0021:39	55.7
10425	22	0026:37	56.9
10439	23	0031:35	58.2
10453	24	0036:32	59.4
10467	25	0041:30	60.7
10481	26	0046:28	62.0
10495	27	0051:25	63.2
10509	28	0056:23	64.5
10523	29	0101:20	65.8
10537	30	0106:18	67.0
10551	31	0111:15	68.3

Review

COMPLETE GUIDE TO AMATEUR RADIO
by Joseph DuBovy
Parker Publishing Company,
1979

You are not alone if you have ever wished that there was ONE book that had all the answers to questions about ham radio. The publisher's description of a *Complete Guide to Amateur Radio* might make you think that such a book is finally available. Billed as "the indispensable

guide to amateur radio," this 264-page hardcover book from Parker Publishing Company may turn out to be a disappointment to many amateurs. It is intended for beginners who are full of questions and looking for easy-to-understand answers.

The *Complete Guide to Amateur Radio* will not leave a prospective ham baffled by a lot of unexplained technical jargon or long-winded theoretical discussions. The author, Joseph Du-

Bovy W2TCC, guides his readers from an introduction to the "magic of ham radio" to a description of how to build a simple transmitter and antenna. Along the way, topics such as satellite communication, receiver block diagrams, and basic semiconductor theory are discussed. While no subject gets thorough treatment, most of the questions a beginning ham might have are answered.

Promotional literature and the book's jacket claim that the knowledge needed to pass the Novice or General/Technician license exam is included. Unfortunately, much of the informa-

tion is several years old. The author even refers to a \$9.00 license cost, something that changed about five years ago! The guts of the licensing material is of the question-and-answer variety. As the exams get tougher and include many questions on the frequently changing rules and regulations, it is unlikely that the dated information will be adequate to pass the exams.

Another advertised feature of the book is its chapter on the Navy's special method for mastering Morse code. While the segment on sending is painstakingly complete, the "secrets" for

receiving code are brief. I think that the secret of learning code is not held in a few paragraphs of a book; it is in regular practice, using a challenging source of code.

The one-tube transmitter described in the *Complete Guide to Amateur Radio* would be easy to construct if you were already an experienced builder. Unfortunately, the author gives an in-

complete explanation. Only a smattering of construction practices can be found and the table showing the color-coding scheme for resistors does not tell the reader what number each color stands for. The most obvious omission is a mention of safety practices. This is especially important when the first-time builder is tackling a project containing a high-volt-

age supply like the one described.

Much of the book's strength lies in its numerous diagrams and charts. Many of these are from ARRL publications and they do a good job supplementing the text which contains a lot of generalities. The book is not published by one of the traditional ham radio firms, which may account for the expansive

description on the book's jacket and in mail-order advertising. The retail price, \$14.95, may make many amateurs think twice about buying the book. The *Complete Guide to Amateur Radio* is suited for beginners, but they should realize that other sources of information may be needed.

Tim Daniel N8RK
Terre Haute IN

Corrections

With regard to my article, "Son of Keycoder" (November, 1979, p. 106), several sharp-eyed readers have called my at-

tention to two small errors in the diode matrix encoding chart (Fig. 3, p. 109). The letters in error are K and X. The correct

encoding is shown here.

I will be happy to answer any questions readers may have

about the circuit or construction details.

L. B. Cebik W4RNL
Knoxville TN

K	INV/I-17	INV/I-16	INV/I-15	INV/I-14	INV/I-13	INV/I-12	INV/I-11
K			X	X		X	
X		X	X			X	

Revised Fig. 3, "Son of Keycoder."

Ham Help

I have several old automobile radios that have vibrator power supplies. Somewhere in my readings I saw an article that gave circuit descriptions and parts data to convert to transistor power in the vibrator can. In other words, the whole circuit is built in the can itself and the present socket is used. I cannot remember where I saw the article. Any assistance will be appreciated. Thanks.

Walter F. Seaberg, Jr. WA4TQI
1801 Pimmit Drive
Falls Church VA 22043

I am willing to pay for a copy of pages 19 and 20 of the Galaxy III transceiver manual (#183-29).

Arthur H. Curling W5MIC
131 Archimedes
San Antonio TX 78223

I would like to obtain a copy of an owner's manual to Xerox, or a Xerox copy, for an RCA Senior volt-ohm-imp VTVM, model WV98C. Also, what is the availability of dc/ac-Ohms probe and cable, model WG299D.

Please advise about what you have and price. I will ensure return of manual.

Harry C. Lein W7HNP
1109 Highland Avenue
Bremerton WA 98310

I would like to hear from anyone interested in starting a rag-chew/roundtable on 50.150 MHz, Thursday evenings, 2000 Pacific Standard Time, 0400 GMT.

Berand Kirschner WB0YCQ
4439 Jupiter Drive
Riverside CA 92505

I recently obtained a Heath SB-102 transceiver and am interested in hearing from hams

who have made modifications/improvements to the unit, especially in the receiver.

John DiLorenzo KA1FN
Box 179BR
Griswold St.
Jericho VT 05465

I need an instruction book, service manual, and/or schematic for a General Radio model 1601 A VHF bridge. Please advise cost of original or reproduction.

Roger Moe W7KGG
Route 1, Box 1140
Wapato WA 98951

I would appreciate any information, especially a schematic, on a Narco Superhomer VHF aircraft transceiver. I would also like to get a schematic and information for a Dumont model 304-A oscilloscope.

I will copy and return with a postage refund or purchase at a reasonable price.

Gary B. Trustle WB8SPV
424 Franklin Ave.
Waverly OH 45690

If you had trouble with either the code or theory and rules & regs (or both!) when you were studying for your Novice ticket but conquered those problems and went on to join the ranks of licensed radio amateurs, then I need your help. Please write to my wife, Cindy, and relate your experiences and hardships so she will realize that she's not the only one who is having a hard time. She really needs help and encouragement.

Timothy M. Mrva WD8QLB
436 1/2 E. Exchange St.
Owosso MI 48867

I need any available data on a Hickok Vacuum-tube volt-ohmmeter, Department of Ships Model OBQ-1. Thanks.

John C. White WB6BLV
560 N. Indiana St.
Porterville CA 93257

I need a schematic for my vintage National NC57B receiver. I will gladly reimburse costs. Thanks.

Larry Pike WD9HCR
PO Box 3766
Quincy IL 62301

JUST GETTING ON THE AIR?

See Adirondack for



- New Equipment
- Used Gear
- Friendly Advice

ADIRONDACK Radio Supply

185-191 West Main Street • P.O. Box 88
Amsterdam, N.Y. 12010 Tel. (518) 842-8350
Just 5 minutes from N.Y. Thruway - Exit 27

ALL BAND TRAP ANTENNAS!

PRE-TUNED - COMPLETELY ASSEMBLED - ONLY ONE NEAT SMALL ANTENNA FOR UP TO 6 BANDS! EXCELLENT FOR CONGESTED HOUSING AREAS - APARTMENTS LIGHT - STRONG - ALMOST INVISIBLE!

COMPLETE AS SHOWN with 90 ft. RG58U-52 ohm feedline, and PL259 connector, insulators, 30 ft. 300 Ω test leadon end supports, center connector with built in lightning arrester and static discharge - melted, sealed, weatherproof, resonant traps "XG" - you just switch to band desired for excellent worldwide operation - transmitting and receiving! WT. LESS THAN 5 LBS.

160-80-40-20-15-10 bands 4 trap --- 169 ft. with 90 ft. RG58U - connector - Model 1060BU ... \$99.95
80-40-20-15-10- bands 4 trap --- 91 ft. with 90 ft. RG58U coax - connector - Model 1060BU ... \$95.95
40-20-15-10 bands 4 trap --- 45 ft. with 90 ft. RG58U coax - connector - Model 1040BU ... \$92.95
20-15-10 bands 4 trap --- 23 ft. with 90 ft. RG58U coax - connector - Model 1002BU ... \$89.95

SEND FULL PRICE FOR POST PAID INSURED DEL IN USA. (Canada is \$5.00 extra for postage - clerical - customs - etc.) or order using VISA Bank Americard - MASTER CHARGE - AMER. EXPRESS. Give number and ex. date. Ph 1-308-236-5333 9AM - 6PM week days. We ship in 2-3 days. ALL PRICES WILL INCREASE - SAVE - ORDER NOW! All antennas guaranteed for 1 year. 10 day money back trial if returned in new condition! Made in USA. FREE INFO. AVAILABLE ONLY FROM

WESTERN ELECTRONICS Dept. A7-2 Kearney, Nebraska, 68847

ALL BAND TRAP ANTENNAS!

Social Events

Listings in this column are provided free of charge on a space-available basis. The following information should be included in every announcement: sponsor, event, date, time, place, city, state, admission charge (if any), features, talk-in frequencies, and the name of whom to contact for further information. Announcements must be received two months prior to the month in which the event takes place.

GRAND JUNCTION CO FEB 9

The Grand Mesa Repeater Society will hold its 1st annual Western Slope Swapfest on Saturday, February 9, 1980, from 10:00 am to 4:00 pm at the Lincoln Park Barn, Grand Junction, Colorado. Table reservations are \$2.00 in advance, per table. Talk-in on 146.22/.82. For further information, write to Larry Brooks WB0ECV, 3185 Bunting Ave., Grand Junction CO 81501.

MANSFIELD OH FEB 10

The Mansfield mid-winter hamfest and auction will be held on February 10, 1980, at the Richland County Fairgrounds, Mansfield, Ohio. Featured will be prizes, a flea market, and an auction to be held in large heated buildings. Doors will open to the public at 8:00 am. Tickets are \$1.50 in advance and \$2.00 at the door. Talk-in on 146.34/.94. For additional information or advance tickets, contact Harry Frietchen K8HF, 120 Homewood, Mansfield OH 44906, or phone (419)-529-2801 or (419)-524-1441.

MINONG WI FEB 17

The Wild Rivers Amateur Radio Club will hold a mid-winter swapfest on Sunday, February 17, 1980, from 10:00 am to 3:00 pm at the Minong village hall, Minong, Wisconsin, 45 miles south of Duluth-Superior, 90 miles north of Eau Claire on Highway 53, and 135 miles from Minneapolis-St. Paul. Admission is \$1.50 and tables are free. There will be a raffle drawing for a scanner. Talk-in on .28/.88 and .52. For information, contact Roger Doehr W9DLY, Rte. 5, Box 452, Hayward WI 54843.

LIVONIA MI FEB 17

The Livonia Amateur Radio Club will hold its 10th anniversary Swap 'n Shop on Sunday,

February 17, 1980, from 8:00 am to 4:00 pm, at the Churchill High School, Livonia, Michigan. There will be plenty of tables, door prizes, refreshments, and free parking available, plus reserved table space of 12-foot minimum. Talk-in on 146.52. For further information, send an SASE to Neil Coffin WA8GWL, c/o Livonia Amateur Radio Club, PO Box 2111, Livonia MI 48150.

GLASGOW KY FEB 23

The Mammoth Cave ARC will hold its annual Glasgow swapfest on Saturday, February 23, 1980, from 8:00 am to 5:00 pm at the Glasgow Flea Market, south of Glasgow on Highway 31E. There will be a large heated building with plenty of free parking. Spaces are available for \$3.00 each. There will be no meetings or forums, just door prizes, free coffee, and a large flea market. Admission is \$2.00. Talk-in on .34/.94. For additional information, contact WA4JZO, 121 Adairland Ct., Glasgow KY 42141.

LANCASTER PA FEB 24

The Lancaster Hamfest will be held on February 24, 1980, at the Guernsey Pavilion, located at the intersection of Rtes. 30 and 896, east of Lancaster, Pennsylvania. General admission is \$3.00, except children and XYLs. Doors will open at 8:00 am. All inside spaces are available by advance registration only and are \$3.00 each for an 8-foot space, which includes a table. There will be free tailgating in a specified area outside, if the weather permits. There will be a two-hour Dutch Country tour by an advance registration of \$4.00. Food will be served at the hamfest. Also, there are excellent restaurants and accommodations in the area. Talk-in on .01/.61. For information, write Sercom, Box 6082, Rohrerstown PA 17603.

AKRON OH FEB 24

The Cuyahoga Falls Amateur Radio Club will hold its 26th annual electronics equipment auction and flea market on Sunday, February 24, 1980, from 8:30 am until 4:00 pm at North High School, Akron, Ohio. Tickets are \$2.00 each. Even though it is suggested that you bring your own tables, some tables will be available for \$2.00 each. Featured will be refreshments and prizes, including a first prize of a Kenwood TS-120S and a second prize of a Kenwood TR-2400.

There will be plenty of room for buyers and sellers. Talk-in on 146.52 and 146.04/.64. For details, write CFARC, PO Box 6, Cuyahoga Falls OH 44221 or phone K8JSL at (216)-923-3830.

LAPORTE IN FEB 24

The LaPorte Winter Hamfest will be held on February 24, 1980, starting at 8:00 am, in the LaPorte Civic Auditorium, LaPorte, Indiana. There will be plenty of free tables, plus coffee, donuts, and hot food will be available. Admission is \$2.50 at the gate, or \$2.00 in advance. Talk-in on 146.52. For information, write LPARC, PO Box 30, LaPorte IN 46350.

DAVENPORT IA FEB 24

The Davenport Radio Amateur Club will hold its ninth annual hamfest on Sunday, February 24, 1980, from 8:00 am to 4:00 pm, at the Davenport Masonic Temple, Highway 61 (Brady Street) and 7th Street, Davenport, Iowa. Tickets are \$2.00 in advance; \$3.00 at the door. Tables are \$3.00 each, no limit, with a \$2.00 additional charge for ac electrical hook-up. Talk-in on 146.28/.88 W0BXR repeater. Advance tickets can be purchased by writing to club treasurer Clarence Wilson WA0OEW, 1357 W. 36th Street, Davenport IA 52806.

VIENNA VA FEB 24

The Vienna Wireless Society will hold its annual WINTER-FEST™ on Sunday, February 24, 1980, at the Vienna Community Center, Vienna, Virginia. There will be indoor tables, sales, prizes, food, and outdoor frostbite tailgating. The event at 6:30 am for vendors; 8:00 am

for general admission. Admission is \$3.00, including one prize ticket; \$2.00 for an extra prize ticket. Pre-teens with parents are free. Tables are \$5.00 to \$2.00, depending on the quantity. Frostbite tailgating is \$1.00. Reservations close February 15. For reservations, contact Carrol N. Guin, 7533 Oak Glen Court, Falls Church VA 22042. For other information, contact the Vienna Wireless Society, PO Box 418, Vienna VA 22180.

MARLBORO MA FEB 24

The Algonquin Amateur Radio Club will hold its 3rd annual ham radio flea market on Sunday, February 24, 1980, at the Marlboro Jr. High School Cafetorium, just off Rte. 85 North, Marlboro, Massachusetts. Admission will be 50¢. The event will be held rain, shine, or blizzard. Food will be available. Tables will be \$5.00 in advance or \$7.50 at the door. Talk-in on .01/.61 and .52. For more information or reservations, contact Charles D. McCarthy W1BK, 128 Forest Ave., Hudson MA 01749, or phone (617)-562-5622.

WINCHESTER IN MAR 15-16

The Randolph Amateur Radio Association will hold its 1st annual hamfest on March 15-16, 1980, from 8:00 am to 8:00 pm, both days, at the National Guard Armory, 700 Western Ave., Winchester, Indiana. Featured will be door prizes, food and drink, and a program of speakers for both days. The cost per table, or an equivalent space, is \$3.00. Tickets are \$2.50 at the door, or \$1.50 in advance. Talk-in on 147.90/147.30, 223.30/224.90, and 146.52.

CB TO 10 METER

10 METER CONVERSION KITS FOR CB RADIOS AM-FM & SSB

- Kits for over 300 Models of CB Radios
- Low Cost from \$10.00
Easy to Install with All Instructions
Tune-Up Procedure Alignment
- KITS FOR MOST POPULAR UNITS
Over 5,000 Satisfied Customers
- Write or Call Today for Our Free
1980 Catalogue

AMERICAN CRYSTAL SUPPLY COMPANY

PO Box 638
W Yarmouth, MA 02673
(617) 771-4634

✓ A58

★ For Sale ★

**\$10,000,000
INVENTORY**

The *ultimate* source for electronic components and equipment.

**PRODUCTION OVERRUNS
SURPLUS MATERIALS**

Send us your inquiries. Get on our exclusive mailing list. Inquire in writing or by Telex

TWX: 510-224-6539

Serving domestic and overseas markets.

**Ultima
Electronics, Ltd.
(516) 423-3770**

U13

73 Sherwood Ct., Huntington, N.Y. 11743 U.S.A.

ATTENTION

EXPERIMENTER DESIGNER MANUFACTURER
HFT OFFERS YOU
ENGINEERING SERVICES - MINIMODULE PRODUCTS
AUDIO THROUGH 250 MHz

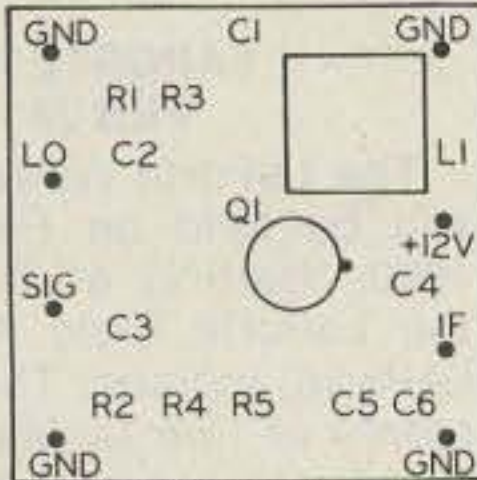

FULL SCALE DUAL GATE MIXER

CATALOG ITEMS IN TWO WEEKS OR LESS
QUICK TURN AROUND ON SPECIALS

CATALOG & DESIGN MANUAL \$2.95 REFUND ON 1ST PURCHASE

DETAILED SPECIFICATIONS

APPLICATION NOTES

DESIGN DATA ON:

RF PREAMPLIFIERS, MIXERS,
SPURIOUS SIGNALS, RECEIVER
PARAMETERS, AUDIO COMPRESSION,
& OTHER DATA

SHORT FORM CATALOG ON REQUEST

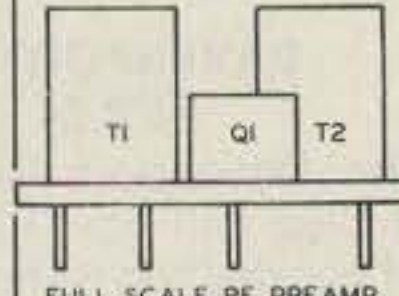

FULL SCALE RF PREAMP.

HFT INC

158 West 9th St
Deer Park NY 11729

HAM SCAN-1: YAESU MEMORIZER

*Scans 145-148 MHz in 10 sec., stops 3 sec. on active channels, simple 7 wire installation.
ORDER HAM SCAN-1.....\$39.95

HAM SCAN-2: K'WD 7625, 7600,

**7400A, KDK 2015R, 2016A, CLEGG FM-28
MIDLAND 13-510, HW-2036, Others soon.**

- * Adds one channel of memory to any above rig
 - * Scan range selectable by position of radio's MHz switch. Up to full 4 MHz width.
 - * Scan rate 200 kHz/sec at 10 kHz steps with a 3 second pause on all active channels
 - * Mike-mounted switch provides 3 functions: start/stop, remote freq. incrementing and xmit interlock while actively scanning
 - * Scanner mounts inside radio, no external box
 - * Assembled, tested and guaranteed \$59.95
- ORDER HAM SCAN-2 and specify type of radio**

Technical Clinic

P.O. BOX 636 T64
STERLING HTS. MI 48078
Phone Orders Call: (313) 286-4836

URFI

(UNIVERSAL RECEIVED
FREQUENCY INDICATOR)



Digitize your receiver's dial with the DIAL SPOTTER. Adapts to most Communication Receivers with simple connection to VFO. From \$149.95 Write for Data Sheet.

**GEMINI
INSTRUMENTS
INCORPORATED**

Box 205, Larchmont, NY 10538 G27

**UNBEATEN SIX
BAND ANTENNA**

THE JOYSTICK VFA

(Variable Freq. Antenna) claims unbeaten scoring over commercial and/or conventional antennae.

- Simple, rapid erection
- Not only 6-band but CONTINUOUS 0.5 - 30 Mhz., incl. BC & MARS
- Omnidirectional
- Substantially Harmonic FREE
- 1,000,000 miles per watt, unbeaten record!
- Poor QTH enhanced!
- CLIFF DWELLERS ANTENNA!
- QUOTE from CQ Mag. - "If you are high enough the antenna will operate (esp. at 15-20) as well as the well-known 3-element beam with which we compared it. The tests were operational, not theoretical! We find that if we can hear 'em we can work 'em."

SYSTEM 'A' \$110.00

150 W.P.E.P. &/or Receiving only

SYSTEM 'J' \$130.00

500 W.P.E.P. &/or Improved

Q Factor Receive

Each System 3-sections easily assembled to make unit 7' 6" long. Matching ATU.

Air mail cost included

Rush Mastercharge/Visa no

or check or request FREE literature.

PARTRIDGE ELECTRONICS LTD

8 Partridge House,

Broadstairs, Kent, England.

G3CED

Tel: 011 44 0843 62535

G3VFA

Please send all reader inquiries directly

**AUTOMATIC CW
COPIER**

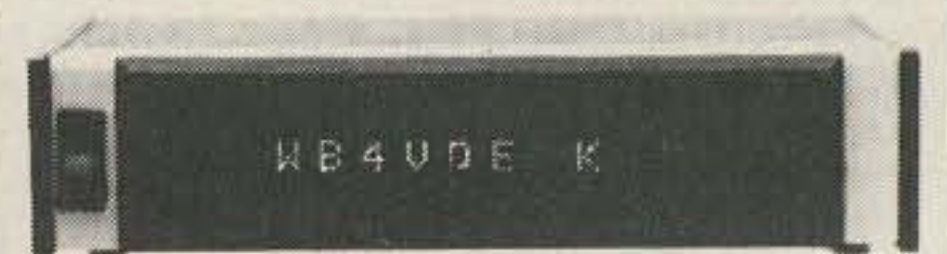

Now you can copy the fast CW stations. The NEW professionally designed DE-150 plugs into a transceiver's earphone jack & automatically displays Morse code as it is being received. New characters are entered from the right and shift left giving a continuous easy to read display of the latest code received. \$425.

One year warranty and 15 day return privilege. Add \$5 for shipping. VISA & MC cards welcome.

D73

**Dynamic
ELECTRONICS INC.**

(205) 773-2758 Box 896 Hartselle, AL 35640

50 144 REPEATERS 220 450 Mhz

Hi Pro Mk I



OPTIONS

- Duplexers
- Basic auto patch
- Matching cabinet
- .0005% High stability crystals

50 MHz \$889.95 450 MHz 899.95
144 or 220 MHz 799.95

PA Res. add 6% tax
PLUS SHIPPING

**New and Improved
Receiver
and Transmitter**

Available Separately:

COR Identifier: All on one board, programmable, Fully adjustable, time out (.5-7 min.), hang time (0-1 min.), identifier (1-10 min.), tone, speed, volume, L.E.D. outputs, low current drain CMOS logic, plugs for easy installation and removal plus much more. \$89.95

Basic Repeater \$599.95

2M 130-175 MHz Basic Repeater for 2 meters with all the features of the Hi Pro Mk I less the power supply and front panel controls and accessories.

Maggiore Electronic Laboratory

845 WESTTOWN RD. M36
WEST CHESTER, PA. 19380 PHONE 215 436-6051

EIMAC 3-500 Z

Special price — limited quantity

\$150.00/pair

TEKTRONIX
1L5 Spectrum Analyzer
plug-in
50 Hz - 1MHz \$899.00

TEKTRONIX 1S1
DC - 1GHz
2mV/cm - 200mV/cm
plug-in \$250.00

MURATA CERAMIC FILTERS

Model SFD-455D
455 kHz \$3.00
Model SFB-455D
455 kHz \$2.00
Type: CFM-455E 455 kHz \$7.95
Type: SFE-10.7 10.7 MHz \$5.95

MEASUREMENTS Model 800
Standard Signal Generator
19 MHz - 520 MHz FM \$750.00

HEWLETT PACKARD UHF, VHF, AND MICROWAVE SIGNAL GENERATORS AND SWEEPERS, AND OTHER EQUIPMENT

MODEL 434A
Calorimetric power meter
\$450.00

MODEL 416A
Ratio meter
\$125.00

MODEL 413AR
DC null voltmeter
\$112.50

MODEL 400DR
Vacuum tube voltmeter
\$79.95

MODEL 616B/A
1.8 to 4.2 GHz
only \$399.00

MODEL 618B
3.8 to 7.6 GHz
only \$499.99
A Model \$299.00

MODEL 606A
50 kHz to 65 MHz
.1mV to 3V into 50 ohms
\$1,000.00

MODEL 683C
2 to 4 GHz
ONLY \$299.00

MODEL 616 A/B
1.8 to 4.2 GHz
\$400.00

MODEL TS510/U HP608D
10 MHz to 420 MHz
.1V to .5V
\$399.95

MODEL 620A
7 to 11 GHz
.223V to 1uv.
\$699.99

302A with a 297A
Wave Analyzer and Sweep Drive
20 HZ to 50 kHz
\$799.00

WISPER FANS

This fan is super quiet, efficient cooling where low acoustical disturbance is a must.
Size 4.68" x 4.68" x 1.50", Impedance protected, 50/60 Hz 120 volts AC
ONLY \$9.95 or 2/\$18.00

TRW BROADBAND AMPLIFIER MODEL CA615B

Frequency response 40 to 300 MHz
Gain

300 MHz 16dB MIN.
17.5dB MAX.
50 MHz 0 to -1dB from 300 MHz
24 volts DC at 220ma MAX

only \$19.95

CARBIDE CIRCUIT BOARD DRILL BITS

Size	Price	Size	Price
35	\$2.15	58	\$1.85
42	\$2.15	59	\$1.85
47	\$2.15	61	\$1.85
49	\$2.15	63	\$1.85
51	\$2.15	64	\$1.85
52	\$2.15	65	\$1.85
53	\$1.85	66	\$1.90
54	\$1.85	1.25 mm	\$1.85
55	\$1.85	1.45 mm	\$1.85
56	\$1.85	3.20 mm	\$3.58
57	\$1.85		

MICROWAVE DIODES

H.P. 2835	2.20
MBD101	1.89
MBD102	1.98
1N831	8.00
1N5711	2.20
1N5712	3.45

INTEGRATED CIRCUITS

MC1303L	\$2.00	MC1463R	\$5.15
MC1461R	6.90	MC1469R	3.55
MC1469G	2.05	MC1560G	10.20
MC1550G	1.50	MC1563R	10.00
MC1560R	12.40	MC1568L	5.00
MC1568G	5.31	MC1590G	6.50
MC1569R	8.15	MC1648L	4.70
MC4024P	3.82	MC1648P	3.75
MC6820P	6.95	MC68B21P	12.00
2513	6.95		
8080A	3.95		
2716T1	29.95		
MC1460R	5.40		

ALL CRYSTALS \$4.95

19.2 kHz	2.42 MHz	3.1545 MHz	5.604 MHz	7.79850 MHz	27.70 MHz
32.0	2.4375	3.158	5.61482	7.80150	27.77778
37.35	2.44275	3.1585	5.619	7.81	27.845
49.710	2.4495	3.1615	5.6115	7.926667	27.9
70	2.45	3.1625	5.6265	8.00769	28.728
81.9	2.46125	3.166	5.62963	8.075	28.88889
96	2.482	3.16975	5.6415	8.15571	28.9
225	2.486	3.177	5.64444	8.364	28.93888
250	2.51375	3.181	5.6715	8.820	29.896
285.714	2.581	3.1825	5.675	8.8285	29.9
576	2.604	3.18475	5.680	8.837	30.0000
1.0000 MHz	2.6245	3.1885	5.695	8.8455	30.9
1.3047	2.618	3.2035	5.7	8.854	31.0000
1.689600	2.62825	3.20725	5.70370	8.8625	31.11111
1.7	2.633125	3.2105	5.7105	8.871	31.66667
1.76375	2.639	3.2165	5.733333	8.879500	31.9
1.77125	2.63575	3.2175	5.74815	8.888	32.0000
1.773125	2.64325	3.2315	5.80741	8.905	32.22222
1.78675	2.646	3.23275	5.83704	8.9135	32.6
1.80224	2.647	3.2365	5.85185	8.9305	32.9
1.81875	2.650750	3.23775	5.8968	8.939	33.0000
1.845125	2.6545	3.2385	5.92593	8.956	33.33333
1.84375	2.65825	3.238875	5.95556	9.0265	33.9
1.845625	2.660	3.23925	6.00	9.37491	34.0000
1.84575	2.662	3.24	6.155	9.545	34.4444
1.846	2.66575	3.24025	6.16296	9.555	34.44444
1.84825	2.6695	3.2405	6.210	9.565	35.0000
1.84975	2.677	3.241	6.22222	9.585	35.55555
1.8575	2.68075	3.2425	6.25185	9.65	36.0000
1.908125	2.681	3.244	6.28146	9.7	36.21750
1.925	2.6845	3.248875	6.31111	9.75	36.66667
1.925125	2.68825	3.24925	6.321458	9.8	37.00000
1.927	2.69575	3.24975	6.37037	9.85	37.2175
1.932	2.702	3.2515	6.380416	9.9	37.385
1.982	2.704	3.253625	6.380833	9.934375	37.460
1.985	2.71075	3.255	6.381041	9.95	37.77777
1.9942	2.715	3.256125	6.381666	10.0000	38.00000
1.995975	2.716	3.258625	6.382291	10.010	38.33333
1.964750	2.723	3.261	6.382916	10.020	38.77777
2.0000	2.730	3.261125	6.384166	10.021	38.77778
2.0285	2.7315	3.266125	6.384791	10.040	38.88888
2.05975	2.73225	3.268625	6.385541	10.20833	38.88889
2.125	2.732625	3.271125	6.385416	10.80375	39.00000
2.126175	2.733	3.273625	6.40000	11.0000	39.160
2.12795	2.737	3.3	6.427083	11.13	39.51851
2.1315	2.73975	3.3345	6.42963	11.1805	39.55555
2.133275	2.742125	3.4045	6.45	11.228	39.592593
2.13505	2.7425	3.4115	6.45926	11.2375	39.629630
2.136825	2.744	3.4325	6.47	11.27	39.666667
2.1425	2.7445	3.4535	6.4711	11.2995	39.703704
2.144625	2.74475	3.4675	6.48889	11.3565	39.74071
2.14675	2.746875	3.4815	6.510	11.705	39.777778
2.148875	2.751	3.5	6.537	11.750	39.81481
2.151	2.754	3.579545	6.567	11.755	39.851852
2.153125	2.75525	3.64	6.57778	11.805	39.888888
2.15375	2.762375	3.656	6.582	11.855	39.92592
2.155	2.7735	3.80	6.60741	11.905	39.962963
2.15525	2.776625	3.803	6.612	11.955	40.00000
2.157375	2.78	3.805	6.6645	11.96125	40.037037
2.1595	2.790	3.860	6.66667	11.965	40.074074
2.16375	2.814	3.901	6.673	12.925	40.111111
2.165875	2.817	3.908	6.693	12.93	40.14814
2.170125	2.8225	3.9168	6.705	13.102	40.18518
2.17225	2.835	4.0000	6.723	13.2155	40.222222
2.174375	2.85	4.011	6.7305	13.2455	40.25925
2.1765	2.854	4.126666	6.738	13.2745	40.29629
2.17925	2.854285	4.194	6.75125	13.2845	40.33333
2.18475	2.865	4.26	6.753	13.2945	40.37037
2.18575	2.868	4.3	6.7562	13.3045	40.407407
2.194125	2.8725	4.57	6.7605	13.3145	40.444444
2.207063	2.876875	4.6895	6.7712	13.3245	40.48148
2.208313	2.887	4.6965	6.77625	13.3345	40.51851
2.209563	2.889	4.7175	6.68148	13.3445	40.555556
2.210812	2.894	4.7245	6.81482	13.3545	40.59259
2.210813	2.910	4.7315	6.84444	14.315	40.62963
2.212063	2.920	4.765	6.87407	15.016	40.66666
2.214562	2.925450	4.89	6.880000	15.020	40.703704
2.214563	2.92545	4.90370	6.90370	15.036	40.740741
2.215625	2.931	4.93333	6.910	16.39074	40.77777
2.217938	2.94375	4.96296	6.93333	16.39166	40.814815
2.21975	2.945	5.000	6.940	16.965	40.85185
2.222125	2.94675	5.13125	6.96296	17.00925	40.888888
2.22325	2.952	5.139585	6.97778	17.01018	40.925926
2.22675	2.966	5.147917	7.186666	17.015	40.96296
2.22875	2.973	5.164583	7.193333	17.065	43.33333
2.23725	2.980	5.21482	7.34350	17.115	45.0000
2.2395	2.981	5.25926	7.35	17.165	49.84166
2.24075	2.98325	5.30370	7.36296	17.215	49.95
2.241	2.987	5.33333	7.37778	17.280	50.0000
2.246	2.9989	5.34815	7.390	17.8710	53.45
2.2475	3.001	5.348400	7.42222	17.9065	57.45
2.2925	3.0235	5.426636	7.443	17.9165	59.45
2.2975	3.045	5.436636	7.45850	17.9265	60.45
2.30000	3.049	5.456	7.4615	17.9365	61.95
2.320	3.053	5.4675	7.4685	17.9465	66.66667
2.326	3.062	5.4990	7.4715	17.9665	70.0000
2.32625	3.067	5.5065	7.473	17.975	72.855
2.32825	3.074	5.1111	7.47850	17.9735	75.185
2.3525	3.1125	5.515	7.4815	17.9935	76.66667
2.35256	3.126	5.5215	7.49850	18.290	82.75
2.368	3.137	5.52593	7.5015	19.100	83.0000
2.374	3.13975	5.544	7.62963	20.1	84.0000
2.375	3.1435	5.5515	7.65926	23.25	90.833
2.375	3.144	5.559	7.67407	23.575	93.1346
2.38725	3.145	5.5665	7.68889	25.9	93.535
2.395	3.145	5.574	7.71852	25.99961	93.9353
2.396875	5.5815	5.5815	7.77778	26.66667	94.3
	5.58519	5.58519		26.8965	95.35
	5.589	5.589		26.9	106.850
				26.958	146.64
					147.09
					153.6

Prices are subject to change. Some items are in limited quantity.

Polorad Model 1206
1.95 to 4.20 GHz
signal source
\$400.00

Model 1107 3.8 to 8.20
GHz signal generator
\$550.00

FETS

3N128	\$1.00
40673	1.39
MPF102	.45
MPF121	1.00
MPF131	1.00

AA NICADS
Used/pull out of calculators
79¢ each or \$59.00/100
Nicad battery charger
available \$5.95

TUNNEL DIODES

TYPE	PRICE
TD261A	\$10.00
TD263A	10.00
1N2930	7.65
1N3716	5.00
1N4396	7.50

E.F. Johnson tube socket #122-0275-001
for 3-400Z, 3-500Z, 4-125A, 4-250A, 4-400A
\$29.95/pair

2300 MHz CONVERTER KIT

- PC board and assembly instructions \$25.00
- PC board with 13 chip caps - assembled \$44.50
- PC board with all parts for assembly \$79.95
- PC board assembled and tested \$119.95

RF TRANSISTORS

TYPE	PRICE	TYPE	PRICE	TYPE	PRICE
2N1561	\$15.00	2N5184	2.00	MM1550	10.00
2N1562	15.00	2N5216	47.50	MM1552	50.00
2N1692	15.00	2N5583	4.43	MM1553	56.50
2N1693	15.00	2N5589	4.60	MM1601	5.50
2N2857JAN	2.45	2N5590	6.30	MM1602/2N5842	7.50
2N2876	12.35	2N5591	10.35	MM1607	8.65
2N2880	25.00	2N5637	20.70	MM1661	15.00
2N2927	7.00	2N5641	4.90	MM1669	17.50
2N2947	17.25	2N5642	8.63	MM1943	3.00
2N2948	15.50	2N5643	14.38	MM2605	3.00
2N2949	3.90	2N5645	11.00	MM2608	5.00
2N2950	5.00	2N5764	27.00	MM8006	2.15
2N3287	4.30	2N5842	8.65	MMCM918	1.00
2N3294	1.15	2N5849	19.50	MMT72	.61
2N3301	.75	2N5862	50.00	MMT74	.94
2N3302	1.05	2N5913	3.25	MMT2857	2.68
2N3304	1.48	2N5922	10.00	MRF245	31.05
2N3307	10.50	2N5942	46.00	MRF304	43.45
?N3309	3.90	2N5944	7.50	MRF420	20.00
?N3553	1.45	2N5945	10.90	MRF450A	10.35
2N3818	6.00	2N5946	13.20	MRF476	1.38
2N3866	1.09	2N6080	5.45	MRF502	.49
2N3866JAN	2.70	2N6081	8.60	MRF504	6.95
2N3866JANTX	4.43	2N6082	9.90	MRF509	4.90
2N3924	3.20	2N6083	11.80	MRF511	8.60
2N3925	6.00	2N6084	13.20	MRF501	5.00
2N3927	11.50	2N6094	5.75	MRF5177	20.70
2N3950	26.25	2N6095	10.35	MRF8004	1.44
2N4072	1.70	2N6096	19.35	PT4186B	3.00
2N4135	2.00	2N6097	28.00	PT4571A	1.50
2N4261	14.60	2N6136	18.70	PT4612	5.00
2N4427	1.09	2N6166	36.80	PT4628	5.00
2N4429	7.50	2N6265	75.00	PT4640	5.00
2N4430	20.00	2N6266	100.00	PT8659	10.72
2N4957	3.50	2N6439	43.45	PT9784	24.30
2N4958	2.80	BFR90	3.00	PT9790	41.70
2N4959	2.12	BLY568C	25.00	PT9847	26.40
2N4976	19.00	BLY568CF	25.00	SD1043	5.00
2N5090	6.90	HEP76/S3014	4.95	SD1116	3.00
2N5108	3.90	HEPS3002	11.30	SD1118	5.00
2N5109	1.55	HEPS3003	29.88	SD1119	3.00
2N5160	3.34	HEPS3005	9.95	TA7993	75.00
2N5179	.49	HEPS3006	19.90	TA7994	100.00
		HEPS3007	24.95	40281	10.90
		HEPS3010	11.34	40282	11.90
		HEPS5026	2.56	40290	2.48
		MM1500	32.20		

MHZ ELECTRONIC KITS:

kit #1
Motorola MC14410CP CMOS Tone Generator
CMOS Tone Generator uses 1MHZ crystal to produce standard dual frequency dialing signal. Directly compatible with 12 key Chomeric Touch Tone Pads. Kit includes the following:
1 Motorola MC14410CP Chip
1 PC Board
And all other parts for assembly, with 1 MHz crystal \$20.65

Kit #2
Fairchild 95H90DC Prescaler 350MHZ.
95H90DC Prescaler divides by 10 to 350 MHZ. This kit will take any 35MHZ Counter to 350 MHZ. Kit includes the following:
1 Fairchild 95H90DC Chip
1 2N5179 Transistor
2 UG-88/U BNC Connectors
1 PC Board
And all other parts for assembly. **NOW ONLY \$24.95**
Less 95H90 chip \$10.95

FAIRCHILD VHF AND UHF PRESCALER CHIPS

95H90DC	350MHZ Prescaler Divide by 10/11	\$ 9.50
95H91DC	350MHZ Prescaler Divide by 5/6	8.95
11C90DC	650MHZ Prescaler Divide by 10/11	16.50
11C91DC	650MHZ Prescaler Divide by 5/6	15.95
11C83DC	1GHZ Divide by 248/256 Prescaler	29.90
11C70DC	600MHZ Flip/Flop with reset	12.30
11C58DC	ECL VCM	4.53
11C44DC	Phase Frequency Detector (MC4044P/L)	3.82
11C24DC	Dual TTL VCM (MC4024P/L)	3.82
11C06DC	UHF Prescaler 750MHZ D Type Flip/Flop	12.30
11C05DC	1GHZ Counter Divide by 4	74.35
11C01FC	High Speed Dual 5-4 Input NO/NOR Gate	15.40

CRYSTAL FILTERS: Tyco 001-19880 same as 2194F
10.7MHZ Narrow Band Crystal Filter
3 db bandwidth 15khz minimum 20 db bandwidth 60khz minimum 40 db bandwidth 150khz minimum. Ultimate 50 db: Insertion loss 1.0db Max. Ripple 1.0db Max. Ct. 0+ - 5pf. Rt. 3600 Ohms.
NOW ONLY \$5.95

We bought 6,000 LED digital clocks, made by Spartus. All have alarms. Sold as is. (Some alarms don't work.)
\$7.95 each/2 for \$13.95
Have National clock module Model MA 1002 and 1023. Can be used for 12- or 24-hours.

TUBES

2E26	\$5.00	4X150G	70.00
3-500Z	90.00	100TH	144.00
3-1000Z	225.00	572B	39.00
3B28	5.00	811A	12.95
3X2500A3	150.00	813	29.00
4.65A	54.50	5894	39.00
4-125A	68.75	6146A	5.25
4-250A	80.00	6146B	6.25
4-400A	81.50	6159	10.60
4-1000A	255.00	6293	18.50
5-500A	145.00	6360	7.95
4CX250B	38.50	6907	35.00
4CX250F	53.50	6939	9.95
4CX250G	53.50	7360	10.60
4CX250K	72.00	7984	10.40
4CX250R	48.00	8072	45.00
4CX350A	60.00	8156	7.85
4CX350FJ	70.00	8226	127.70
4CX1000A	289.00	8295A/PL172	328.00
4CX1500B	285.00	8458	25.75
4CX15000A	400.00	8560AS	50.00
4X150A	37.00	8950	7.80

TERMS:
All checks and money orders are in U.S. funds!
All orders sent first class or UPS.
Please include \$1.50 minimum for postage.
All prices are in U.S. dollars.
All parts prime/guaranteed.
5% service charge on all bank cards.



(602) 242-3037
2111 W. Camelback
Phoenix, Arizona 85015

BANK AMERICARD/VISA/MASTERCHARGE
Your Number: _____
(or equivalent) _____
Exp. Date: _____
Your Signature: _____

SEMICONDUCTORS SURPLUS

✓ S63

2822 North 32nd Street/Unit -1 Phoenix, Arizona 85008 (602) 956-9423

We accept checks, MasterCard, and Visa

Prices subject to change without notice



E.F. JOHNSON TUBE SOCKETS & PARTS

POWER TUBE SOCKET

for RCA 8072, 8021, 8122, and 8462
EIA base #E11-81
Will also fit CRT tubes 1EP11 and 1EP1 EIA base #E11-22
\$4.99 each

SCREEN GRID BY-PASS CAPACITOR

1450pf @ 1000pf
Part No. 124-0113-001
\$9.95 each

POWER TUBE SOCKETS

for 4X150A and D, 4CX250B and R, 4CX350A
Part No. 124-0107-001
\$14.95

CHIMNEY for 4CX250B and R, 4X150A and D, and 4CX350A

Part No. 124-0111-001
\$3.99

POWER TUBE SOCKETS

for 4-125A, 4-250A, 4-400A/C etc., 3-400Z, and 3-500Z
Part No.
\$29.95 per pair only

SPRAGUE RF NOISE FILTERS

#JN17-4080A
100VDC @ 70Amps
.22mfd
\$2.99 each

CARBIDE DRILL BITS

for drilling P.C.B.
5 mix **\$6.00**
10 mix **\$10.00**

25AMP SCR's

2N681	\$1.10
2N682	1.25
2N683	1.45
2N684	1.60
2N685	1.70
2N686	1.95
2N687	2.45
2N688	3.45
2N690	3.95

E.F. JOHNSON MINIATURE TYPE V AIR VARIABLE CAPS

189-503-105	1.4-9.2pf
189-504-4	1.8-5pf
189-504-5	1.5-11.6pf
189-505-5	1.7-14.1pf
189-506-105	1.8-16.7pf
189-507-5	2-19.3pf
189-508-5	21.-22.9pf
189-509-5	2.4-24.5pf
189-1-1-4	1.2-4.2pf
189-4-5	1.5-9.1pf
189-5-8	1.1-11pf
189-6-8	1.8-13pf
189-503-5	1.4-9.2pf
\$1.50 each	

FET's

3N128	\$1.00 or 10/8.00
40673	1.39 or 10/10.00
MPF102	.45 or 10/3.50
MFE131	1.00 or 10/8.00
U2705/2N4416	1.00 or 10/8.00
MFE2000	1.00 or 10/8.00
MPF4391	.80 or 10/6.00
2N4303	.50 or 3/1.00
2N5484	.50 or 3/1.00
2N5555	.90 or 2/1.50
2N5639	.48 or 3/1.00
2N5246	.50 or 3/1.00
2N5248/MPF102	.45 or 10/3.50
3N201	1.99 or 10/12.00
3N157A	6.00 each

MOTOROLA POWER TRIACS

TO-220 case
15Amps 600PRV
99¢ each or 10/\$7.50

TUBES

2E26	\$ 5.00
3-500Z	90.00
3B28	4.00
3X2500A3	125.00
3X3000F1	200.00
4-65A	30.00
4-125A	40.00
4-250A	60.00
4-400A	80.00
4-1000A	175.00
4CX250B	38.50
4CX250R	40.00
4CX350A	50.00
4CX1000A	150.00
4X150A	20.00
4X150G	30.00
572B/T160L	39.00
811A	9.95
6146	4.50
6146A	5.25
6146B	6.50
6146W	7.50
6360	7.95
6939	8.00
8072	45.00
8295/PL172	300.00
8950	5.95
8877	300.00
7289	6.99
6KD6	4.00
6LF6	4.00
6LQ6/6JE6	5.99
8908	8.99
6550A	8.00
Other numbers on request	

HIGH VOLTAGE CAPS

22mfd @ 500VDC
7/8 in. x 1 1/2 in.
\$1.99 each

330mfd @ 450VDC
Can Type
1 1/8 in. x 4 1/4 in.
\$4.99 each

SEMICONDUCTORS SURPLUS

✓ S63

2822 North 32nd Street/Unit -1 Phoenix, Arizona 85008 (602) 956-9423

We accept checks, MasterCharge, and Visa

Prices subject to change without notice



HIGH VOLTAGE CAPS

150uf @ 450VDC
Can Type
1 3/8 in. x 3 1/2 in. high
\$2.99 each

50uf @ 450VDC
Can Type
1 in. x 3 in. high
\$2.99 each

MINI TRIM POTS

5 Ohm	5 K
10 Ohm	10 K
17 Ohm	20 K
50 Ohm	25 K
100 Ohm	50 K
150 Ohm	100 K
200 Ohm	200 K
500 Ohm	250 K
1 K	500 K
2 K	1 Meg
2.5 K	5 Meg
4.7 K	

49¢ each

MINI RF CHOKES

.2 uh	33 uh
.5 uh	39 uh
.56 uh	47 uh
.68 uh	100 uh
1.5 uh	680 uh
2.2 uh	1000 uh
3.3 uh	1 mh
6.8 uh	1.1 mh
10 uh	2.5 mh
22 uh	6.8 mh
27 uh	10 mh

79¢ each

PRESS FIT RECTIFIERS

DO-21 500VDC @ 25Amps
2/\$1.00

MAN 3's
4/\$1.00

FULL WAVE BRIDGES

Motorola MDA 204/3N256	2Amps @ 400VDC	\$.69 each
Varo VH147	6Amps @ 100VDC	1.00 each
Varo VS148	2Amps @ 100VDC	.69 each
Varo VS647	2Amps @ 600VDC	1.29 each
Motorola and GI	25Amps @ 600VDC	2.99 each

RF TRANSISTORS

2N2270	\$.78	2N6084	\$13.20
2N2857	1.80	2N6094	5.75
2N2857JAN	2.45	2N6095	19.35
2N2947	17.25	2N6097	28.00
2N3261	2.10	2N6166	36.80
2N3375	7.99	2N6439	43.45
2N3553	1.80	40280	2.00
2N3866	1.09	40281	10.90
2N3866JAN	2.70	40282	11.90
2N3866JANTX	4.43	40894	.99
2N3925/M9477	6.00	FT3551C/2N6082NS	4.00
2N3948	2.00	(no stud)	
2N3950	26.25	PT3563	5.00
2N3818	6.00	PT4132D/2N5641	4.90
2N4072	1.70	PT4571A	1.50
2N4427	1.09	MRF216	20.00
2N4429	7.50	MRF221	10.00
2N4877	.90	MRF227	2.00
2N4959	2.12	MRF240	price on request
2N5108	3.90	MRF245	31.05
2N5109	1.55	MRF247	39.95
2N5179	.43	MRF314	14.00
2N5177	20.70	MRF412	price on request
2N5190	1.50	MRF422A	42.30
2N5583	4.43	MRF426A	price on request
2N5214	20.00	MRF450	10.35
2N5589	4.60	MRF450A	10.35
2N5590	6.30	MRF454/568BLYCF	17.95
2N5591	10.35	MRF472	1.15
2N5637	20.70	MRF475	2.90
2N5645	11.00	MRF476	1.38
2N5842/MM1607	8.65	MRF477	2.00
2N5919	30.00	MRF479	price on request
2N5946	13.20	MRF485	price on request
2N5849/MM1620	20.00	MRF502	.49
2N5862	50.00	MRF629	3.00
2N6080	5.45	MRF901	3.99
2N6081	8.60	MRF911	3.99
2N6082	9.90	MRF5176	13.00
2N6083	11.80	MRF8004	1.44
		Other numbers on request	



SPECTRONICS, INC.

1009 Garfield St., Oak Park, Illinois • 60304

(312) 848-6777 ✓S81

BARGAIN FAVORITES!

OUR BEST-SELLING MULTI-BAND!



AS LOW AS
\$73⁷⁵

- One half the length of conventional half-wave dipoles
- Multi-band, Multi-frequency
- Maximum efficiency — no traps, loading coils, or stubs
- Fully assembled and pre-tuned — no measuring, no cutting
- All weather rated — 1 KW AM, 2.5 KW CW or PEP SSB
- Proven performance — more than 10,000 have been delivered
- Permit use of the full capabilities of today's 5-band xcvsr.
- One feedline for operation on all bands.

40-10HD/A 40/20/15/10 Mtrs (36)	\$73.75 c
80-40HD/A 80/40 Mtr bands (69)	77.25 c
75/40HD/A 75/40 Mtr bands (66)	73.75 c
75-10HD/A 75/40/20/15/10 Mtr (66)	89.95 c
80-10HD/A 80/40/20/15/10 Mtr (69)	94.95 c

Famous "W2AU" Balun

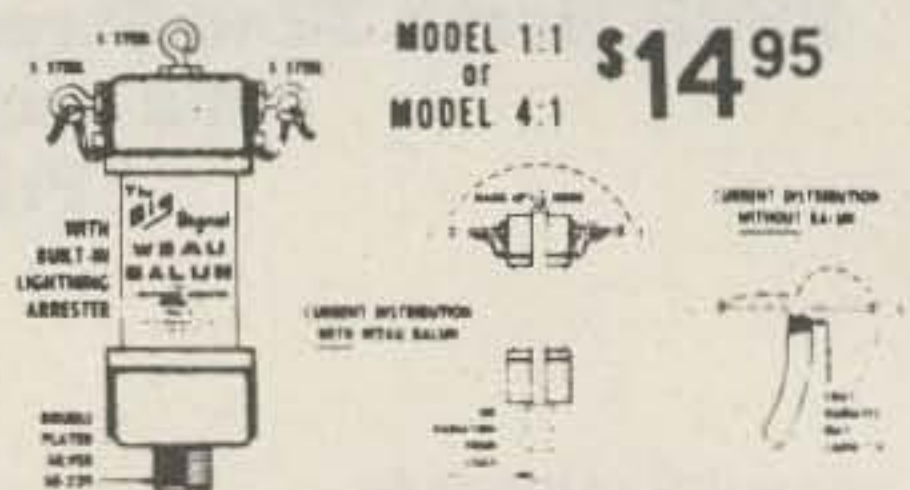

MODEL 1:1 OF MODEL 4:1 **\$14⁹⁵**

1. HANDLES FULL 2 KW PEP AND THEN SOME Broad Banded 3 to 40 Mc
 2. HELPS TVI PROBLEMS By Reducing Coax Line Radiation
 3. NOW ALL STAINLESS STEEL HARDWARE SO239 Double Silver Plated
 4. IMPROVES F/B RATIO By Reducing Coax Line Pick-Up
 5. REPLACES CENTER INSULATOR Withstands Antenna Pull of Over 600 Lbs
 6. BUILT IN LIGHTNING ARRESTER Helps Protect Balun — Could Also Save Your Valuable Gear
 7. BUILT IN HANG-UP HOOK Ideal for Inverted Vees, Multi-Band Antennas, Dipoles, Beam and Quads
- NOW BEING USED BY ALL BRANCHES OF THE U.S. ARMED FORCES, FAA, RCA, CIA, CANADIAN DEFENSE DEPT PLUS THOUSANDS OF HAMS THE WORLD OVER
- Comes in 2 models: 1:1 matches 50 or 75 ohm unbalanced (coax line) to 50 or 75 ohm balanced load 4:1 model matches 50 or 75 ohm unbalanced (coax line) to 200 or 300 ohm balanced load
- Model 1:1.....\$14.95 Model 4:1.....\$14.95

2 METER ANTENNAS at BARGAIN PRICES!!

hy-gain 3 db GAIN
NEW! MAGNETIC MOUNT
ONLY

Model 287
Wt. 2.5 lbs.

\$19.⁹⁵

An economical alternative to drilling a hole. A magnetic antenna by a name you can trust at a low, low price.

Model 286 Same but trunk lid.....\$15.95 b

NEW! FINCO

2.8 dbd GAIN
BASE ANTENNA

ONLY **\$9.⁹⁵**

Model A2-GP
Wt. 2 lbs.

At last! An inexpensive, omni directional, 144-148 MHz, 1/2 wave antenna. Fits 1 1/4" mast, 50 ohm imp. A good antenna at a very affordable price.

NEW! FROM

avanti antennas

ON GLASS MOBILE ANTENNAS

Modern technology lets you mount a mobile antenna right on the window. Ideal for tough installations. 3 models available

AH151.3G 144-174 MHz, 3 db gn	\$33.95 b
AH220.3G 220 MHz, 3 db gn	33.95 b
AH450.5G 406-512 MHz, 5 db gn	36.95 b

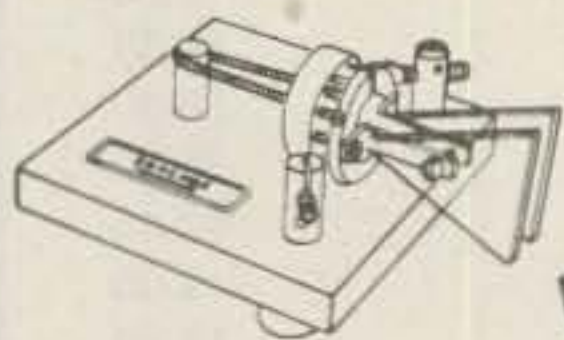

BENCHER

If it's the ultimate in paddles your looking for may we recommend the Bencher. It's simply the nicest one we've seen yet.

BY1 paddle w/black base.....\$39.95 c
BY1 Deluxe model w/chrome base... 49.95 c

IMPROVE YOUR RECEPTION!

AN AMECO ALL-BAND PREAMP!
• 6-160 Meters
• 20+ dB Gain
• Low Price



ONLY **\$49⁹⁵**

MODEL PLF-2... Improves weak signals as well as image and spurious rejection of most receivers. Direct switching to rec. or preamp. Includes pwr. supp. 117 VAC wired & tested **\$49.95.**

DIPOLE HEADQUARTERS

CABLE

8U FOAM, hi dens braid 50 ft.....	\$12.95 c
8U FOAM, hi dens braid 100 ft.....	24.00 e
RG58A/U stranded center 50 ft.....	6.95 c
RG58A/U stranded center 100 ft.....	9.95 d
RG58 3 ft w/PL259 each end.....	3.35 b
RG58 5 ft w/PL259 each end.....	4.39 b
RG58 50 ft w/PL259 each end.....	9.95 c

COPPER WIRE

#14 stranded, 100 ft spool.....	5.95 c
#14 solidcopper enameled 100'	5.95 c

INSULATORS

Egg Ins, porcelain per pair.....	.99 a
DOG BONE, porcelain set of 3.....	1.50 a
HY GAIN #155 center insulator.....	5.95 b
HY GAIN Cycloc end ins per pair.....	3.95 b
MOSLEY dipole center insulator.....	5.75 a

CONNECTORS

PL259 UHF male, 2 per pkg.....	1.59 a
SO239 UHF female chassis mt.....	.69 a
UG175 Adapts RG58 to PL259, pkg 2.....	.59 a
UG176 Adapts RG59 to PL259, pkg 2.....	.59 a
PL258 UHF double female.....	.99 a
DM-SP UHF double male.....	1.69 a
M359 90 deg UHF elbow conn.....	2.10 a
UG88U BNC male for RG58.....	1.49 a
1094 BNC female.....	1.49 a
M358 UHF "T" connector.....	3.95 a
UG255 UHF female to BNC male.....	3.49 a
UG273 BNC female to UHF male.....	2.45 a

DSI

A 550 MHz COUNTER FOR UNDER \$100.00!

\$99⁹⁵

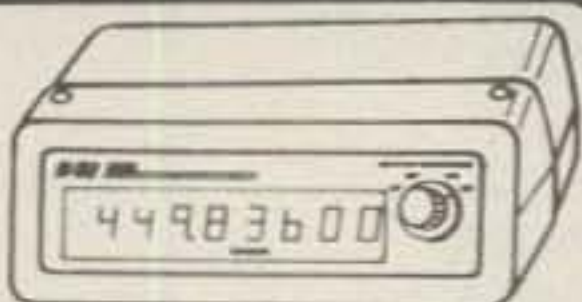

- ONE HOUR easy assembly. • 1 YEAR warrantee
- 8 DIGIT readout • 1 Hz resolution • 12 VDC
- operation • 1/2 INCH LED's • 95% assembled

Whether it's adjusting a 60 Hz. time base, or netting a UHF radio, here's one low cost counter to do it all! Ideal for all types of radios, TV and PLL repair, computer maintenance & construction, and audio amplifier & Receiver repair

3550 Kit.....\$99.95 AC-9 AC Adapter.....\$7.95
T-101 Antenna.....3.95 Shipping & Handling.....2.50

CATALOG SPECIAL — T101 antenna free! A \$3.95 value!

NEW from HY-GAIN!

A \$269.95 Value! **ONLY \$221⁵⁰**
TH5DXX 5 El. 10-15-20 Meter Beam — Rated Full Legal Power Output

HF & VHF BEAMS and VERTICALS



SPECTRONICS, INC.

1009 Garfield St., Oak Park, Illinois • 60304

(312) 848-6777

the antenna
specialists



2 MTR DUCKIES

- Model HM-4. Has 5/16"-32 thread. Fits Motorola HT's, ICOM IC215 and Standard 146A \$7.00
- Model HM-5. Same as above, but with PL-259 connector \$7.00
- Model HM-226. Same, with TNC connector for Wilson 1405 \$18.50
- Model HM-227. Same, but with BNC connector termination \$12.00
- Model HM-228. With F connector for Wilson 1402 & Tempo \$11.50

- HM180 2mtr, 3db trunk lip ant. \$33.50 b
- HM179 2mtr, 3db hole mount ant. 29.00 b
- HM20 2mtr, 3db for marine use. 39.00 b
- HM176 440MHz 5db trunk lip ant. 33.00 b
- HM175 440MHz 5db hole mount ant. 29.00 b
- HM224 220MHz 4db trunk lip ant. 33.50 b



- AR2 2meter Ringo base ant. \$24.95 b
- ARX2 2mtr Ringo Ranger base ant. . . 39.95 c
- AR220 220MHz Ringo base ant. 24.95 b
- ARX220 220MHz Ringo Ranger. 39.95 c
- AR450 UHF Ringo base ant. 24.95 b
- ARX450 UHF Ringo Ranger base ant. . 39.95 c
- AR6 6 meter Ringo base ant. 36.95 c
- ARX2K Adapts 2M Ringo to Ranger . 16.95 b
- A147-4 4 ele 2M FM beam ant. 24.95 b
- A147-11 11 ele 2M FM beam. 36.95 c
- A147-20T 10 ele 2M vert/horz twist. . 62.95 d
- A144-7 7 ele 2M CW/SSB beam. 26.95 c
- A144-11 11 ele 2M CW/SSB beam. 36.95 d
- A144-10T 10 ele Twist OSCAR ant. . . 42.95 c
- A144-20T 20 ele Twist OSCAR ant. . . 62.95 d
- A220-7 7 ele 220MHz beam. 26.95 c
- A220-11 11 ele 220MHz beam. 34.95 c
- A449-6 6 ele UHF FM beam. 24.95 c
- A449-11 11 ele UHF beam. 34.95 c
- A432-11 11el 432MHz SSB/CW beam 34.95 c
- AFM4D 144-148MHz Four Pole. 69.95 c
- AFM24D 220MHz Four Pole. 64.95 c
- AFM44D 435-450MHz Four Pole. 64.95 c
- ASQ-2 2M Squalo horiz ant. 19.95 b
- LAC-1 Coax lightning arrester. 4.95 a
- LAC2- Coax lightning arrester. 4.95 a
- ATB34 ★ 4 ele 20-10mtr beam. 219.95 ★
- ATV3 20-10mtr trap vertical. 49.95 e
- ATV4 40-10mtr trap vertical. 89.95 e
- ATV5 80-10mtr trap vertical. 89.95 e
- A50-3 3 element 6 meter beam. 39.95 d
- A50-5 5 element 6 meter beam. 59.95 e
- A28-3 ★ 3 element 10 meter beam. . 69.95 ★
- A432-20T 432MHz 20 ele twist. 59.95 d

AVERAGE SHIPPING COST GUIDE (Continental U.S.) Items sent UPS whenever possible.

Please estimate the shipping charges for your order. Any excess payment over 25c will be refunded or credited. Underpayment will be billed or sent collect. For insurance add 25c for each \$100.00 value over the first \$100.00.

W/K CALL AREA	1,2,3,4,5	6,7	8,0	9
1 lb.	.90	1.00	.90	.85
5 lbs.	1.50	2.00	1.35	1.20
10 lbs.	2.26	3.20	1.95	1.70
20 lbs.	3.80	5.80	3.20	2.90
30 lbs.	5.30	8.05	4.40	3.50
50 lbs.	8.40	12.90	6.80	5.35

ESTIMATED WEIGHT CODING

After the price of each item you will find a letter, i.e., 19.95 a. To make it easier to figure shipping costs, these letters indicate the approximate weight of the item as follows:

- a. Less than 1 lb.
- b. 1-3 lbs.
- c. 4-6 lbs.
- d. 7-10 lbs.
- e. 10-20 lbs.
- f. 20-30 lbs.
- g. 30-40 lbs.
- h. 40-50 lbs.

NOTE: INTERNATIONAL ORDERS write for Proforma Invoice. ITEMS MARKED ★ will be sent truck collect.

2M BASE ANT. PACKAGE

Here's what you get:

- Cushcraft AR2 Ringo South River.
- PFM71 Roof mount.
- A125-5P 5' alum mast.
- Lag bolts.
- 50' 8U foam coax.
- PL259 coax conn.



\$59⁹⁵

Wt. 16 lbs.

FINCO

The most rugged 6 & 2 meter beams we've seen yet!!

- A 2-10 10 ele, 2M beam \$44.95 d
- A 2-5 5 ele, 2M beam, 9.5db gain. 27.95 c
- A 2-2 10 ele, 2M dual polarization. 46.50 e
- A62 6&2M antenna on one boom. 74.95 e
- A6-5 5 element 6M beam, 11db. 46.50 e
- A6-3 3 ele 6M beam, 7db gain. 30.00 d
- A 1 1/4 220MHz 10 ele, 13.8db. 32.95 d

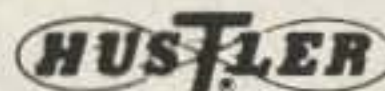

\$9⁹⁵ "BUCK-BUSTER" SF-2 ANTENNA

Fits all Hustler deluxe mobile mounts. 3/8"x24 base 5/8" wave two meters, 3.4 db gain. SWR at resonance: adj to 1.5:1 or better. Bandwidth 6 MHz, 2:1 or better SWR. 100 watts max.

\$79⁹⁵ NEW 4-BTV VERTICAL

One setting covers 10, 15, 20, 40M. Space restricted or unlimited, you get top signal reports, consistent contacts and complete coverage. Add 5th band with a 75M resonator. Use one feedline, any length. Requires no switching or matching devices. 15 lbs.

SF-2

4-BTV

- MO1 Mobile mast \$22.95 c
- MO2 Mobile mast 22.95 c
- RM10 10 Meter resonator. 6.95 b
- RM15 15 meter resonator. 7.95 b
- RM20 20 Meter resonator. 8.95 b
- RM40 40 Meter resonator. 14.95 b
- RM75 75 Meter resonator. 16.95 b
- RM80 80 Meter resonator. 17.95 b
- RM10S 10M resonator 2KW PEP. 11.95 b
- RM15S 15M resonator 2KW PEP. 12.95 b
- RM20S 20M resonator 2KW PEP. 13.95 b
- RM40S 40M resonator 2KW PEP. 16.95 b
- RM75S 75M resonator 2KW PEP. 31.95 b
- RM80S 80M resonator 2KW PEP. 31.95 b
- CG144 5.2db 2mtr ant 3/4 x 24 stud. . 26.95 b
- CGT144 Same but trunk lip mount. . . 42.95 c
- SF2 3db 2mtr ant 3/4 x 24 stud. 9.95 b
- SF220 3db 220MHz ant 3/4 x 24 stud. . 11.95 b
- 4BTV 40-10mtr vertical. 79.95 e
- G6-144 2mtr base ant 6db. 79.95 d
- BM1 Bumper mount 3/4 x 24 thread. . 15.95 d
- RSS2 Mobile resonator spring. 5.95 a
- QD1 Quick disconnect 3/4 x 24. 16.95 a



VERTICAL ANTENNAS

- Model 14AVQ/WB SAVE \$10.00!
- 40 thru 10 meters List
- Wide band performance \$69.95
- New Hy-Q traps

Self-supporting, automatic band switching vertical antenna. Omni-directional performance. Favorable L/C ratio. High-Q. True 1/4 wave resonance on all bands. Low angle radiation pattern. Taper swaged seamless aluminum construction. 12" double-grip mast bracket. Full circumference compression clamps at tubing joints. Weight 8.2 lbs.

Model 14AVQ/WB 59.95

SAVE \$18.00

- Model 18AVT/WB list
- Automatic band switching
- Completely Self-Supporting \$105.00
- Omni-Directional Performance

Three beefed-up Hy-Q traps permit automatic switching 5 band capability. Favorable L/C ratio. Top loading coil. Across the band performance with one furnished setting for each band (10 thru 40). True 1/4 wave resonance on all bands. SWR of 2:1 or less at band edges. Low angle radiation pattern. Extra heavy duty tapered swaged seamless aluminum tubing with full circumference, corrosion resistant compression clamps at tubing joints. Antenna can be mounted without guide wires. 25" high. Weight 10.7 lbs.

Model 18 AVT/WB 87.00

- BN86 Ferrite balun for 80-10mtrs. . . \$15.95 a
- 155 Center insulator for doublet. 5.95 a
- 156 End insul. for doublet (pair) . . . 3.95 a
- 18HT ★ HyTower 80-10M vertical. . . 289.95 ★
- 18V Economy 80 tru 10M vertical. 29.95 c
- 12AVQ 20-10mtr trap vertical. 39.95 c
- 14AVQ 40-10mtr trap vertical. 59.95 d
- 18AVT/WB 80-10mtr trap vertical. . . 87.00 d
- 2BDQ Trap doublet for 80 & 40mtr. . . 49.95 d
- 5BDQ Trap doublet for 80-10mtrs. . . 89.95 e
- TH3 MkIII ★ 3 ele 20-10M tribander. . 189.95 ★
- TH6DXX ★ 6 ele 20-10M tribander. . . 264.95 ★
- TH3 Jr 3 ele tribander (750W PEP) . . 149.95 e
- HY QUAD ★ 2 ele quad 20-10 mtrs. . 229.95 ★
- 103BA 3 element 10Mtr beam. 64.95 e
- 153BA ★ 3 element 15mtr beam. 79.95 e
- 204BA ★ 4 element 20mtr beam. 214.95 ★
- 402BA ★ 2 element 40 mtr beam. 204.95 ★
- 64B ★ 4 element 6 meter beam. 49.95 b
- 270 6db fiberglass 2M antenna. 49.95 b
- 203 3 element 2 meter yagi. 21.95 b
- 205 5 element 2 meter yagi. 17.95 c
- 208 8 element 2 meter yagi. 29.95 c
- 214 14 element 2 meter yagi. 34.95 d

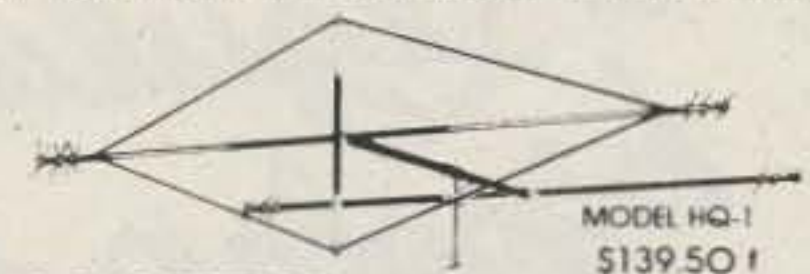

MODEL HQ-1
\$139.50!

CRAMPED FOR SPACE?

Then you want the antenna that's known around the world for its small size and superior performance. The Multiband HYBRID QUAD for 6-10-15 & 20 meters.

- WING SPAN-11 FT.
- BOOM-54 INCHES LONG
- WIND AREA-1.5 SQ. FT.
- 1200 WATTS PEP INPUT TO FINAL
- FEED LINE-50 OHMS

MFJ

GIVE US A TRY ON YOUR MFJ NEEDS. MANY TIMES WE CAN GIVE QUICKER DELIVERY THAN WHEN YOU ORDER DIRECT.

For TRS-80* MODELS I, II

250ns

4 MHz

They're fast, too... none of this 450ns stuff, but true 250ns.

Also compatible with Exidy's Sorcerer, Heath H89, Apple, newer etc.

maybe even some other machines we don't know about

this is certainly worth an exclamation mark. 8 for \$64!!

yes, we really mean 8 for \$64!

*trademark of Tandy Corp.

16K DYNAMIC RAMS

Ltd Qty! 8 FOR \$64!!

add \$3 for 3 dip shunts & instructions

no foolin' -- \$64!!

better do it now, they're going back up again soon.

CLOCK MODULE

\$19.95 *includes case*

Perfect for mobile use; the MA1003 includes a built-in timebase and runs off +12V DC. The matching case mounts easily under dash (hardware included). If you've ever wanted a car clock, this is it.

12V 8 AMP POWER SUPPLY

\$44.50 *kit form*

This is the one, folks... even handles 12A peaks with 50% duty cycle. Crowbar overvoltage protection, current limiting, adjustable 11-14V output, RF suppression, easy assembly, and much more. Please add \$10 shipping - excess refunded. *Oh yes -- case and line cord are not included*

Regulated, bipolar power supply kit \$15

±250 mA minimum; specify ±5, ±6, ±8, ±9, ±12V, or ±15V

We stock Vector products, some of the best computer peripherals in the business, and lots more. Send for our free flyer!

GODBOUT

GODBOUT ELECTRONICS

BLDG. 725, OAKLAND AIRPORT, CA 94614 (415) 562-0636

TERMS: Cal res add tax. Allow 5% for shipping, excess refunded. VISA®/Mastercharge® call our 24 hour order desk at (415) 562-0636. COD OK with street address for UPS. Prices good through cover month of magazine.

Continuity Tester and Flashlight

Convenient versatile tool for quickly checking continuity of dead circuits, switches, appliances, cords, fuses, motors, control equipment, coils and panel boards. Also tests circuits for low-resistance shorts and helps identify wires in multi-wire cables. Dozens of other uses. Plus the added convenience of a handy, durable flashlight. Uses two AA size penlight batteries (not furnished). Insulated clip prevents accidental shorting to case. Alligator clip has 48" lead with plug.



RT300 **\$7.95**

CONTINENTAL SPECIALTIES

Logic Monitor

The Logic Monitor allows you to check logic levels on all 16 pins of any DTL, HTL, TTL, or CMOS device. It has a typical input impedance of 100K ohms and weighs a mere 3 oz. (85 grams). It has an input volt. range of 4V to 15V and draws a max. of 100mA@10V



LM-1 **\$70.00**

Proto Clips

14-PIN CLIP PC-14 \$ 4.50
 16-PIN CLIP PC-16 \$ 4.75
 24-PIN CLIP PC-24 \$10.00
 40-PIN CLIP PC-40 \$16.00

Proto Boards

PB-6 \$17.95
 PB-100 19.95
 PB-101 22.95
 PB-102 26.95
 PB-103 44.95
 PB-104 55.95
 PB-203 99.95
 PB-203A 155.00
 PB-203A-Kit 131.00

Jumbo 6-Digit Clock Kit

- Four .630"ht. and two .300"ht. common anode displays
- Uses MM5314 clock chip
- Switches for hours, minutes and hold functions
- Hours easily viewable to 30 feet
- Simulated walnut case
- 115VAC operation
- 12 or 24 hour operation
- Includes all components, case and wall transformer
- Size: 6 1/2" x 3 1/4" x 1 3/8"

JE747 **\$29.95**

JE701

- Bright .300 ht. comm. cathode display
- Uses MM5314 clock chip
- Switches for hours, minutes and hold modes
- Hrs. easily viewable to 20 ft.
- Simulated walnut case
- 115 VAC operation
- 12 or 24 hr. operation
- Incl. all components, case & wall transformer
- Size: 6 1/2" x 3-1/8" x 1 1/4"

6-Digit Clock Kit **\$19.95**

Regulated Power Supply

Uses LM309K. Heat sink provided. PC board construction. Provides a solid 1 amp @ 5 volts. Can supply up to ±5V, ±9V and ±12V with JE205 Adapter. Includes components, hardware and instructions. Size: 3 1/2" x 5" x 2"H

JE200 **\$14.95**

ADAPTER BOARD
 -Adapts to JE200-
 ±5V, ±9V and ±12V

DC/DC converter with +5V input. Toroidal hi-speed switching XMR. Short circuit protection. PC board construction. Piggy-back to JE 200 board. Size: 3 1/2" x 2" x 9/16"H

JE205 **\$12.95**

MICROPROCESSOR COMPONENTS

8080/8085 SUPPORT DEVICES		MICROPROCESSOR MANUALS	
8080A CPU	\$ 7.95	M-280 User Manual	\$7.50
8212 8-Bit Input/Output	3.25	M-CDP1802 User Manual	7.50
8214 Priority Interrupt Control	5.95	M-2650 User Manual	5.00
8216 Bi-Directional Bus Driver	3.49		
8224 Clock Generator/Driver	3.95		
8226 Bus Driver	3.49		
8228 System Controller/Bus Driver	4.95		
8238 System Controller	5.95		
8251 Prog. Comm. 1/0 (USART)	7.95		
8253 Prog. Interval Timer	14.95		
8255 Prog. Paraph. 1/0 (PPI)	9.95		
8257 Prog. DMA Control	19.95		
8259 Prog. Interrupt Control	19.95		
8080/8085 SUPPORT DEVICES		ROM'S	
MC6800 MPU	\$14.95	2513(2140) Character Generator(upper case)	\$9.95
MC6802CP MPU with Clock and Ram	24.95	2513(3021) Character Generator(lower case)	9.95
MC6810API 128K Static Ram	5.95	2516 Character Generator	10.95
MC6821 Paraph. Inter. Adapt (MC6820)	7.49	MMS230N 2048-Bit Read Only Memory	1.95
MC6828 Priority Interrupt Controller	12.95		
MC6830L 1024X8 Bit ROM (MC6830-8)	14.95		
MC6850 Asynchronous Comm. Adapter	7.95		
MC6852 Synchronous Serial Data Adapt.	9.95		
MC6860 0-600 bps Digital MODEM	12.95		
MC6862 2400 bps Modulator	14.95		
MC6860A Quad 3-State Bus. Trans. (MC6826)	2.25		
MICROPROCESSOR CHIPS—MISCELLANEOUS		RAM'S	
Z80(780C) CPU	\$14.95	1101 256X1 Static	\$1.49
Z80A(780-1) CPU	16.95	1103 1024X1 Dynamic	.99
CDP1802 CPU	19.95	2101(R101) 256X4 Static	3.35
2650 MPU	19.95	2102 1024X1 Static	1.75
6502 CPU	11.95	2102 1024X1 Static	1.85
8035 8-Bit MPU w/clock, RAM, 1/0 lines	19.95	2111(8111) 256X4 Static	3.95
P9085 CPU	19.95	2112 256X4 Static MOS	4.95
TMS9900L 16-Bit MPU w/hardware, multiply & divide	49.95	2114 1024X4 Static 450ns	7.95
SHIFT REGISTERS		2114-3 1024X4 Static 450ns low power	10.95
MMS00H Dual 25 Bit Dynamic	\$ 5.50	2114-3 1024X4 Static 300ns	10.95
MMS02H Dual 50 Bit Dynamic	.50	2114L-3 1024X4 Static 300ns low power	11.95
MMS04H Dual 16 Bit Static	.50	5101 256X4 Static	7.95
MMS06H Dual 100 Bit Static	.50	5280/2107 4096X1 Dynamic	4.95
MMS10H Dual 64 Bit Accumulator	.50	7489 16X4 Static	1.75
MMS016H 500/512 Bit Dynamic	.89	74S200 256X1 Static Tristate	4.95
2504T 1024 Dynamic	3.95	93421 256X1 Static	2.95
2518 Hex 32 Bit Static	4.95	UPD414 4K Dynamic 16 pin	4.95
2522 Dual 132 Bit Static	2.95	(MK4027)	
2524 512 Static	.99	UPD416 16K Dynamic 16 pin 250ns	9.95
2525 1024 Dynamic	2.95	(MK4116)	
2527 Dual 256 Bit Static	2.95	TMS4044 4K Static	14.95
2528 Dual 250 Static	4.00	49N1 49N1	
2529 Dual 240 Bit Static	4.00	TMS4045 1024X4 Static	14.95
2532 Dual 80 Bit Static	2.95	2117 16,384X1 Dynamic 350ns	9.95
3341 File	6.95	MMS262 20X1 Dynamic	4/1.00
74LS670 4Kx Register File (TriState)	2.49		
UART'S		PROM'S	
A-Y-5-1013 30K BAUD	5.95	1702A 2048 FAMOS	\$5.95
		2718INTEL 15K* EPROM	\$9.95
		TMS2516 16K* EPROM	49.95
		(2716) *Requires single +5V power supply	
		TMS2532 4KX8 EPROM	69.95
		2708 8K EPROM	10.95
		2716 T.1 16K** EPROM	29.95
		**Requires 3 voltages, -5V, +5V, +12V	
		5203 2048 FAMOS	14.95
		8301-1(7811) 1024 Tristate Bipolar	3.49
		8330-1(7602) 256 Open C Bipolar	2.95
		82S23 32X8 Open Collector	3.95
		82S115 4096 Bipolar	19.95
		82S123 32X8 Tristate	3.95
		74186 512 TTL Open Collector	9.95
		74188 256 TTL Open Collector	3.95
		74S287 1024 Static	2.95

JE600 HEXADECIMAL ENCODER KIT

FEATURES:

- Full 8 bit latched output for microprocessor use
- 3 User Define keys with one being bi-stable operation
- Debounce circuit provided for all 19 keys
- LED readout to verify entries
- Easy interfacing with standard 16 pin IC connector
- Only -5VDC required for operations

FULL 8 BIT LATCHED OUTPUT—19 KEYBOARD

The JE600 Encoder Keyboard provides two separate hexadecimal digits produced from sequential key entries to allow direct programming for 8 bit microprocessor or 8 bit memory circuits. Three (3) additional keys are provided for user operations with one having a bistable output available. The outputs are latched and monitored with LED readouts. Also included is a key entry strobe.

JE600 **\$59.95**
 Hexadecimal Keypad only **\$14.95**

DIGITAL THERMOMETER KIT

FEATURES:

- Dual sensors—switching control for indoor/outdoor or dual monitoring
- Continuous LED .8" ht. display
- Range: -40°F to 199°F / -40°C to 100°C
- Accuracy: ±1° nominal
- Set for Fahrenheit or Celsius reading
- Sim. walnut case - AC wall adapter incl.
- Size: 3-1/4"H x 6-5/8"W x 1-3/8"D

JE300 **\$39.95**

62-Key ASCII Encoded Keyboard Kit

FEATURES:

- 60 Keys generate the full 128 characters, upper and lower case ASCII set
- Fully buffered
- 2 user-define keys provided for custom applications
- Caps lock for upper case only alpha characters
- Utilizes a 2376 (40 pin) encoder read only memory chip
- Outputs directly compatible with TTL/DTL or MOS logic arrays
- Easy interfacing with a 16-pin dip or 18-pin edge connector

JE610 **\$79.95**
 62-Key Keyboard only . . **\$34.95**

HICKOK LX303 Portable LCD Digital Multimeter

- Big 1 1/2 inch high, 2 1/2 Digit Liquid Crystal Display
- Over 200 Hours of operation with a 9V battery
- Automatic zero, polarity and average indication
- 100mV DC F.S. sensitivity
- 1% basic accuracy
- 10 ranges and functions
- Rugged Ceraclon® case and removable cover, stores test lead set.
- Full only year warranty.

SPECIFICATIONS: DC volts 5 ranges: 0.1 to 1000V. Accuracy: ±0.5% (up to 100V), ±1% (above 100V). AC Volts 10 ranges: 0.1 to 600V. Accuracy: ±1.0% (up to 100V), ±1.5% (above 100V). Max. range: 600V. Resistance 18 Low Power Ranges: 0.1 to 200KΩ. Accuracy: ±0.5% (up to 100Ω), ±1% (above 100Ω). Capacitance 18 ranges: 0.1 to 100µF. Accuracy: ±1.0% (up to 10µF), ±1.5% (above 10µF). Dimensions and Weight: 3.75" x 3.38" x 1.25", 8.5oz. POWER: 9V battery (not included) or Mocket AC Adapter. READ RATE: 2/sec.

LX303 Digital Multimeter **\$74.95**

PART NO.	DESCRIPTION	PRICE
RC-3	115V AC ADAPTER	7.50
CC-3	PADDED CARRYING CASE	7.50
VP-10	X10 DC PROBE ADAPTER (Up to 10K)	14.95
VP-40	40kV DC PROBE	35.00
CS-1	10 Amp DC Current Shunt	14.95

Jameco ELECTRONICS

MAIL ORDER ELECTRONICS — WORLDWIDE
 1355 SHOREWAY ROAD, BELMONT, CA 94002
 ADVERTISED PRICES GOOD THRU FEBRUARY

PHONE ORDERS WELCOME (415) 592-8097

The Incredible "Pennywhistle 103"

\$139.95 Kit Only

The Pennywhistle 103 is capable of recording data to and from audio tape without critical speed requirements for the recorder and it is able to communicate directly with another modern and terminal for telephone "hamming" and communications. In addition, it is free of critical adjustments and is built with non-precision, readily available parts.

TRS-80 16K Conversion Kit

Expand your 4K TRS-80 System to 16K. Kit comes complete with:
 • 8 each UPD416-1 (16K Dynamic Rams) 250NS
 • Documentation for conversion

TRS-16K **\$75.00**

JUST WRAP™

• 30 AWG wire • .025" square posts
 • Daisy chain or point-to-point • Built-in cut off
 • No stripping or slitting required—just wrap

Part No.	Wire Color	Price
JW-1-B	Blue	\$14.95
JW-1-W	White	14.95
JW-1-Y	Yellow	14.95
JW-1-R	Red	14.95

JUST WRAP™ Replacement Wire

Part No.	Color	Length	Price
R-JW-B	Blue	50 ft. roll	\$2.98
R-JW-W	White	50 ft. roll	2.98
R-JW-Y	Yellow	50 ft. roll	2.98
R-JW-R	Red	50 ft. roll	2.98

JUST WRAP™ Unwrap Tool \$3.49

JUST WRAP™ Kit • 50 ft. ea.: blue, white, red, yellow wire
 • JUST WRAP Tool • Unwrapping Tool

JWK-6 **\$24.95**

Vacuum Vise

Vacuum-based light-duty vise for small components and assemblies. ABS construction. 1 1/2" jaws, 1 1/4" travel. Can be permanently installed.

VV-1 **\$3.49**

EPROM Erasing Lamp

- Erases 2708, 2716, 1702A, 5203Q, 5204Q, etc.
- Erases up to 4 chips within 20 minutes.
- Maintains constant exposure distance of one inch
- Special conductive foam liner eliminates static build-up
- Built-in safety lock to prevent UV exposure
- Compact — only 7-5/8" x 2-7/8" x 2"
- Complete with holding tray for 4 chips

UVS-11E **\$69.95**

JOYSTICK

- 2 each 100K pots (Linear Taper)
- Printed Circuit Board Mount
- Size: 1" x 1-3/16" x 1-3/16"

JOYSTICK **\$4.95**

ASSOCIATED RADIO

913-381-5900

8012 CONSER BOX 4327
OVERLAND PARK, KANSAS 66204



CALL US WITH YOUR REQUIREMENTS
AMERICA'S NO. 1 Real Amateur Radio Store



**(Associated Wants to TRADE - BUY - SELL
GOT YOUR BEST DEAL? THEN CALL US AT
913-381-5900 - NO TRADE? ASK FOR EXT. 12)**

**NOTE: SEND \$1.00 FOR OUR CURRENT CATALOG
OF NEW AND RECONDITIONED EQUIPMENT.**

*** ALSO WE PERIODICALLY PUBLISH A LIST OF
UNSERVICED EQUIPMENT AT GREAT SAVINGS.
A BONANZA FOR THE EXPERIENCED OPERATOR.
TO OBTAIN THE NEXT UNSERVICED BARGAIN LIST,
SEND A SELF ADDRESSED STAMPED ENVELOPE.**

POLY PAKS "SHOP BY MAIL" WITH ITS NEW INFLATION FIGHTIN'

'ONE CENTERS'



SALE *Buy any item on this page and get 2nd item of the same cat. no. for only one penny!

- 40-TWO WATT RESISTORS, carbo-films, carbons, some 5%ers, (#456) 1.29 80 for 1.30
- 50-TERMINAL STRIPS, asst'd solder and screw types, 2 lugs & up, (#334) 1.29 100 for 1.30
- 1-WATCH GUTS, LED, who knows how good, micro-digital bonanza, (#5115) 1.29 2 for 1.30
- 10-1000V 1A RECTIFIERS, 1N4007, epoxy case, axial leads, (#5926) 1.29 20 for 1.30
- 6-25 WATT PLASTIC POWER, 2N6100 series, TO-220, 200bvcb0, 3A, (#1786) 1.29 12 for 1.30
- 4-CALCULATOR AC JACKS, 3 terminals, takes mini plug, (#2316) 1.29 8 for 1.30
- 65-PRE-FORM 1/4 WATTERS, popular values, for PC appl., (#2444) 1.29 130 for 1.30
- 200-PC BOARD PARTS, boards loaded w/100% parts, hobby bonanza, (#5946) 1.29 400 for 1.30
- 40-LOW NOISE RESISTORS, 1/8 & 1/2 W, oxide & magnetic film, (#220) 1.29 80 for 1.30
- 40pc-SEMI-CON SURPRISE, asst. zeners, diodes, etc. untested, (#2226) 1.29 80 for 1.30
- 20-TRANSISTOR ELECTROLYTICS, asst. voltages from 5-100 mtd, (#453) 1.29 40 for 1.30
- 1-LASCR OPTO COUPLER, type H11C3, mini dip, (#5700) 1.29 2 for 1.30
- 10-UPRIGHT ELECTROS, 100% asst'd values and voltages, (#5900) 1.29 20 for 1.30
- 2-GE 3W AUDIO AMP, type PA-263 IC chip, mono, (#1522) 1.29 4 for 1.30
- 1-MERCURY TILT SWITCH, N.C. rated 24VDC @ .05A, w/leads, (#5686) 1.29 2 for 1.30
- 50-CAP SPECIAL, asst. values in mylar, mica, ceramic, disc, etc., (#3775) 1.29 100 for 1.30
- 40-FEEDTHRU CAPACITORS, used for hams, RF, UHF circuitry, (#5688) 1.29 80 for 1.30
- 40-PLASTIC TRANSISTORS, asst'd untested and hobby, (#2604A) 1.29 80 for 1.30
- 6-6V INDICATORS, w/leads, test lamp manufacturers excess, (#5893) 1.29 12 for 1.30
- 4-12 VOLT LAMPS, w/leads, popular voltage, 100's of uses, (#5942) 1.29 8 for 1.30
- 1-12 VDC SOLENOID, similar to Guardian 16-P, w/plunger, 1/2" stroke, (#6013) 1.29 2 for 1.30
- 1-TV/AUDIO SHIELDED CABLE, 2 cond, 15 ft, w/RCA phone plugs, (#5812) 1.29 2 for 1.30
- 10-POWER TAB TRANSISTORS, NPN, plastic, TO-220, (#5629) 1.29 20 for 1.30
- 6-PRECISION TRIM POTS, asst'd singles and multi-turns, untested, (#3389) 1.29 12 for 1.30
- 20-1N4148, 4 NANO, SWITCHING DIODE, axial leads 10mA, 100%, (#3000) 1.29 40 for 1.30
- 2-5.1V STUD ZENER, 10W, DO-4, 5% tol, Motorola 10MS or equiv, (#5287) 1.29 4 for 1.30
- 4-PUSHBUTTON ALARM SWITCH, 125 VAC 1A SPST, NC, (#5289) 1.29 8 for 1.30
- 6-CABLE & PLUG SET, 2 cond, 3.5mm mini plug w/6 polarized cable, (#5737) 1.29 12 for 1.30
- 5-"SUPER" 2N2222, NPN, ICBO:60V, hfe:100 1W @ 2A, TO-92, 100%, (#5952) 1.29 10 for 1.30
- 10-RESISTOR NETWORKS, assorted values in dips and singles, (#5699) 1.29 20 for 1.30
- 4-VARACTOR DIODES, var. tuner capacitance, 20-50 pf, (#5887) 1.29 8 for 1.30
- 50-PRECISION RESISTORS, 1/2, 1, & 2 watts, 1%, assorted types, (#363) 1.29 100 for 1.30
- 60-CERAMIC CAPS, asst'd val. & styles, incl. tubulars, NPO's, etc., (#590) 1.29 120 for 1.30
- 30-MOLEX CONNECTORS, nylon, asst'd styles, colors, & = of cond, (#5835) 1.29 60 for 1.30
- 10-IF-FM OP AMPS, by RCA, FM-UHF circuitry, TO-5, 10 leads, (#5951) 1.29 20 for 1.30
- 4-ROCKER SWITCHES, DPDT, solder eyelet terminals, (#3302) 1.29 8 for 1.30
- 1-RELAY, BABCOCK 6VDC, SPST, plastic case, (#5807) 1.29 2 for 1.30
- 1-25 AMP BRIDGE RECTIFIER, 50 volts, 100%, (#5948) 1.29 2 for 1.30
- 50-1N4000 RECTIFIERS, epoxy, axial leads, untested, (#2594) 1.29 100 for 1.30
- 30pc-HEAT SHRINK, Thermo-fit, useful asst. of sizes, shrinky 50%, (#5248) 1.29 60 for 1.30
- 10-SLIDE SWITCHES, SPST, SPDT, etc. all shapes and sizes, (#5927) 1.29 20 for 1.30
- 25-DTL's, 100% prime, asst'd flip flops, etc., marked, (#3709) 1.29 50 for 1.30
- 10-MAN-3's, 7 segment, w/bubble magnifier, 100% material, (#3842) 1.29 20 for 1.30
- 4-PL-259 COAX PLUG, mates to SO-239, Amphenol, (#5221) 1.29 8 for 1.30
- 1-LITE SENSITIVE UNIJUNCTION TRANSISTOR, programmable, (#5719) 1.29 2 for 1.30
- 100-PRE-FORMED 1/2 WATTERS, popular values, some 5 & 10 %ers, (#1060) 1.29 200 for 1.30
- 4-PHOTO ELECTRIC DARLINGTON TRANSISTORS, (#3276) 1.29 8 for 1.30
- 40-POWER RESISTORS, assorted types, includes 2 to 10 watters, (#228) 1.29 80 for 1.30
- 15-NE-2 LAMPS, neon red, for 110VAC, less resistor, (#1435) 1.29 30 for 1.30
- 30-"CRIMP-ON" TERMINALS, rings and spades, for # 12-20 wire, (#3955) 1.29 60 for 1.30
- 50-ONE-WATT RESISTORS, popular assort, some 5%ers, 100's of uses, (#3844) 1.29 100 for 1.30
- 30-FT. WIRE-WRAP WIRE, 30 gauge, insulated, continuous length, (#3803) 1.29 60 for 1.30
- 6-SPDT MICRO SLIDE SWITCH, only 3/7" cube, for PC mount, (#3429) 1.29 12 for 1.30
- 10-PR-RCA PLUGS & JACKS, for audio, speakers, etc., (#402) 1.29 20 for 1.30
- 5-2N3055 HOBBY TRANSISTORS, TO-3, (#3771) 1.29 10 for 1.30
- 6-SINGLE PIN MICRO GREEN LEDS, 3V, 10 mils, "pin heads", 100%, (#6126) 1.29 12 for 1.30
- 6-JUMBO RED LEDS, 1.5-3 V @ 10 mA, 100% material, 100's of uses, (#2135) 1.29 12 for 1.30
- 6-MAGNETIC DISCS, shatter-resistant Plastalloy, 13/16" dia, (#6099) 1.29 12 for 1.30
- 5-PHOTO CELLS, Vactec 900, disc type, R: 2K ohm (dark) w/leads, (#6135) 1.29 10 for 1.30
- 1-12VDC SPDT RELAY, 180 ohm coil, 25 mA, 1x1x1 1/2" sealed, (#5937) 1.29 2 for 1.30
- 10-VOLUME CONTROLS, asst. values, audio, and switch too! (#592) 1.29 20 for 1.30
- 60-PREFORMED DISC CAPS, handy assortment of values, marked, (#1181) 1.29 120 for 1.30
- 10-AXIAL ELECTROS, assorted values and capacitance, (#5901) 1.29 20 for 1.30
- 2-DOUBLE-SIDED PC BOARDS, 3"x12" high quality G-10 glass, (#5694) 1.29 4 for 1.30
- 60-TUBULAR CAPACITORS, asst'd 100mmf to 1mf to 600 WVDC, (#35A219) 1.29 120 for 1.30
- 6-MICRO MINI REED SWITCHES, 1" long, for alarms, relays, etc., (#1258) 1.29 12 for 1.30
- 10-TANTALUM ELECTROS, asst'd mini, axial, hermetically sealed, (#5848) 1.29 20 for 1.30
- 50-DISC TYPE CAPS, incl: NPO, hi-Q, mylar, ceramics, asst'd values, (#437) 1.29 100 for 1.30
- 60-COILS & CHOKES, asst'd RF, OSC, IF, parasitic types, (#35A297) 1.29 120 for 1.30
- 6-SWITCHCRAFT PHONO JACKS, hi-Q, chassis mount, teflon base, (#5119) 1.29 12 for 1.30
- 30-SUBMINI IF TRANSFORMERS, slug tuned, shielded, (#35A9) 1.29 60 for 1.30
- 40-ADJUSTABLE FERRITE CORES, center cut for hex adjust, (#5701) 1.29 80 for 1.30
- 10-PC TRIMPOTS, screwdriver adjust, assorted values, (#3346) 1.29 20 for 1.30
- 25-4" CABLE TIES, plastic, like Ty-wrap style, (#5217) 1.29 50 for 1.30
- 5-CRYSTALS, may include; CB, ham various shapes and sizes, (#5716) 1.29 10 for 1.30
- 3-MICRO SWITCHES, SPST, NO contacts, plunger style, solder tabs, (#5785) 1.29 6 for 1.30
- 65-MOLEX SOCKETS, "on-a-strip", for 8-40 pin ICs, (#1609) 1.29 130 for 1.30
- 6-PAIRS 9V BATTERY CLIPS, w/red & black color-coded leads, (#2852) 1.29 12 for 1.30
- 6-LM340T VOLTAGE REGULATORS, 5 to 24 volts, TO-220, (#5897) 1.29 12 for 1.30
- 40-POLYTYRENE CAPACITORS, asst'd values and voltages, (#1052) 1.29 80 for 1.30
- 15-THERMISTORS, resistors that change with the temperature, (#2048) 1.29 30 for 1.30
- 65-1/4 WATT RESISTORS, asst'd values, metal film, marked, (#5797) 1.29 130 for 1.30
- 10-MODULAR SWITCHES, Centralab "push-on" type, up to 4PDT, (#3150) 1.29 20 for 1.30
- 5-"MOTORS MOTORS", small, high speed, asst'd sizes, 3-6VDC, (#2551) 1.29 10 for 1.30
- 50-MICAS asst. sizes-n-shapes, incl. "silvers" too! (#373) 1.29 100 for 1.30
- 10-TRANSISTOR SOCKETS, for npn and pnp types, (#5944) 1.29 20 for 1.30
- 4-HOBBY VOLTAGE REGULATORS, LM-309, 320, 340's, TO-3, (#3330A) 1.29 8 for 1.30
- 12-PANEL SWITCHES, assorted slides, rotaries, modulars, etc, (#295) 1.29 24 for 1.30
- 60-RESISTOR SPECIAL, 1/2 to 1 watt, carbons, carbo-films, etc., (#35896) 1.29 120 for 1.30
- 65-HALF WATT RESISTORS, asst'd, carbons, carbo-films, various values, (#454) 1.29 130 for 1.30
- 10-MV-54 MICRO-MINI LEDS, single pin - diffused red lens, (#1802) 1.29 20 for 1.30
- 15-HUMBUCKER CONTROLS, assorted values, manufacturers dump, (#3807) 1.29 30 for 1.30
- 1-POWER TAB TRIAC, 100% prime, 400 V 10A TO-220, (#6216) 1.29 2 for 1.30

4-DIGIT HY GAIN LED CLOCK KIT

\$14.99 2 FOR \$15

• Giant 0.5" high LED digits
• Colon "pulsating" second indicator
• AM-PM indicators!

Cat. No. 92CU6320

7 PC set

Telephone Handset

only **\$8.99**
2 for \$9

Cat. No. 92CU6142

12 VOLT ROTARY SOLENOID

\$6.99 each
2 for \$7

Similar to Ledex model 1E, combines SPST, SP3T, & DP3T in a single device. Interior shaft rotates 360° in 12 "steps". Unit switches 1 "step" when 12V surge is applied. Rated: 12 VDC @ 1.25A, only 1-3/8" dia. x 2-3/8". Metal encased. Color-coded wires extend from front. Uses standard rotary contact wafer system. Wt: 7 oz. With specs.

Cat. No. 92CU8052

5 WATT MONO AMPLIFIER

\$6.99
2 for \$7

These popular, multi-purpose units require 12 VDC to produce 4.5W RMS, (5W max.) into 4 ohms from 20-40 KHz. THD:0.8% @ 2W @ 1 KHz. Other features include: heat-sinked SGS/ATES TBA-641B amp chip, concentrically mounted ON/OFF-VOL and TONE controls, and dual source input capability. Size: 2-1/8 x 4 1/4 x 1 1/4". Wt: 4 oz w/hookup sheet.

Cat. No. 92CU5681

Buy Two for Stereo

HY - GAIN ONE ARM BANDIT MIKES

Only **\$14.99**
2 FOR \$15

Cat. No. 92CU5886

Take one hand command of your mobile or base rig with Hy-Gain's One Arm Bandit Mike. ON/OFF, VOLUME, SQUELCH, CHANNEL SELECTOR, SPEAKER, and DIGITAL DISPLAY are all conveniently located where your fingers do the talking. Comes with 6 ft. multi-conductor, color-coded, coiled cable, (separate) for easy integration into any type of rig. Size: 4 1/4" x 2 1/4" x 1 1/4". Wt. 9 oz.

40 CHANNEL CB BOARD

only **\$14.99**
2 FOR \$15

Poly Paks buys up factory close-out from Hy-Gain so you gain! Boards have: Heatsinked 9 Watt Amp Chip, RF and Mod. Transistors, and Motorola MC series PLL. May be used for 10 meter conversion, (see continuing series "CB to 10" in 73 magazine). The parts alone make it an offer you can't refuse. Wt. 9 oz.

Cat. No. 92CU5554

WITH SWITCH

25 AMP BRIDGE RECTIFIERS

PIV	SALE	2 FOR
25	1.25	1.26
50	1.95	1.96
100	2.25	2.26
200	2.95	2.96
400	3.50	3.51
600	4.25	4.26
800	4.95	4.96

Order by Cat. No. 2273 & voltage

LEDS! LEDS! LEDS!

YOUR CHOICE
5 for \$1.29
10 for \$1.30

Cat. No. Type

1802	MICRO SINGLE PIN RED
1948	MICRO YELLOW
2135	JUMBO RED
2136	JUMBO TAPER RED
2137	MICRO RED
1944	Jumbo Yellow
2138	Jumbo Green

ULTRASONIC TRANSDUCER

\$3.98
2 for \$3.99

Cat. No. 92CU5375

1N4000 Epoxy Rectifiers

Cat. No.	Type	Volts	10 for	20 for	50 for	100 for	1C SALE!
2377	1N4001	50	10 for	.75	20 for		\$.76
2378	1N4002	100	10 for	.85	20 for		.86
2379	1N4003	200	10 for	.95	20 for		.96
2380	1N4004	400	10 for	1.19	20 for		1.20
2381	1N4005	600	10 for	1.39	20 for		1.40
2382	1N4006	800	10 for	1.49	20 for		1.50
2383	1N4007	1000	10 for	1.59	20 for		1.60

3 ELEMENT 120 VAC HOTPLATE

2 FOR \$4
\$3.99

This Top Quality, Multi-Purpose Hotplate features: Built-In Thermostat, Neon "Red" AC Indicator Lamp, and 1/8" Textured Glass Surface for even heat distribution. Generates up to 150° C. 120 watts! Use for photographic applications, laboratory work, aquarium heater, plants, etc. Size: 10-3/8" x 5-3/8" x 1/8". Wt. 1 lb. 2 oz. Cat. No. 92CU5723

"TIE-PIN" CONDENSER MIKE

\$3.95
2 for \$3.96

It's a little giant in sound quality. Metal encased, and omnidirectional. Frequency response 20-20,000 Hz. Lens tie pin or lapel clip. 600 ohm impedance. 1.5 VDC.

1/2" Dia. x 1/2"
• 20-20K Response
No. 92CU5730

PLESSEY WHITE BLOCK

10 per value **\$1.29** UPRIGHT CAPS
20 FOR \$1.30
Cat. No. 92CU5389 • 100 VDC • CERAMIC

MFD.	MFD.	MFD.
.001	.01	.068
.0022	.015	.1
.0033	.02	.12
.0047	.022	.124
.0056	.033	.27
.0068	.047	.47

THUMB WHEEL POTS

ORDER BY CAT. NO. AND RATING

6 for \$1.29	12 for \$1.30	
100 ohm	1K	100K
150 ohm	5K	200K
200 ohm	10K	250K
250 ohm	20K	500K
500 ohm	25K	1 meg
2500 ohm	50K	5 meg
100 ohm	10K	500K
250 ohm	20K	1 meg
500 ohm	25K	2 meg
1K	50K	2.2 meg
2K	100K	3 meg
2500 ohm	150K	4 meg
5K	250K	5 meg

UPRIGHT 92CU3363

SNAP-IN 92CU3362

SEND FOR FREE CATALOG

POLY PAKS®

P.O. BOX 942-A2
SO. LYNNFIELD, MA 01940

HOW TO ORDER
We honor MASTERCHARGE, VISA, check, and COD, (25% down). Order by phone or mail. Minimum order \$8. Please state Cat. No. & description, name & month of magazine. Canadian; add \$5, Foreign; add \$10 (US funds). Excess will be returned. TERMS: add postage. RATED: Not-30. Phone: (617) 245-3828

7294 N.W. 54 STREET
MIAMI, FLORIDA 33166

SURPLUS ELECTRONICS CORP. ✓S43

PHONE: (305) 887-8228
TWX: 810-848-6085
WHOLESALE - RETAIL

<p>PL259 or SO239 Quality American Made 10/\$5.00 100/\$35.00 50/\$20.00 1000/\$300.00</p>	<p>CB SPECIAL Brand new printed circuit board assembly. Used in all HyGain 40 Channel CB transceivers. Fits many other manufacturers' units also. Squelch pot/volume control/channel selector switch not included. Board Dimensions 6" x 6 1/2" 1-9 - 7.50 ea. 50-99 - 6.00 ea. 10-49 - 6.50 ea. 100-up - 5.50 ea.</p>		<p>TRIMMER CAPS Can fit in your watch 3.5-20 pF & 5-30 pF \$.75 ea., 2/\$1.25 5/\$3.00</p>																																																																																																												
<p>E. F. Johnson NICAD 12.0 V. 1.2 AH @ 10 hr rate 4 1/2" x 1 7/8" x 1 3/4" \$1495ea.</p>	<p>CB SPECIAL W/40 ch SW same as above 1-9 \$10.50 ea. 50-99 \$9.00 ea. 10-49 \$9.50 ea. 100-up \$8.50 ea.</p>		<p>POLY FOAM COAX 50 Ohm Low Loss = to RG174 \$.49/100' \$3.00/50'</p>																																																																																																												
<p>E. F. Johnson S Meter Edge Meter 250 UA. Fits in 5/8" x 1-3/8" hole. MTG holes on each end 1-1/4" behind panel. Black scale 0-5 bottom 1-20 top \$1.25 ea. 5/\$5.00</p>	<p>Serviceman Special New Hy-Gain 40ch CB Less Case. Speaker & Knobs (as is) \$14.95 ea</p>		<p>ULTRASONIC TRANSDUCER Detects sound above the range of human hearing! Transmits & receives \$2.50 ea. 5/\$10.00</p>																																																																																																												
<p>E. F. Johnson Signal Strength Meter 200 UA 2 1/2" x 2 1/2" Sq. mounts in 1 1/4" hole 1" behind panel. Scale: 1-30 db top 0-5 bottom. \$4.95ea 5/\$20.00</p>	<p>NEW Hy-Gain Remote 40ch CB Less Case. Speaker & Control Mic (as is) \$14.95 ea</p>	<p>NEW E.F. Johnson Power Mic/Less Cord. Desktop Style \$19.95 ea</p>	<p>MAGNETIC PICK UP TRANSDUCER Converts motion to ac voltage without mechanical linkage 3/8" x 2" w/6' shielded cable \$4.95 ea.</p>																																																																																																												
<p>PANEL METERS \$4.00 ea 2 for \$7.00 25-0-25 dc volts } 2 1/4" x 3" 0-20 dc volts } 0-25 dc volts } 2 1/4" x 2 1/4" 0-50 ac volts } -Shunt Required-</p>	<p>ASTATIC T-UG8-D104 PREAMP Desktop microphone w/crystal element 3 Pin Plug \$35 ea.</p>	<p>CERAMIC IF FILTERS EFC L455K \$3.50 ea.</p>	<p>SOLDERLESS TEST PROD (BLACK) Threaded type, molded handle \$.40 ea. 10/\$3.50</p>																																																																																																												
<p>Double Row/Wire Wrap .100 25 pins \$3.49 ea 10/\$30.00 30 pins \$3.96 ea 10/\$32.00 50 pins \$5.43 ea 10/\$45.00</p>	<p>50' MODEM CABLES 13#22ga wire w/shield, DB25P conn & DB51226-1 cover on one end \$7.50 ea.</p>	<p>15' MODEM CABLES 10#22ga wire w/shield, DB25P conn & DB51226-1 cover on one end \$5.50 ea. 10/\$50.00</p>	<p>25' MODEM CABLES 13#22ga wire w/shield, DB25P conn & DB51226-1 cover on one end \$6.50 ea. 10/\$60.00</p>																																																																																																												
<p>Double Row/Solder Eyelet .156 6 pins \$1.10 ea 10/\$ 9.00 15 pins \$1.55 ea 10/\$12.50 22 pins \$2.08 ea 10/\$17.00 43 pins \$3.66 ea 10/\$30.00</p>	<p>12 Vdc RELAY SPST 35 Amp Contacts Open Frame Rugged, great for mobile use \$4.50 ea 5/\$20.00</p>	<p>12 Vdc RELAY SPST Open Frame 5 Amp Contacts Mfg-Magnecraft \$1.50 ea 4/\$5.00</p>	<p>USED MUFFIN FANS 3 blades, 110VAC, 4 1/4" sq. \$5.95</p>																																																																																																												
<p>C & K SWITCHES PART # MOVEMENT 7101 ON/NONE/ON SPST 7103 ON/OFF/ON SPST 7108 ON/NONE/(ON) SPST 7201 ON/NONE/ON DPDT \$1.00 EA 6 FOR \$5.00</p>	<p>22 pins/Double Row/Dipped Solder .156 \$2.08 ea 10/\$17.00</p>	<p>22 pins/Double Row/Wire Wrap .156 \$2.44 ea 10/\$19.00</p>	<p>CW MINI SLIDE SW DPDT .15 ea. 10/\$1.25</p>																																																																																																												
<p>6 TV GAMES ON (1) CHIP Gen Instr AY-3-8500-1 28 Pin Plastic Case EVERYDAY LOW PRICE \$7.50 ea</p>	<p>RECEIVER FRONT ENDS Made by EFJ 132-174 MHz \$12.00 ea.</p>	<p>100 ASSORTED DISC CAPS (FULL LEADS) 20 EA OF 5 DIFFERENT VALUES \$2.00 PER PACK</p>	<p>ALL STAR AIR VARIABLE 24-275 pF .75 ea.</p>																																																																																																												
<p>ASSORTED ELECTROLYTICS</p> <table border="1"> <thead> <tr> <th>VALUE/MFD</th> <th>@</th> <th>VOLTS</th> <th>DIA</th> <th>LENGTH</th> <th>PRICE</th> </tr> </thead> <tbody> <tr><td>250,000</td><td>@</td><td>5V</td><td>3"</td><td>5 3/4"</td><td>\$4.00 ea</td></tr> <tr><td>30,000</td><td>@</td><td>15V</td><td>3"</td><td>4 1/2"</td><td>4.00 ea</td></tr> <tr><td>63,000</td><td>@</td><td>15V</td><td>3"</td><td>5 1/2"</td><td>4.00 ea</td></tr> <tr><td>10,000</td><td>@</td><td>20V</td><td>1 1/2"</td><td>5 3/4"</td><td>3.00 ea</td></tr> <tr><td>2,700</td><td>@</td><td>25V</td><td>1 1/4"</td><td>2 1/4"</td><td>2.00 ea</td></tr> <tr><td>2,900</td><td>@</td><td>25V</td><td>1 1/4"</td><td>2"</td><td>2.00 ea</td></tr> <tr><td>3,000</td><td>@</td><td>25V</td><td>1 1/2"</td><td>4 1/2"</td><td>2.00 ea</td></tr> <tr><td>18,000</td><td>@</td><td>25V</td><td>2"</td><td>4"</td><td>3.00 ea</td></tr> <tr><td>21,000</td><td>@</td><td>25V</td><td>2 1/2"</td><td>3"</td><td>3.00 ea</td></tr> <tr><td>39,000</td><td>@</td><td>45V</td><td>3"</td><td>5 3/4"</td><td>3.00 ea</td></tr> <tr><td>1,000</td><td>@</td><td>50V</td><td>1 1/4"</td><td>3 1/4"</td><td>2.50 ea</td></tr> <tr><td>34,800</td><td>@</td><td>50V</td><td>3"</td><td>5 1/2"</td><td>3.00 ea</td></tr> <tr><td>450</td><td>@</td><td>75V</td><td>1 1/4"</td><td>2 1/4"</td><td>2.00 ea</td></tr> <tr><td>500</td><td>@</td><td>100V</td><td>1 1/2"</td><td>3 1/2"</td><td>2.00 ea</td></tr> <tr><td>240</td><td>@</td><td>300V</td><td>1 1/4"</td><td>3 1/4"</td><td>2.00 ea</td></tr> <tr><td>50</td><td>@</td><td>450V</td><td>1 1/4"</td><td>2"</td><td>2.00 ea</td></tr> <tr><td>140</td><td>@</td><td>450V</td><td>1 1/4"</td><td>3"</td><td>2.00 ea</td></tr> </tbody> </table>	VALUE/MFD	@	VOLTS	DIA	LENGTH	PRICE	250,000	@	5V	3"	5 3/4"	\$4.00 ea	30,000	@	15V	3"	4 1/2"	4.00 ea	63,000	@	15V	3"	5 1/2"	4.00 ea	10,000	@	20V	1 1/2"	5 3/4"	3.00 ea	2,700	@	25V	1 1/4"	2 1/4"	2.00 ea	2,900	@	25V	1 1/4"	2"	2.00 ea	3,000	@	25V	1 1/2"	4 1/2"	2.00 ea	18,000	@	25V	2"	4"	3.00 ea	21,000	@	25V	2 1/2"	3"	3.00 ea	39,000	@	45V	3"	5 3/4"	3.00 ea	1,000	@	50V	1 1/4"	3 1/4"	2.50 ea	34,800	@	50V	3"	5 1/2"	3.00 ea	450	@	75V	1 1/4"	2 1/4"	2.00 ea	500	@	100V	1 1/2"	3 1/2"	2.00 ea	240	@	300V	1 1/4"	3 1/4"	2.00 ea	50	@	450V	1 1/4"	2"	2.00 ea	140	@	450V	1 1/4"	3"	2.00 ea	<p>STANCOR TRANSFORMERS STEP-DOWN AUTO (3) COND LINE CORD W/RECPT GSD 200 (230V In/115V Out @ 200 Va) \$12.00 ea GSD 400 (230 In/115 V Out @ 400 Va) \$14.50 ea</p>	<p>White Porcelain Egg Insulator 1 1/2" x 1" 50¢ ea. 3 for \$1.25</p>	<p>RED SEVEN SEGMENT DISPLAY TIL 322P \$1.00 ea.</p>
VALUE/MFD	@	VOLTS	DIA	LENGTH	PRICE																																																																																																										
250,000	@	5V	3"	5 3/4"	\$4.00 ea																																																																																																										
30,000	@	15V	3"	4 1/2"	4.00 ea																																																																																																										
63,000	@	15V	3"	5 1/2"	4.00 ea																																																																																																										
10,000	@	20V	1 1/2"	5 3/4"	3.00 ea																																																																																																										
2,700	@	25V	1 1/4"	2 1/4"	2.00 ea																																																																																																										
2,900	@	25V	1 1/4"	2"	2.00 ea																																																																																																										
3,000	@	25V	1 1/2"	4 1/2"	2.00 ea																																																																																																										
18,000	@	25V	2"	4"	3.00 ea																																																																																																										
21,000	@	25V	2 1/2"	3"	3.00 ea																																																																																																										
39,000	@	45V	3"	5 3/4"	3.00 ea																																																																																																										
1,000	@	50V	1 1/4"	3 1/4"	2.50 ea																																																																																																										
34,800	@	50V	3"	5 1/2"	3.00 ea																																																																																																										
450	@	75V	1 1/4"	2 1/4"	2.00 ea																																																																																																										
500	@	100V	1 1/2"	3 1/2"	2.00 ea																																																																																																										
240	@	300V	1 1/4"	3 1/4"	2.00 ea																																																																																																										
50	@	450V	1 1/4"	2"	2.00 ea																																																																																																										
140	@	450V	1 1/4"	3"	2.00 ea																																																																																																										
	<p>15' MODEM CABLES 14#22ga wire w/shield, DB25P conn & DB51226-1 cover on one end \$6.00 ea. 10/\$55.00</p>	<p>CAPS RADIAL LEADS 2200 uF @ 16V .25 ea. 10/\$2.00</p>	<p>BOURNS' EDGE MOUNTING 5K pot single turn 3345W series \$1.50 ea.</p>																																																																																																												
	<p>15' MODEM CABLES 10#22ga wire w/shield, DB25S conn & DB51226-1 cover on one end \$6.50 ea. 10/\$60.00</p>	<p>SOLDER LUG-TYPE CAPS 50 uF @ 350V 1" D x 3" L 50 uF @ 450V 1" D x 2 1/2" L 50 uF @ 450V 1" D x 3" L 60¢ EA. 5 FOR \$2.50</p>	<p>12 VOLTS @ 1/2 AMP Filament transformer 1 1/4" x 2" x 1" \$1.50 ea.</p>																																																																																																												
		<p>EFJ CRYSTAL OVENS 6V/12V 75° \$5.00 ea.</p>	<p>CTS DP6P ROT SWITCH .50 ea. 5/\$2.00</p>																																																																																																												
		<p>IC SOCKETS Cambion Gold Plated Wire Wrap 14 pin .35 ea 10/\$3.00 16 pin .38 ea 10/\$3.30</p>	<p>AXIAL LEAD ELECTROLYTIC CAPACITORS 2 uF @ 15V } 10 uF @ 15V } 20 uF @ 15V } 12 ea. 50 uF @ 15V } for 2.2 uF @ 25V } \$1.00 3.3 uF @ 25V } 1 uF @ 35V } 2 uF @ 150V } 25 uF @ 25V } 15 ea. 3 uF @ 50V } for 5 uF @ 50V } \$2.00 10 uF @ 50V } 250 uF @ 25V } 10 ea. 100 uF @ 50V } for 50 uF @ 75V } \$2.00</p>																																																																																																												

TERMS: All material guaranteed • If for any reason you are not satisfied, our products may be returned within 10 days for a full refund (less shipping). Please add \$3 for shipping and handling on all orders. Additional 5% charge for shipping any item over 5 lbs. COD's accepted for orders totaling \$50.00 or more. All orders shipped UPS unless otherwise specified. Florida residents please add 4% sales tax. Minimum order \$15.00.

Low Cost...High Performance

DIGITAL MULTIMETER



\$99.95 WIRED

Low cost, high performance, that's the DM-700. Unlike some of the hobby grade DMMs available, the DM-700 offers professional quality performance and appearance at a hobbyist price. It features 26 different ranges and 5 functions, all arranged in a convenient, easy to use format. Measurements are displayed on a large 3½ digit, ½ inch high LED display, with automatic decimal placement, automatic polarity, and overrange indication. You can depend upon the DM-700, state-of-the-art components such as a precision laser trimmed resistor array, semiconductor band gap reference, and reliable LSI circuitry insure lab quality performance for years to come. Basic DC volts and ohms accuracy is 0.1%, and you can measure voltage all the way from 100 μ V to 1000 volts, current from 0.1 μ A to 2.0 amps and resistance from 0.1 ohms to 20 megohms. Overload protection is inherent in the design of the DM-700, 1250 volts, AC or DC on all ranges, making it virtually goof proof. Power is supplied by four 'C' size cells, making the DM-700 portable, and, as options, a nicad battery pack and AC adapter are available. The DM-700 features a handsome, jet black, rugged ABS case with convenient retractable tilt bail. All factory wired units are covered by a one year limited warranty and kits have a 90 day parts warranty.

Order a DM-700, examine it for 10 days, and if you're not satisfied in every way, return it in original form for a prompt refund.

Specifications

DC and AC volts: 100 μ V to 1000 Volts, 5 ranges
 DC and AC current: 0.1 μ A to 2.0 Amps, 5 ranges
 Resistance: 0.1 Ω to 20 megohms, 6 ranges
 Input protection: 1250 volts AC/DC all ranges fuse protected for overcurrent
 Input impedance: 10 megohms, DC/AC volts
 Display: 3½ digits, 0.5 inch LED
 Accuracy: 0.1% basic DC volts
 Power: 4 'C' cells, optional nicad pack, or AC adapter
 Size: 6"W x 3"H x 6"D
 Weight: 2 lbs with batteries

Prices

DM-700 wired + tested	\$99.95
DM-700 kit form	79.95
AC adapter/charger	4.95
Nicad pack with AC adapter/charger	19.95
Probe kit	3.95

TERMS: Satisfaction guaranteed or money refunded, COD, add \$1.50. Minimum order \$6.00. Orders under \$10.00, add \$3.75. Add 5% for postage, insurance, handling. Overseas, add 15%. NY residents, add 7% tax.



600 mHz COUNTER



\$99.95 WIRED

The CT-70 breaks the price barrier on lab quality frequency counters. No longer do you have to settle for a kit, half-kit or poor performance, the CT-70 is completely wired and tested, features professional quality construction and specifications, plus is covered by a one year warranty. Power for the CT-70 is provided by four 'AA' size batteries or 12 volts, AC or DC, available as options are a nicad battery pack, and AC adapter. Three selectable frequency ranges, each with its own pre-amp, enable you to make accurate measurements from less than 10 Hz to greater than 600 mHz. All switches are conveniently located on the front panel for ease of operation, and a single input jack eliminates the need to change cables as different ranges are selected. Accurate readings are insured by the use of a large 0.4 inch seven digit LED display, a 1.0 ppm TCXO time base and a handy LED gate light indicator.

The CT-70 is the answer to all your measurement needs, in the field, in the lab, or in the ham shack. Order yours today, examine it for 10 days, if you're not completely satisfied, return the unit for a prompt and courteous refund.

Specifications

Frequency range: 10 Hz to over 600 mHz
 Sensitivity: less than 25 mv to 150 mHz
 less than 150 mv to 600 mHz
 Stability: 1.0 ppm, 20-40°C; 0.05 ppm/°C TCXO crystal time base
 Display: 7 digits, LED, 0.4 inch height
 Input protection: 50 VAC to 60 mHz, 10 VAC to 600 mHz
 Input impedance: 1 megohm, 6 and 60 mHz ranges 50 ohms, 600 mHz range
 Power: 4 'AA' cells, 12 V AC/DC
 Gate: 0.1 sec and 1.0 sec LED gate light
 Decimal point: Automatic, all ranges
 Size: 5"W x 1½"H x 5½"D
 Weight: 1 lb with batteries

Prices

CT-70 wired + tested	\$99.95
CT-70 kit form	75.95
AC adapter	4.95
Nicad pack with AC adapter/charger	14.95
Telescopic whip antenna, BNC plug	7.95
Tilt bail assembly	3.95

ramsey electronics

✓ R8 BOX 4072, ROCHESTER, N.Y. 14610
 PHONE ORDERS CALL
 (716) 271-6487

ALARM CLOCK KITS: 4 Digit .5"

Here it is! The first of several quality kits we have been asked for: Here is what you get — unbelievable as it may sound...

- 1 National - 5375AA Clock Chip
- 1 Bowmar Clock Stick Readout (L.E.D.) 4 digit - 1/2"
- 13 Transistors
- 2 Push Buttons for time set
- 2 Toggle Switches for alarm
- 1 Filter cap
- 4 1N4000 series diodes
- 1 1N4148
- 2 Disc caps
- 29 Resistors
- 1 Transducer (Speaker) for Alarm
- 1 LED Lamp for alarm indicator

NEW!
\$9.99

ORDER
KIT
CK-100AC

P.C. Board \$2.25

Plug In
Transformer \$1.50

D.C. MODEL

Same as above except it includes 60 Hz timebase.

This Kit Includes:

- 1 National 5375AA Clock Chip
- 1 Bowmar Clock Stick Readout - (L.E.D.) 4 digit - 1/2"
- 12 Transistors
- 2 Push Buttons for time set
- 2 Disc caps
- 27 Resistors
- 1 MOV
- 1 60 Hz time base

P.C. Board \$2.25

NEW!
\$12.75

ORDER
KIT
CK-100DC

**MICRO MINI
TOGGLE SWITCHES**
6 for \$5 with hardware.



**99¢
EACH**

VARO FULL WAVE BRIDGE

6 AMPS 200 PIV
#VH248
3/4 IN. SQUARE **NEW!**



89¢ ea. 4 For \$2.99

RCA SENSITIVE GATE TRIAC

TO-5 CASE. HOUSE #40531
ALSO SAME AS T2300D.
2.5 AMPS 400 PIV



5 FOR \$1.19

Perfect for Dimmers, Color Organs, etc.
PC LEADS

Sonalert® on P.C. Board

Direct from a radar detector manufacturer! 4-741 on a board - plus 12 capacitors, trim pot and many useable components plus a Mallory Sonalert® - well worth the price of the board alone - while they last - **\$2.50 ea.**



We bought 350,000 LED's.
And you get the savings.

Reds, greens, yellows, orange, small, medium, large. Bags of 25 - mixed **\$2.75**. That's only 11¢ each. Compare this bargain up to twice our price.

FACTORY PRIME

BI - Polar LED 59¢ ea. or 10 for \$5

LAB-BENCH VARIABLE POWER SUPPLY KIT

5 to 20 VDC at 1 AMP. Short circuit protected by current limit. Uses IC regulator and 10 AMP Power Darlington. Very good regulation and low ripple. Kit includes PC Board, all parts, large heatsink and shielded transformer. 50 MV. TYP. Regulation. **\$15.99 KIT**

LED BAR GRAPH AND ANALOG METER DRIVER

New from National Semi. #LM3914. Drives 10 LED directly for making bar graphs, audio power meters, analog meters, LED oscilloscopes, etc. Units can be stacked for more LED's. A super versatile and truly remarkable IC. Just out!

SPECIAL PRICE: \$3.99 INCLUDES 12 Page Spec. Sheet

NATIONAL SEMICONDUCTOR

"COLOSSUS JR." JUMBO CLOCK MODULE

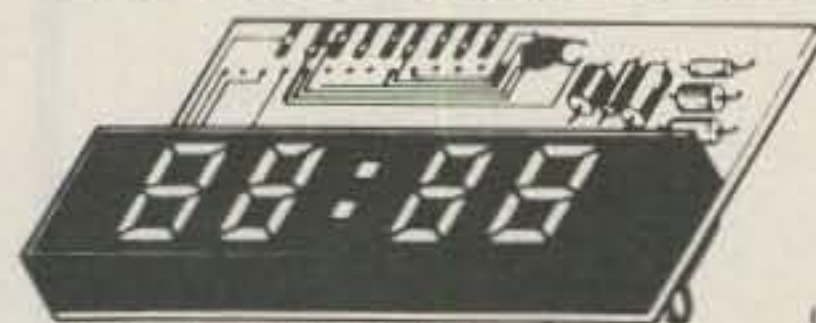

\$8.50

2 FOR \$15

(AC XFMR \$1.95)

ASSEMBLED! NOT A KIT!

MANUFACTURER'S CLOSEOUT!

PERFECT FOR USE WITH A TIMEBASE.

- Bright 4 digit 0.7" LED Display
- Complete-Add only Transformer and Switches
- 24 Hour Alarm Signal Output
- 12 Hour Real Time Format
- 50 or 60 Hz Operation
- Power Failure Indication
- LED Brightness Control
- Sleep and Snooze Timers
- Alarm "on" and PM Indicators
- Direct Drive - No RFI
- Direct Replacement for MA1012
- Comes with Full Data

CLOCK MODULE OPTIONS MA1008 A and D MA1013

Switches and pot for all options.

Includes:

- 5 push buttons
- 1 toggle
- 1 10K pot **\$2.50**
- Alarm Parts (including high impedance transducer). Much more efficient than a speaker. **\$1.50**
- Transducer only (unbelievably loud!) **\$1.10**

16K DYNAMIC RAM CHIP WORKS IN TRS-80 OR APPLE II

16K X 1 Bits. 16 Pin Package. Same as Mostek 4116-4. 250 NS access. 410 NS cycle time. Our best price yet for this state of the art RAM. 32K and 64K RAM boards using this chip are readily available. These are new fully guaranteed devices by a major mfg.

VERY LIMITED STOCK!

"MAGAZINE SPECIAL" - 8/\$79.50

**MA1013
BRAND NEW!**

SONY 23 WATT AUDIO AMP MODULE

#STK-054. 23 WATTS SUPER CLEAN AUDIO. 20 HZ to 100 KHZ ± 2 DB. HYBRID, SILICON, SELF-CONTAINED MODULE. ONLY 1 3/4 x 2 1/2 IN. WITH DATA.

COMPARE AT UP TO TWICE OUR PRICE! **\$6.50 each**

60 Hz CRYSTAL TIME BASE \$4.95 (Complete Kit)

Uses MM5369 CMOS divider IC with high accuracy 3.579545 MHZ Crystal. Use with all MOS Clock Chips or Modules. Draws only 1.5 MA. All parts, data and PC Board included. 100 Hz, same as above, except **\$5.95**

SILICON POWER SOLAR CELLS

2 Inch Dia. Approx. .5 VDC at 500 MA. in sunlight. Factory new units, not rejects as sold by others. Series for higher voltage, parallel for higher current. Converts solar energy directly to electricity. **LIMITED QUANTITY. \$5.99 ea**

FAIRCHILD PNP

"SUPER TRANSISTOR"

2N4402. TO-92 Plastic. Silicon PNP Driver. High Current. VCEO-40 HFE-50 to 150 at 150 MA. FT-150 MHZ. A super "BEEFED-UP" Version of the 2N3906.

8 FOR \$1.19

SOUND ACTIVATED SWITCH

Not a kit. Already assembled. Clap your hands and turn on lights, music boxes, coffee pots, etc. Full spec. sheet with each unit.

69¢ 10 for \$5.50

TOSHIBA POWER AUDIO AMP

5.8 WATTS RMS Typical Output. 50 to 30,000 HZ ± 3 DB. For CB's, tape decks, PA's, etc. Works off of a single supply voltage from 10.5 to 18 VDC. 10 Pin plastic DIP with special built in heat sink tab. Perfect for use on 12VDC. **\$3.99 each** With Data.

TERMS: Add 50¢ postage, we pay balance. Orders under \$15 add 75¢ handling. No C.O.D. We accept Visa, MasterCard and American Express cards. Tex. Res. add 5% Tax. Foreign orders (except Canada) add 20% P&H. 90 Day Money Back Guarantee on all items.

Digital Research: Parts

(OF TEXAS)

P.O. BOX 401247 • GARLAND, TEXAS 75040 • (214) 271-2461

GET ON PHASE THREE FOR MUCH LESS THAN YOU THINK!

These Low Cost SSB TRANSMITTING CONVERTERS

Let you use inexpensive recycled 10M or 2M SSB exciters on UHF & VHF!

- Linear Converters for SSB, CW, FM, etc.
- A fraction of the price of other units; no need to spend \$300 - \$400!
- Use with any exciter; works with input levels as low as 1 mW.
- Use low power tap on exciter or simple resistor attenuator pad (instructions included).
- Link osc with RX converter for transceive.

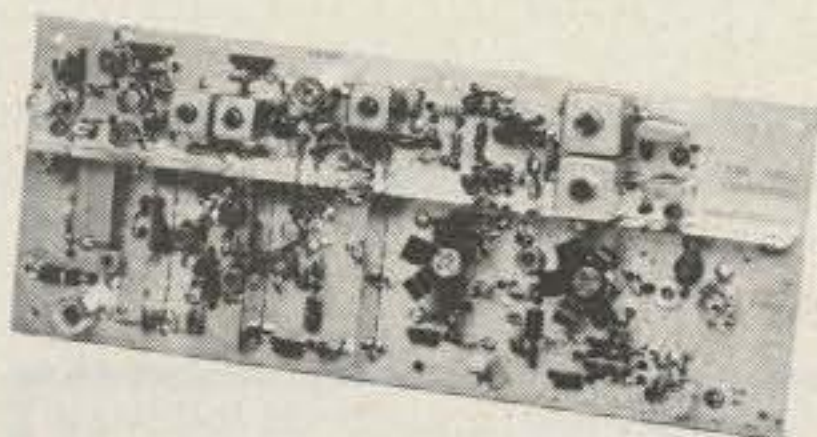

HAMTRONICS DOES IT AGAIN!

NEW XV4 UHF KIT - ONLY \$99.95

28-30 MHz in, 435-437 MHz out; 1W p.e.p. on ssb, up to 1½W on CW or FM. Has second oscillator for other ranges. Atten. supplied for 1 to 500 mW input, use external attenuator for higher levels.

Extra crystal for 432-434 MHz range.....\$5.95
XV4 Wired and tested\$149.95

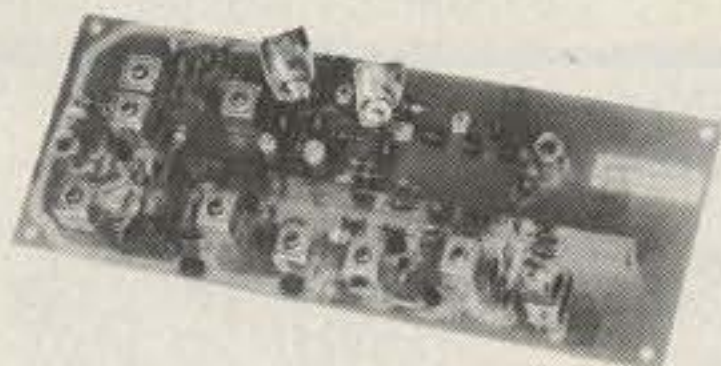

XV2 VHF KIT - ONLY \$69.95

2W p.e.p. output with as little as 1mW input. Use simple external attenuator. Many freq. ranges available.

MODEL	INPUT (MHz)	OUTPUT (MHz)
XV2-1	28-30	50-52
XV2-2	28-30	220-222
XV2-4	28-30	144-146
XV2-5	28-29 (27-27.4 CB)	145-146 (144-144.4)
XV2-7	144-146	50-52
XV2 Wired and tested\$109.95		

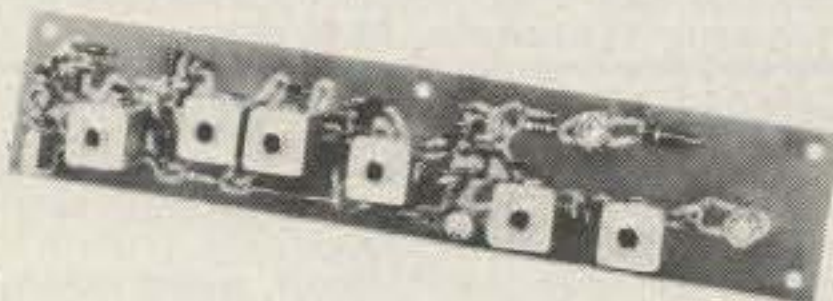

XV28 2M ADAPTER KIT - \$24.95

Converts any 2M exciter to provide the 10M signal required to drive above 220 or 435 MHz units.

Easy to Build FET RECEIVING CONVERTERS

Let you receive OSCAR and other exciting VHF and UHF signals on your present HF or 2M receiver

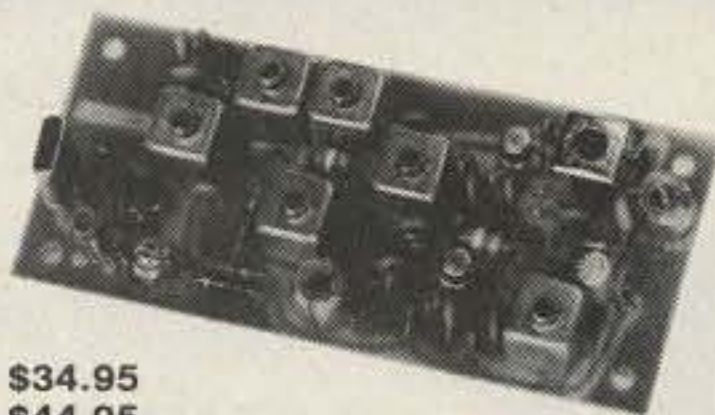

VHF KIT \$34.95
VHF Wired \$44.95

MODEL	RF RANGE	OUTPUT RANGE
CA28	28-32 MHz	144-148 MHz
CA50	50-52	28-30
CA50-2	50-54	144-148
CA144	144-146	28-30
CA145	145-147	28-30
or	144-144.4	27-27.4 (CB)
CA146	146-148	28-30
CA220	220-222	28-30
CA220-2	220-224	144-148
CA110	Any 2MHz of Aircraft Band	26-28 or 28-30
Kit less xtal\$29.95		

UHF KIT \$34.95
UHF Wired \$44.95



MODEL	RF RANGE	OUTPUT RANGE
C432-2	432-434	28-30
C432-5	435-437	28-30
C432-4	432-436	144-148
Kit less xtal\$29.95		

Professional Quality VHF/UHF FM/CW EXCITERS

- Fully shielded designs
- Double tuned circuits for spurious suppression
- Easy to align with built-in test aids

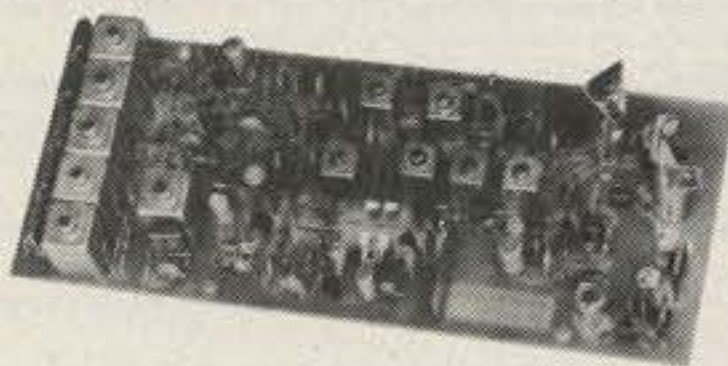

T50-50	6-chan, 6M, 2W Kit.....	\$44.95
T50-150	6-chan, 2M, 2W Kit.....	\$44.95
T50-220	6-chan, 220 MHz, 2W Kit	\$44.95
T450	1-chan, 450 MHz, ¼W Kit.....	\$44.95

See our Complete Line of VHF & UHF Linear PA's

- Use as linear or class C PA
- For use with SSB Xmtg Converters, FM Exciters, etc.

LPA2-15	6M, 2M, 220; 15 to 20W	\$59.95
LPA2-30	6M, 2m; 25 to 30W	\$89.95
LPA2-40	220 MHz; 30 to 40W	\$119.95
LPA2-45	6M, 2M; 40 to 45W	\$119.95
LPA4-10	430MHz; 10 to 14W	\$79.95
LPA4-30	430MHz; 25 to 30W	\$119.95

See catalog for complete specifications

FAMOUS HAMTRONICS PREAMPS

Let you hear the weak ones too!
Great for OSCAR, SSB, FM, ATV. Over 14,000 in use throughout the world on all types of receivers.

P9 Kit \$12.95
P14 Wired \$21.95
Specify band when ordering

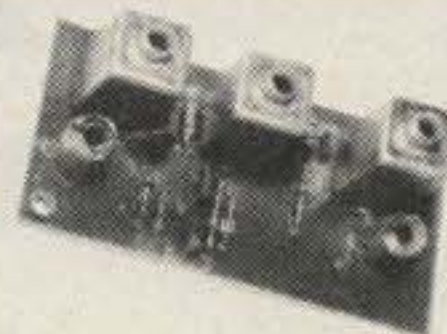

- Deluxe vhf model for applications where space permits ● 1½" x 3" ● Models available to cover any 4MHz band in the 26 to 230 MHz range ● 12 Vdc ● 2 stages ● Ideal for OSCAR ● 20 dB gain

P8 Kit \$10.95
Specify band when ordering



- Miniature vhf model for tight spaces—size only ½ x 2 ¾ ● Models available to cover any 4MHz band in the range 20 to 230 MHz ● 20 dB gain ● 12 Vdc

P15 Kit \$18.95
P35 Wired \$27.95



- Covers any 10 MHz band in UHF range of 380 to 520 MHz ● 20 dB gain ● 2 stages ● 12 Vdc

NEW VHF/UHF FM RCVRs

Offer Unprecedented Range of Selectivity Options

- New generation
- More sensitive
- More selective
- Low cross mod
- Uses crystal filters
- Smaller
- Easy to align



R75A* VHF Kit for monitor or weather satellite service. Uses wide L-C filter. -60dB at ± 30 kHz.\$69.95

R75B* VHF Kit for normal nbfm service. Equivalent to most transceivers. -60dB at ± 17 kHz, -80dB at ± 25 kHz... \$74.95

R75C* VHF Kit for repeater service or high rf density area. -60dB at ± 14kHz, -80dB ± 22kHz, -100dB ± 30kHz.... \$84.95

R75D* VHF Kit for split channel operation or repeater in high density area. Uses 8-pole crystal filter. -60dB at ± 9kHz, -100dB at ± 15 kHz. The ultimate receiver!... \$99.95

* Specify band: 10M, 6M, 2M, or 220 MHz. May also be used for adjacent commercial bands. Use 2M version for 137 MHz WX satellites.

R85() UHF FM Receiver Kits, triple conversion, include C432 UHF Front End Module. Add \$20 to above prices. (Add selectivity letter to model number.)

A13-45A 6 Channel Adapter for receivers\$13.95
WX-25 Weather Tone Alert\$24.95

NEW R110 VHF AM RCVR

AM monitor receiver kit similar to R75A, but AM. Available for 10-11M, 6M, 2M, 220 MHz, and 110-130 MHz aircraft band.\$74.95

IT'S EASY TO ORDER!

- Write or phone 716-392-9430 (Electronic answering service evenings & weekends)
- Use Credit Card, UPS COD, Check, Money Order
- Add \$2.00 shipping & handling per order

Call or Write to get FREE CATALOG With Complete Details

(Send 4 IRC's for overseas mailing)

hamtronics, inc.

65 E MOUL RD · HILTON, NY 14468

X-RATED CLOCK!

ZULU II CLOCK KIT

WITH CALENDAR AND
NOX™ CIRCUIT

\$19.95
LESS CASE

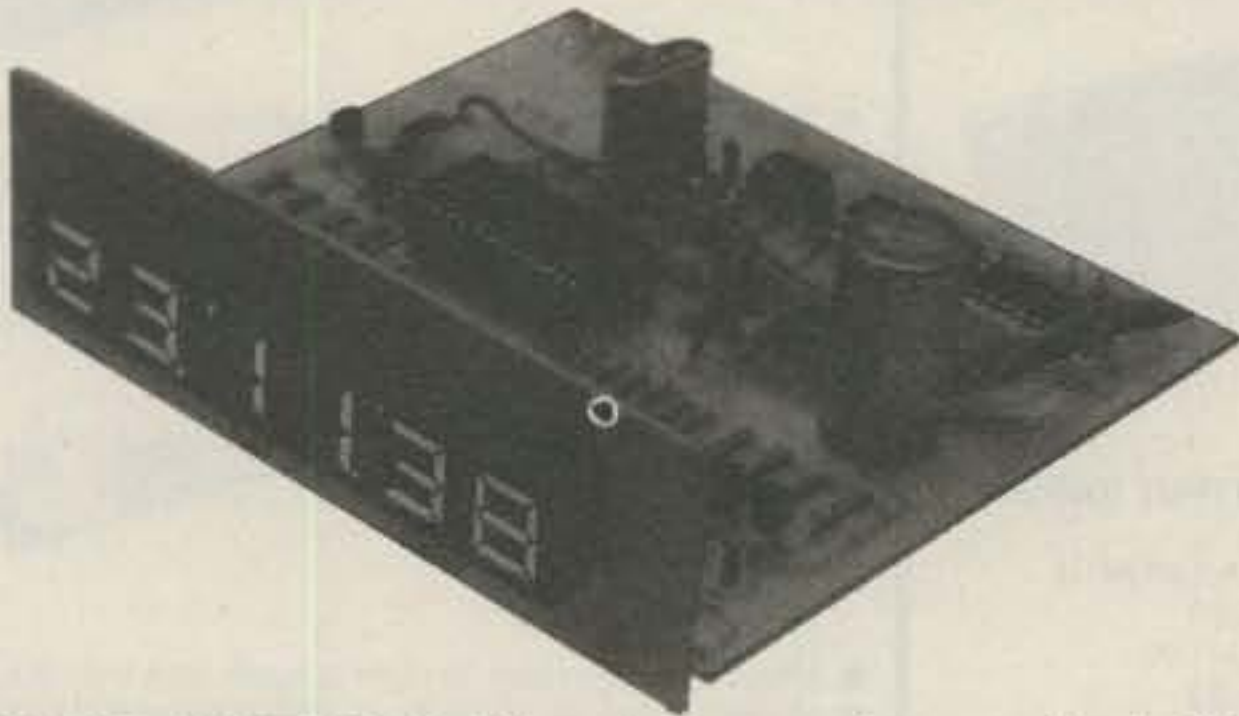

X-TRA VALUE: All the components and high quality plated G-10 PC Boards are provided.

X-TRA CARE IN DESIGN: No wires between readout board and clock board. Large open layout.

X-CELLENCE IN IDEAS: 5 years of designed products for the amateur radio market.

X-CELLENCE IN INSTRUCTIONS: Clear step-by-step instructions with quality illustrations. The assembly manual is not a read-between-the-lines afterthought!

X-TRA FEATURES: There has never been a clock kit with so many features — at any price!

- Unit operates on either 12 VAC or 12 VDC.
- On board QUARTZ XTAL TIMEBASE or 60Hz AC line freq. can be used.
- Automatic BATTERY BACKUP*. Never worry about power failures again!
- Reads true 24 HOUR TIME and 31 DAY CALENDAR.
- Unique NOX™ CIRCUIT activates readouts with a handclap or they can be turned on constantly.
- When used mobile readouts blank when ignition is off.
- Special NOISE SUPPRESSION and battery reversal circuits.
- Bright 1/2" LED's show hours, minute and seconds.

Just clap your hands and the time appears for 5 seconds followed by the date for 4 seconds. A low cost 9V transistor battery provides stand by power in the event of power failures up to 4 hours. With the addition of a low cost 12V 300 MA transformer, the unit will work on AC.

Custom High Impact Molded Case with Ruby Lens. Available in Blue or Tan.

6.50

117 VAC to 12 VAC Transformer.

1.35

ACCESSORIES

*9V Battery Not Included

SE 01 Sound Effects Kit \$16.95

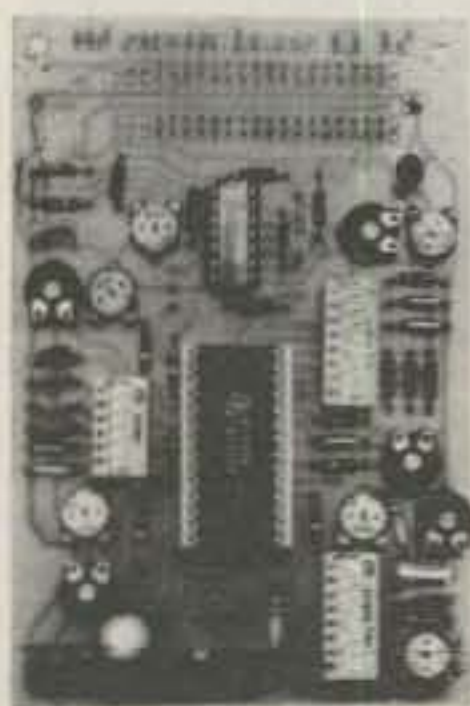

The SE-01 is a complete kit that contains all the parts to build a programmable sound effects generator. Designed around the new Texas Instruments SN76477 Sound Chip, the board provides banks of MINI DIP switches and pots to program the various combinations of the SLF Oscillator, VCO, Noise, One Shot, and Envelope Controls. A Quad Op Amp IC is used to implement an Adjustable Pulse Generator, Level Comparator and Multiplex Oscillator for even more versatility. The 3 1/4" x 5" PC Board features a prototype area to allow for user added circuitry. Easily programmed to duplicate Explosions, Phasor Guns, Steam Trains, or almost an infinite number of other sounds. The unit has a multiple of applications. The low price includes all parts, assembly manual, programming charts, and detailed 76477 chip specifications. It runs on a 9V battery (not included). On board 100MW amp will drive a small speaker directly, or the unit can be connected to your stereo with incredible results! (Speaker not included).

- 76477 CHIP IS INCLUDED. EXTRA CHIPS \$2.95 EACH
- \$16.95 LESS SPEAKER & BATTERY

From T.I.: TL490 BAR/DOT DRIVER IC. Drives 10 LED's with adjustable analog steps. Units are cascadable up to 10 (100 steps). Drives LED's directly. Great for voltage, current, or audio displays. Similar in features to LM3914 with specs and circuit notes.

2.95

NEW!



NEW ITEMS

LM567	Tone Decoder	.89
RCA 40430	400V 6A TRIAC TO-66	.75
CA3086	RCA Transistor Array	.80
MC1438R	Power Op Amp/Driver	.50
CD4046	PLL CMOS	.99
LM3302	Quad Comparator	.89
2SC1849	High Freq NPN TO-92	6/1.00
MPS A20	NPN GEN PUR	8/1.00
723	14 PIN DIP	3/1.00

XAN SUPER DIGITS

.6" JUMBO LED
7 SEGMENT
RED

99¢

6640 COMMON ANODE
6920 COMMON CATHODE

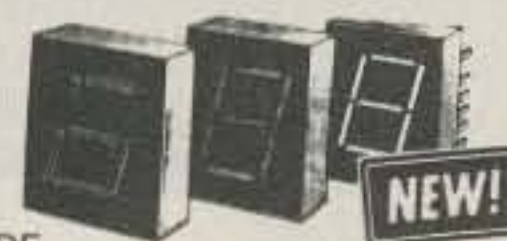

NOW A SUPER READOUT AT A SUPER BUY! These are factory fresh prime LED readouts, not seconds or rejects as sold by others. Compare our price and send for yours today, but hurry, the supply is limited! SPECIFY: COMMON ANODE OR COMMON CATHODE

POTENTIOMETER ASSORTMENT

A mix of new, panel mount 3/8" bushing pots in various values. Some dual, some with switches.

10/2.00

1/2W RESISTOR ASSORTMENT

A good mix of 5% and 10% values in both full lead and PC lead devices. All new, first quality.

(Asst.) 200 pieces/2.00

SLIDE SWITCH ASSORTMENT

An outstanding bargain. Includes miniature and standard sizes and multi-position units. All new first quality, name brand switches. Try one pack and you'll reorder more. SPECIAL — 12 for \$1.20 (Assortment)

PARTS

301 OP AMP & LEAD CAN	3/1.00
723 VOLT REG. 10 LEAD CAN	.50
*13741 FET INPUT 741 MINI DIP	3/1.10
30.000 @ 15V COMPUTER GRADE	2.10
2N4400 NPN GEN. PURPOSE	8/1.00
2N4402 PNP COMPLIMENT	8/1.00
2N6026 P.U.T. W/SPECS	.50
LM380 2W AUDIO IC W/SPECS	1.00
LM377 DUAL LM380 W/SPECS	2.50
*7815 VOLT REG. 1A 15V	.89
*78M05 5V 1/2A TO-5 REG.	.80
IL-1 OPTO ISOLATOR MINI DIP	.80
*MEM 631 DUAL GATE MOSFET, DIODE PROTECTED, SIMILAR TO 40673	.50
MV1624 VARICAP DIODE 10 PFD	.40
1N4003 1A 200V DIODE	15/1.00
TIP30 TAB PNP POWER	3/1.00
*MC1351P FM IF. DISC IC	.50
.25 ohm 3W RESISTOR	8/1.00
*INDICATED ITEM IS "HOUSE NUMBERED"	

LED'S

JUMBO GREEN	4/89
JUMBO RED	5/89
MEDIUM RED (1/4")	.15
MEDIUM GRN OR YELLOW	.18

7 WATT AUDIO AMP KIT

SMALL SINGLE HYBRID IC AND COMPONENTS FIT ON A 2" x 3" PC BOARD (INCLUDED). RUNS ON 12 VDC. GREAT FOR ANY PROJECT THAT NEEDS AN INEXPENSIVE AMP. LESS THAN 3% THD @ 5 WATTS. COMPATIBLE WITH SE-01 SOUND KIT.

\$5.95

6 DIGIT AUTO/VAN CLOCK

- LARGE 1" CHARACTERS (LED)
- QUARTZ XTAL TIMEBASE
- ALARM & SNOOZE OPTIONS
- NOISE FILTERING
- EASY TO ASSEMBLE
- 4" x 3" x 1 1/2"
- DRILLED & PLATED PC BOARDS

\$16.95 COMPLETE KIT

12 VDC

ULTRASONIC RELAY KIT

INVISIBLE BEAM WORKS LIKE A PHOTO ELECTRIC EYE. USE UP TO 25 FT. APART. COMPLETE KIT. ALL PARTS & PC BOARDS.

\$21.50



AY3-8910 PROGRAMMABLE SOUND GENERATOR

The AY3-8910 is a 40 pin LSI chip with three oscillators, three amplitude controls, programmable noise generator, three mixers, an envelope generator, and three D/A converters that are controlled by 8 BIT WORDS. No external pots or caps required. This chip hooked to an 8 bit microprocessor chip or Buss (8080, Z80, 6800 etc.) can be software controlled to produce almost any sound. It will play three note chords, make bangs, whistles, sirens, gunshots, explosions, bleats, whines, or grunts. In addition, it has provisions to control its own memory chips with two IO ports. The chip requires +5V @ 75ma and a standard TTL clock oscillator. A truly incredible circuit.

\$14.95 W/Basic Spec Sheet (4 pages)

60 page manual with S-100 interface instructions and several programming examples, **\$3.00 extra**

NPN HIGH VOLTAGE 2.00

VCEO = 450 VDC IC = 3A (5A Peak)

FOR TV HORIZONTAL SECTIONS; HIGH VOLTAGE REGULATORS

REPLACES: 2N5076, 2N5077, 2N5838, 2N5665, BDY94, BU126, 2SC2121, 2N5840, 2SC1046, 2N5466, TIP556 AND MANY OTHERS.

HOUSE #

HOUSE #

- NO C.O.D.'s
- SEND CHECK M.O. OR CHARGE CARD NO.
- PHONE ORDERS ACCEPTED ON VISA AND MASTERCARD ONLY.

(214) 278-3553

- ADD 5% FOR SHIPPING
- TX. RES. ADD 5% STATE SALES TAX
- FOREIGN ORDERS ADD 10% (EXCEPT CANADA) (20% AIRMAIL) U.S. FUNDS ONLY.

catalog free on request

Radio Bookshop

LICENSE STUDY GUIDES & TAPES

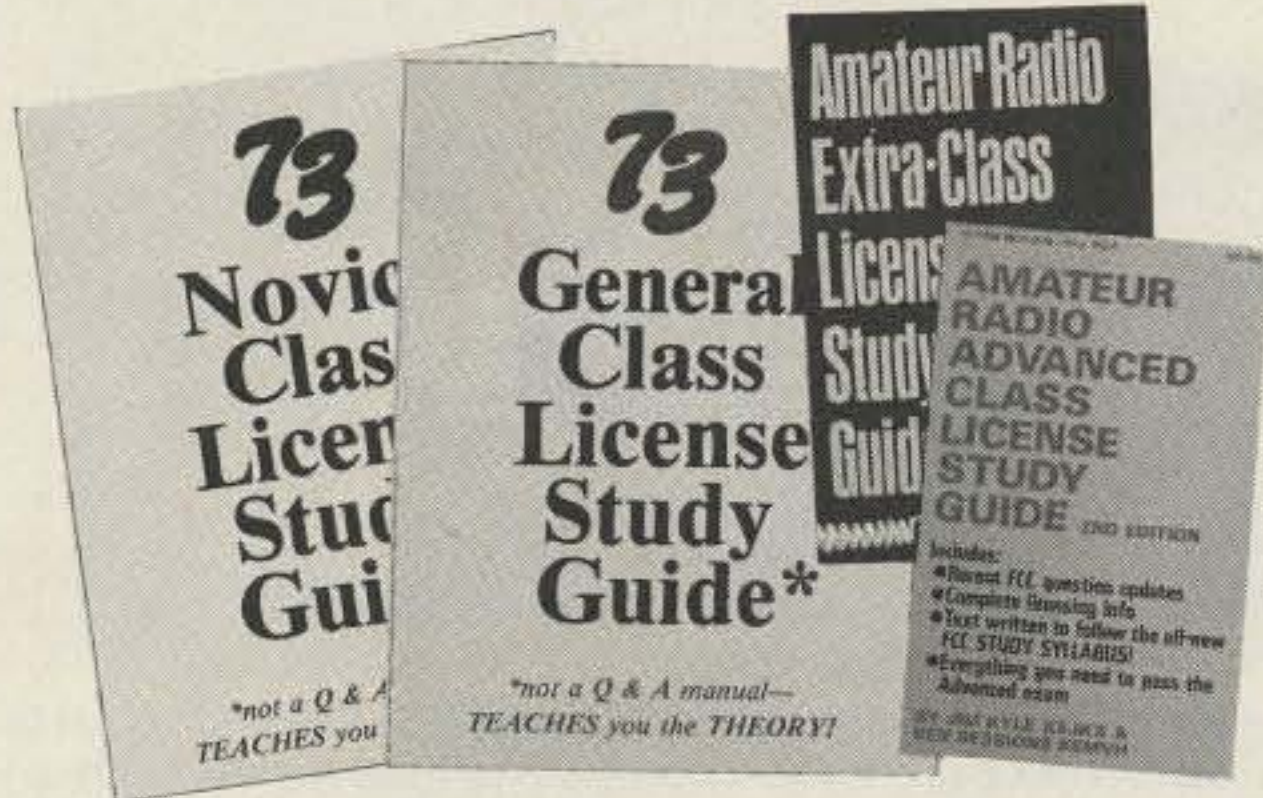

● **NOVICE STUDY GUIDE—SG7357**—Here is a completely new study guide and reference book for the potential ham. This is not a question/answer memorization course. Electronic and radio fundamentals are presented and explained in an easy-to-understand fashion, preparing the beginner for the Novice exam. Includes the latest FCC amateur regulations, as well as application forms. Easily the best path into the exciting world of ham radio! \$4.95.*

● **GENERAL CLASS STUDY GUIDE—SG7358**—A complete theory course for the prospective General or Technician. This reference explains transistor, amplifier, and general radio theory, while preparing the Novice for the "big" ticket. After getting your ticket, you'll use this guide again and again as an electronic reference source. Not a question/answer guide that becomes dated when the FCC updates the amateur exams. \$5.95.*

● **ADVANCED CLASS STUDY GUIDE—SG1081**—Ready to upgrade your license? To prevent retaking the FCC theory exam, you need the 73 Advanced theory guide. SSB, antenna theory, transmitters, and electronics measuring techniques are covered in detail in this easy-to-follow study guide. Special modes and techniques, such as RTTY, are also treated. An engineering degree is *not* necessary to master Advanced theory—try this book before visiting the examiner's office! \$6.95.*

● **EXTRA CLASS LICENSE STUDY GUIDE—SG1080**—Before going for your 1 x 2 call, it pays to be a master of the Extra class electronic theory. This study guide is the logical extension of the 73 theory course. All the theory necessary to pass the exam is presented. Antennas, transmission lines, swr are discussed, as well as noise, propagation, and specialized communication techniques. This book is not a classroom lecture or memorization guide, but rather a logical presentation of the material that must be *understood* before attempting the Extra exam. Save yourself a return trip to the FCC and try the 73 method first! \$6.95.*



NOVICE THEORY TAPES Startling Learning Breakthrough

● **NOVICE THEORY TAPES—CT7300**—Startling Learning Breakthrough. You'll be astounded at how really simple the theory is when you hear it explained on these tapes. Three tapes of theory and one of questions and answers from the latest Novice exams give you the edge you need to breeze through your exam. 73 is interested in helping get more amateurs, so we're giving you the complete set of our tapes for the incredibly low price of **ONLY \$15.95.***

Scientists have proven that you learn faster by listening than by reading because you can play a cassette tape over and over in your spare time—even while you're driving! You get more and more info each time you hear it.

You can't progress without solid fundamentals. These four hour-long tapes give you all the basics you'll need to pass the Novice exam easily. You'll have an understanding of the basics which will be invaluable to you for the rest of your life! Can you afford to take your Novice exam without first listening to these tapes? Set of 4—\$15.95.*



SSTV

● **SLOW SCAN TELEVISION TAPE—CT7350**—Prize-winning programs from the 73 SSTV contest. Excellent for Demo! \$5.95.*

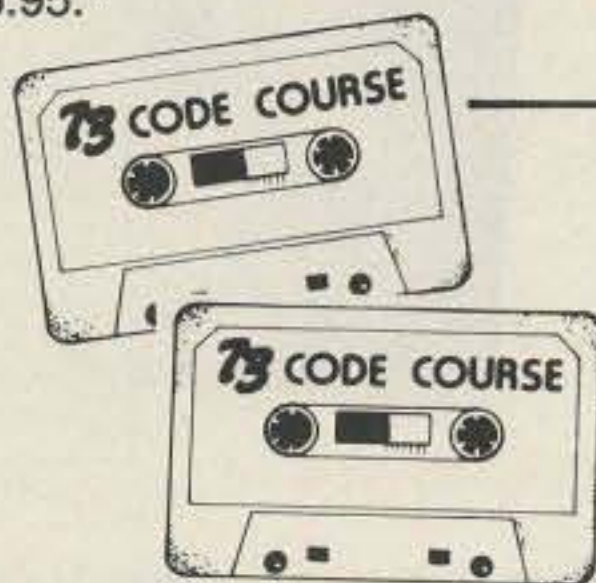

73 CODE TAPES

Any Four Tapes For \$15.95! *
\$4.95 Each! *

"GENESIS"

5 WPM—CT7305—This is the beginning tape for people who do not know the code at all. It takes them through the 26 letters, 10 numbers and necessary punctuation, complete with practice every step of the way using the newest blitz teaching techniques. It is almost miraculous! In one hour many people—including kids of ten—are able to master the code. The ease of learning gives confidence to beginners who might otherwise drop out.

"THE STICKLER"

6+ WPM—CT7306—This is the practice tape for the Novice and Technician licenses. It is made up of one solid hour of code, sent at the official FCC standard (no other tape we've heard uses these standards, so many people flunk the code when they are suddenly—under pressure—faced with characters sent at 13 wpm and spaced for 5 wpm). This tape is not memorizable, unlike the zany 5 wpm tape, since the code groups are entirely random characters sent in groups of five.

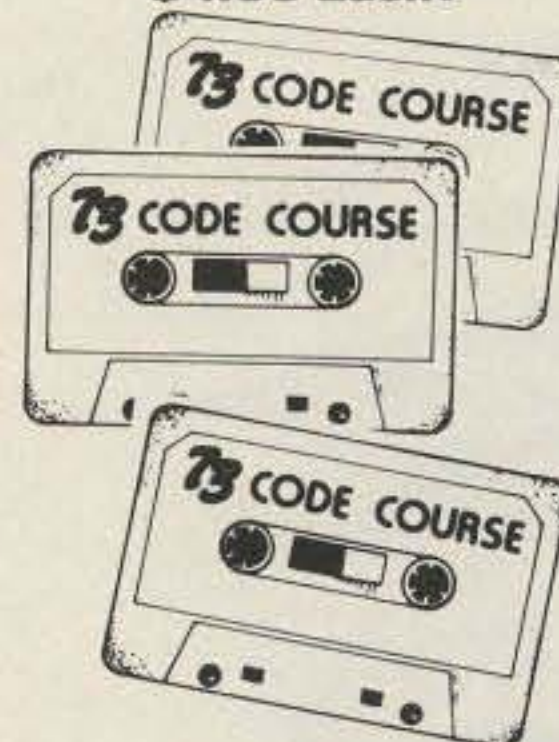

"BACK BREAKER"

13+ WPM—CT7313—Code groups again, at a brisk 13 per so you will be at ease when you sit down in front of the steely-eyed government inspector and he starts sending you plain language at only 13 per. You need this extra margin to overcome the panic which is universal in the test situations. When you've spent your money and time to take the test, you'll thank heavens you had this back-breaking tape.

"COURAGEOUS"

20+ WPM—CT7320—Code is what gets you when you go for the Extra class license. It is so embarrassing to panic out just because you didn't prepare yourself with this tape. Though this is only one word faster, the code groups are so difficult that you'll almost fall asleep copying the FCC stuff by comparison. Users report that they can't believe how easy 20 per really is with this fantastic one hour tape.

"OUTRAGEOUS"

25+ WPM—CT7325—This is the tape for that small group of overachieving hams who wouldn't be content to simply satisfy the code requirements of the Extra Class license. It's the toughest tape we've got and we keep a permanent file of hams who have mastered it. Let us know when you're up to speed and we'll inscribe your name in 73's CW "Hall of Fame."

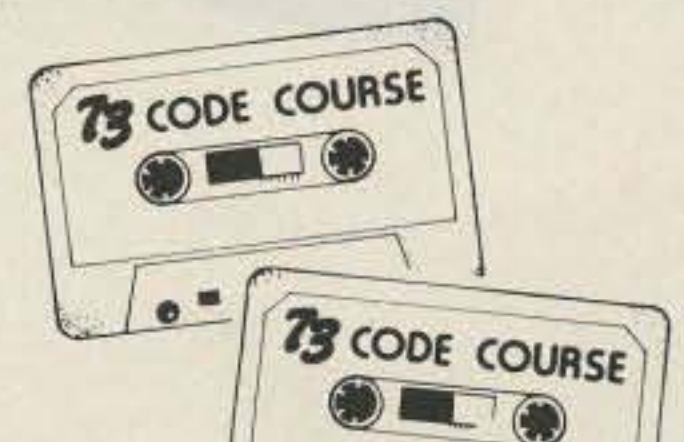

Use the order card in the back of this magazine or itemize your order on a separate piece of paper and mail to:
73 Radio Bookshop • Peterborough NH 03458. Be sure to include check or detailed credit card information.
*Add \$1.00 handling charge. Note: Prices subject to change on books not published by 73 Magazine.

FOR CUSTOMER SERVICE CALL (603) 924-7298

Radio Bookshop

73 TECHNICAL LIBRARY

● **BEHIND THE DIAL**—BK7307—By Bob Grove. Get more fun out of shortwave listening with this interesting guide to receivers, antennas, frequencies and interference. \$4.95.*

● **THE CHALLENGE OF 160**—BK7309—is the newest book in the 73 technical library, dedicated to 160 meter operating. Si Dunn provides all necessary information to get started on this unique band. The all-important antenna and ground systems are described in detail. The introduction contains interesting photos of Stew Perry's (the King of 160) shack. This reference is a must for new and experienced "Top Band" operators. Price: \$4.95.*

● **IC OP-AMP COOKBOOK**—BK1028—by Walter G. Jung. Covers not only the basic theory of the IC op amp in great detail, but also includes over 250 practical circuit applications, liberally illustrated. 592 pages, 5½ × 8½, softbound. \$12.95.*

● **THE POWER SUPPLY HANDBOOK**—BK7305—Need a power supply for a gadget you're building? In the **POWER SUPPLY HANDBOOK** there are dozens ready-to-build, plus detailed steps for designing your own. There are circuits and parts lists for all kinds of supplies, ranging from simple DC types to highly stable regulated versions. If you need a circuit to convert a DC voltage to a higher or lower voltage, turn DC into AC, or AC to DC—then this is the book you need. With more than 400 pages, you should be able to find just the circuit you need. Without a doubt one of the best power supply source books available, compiled by the editors of 73. \$7.95.*



● **INTRODUCTION TO RTTY**—BK7380—A beginner's guide to radioteletype including teletypewriter fundamentals, signals, distortion and RTTY art. You can be a RTTY artist! A 73 publication. \$2.00.*

● **THE NEW RTTY HANDBOOK**—BK7347—is a new edition and the only up-to-date RTTY book available. The state of the art has been changing radically and has made all previous RTTY books obsolete. It has the latest circuits, great for the newcomer and expert alike. \$5.95.*

● **PROPAGATION WIZARD'S HANDBOOK**—BK7302—by J. H. Nelson. When sunspots riddled the worldwide communications networks of the 1940's, John Henry Nelson looked to the planets for an answer. The result was a theory of propagation forecasting based upon interplanetary alignment that made the author the most reliable forecaster in America today. The book provides an enlightened look at communications past, present, and future, as well as teaching the art of propagation forecasting. \$6.95.*

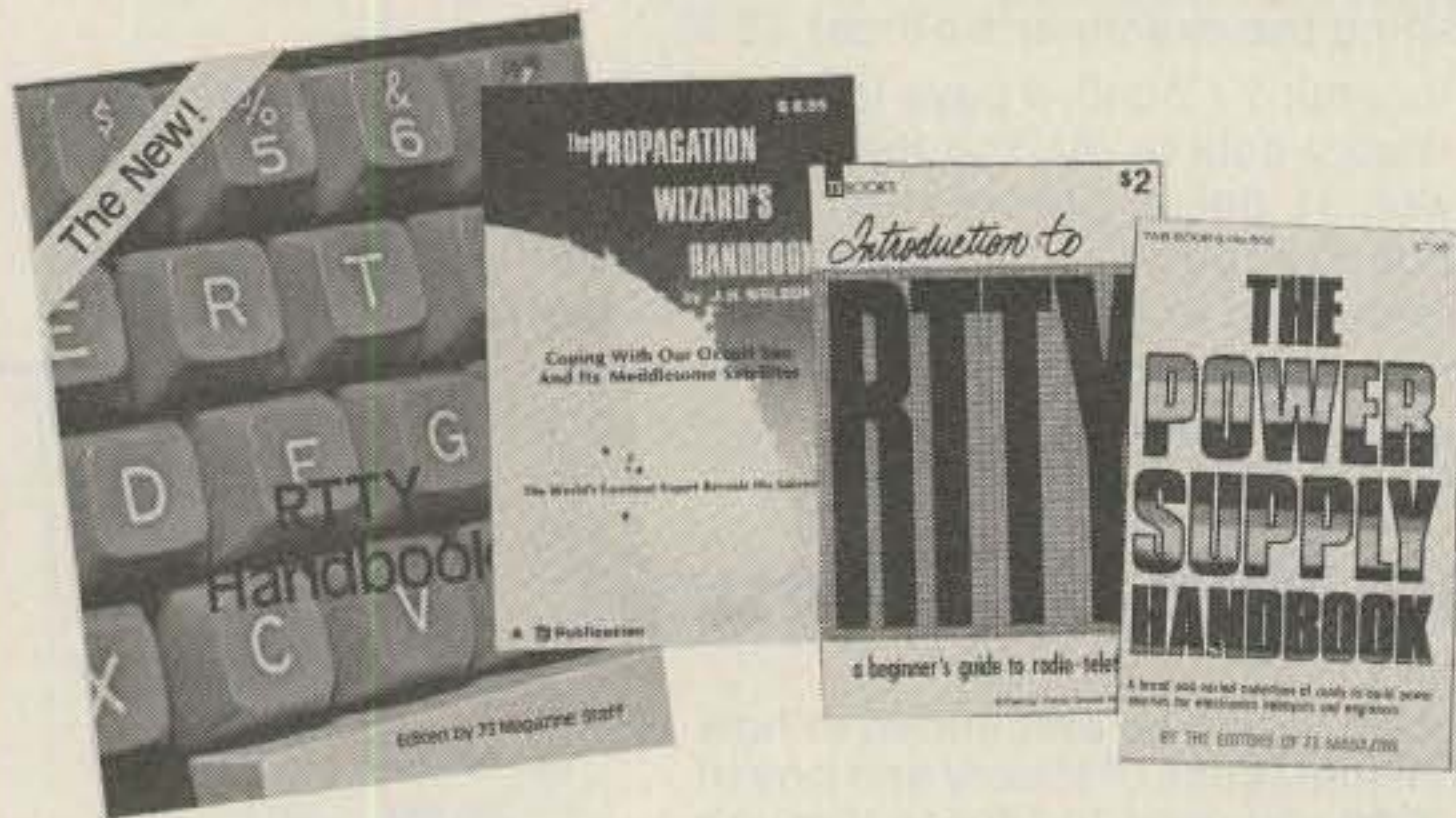

● **SSB . . . THE MISUNDERSTOOD MODE**—BK7351—by James B. Wilson. Single Sideband Transmission . . . thousands of us use it every day, yet it remains one of the least understood facets of amateur radio. J. B. Wilson presents several methods of sideband generation, amply illustrated with charts and schematics, which will enable the ambitious reader to construct his own sideband generator. A must for the technically-serious ham. \$5.50.*

● **SSTV HANDBOOK**—BK7354(hardcover), BK7355(softcover)—This excellent book tells all about it, from its history and basics to the present state-of-the-art techniques. Contains chapters on circuits, monitors, cameras, color SSTV, test equipment and much more. Hardbound \$7.00, softbound \$5.00.*



● **WEATHER SATELLITE HANDBOOK**—BK7370—Simple equipment and methods for getting good pictures from the weather satellite. Antennas, receivers, monitors, facsimile you can build, tracking, automatic control (you don't even have to be home). Dr. Taggart WB8DQT. \$4.95.*

● **TOOLS & TECHNIQUES FOR ELECTRONICS**—BK7348—is an easy-to-understand book written for the beginning kit builder as well as the experienced hobbyist. It has numerous pictures and descriptions of the safe and correct ways to use basic and specialized tools for electronic projects as well as specialized metal working tools and the chemical aids which are used in repair shops. \$4.95*

● **THE CONTEST COOKBOOK**—BK7308—reveals the secrets of the contest winners (Domestic, DX and specialty contests), complete with photos and diagrams of equipment used by the top scorers. Find out how to make 150 contacts in one hour. \$5.95*



Use the order card in the back of this magazine or itemize your order on a separate piece of paper and mail to:
Dept. F3 • 73 Radio Bookshop • Peterborough NH 03458. Include check or detailed credit card information.
*Add \$1.00 handling charge. Note: Prices subject to change on books not published by 73 Magazine.

FOR TOLL FREE ORDERING CALL 1-800-258-5473

Radio Bookshop

TEST EQUIPMENT

● **RF AND DIGITAL TEST EQUIPMENT YOU CAN BUILD**—BK1044—Rf burst, function, square wave generators, variable length pulse generators—100 kHz marker, i-f and rf sweep generators, audio osc, af/rf signal injector, 146 MHz synthesizer, digital readouts for counters, several counters, prescaler, microwave meter, etc. 252 pages. \$5.95.*

● **VOL. I COMPONENT TESTERS**—LB7359—... how to build transistor testers (8), diode testers (3), IC testers (3), voltmeters and VTVMs (9), ohmmeters (8 different kinds), inductance (3), capacity (9), Q measurement, crystal checking (6), temperature (2), aural meters for the blind (3) and all sorts of miscellaneous data on meters... using them, making them more versatile, making standards. Invaluable book. \$4.95.*

● **VOL. II AUDIO FREQUENCY TESTERS**—LB7360—... jam packed with all kinds of audio frequency test equipment. If you're into SSB, RTTY, SSTV, etc., this book is a must for you... a good book for hi-fi addicts and experimenters, too! \$4.95.*

● **VOL. III RADIO FREQUENCY TESTERS**—LB7361—Radio frequency waves, the common denominator of Amateur Radio. Such items as SWR, antenna impedance, line impedance, rf output and field strength; detailed instructions on testing these items includes sections on signal generators, crystal calibrators, grid dip oscillators, noise generators, dummy loads and much more. \$4.95.*

● **VOL. IV IC TEST EQUIPMENT**—LB7362—Become a troubleshooting wizard! In this fourth volume of the 73 TEST EQUIPMENT LIBRARY are 42 home construction projects for building test equipment to work with your ham station and in servicing digital equipment. Plus a cumulative index for all four volumes of the 73 TEST EQUIPMENT LIBRARY. \$4.95.*



THE WELL-EQUIPPED HAM SHACK

● **73 MAGAZINE BINDERS**—Preserve and protect your collection for your lifetime! There's no excuse for lost issues when you have these handsome red binders with gold lettering. Order 1—BN1001—for \$6.50*; 2 or more—BN1002—for \$6.00 each.* (specify 1978 or 1979 binders)

● **QSL CARDS**—73 turns out a fantastic series of QSL cards at about half the cost of having them done elsewhere because they are run as a fill-in between printing books and other items in the 73 Print Shop. 250 Style W—QW0250—for \$8.95*; 500 Style W—QW0500—for \$13.95*; 250 Style X—QX0250—for \$8.95*; 500 Style X—QX0500—for \$13.95*; 250 Style Y—QY0250—for \$8.95*; 500 Style Y—QY0500—for \$13.95.* Allow 6-12 wks. for delivery.

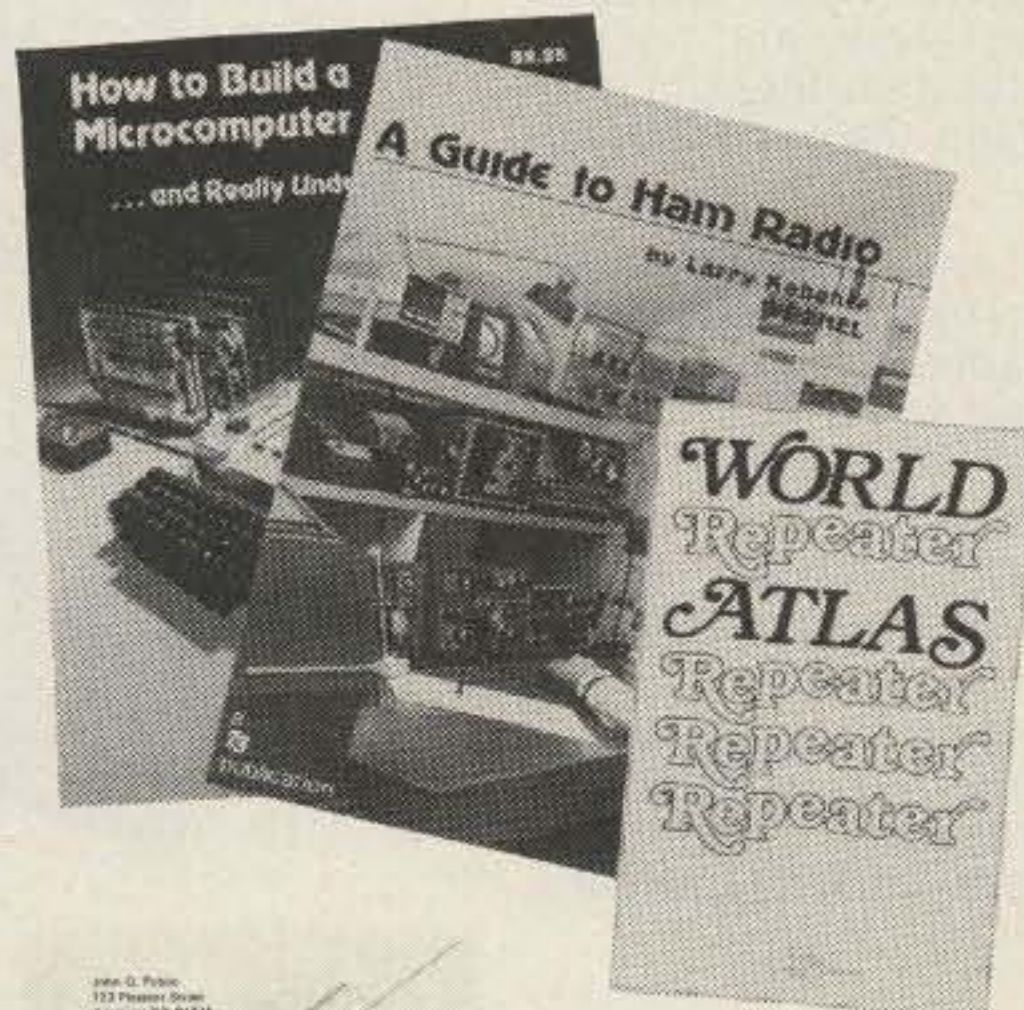
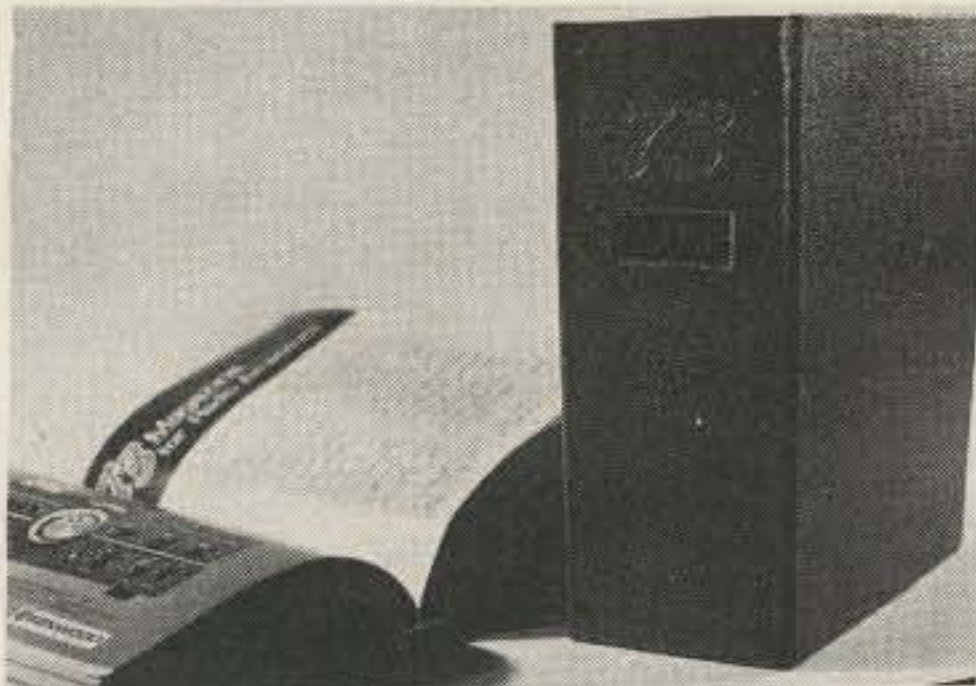

● **HOW TO BUILD A MICROCOMPUTER—AND REALLY UNDERSTAND IT**—BK7325—by Sam Creason. The electronics hobbyist who wants to build his own microcomputer system now has a practical "How-To" guidebook. Sam Creason's book is a combination technical manual and programming guide that takes the hobbyist step-by-step through the design, construction, testing and debugging of a complete microcomputer system. \$9.95.*

● **1980 WORLD REPEATER ATLAS**—BK1080—Completely updated for 1980, over 230 pages of repeater listings are indexed by location and frequency. More than 50 maps pinpoint 2000 repeater locations throughout the USA. Foreign listings include Europe, the Middle East, South America and Africa. \$4.95.*

● **BACK ISSUES**—Complete your collection; many are prime collectables now, classics in the field! A full collection is an invaluable compendium of radio and electronics knowledge!

WA6JYB

Style X

Style Y

W2NSD/1

Style W

W2NSD/1

Single back issue—ST0000—

\$3.00*;

25 your choice—ST2500—\$12.00*;

25 your choice—ST2501—\$25.00*;

5 your choice—ST0500—\$8.75*;

10 your choice—ST1000—\$14.00.*

● **OWNER REPAIR OF AMATEUR RADIO EQUIPMENT**—BK7310—Frank Glass shares over 40 years of operating, servicing, and design experience in this book which ranges from the elementary to the highly technical written for the top engineers in the field. It is written in narrative style on the subjects of electronic servicing, how components work, and how they are combined to provide communication equipment. This book will help you understand the concepts required to service station equipment. \$7.95.*

● **FREE BACK ISSUE CATALOGS** are yours for the asking... specify 73 Magazine and/or Kilobaud Microcomputing back issue catalog when you send your name and address to us on a postcard.

● **A GUIDE TO HAM RADIO**—BK7321—by Larry Kahaner WB2NEL. What's Amateur Radio all about? You can learn the basics of this fascinating hobby with this excellent beginner's guide. It answers the most frequently asked questions in an easy-going manner, and it shows the best way to go about getting an FCC license. A Guide to Ham Radio is an ideal introduction to a hobby enjoyed by people around the world. \$4.95.*

● **LIBRARY SHELF BOXES**—These sturdy white, corrugated, dirt-resistant boxes each hold a full year of 73 or Kilobaud Microcomputing. With your order, request self-sticking labels for any of the following: 73, Kilobaud Microcomputing, CQ, QST, Ham Radio, Personal Computing, Radio Electronics, Interface Age, and Byte. Order 1—BX1000—for \$2.00*; order 2-7—BX2002—for \$1.50 each*; order 8 or more—BX1002—for \$1.25 each*.

Use the order card in the back of this magazine or itemize your order on a separate piece of paper and mail to: Dept. F3 • 73 Radio Bookshop • Peterborough NH 03458. Include check or detailed credit card information.

*Add \$1.00 handling charge. Note: Prices subject to change on books not published by 73 Magazine.

FOR CUSTOMER SERVICE CALL (603) 924-7298

Radio Bookshop

● **73 DIPOLE AND LONG-WIRE ANTENNAS**—BK1016—by Edward M. Noll W3FQJ. This is the first collection of virtually every type of wire antenna used by amateurs. Includes dimensions, configurations, and detailed construction data for 73 different antenna types. Appendices describe the construction of noise bridges, line tuners, and data on measuring resonant frequency, velocity factor, and swr. \$5.50.*

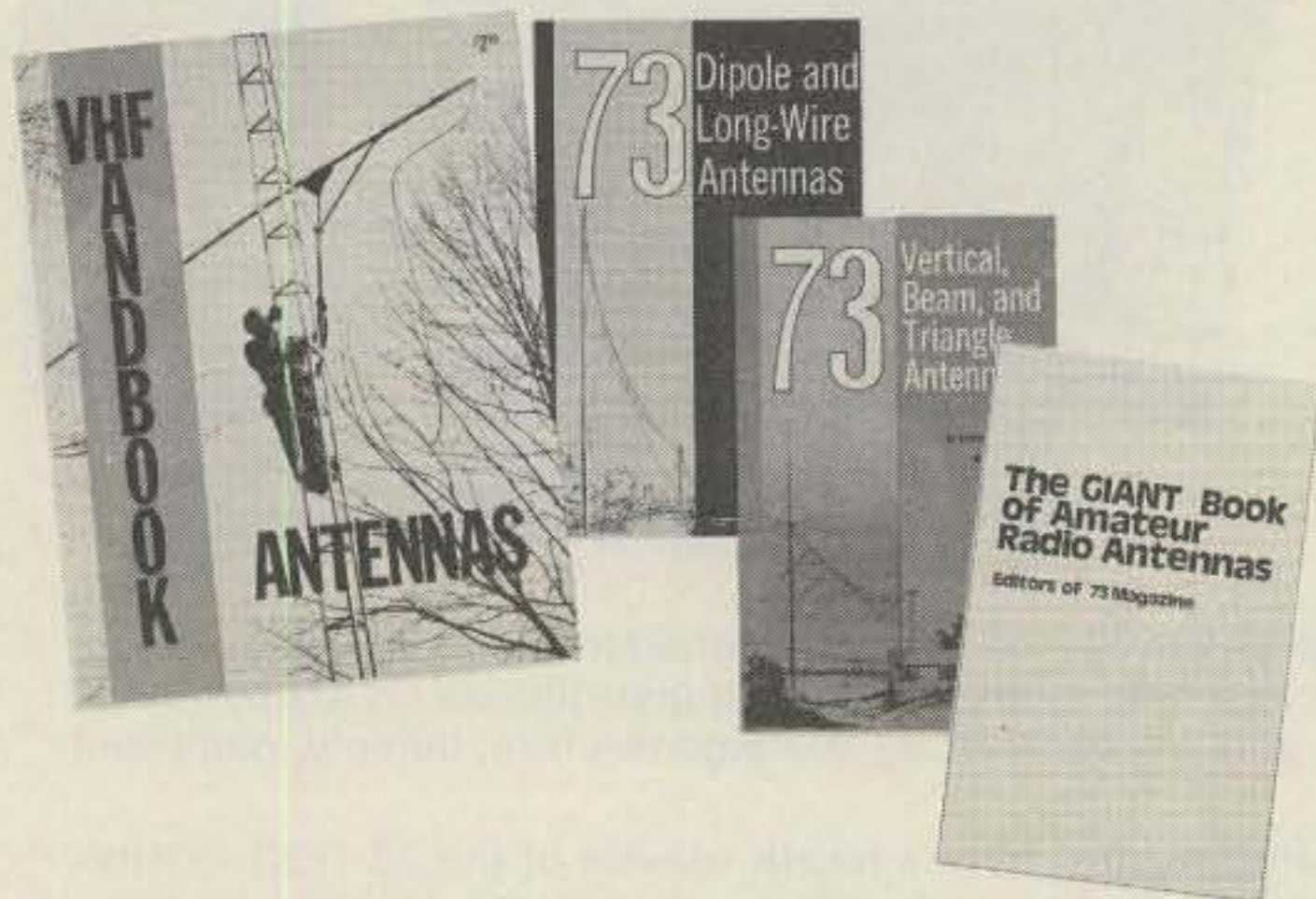

● **THE GIANT BOOK OF AMATEUR RADIO ANTENNAS**—With the **GIANT Book of Amateur Radio Antennas** by your side, antennas will become the least of your worries. Over 450 pages of design ideas, theory and reference data make this book live up to its title. The 7 chapters cover everything from basic antenna theory through designs for DIY accessories, as well as dozens of antenna designs. Whether planning to build or buy, design or admire, test or enjoy a ham antenna—this is the book for you. From the editors of 73; published by Tab Books. \$12.95* hardback—BK7304, \$8.95* paper—BK1104.

● **73 VERTICAL, BEAM AND TRIANGLE ANTENNAS**—BK1069—by Edward M. Noll W3FQJ. Describes 73 different antennas for amateurs. Each design is the result of the author's own experiments covering the construction of noise bridges and antenna line tuners, as well as methods for measuring resonant frequency, velocity factor, and standing-wave ratios. 160 pages. \$5.50.*

● **VHF ANTENNA HANDBOOK**—BK7368—The **NEW VHF Antenna Handbook** details the theory, design and construction of hundreds of different VHF and UHF antennas... A practical book written for the average amateur who takes joy in building, not full of complex formulas for the design engineer. Packed with fabulous antenna projects you can build. \$4.95.*

● **PRACTICAL ANTENNAS FOR THE RADIO AMATEUR**—BK1015—A manual describing how to equip a ham station with a suitable antenna. A wide range of antenna topics, systems, and accessories are presented giving the reader some food for thought and practical data for construction. Designed to aid the experienced ham and novice as well. Only \$9.95.*

● **TTL COOKBOOK**—BK1063—by Donald Lancaster. Explains what TTL is, how it works, and how to use it. Discusses practical applications, such as a digital counter and display system, events counter, electronic stopwatch, digital voltmeter and a digital tachometer. \$9.50.

● **CMOS COOKBOOK**—BK1011—by Don Lancaster. Details the application of CMOS, the low power logic family suitable for most applications presently dominated by TTL. Required reading for every serious digital experimenter! \$10.50.*

● **TVT COOKBOOK**—BK1064—by Don Lancaster. Describes the use of a standard television receiver as a microprocessor CRT terminal. Explains and describes character generation, cursor control and interface information in typical, easy-to-understand Lancaster style. \$9.95.*



● **BASIC NEW 2ND EDITION**—by Bob Albrecht. Self-teaching guide to the computer language you will need to know for use with your microcomputer. This is one of the easiest ways to learn computer programming. \$6.95.* (BK1081)

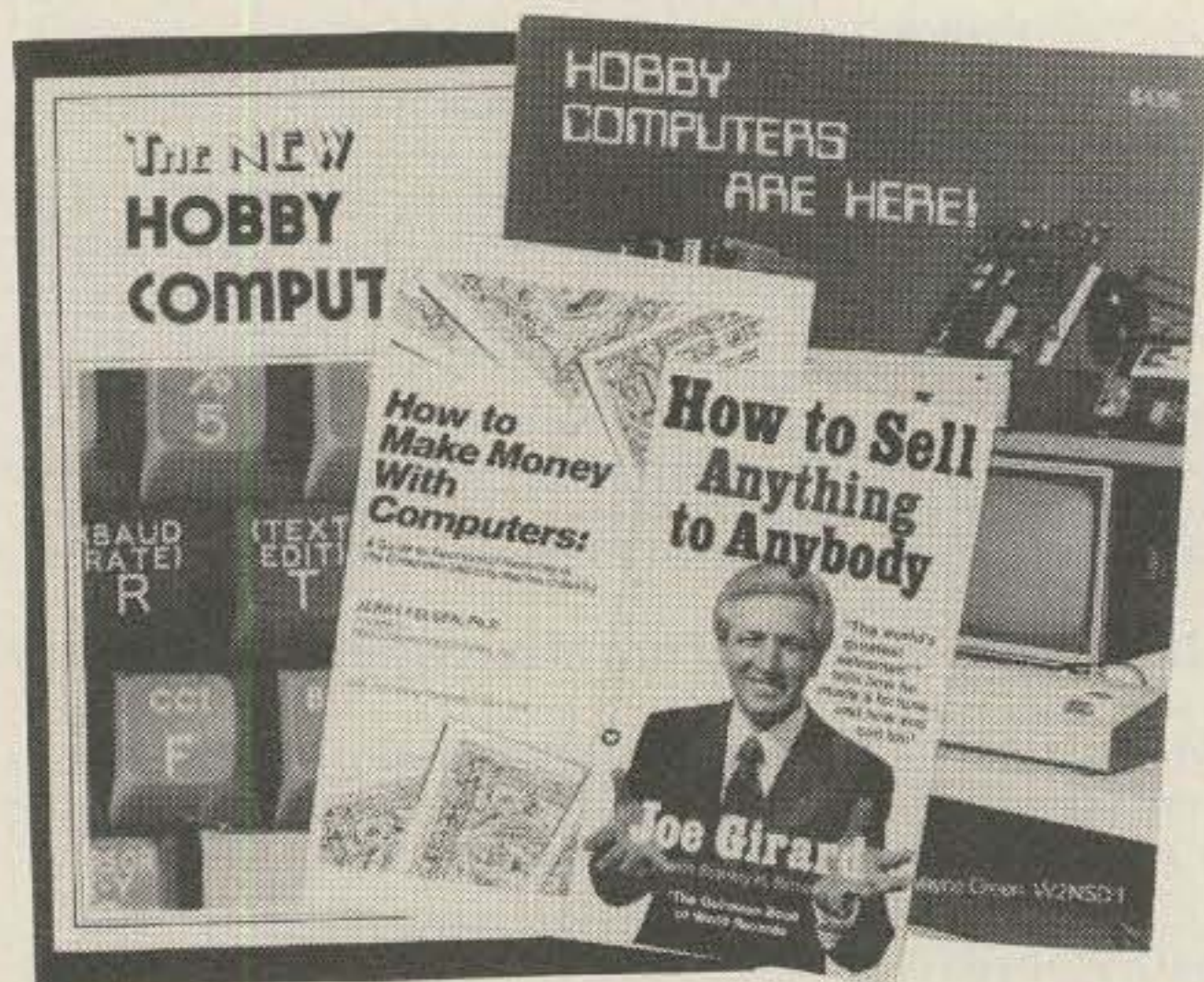

● **HOBBY COMPUTERS ARE HERE!**—BK7322—If you want to come up to speed on how computers work... hardware and software... this is an excellent book. It starts with the fundamentals and explains the circuits, the basics of programming, along with a couple of TVT construction projects, ASCII-Baudot, etc. This book has the highest recommendations as a teaching aid for newcomers. \$4.95.*

● **THE NEW HOBBY COMPUTERS**—BK7340—This book takes it from where **Hobby Computers Are Here!** leaves off, with chapters on Large Scale Integration, how to choose a microprocessor chip, an introduction to programming, low cost I/O for a computer, computer arithmetic, checking memory boards, a Baudot monitor/editor system, an audible logic probe for finding those tough problems, a ham's computer, a computer QSO machine... and much, much more! \$4.95*

● **HOW TO MAKE MONEY WITH COMPUTERS**—In 10 information-packed chapters, Jerry Felsen describes more than 30 computer-related, money-making, high profit, low capital investment opportunities. \$15.00.* (BK1003)

● **HOW TO SELL ANYTHING TO ANYBODY**—According to *The Guinness Book of World Records*, the author, Joe Girard, is "the world's greatest salesman." This book reveals how he made a fortune—and how you can, too. \$2.25.* (BK7306)

Use the order card in the back of this magazine or itemize your order on a separate piece of paper and mail to:
Dept. F3 • 73 Radio Bookshop • Peterborough NH 03458. Include check or detailed credit card information.

*Add \$1.00 handling charge. Note: Prices subject to change on books not published by 73 Magazine.

FOR TOLL FREE ORDERING CALL 1-800-258-5473

kilobaud

MICROCOMPUTING™

for business... education... FUN!

save
up to 50%

Yes! Please send me Kilobaud **MICROCOMPUTING** at a saving of 40% to 50% off the newsstand price.

- 12 issues for \$18 (save 40%)
 24 issues for \$30 (save 50%)
 36 issues for \$45 (save 50%)
 New subscription Renewal
 Payment enclosed \$ _____
 VISA MC AE Bill me

Card# _____ Exp. date _____

Signature _____

Name _____

Address _____

City _____ State _____ Zip _____

—for even faster service call toll-free (800) 258-5473

Canada: same as US, in US funds.
Other foreign: \$23 one year only, US funds.

302B55

MICROCOMPUTING • POB 997 • Farmingdale NY 11737

MOVING?

Let us know 8 weeks in advance so that you won't miss a single issue of 73 Magazine.

Attach old label where indicated and print new address in space provided. Also include your mailing label whenever you write concerning your subscription. It helps us serve you promptly. Write to:

73 magazine

Subscription Department
P.O. Box 931
Farmingdale NY 11737

- Address change only Payment enclosed
 Extend subscription
 Enter new subscription Bill me later
 1 year \$18.00

If you have no label handy, print OLD address here.

Name _____ Call _____

Address _____

City _____ State _____ Zip _____

print NEW address here:

Name _____ Call _____

Address _____

City _____ State _____ Zip _____

301B55

PROPAGATION

by
J. H. Nelson

Due to unforeseen circumstances, J. H. Nelson's "Propagation" was unavailable this month. His column will resume soon.

**1980 INTERNATIONAL
SSTV CONTEST**

Saturday, March 8, 1500 to 2300 GMT
Sunday, March 9, 1500 to 2300 GMT

SPONSOR 73 Magazine, Peterborough NH 03458 USA

OBJECT To exchange SSTV pictures with as many stations in as many parts of the world as possible during the contest periods.

FREQUENCIES All amateur frequencies between 3.5 and 29.7 MHz where SSTV is permitted.

EXCHANGE Exchange of pictures must include call sign, RST report, and consecutive contact number starting with 001. FCC rules require a verbal exchange of call signs for US stations. Do not include the contact number in the verbal exchange.

CREDITS One (1) point for each station worked. A station may be worked once on each band for credit. One (1) point for each US state or Canadian province worked. Five (5) points for each country worked. Five (5) points for each continent worked. Each state, province, country, and continent may be counted only once for credit. Total score is the sum of all credits.

ENTRIES Activity sheets should show station worked, state or province, country, continent, and band (80, 40, 20, 15, 10). Summary sheets should show number of stations worked, number of states and provinces worked, number of countries worked, number of continents worked, and total score. Entries become the property of the contest committee. Excessive discrepancies in a contest entry may cause disqualification. Contest entries must be postmarked no later than April 30, 1980. The decisions of the contest committee are final.

AWARDS The top scorer will receive a certificate and a one year subscription to 73 Magazine. Certificates will also be awarded to the station working the most countries and to the station working the most continents.

Send all entries to:

R. Brooks Kendall W1JKF
10 Stocker St.
Saugus MA 01906

or David Ingram K4TWJ
Eastwood Village, #1201 South
Rte. 11, Box 499
Birmingham AL 35210

AFFIX LABEL

READER SERVICE

A1 Adirondack Radio Supply..... 154	G36 Gregory Electronics..... 49	* Partridge Electronics, Ltd..... 156	Z5 "Z" Associates..... 138
A60 AED Electronics..... 46	* Hal Communications Corp..... 38, 53	P41 P.C. Electronics..... 124	From 73..... 99, 173-178
A92 AHF/Antennas..... 139	H24 Hal-Tronix..... 105	P2 Poly-Paks..... 167	From 80 Microcomputing..... 94
A2 Aldelco..... 65	H2 Ham Radio Center..... 7, 29	P80 Protronics, Inc..... 75	
A21 Amateur-Wholesale Electronics..... 121	H16 Hamtronics, NY..... 149, 171	Q3 Quest Electronics..... 157	
A106 AMC Engineering..... 62	H5 Heath Co..... 148	R1 Radio Amateur Callbook..... 137	
A58 American Crystal Supply..... 155	H3 Henry Radio..... CII	* Radio World..... 62	
* AMSAT..... 71	H44 HFT, Inc..... 156	R8 Ramsey Electronics..... 169	
A6 Apron Laboratories..... 80	* ICOM..... 15	R27 RF Power Labs, Inc..... 135	
A105 A R Technical Products..... 68	I45 Info-Tech, Inc..... 34, 62	S110 Selectone..... 149	
* Associated Radio..... 166	I48 International Crystal Mfg..... 137	S63 Semiconductors Surplus..... 160, 161	
A93 Avanti Research & Development..... 31	I27 iRL..... 89	S33 S-F Amateur Radio Services..... 136, 139	
B23 Barker-Williamson..... 139	J1 Jameco Electronics..... 165	S130 Signalcrafters, Inc..... 37, 132	
B8 Bullet Electronics..... 149, 172	J2 Jan Crystals..... 62	S117 Spacecoast Research..... 138	
C162 Castle Publishing..... 138	* Kantronics..... 133	S81 Spectronics, Inc..... 162, 163	
C3 Clegg..... 89	* Kenwood..... CIV, 5	S8 Spectrum Communications..... 40, 41	
C58 Communications Center, NE..... 119	K4 KLM Electronics..... 31	S43 Surplus Electronics..... 168	
C6 Communications Specialists..... 16, 17	L28 LaRue Electronics..... 65	S44 Swan Electronics..... 26, 27, 136	
D29 Dielectric Communications..... 132	L9 Long's Electronics..... 126-131	T64 Technical Clinic..... 138, 156	
* Digital Research: Parts..... 170	L17 Lunar Electronics..... 85	T52 Tele-Tow'r Mfg..... 22	
D76 Digitrex Electronics..... 138	M48 Macrotronics, Inc..... 132	* Ten-Tec, Inc..... 19	
D75 Discoil..... 34	M35 Madison Electronics Supply..... 49, 85, 133	T55 TET, USA..... 125	
D25 DSI Instruments..... 13, 33, 147	M36 Maggiore Electronic Lab..... 156	T77 Texas Towers..... 115	
D73 Dynamic Electronics..... 156	M52 MFJ Enterprises..... 29, 102, 133, 136, 138	T34 Thomas Communications..... 95	
* Electronics Book Club..... 21	M8 MHz Electronics..... 158, 159	T18 Trac Electronics..... 46	
F5 Flesher Corporation..... 46	M69 Micro Control Specialists..... 139	T3 Tufts Radio Electronics..... 60, 61, 65	
F25 Fotografix..... 148	M55 Microlog Corp..... 9	U13 Ultima Electronics, Ltd..... 156	
F24 Fox-Tango..... 148	M62 Mid Com Electronics, Inc..... 73	W15 Wacom Products..... 139	
G27 Gemini Instrument..... 156	M109 Mil Industries..... 139	W18 Western Electronics..... 154	
G12 Germantown Amateur Supply..... 110	M92 J W Miller Div Bell Industries..... 65	W2 Wilson Electronics..... 3	
G26 G & G Electronics..... 138	M128 MOM's..... 100, 101	W33 Wilson Systems..... 23-25	
G22 G.I.S.M.O..... 68	O5 OK Machine & Tool..... 90, 91, 149	X3 Xitex Corp..... 98	
G4 Godbout Electronics..... 164	O3 Optoelectronics, Inc..... 111	Y1 Yaesu Electronics Corp..... CIII, 69, 81, 145	
	* Palomar Engineers..... 22		

*Reader Service inquiries not honored. Please contact advertiser directly.

BOOKS, ETC.

BK1016 73 DIPOLE & LONG WIRE ANTENNAS..... \$ 5.50	BK7305 POWER SUPPLY HANDBOOK..... \$ 7.95
ST0000 73 BACK ISSUE..... \$ 3.00	BK1015 PRACTICAL ANTENNAS FOR THE RADIO AMATEUR..... \$ 9.95
ST2500 73 BACK ISSUES - 25 OUR CHOICE..... \$12.00	BK7302 PROPAGATION WIZARD'S HANDBOOK..... \$ 6.95
ST0500 73 BACK ISSUES - 5 YOUR CHOICE..... \$ 8.75	QW0250 QSL CARDS - STYLE W - 250..... \$ 8.95
ST1000 73 BACK ISSUES - 10 YOUR CHOICE..... \$14.00	QW0500 QSL CARDS - STYLE W - 500..... \$13.95
ST2501 73 BACK ISSUES - 25 YOUR CHOICE..... \$25.00	QX0250 QSL CARDS - STYLE X - 250..... \$ 8.95
BK1081 BASIC NEW 2ND EDITION..... \$ 6.95	QX0500 QSL CARDS - STYLE X - 500..... \$13.95
BK7307 BEHIND THE DIAL..... \$ 4.95	QY0250 QSL CARDS - STYLE Y - 250..... \$ 8.95
BN1001 BINDER - 73 - 1..... \$ 6.50	QY0500 QSL CARDS - STYLE Y - 500..... \$13.95
BN1002 BINDER - 73 - 2 AND UP..... \$ 6.00	BK1080 1980 WORLD REPEATER ATLAS..... \$ 4.95
BK7309 CHALLENGE OF 160..... \$ 4.95	BK1044 RF DIGITAL TEST EQUIPMENT..... \$ 5.95
CT7305 CODE TAPE - 5 WPM..... \$ 4.95	BK7347 RTTY HANDBOOK..... \$ 5.95
CT7306 CODE TAPE - 6+ WPM..... \$ 4.95	BX1000 SHELF BOX - 1..... \$ 2.00
CT7313 CODE TAPE - 13+ WPM..... \$ 4.95	BX1001 SHELF BOXES - 2..... \$1.50 each
CT7320 CODE TAPE - 20+ WPM..... \$ 4.95	BX1002 SHELF BOXES - 8 AND UP..... \$1.25 each
CT7325 CODE TAPE - 25+ WPM..... \$ 4.95	BK7351 SSB THE MISUNDERSTOOD MODE..... \$ 5.50
CT7394 CODE TAPES (ANY FOUR ABOVE)..... \$15.95	BK7354 SSTV HANDBOOK (HARDCOVER)..... \$ 7.00
BK7308 THE CONTEST COOKBOOK..... \$ 5.95	BK7355 SSTV HANDBOOK (SOFTCOVER)..... \$ 5.00
BK7321 GUIDE TO HAM RADIO..... \$ 4.95	CT7350 SSTV TAPE..... \$ 5.95
BK7304 GIANT BOOK OF AMATEUR RADIO ANTENNAS..... \$12.95	SG1081 STUDY GUIDE - ADVANCED CLASS..... \$ 6.95
BK7322 HOBBY COMPUTERS ARE HERE..... \$ 4.95	SG1080 STUDY GUIDE - EXTRA CLASS..... \$ 5.95
BK7325 HOW TO BUILD A MICROCOMPUTER & REALLY UNDERSTAND IT..... \$ 9.95	SG7358 STUDY GUIDE - GENERAL CLASS..... \$ 5.95
BK1003 HOW TO MAKE MONEY WITH COMPUTERS..... \$15.00	SG7357 STUDY GUIDE - NOVICE CLASS..... \$ 4.95
BK7306 HOW TO SELL ANYTHING TO ANYBODY..... \$ 2.25	LB7359 TEST EQUIP LIB V1 - COMP TESTERS..... \$ 4.95
BK1028 IC OP AMP COOKBOOK..... \$12.95	LB7360 TEST EQUIP LIB V2 - AUDIO TESTERS..... \$ 4.95
BK7380 INTRO TO RTTY..... \$ 2.00	LB7361 TEST EQUIP LIB V3 - RADIO EQUIP..... \$ 4.95
BK7340 THE NEW HOBBY COMPUTERS..... \$ 4.95	LB7362 TEST EQUIP LIB V4 - IC TEST EQUIP..... \$ 4.95
CT7300 NOVICE THEORY TAPES..... \$15.95	BK7348 TOOLS & TECHNIQUES..... \$ 4.95
BK7310 OWNER REPAIR OF AMATEUR RADIO EQUIPMENT..... \$ 7.95	BK1063 TTL COOKBOOK..... \$ 9.50
	BK1064 TVT COOKBOOK..... \$ 9.95
	BK1069 VERTICAL BEAM & TRIANGLE ANTNS..... \$ 5.50
	BK7368 VHF ANTENNA HANDBOOK..... \$ 4.95
	BK7370 WEATHER SATELLITE HANDBOOK..... \$ 4.95

FT-707 is shown with optional FV-707DM VFO & Scanning Microphone



THE FT-707 "WAYFARER"

The introduction of the "WAYFARER" by Yaesu is the beginning of a new era in compact solid state transceivers. The FT-707 "WAYFARER" offers you a full 100 watts output on 80-10 meters and operates SSB, CW, and AM modes. Don't let the small size fool you! Though it is not much larger than a book, this is a full-featured transceiver which is ideally suited for your home station or as a traveling companion for mobile or portable operation.

The receiver offers sensitivity of .25 μ V/10 dB SN as well as a degree of selectivity previously unavailable in a package this small. The "WAYFARER" comes equipped with 16 poles of IF filtering, variable bandwidth and optional crystal filters for 600 Hz or 350 Hz. Just look at these additional features:

FT-707 with Standard Features

- Fast/slow AGC selection
- Advanced noise blanker
- Built-in calibrator
- WWV/JJY Band
- Bright Digital Readout
- Fixed crystal position
- 2 auxiliary bands for future expansion
- Unique multi-color bar metering—monitors signal strength, power output, and ALC voltage.

FT-707 with Optional FV-707DM & Scanning Microphone

- Choice of 2 rates of scan
- Remote scanning from microphone
- Scans in 10 cycle steps
- Synthesized VFO
- Selection of receiver/transmitter functions from either front panel or external VFO
- "DMS" (Digital Memory Shift)

Impressive as the "WAYFARER" is its versatility can be greatly increased by the addition of the FV-707DM (optional). The FV-707DM, though only one inch high, allows the storage of 13 discrete frequencies and with the use of "DMS" (Digital Memory Shift) each memory can be band-spread 500 KHz. These 500 KHz bands may be remotely scanned from the microphone at the very smooth rate of 10 Hz steps.

The FT-707 "WAYFARER" is a truly unique rig. See it today at your authorized Yaesu Dealer.

YAESU

The radio.



YAESU ELECTRONICS CORP., 6851 Walthall Way, Paramount, CA 90723 • (213) 633-4007
YAESU ELECTRONICS Eastern Service Ctr., 9812 Princeton-Glendale Rd., Cincinnati, OH 45246

KENWOOD'S TR-2400

...synthesized, BIG LCD,
10 memories,
scanning...and more!

Kenwood TR-2400...It's a synthesized 2 meter hand-held transceiver...the answer to any Amateur's operating requirements! Its many advanced features include:



CONVENIENT TOP CONTROLS

- **LCD digital readout**
 - Readable in direct sunlight (better than LEDs)
 - Readable in the dark (with lamp switch)
 - Virtually no current drain (much less than LEDs) and display stays on
 - Shows receive and transmit frequencies and memory channel
- **10 Memories** (always retained with battery backup)
- **Automatic memory scanning** (for "busy" or "open" channels)
- **Mode switch for the following operations:**
 - Simplex
 - Standard repeater by offsetting the transmit frequency + 600 kHz or - 600 kHz
 - Repeater with nonstandard splits by offsetting the transmit frequency to any frequency stored in memory 10
- **REVERSE** momentary switch for the following applications:
 - Checking signals on the input of a repeater
 - Determining if a repeater is "upside down"
- **Built-in Touch-Tone generator** using 16-button keyboard
- **Keyboard selection** of 5-kHz channels from 144.000 to 147.995 MHz
- **UP/DOWN manual scanning** and operation from 143.900 to 148.495 MHz in single or fast continuous 5-kHz steps. Even operates on MARS repeaters within this range by using memory 10 for transmit offset frequency.
- **LCD "arrow" indicators**
 - "ON AIR"
 - Memory recall
 - Battery status
 - Lamp switch on
- **Two lock switches** to prevent accidental frequency change and accidental transmission
- **Subtone switch** (subtone module not Kenwood-supplied)
- **BNC antenna connector**
- **1.5 watts RF output**

The TR-2400 comes with the following standard accessories:

- Flexible rubberized antenna with BNC connector
- Nicad battery pack
- Battery charger

Optional accessories include:

- Leather case
- Base Stand (for quick charge and easy base-station operation)
- DC (automobile) quick charger



ST-1 BASE STAND (OPTIONAL)



SEE YOUR AUTHORIZED
KENWOOD DEALER FOR MORE
INFORMATION ON THE TR-2400.

 **KENWOOD**
...pacesetter in amateur radio

TRIO-KENWOOD COMMUNICATIONS INC.
1111 WEST WALNUT/COMPTON, CA 90220