



MODEL: BIG BORE BOUNTY HUNTER Single Action Revolver



WARNINGS AND INSTRUCTION MANUAL

**European American Armory Corp.
402 Richard Road
Rockledge, Florida 3232955
(321) 639-4842
www.eaacorp.com
E-mail: eaacorp@eaacorp.com**

© Copyright 2004

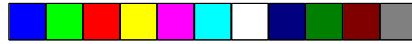

Model: Big Bore Bounty Hunter Single Action Revolver

WARNINGS AND INSTRUCTION MANUAL PLEASE READ THESE INSTRUCTIONS

MODEL NUMBER	BARREL LENGTH	CALIBERS	FINISH
Bounty Hunter 357	4 1/2" or 7 1/2"	.357 Mag.	Blue, Case, Nickel
Bounty Hunter 45	4 1/2" or 7 1/2"	.45 Long Colt	Blue, Case, Nickel
Bounty Hunter 44	4 1/2" or 7 1/2"	.44 Mag.	Blue, Case, Nickel

GENERAL INFORMATION:

Capacity- 6 chambers (load only 5); Safety Transfer Bar
Sights- fixed or adjustable; Grips- European Walnut
Weight (average) – 4 1/2" Barrel = 40 oz.; 7 1/2" = 44 oz.
Overall Length – 4 1/2" Barrel = 10"; 7 1/2" = 13"

FOR YOUR SAFETY AND THE SAFETY OF OTHERS, this owner's manual contains important warnings, instructions and safety procedures which must be understood **BEFORE** using this firearm. Read the **ENTIRE MANUAL** and if you do not understand any part of it or the operation of your revolver, stop and seek professional firearms instruction. You can get a copy of this manual from European American Armory Corp. upon request.

Record the serial number of your firearm (located on the bottom front of the frame):

and a description of it:

Make a copy of this manual and the proof of purchase/sales record for safekeeping in a secure safe or fireproof container. Such proof is necessary if the firearm is damaged, stolen or sent in for warranty repair.

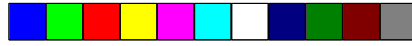

W A R N I N G
****YOU RISK PERSONAL INJURY OR DEATH**
BY HANDLING THIS FIREARM**

Before handling any firearm, make sure you know the safety procedures and most importantly, keep the firearm pointed in a safe direction.

DO NOT USE THIS FIREARM FOR QUICK-DRAW. DO NOT FAN THE HAMMER AND DO NOT MODIFY OR ALTER ANY PART OF THIS FIREARM.

Before handling this firearm, read, understand and follow the instructions in this manual. Always keep this manual with the firearm. If you lend, give or sell this firearm, be sure the manual goes with it. If there is anything you do not understand, seek advice from someone qualified in safe handling of firearms. You must ALWAYS obey the following warnings, instructions and safety procedures:

1. Always keep the muzzle pointed in a safe direction.
2. Firearms should be unloaded and secured when not actually in use.
3. Don't rely on your firearm's safety.
4. Be sure of your target and what's beyond it.
5. Use only proper ammunition matching the precise caliber of your specific revolver.
6. If your revolver fails to fire when the trigger is pulled, handle with care.
7. Always wear ear and eye protection when shooting.
8. Be sure the barrel is clear of obstructions before shooting.
9. Don't alter or modify your firearm and have it serviced regularly.
10. Learn the mechanical and handling characteristics of your revolver.
11. Shoot sober!

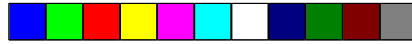

Type Of Ammunition To Be Used

It is suggested that high quality commercially manufactured ammunition be used in this firearm. Avoid military surplus or old ammunition as it may not fire with sufficient force to expel the projectile from the barrel. **The use of reloaded, Super-Vel, +P, high pressure or hand-loaded ammunition can be dangerous and will void the warranty.**

LEAD WARNING: The actual firearm does not contain any lead; however, it does fire ammunition which contains lead or lead compounds known to the State of California to cause cancer, birth defects, reproductive toxicity, and other serious physical injury. Those who discharge a firearm, stand near someone who discharges a firearm or clean firearms are hereby warned of the dangers presented by lead and lead compounds and should take protective health measures. Avoid exposure to lead while handling and wash your hands after contact. Proper air ventilation is absolutely necessary when shooting indoors.

NOTICE

REVOLVERS ARE CLASSIFIED AS FIREARMS OR DANGEROUS WEAPONS and are sold by European American Armory Corp. with the specific understanding that we are not responsible in any manner whatsoever for their safe handling or resale under local laws and regulations.

European American Armory Corp. shall not be responsible in any manner whatsoever for malfunctioning of the firearm, for physical injury or for property damage resulting in whole or in part from **(1)** intentional or negligent discharge, **(2)** improper or careless handling, **(3)** unauthorized modifications and/or alteration of the internal/safety mechanisms, **(4)** defective, improper, high pressure, hand-loaded, or reloaded ammunition, **(5)** corrosion and/or lack of proper maintenance **(6)** neglect, or **(7)** other influences beyond our direct and immediate control. This limitation applies regardless of whether liability is asserted on the basis of contract, negligence or strict liability (including any failure to warn). Under no circumstance shall European American Armory Corp. be liable for incidental or consequential damages, such as loss of use of property, commercial loss and loss of earnings or profits.



FOLLOWING THESE SAFETY RULES CAN SAVE YOUR LIFE OR THE LIFE OF SOMEONE ELSE

Get competent firearms instruction in safe handling before using this firearm. Please ask your dealer for names of qualified instructors near you. All guns are extremely dangerous if carelessly handled or used. Remember that the firearm user is the primary “safety” and that reliance on any mechanical safety device should never replace safe handling procedures.

This firearm **WILL FIRE** if a cartridge is in the chamber, the hammer is fully cocked and the trigger is pulled.

DO NOT LOAD THIS REVOLVER UNTIL YOU UNDERSTAND HOW IT OPERATES. KEEP this revolver unloaded at all times except when you are ready to fire and are sure of your target.

ALWAYS carry this revolver in a case or original box unloaded.

NEVER point this revolver at anything that is not your intended target even if the revolver is unloaded. When loading, unloading, cleaning or handling, always be sure the muzzle is pointed in a safe direction and always keep your finger off the trigger.

NEVER assume any gun is unloaded. Before handling, check to make sure the chamber is empty. See Unloading Instructions. Make sure you know that this or any firearm is fully unloaded before displaying or handling it. When handling any firearm, keep your fingers away from the trigger at all times until you intend to fire.

Get instructions from a competent firearms instructor before using this or any firearm. Learn from a professional how to handle, load, unload, operate, fire and care for your gun.

NEVER PLAY with your firearm. It is not a toy and can be a very dangerous weapon that can cause serious personal injury or death.

Always keep the gun pointed in a safe direction. Treat every gun as if it is loaded...all the time. **NEVER** point any firearm (loaded or unloaded) at any person or anything you do not intend to shoot. Always keep your gun unloaded until ready to use and make sure that it is unloaded before cleaning.

Keep your finger **OFF** the trigger until you are actually aiming at the target and ready to shoot. Learn to rest your finger outside of the trigger guard.

Never rely on a gun’s “safety” to protect you from unsafe gun handling. A safety is only a mechanical device, not a substitute for using common sense and following gun safety procedures.

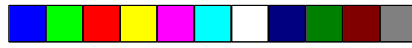

FOLLOWING THESE SAFETY RULES CAN SAVE YOUR LIFE OR THE LIFE OF SOMEONE ELSE

Never leave a gun unattended or where it could fall.

Store guns and ammunition separately **beyond the reach of children**. Make sure that they are properly secured so untrained individuals and children will be denied access to your guns and ammunition.

Test your gun's operation and safeties only at a shooting range while the firearm is pointed in a safe direction.

Know your target and what is beyond. Ask yourself what your projectile will hit if it misses the target or passes through the intended target. Remember, a fired projectile can travel over a mile (including a ricochet) and is capable of going through walls. Never shoot at hard flat surfaces or water. . . bullets ricochet.

Guns and alcohol or drugs do not mix. Don't take any alcoholic beverages and/ or drugs before or during shooting activities.

Never pull a gun toward you by the muzzle. Don't climb a tree, cross a ditch or fence with a loaded gun.

Always empty guns before entering a house, car, truck, boat, RV, camp or any building.

When receiving a gun, always open the action and check to make sure the chamber is unloaded.

NEVER accept anyone's word that a gun is "unloaded" or "empty." You should immediately open the action and check to make sure it is unloaded.

Be careful with **ALL** ammunition. Even "blank" cartridges are deadly at close range due to the muzzle blast. Make sure your ammunition is new and in good clean condition. Do **NOT** oil or grease ammunition as this may damage the cartridge primer. Do **NOT** tamper with or alter the standard factory ammunition.

Keep firearms unloaded when not actually in use. Load the gun only when on the range preparing to fire and unload it before leaving the range.

Never put your hand over the muzzle of a gun.

ALWAYS WEAR protective shooting glasses and hearing protection when using firearms.

Spectators should be at least 10 feet behind and away from the shooter while the

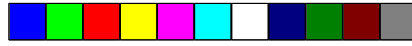

FOLLOWING THESE SAFETY RULES CAN SAVE YOUR LIFE OR THE LIFE OF SOMEONE ELSE

shooter is loading, shooting and unloading. Spectators should wear protection for hearing and sight loss and they should avoid distracting those shooting their firearms.

Never carry a handgun in your pocket, purse or tucked in a belt or waistband. Use a revolver case or a proper holster with a safety flap or strap.

Never drop your gun. If you do drop it, unload it and check it for proper function before using it again.

Do **NOT** alter or modify your gun. Don't try to change your gun's trigger pull, because it may affect sear engagement and thereby cause accidental firing.

Do **NOT** remove any internal safety or safety device on the firearm. Safety mechanisms are designed to help protect you from injury or death.

Properly maintain and keep your gun clean. Keep in a dry place away from other metals and water. If your gun shows sign of corrosion or improper operation, have it serviced by a competent gunsmith.

Keep the muzzle pointed in a safe direction when loading and unloading your gun. Never point the muzzle at anyone.

If a gun fails to fire when the trigger is pulled, keep it pointed down range at the target for 60 seconds. Sometimes slow primer ignition may cause a delay in full ignition of a cartridge. If after 60 seconds the cartridge does not fire, keep the muzzle pointed in safe direction and avoid exposure to the breech, as you attempt to unload your firearm.

Never let water, snow, mud or other material enter the barrels. Always be sure the barrel is free of any obstruction.

Since many ammunition identifications sound similar, be sure that you use only the correct ammunition for your gun. Do **NOT** use the wrong size or wrong strength ammunition in your firearm.

Teach children: 1. **NOT** to touch guns, bullets, cartridges, shells, flares or any explosive device and 2. That if they discovery such a dangerous item or weapon, they must immediately report its location to their parents, school teacher or police.

Remember a firearm has the capability of taking your life or the life of someone else. Be careful with your firearm — an accident is almost always the result of not following basic safety rules.

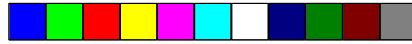

Use the Security Lock Provided with your Revolver

This revolver comes with a security lock to assist in protecting against unauthorized use. See **Figure 1**. The revolver must be unloaded when the security lock is in place on the revolver. **WARNING:** Using the security lock cannot substitute for securing your firearm and ammunition in separate, locked locations.



Figure 1

Use either of the following two methods to install the security lock provided with your Big Bore:

Method 1

- 1) Remove the provided security lock and block from its package. See **Figure 1**.
- 2) Install the block on the trigger (see **Figure 2**) and then install the security lock on the security block. See **Figure 3**. Next, close the security lock. See **Figure 4**.



Figure 2



Figure 3



Figure 4

Method 2

- 1) Looking at the trigger guard there is a hole in the center bottom. See **Figure 5**.
- 2) Insert the lock through the hole and close the lock. See **Figures 6 and 7**.

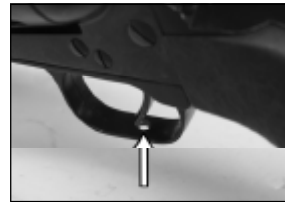

Figure 5

⚠ WARNING

Always store the key to the security lock: (1) in a separate location away from the revolver; (2) in a secure location unknown and not accessible to others, especially children.

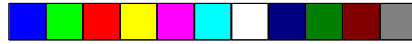

Figure 6



Figure 7

Whether you secure your firearms by using the supplied security lock, a gun lock or safe or some other mechanism, it is **YOUR RESPONSIBILITY** to store your firearms in such a manner that children and other unauthorized persons cannot gain access to them.



USED FIREARMS - Firearms are sometimes altered to work incorrectly, or parts may be removed, lost or replaced with incorrect parts. If you got your European American Armory Corp. firearm as a used gun, **BEFORE USING IT** you should take it to a good gunsmith who knows European American Armory Corp. firearms, and have him examine it.

WRITE EUROPEAN AMERICAN ARMORY CORP. concerning any items or circumstances which you don't understand and which might relate to your safety and the operation of your firearm at: European American Armory Corp., 402 Richard Road, Florida 32955 (321) 639-4842.

 **W A R N I N G (POTENTIAL OBSTRUCTIONS)**

BEFORE LOADING or firing a revolver, examine the bore and the firing chamber to be certain they are clean and free of any obstruction. Even a heavy coat of oil, grease, snow or water may result in damage to the firearm and injury to the shooter and/or persons near the firearm. A misfire or unusual sound upon firing is a signal to cease firing and to examine the chamber and bore. If there is any obstruction, clear the obstruction and clean the bore and chamber before firing.

Any bore obstruction, even if it is only partly blocked, may cause the gun to blow up if it is fired, or may cause damage to the gun such as a bulged barrel. To avoid injury or death to the shooter or bystanders, check the barrel before shooting or if a shot does not sound normal.

 **W A R N I N G**

Always keep the muzzle pointed in a safe direction! Never attempt to load or unload any firearm inside a vehicle, building or other confined space (except a properly constructed shooting range). Enclosed areas frequently offer no completely safe direction in which to point the firearm. If an accidental discharge occurs, there is great risk of death, personal injury or property damage. Before loading, always clean all, grease and oil from the bore and chamber, and check to be certain that no obstruction is in the barrel. Any foreign matter in the barrel could result in a bulged or burst barrel or other damage to the firearm and could cause serious injury to the shooter or to others.

 **W A R N I N G**

If there is any reason to suspect that a projectile or any other object is obstructing the barrel, immediately unload the firearm (See Unloading Instructions) and check the chamber and the bore. A wad, shot or some other matter that may be lodged some distance down the barrel where it can not easily be seen. Check the bore by using a cleaning rod to pass through the barrel. If a blockage is in the bore, **DO NOT ATTEMPT TO SHOOT IT OUT WITH ANOTHER CARTRIDGE, OR BLOW IT OUT WITH A BLANK CARTRIDGE OR A CARTRIDGE FROM WHICH THE SHOT HAS BEEN REMOVED. SUCH TECHNIQUE(S) CAN GENERATE EXCESSIVE PRESSURE, DAMAGE THE FIREARM AND CAUSE SERIOUS PERSONAL INJURY.** If the blockage can be removed with a cleaning rod, clean

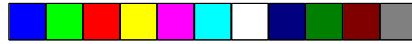

any unburned powder grains from the bore, chambers and mechanism before resuming shooting. If the blockage can not be dislodged by tapping it with a cleaning rod, take the firearm to a gunsmith.

⚠ WARNING (EYE AND EAR PROTECTION)

When shooting, full eye and ear protection is mandatory at all times. Shooters and spectators must wear shooting glasses and hearing protection to prevent eye injury and hearing loss. Vision and hearing impairment can occur with only one moment of non-protection.

⚠ WARNING (Mechanical Malfunctions)

STOP SHOOTING IMMEDIATELY AND UNLOAD YOUR FIREARM if your firearm develops: a mechanical malfunction; binding or stoppage; spitting powder/gas; a punctured cartridge primer; a bulged or ruptured cartridge case; or a sound on firing does not sound quite right. Do **NOT** try one more shot but unload your firearm and take it and the ammunition to a qualified gunsmith or send the firearm back to European American Armory Corp. for examination. Do not assume that the revolver is empty merely because you checked the chamber. You must also check the bore for any bullet or other material jammed inside the barrel.

BASIC PARTS OF YOUR REVOLVER

INTERNAL AND EXTERNAL CONTROL PARTS:

Internal Transfer Bar Safety: The safety mechanism of the revolver provides protection against accidental and unintentional discharge under normal usage when properly engaged and in good working order. The safety mechanism is not a substitute for following the rules of safe gun handling. ***MAKE SURE YOU UNDERSTAND HOW THE SAFETY WORKS BEFORE YOU LOAD OR USE THE REVOLVER.***

The internal transfer bar safety keeps the hammer from striking the firing pin except when the hammer is in the third position (full cock) and the trigger is pulled completely to the rear. See **Figure 8**. After each shot, the trigger must return to the forward position. If it does not, unload the revolver immediately and do not use it until it has been repaired by European American Armory Corp. or a competent gunsmith.

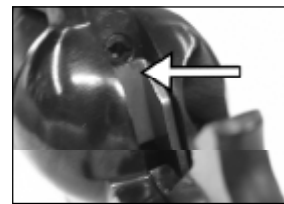

Figure 8

Frame: The frame is the portion of the revolver into which the cylinder is secured. See **Figure 9**.



Figure 9

Cylinder: The cylinder is located in the frame of the

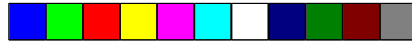

revolver. See **Figure 10**. The cylinder contains six chambers. Note: While this revolver has a transfer bar safety and does not require an unloaded chamber under the hammer, European American Armory Corp. recommends that you keep one chamber empty in the cylinder and rest the hammer on that empty chamber.

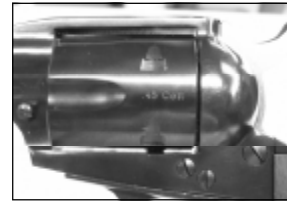

Figure 10

Loading Gate: The loading gate is located on the right side of the revolver behind the cylinder. See **Figures 11a** and **11b**. The loading gate, when opened, allows the revolver to be loaded or unloaded and allows for the extraction of empty cases. The loading gate must also be opened to allow for the removal and/or replacement of the cylinder.

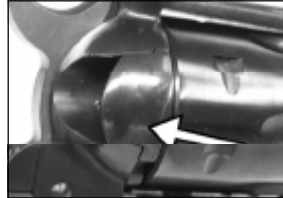

Figure 11a



Figure 11b

Ejector Rod: The ejector rod is located under the barrel of the revolver. See **Figure 12**. The ejector rod is pushed while unloading the revolver in order to eject any cartridges and/or empty casings from the cylinder chambers.

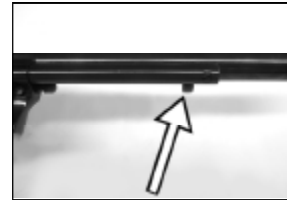

Figure 12

Hammer: The hammer is located behind the cylinder. See **Figure 13**. When the trigger is pulled with the hammer cocked, the hammer falls to strike the transfer bar, which in turn strikes the firing pin, causing the revolver to discharge.



Figure 13

Trigger: The trigger is located in the trigger guard. See **Figure 14**. Pull the trigger after the hammer is fully cocked to allow the hammer to fall forward and fire the revolver.



Figure 14

⚠ WARNING!

Never pull the trigger until you are actually ready to fire. Keep your fingers off the trigger and outside of the trigger guard until you are ready to pull the trigger and fire the revolver.

Trigger Guard: The trigger guard is located around the trigger. See **Figure 15**. It protects the trigger. Keep your finger out of the trigger guard and off the trigger until you are ready to fire.



Figure 15

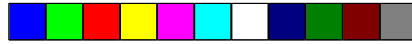

Grip: The grip is that portion of the revolver used by the shooter to grasp the revolver. See **Figure 16**.

The Serial Number: The revolver's serial number is located on the bottom front of the frame.

Front Sight/Rear Sight: The sights are located on top of the barrel on the muzzle end and above and in front of the hammer. See **Figures 17** and **18**.

Holster: A good quality, properly designed holster should be used for safe carrying of your revolver. It must be the correct size, and it should have a safety flap or strap or other means of securing the revolver so it cannot fall out.

WARNING!
Do not carry the revolver cocked.

WARNING!
Do not carry it in a pocket or tucked into a waistband or belt or other informal means.



Figure 16

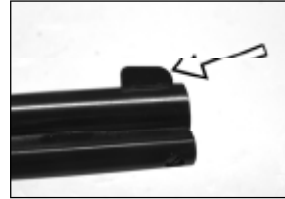

Figure 17



Figure 18

LOADING AND UNLOADING YOUR REVOLVER

WARNING
Never load the revolver until you are ready to use it.

WARNING
Make sure the revolver is pointed in a safe direction at all times while loading and unloading. NEVER allow your fingers or other objects to contact the trigger while loading or unloading.

***** Warning *****
Do not load the revolver until you are ready to fire.

TO LOAD:

- 1) Make sure the ammunition that you are using is the correct caliber. The barrel is marked with the caliber of the cartridge.
- 2) Visually inspect the chambers and barrel for obstructions. The chambers

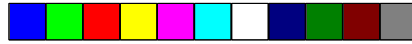

and barrel should be free of oil or grease or obstructions. See **Figure 19**.

- 3) After inspection, use two hands to control the revolver so that it does not fall from your grasp. Move the hammer to the loading position or second notch. See **Figure 20**. Swing out the cylinder loading gate and insert the cartridges while progressively revolving the cylinder. See **Figure 21**.



Figure 19

- 4) One method of loading your revolver and finishing with an empty chamber lined up with the firing pin is to load one chamber but not the next one, then load the other four chambers (load one, skip one, load four). Close the loading gate and pull the hammer all the way back with a smooth stroke. Then controlling the hammer very carefully with your thumb, squeeze the trigger and let the hammer down gently to the rest position. See **Figure 22**.



Figure 20



Figure 21

- 5) Always keep the hammer in the rest position except when you intend to shoot. The rest position is when the hammer is against the frame. In this position the trigger is fully forward and the transfer bar is out of the firing position. If you do not understand this procedure, ask your firearms instruction to explain it to you.



Figure 22

⚠ WARNING !

The revolver is now loaded and ready to fire. Be extremely **CAREFUL**.

TO UNLOAD AND/OR EXTRACT EMPTY CASES:

- 1) Use both hands during unloading so the revolver and ammunition cartridges/empty cases do not fall. See **Figure 23a**.



Figure 23a

⚠ WARNING !

Keep your fingers out of the trigger guard and off the trigger.

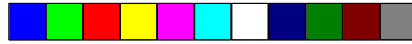

⚠ WARNING!

Always make sure the revolver is pointed in a safe direction during any hammer or trigger movement.

2) Point the barrel down and keep the revolver pointed in a safe direction. See **Figure 23b**.



Figure 23b

3) Move the hammer to the second notch. See **Figure 24**. Move the cylinder gate aside. Press the ejector rod, which enters the chamber and expels the cartridge or cartridge case.



Figure 24

4) Let the ejector thumb piece come back. Locate the next chamber before it and repeat the procedure. See **Figures 25a** and **25b**.

5) Before closing the cylinder gate, make sure that the cylinder is totally empty or unloaded by causing it to perform a full revolution.



Figure 25a

6) If once you have extracted the empty cases or unloaded the revolver and you do not wish to reload the revolver, close the cylinder loading gate and pull the hammer all the way back with a smooth stroke. Then controlling the hammer very carefully with your thumb, squeeze the trigger and let the hammer down to the rest position. The rest position is when the hammer is against the frame. In this position, the trigger is fully forward and the transfer bar is out of the firing position.



Figure 25b

HANDLING YOUR REVOLVER

⚠ WARNING

Never load your revolver until you are ready to fire the revolver.

WARNING (HANDLING)

Do not load the revolver until you are ready to use it.

NEVER CARRY ANY REVOLVER WITH THE HAMMER COCKED OR WITH THE TRIGGER HELD TO THE REAR. If the trigger is held to the rear, the gun can fire if the hammer strikes the transfer bar. Note that it need not be a deliberate

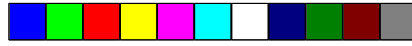

effort to pull the trigger. Any situation where the trigger attains its rearward position and permits the transfer bar to be interposed between the hammer and the firing pin can cause the cartridge under the firing pin to discharge if the hammer falls or is struck. **NEVER DROP OR STRIKE ANY REVOLVER—COCKED OR UNCOCKED. ALWAYS CARRY AND HANDLE THE REVOLVER IN SUCH A MANNER THAT THE HAMMER WILL NOT BE STRUCK.**

HANDLING IN GENERAL

This revolver has a transfer bar safety and does not require an unloaded chamber under the hammer. However, it is a good safety practice and we recommend that you keep one chamber empty in the cylinder and rest the hammer on this empty chamber.

The Big Bore Bounty Hunter has an internal safety device that keeps the hammer from striking the firing pin except when the hammer is in the third position (full cock) and the trigger is pulled completely to the rear. After each shot, the trigger must return to the forward position. If it does not, unload the revolver immediately and do not use it until it has been repaired by European American Armory Corp. or a competent gunsmith.

This is a single action revolver and thus, you cannot cock the hammer by pulling the trigger. This Big Bore Bounty Hunter single action revolver must be cocked manually for each shot. Always keep your finger off the trigger while handling this firearm. The only time you should pull the trigger is when firing the revolver or when carefully lowering the hammer. Never force the trigger or hammer to move.

COCKING AND FIRING YOUR REVOLVER



WARNING

Never load your revolver until you are ready to fire the revolver.



WARNING

Keep your finger off the trigger and the revolver pointed in a safe direction until you are ready to fire.



WARNING

If a cartridge does not fire and the trigger has been pulled, Stop! Then do the following: **a)** Make sure the gun is pointed in a safe direction **b)** Wait 60 seconds **d)** Follow the instructions above for unloading the revolver.



WARNING

If during firing the sound of any cartridge is noticeably softer or louder than the previous cartridge fired, Stop! Then do the following: **a)** Make sure the gun is

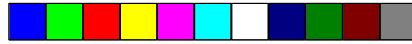

pointed in a safe direction **b)** Follow the instructions above for unloading the revolver and **c)** With the revolver unloaded visually inspect the revolver for barrel blockage or damage. Then inspect the receiver of the revolver for damage before continuing.

READ, UNDERSTAND AND FOLLOW ALL WARNINGS AND INSTRUCTIONS IN THIS MANUAL BEFORE FIRING THE REVOLVER.

TO FIRE THE REVOLVER:

In order to fire the revolver, the hammer must be moved from the rest position or from the second notch position to the fully cocked position. After the hammer is fully cocked (see COCKING below), you must pull (squeeze) the trigger. The firearm will fire one shot. The sequence of cocking the hammer and pulling the trigger must take place to fire each shot. When the trigger is pulled back, the transfer bar moves up into firing position and the hammer is released so that a cartridge is fired.

- 1) Point the muzzle in a safe direction with your finger outside the trigger guard. See **Figure 26**.
- 2) **COCKING:** Place the fore portion of the thumb firmly on the hammer spur and pull the hammer fully to the rear until it stops. Then permit the hammer to move very slightly forward until the trigger engages the hammer at full cock. See **Figure 27**.



Figure 26

⚠ WARNING!

When cocking the hammer, have a firm hold on the grip with the shooting hand. **DO NOT TOUCH THE TRIGGER WHILE COCKING THE HAMMER. TOUCH THE TRIGGER ONLY WHEN YOU ARE READY TO FIRE.**

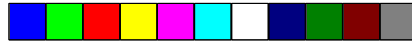

Figure 27

- 3) **FIRING:** Once the hammer has been cocked, pressure on the trigger will disengage the trigger from the hammer. The hammer will fall forward against the transfer bar. The transfer bar in turn strikes the firing pin and the firing pin strikes the loaded cartridge in the chamber, causing the discharge of a bullet. See **Figure 28**.



Figure 28



WARNING!

If you have never fired a revolver with Magnum cartridges, be aware that .357 Magnum and .44 Magnum cartridges have surprisingly more recoil and a firm grip is necessary. A novice shooter should be aware that the recoil of any handgun causes the muzzle of the gun to flip upward. The shooter need not be apprehensive but must be prepared.

FIRING WARNING

When firing any revolver, be sure that all spectators are a safe distance to the rear of the shooter. When fired, all revolvers have “side blast” or “cylinder blast” which is the discharge of hot gas and particles through the clearance gap between the cylinder and the rear of the barrel. These particles of lead, powder grains or lubricants are projected broadly sideways at high speeds and thus, can injure any person who is too close to the revolver. When firing any revolver, always be certain that nothing—including either of your hands—is in the path of the hot gas and particles which are discharged from the front and sides of the cylinder. When firing, do not rest your revolver against your hand, legs or body where the muzzle or cylinder blast can hit you. Always keep the side of the revolver away from you or bystanders. Keep people behind and away from you while firing.

When shooting, full eye and ear protection is mandatory at all times. Shooters and spectators must wear shooting glasses and hearing protection to prevent eye injury and hearing loss. Vision loss and hearing impairment can occur with only one moment of non-protection.

NEVER quick-draw a loaded revolver and never fan the hammer of this revolver. Quick-draws and fanning are dangerous to you and others. They are also abusive to the firearm and will void the warranty.

DECOCKING THE REVOLVER

WARNING!

Use **EXTREME CARE** when attempting to decock the revolver as the thumb slipping during this process can result in an accidental discharge if the trigger is held to the rear and the hammer falls.

WARNING!

ALWAYS keep the revolver pointed in a safe direction.

If the revolver is cocked and you wish to decock the revolver without firing it, proceed as follows:

- 1) Make certain that the revolver is pointed in a safe direction.
- 2) Make certain both hands are dry and not impeded in any way—gloves, bandages, cold, etc.

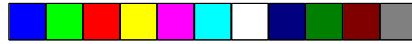

- 3) Grasp the revolver (if right-handed) so that the thumb and forefinger of your left hand are firmly holding the frame, forward of the trigger guard. Thus, your left hand is in full control of the revolver. See **Figure 29**.



Figure 29

- 4) Place your right thumb firmly on the hammer spur. With your thumb securely in control of the hammer, squeeze the trigger only enough to permit the hammer to break free of the trigger. At that instant, slowly permit the hammer (STILL SECURE UNDER YOUR THUMB) to move forward to its resting position against the frame. See **Figure 30**.



Figure 30

Practice this important gun handling skill with an unloaded revolver until you have developed the proper control and touch to safely decock your revolver. The key to safe decocking is having the weight of the revolver controlled with one hand, while the thumb and forefinger of the “shooting hand” control the hammer and trigger.

CYLINDER REMOVAL OR REPLACEMENT:

⚠ WARNING !

Never attempt to remove or replace a loaded cylinder.

- 1) Following the previous instructions to unload the revolver.
- 2) Follow the previous instructions to move the hammer to the 2nd notch.
- 3) Open the cylinder gate. See **Figure 31**.



Figure 31

- 4) Press the base pin release and withdraw the base pin. See **Figure 32**.
- 5) Remove the cylinder from the gate side of the revolver. See **Figure 33**.

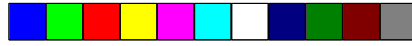

Figure 32

- 6) To replace the cylinder, simply reverse this procedure. Rotate the cylinder in a clockwise direction to insure that the hand is correctly positioned on the cylinder ratchet before replacing the base pin. Make sure that when you install the base pin that the base pin release pops out. This will insure that the base pin has been fully



Figure 33



inserted when the release pops out to its locked position.

MANUFACTURER'S WARNING:

This firearm was manufactured to properly perform with the original parts as designed. It is your duty to make sure any parts you buy are correctly installed and that neither replacements nor originals are altered or changed. Your gun is a complex tool with many parts that must relate correctly to other parts for safe and accurate operation. Putting a gun together wrong or with modified parts can result in a damaged gun, or personal injury or death to you or others. Always let a qualified gunsmith work on your gun or at least, check any work not performed by a gunsmith. Firearm safety is your primary concern. **THE GUN OWNER MUST ACCEPT FULL RESPONSIBILITY FOR THE CORRECT REASSEMBLY AND FUNCTIONING OF THE FIREARM AFTER ANY DISASSEMBLY OR REPLACEMENT OF PARTS.**

TO CLEAN AND MAINTAIN YOUR REVOLVER:

- A) Follow procedures for unloading revolver as described previously.
- B) Remove the cylinder from the revolver as described previously.
- C) Materials needed to clean this revolver are: a cleaning rod, cotton bore patches, brass bore brush, powder solvent, a small soft brush and good quality gun oil.

WARNING: Lead or lead compounds are known to the State of California to cause cancer, birth defects, reproductive toxicity, and other serious physical injury. Those who clean firearms should take protective measures to avoid contact or exposure to such chemicals.

- D) Using the bore brush with powder solvent, scrub the interior of the barrels and chambers to remove any powder and lead residue in the bore. Always and lastly, swab the interior of the barrels with cotton patch with gun oil to coat and protect the bore and chambers from rust and corrosion.
- E) Any powder fouling on the firing wall, barrel, etc. can be easily cleaned with a brush and powder solvent.
- F) All external surfaces should be wiped down with a light coat of rust preventative. Avoid using too much oil as powder, dust or other foreign material may get trapped in the oil. This could lead to congealed deposits which may interfere with the safe and reliable operation of the revolver.
- G) **USE CAUTION** while using solvents in gun bore cleaning. Prolonged or excess contact with solvents can damage the gun's bluing and finish. Be sure to wipe away all excess solvent and then lubricate with oil.

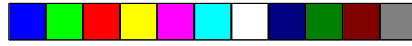

- H) A gun should be cleaned after firing. In addition, external parts should be wiped with an oiled cloth after handling. A light oil is ordinarily all that is necessary in cleaning if the gun has not been fired or fired very little. If a gun is used frequently, it must be cleaned after each firing and regularly serviced by a professional gunsmith. If the gun has been stored, remove all excess oil and/or grease before firing. Always check to be sure that no cleaning patch or other obstruction remains in the bore or chambers before firing.

DANGER – AMMUNITION WARNING

Firearms may be damaged and serious personal injury or death to the shooter or bystanders may result from any condition which contributes to the generation of excessive pressure or uncontrolled release of gas within the firearm. Such adverse conditions can be caused by bore or chamber obstruction, propellant powder overloads or by defective, incorrect or improperly loaded and assembled cartridge components. Even the strongest firearm can be blown up as a result of excessive pressure. It is extremely dangerous to use a cartridge whose pressure is greater than that developed by cartridges loaded to industry standards.

AMMUNITION (CARTRIDGES) NOTICE

We specifically disclaim responsibility for any damage, personal injury or death occurring in connection with or as the result of the use of European American Armory Corp. revolvers with faulty, nonstandard, remanufactured, Super-Vel, +P, hand-loaded or reloaded ammunition, used cartridges or cartridges other than factory cartridges for which the firearm was originally chambered.

LUBRICATION WARNING

Firing a revolver with oil, grease or any other material even partially obstructing the bore may result in damage to the revolver and personal injury to the shooter and those nearby. Do not spray or apply lubricants directly on ammunition. If the powder charge of a cartridge is affected by the lubricant, it may not fully ignite yet the energy from the primer and/or powder may be sufficient to push the projectile or wad into the bore where it may become lodged. Firing a subsequent cartridge into the obstructed bore will damage the revolver and may cause personal injury to the shooter and those nearby. Use lubricants properly. You are responsible for the proper care and maintenance of your firearm and ammunition.

LIFETIME LIMITED WARRANTY

This European American Armory Corp. firearm is warranted to the original retail customer for life from date of purchase against defects in material and workmanship. All parts and labor or replacement **at our option** are covered.

Transportation to and from our repair facilities, government fees, damage caused by failure to perform normal maintenance, sales outside the United States, damage due to use of high velocity, high pressure, reloaded or other nonstandard ammunition, or any unauthorized repair, modification, misuse, abuse, or alteration of the product are not covered by this Lifetime Limited Warranty.

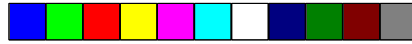

Any implied warranties, including the implied warranties of merchantability and fitness for a particular purpose, are limited to one year from date of original retail purchase. Consequential or incidental damages and/or expenses, or any other expenses are not covered by this warranty.

To obtain warranty performance send your firearm with proof of retail purchase, freight prepaid to:

European American Armory Corp.
402 Richard Road
Rockledge, Florida 32955

NOTICE: It is illegal to ship a firearm with ammunition in the firearm or in the same packaging. Firearms and ammunition must be shipped separately. For information about shipping ammunition, call European American Armory Corp. at (321) 639-4842.

BIG BORE BOUNTY HUNTER EXPLODED VIEW

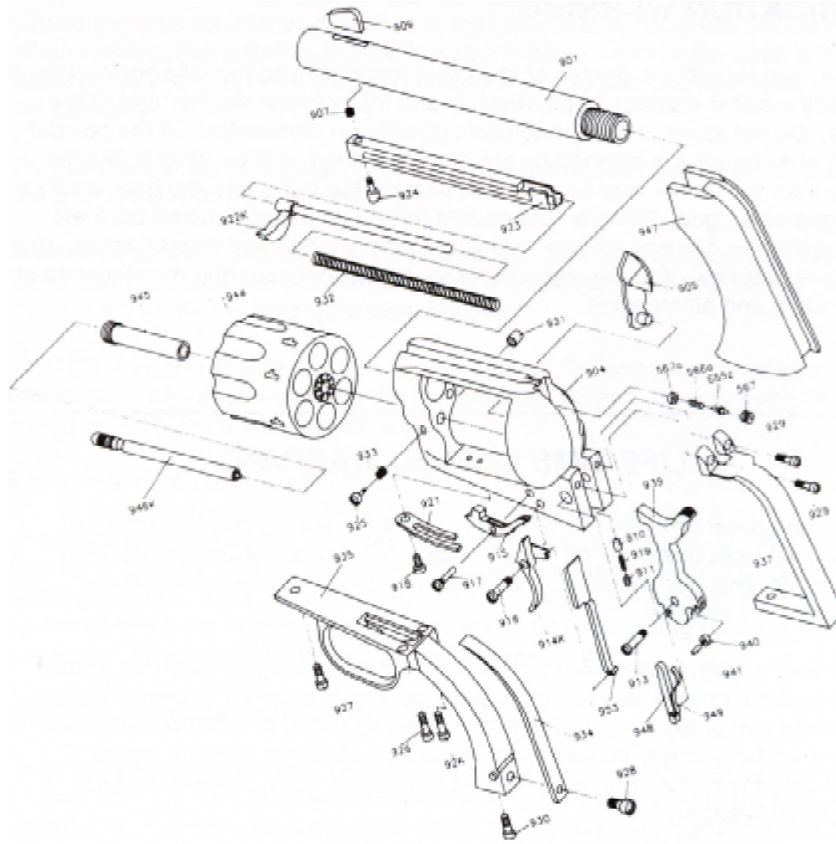

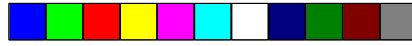

BIG BORE BOUNTY HUNTER PARTS LIST

- | | |
|--------------------------------|---------------------------------|
| 901. Barrel | 928. Main Spring Screw |
| 904. Frame | 929. Upper Backstrap Screw |
| 905. Gate | 930. Lower Backstrap Screw |
| 906. Front Sight | 931. Base Pin Release Nut |
| 907. Ejector Tube Spacer | 932. Ejector Spring |
| 567A. Recoil Plate | 933. Base Pin Release Spring |
| 655Z. Firing Pin | 934. Mainspring |
| 910. Gate Detent | 935. Trigger Guard |
| 911. Gate Screw | 937. Backstrap |
| 567. Recoil Cup | 939. Hammer |
| 913. Hammer Screw | 940. Hammer Roller |
| 914K. Trigger | 941. Hammer Pin |
| 915. Bolt & Cylinder Stop | 944. Cylinder (Specify Caliber) |
| 916. Trigger Screw | 945. Base Pin Bushing |
| 917. Bolt Screw | 946K. Base Pin |
| 918. Bolt Screw Spring | 947. Set Grips |
| 919. Gate Spring | 948. Hand |
| 921. Sear & Bolt Spring | 949. Spring for Hand |
| 922K. Ejector Rod | 953. Transfer Bar |
| 923. Ejector Tube | |
| 924. Ejector Tube Screw | |
| 925. Base Pin Release Screw | |
| 926. Rear Trigger Guard Screw | |
| 927. Front Trigger Guard Screw | |

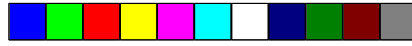

WARNING

Children are attracted to and can operate firearms that can cause severe injuries or death.

Prevent child access by always keeping guns locked away and unloaded when not in use. If you keep a loaded firearm where a child obtains and improperly uses it, you may be fined or sent to prison.

ADVERTENCIA

A los niños les atraen las armas de fuego y los pueden hacer funcionar. Ellos pueden causarse lesiones graves y la muerte.

Evite que los niños tengan acceso a las armas de fuego guardándolas siempre con llave y descargadas cuando no las esté utilizando. Si usted tiene un arma de fuego cargada en un lugar en que un niño tiene acceso a ella y la usa indebidamente, le pueden dar una multa o enviarlo a la cárcel.

Importer:

European American Armory Corp.
402 Richard Road
Rockledge, FL 32955

Manufacturer:

Hermann Weihrauch Revolver GmbH
Postfach 25
97634 Mellrichstadt