

®

Taurus



PISTOL

General Safety,

.....
Operating Instructions

.....
and Limited Warranty

.....
**READ CAREFULLY BEFORE
USING YOUR FIREARM**

**Important: Keep this manual with
your firearm.**

The information contained in this manual is useful, both for beginners and experienced shooters. In addition to important information about functioning, cleaning and care of the gun, the manual contains instructions that may be very helpful in shooting properly.

The most important rule of safe gun handling is always keep the muzzle pointed in a safe direction!!!

TAURUS SECURITY SYSTEM™



Engagement (Secure)

PT58 S-D, PT92 C-D, PT92 AF-D, PT99 AF-D, PT908, PT100 AF-D, PT101 AF-D, PT911, PT938, PT940, PT945 and PT957

Insert the key into the mechanism and turn clockwise until a click is felt or heard. The mechanism now partially protrudes above the surface of the backstrap of the grip. The action is locked in place and cannot function.

Disengagement (Ready-to-Fire)

PT58 S-D, PT92 C-D, PT92 AF-D, PT99 AF-D, PT908, PT100 AF-D, PT101 AF-D, PT911, PT938, PT940, PT945 and PT957

To place the pistol in a firing condition, insert the key into the mechanism and turn it counter-clockwise. The mechanism is now virtually flush with the backstrap of the grip. The pistol can now be fired.



Engagement (Secure) PT111, PT111Ti,

PT132, PT138, PT140, PT145 & PT145Ti

Insert the key into the mechanism and turn clockwise until a click is felt or heard. The mechanism now partially protrudes above the surface of the slide. The action is locked in place and cannot function.

Disengagement (Ready-to-Fire)

PT111, PT111Ti, PT132, PT138, PT140, PT145 & PT145Ti

To place the pistol in a firing condition, insert the key into the mechanism and turn it counter-clockwise. The mechanism is now virtually flush with the slide on the PT111, PT132, PT138, PT140, PT145). The pistol can now be fired.



WARNING:

Securing your firearm may inhibit access to it in a defense situation and result in injury or death.

WARNING:

Failure to properly secure a firearm may result in injury or death.

CAUTION:

Never engage the Taurus Security System on your Taurus Pistol with the slide in the open (rearward) position. This will result in permanent damage to your firearm.

THIS BOOKLET

The safety warnings in this booklet are important. By understanding the dangers inherent in the use of any firearm, and by taking the precautions described herein, you can enjoy complete safety in the use of your Taurus revolver or pistol. Failure to heed any of these warnings may result in serious injury to you or others, as well as severe damage to the firearm or other property.

DANGEROUS WEAPONS

REVOLVERS and PISTOLS are classified as FIREARMS or DANGEROUS WEAPONS and are sold by us with the specific understanding that we are not responsible in any manner whatsoever for their improper or negligent handling or resale under local laws and regulations.

TAURUS shall not be responsible in any manner whatsoever for malfunctioning of the firearm, or for physical injury or property damage, resulting in whole or in part from (1) criminal or negligent discharge, (2) improper or careless handling, (3) unauthorized modifications, (4) defective, improper hand-loaded, or reloaded ammunition, (5) neglect, or (6) other influences beyond our direct and immediate control. This limitation applies regardless of whether liability is asserted on the basis of contract, negligence or strict liability (including any failure to warn). Under no circumstance shall Taurus be liable for incidental or consequential damages, such as loss of use of property, commercial loss and loss of earnings or profits.

SAFETY WARNINGS

NOT JUST FOR BEGINNERS

Regardless of your familiarity or experience with firearms, you need to study this manual.

The safe handling of firearms requires specialized training, discipline and caution. Firearms, by their nature and intended function, are deadly instruments. Accidental death or serious injury can result if they are handled improperly or carelessly.

Firearms rarely cause accidents. Firearms accidents almost always are caused by a failure to obey the basic rules of gun safety. Unfortunately, experienced shooters seem to violate these rules as frequently as beginners. Thus the basics of safe firearms handling cannot be repeated too often. Read, re-read and practice the basic principles of firearms safety until they become second nature: habits that you don't forget.

If you have any question about your knowledge or ability to use this or any other firearm with complete safety you should seek supervised instruction. Personalized instruction is often available from firearms dealers, gun clubs, state hunter safety programs or police departments in the United States. If none of these sources is accessible, write to the National Rifle Association, 11250 Waples Mill Road, Fairfax, VA 22030 . THEY WILL ASSIST YOU.

A person with a firearm in his possession has a full-time responsibility. He must KNOW how to keep and use his firearm safely, and then must always TAKE the precautions necessary -all of them. He cannot guess; he cannot forget. This responsibility is his alone. It cannot be passed off to someone else.

Remember: no firearm can be made accident-proof. A firearm is just a machine, with no judgement of its own. It responds to your actions, whether wise or foolish. The only truly effective safety device is the mind of a cautious shooter who never forgets that a moment's carelessness can produce permanent tragedy.

FIREARMS ARE NOT ALL ALIKE

Many makes and models of firearms might LOOK nearly the same. However, they differ widely in design and operation, and in the location and function of various controls.

Study this manual thoroughly. Educate yourself on the characteristics and operation of your particular firearm before attempting to handle it. Do not permit others to handle it - unless they also have done so.

You should have an instruction manual for every firearm you own. If you do not, write the manufacturer and obtain one. Most manufacturers will gladly send you one free. If for any reason a manual is not available, visit your public library. Many books have been published which contain detailed information on obsolete or discontinued firearms.

Your knowledge can prevent injuries.

Taurus firearms are designed and made to offer maximum safety when correctly used. However, as with any other weapon, it is not foolproof, and may become very dangerous if the following basic recommendations are not RIGIDLY observed:

ATTENTION

1. **DANGER:** Never, never-ever point any firearm, loaded or unloaded, at anything you do not intend to shoot.
2. **WARNING:** Always treat every firearm as if it were loaded.
3. **NOTICE:** Get instruction from a competent firearms instructor before using any firearm.
4. **SAFETY FIRST:** The safety is only a mechanical device, not a substitute for common sense.
5. **WARNING:** Keep your finger off the trigger until you are actually aiming at the target ready to shoot.
6. **WARNING:** Be certain the firearm is unloaded before cleaning.
7. **WARNING:** Always empty firearms before entering a place where there are people.
8. **SAFETY FIRST:** Never leave a loaded firearm unattended.
9. **SAFETY FIRST:** Store firearms and ammunition separately beyond the reach of children.
10. **WARNING:** Don't test the safety by pulling the trigger while the safety is on unless you are absolutely sure the firearm is empty and you are pointing away from everyone.
11. **SAFETY FIRST:** Be sure of your target and backstop before you shoot.
12. **SAFETY FIRST:** Firearms and alcohol or drugs don't mix.
13. **WARNING:** Never pull a firearm towards you by the muzzle. Don't climb a tree or cross a fence with a loaded firearm.

14. **DANGER:** Load and unload with the muzzle pointed in a safe direction.
15. **SAFETY FIRST:** If a firearm fails to fire when the trigger is pulled, keep it pointed at the target for at least 30 seconds. Sometimes slow primer ignition will cause a “hang” fire and the cartridge will go off after a short pause.
16. **SAFETY FIRST:** Never shoot at hard flat surfaces or water., bullet may ricochet.
17. **DANGER:** When receiving a firearm always check that it is unloaded (Pistols: Remove magazine and open slide to check if chamber is empty. Revolvers: Open cylinder to check if it is empty), even if you saw it done previously.
18. **DANGER:** Never put your hand over the muzzle of a firearm.
19. **DANGER:** Check ammunition to be sure it is the right size and caliber, and that it is not dented.
20. **SAFETY FIRST:** Use a proper holster and draw only if you intend to shoot.
21. **NOTICE:** Never cock the firearm until you are ready to shoot.
22. **SAFETY FIRST:** Dry firing is bad for this firearm, whether the hammer block is engaged or not.
23. **DANGER:** WHILE HANDLING ANY FIREARM, NEVER ALLOW IT TO POINT AT ANY PART OF YOUR BODY OR AT ANOTHER PERSON. NO HARM SHOULD RESULT IF YOU OBEY THIS RULE, EVEN IF AN ACCIDENTAL DISCHARGE OCCURS.
24. **CAUTION:** If there is any reason to suspect that a bullet is obstructing the barrel, immediately unload the firearm and look through the bore. It is not sufficient to merely look in the chamber.
25. **SAFETY FIRST:** Treat this firearm as a precision instrument.
26. **WARNING:** Old or reloaded ammunition may be dangerous. We recommend against using it.
27. **WARNING:** Never carry any handgun in your pocket, purse or waist-band. Use a pistol case or proper holster with safety flap or strap.
28. **DANGER:** Don't try to change your firearm's trigger pull, because alteration of trigger pull usually affects sear engagement and may cause accidental discharge.
29. **SAFETY FIRST:** Write to us concerning any items or circumstances which might relate to your safety and the operation of our products.
30. **DANGER:** Never engage a gun lock on a loaded firearm.

WARNING

Taurus pistols were manufactured to perform properly with the original parts as designed. It is your duty to make sure any parts you buy are installed correctly and that neither replacements nor originals are altered or changed. Your firearm is a simple tool but it has many parts that must relate correctly to other parts. Putting a firearm together wrong or with modified parts can result in a damaged firearm, danger and injury or death to you and others through malfunction.

Always have a qualified gunsmith work on your firearm.

DANGER: PROTECT YOUR EYES AND EARS

Always wear adequate shooting glasses and ear plugs or "ear muff" type protectors whenever you are shooting. Always make certain that persons close to you are similarly protected. Unprotected eyes may be injured by powder, gas, carbon residue, lubricant, metallic particles or similar debris which may emanate occasionally from any firearm in normal use. Without ear protection, repeated exposure to shooting noise may lead to cumulative, permanent hearing loss.



DANGER:

This pistol will fire with the magazine removed. Injury or death may result. Never point a loaded pistol at anyone or anything you do not intend to shoot.

WARNING:

To prevent injury or death, it is imperative that you must keep your firearm unloaded, uncocked and securely locked, with ammunition in a separate location. In addition, take any other reasonable steps to limit the possibility of theft, crime, accident or suicide.

FOR TAURUS PISTOLS WITHOUT A MAGAZINE DISCONNECTOR:

WARNING: This pistol will fire with the magazine removed. Injury or death may result. Never point a loaded pistol at anyone or anything you do not intend to shoot.

FOR TAURUS PISTOLS WITH A MAGAZINE DISCONNECTOR:

WARNING: This pistol is equipped with a magazine disconnect. It is intended but not warranted or promised that the pistol will not fire with the magazine removed, however,

- (i) The magazine disconnect is not a safety and should not be relied on as such to prevent injury or death.
- (ii) The magazine disconnect can be accidentally bypassed through abnormal handling. If so, the pistol will fire and may result in injury or death.
- (iii) The magazine disconnect may break and allow the pistol to fire with the magazine removed, resulting in injury or death.
- (iv) Do not attempt to remove, alter or modify the magazine disconnect. Injury or death may result.
- (v) If you purchase this product “used” check the operation of the magazine disconnect as follows: Verify that the magazine is out and visually confirm that the chamber is empty by pulling the slide back with your finger well clear of the trigger. Close the slide, and point the muzzle in a safe direction and attempt to pull the trigger. If the trigger pull is complete and a loud clicking is heard, then the disconnect may be broken and the firearm should be returned to Taurus customer service for inspection and, if necessary, repair. Failure to do so may result in injury or death.
- (vi) If you are unclear about the purpose, function or proper procedures for performing the test, please return the product to Taurus in accordance with your warranty for a free inspection.

WARNING: AMMUNITION

1. Use only high quality, original, factory-manufactured ammunition. Do not use cartridges that are dirty, wet, corroded, bent or damaged. Do not oil cartridges. Do not spray aerosol-type lubricants, preservatives, or cleaners directly onto cartridges or where excess spray may flow into contact with cartridges. Lubricant or other foreign matter on cartridges can cause potentially dangerous ammunition malfunctions. Use only ammunition of the caliber for which your firearm is chambered. The proper caliber is permanently engraved on your firearm; never attempt to use ammunition of any other caliber.

2. The use of reloaded, “remanufactured”, hand-loaded, or other non-standard ammunition voids all warranties. Improperly loaded ammunition voids all warranties. Improperly loaded ammunition can be extremely dangerous. Severe damage to the firearm and serious injury to the shooter or to others may result. Always use ammunition that complies with the industry performance standards established by the Sporting Arms and Ammunition Manufacturers Institute, Inc., of the United States, (SAAMI) or the equivalent from other countries.

3. Firearms may be severely damaged and serious injury to the shooter or to others may result from any condition causing excessive pressure inside the chamber or barrel during firing. Excessive pressure can be caused by obstructions in the barrel, propellant powder overloads, or by the use of incorrect cartridges or defectively assembled cartridges. In addition, the use of a dirty, corroded, or damaged cartridge can lead to a burst cartridge case and consequent damage to the firearm and personal injury from the sudden escape of high-pressure propellant gas within the firearm’s mechanism.

4. Immediately stop shooting and check the barrel for a possible obstruction whenever:

- You have difficulty in, or feel unusual resistance in, chambering a cartridge, or
- A cartridge misfires (does not go off), or
- The mechanism fails to extract a fired cartridge case, or
- Unburned grains of propellant powder are discovered spilled in mechanism, or
- A shot sounds weak or abnormal.

In such cases it is possible that a bullet is lodged part way down the barrel. Firing a subsequent bullet into the obstructed barrel can wreck the firearm and cause serious injury to the shooter or to bystanders.

5. Bullets can become lodged in the barrel.

- If the cartridge has been improperly loaded without propellant powder, or if the powder fails to ignite (Ignition of the cartridge primer alone will push the bullet out the cartridge case, but usually does not generate sufficient energy to expel the bullet completely from the barrel).
- If the bullet is not properly seated tightly in the cartridge case.

When such a cartridge is extracted from the chamber without being fired, the bullet may be left behind in the bore at the point where the rifling begins. Subsequent chambering of another cartridge may push the first bullet further into the bore.

6. If there is any reason to suspect that a bullet is obstructing the barrel, immediately unload the firearm and look through the bore. It is not sufficient to merely look in the chamber. A bullet may be lodged some distance down the barrel where it can not easily be seen.

IF A BULLET IS IN THE BORE, DO NOT ATTEMPT TO SHOOT IT OUT BY USING ANOTHER CARTRIDGE, OR BY BLOWING IT OUT WITH A BLANK OR ONE FROM WHICH THE BULLET HAS BEEN REMOVED. SUCH TECHNIQUES CAN GENERATE EXCESSIVE PRESSURE, WRECK THE FIREARM AND CAUSE SERIOUS PERSONAL INJURY.

If the bullet can be removed with a cleaning rod, clean any unburned powder grains from the bore, chamber, and mechanism before resuming shooting. If the bullet cannot be dislodged by tapping it with a cleaning rod, take the firearm to a gunsmith.

7. Dirt, corrosion, or other foreign matter on a cartridge can impede complete chambering and may cause the cartridge case to burst upon firing. The same is true of cartridges which are damaged or deformed.

8. Do not oil cartridges, and be sure to wipe the chamber clean of any oil or preservative before commencing to shoot. Oil interferes with the friction between cartridge case and chamber wall that is necessary for safe functioning, and subjects the firearm to stress similar to that imposed by excessive pressure.

9. Use lubricants sparingly on the moving parts of your firearm. Avoid excessive spraying of any aerosol firearm care product, especially where it may get on ammunition. All lubricants and aerosol spray lubricants in particular, can penetrate cartridge primers and cause misfires. Some highly penetrative lubricants can also migrate inside cartridge cases and cause deterioration of the propellant powder; on firing, the powder may not ignite. If only the primer ignites, there is danger that the bullet may become lodged in the barrel.

Taurus pistols were designed to use cartridges loaded to the limits shown below. Other cartridges of various types or bullet weights may or may not function acceptably; such ammunition should be thoroughly tested by the user before relying on it. Because of the widely differing specifications of such other ammunition, Taurus cannot be responsible for malfunctions resulting from its use.

CALIBER	BULLET WEIGHT	MUZZLE VELOCITY
.32 ACP	71 GR FMP	905 FPS
.380 ACP	95 GR FMJ	1000 FPS
9MMPARA.	124 GR FMJ	1225 FPS
.357 SIG	125 GR FMJ	1350 FPS
.40 S&W	180 GR FMJ	985 FPS
.45 ACP	225 GR FMJ	900 FPS

GR = grains

FMJ = Full metal jacketed bullet

FPS = Feet per second

“Plus-P’, “Plus-P-Plus” or other ultra or high velocity ammunition generates pressures significantly in excess of the pressures associated with standard ammunition. Such pressures may affect the useful life of the firearm or exceed the margin of safety built into many pistols and could therefore be DANGEROUS.

CAUTION

Discharging firearms in poorly ventilated areas, cleaning firearms, or handling ammunition may result in exposure to lead and other substances known to cause birth defects, reproductive harm, and other serious physical injury. Have adequate ventilation at all times. Wash hands thoroughly after exposure.

POSITION FOR TARGET SHOOTING

Take such stance that your body faces the target at a 90 degree angle. Keep your feet 1 ft. to 1-1/2 ft. apart. Raise your arm so that it lines up naturally with the target. Your head should be turned as needed, so to have a good sight picture. When you are in a correct position, aim the firearm and squeeze the trigger.

AIMING

Align the rear and front sights carefully. The top of the front sight must be leveled with the top of the rear sight and set in the middle of the rear sight notch. The bullseye should rest on the top of the sights.

SQUEEZE OF THE TRIGGER

Squeeze the trigger very carefully with index-finger, keeping sight aligned with the target. If the trigger is jerked, the target will possibly be missed due to the movement of the firearm. The pressure should be applied between the tip and the first joint of the finger. Press slowly and carefully. More speed will be gained with practice.

ADJUSTING THE SIGHTS

Adjustable Sight Models Only

To raise the rear sight, turn the elevation adjusting screw counterclockwise. To lower the rear sight turn the screw clockwise. When raising the sight the point of impact rises. Lowering the sight, the point is lowered. The rear sight can also be adjusted for windage. Turn the windage adjusting screw clockwise to move the notch to right side, and counter-clockwise to move the notch to left side.

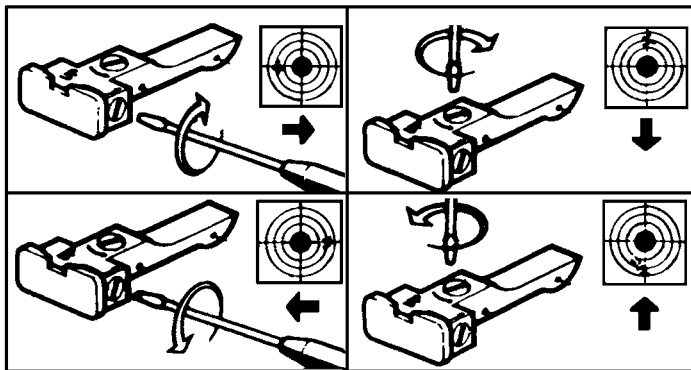

CARE AND MAINTENANCE

A. The firearm may be cleaned and lubricated under normal conditions without the need of any disassembly.

B. In special conditions, such as repairs, when disassembling is necessary, it is recommended the firearm be returned to the factory or sent to a competent gunsmith or to the importer.

C. In order to keep a firearm in perfect condition it must be kept clean and covered with a slight film of good quality oil to prevent corrosion. This is especially necessary after use.

D. For normal cleaning of handgun not used or kept in storage for some time, it is necessary to rub it with a lightly oiled cloth. In the same way proceed with the bore of the barrel. The excess of oil must be removed, but a thin protecting film should remain. Also the dust should be removed from all crevices with a small, clean brush.

E. For cleaning after shooting, it is of special importance that all residues of powder be removed from barrel and other adjacent areas subject to such deposits, using an appropriate brush. If particles of lead are detected in barrel they must be scrubbed with a brass brush, drenched with oil. Once cleaned, lubrication should be done as above described. When shooting more than 200 shots in a row, your firearm should be cleaned.

F. Do not keep handguns in contact with materials that attract moisture or possess a certain degree of acidity, or in environments with great variation of temperature or of humidity. Avoid the use of holsters of cloth or of any other material except natural leather appropriately cured.

G. If the weapon is to be stored for a long period of time, extreme care should be taken with metal surfaces, in order to protect them against corrosion.

H. If magazine becomes dirty, which usually happens after 200 shots, it should be disassembled and thoroughly cleaned. To do so, use a punch to press in on magazine spring seat where it protrudes into the hole in the magazine floorplate. Slide the magazine floorplate toward the front of the magazine, taking care to prevent the forcible ejection of the magazine spring seat and compressed magazine spring. Withdraw magazine spring plate and magazine spring from magazine body. Turn magazine upside down and remove magazine follower.

Reassemble in reverse order.

WARNING: Damaged or improperly assembled magazines should not be used. They can cause the pistol to malfunction.

TAURUS LIMITED WARRANTY

What Does This Warranty Cover?

This warranty covers any service and repair needed by any product manufactured by Forjas Taurus SA., and imported by Taurus International Manufacturing, Inc. or manufactured in the United States by Taurus International Manufacturing, Inc.

How Long Does Coverage Last?

This warranty is of unlimited duration.

What Will We Do?

Taurus will service and/or repair all covered products free of charge.

What Does This Warranty Not Cover?

This warranty does not cover grips, sights, accessories, cosmetic defects after one year, or damage caused by customer abuse at any time. This express limited warranty is the only warranty on this product. This product is sold "as is" and has no implied warranties of merchantability or fitness for a particular purpose. There are no warranties which extend beyond the description on the face hereof.

How Do I Get Service?

To simplify repair and service Forjas Taurus and Taurus International products are serviced and repaired by Taurus International. Questions regarding the products of either company can be directed to Taurus International in Miami, Florida at 1-305-624-1115 or in writing to:

16175 NW. 49th Avenue
Miami, Florida 33014
in care of the Consumer Affairs Department.

In order to obtain warranty service or repair you must first complete and return the enclosed warranty registration card within 10 days of the date of purchase. Then, if a problem should arise, describe the problem in writing and send the firearm to Taurus International at the above address, insured and pre-paid with the written description of the problem enclosed. Within 4 business days of our receipt of your firearm our Customer Service Department will contact you in writing advising you of when to expect your firearm back. We will ship guns serviced because of defect in materials or workmanship insured and pre-paid. We will ship guns repaired out of warranty COD. There will, of course, be no charge for parts or labor if the repair work performed is covered by this express warranty.

How Does State Law Apply?

This warranty gives you specific legal rights and you may also have other rights which vary from state to state.

LOADING

1. **DANGER:** Always make sure the muzzle is pointed in a safe direction.
2. **SAFETY FIRST:** Never attempt to load or unload any firearm inside a vehicle, building or other confined space (except a properly constructed shooting range). Enclosed areas frequently do not offer a completely safe direction to point the firearm; if an accidental discharge occurs, there is a great risk of injury or property damage.
3. **SAFETY FIRST:** Before loading, always clean all grease and oil from the bore and chamber, and check to be certain that no obstruction is in the barrel. Any foreign matter in the barrel could result in a bulged or burst barrel or other damage to the firearm, and could cause serious injury to the shooter or to others.

FIRING

1. **DANGER:** Keep the muzzle pointed in a safe direction and your finger away from the trigger when cocking any firearm.
2. **WARNING:** Never carry, handle or leave unattended any firearm which is cocked and ready to fire. When cocked, it will fire from slight pressure on the trigger. An accidental discharge could easily result if you fall or drop the firearm, or if the firearm is struck or disturbed by someone or something.
3. **WARNING:** Never fire any semi-automatic firearm with your finger, hand, face, or other part of your body over or adjacent to the ejection port, or in any position where you may be struck by reciprocating movement of the slide (or bolt). Both the ejection of empty cartridge cases and the movement of the slide (or bolt) are part of the normal operating cycle of semi-automatic firearms, and pose no safety hazard to the shooter if the firearm is held in a normal grip and fired at arm's length (in the case of a handgun) as intended by its design.
4. **CAUTION:** Never allow other persons to stand beside you where they might be struck by an ejected cartridge case. The case is hot, and may be ejected with sufficient force to cause a burn or cut or injury to an unprotected eye. Make certain there is a clear, unobstructed path for safe ejection of the fired case. Remember, the case may bounce off a hard object nearby and strike you or someone else.
5. **DANGER:** If while shooting, your firearm develops ANY mechanical malfunction or binding, or "spits" powder, gas, or if a cartridge primer is punctured or a cartridge case is bulged or ruptured, or if the report on firing does not sound quite right, STOP SHOOTING IMMEDIATELY. It may be dangerous to continue. UNLOAD THE FIREARM. DO NOT try "one more shot". Take the firearm and ammunition to a gunsmith for examination.
6. **SAFETY FIRST:** While shooting any semi-automatic firearm, an unfired cartridge case may occasionally become jammed between the slide (or bolt) and the barrel. Clear the jam as follows, WHILE KEEPING THE MUZZLE POINTED IN A SAFE DIRECTION: remove the magazine, then pull back the slide (or bolt) and hold or lock it to the rear. The jammed cartridge or case now can be removed by shaking it out or by picking it out.

SEMI-AUTOMATIC PISTOLS

1. **SAFETY FIRST:** Risk of an accident is greatly increased when any semi-automatic pistol, no matter how safely designed, is carried with a cartridge in the chamber. THIS PRACTICE IS NOT RECOMMENDED AND MAY BE JUSTIFIED ONLY IN CIRCUMSTANCE OF CLEAR AND PRESENT DANGER WHEN THE PISTOL MAY IMMEDIATELY HAVE TO BE USED IN SELF-DEFENSE. By far the safest procedure when carrying a loaded pistol is to leave the chamber empty.
2. **SAFETY FIRST:** If you MUST carry a Taurus semi-automatic pistol with a cartridge in the chamber, always lower the hammer to the uncocked position. In addition, if your pistol is equipped with a manual safety, never carry the pistol with a cartridge in the chamber unless the safe is “on” until you are ready to shoot and the firearm is pointed at the target.
3. **SAFETY FIRST:** When uncocking the hammer, always EASE the hammer down, NEVER LET IT SNAP DOWN, AS THIS MAY CAUSE THE PISTOL TO FIRE ACCIDENTALLY.
4. On some semi-automatic pistols it is possible to lower the hammer to a “half-cock” position. This position is the intercept notch.
WARNING: DO NOT USE THIS INTERCEPT NOTCH OR HALF COCK POSITION AS A SAFETY DEVICE. DO NOT CARRY THE FIREARM AT ANYTIME IN THE HALF COCK POSITION. It is not designed or suitable for that purpose. The “half cock” or intercept notch serves only to prevent unintended firing in case of internal malfunction or in case your thumb slips off the hammer during manual cocking or decocking.
WARNING: TO PREVENT ACCIDENTAL DISCHARGE, it is absolutely essential to **USE THE MANUAL SAFETY. NEVER CARRY THE PISTOL IN THE COCKED OR HALF COCKED POSITION AT ANYTIME.**
5. **SAFETY FIRST:** Always point the muzzle in a safe direction when manually operating the slide to load the first cartridge from the magazine into the chamber. Malfunctions which allow the pistol to fire without the trigger being pulled when the slide snaps closed are rare but can happen. Always grip the slide so that your fingers, hand, elbow, and other parts of your body are BEHIND the pistol and your finger is off of the trigger.

TAURUS PISTOLS OPERATION

(PT58 S-D, PT92 C-D, PT92 AF-D, PT99 AF-D, PT908, PT100 AF-D, PT101 AF-D, PT911, PT938, PT940, PT945 and PT957)

1. To remove the magazine press the **MAGAZINE RELEASE BUTTON**, located near the **TRIGGER GUARD**, with your thumb.

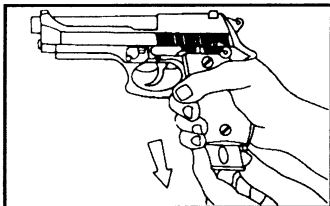

2. Hold the **MAGAZINE** with one of your hands and with the other one insert the cartridges one at a time, pressing them down and to the rear. Insert the **MAGAZINE** into the pistol until it is held by the **MAGAZINE CATCH**.

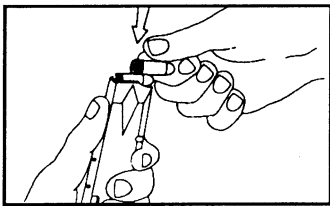

3. Hold the pistol with one hand keeping your finger away from the **TRIGGER**. With the other hand pull the **SLIDE** to its limit and release it. You may depress the **SLIDE CATCH**, and the **SLIDE** will go forward under **RECOIL SPRING** pressure and will insert one cartridge in the chamber.

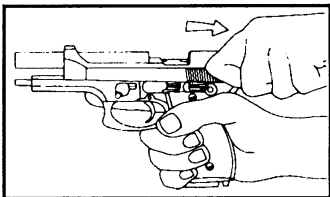

4. The pistol is now cocked and ready to fire by pulling the **TRIGGER**. After firing, the **SLIDE** will recoil from gas pressure and will eject the empty cartridge case and feed another cartridge into the chamber. The pistol will be ready to fire again. After the last round, the **SLIDE** will remain in the open position held by the **SLIDE CATCH**. In order to make it return to its rest position, press the **SLIDE CATCH** just above the **LEFT GRIP**.

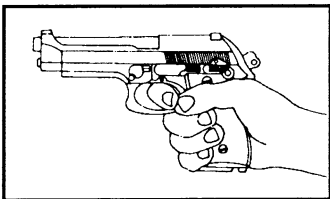

5. If you want to stop shooting before firing the last cartridge of a magazine, decock the firearm immediately by moving the safety downward and push the safety lever in the up (on) position.

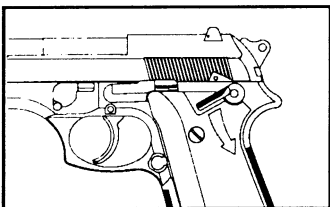

WARNING: These Taurus pistols do **not** have a magazine disconnect (safety). They will fire the round in the chamber with the magazine removed.

OPERATION OF TAURUS PT111, PT111Ti, PT132, PT138, PT140, PT145 & PT145Ti

1. To remove the magazine press the **MAGAZINE RELEASE BUTTON**, located near the **TRIGGER GUARD**, with your thumb.

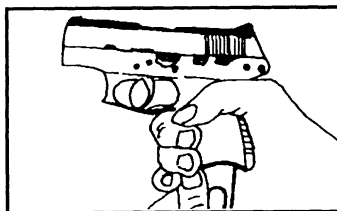

2. Hold the **MAGAZINE** with one of your hands and with the other one insert the cartridges one at a time, pressing them down and to the rear. Insert the **MAGAZINE** into the pistol until it is held by the **MAGAZINE CATCH**. For PT145 and PT145Ti models, use the magazine loader to insert the cartridges (see instructions).

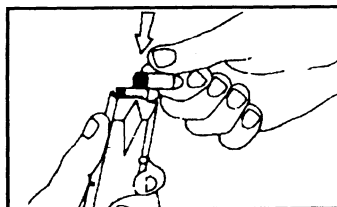

3. Hold the pistol with one hand keeping your finger away from the **TRIGGER**. With the other hand pull the **SLIDE** to its limit and release it. You may depress the **SLIDE CATCH**, and the **SLIDE** will go forward under **RECOIL SPRING** pressure and will insert one cartridge in the chamber.

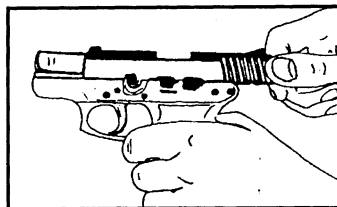

4. The pistol is now ready to fire by pulling the **TRIGGER**. After firing, the **SLIDE** will recoil from gas pressure and will eject the empty cartridge case and feed another cartridge into the chamber. The pistol will be ready to fire again. After the last round, the **SLIDE** will remain in the open position held by the **SLIDE CATCH**. In order to make it return to its rest position, press the **SLIDE CATCH** downward just above the **LEFT GRIP**. On the PT145 and PT145Ti, the slide will not close with an empty magazine in place. To return the slide to its rest position, release the empty magazine by pushing the magazine catch button with your thumb.

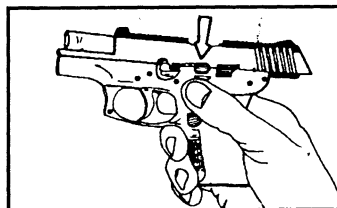

5. If you want to stop shooting before firing the last cartridge of a magazine, push the safety lever in the up (on) position.

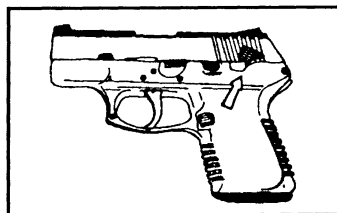

WARNING: These Taurus pistols do not have a magazine disconnect (safety). They will fire the round in the chamber with the magazine removed.

SAFETY AGAINST ACCIDENTAL FIRING FROM DROPPING

Like any other precision instrument of small size, this pistol can be damaged or broken by unusual abuse, such as by severe impact on a hard surface. If dropped from a height at which the pistol is normally used, the manual safety and automatic safety together provide double strong resistance against accidental firing caused by such impact, **BUT THE MANUAL SAFETY MUST BE "ON" TO FULFILL ITS FUNCTION.** A user who neglects to apply the manual safety runs a greater risk of accidental firing.

It is important to recognize that it is impossible to make any small firearm absolutely foolproof against drop firing under all circumstances, so long as a cartridge is loaded in the chamber.

The risk is virtually eliminated by the simple precaution of leaving the chamber empty until you are ready to shoot. In the event of a severe drop, the pistol should be checked by a competent gunsmith to ensure that no internal damage has occurred which may impair its safety or reliability.

DANGER:

USE OF SAFETY

1. Your firearm comes equipped with an effective, well designed safety device. **HOWEVER, NEVER RELY COMPLETELY ON ANY SAFETY MECHANISM.** The best safety mechanism is your own common sense: **USE IT!** Always handle your firearm as though you expect the safety **NOT** to work.
2. While handling any firearm, never allow it to point at any part of your body or at another person. No harm will result if you obey this rule, even if an accidental discharge occurs.
3. Leave the safety "on" until you are ready to shoot and the firearm is pointed at the target.
4. Always keep your finger off the trigger and point the muzzle in a safe direction when turning the safety "on" or "off".
5. When applying the safety, be certain to move it fully into position. On some firearms a red warning dot is located beside the safety; when the safety is fully "on", the red dot should be completely covered. Always remember, "Half-safe" is **NOT SAFE.**
6. Never carry any firearm with a cartridge in the chamber without placing the safety "on". (The only exceptions are double-action revolvers and some double-action pistols which have automatic internal safeties and which are not equipped with manual safeties.)
7. For maximum safety never carry a firearm with a cartridge in the chamber.

8. Most TAURUS pistols are equipped with the following:

THE AMBIDEXTROUS MANUAL SAFETY - levers on the left and right side of the slide. It is "ON" when the lever is turned fully up to cover the RED dot. When turned on, the safety lever will disengage the hammer and sear simultaneously.

AMBIDEXTROUS MANUAL HAMMER DROP SAFETY. Mechanism that allows the hammer to be lowered safely, when one of the safety levers is turned fully down. Hammer and firing pin are kept apart, and pistol is now in double action condition.

AUTOMATIC FIRING PIN BLOCK SAFETY built-in safety that blocks the firing pin from movement until the trigger is pulled completely to the rear as part of the firing sequence.

LOADED CHAMBER INDICATOR is in the extractor which protrudes on the right side of the slide, near the ejection port. When there is a round in the chamber, a red line is visible in daylight or may be felt in poor light

9. PT111, PT111Ti, PT132, PT138, PT140, PT145 and PT145Ti **SAFETY FEATURES** - The PT111, PT111Ti, PT132, PT138, PT140, PT145 and PT145Ti pistols are equipped with the following safety features:

A. Manual safety lever on the left side of the frame above the left-hand grip. When turned ON (up), the Safety Lever will prevent the trigger from being pulled to the rear.

B. Automatic firing pin block safety is built in and blocks the firing pin from forward movement until the trigger is pulled completely to the rear.

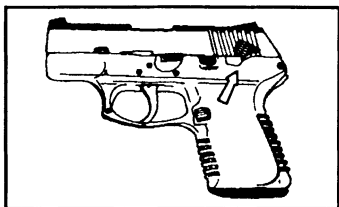

WARNING

NEVER RELY COMPLETELY ON ANY SAFETY MECHANISM. It is NOT a substitute for cautious firearm handling. NO safety, however positive or well-designed, should be totally trusted. Like all mechanical devices, the safety is subject to breakage or malfunction and can be adversely affected by wear, abuse, dirt, corrosion, incorrect assembly, improper adjustment or repair, or lack of maintenance. Moreover, there is no such thing as a safety which is "childproof" or which can completely prevent accidental discharge from improper usage, carelessness, or "horseplay". The automatic safety can provide only partial protection against mishaps. By itself it is not a complete safety system. To prevent accidents, it is absolutely essential to consistently and correctly use the manual safety lever also. If water, sand, or other foreign matter enters the internal mechanism, the firearm should be dismantled for complete and thorough cleaning. Failure to keep your firearm clean and in proper working order can lead to a potentially dangerous condition.

SAFETY DEVICES

(PT58 S-D, PT92 C-D, PT92 AF-D, PT99 AF-D, PT100 AF-D, PT101 AF-D, PT908, PT911, PT938, PT940, PT945 and PT957)

1. The FIRING PIN BLOCK (4) is permanently locked preventing the FIRING PIN (5) from going forward which could cause accidental discharge should the pistol be dropped.

The FIRING PIN BLOCK (4) is only released at the TRIGGER (1) final stage position, allowing the FIRING PIN (5) to advance as soon as it receives the HAMMER (6) impact energy. The release is done through the following movement series: TRIGGER (1), TRIGGER BAR (2), FIRING PIN BLOCK LEVER (3) and FIRING PIN BLOCK(4).

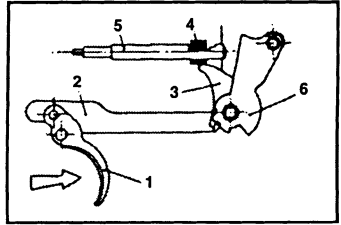
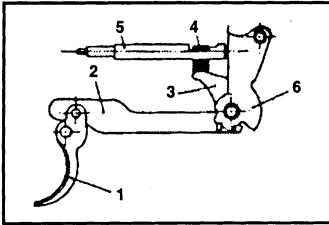

PT58, 92, 92C, 99, 100, 101, 908, 911, 938, 940, 945, 957.

2. By moving the SAFETY upward you will disengage the hammer and sear simultaneously. The SAFETY was designed to allow AMBIDEXTROUS use and it enables a rapid change from safe to fire position.

3. When a cartridge is loaded in the chamber the EXTRACTOR end protrudes and its red colored surface can be easily seen or felt without the need of moving back the SLIDE.

CAUTION - Taurus Models PT111, PT140, PT911, PT938, PT940 and PT957 manufactured before July, 2000 do NOT contain a loaded



chamber indicator. To determine if chamber is loaded, make sure your finger is not on the trigger or inside the trigger guard and pull slide to rear and visually inspect the chamber. In any case, always inspect the chamber visually by pulling the slide back slowly and looking into the chamber while keeping your finger well clear of the trigger and trigger guard and keeping the muzzle pointed in a safe direction.

DANGER: CLEARING THE CHAMBER

To clear the chamber of a Taurus Pistol, first make sure the muzzle is pointed in a safe direction. Remove magazine and set aside. While keeping your finger well away from the trigger and trigger guard, disengage the manual safety, and pull the slide smartly to the rear. The cartridge will eject. Lock the slide open and visually inspect the chamber to make sure the pistol is unloaded. You may then close the slide and secure your firearm.

21

ALWAYS KEEP THE MUZZLE POINTED IN A SAFE DIRECTION.

4. By moving safety (3) downward you will lower the hammer (5) and disengage the trigger bar (2) so that the connection between trigger (1) and sear (4) will be interrupted. The hammer (5) forward motion will be stopped by the hammer catch (6).

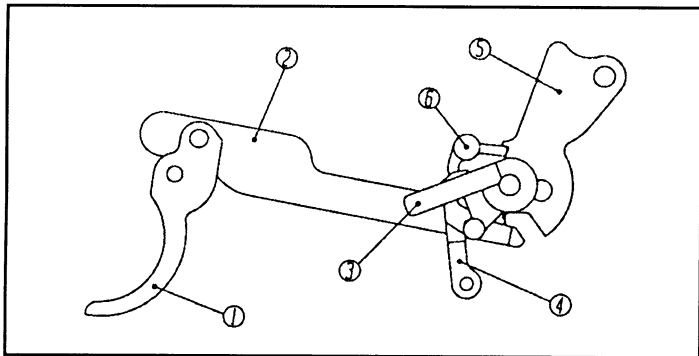

PT58, 92, 92C, 99, 100, 101, 908, 911, 938, 940, 945, 957.

FIELD STRIPPING

(PT58 S-D, PT92 C-D, PT92 AF-D, PT99 AF-D, PT100 AF-D, PT101 AF-D, PT908, PT911, PT938, PT940, PT945, and PT957)

1. Remove the **MAGAZINE** by pressing the **MAGAZINE RELEASE BUTTON**; be sure that the chamber is **EMPTY**.

2. With the left forefinger press the **DISASSEMBLY LATCH RELEASE** and with the left thumb rotate the **DISASSEMBLY LATCH** clockwise until it stops.

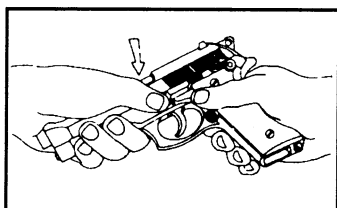
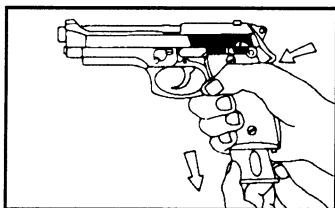

3. Pull forward the **SLIDE-BARREL** assembly.

4. Slightly press the **RECOIL SPRING GUIDE**. Lift and remove it carefully.

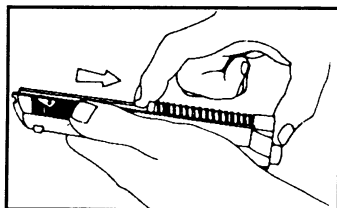
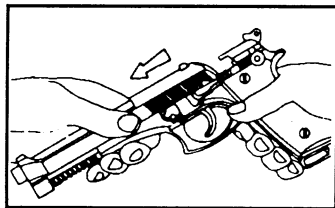

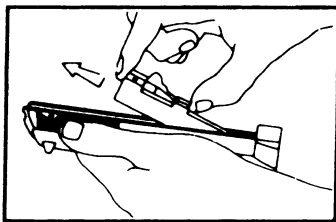
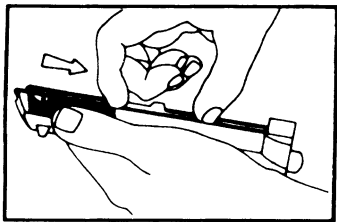

5. Press LOCKING BLOCK PLUNGER (PT-92 C-D, PT-92AF-D, PT-99 AF-D, PT-100 AF-D AND PT-101 AF-D)

6. Remove the BARREL from the SLIDE.

On Models 58, 111,132, 138,140, 145, 908, 911, 938, 940, 945 and 957 there is no locking block. Remove spring and guide and then barrel from slide. ATTENTION: No further disassembly is recommended unless done by a skilled gunsmith.

FIELD STRIPPING PT111, PT111Ti, PT132, PT138, PT140, PT145 & PT145Ti

NOTICE: Some newer model pistols feature a takedown pin rather than a disassembly latch. Instructions for the pin, where these instructions differ, are in blue.

1. Remove the MAGAZINE by pressing the MAGAZINE RELEASE BUTTON; be sure that the chamber is EMPTY.

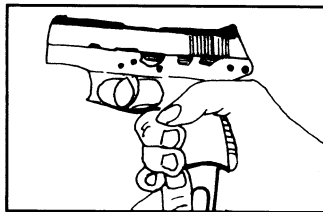

2. Pull SLIDE fully to the rear and push up the SLIDE CATCH LEVER.

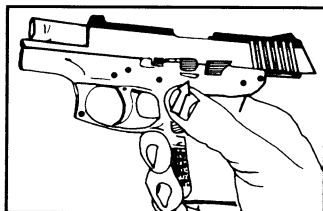

3. With left thumb, rotate SLIDE DISASSEMBLY LATCH clockwise until it stops.

Use the key for your Taurus Security System to gently push the pin from the right side of the pistol.

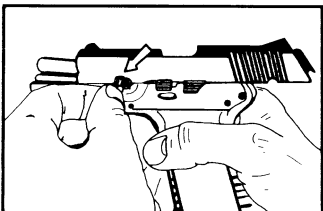

4. With left hand, pull SLIDE DISASSEMBLY LATCH or TAKE-DOWN PIN out of frame.

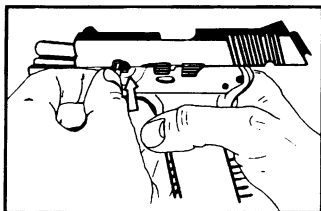

5. Carefully release SLIDE CATCH, and with SLIDE under full control, pull SLIDE forward off of frame.

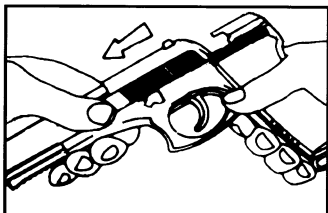

6. Carefully remove SLIDE SPRING and GUIDE from its position on the bottom of the BARREL. SPRING is under compression so it must be kept under control until removed.

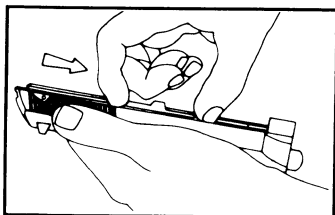

7. Remove BARREL from SLIDE by pulling to the rear and up.

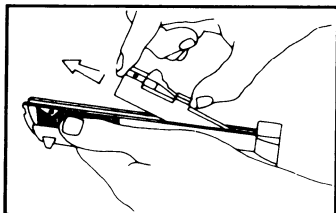

ATTENTION: No further disassembly is recommended unless done by a skilled gunsmith.



If the slide sticks on the frame, be sure the chamber is empty and firmly pull the trigger fully to the rear while pulling the slide forward off the frame.

If the slide does not move because the barrel remains to the rear and tilted upward, be sure the chamber is empty and push the muzzle against the palm of one hand while pushing the slide forward with the other.



ASSEMBLY

(PT58 S-D, PT92 C-D, PT92 AF-D, PT99 AF-D, PT100 AF-D, PT101 AF-D PT908, PT911, PT938, PT940, PT945 and PT957)

1. The FIRING PIN BLOCK LEVER must be lowered while assembling the SLIDE in the FRAME.
2. Before turning the DISASSEMBLY LATCH or reinserting the TAKE-DOWN PIN the SLIDE must be perfectly aligned to the rear of the FRAME.

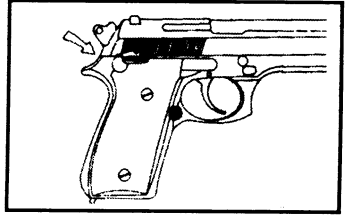
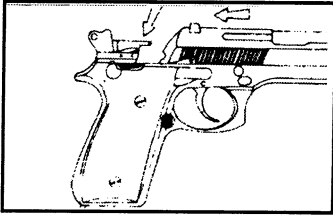

On **PT938** pistols it is necessary to press slightly down on the barrel while assembling the slide on the frame.

ASSEMBLY FOR LEFT HAND USE

TAURUS pistols (except models PT22, PT25, PT111, PT111Ti, PT132, PT138, PT140, PT145, PT145Ti, PT908 and PT945) can be adjusted to be used by left handed people by following the instructions below:

1. Using a pin punch press in the MAGAZINE RELEASE BUTTON unscrewing the MAGAZINE RELEASE BUTTON at the same time.
2. Reassemble with MAGAZINE RELEASE BUTTON at the right side of the firearm.

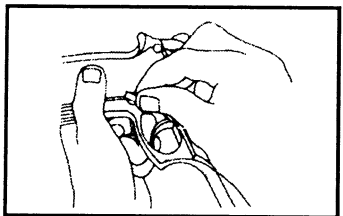
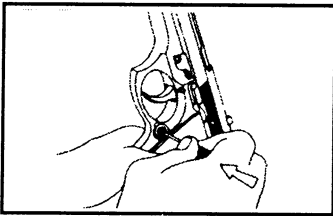

ASSEMBLY OF PT111, PT111Ti, PT132, PT138, PT140, PT145 AND PT145Ti

In order to reassemble the pistol, proceed by reversing the disassembling procedure while observing the following details:

1. Replace the barrel in the slide pushing it to the rearward position. Mount the spring on the guide rod. Insert the spring/guide rod sub-assembly into the slide over the barrel, compressing the spring slightly to get it into position. The SLIDE should be mounted on the frame and pulled fully to the rear and the SLIDE CATCH must be moved upward to hold the SLIDE to the rear.

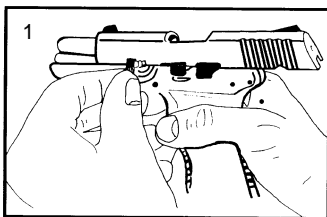

2. When reinstalling the SLIDE DISASSEMBLY LATCH, it is inserted into the frame with the lever pointing rearward and the horizontal round portion of the latch must engage the mating surface on the bottom of the BARREL.

Insert the take-down pin once the slide is in position to line up the barrel with the hole, and gently push in. A click will indicate the pin is secured in place.

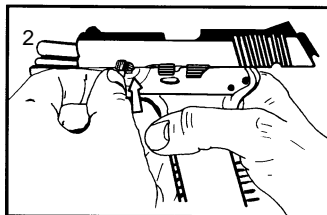

3. The SLIDE CATCH then can be depressed which allows the SLIDE to go forward.

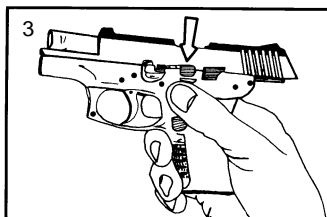

4. You should cycle the SLIDE several times, with no magazine inserted and no rounds in the chamber, to insure that the barrel/slide/frame relationship is correct.

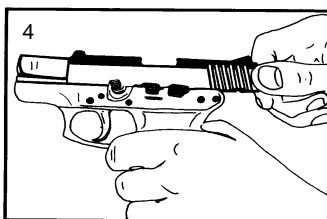

The slide may stick on the frame before going fully to the rear, or the barrel may ride with it to the rear. Begin again and press down with the finger onto that rear portion of the barrel accessible through the ejection port.

When the barrel depresses and locks to the frame, continue moving the slide fully to the rear and engage the slide catch lever.



SAFETY FIRST: PARTS

All firearms require periodic maintenance and inspection which may reveal a need for adjustment or repair. Have your firearm checked by a competent gunsmith annually, even if it seems to be working well, since breakage, improper functioning, undue wear, or corrosion of some components may not be apparent from external examination. If you notice ANY mechanical malfunction, do NOT continue to use the firearm. UNLOAD the firearm and take it to a competent gunsmith immediately.

Our Service Department maintains a full complement of replacement parts for our firearms of current manufacture. Even though most gunsmiths have the knowledge, training and ability to make the necessary repairs to your firearm, the skill and workmanship of any particular gunsmith is totally beyond our control. Should your firearm ever require service, we strongly recommend that you return it to Taurus. Follow the instructions outlined below. Remember, unauthorized adjustments or parts replacement can void your warranty.

It is the responsibility of the purchaser to be absolutely certain that any parts ordered from Taurus are of the correct type and are properly fitted and installed by a competent person.

THIS FIREARM IS A PRECISION MECHANISM AND THE IMPROPER FITTING OF PARTS OR IMPROPER MECHANICAL ADJUSTMENT MAY RESULT IN A DANGEROUS MALFUNCTION, DAMAGE TO THE FIREARM, AND POSSIBLE SERIOUS INJURY TO THE SHOOTER OR TO OTHERS.

Therefore, the purchaser and/or installer of parts must accept full responsibility for the correct adjustment of and function of the firearm after such installation has been made or attempted.

TAURUS SERVICE POLICY

Before shipment, your firearm was carefully inspected and test fired in order to ensure that it conformed to our specifications and standards. Should your firearm require adjustment or repair, we strongly recommend that you return it to Taurus for factory service.

If there is any question regarding the performance of your firearm, please write to our Service Department fully describing all circumstances and conditions involved. If our Service Department makes the determination that your firearm requires factory service, you will be so advised and will be given instructions for the most expeditious handling of your shipment.

Our Service Department will give your firearm a complete inspection, and evaluate the problem(s) specified in your letter. If the work required is not covered under the terms of our Warranty (when applicable) you will receive an actual cost quotation, not an estimate. Any repair work must be authorized by you, and no work will be done without your expressed approval.

Please follow these suggestions to expedite service in the United States of America to return any firearm to us for adjustment or repair.

1. Federal law permits you to return your firearm to the manufacturer for service via common carriers. However, state and local firearms laws vary greatly; you should consult your local prosecuting attorney regarding any restrictive laws in your jurisdiction regarding your shipment or receipt of firearms. With the above in mind, it is strongly recommended that any firearm sent to us for repair be sent through a Federally licensed dealer.
2. All firearms must be shipped to us prepaid. **WE WILL NOT ACCEPT COLLECT SHIPMENTS.**
3. Be sure to enclose a letter stating your name, address and telephone number, serial number, caliber and barrel length of your firearm. Also state nature of trouble experienced or work required. Merely stating "defective" or "repair as necessary" is inadequate information. Be specific and enclose copies of any previous correspondence. Work (other than warranty repair) will bear minimum labor charge of \$ 10.00.
4. **FIREARMS MUST BE SHIPPED UNLOADED.** Double check the chamber of your firearm before shipping. If firearms are sent to Taurus in a loaded condition, we are required by law to notify the Federal authorities.
5. **DO NOT** include telescopic sights; custom grips, holsters, or other accessories with any firearm shipped to us.

EXPLODED VIEW OF MODELS PT92 C-D, PT92 AF-D, PT99 AF-D, PT100 AF-D AND PT101 AF-D.

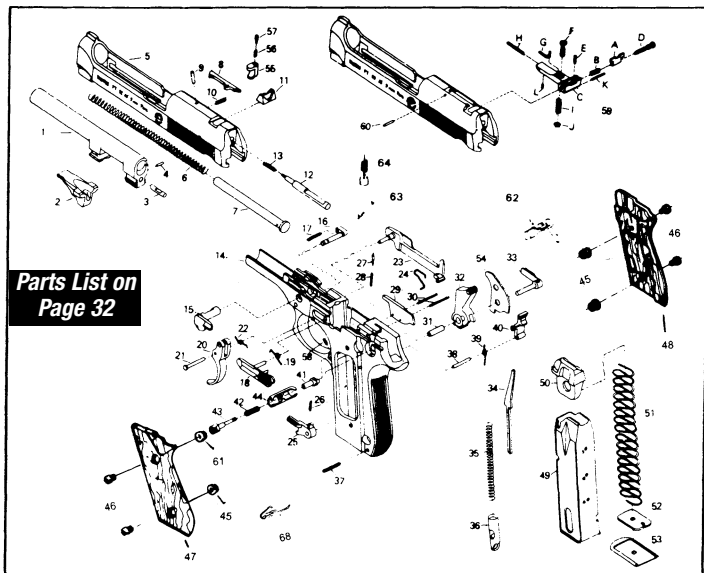

	PT92 C-D	PT92 AF-D	PT99 AF-D	PT100 AF-D	PT101 AF-D
Caliber	9 mm PARA.	9 mm PARA.	9 mm PARA.	.40 S&W	.40 S&W
Number of shots	10+1	10+1	10+1	10+1	10+1
Barrel	4 1/4"	5"	5"	5"	5"
Total Length	8"	8 1/2"	8 1/2"	8 1/2"	8 1/2"
Weight	32 oz.	33 1/2 oz.	33 1/2 oz.	34 oz.	34 oz.
Front Sight	Square, Integral with slide				
Rear Sight	Square Notch, dovetailed to slide		Micrometer click, adjustable for windage and elevation	Square notch, dovetailed to slide	Micrometer click, adjustable for windage and elevation
Grips	Rubber				
Finish	Blue or Stainless				

EXPLODED VIEW OF MODEL PT 58 S-D

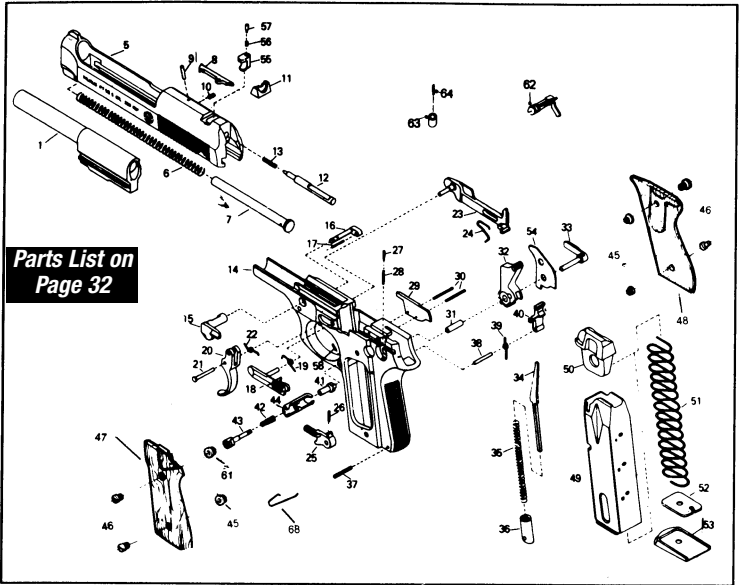

	PT58 S-D
Caliber	9 mm PARA.
Number of shots	10+
Barrel	4 1/4"
Total Length	8"
Weight	32 oz.
Front Sight	Square, Integral with slide
Rear Sight	Square Notch, dovetailed to slide
Grips	Rubber
Finish	Blue or Stainless

EXPLODED VIEW OF MODEL PT911, PT938, PT940, PT945 AND PT957

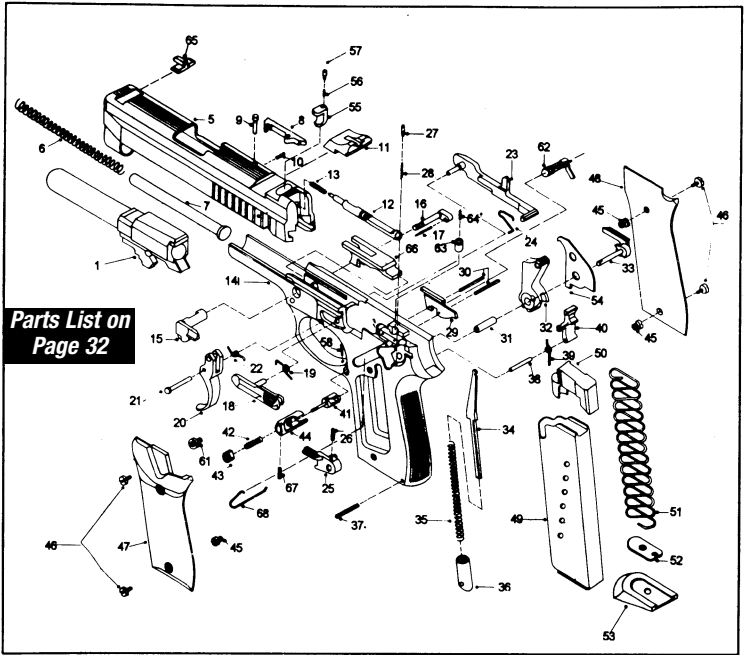

	PT911	PT938	PT940	PT945	PT957
Caliber	9 mm PARA.	.380 ACP	.40 S&W	.45 ACP	.357 SIG
Number of shots	10+1	10+1	10+1	8+1	10+1
Barrel	3.86"	3.7"	3.88"	4.25"	3.88"
Total Length	7.12"	6.7"	7.12"	7.45"	7.12"
Weight	28 oz.	26.8 oz.	30 oz.	30 oz.	30 oz.
Front Sight	Square, dovetailed to slide				
Rear Sight	Square Notch, dovetailed to slide				
Grips	Santoprene				
Finish	Blue or Stainless				

ALWAYS KEEP THE MUZZLE POINTED IN A SAFE DIRECTION.

**PT92 C-D, PT92 AF-D, PT99 AF-D, PT100 AF-D, PT101 AF-D,
PT 58 S-D, PT911, PT938, PT940, PT945 AND PT957
PART LIST**

ITEM	NAME	ITEM	NAME
01	Barrel	38	Sear pin
02	Locking block	39	Sear spring
03	Locking block plunger	40	Sear
04	Locking block plunger pin	41	Magazine release
05	Slide	42	Magazine release spring
06	Recoil spring	43	Magazine release button
07	Recoil spring guide	44	Magazine release case
08	Extractor	45	Grip bushing
09	Extractor pin	46	Grip screw
10	Extractor spring	47	Left grip
11	Rear sight	48	Right grip
12	Firing pin	49	Magazine box
13	Firing pin spring	50	Magazine follower
14	Frame	51	Magazine spring
15	Disassembly latch	52	Magazine plate
16	Disassembly latch release	53	Magazine bottom
17	Disassembly latch release spring	54	Firing pin block lever
18	Slide catch	55	Firing pin block
19	Slide catch spring	56	Firing pin block spring
20	Trigger	57	Firing pin block pin
21	Trigger pin	58	Magazine release case pin
22	Trigger spring	59	Rear sight assembly
23	Trigger bar	60	Rear sight pin
24	Trigger bar spring	61	Left grip upper bushing
25	Safety	62	Hammer catch
26	Safety elastic pin	63	Hammer catch plunger
27	Safety plunger	64	Hammer catch plunger spring
28	Safety plunger spring	65	Front sight
29	Ejector	66	Central support
30	Ejector pin	67	Magazine release pin
31	Hammer bushing	68	Safety spring
32	Hammer		
33	Right safety latch		
34	Hammer spring guide		
35	Hammer spring		
36	Hammer spring support		
37	Hammer spring support pin		

PT111, PT111Ti, PT132 PT138, PT140, PT145 & PT145Ti PART LIST

ITEM	NAME	ITEM	NAME
01	SLIDE ASSEMBLY (Include parts #2 to #16)	34	GRIP
02	SLIDE	35	GRIP PIN
03	FRONT SIGHT	36	MAGAZINE RELEASE
04	EXTRACTOR PIN	37	GRIP BOTTOM
05	EXTRACTOR	38	MAGAZINE ASSEMBLY (Include parts #39 to #43)
06	EXTRACTOR SPRING	39	FOLLOWER
07	REAR SIGHT SCREW	40	MAGAZINE SPRING
08	INTERNAL RECOIL SPRING	41	MAGAZINE SPRING PLATE
09	REAR SIGHT	42	MAGAZINE BOTTOM
10	FIRING PIN SPRING STOP	43	MAGAZINE BODY
11	FIRING PIN	44	SAFETY SPRING
12	FIRING PIN SPRING	45	SAFETY SPRING BALL
13	FIRING PIN SPRING GUIDE	46	SLIDE RETAINER
14	TRIGGER BAR RAMP	47	SLIDE RETAINER SPRING
15	TRIGGER BAR RAMP PIN	48	FIRING PIN SAFETY
16	FIRING PIN RETAINER	49	FIRING PIN SAFETY PIN
17	INTERNAL RECOIL SPRING GUIDE	50	FIRING PIN SAFETY SPRING
18	EJECTOR	51	FIRING PIN SAFETY PLATE
19	TRIGGER BAR	52	FIRING PIN SAFETY SCREW
20	SLIDE CATCH SPRING	53	FIRING PIN SPRING RETURN
21	TRIGGER PIN		
22	DISASSEMBLING LATCH		
23	SLIDE CATCH		
24	TRIGGER BAR PIN		
25	TRIGGER SPRING		
26	TRIGGER		
27	EJECTOR PIN		
28	SAFETY		
29	FRAME		
30	BARREL		
31	RECOIL SPRING		
32	MAGAZINE RELEASE SPRING		
33	RECOIL SPRING GUIDE		

EXPLODED VIEW OF MODELS PT111, PT111Ti, PT132 PT138, PT140, PT145 & PT145Ti

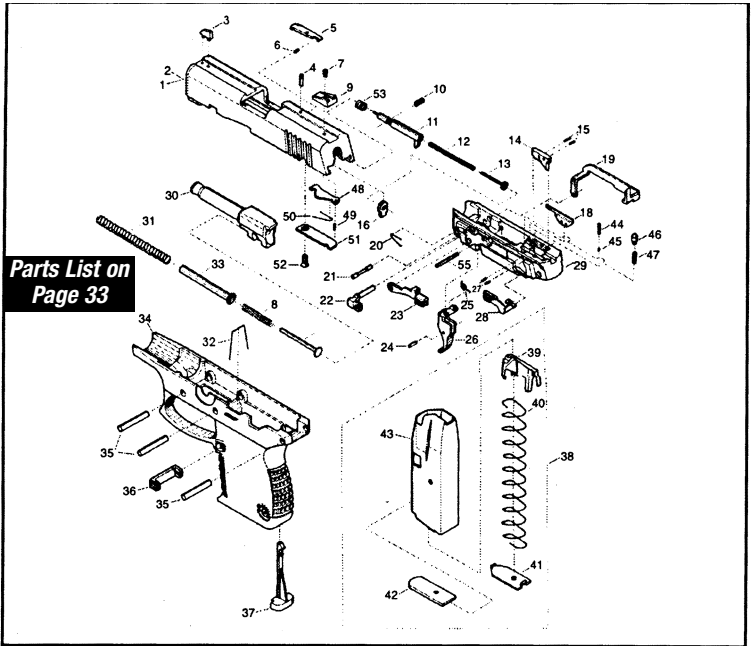

	PT111 PT111Ti	PT132	PT138	PT140	PT145 PT145Ti
Caliber	9 mm	.32 ACP	.380 ACP	.40	.45 ACP
Number of shots	10+1	10+1	10+1	10+1	10+1
Barrel	3.30"	3.30"	3.30"	3.30"	3.30"
Total Length	6.00"	6.00"	6.00"	6.00"	6.10"
Weight	19 oz. 16 oz.	19 oz.	19 oz.	21 oz.	22 oz. 19 oz.
Front Sight	Square, dovetailed to slide				
Rear Sight	Square notch, dovetailed to slide				
Grips	Polymer				
Finish	Blue, Stainless or Titanium Shadow Gray (PT111Ti & PT145 Ti only)				



This trademark, forged for over 60 years of hard and dedicated work, became a symbol of quality in handguns for civilian, police and military use. This outstanding quality is the result of constant technological evolution and from the devoted work of expert gunsmiths and highly specialized professionals, which makes TAURUS a respected name in more than 75 countries all over the world.

A WORD TO THE WISE

**MOST FIREARM ACCIDENTS HAPPEN
BECAUSE THE SHOOTER CARELESSLY
VIOLATES THE SINGLE MOST
IMPORTANT RULE OF SAFE FIREARM
HANDLING:
ALWAYS KEEP THE MUZZLE POINTED
IN A SAFE DIRECTION!**

**IMPORTANT:
DO NOT DISCARD
KEEP THIS MANUAL WITH YOUR
FIREARM. UPON CHANGE OF
OWNERSHIP, TRANSFER THIS
MANUAL WITH THE FIREARM.**



TAURUS

Forjas Taurus, S.A

Av. do Forte, 511 - Cx. Postal 44 - Telegr.: "Forja"

Fone: (051)3347.4000 - Fax: (051)3347.3075

91360-000 - Porto Alegre - RS - Brasil



TAURUS

Taurus International Manufacturing, Inc.

16175 NW 49 Avenue

Miami, Florida 33014

Telephone: (305)624.1115 - Fax: (305)624.1126