

SCIENTIFIC AMERICAN

[Entered at the Post Office of New York, N. Y., as Second Class Matter. Copyright, 1908, by Munn & Co.]

Vol. **XCVIII**.—No. 13. ★
ESTABLISHED 1845.

NEW YORK, MARCH 28, 1908.

★ [10 CENTS A COPY
\$3.00 A YEAR.

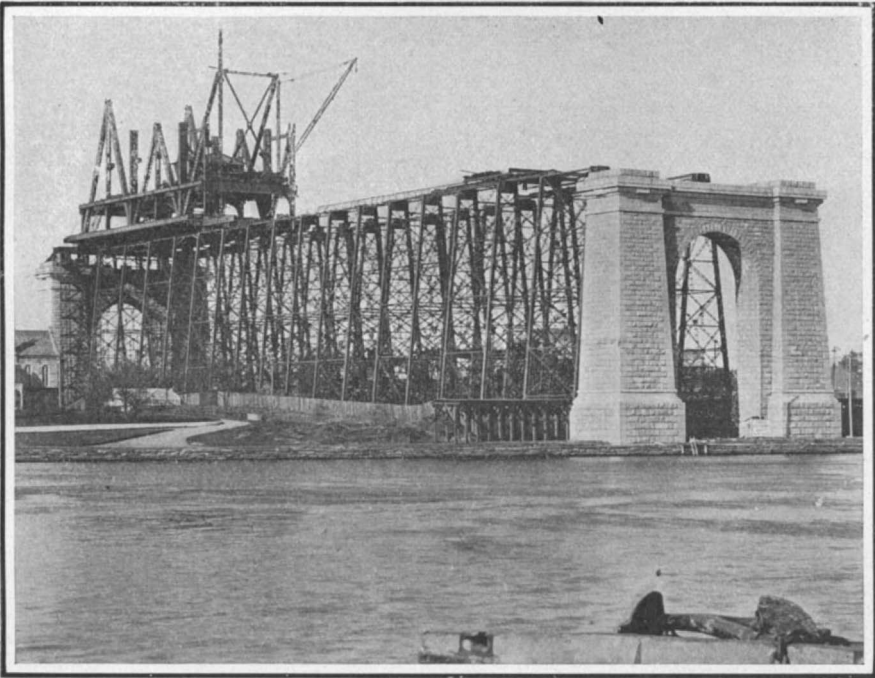

Steel Falsework for Carrying the Island Span During Erection; This Span Weighs 16½ Tons to the Foot.

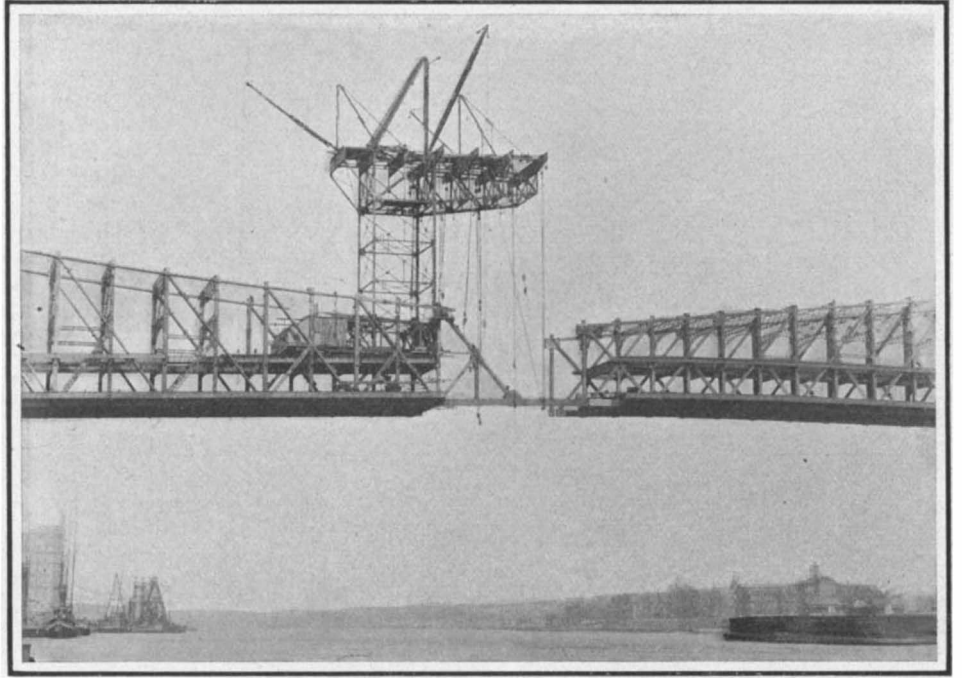

The 600-ton Traveler is Putting in Position the Last Section of the 1,182-foot Cantilever.



Total Length of Bridge, Including Approaches, 7,408 Feet. Total Length of Cantilevers, 3,727 Feet. Total Weight of Cantilevers, 52,000 Tons. Bridge Has Two Floors, Accommodating Eight Tracks; a 36-Foot Driveway, and Two 13-Foot Sidewalks for Pedestrians. The Strongest and Heaviest Bridge in the World, Able to Carry 8 Tons to Each Foot of Its Length.

GENERAL VIEW OF THE GREAT CANTILEVER BRIDGE OVER THE EAST RIVER AT BLACKWELL'S ISLAND, NEW YORK.—[See page 223.]

SCIENTIFIC AMERICAN

ESTABLISHED 1845

MUNN & CO. - - - Editors and Proprietors

Published Weekly at

No. 361 Broadway, New York

CHARLES ALLEN MUNN, *President*
361 Broadway, New York

FREDERICK CONVERSE BEACH, *Sec'y and Treas.*
361 Broadway, New York

TERMS TO SUBSCRIBERS.

One copy, one year, for the United States or Mexico \$3.00
One copy, one year, for Canada 3.75
One copy, one year, to any foreign country, postage prepaid, 18s. 6d. 4.50

THE SCIENTIFIC AMERICAN PUBLICATIONS.

Scientific American (established 1845) \$3.00 a year
Scientific American Supplement (established 1876) 5.00 "
American Homes and Gardens 3.00 "
Scientific American Export Edition (established 1878) 3.00 "

The combined subscription rates and rates to foreign countries, including Canada, will be furnished upon application.

Remit by postal or express money order, or by bank draft or check.

MUNN & CO., 361 Broadway, New York.

NEW YORK, SATURDAY, MARCH 28, 1908.

The Editor is always glad to receive for examination illustrated articles on subjects of timely interest. If the photographs are sharp, the articles short, and the facts authentic, the contributions will receive special attention. Accepted articles will be paid for at regular space rates.

ACETYLENE LAMPS AND SMOKY AUTOMOBILES.

In a recent message Mayor McClellan made a recommendation which merited greater attention than it has received. We refer to his suggestion that a city ordinance be passed, making it a misdemeanor to carry acetylene lights or run a smoky automobile in the city streets. Both of these recommendations are based upon a recognition of the right of the general public to be protected against unnecessary risks and nuisances—to which category the blinding acetylene lamp and the evil-smelling, smoky automobile undoubtedly belong.

That the dazzling brilliancy, which renders the acetylene lamp such an excellent light for the chauffeur, has a blinding effect when thrown in the eyes of drivers or pedestrians who are moving in the opposite direction, is a fact that has long been well understood. In Europe, indeed, the danger has been considered so great as to call for legislation, and the use of the acetylene lamp has long been prohibited in the streets of European cities. In the darkness of unlighted country roads acetylene is the ideal light; but on the lighted streets of the city it is altogether superfluous, and the ordinary kerosene or electric lamp is sufficient.

Of even greater importance than the lamp question is that of the intolerable nuisance of smoky cars, a nuisance that has become exceedingly aggravated of late in this city, largely owing to the introduction of taxicabs, which are by long odds the worst offenders. There is absolutely no excuse for a smoky car. The smoke is due to filling the crank case and flooding the cylinders with an unnecessary amount of oil. Of course, it may occasionally happen that a little extra oil will pass into the cylinders, producing a temporary emission of smoke from the exhaust; but when cars pass through the streets, pouring forth, as they often do, dense volumes of malodorous gases, the nuisance is due either to carelessness or stupidity. That the taxicabs should be the chief offenders is something of a mystery; for it seems but natural that the companies operating these cabs should require their chauffeurs to be as economical of oil as possible.

We heartily agree with the Mayor that this nuisance should also be made the subject of a city ordinance. European cities, as usual, are a long way-ahead of us in these matters, and a chauffeur whose car is emitting smoke is liable to summary arrest. Moreover, the law is rigidly enforced; and we have in mind a case, personally known to us, of an American being instantly cautioned in Hyde Park, London, when his car began to show smoky tendencies, and of his receiving a second caution before he had traveled another three hundred yards. Restrictions such as these are perfectly reasonable, and are based upon the broad principle that, in the management of a city, the convenience and comfort of the great majority should be the prime consideration.

THE COMPARATIVE TRIALS OF OUR SCOUT CRUISERS.

The trials of the scout cruiser "Birmingham," which have recently taken place, afford the long-anticipated opportunity of gaging, in this country, under identical conditions of trial, the relative efficiency of the Parsons marine turbines against reciprocating marine engines. In our issue of March 14, we gave the data of the government trials of the turbine-driven scout "Chester." The "Birmingham," which is of exactly the same size and model as the "Chester," but is driven by triple-

expansion reciprocating engines, was put through an identical series of trials, and the comparative results arrived at are as follows: In the four-hour speed trial at full power, the "Birmingham" averaged 24.32 knots an hour as against 26.52 knots for the "Chester," an excess of speed of 2.2 knots for the turbine-driven boat. In the 24-hour test at 22½ knots speed, the "Birmingham" made 22.665 knots as against 22.78 knots for the "Chester," the former steaming 2.475 knots for each ton of coal burned, as against 2.824 knots for the latter, an excess in speed of 0.115 knot, and of distance traveled per ton of coal of 0.349 knot, in favor of the turbine-driven vessel. In the 24-hour trial at 12 knots speed, both vessels steamed at an average of 12.2 knots, the "Birmingham" covering 5.96 knots per ton of coal, and the "Chester" 6.67 knots per ton, the turbine-driven boat thus steaming nearly ¼ of a knot farther for each ton of coal than the vessel driven by reciprocating engines. This last is a most surprising result; for it has always been considered that at speeds below 15 knots, the turbine would be considerably more expensive in coal than the reciprocating engine.

There now remains the test of the third of these sister ships, to render the comparison complete. This will occur when the "Salem," which is engined with turbines of the Curtis type, is sent out for similar trials over the same course.

THE NEW YORK HIGH-PRESSURE FIRE PROTECTION SYSTEM.

Recent disastrous city conflagrations, and particularly that at Baltimore, brought home to the citizens of New York the necessity for the provision of some auxiliary system of fire protection, which would be sufficiently powerful to absolutely prevent the possibility of the business section of New York being swept out of existence by fire. It was decided to provide pumping stations and a system of mains covering what is known as the dry goods district, which should be independent of the existing Fire Department plant, and be capable, at a moment's notice, of concentrating a heavy flood of water at any point which might be threatened. The work was put in hand, and has been pushed through to completion. In about a month's time it will be at the service of the city.

The district covered by the system extends from 25th Street south to the City Hall, and east from the Hudson River to Second Avenue and East Broadway. It includes over sixty miles of extra heavy mains of from 12 to 24 inches diameter, served by two separate pumping stations, each of which, as at present completed, has a capacity of 15,000 gallons per minute delivered at a pressure of 300 pounds per square inch. Moreover, space has been left in the two pumping plants for additional pumps, which will bring the combined capacity of the two plants up to a total of 48,000 gallons per minute. The work has been planned and carried out by Mr. I. M. De Varona, Chief Engineer of the Department of Water Supply, Gas, and Electricity; and it embodies the ripe experience of nearly a quarter of a century of service, in the latter days of which he installed at Coney Island the very successful high-pressure service, which recently was instrumental in flooding out a conflagration that threatened to wipe the place out of existence.

The general impression that an enormous quantity of water is used for fire purposes is erroneous. Figures furnished by the Fire Department for the years 1900 to 1904 show that in 1901, in which the maximum amount of water was used, the total amount of water expended in the borough of Manhattan for fire purposes was just under 100,000,000 gallons, of which 70,000,000 were river water. Deducting the river water, we find that about 30,000,000 gallons of water were drawn from the fresh-water mains for fire purposes during that year. Now, the daily average consumption of water for drinking and other purposes is about 300,000,000 gallons; so that the total amount of water used from the mains for fire purposes during a year is only about one-tenth of the amount of Croton water used for all purposes in a single day. The quantity needed for fire purposes, then, need not be considered in determining the question of the total water supply required for all purposes by the city. As Mr. De Varona states, "the difficulty in affording adequate fire protection has not been the lack of water, but the lack of means to concentrate a requisite amount at the scene of a fire." The value of the present high-pressure service lies in the fact that it will now be possible to concentrate a sufficient volume of water at any threatened locality to make sure of getting any fire under control. As the total capacity of the two pumping stations about to be placed in service is 43,000,000 gallons per day, they will be equal in capacity to about two-thirds of the total amount of fresh water used in Manhattan for fire purposes during the whole year 1903. Their total capacity, moreover, will exceed that of all the fire engines in the borough of Manhattan working under normal conditions, and will be equivalent to approximately two-thirds of the combined capacity of all the fire engines in the boroughs of Manhattan, the Bronx, and Brooklyn. This comparison is based on the average capacities of steam

fire engines, as printed in the official blank forms of reports of the Fire Department, where the average is assumed at 250 gallons per minute.

As showing the wide margin provided by the new service over possible requirements of water at a fire, it is sufficient to state that the largest fire recorded in recent years by the Fire Department was that at 188 to 194 Mott Street, which lasted 106 hours, and during which 1,590,000 gallons of water were used. The supply from the new high-pressure stations during that length of time, at the present capacity of 43,000,000 gallons, would have been nearly 200,000,000 gallons of water.

The two stations are located on the water front, one at the corner of Gansevoort and West Streets on the Hudson River, and the other at the corner of Oliver and South Streets on the East River. They are thus outside the limits of districts in which the fire risk is hazardous. A conflagration could not practically affect either station, and certainly could not affect both stations. Each station is arranged so that it can draw its water either directly from the Croton mains, in which case the pressure would be increased from 25 to 325 pounds per square inch, or they can draw their supply directly from the salt water of the harbor. That the Croton mains will provide an ample supply is evident from the fact that the Oliver Street station can draw upon two 20-inch, one 24-inch, one 30-inch, and two 36-inch mains. The salt-water supply will be taken from the river by two 36-inch pipes, leading direct from the East River to a suction chamber in front of the pumping station. The pumping units will consist in each station of five 6-stage centrifugal pumps, driven by electric motors; the electric current being furnished by the New York Edison Company at a pressure of 6,660 volts. The stations are also partially equipped with rotary converters and storage batteries; so that, in the case of a breakdown, the storage batteries and converters can be put in service.

The distribution of the mains includes two 24-inch discharge mains, which lead from each station and bound the entire district under protection, and 16-inch and 12-inch mains, which run in streets parallel to and intersecting these mains. All mains are cross-connected at the points of intersection, so as to obtain a perfect circulation. Careful computations show that the full capacity of both stations can be delivered in any section within the area covered, with a pressure at the base of the hydrants of about 250 pounds per square inch. If the system were extended to 42d Street, the pressure from the Oliver Street station would be not less than 220 pounds per square inch, and at 59th Street would not be less than 215 pounds per square inch. Again, if there were a fire in 23d Street, and each 300 feet of 3-inch hose were serving a 1¼-inch smooth nozzle, the hydrants would each give about 550 gallons per minute, and the streams would be thrown vertically to an extreme height of 220 feet. At 42d Street 520 gallons per minute would be thrown to a height of 205 feet, and at 59th Street the delivery per nozzle would be about 515 gallons per minute and the extreme vertical height of the stream about 200 feet. Finally, as showing the enormous capacity of the plant, Mr. De Varona states that the hydrants are always within 400 feet of any building in the district, "and there are sufficient hydrants, so that if any block were on fire, 60 streams of 500 gallons per minute each, or the full capacity of both stations, could be concentrated on a block, with a length of hose not exceeding from 400 to 500 feet, assuming the use of 3-inch hose and 1¼-inch nozzles."

The system has been so designed that it may be used for street sprinkling and flushing; but care has been exercised to avoid any reduction in the efficiency of the system from a fire standpoint, by street-cleaning appliances, should it be used for this purpose. The hydrants to be used for street cleaning will be so designed that the supply of water will be cut off therefrom when the pressure in the main rises above any prescribed limit, say of 70 pounds. We think that great care should be exercised to separate the use of the system for street cleaning from its primary use for fire protection. It would imperil the efficiency of the service to allow the Street Cleaning Department men to use the fire service hydrants at will. The proposal to install separate pumps in the stations, for use with separate and special street-cleaning hydrants, is a wise one, and should certainly be followed out.

Peat coke manufacture by the Ziegler process has recently been started at Beuerberg, Bavaria. The peat is cut up, pressed, and exposed to the air until evaporation has reduced its water to less than 25 per cent of the whole mass. This peat is then placed in a retort for eighteen hours. The coke is finally received in air-tight iron cars which are left for six or eight hours to cool before they are discharged. Each retort yields during every twenty-four hours eight to ten tons of coke. The gas is passed through various tanks and towers in which the by-products are separated, and is then employed in assisting the retort process which could not even commence without the external application of heat.

THE HEAVENS IN APRIL.

BY HENRY NORRIS RUSSELL, PH.D.

The most interesting astronomical announcement of the past month comes from Greenwich, and relates to a faint planet discovered there by Mr. Melotte.

The mere discovery of another asteroid calls for no remark, for such are now found every month. But this object is very close to Jupiter (about $\frac{3}{4}$ of a degree south of him) and seems to be moving with him among the stars, the relative motion of the two being less than one-tenth of the distance that the two appear to have traveled. It therefore seems very likely (as is suggested in the telegram announcing the discovery) that this is another satellite of Jupiter—faint and distant like the two recently discovered.

This seems all the more probable when it is seen that, during the month for which it has been observed (on eight nights between January 27 and February 28) it was moving relative to Jupiter in about the same direction as the previously known sixth satellite (which at the time of writing must be apparently pretty close to it in the sky), but at only about one-third the rate. It looks therefore as if the new body was really a satellite, perhaps more distant from its primary than the sixth and seventh (whose periods are about 250 days) and of correspondingly longer period. It will, however, be some time before the intricate calculations which will inform us of the nature of the orbit can be completed.

THE HEAVENS.

This is the time of all the year when we can see the greatest number of bright stars in the evening. Beginning in the west, we see Orion with two stars of the first magnitude, the white Rigel below his belt and the red Betelgeux above. North of him is Taurus, with the ruddy Aldebaran, beyond which is the cluster of the Pleiades.

Venus and Mars are both close to the Pleiades, and to one another at the beginning of the month. The latter is not as bright as Aldebaran, but the former is exceedingly brilliant, and far surpasses anything else in sight. South of Orion is Canis Major, whose principal luminary, the great dog star Sirius, surpasses all the other stars in splendor, though by no means as bright as Jupiter and still more inferior to Venus. Above these constellations, and on the opposite side of the Milky Way, we see Canis Minor, with the other dog star, Procyon, Gemini with its twins Castor and Pollux, and Auriga, whose brightest star Capella very much resembles our sun in color and spectrum, though probably exceeding it a hundred-fold in actual brightness. Not far from Castor and Pollux is the planet Jupiter, second only to Venus in brightness.

The eastern skies are not so abundantly adorned, but we may none the less pick out Regulus in Leo, high up and due south of the zenith; Spica in Virgo, well down in the southeast; and the much brighter red star Arcturus, due east.

Within a few minutes after the hour for which our map is drawn, one more bright star, Vega, will rise in the northeast, and we will then have twelve stars of the first magnitude in sight at once, as well as the two brightest planets—an unusual display.

The remaining constellations can easily be made out from our map, the principal ones being Hydra in the south, with the inconspicuous Crater and the brighter Corvus upon its back, and the circumpolar group in the north; Ursa Major is almost overhead, Draco and Ursa Minor on the right of the pole, and Cepheus below it, with Cassiopeia on the left and Perseus farther on in the northwest.

THE PLANETS.

Mercury is morning star all through April, but is not very favorably placed, having passed elongation on March 27, and being moreover far south of the sun. He may, however, be pretty well seen during the first week of the month, when he rises at about 5 A. M.,

but toward its end he is lost in the dawn and becomes invisible.

Venus is evening star, very bright, very far north, and as conspicuous as she possibly can be. She moves through Taurus to Gemini during the month, and increases in brightness about fifty per cent as she approaches us. Owing to her high northern declination, she remains in sight for a long time, and does not set till nearly 10 o'clock.

It is perfectly easy to see her in broad daylight even at noon, when the sky is sufficiently free from haze. The only trouble is to know where to look for her. A very good opportunity will be on the afternoon of the 3d, when she will be about 7 deg. above the moon.

On this evening she is in conjunction with Mars, and the two planets, with the moon, will be well worth looking at.

Mars is likewise evening star, moving eastward through Taurus and pretty close to Venus all the month, so far as appearances go, though as a matter of fact he is fully 200 million miles from us, while Venus is only 80 million.

Jupiter is in Cancer, visible until the small hours of the morning. On the 24th he is in quadrature with the sun, and comes to the meridian at 6 P. M. Saturn, which has just passed conjunction with the sun, is

"GLUTEN" BREAD AND CRACKER FRAUDS.

BY CHARLES CHRISTADORO.

When starch must be eliminated from a sick man's diet, white bread is the first thing tabooed, and then follow potatoes and other overcharged starchy cereals. It is a serious matter for the patient to be denied bread, and so the pathway is smoothed out and the doctor prescribes "gluten" bread, because gluten is not a carbohydrate, and "gluten" bread is supposed to be free from starch.

What is gluten? Well, spend ten minutes and find out—not all about it, but something about it. Obtain a heaping tablespoonful of white flour. Add a little water to it, in a saucer, and dough it into a compact ball. Turn on the tap in the sink, and let the water drip upon your hands as you roll the ball between your palms. The ball will grow less and less, and the water will be white with starch cells held in suspension. In ten minutes, more or less, the water will run clean and clear, and you appear to have a nodule of yellow, firm, vegetable gum, which you are tempted to call "pure" gluten. Become a gum chewer for once, and keep a-chewing for a couple of hours. At the end of this time the quantity of gluten is less than when you took it from the hydrant. What has happened? You have simply mechanically crushed and broken the gummy mass, exposing the infinitesimally fine starch cells to the moisture of the mouth, and the washing out of the raw insoluble starch has continued, just an extension of the sink-washing process, with greater mechanical elaboration to expose the entangled starch cell. Now take the piece of gluten to an analytic chemist. When his report comes in, you read starch 15, or 18, or maybe 20 per cent, gluten 85, 82, or 80 per cent, and begin to appreciate for the first time what real gluten is.

Where a case is a desperate one, and starch or no starch will turn the balance of life, it is very easy to procure and analyze a sample of the flour or cracker of "gluten" the patient is to use. Such a course would save a physician many a perplexing hour, and maybe an esteemed patient now and then.

Gluten is a word to conjure with. There is for sale in London and Paris a gluten bread that is much like baked horn or glue, but it is a step toward gluten, although it may contain 20 to 25 per cent of starch.

The fact is, nothing short of an intricate installation will produce pure gluten, and that at a price which is quite prohibitive. Some of the gluten breads on the market may have a portion of their starch eliminated, while others have little claim to any use of the name.

RUBBER STATISTICS OF 1907.

The total production of rubber in 1907 amounted to about 69,000 tons, against 65,000 tons in 1906. England imported 22,964 tons, and America, 16,020 tons. The shipments of Para rubber amounted to 30,360 tons, and of Peruvian, 7,160 tons; of this quantity, Europe received 20,940 tons. The supply of plantation rubber from the East has increased to over 1,000 tons (in 1906 it was 510 tons): the area planted is about 350,000 acres, or 50 per cent more than in 1906. Brazil exported about 41,500 tons in 1907, against 38,000 tons in 1906. The total production of West African rubber amounted to 17,000 tons, about the same as in 1906. East African rubber showed an increased supply.

According to the American Machinist, the greatest single consumption of brass is for condenser tubes; a battleship alone having from 30,000 pounds to 40,000 pounds of condenser tubing in it; and owing to the corrosive effect of sea water this tubing must be continually replaced. The material used is usually either Muntz metal—60 per cent copper, 40 per cent zinc—or else a mixture of copper, 70; zinc, 29; and tin, 1.

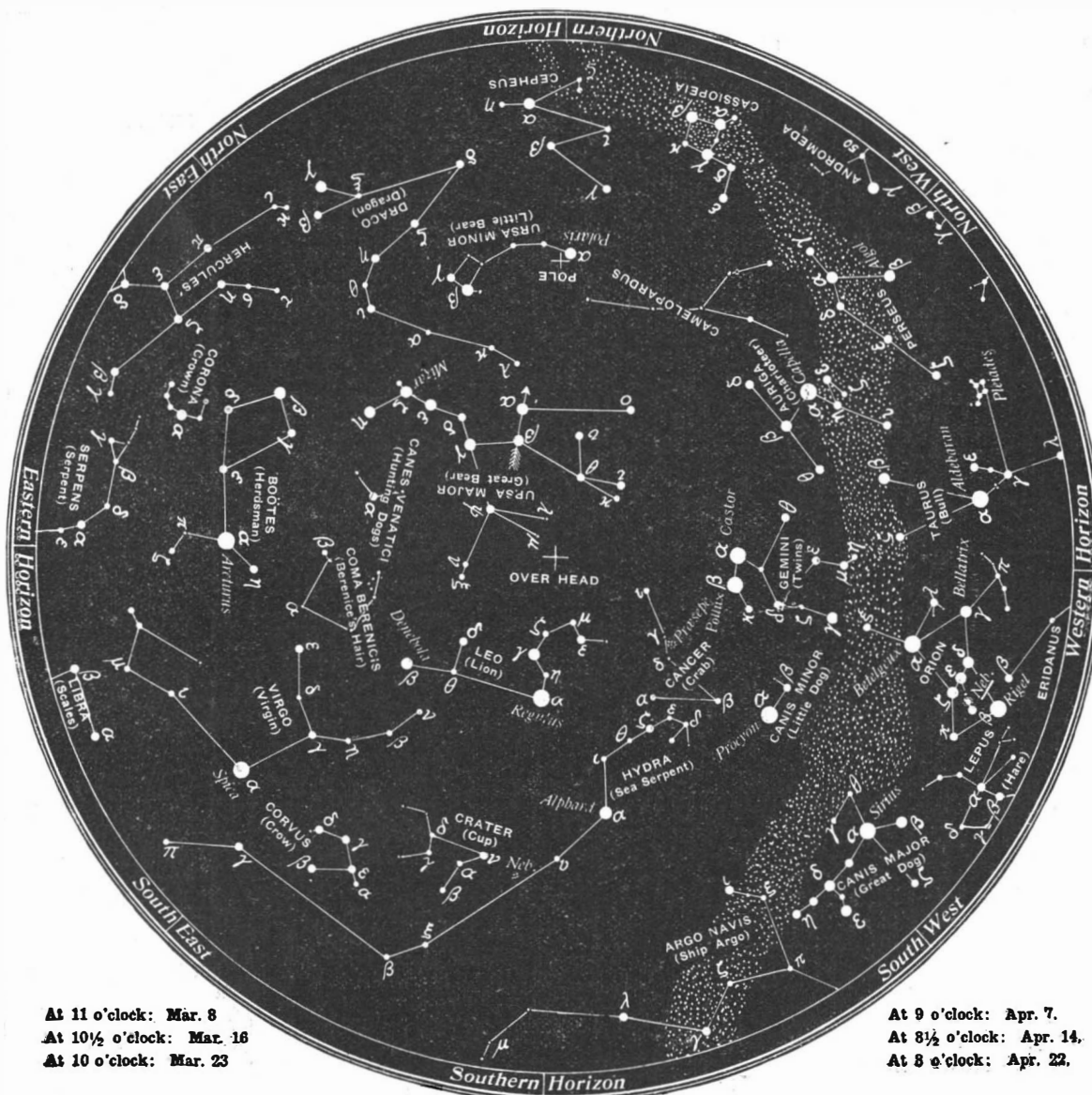

NIGHT SKY: MARCH AND APRIL

only visible at the end of the month, and then with difficulty, as a morning star. Uranus is in quadrature on the 6th, and is due south at 6 A. M. Neptune, which is almost exactly opposite him, is also in quadrature, on the 1st, and south at 6 P. M.

THE MOON.

New moon occurs a few minutes before noon on the 1st, first quarter at 11 A. M. on the 8th, full moon at noon on the 16th, last quarter at 2 P. M. on the 23d, and new moon again at 10 A. M. on the 30th. The moon is nearest us on the 25th, and farthest away on the 10th. She is in conjunction with Venus and Mars on the morning of the 4th, Neptune on the 7th, Jupiter on the 9th, Uranus on the 22d, Saturn on the 27th, and Mercury on the 29th. The conjunction with Jupiter, which takes place about 6 P. M. on the 9th, is rather close.

Princeton University Observatory.

Iron and steel pipe may be readily distinguished by a flattening test, according to statements made at the meeting of the American Society of Heating and Ventilating Engineers. Soft steel pipe, cut in very short lengths or rings, flattens smoothly and evenly without breaking, while wrought iron pipe usually fractures at two or more places when flattened.

A REINFORCED CONCRETE ELEVATED TANK.

Although not the first structure of its kind, the reinforced concrete elevated water tank recently completed in California surpasses in audacity of design all the previous efforts. Reinforced concrete posts 70 feet high support a tank built of the same material, with a capacity of 200,000 gallons. The tank has been in use for four months, and during that period no cracks have appeared, and the amount of leakage has

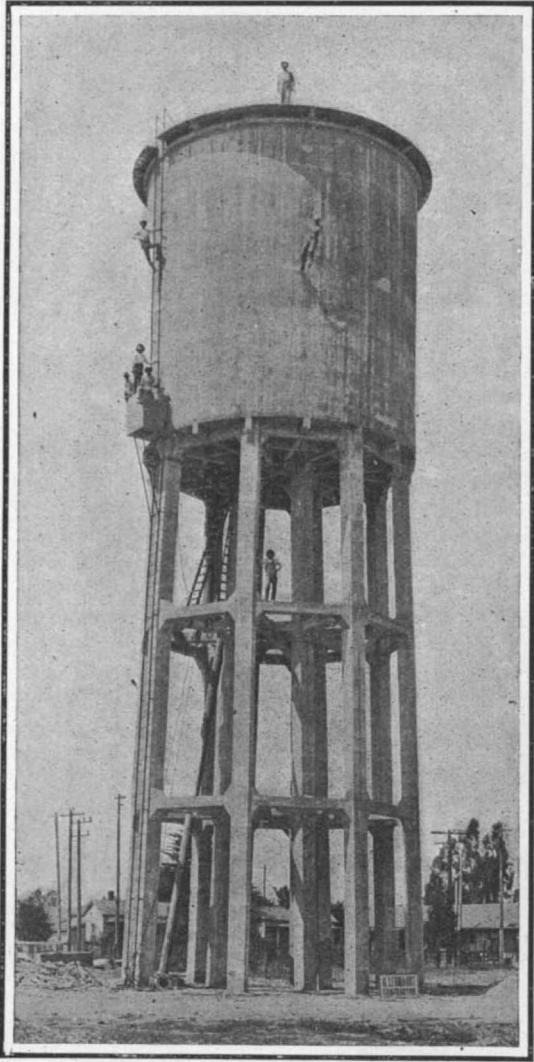

AN ELEVATED WATER TANK BUILT OF REINFORCED CONCRETE.

not been appreciable. The tank was built at Anaheim, in southern California, for the Anaheim Water Company by C. Leonardt of Los Angeles. The tank proper is 38 feet high, with a diameter of 32 feet. The material for the entire tank was concrete, reinforced with rings and vertical members of twisted steel. The thickness of the wall tapers from 5 inches at the bottom to 3 inches at the top. The contents of the tank are protected by a conical-shaped concrete roof 2 inches in thickness, the cornice over the edge is slightly raised to aerate the water within. Reinforced concrete beams support the floor of the tank, which rests on twelve concrete posts, each 16 inches square. These posts are stiffened by two sets of horizontal struts placed at equal intervals above the base. A reinforced concrete foundation extending 4 feet into the ground anchors the structure. The total height, from the base of the foundation to the top of the roof, is 112 feet. The cost of construction was about twenty-five per cent less than the lowest bid for a steel structure of the same dimensions.

Farman's Latest Aeroplane Flight.

After removing from his aeroplane the air-cooled Renault motor, with which he made some short flights on the 14th instant, Mr. Farman refitted an Antoinette water-cooled motor and made, on the 20th, two circular flights estimated at 2.3 kilometers (1.42 miles) and 3 kilometers (1.86 miles) in 2 minutes 50 seconds and 2 minutes 55 seconds respectively. In both these flights the aeroplane made a number of turns without difficulty, and flew at an average speed of over 30 miles an hour.

On March 16 M. Delagrangé also made a flight of about half a mile in a circle. The machine he used was a duplicate of Farman's aeroplane.

For years, says the Iron and Coal Trades Review, the steel industry has confidently expected to see a fulfillment of the prediction made long ago that "the open-hearth process will go to the funeral of the Bessemer." Recent developments indicate rather clearly that the function will be a wedding instead of a funeral, a vastly more happy occurrence. The duplex process is rapidly gaining favor, and the details are being worked out in different ways by different metallurgists. It is more a matter of appliances and manipulation than processes, as the metallurgical work is laid out very clearly,

NEW PROCESS FOR MAKING SHOES.

BY THE PARIS CORRESPONDENT OF THE SCIENTIFIC AMERICAN.

An interesting process has been brought out in France relating to the manufacture of shoes. The idea is to take a shoe which has been already worn and which, therefore, conforms to the shape of the foot, and make an exact reproduction of the same. Plaster is poured into the shoe to make a cast. The cast is used in a copying lathe to produce a wooden form or last of exactly the same shape. On this last the shoe is made and we thus have a new shoe of the same form as the old one, and the person is at once at ease and does not have to undergo the somewhat disagreeable operation of "breaking in" his foot-wear. This is a decided improvement over the usual method of making shoes to measure, as it is much more exact than could be obtained by the few measurements which are generally employed.

It is necessary to make the last of wood with a copying lathe, because the plaster cast is not solid enough to be used for this purpose. In order to strengthen the plaster cast and allow it to be fitted in the lathe there is placed in the shoe an iron core around which the plaster flows. The cast is then ready to be placed in the lathe. The form of copying lathe which is employed is already well known in practice, it being used for different purposes, and it enables a given model to be reproduced exactly by means of a double lathe, one side of which carries the model and a roller bearing thereon, and the other a wood block and a set of cutting knives which work the latter to the right shape. Such a lathe is shown in the engraving, with the plaster cast on the left hand side and the wood block on the right. The lathe has been somewhat modified in the present case in order to adapt it to this particular use. On each side the model and the wood block are made to rotate at the rate of one revolution in three seconds. Opposite the plaster cast is a movable carriage, and there is a second carriage in like manner placed opposite the wood block. These two carriages are solidly connected together. On the frame lying next the plaster cast is mounted a roller with a round rim. The roller is 12 inches in diameter and is pressed against the plaster cast by the weight of the frame. The latter thus takes a series of movements corresponding to the rotation of the plaster cast. The right-hand frame lying opposite the wood form has mounted on it a wheel carrying six knives for working the wood. The knives which do the rough work at the surface parts of the wood take a smaller circumference as they revolve, and are graduated up to the sixth knife, which takes the same circumference as the loose wheel on the other side, and is used to carry out the finishing of the wood piece. While the plaster cast and the wood block are made to revolve at the slow speed mentioned above, the wheel which carries the cutting knives revolves at a high speed, this being ordinarily 1,500 revolutions per minute. Hence the knives make 9,000 strokes per minute upon the wood. As the roller rises and falls in following the contour of the plaster cast, it causes the frame and the knives to follow the same movements. The frame is also gradually shifted from right to left so as to cover all the parts of the cast and the wooden block. The result is that we have a finished piece of wood which has the same form as the plaster cast, and it can now be employed as a last to make the shoe in the usual manner.

This method is somewhat of a novelty, and is at

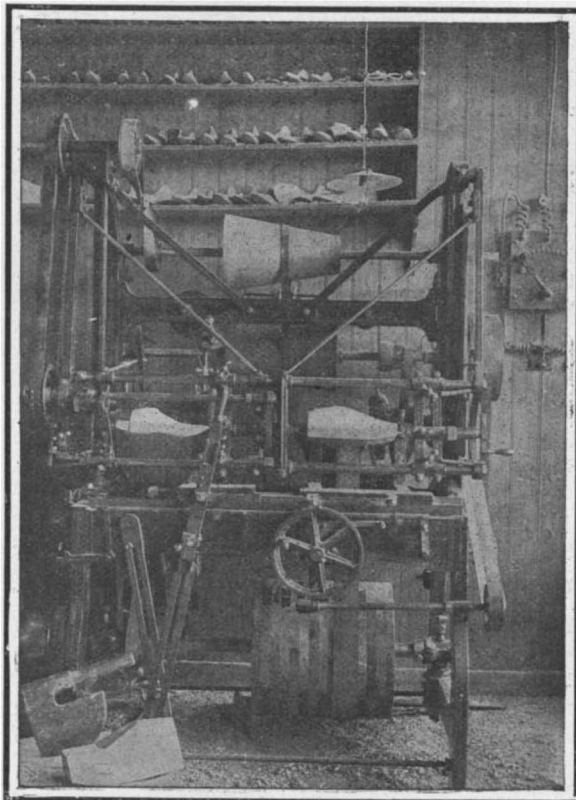

MAKING A LAST FROM THE CAST OF AN OLD SHOE.

least a very practical improvement, and one which will be appreciated by those who have sensitive feet. The new shoe instead of being very uncomfortable, as is often the case, gives at once the same sensation of ease we find in wearing an old shoe. Furthermore, there are no creases or cracks in the leather, as these are quite done away with by the new process

AN AUTOMATIC MILK SUPPLY.

BY OUR ENGLISH CORRESPONDENT.

Many efforts have been made toward rendering it practicable to supply milk direct from the cow to the consumer without intermediate handling, to insure



A PENNY-IN-THE SLOT MILK SUPPLY MACHINE.

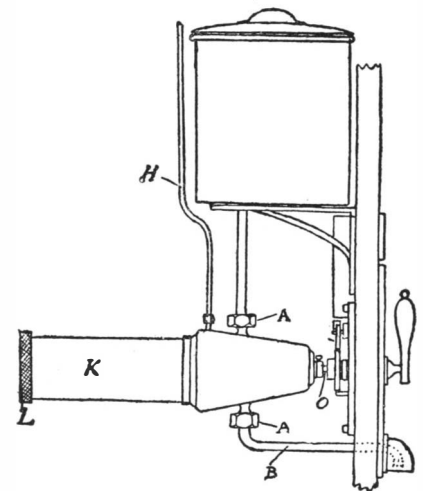

DETAILS OF THE MILK SUPPLY MACHINE.

freedom from contamination, and yet at the same time conform with hygienic requirements. An effort to secure this end is being made in England, whereby the customer secures his quantity of milk from the retail dairy without its being ladled from the supply churn or pan. A novel automatic supply machine is used, which can be fixed in any convenient position. On the outside of the machine there is merely a curved spout, under which the jug or pitcher is placed, a lever handle which is pulled over at right angles, and a slot for the insertion of the coin, which in this particular instance is one penny (two cents), and which insures the delivery of half a pint of the liquid.

The machine itself comprises a circular tank with a capacity of twenty quarts. From this the milk falls into a receptacle, the discharge orifice of which is closed by a valve controlled by the handle lever outside. The handle is actuated by the automatic mechanism set in motion by the insertion of the coin. It will thus be seen that the machine is of very simple construction and operation, being designed to withstand rough usage such as it would naturally be subject to in poor districts. The customers pay no more for their milk than if bought over the counter; and as the reservoir is completely inclosed, there is no risk of contamination from the air or other causes, even if it be left standing for a long period.

The machine can easily and quickly be taken apart for sterilization, so that it conforms with all hygienic requirements. All that is necessary is to disconnect the two unions A, shown in the diagram, release the pipe H, disconnect K from the connection O, undo the milled nut L, and the whole machine is in pieces ready for cleansing from end to end, while similarly it can be quickly reassembled.

In order to distribute the cream uniformly throughout the reservoir, an automatic stirrer is provided; otherwise the cream would collect on the surface of the milk, and the liquid withdrawn from the lower part of the reservoir would be of poor quality. At the same time the automatic stirrer is so designed and operated that there is no risk of converting the milk into butter. A refrigerator is attached in summer.

As the reservoir contains sufficient milk for eighty coins at one charge, it does not need close attention. In England the apparatus is becoming extensively adopted at dairies situated among the poorer classes of the community, who buy in small quantities.

SOME EXPERIMENTS WITH CARBON DISULPHIDE.

BY GUSTAVE MICHAUD, COSTA RICA STATE COLLEGE.

Carbon disulphide vapor is nearly twice as heavy as carbon dioxide gas. Some experiments, still more curious than those which are usually made to manifest the density of carbon dioxide, can be performed with carbon disulphide.

To obtain carbon disulphide vapor there is no need of heating the liquid. It boils at 117 deg. F., but emits a considerable amount of vapor at temperatures far lower than 117 deg. To ascertain this fact, place in a dish a handful of cotton. Pour some carbon disulphide over it, and with bellows blow steadily over the whole. After a minute or two it will be found that the carbon disulphide has gone, and that a thick external layer of snow has taken its place. Condensation and congelation of atmospheric humidity were the result of the quick vaporization of the liquid.

The following experiment made with carbon disulphide always succeeds, although the writer has tried in vain to perform it with carbon dioxide. It offers no difficulty whatever, even when the thermometer stands as low as 66 deg. F., and it can probably be made at a lower temperature, although it is of course better to select a summer day, or, in winter, a heated room. Take a long and narrow strip of stiff paper. Fold it longitudinally so as to form a V-shaped trough. Support the trough on an incline, with the upper end resting on a book and the lower end in the mouth of an empty glass. In the bottom of a second glass press some cotton, and over this pour some disulphide. Have a third empty glass at hand. Everything is now ready for the experiment.

Go through the motions of pouring into the third glass the carbon disulphide contained in glass number two. Capillarity will keep the liquid in the cotton, and nothing will seem to flow out. Now take glass number three, which apparently contains nothing; handle it as if it contained something, and pour slowly its invisible contents into the upper part of the paper gutter. Nothing is seen to leave the glass nor to run along the gutter nor to fill glass number one at the lower end of the gutter, but throw an ignited match

into the latter glass and a blue flame will fill it for one or two seconds.

A little apparatus, called the four liquids vial, is generally shown to students during a course in elementary physics. Mercury, a solution of potassium carbonate, alcohol, and petroleum are seen to superpose themselves in one vessel according to their relative densities, the surface of separation being in each case horizontal. This is the way in which non-misc-

careful not to allow too great a difference of level between both liquids, each will stay on its own side of the partition, even though the latter may imperfectly fit the glass. Now raise the partition. The surface of separation of the two liquids sometimes remains perfectly vertical for several minutes. More frequently, under the influence of the three factors which determine its shape, i.e., adhesion, cohesion, and a small difference in density, it bends itself and becomes more or less S shaped.

While handling carbon disulphide, one should always bear in mind that *this liquid takes fire even more readily than gasoline, and that its vapor is poisonous.* The latter inconvenience is the lesser, because the nature and intensity of the smell of the commercial product are such as to cause one to step back when the vapor reaches the nostrils.

AN OBSERVATORY FOR PUBLIC USE.

BY OUR PARIS CORRESPONDENT.

At Zürich there has recently been erected an observatory known as the Urania which is at present one of the leading features of the city. It affords a popular as well as a scientific establishment in which private researches can be carried out. Outside of the latter, the establishment is open to the public every evening in which observations can be made, and for this only a small fee is charged. The appearance of the building, with the tower and dome, will be noticed in one of our engravings, while the other views show the large telescope which has been set up here. The building is a handsome one, and the lower stories are rented for different purposes, reserving the upper part for the observatory. From the dome there is an exceptionally fine view over the town, the Lake of Zürich and the magnificent panorama of the Alps.

The telescope was constructed by the well-known optical establishment of Carl Zeiss, of Jena, after the plans of Engineer Meyer. It embodies many new features which are worthy of notice. The objective of the instrument is 300 millimeters (11.8 inches) in diameter and the focal length is 5.4 meters (17.7 feet). It has a total weight of 14 tons, and the revolving part weighs 4½ tons. The latter is very well balanced so as to move with but little effort. Electricity is used

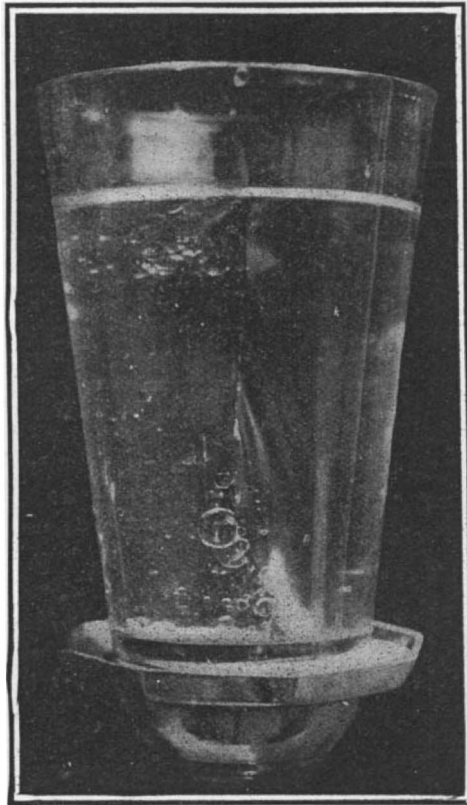

Carbon Disulphide and Glycerin Side by Side.

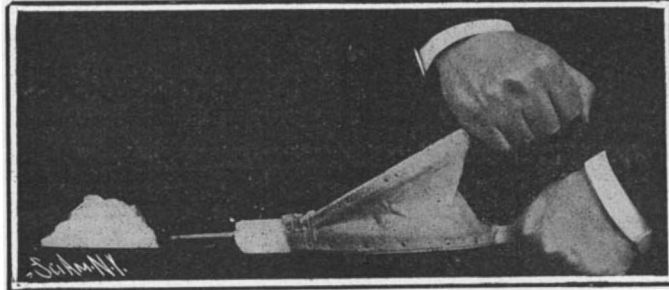

Making Frost With Carbon Disulphide.

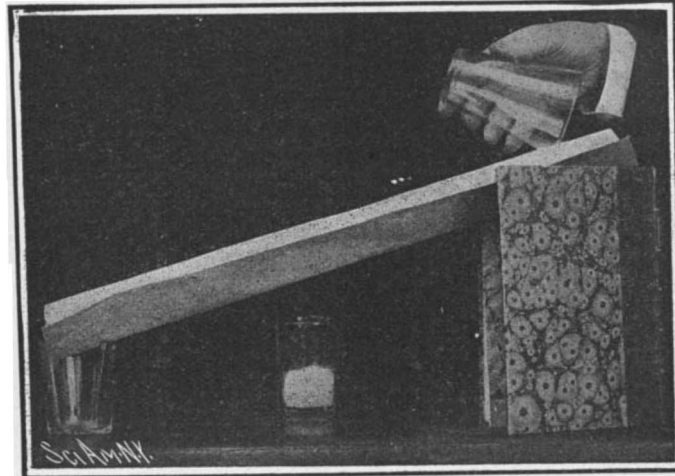

Pouring Invisible Vapor of Carbon Disulphide Down a Trough and Into a Glass.

SOME EXPERIMENTS WITH CARBON DISULPHIDE.

ble liquids generally arrange themselves when thrown together in one vessel. Carbon disulphide permits of a somewhat different arrangement, which appears very odd because the conditions of its realization are so unusual. It happens that carbon disulphide and glycerin cannot be mixed, and have exactly the same density (1.26) up to the second decimal, the third decimal being variously influenced by the purity and temperature of both chemicals. If the two liquids be placed with some care side by side in one vessel, the adhesion of glycerin for glass will keep them in that queer position.

Take an ordinary glass, and divide its capacity into two halves by means of a roughly-cut pasteboard partition laid vertically in the glass. Pour at the same time glycerin on one side of the partition and carbon disulphide on the other. If, while so doing, you are



View of the Telescope, Showing Peculiar System of Mounting.



Urania Observatory at Zürich Where the General Public May Gaze at Stars.

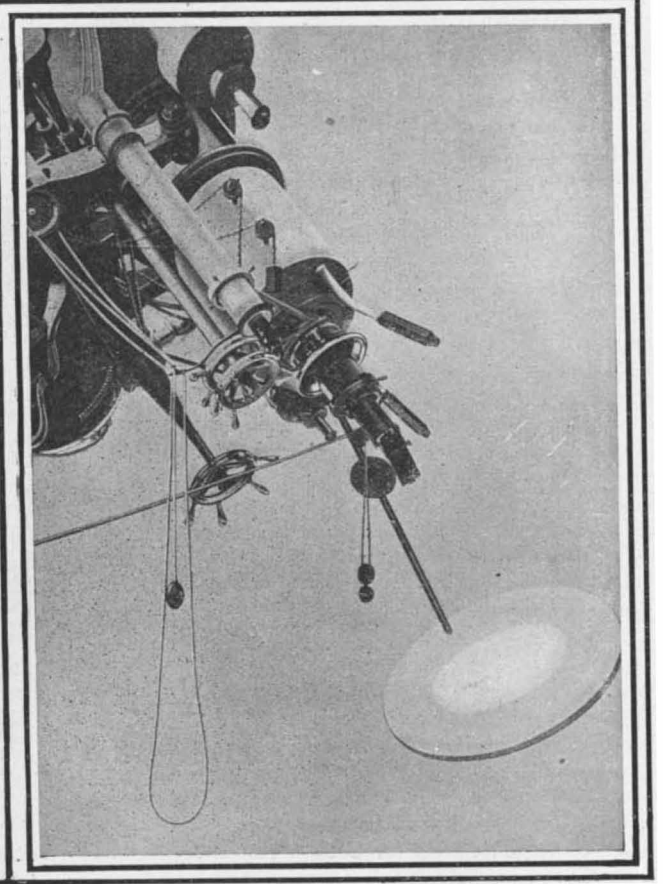

Eyepiece End of the Instrument. Projection of the Sun's Disk on the Screen.

AN OBSERVATORY FOR PUBLIC USE

for operating the clockwork of the telescope and the revolving of the main dome. It will be noted that the arrangement which is employed for moving the telescope is devised upon quite a new principle, and is not merely an improvement upon existing methods. This will be noticed in the principal view of the telescope, where it will be seen that the method of suspension of the tube is different from what we usually see. For all the large telescopes it is the general practice to swing the tube about its middle point. This causes the eyepiece to swing through an inconveniently long arc when the tube is moved to different angles, which is necessarily a disadvantage. The present instrument, on the contrary, is supported so as to turn upon an axis close to the eyepiece, and in this way the tube can be made to cover a large angular distance without moving the eyepiece to any great extent. The tube is balanced by means of a counterweight.

Following the usual practice, the tube rotates about an axis which is permanently set parallel to the earth's axis, and as the Urania Observatory is situated at latitude 47 deg. 23 min., the main axis is mounted at this angle. The shaft upon which the main tube is pivoted is about 2 meters (6.6 feet) in length and 15 centimeters (5.9 inches) in diameter. It supports the whole weight of the revolving part, which is 4,000 kilogrammes (4.5 tons). The tube makes one complete revolution in twenty-four hours, and in order to give the greatest possible precision to this movement an electrically controlled mechanism is employed which is quite ingenious. The main clockwork, which is run according to sidereal time and is provided with a seconds pendulum, is made to close an electric contact at each second. The current impulses operate an electromagnetic device for correcting the working of the regulator in a continuous manner. In this way the instrument can have no greater error than the clock movement, or in general a difference of one-tenth second per day, which makes an angular error of only 1.5 seconds of arc, this being in consequence very low and well within practical limits.

The optical work was carried out under the direction of Dr. Pauly, the chief of the astronomical department of the Zeiss establishment. Fitted to the main tube, near the eyepiece, is an exploring tube, which has an objective of 60 millimeters (2.4 inches) diameter and gives a magnifying power of twenty-five. It has an improved device which enables the objects to be easily brought into the field of the main telescope. There are nine eyepieces for the main tube, which provide a magnifying power ranging from 40 to 1,000. Among other features of the instrument are to be noted a spectroscope of the most recent design, a solar prism with an absorption arrangement according to Herschel, a zenith prism, etc., also a well-designed projection system for throwing the images of the sun and moon upon a screen. This new device, which will be seen mounted below the eyepiece, gives a projection of the moon's disk 600 millimeters (24 inches) diameter. One of our illustrations shows a projection of the sun's disk upon the screen, in which a group of sun spots can be observed. The graduated circle of the instrument is provided with verniers so as to read to 1/2 minute in declination and 5 seconds in time.

The clockwork which drives the telescope has several new features. One of these lies in the use of a compensating device for keeping the weight of the clockwork at a constant level. A small electric motor operates continually to lift the weight by the amount through which it falls, so that there will be no variations due to an increase of length in the chain supporting the weight. The clockwork is located in the story which lies under the dome, and in order to avoid vibration it is well fixed to the pillars of the building. The seconds pendulum is made of nickel steel. A compensating pendulum weight is employed, which consists of a glass cylinder holding 13 pounds of mercury.

The dome of the observatory, which measures 9.5 meters (31.3 feet) in diameter, is rotated upon sixteen differential rollers and is driven in either direction by an electric motor. The dome is constructed of pitch pine and covered with sheet copper, and it has a total weight of 13 tons. A system of electric contacts which are placed near the eyepiece of the telescope control the motion of the dome in either direction. Aside from its astronomical service, the telescope is used for observing the splendid views of the Alps which can be seen from this point. In order to carry this out to the best advantage, Dr. König, of Jena, has designed a new device by which the images are not only thrown upon a screen, but are reversed and can thus be seen in the upright position. The observation of the mountains under these conditions is thus very agreeable, and the different details are well brought out.

The observatory is also equipped with a time ball to indicate the exact noon for Central Europe.

James Oliver, inventor of the chilled plow, proprietor of the largest plow plant in the world, recently died in South Bend, Ind. He left a fortune of many millions, most of it made in plows.

CURIOS FACTS ABOUT NUMBERS.

That the ancient world was impressed by numbers themselves, apart from the things to which they might be applied, admits of no doubt. Thus the great and wonderfully influential system of philosophy due to Pythagoras looked upon numbers as in some mysterious way connected with the constitution of things. In the sacred Scriptures numbers often have a symbolic sense, as almost anyone would conclude upon a slight examination of Revelations.

Among all the numbers, none other seems to have attained the celebrity of 7. There are seven days in the week, seven years of plenty, seven years of famine, seven wise men of Greece, seven wonders of the world, seven Mohammedan heavens, seven notes in the musical scale, seven colors in the solar spectrum, etc. The visible moving bodies of the heavens are seven—sun, moon, Mercury, Venus, Mars, Jupiter, and Saturn. The Great Bear consists of seven principal stars; the

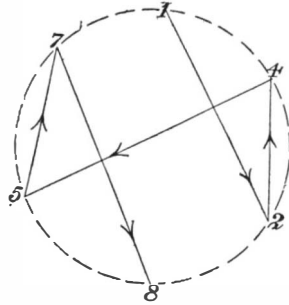

The Multiplying Circle.

Pleiades were seven sisters, the seventh having concealed herself, which accounts for but six stars being visible.

Now there is quite a wonderful array which may be derived from the number 7. Upon attempting to convert the fraction 1/7 into a decimal, we shall find it impossible to complete the operation. We obtain however a recurring series of numbers, thus

$$1/7 = .142857142857142857+$$

This is a circulating decimal. Suppose, now, we write the series of figures thus obtained

$$142857.$$

Multiplying by 1 we, of course, reproduce the number, but multiplying by 2, we obtain 285714. This product is composed of precisely the same figures. And not only that, but the figures are arranged in the same order. Multiplying by 3, we get 428571; again the same figures and the same order. Multiplying successively by 4, 5, and 6, we get 571428, 714285, and 857142, possessing the same properties. These results may be made more striking perhaps by arranging the figures in a circle. Each product may be obtained from this circle by using successively as initial figures the numbers 1, 2, 4, 5, 7, 8, (as indicated in the figure by the chords of the circle) and then taking all the numbers in a complete circuit, clockwise.

This is, however, not the only number which manifests properties of this kind. Consider the series of figures

$$052631578947368421.$$

We have here no less than eighteen digits. By multiplying successively by the natural numbers 1 to 18, inclusive, we shall obtain the following eighteen results:

0	5	2	6	3	1	5	7	8	9	4	7	3	6	8	4	2	1
1	0	5	2	6	3	1	5	7	8	9	4	7	3	6	8	4	2
1	5	7	8	9	4	7	3	6	8	4	2	1	0	5	2	6	3
2	1	0	5	2	6	3	1	5	7	8	9	4	7	3	6	8	4
2	6	3	1	5	7	8	9	4	7	3	6	8	4	2	1	0	5
3	1	5	7	8	9	4	7	3	6	8	4	2	1	0	5	2	6
3	6	8	4	2	1	0	5	2	6	3	1	5	7	8	9	4	7
4	2	1	0	5	2	6	3	1	5	7	8	9	4	7	3	6	8
4	7	3	6	8	4	2	1	0	5	2	6	3	1	5	7	8	9
5	2	6	3	1	5	7	8	9	4	7	3	6	8	4	2	1	0
5	7	8	9	4	7	3	6	8	4	2	1	0	5	2	6	3	1
6	3	1	5	7	8	9	4	7	3	6	8	4	2	1	0	5	2
6	8	4	2	1	0	5	2	6	3	1	5	7	8	9	4	7	3
7	3	6	8	4	2	1	0	5	2	6	3	1	5	7	8	9	4
7	8	9	4	7	3	6	8	4	2	1	0	5	2	6	3	1	5
8	4	2	1	0	5	2	6	3	1	5	7	8	9	4	7	3	6
8	9	4	7	3	6	8	4	2	1	0	5	2	6	3	1	5	7
9	4	7	3	6	8	4	2	1	0	5	2	6	3	1	5	7	8

A Great Magic Square.

Every column sums up 81; so does every cross-line and each of the two diagonals.

Every one of these lines consists of precisely the same digits, arranged in the same order, the only difference being as to the point of beginning. This constitutes, as here arranged, what has been called a magic square. That is to say it is a series of numbers (in this case the series is many times repeated) arranged in the form of a square such that the eighteen lines, the eigh-

teen columns, and the two diagonals will each produce the same result when the figures composing it are added together. In this case the sum is 81.

Numbers and their properties have afforded a fascination for many bright minds. Thus this journal in its issue for February 1, 1908, referred to the theorem of Fermat, for the demonstration of which a prize of \$25,000 has been offered. This theorem, no doubt, grew out of failures of Fermat to find whole numbers such that the sum of their cubes would produce a perfect cube, etc., which probably had been suggested by the fact that it is possible to find numbers such that the sum of their squares will yield a perfect square. Thus, we have

$$3^2 + 4^2 = 5^2$$

$$5^2 + 12^2 = 13^2$$

$$8^2 + 15^2 = 17^2$$

$$7^2 + 24^2 = 25^2$$

A group of numbers possessing this property may become useful in a practical way. Thus with the numbers 3, 4, 5 forming the first group we may construct a right angle without the aid of compasses. To make this clear, reference is made to the geometrical principle that the sum of the squares on the legs of a right-angled triangle is equal to the square of the hypotenuse. Or, rather, to a companion theorem that if we have three squares such that one is equivalent to the sum of the others, then we may form a right triangle by using a side from each square. Applying this, we learn that if we construct a triangle with the sides equal to 3, 4 and 5, we shall have a right triangle, since $3^2 + 4^2 = 5^2$. If we are building a house and have two beams which we wish to place at right angles, we may accomplish the result without a carpenter's square by measuring off 3 feet to B on one from the point of juncture A, and 4 feet on the other from A to C, and then adjusting the angle BAC until the distance AB is equal to five feet. Any of the other sets of numbers will answer the purpose—as, for instance, 8, 15, 17. It may be observed that any multiples of the numbers forming such a set will yield new groups possessing the same property. Thus

$$(2 \times 3)^2 + (2 \times 4)^2 = (2 \times 5)^2$$

$$(7 \times 5)^2 + (7 \times 12)^2 = (7 \times 13)^2$$

No one is known to have succeeded in finding two integral numbers such that the sum of their cubes would produce the cube of a whole number. The cubes of the first ten numbers give the following series, 1-8-27-64-125-216-343-512-729-1000. This series may be prolonged indefinitely. The problem would then be to find two members of the series such that their sum is just equal to another member. Adding 125 and 216 we get 341, which is certainly pretty close to 343. Again, adding 216 and 512, we obtain 728, which is within a single unit of 729, another member of the series. Another example of being very close, but not exact, is that $729 + 1,000$ gives 1,729, which is but a single unit more than 1,728, the cube of 12. It will thus be seen that the first twelve cubes yield two cases where the approximation is but a unit out of the way. As the possible cubes are infinite in number, it may seem worth while to prosecute the search.

Those who have found pleasure thus far may be interested to know that any cube may be expressed as the difference between two squares. Thus

$$2^3 = 3^2 - 1^2$$

$$5^3 = 15^2 - 10^2$$

We may obtain a formula for this by the following procedure. We write

$$x^3 = (x^2) (x)$$

Now

$$x^2 = \frac{x^2 + x}{2} + \frac{x^2 - x}{2}$$

And

$$x = \frac{x^2 + x}{2} - \frac{x^2 - x}{2}$$

We are entitled to write, therefore,

$$x^3 = \left[\frac{x^2 + x}{2} + \frac{x^2 - x}{2} \right] \left[\frac{x^2 + x}{2} - \frac{x^2 - x}{2} \right]$$

But this yields

$$x^3 = \left(\frac{x^2 + x}{2} \right)^2 - \left(\frac{x^2 - x}{2} \right)^2$$

This formula expresses any cube as the difference between two squares. It remains to see only whether the numbers to be squared are whole numbers or not. To show this we pursue the following course of reasoning. x is either even or odd. If it is even, then x^2 is also even. That is, $x^2 + x$ is even and $x^2 - x$ is even. In the case then where x itself is even, the numerators of our fractions are even, and therefore divisible by the denominator, 2. If, on the other hand, x is odd, then x^2 is also odd (factor 2 not being present). Consequently $x^2 + x$ is even (sum of two odd numbers) and $x^2 - x$ is even (difference between two odd numbers). So, as before when x was even, we have the result that our fractions are in reality not fractions but whole

numbers. Let us use this formula in a single case. Suppose we wish to express the cube of 129 as the difference between two squares. We have

$$\frac{129^2 + 129}{2} \text{ and } \frac{129^2 - 129}{2}$$

Consequently,

$$129^3 = 16770^2 - 16512^2$$

Very many are familiar with the numerical principle that in the case of any number which is divisible by 9 the sum of the digits of that number is also divisible by 9; and conversely, that any number the sum of whose digits is divisible by 9 is itself so divisible. There is a like theorem for the number 3. These are quite well-known results. But possibly not many of the readers of this article are aware that a somewhat similar thing is true for the number 11. The rule as to it may be expressed thus: Add the alternate digits and subtract the sum of the remaining digits. If the remainder is 0 or is divisible by 11, then the original number is divisible by 11. But if the remainder is neither 0 nor divisible by 11, then the number itself is not divisible by 11. As an example, take the number 75229. The alternate digits, 7, 2, 9, give for their sum 18. The remaining digits, 5 and 2, give 7. As $18 - 7 = 11$, the number itself is divisible by 11. On the other hand, the number 857964 is not divisible by 11, since $(8 + 7 + 6) - (5 + 9 + 4) = 3$.

What may seem a surprising result is that if we take the series of odd numbers beginning with unity and add together, say the first 12 of these odd numbers, we shall obtain exactly 12^2 . This is true for any series, however short, or however prolonged—the sum of the first n odd numbers is equal to n^2 .

What is perhaps a still more remarkable result is that if we add together the cubes of a series of natural numbers beginning with unity we shall obtain the same amount as if we had added together the natural numbers themselves and then squared the sum. Thus for the first 5 natural numbers, we have for the sum of the cubes,

$$1^3 + 2^3 + 3^3 + 4^3 + 5^3 = 1 + 8 + 27 + 64 + 125 = 225$$

But this is equal to $(1 + 2 + 3 + 4 + 5)^2$.

JOINING OF LAST SPAN OF BLACKWELL'S ISLAND BRIDGE.

On the afternoon of March 18 the last gap in the Blackwell's Island cantilever bridge across the East River, New York, was closed with appropriate ceremonies in the presence of the acting Mayor of the city and other municipal officials, and the principal officers of the Pennsylvania Steel Company which built the bridge. The cantilever span connecting Blackwell's Island with Manhattan had been closed a few days before; and the recent ceremony marked the closing of the cantilever between Blackwell's Island and the Borough of Queens, Long Island. The connection was made by means of the big 600-ton traveler, which picked up the last section of the bottom chord, weighing $29\frac{1}{2}$ tons, and swung it into place. After it had been bolted up, the acting Mayor of the city walked to the center, and proclaimed the closure of the span completed.

The Blackwell's Island Bridge, which crosses the East River at 59th Street, has been built to form a connecting link in the street and railway systems of Greater New York, and therefore it will be free from terminals, such as those at the ends of the Brooklyn Bridge. In the intervening years since the latter bridge was opened, we have come to understand that terminal stations are not only unnecessary, but are a positive incumbrance, causing great congestion and limiting the capacity of a bridge by preventing the unhindered flow of traffic. The Blackwell's Island Bridge, therefore, will be connected at its ends directly with the thoroughfares upon which it abuts; with the surface cars; with the elevated trains; and ultimately with the subway. The capacity of the bridge will be far greater than that of the Brooklyn Bridge, and it will provide for two more railway tracks than the Williamsburg Bridge.

The structure is made up of steel and masonry approaches leading to a huge cantilever bridge proper, which consists of five spans of varying length. The Manhattan approach, built of masonry and steel, is 1,051 feet in length. About 550 feet inshore from the East River is located the anchor-arm pier of the first cantilever. The shore arm of this cantilever is 470 feet in length; the center span over the westerly channel of the East River is 1,182 feet in length; then follows the island span, which measures 632 feet between the towers. Beyond this is the cantilever span over the easterly channel of the East River, which measures 984 feet between towers. Then comes the shore arm of the easterly cantilever, which is 459 feet in length, and beyond this is the Long Island approach, 2,630 feet in length, which is built of steel bents and plate girders.

The cantilever structure proper thus consists of four cantilevers resting upon four towers. The first extends from the Manhattan anchorage tower to the center of the big westerly span, and has a total length of 1,061 feet. The next cantilever extends from the cen-

ter of the westerly span to the center of the island span, and measures 907 feet in length. The third cantilever reaches from the center of the island span to the center of the easterly span, a distance of 808 feet; the fourth cantilever extends from the center of the easterly channel to the anchor pier on Long Island, a distance of 951 feet. The total length of the cantilever structure is 3,727 feet; and the whole bridge, from the commencement of the approach on Manhattan Island to the end of the approach on Long Island, is 7,408 feet.

The people of New York have become so accustomed to the suspension system of construction in their large bridges, that the cantilever form, as used in the Blackwell's Island Bridge, possesses a strong interest of novelty; also the great massiveness of the bridge, and the size and weight of its individual members, give to the structure an impressiveness and dignity, a sense of strength and permanence, which is wanting in the suspension bridges farther down the river. It is considerably the heaviest structure of the kind ever erected, being far heavier than the two East River suspension bridges; heavier than the Forth Bridge in Scotland; and indeed, considerably heavier than the great Quebec Bridge of 1,800 feet span, which collapsed into the St. Lawrence River in the autumn of last year. The massiveness of the individual members is due largely to the great live or moving load which the bridge is designed to carry. The traffic will be accommodated upon two floors. On the lower floor, between the trusses, which are spaced 60 feet apart from center to center, there will be a roadway 56 feet wide, on which will be provision for two trolley tracks, one on each side against the trusses, and a central driveway devoted to vehicles, 36 feet in width. Outside of the trusses will be two more trolley tracks, carried upon cantilever extensions of the floor beams. The upper floor is constructed to carry two elevated tracks, which are to be laid at once, and two additional elevated tracks to be laid when the future demands call for them. These four tracks will be placed between the trusses, and on the outside of the trusses will be two 13-foot sidewalks for pedestrians laid upon cantilever extensions of the floor beams. The maximum possible moving load upon the bridge is estimated at 16,000 pounds to the lineal foot.

The bridge was designed under the former Bridge Commissioner Gustave Lindenthal, who introduced for the first time, in this bridge, the use of nickel steel for the tension members of large bridges. The bridge has been built partly of the ordinary commercial structural steel, and partly of nickel steel made to a special specification. Structural steel is used for the compression members and floor system, and nickel steel for the eyebars. In spite of many predictions of failure, the manufacturers have succeeded in producing nickel-steel eyebars of the great size required, that were perfectly satisfactory. The specifications called for structural steel with an elastic limit of 28,000 pounds to the square inch, and an ultimate strength of 56,000 pounds; and the nickel-steel eyebars were required to show an elastic limit of 48,000 pounds, and an ultimate strength of 85,000 pounds to the square inch. From these figures it will be seen that the bars in this bridge are from 40 to 50 per cent stronger than bars of the same weight built of the ordinary structural steel.

In a bridge of this size and carrying capacity, the weight of the superstructure becomes so great as to necessitate a large amount of preliminary work for facilitating erection. This is evident, when we state that the cantilever portion of the bridge alone weighs 52,000 tons. One single span, that of 632 feet across the island, weighs alone 10,400 tons, which is equivalent to $16\frac{1}{2}$ tons to the lineal foot. This was the first portion of the cantilevers to be erected, and it was therefore necessary to carry the load, during the erection, upon falsework. The ordinary timber work would have had to be designed in such massiveness, and there would have been such difficulty in providing suitable bearing surfaces for the steel work at the panel points, that the engineers decided to discard timber altogether, and design a special steel falsework, consisting of latticed towers and plate girders erected upon especially-prepared foundations. The steel work in this temporary structure weighed some 1,700 tons. We believe this was the first time that steel was employed in work of this character, at least on such an extensive scale. After the span across the island had been completed, the arms of the cantilevers were built out from each end over the adjoining channels until half of each channel span had been completed. The anchor arms of the shore cantilevers were similarly erected upon steel falsework, and the channel arms then built out by overhang until they met the already-completed cantilevers projecting from the island. It should be noted that neither the east nor west channel cantilever spans include the customary suspended span at the center, the arms of the cantilever being continuous until they meet at the center, where they are joined by a rocker bent, which serves the double purpose of permitting horizontal movement of the

cantilevers, due to temperature changes, and of transferring stresses, due to uneven loading from one arm to the other.

The erecting of the cantilevers by overhang was done by means of two huge travelers, each 120 feet in height and weighing about 600 tons. Each traveler was built of riveted trusswork, and was in the form of a huge letter Z, the upper arm of the Z projecting forward beyond the finished cantilever, and the lower arm projecting inwardly on the finished portion of the cantilever, to which it is securely bolted. Heavy trolleys, traveling upon the upper arm and carrying the upper blocks of the hoisting tackles, served to transfer the members out to the desired position for pinning or riveting in place. The bridge material, as it came from the shops, was assembled in storage yards at each end of the bridge. Here it was hoisted onto cars running on the complete structure, which carried it out to the desired position on the bridge.

The heaviest tower post weighs 126,000 pounds, and has a section of 1,396 square inches. The heaviest bottom chord section measures $4 \times 6 \times 59$ feet, has 1,120 square inches of cross-section, and weighs 240,000 pounds. The heaviest Quebec Bridge chord section had less than 800 square inches of section. The heaviest top chord, 48 feet long, is composed of 20 nickel-steel eyebars $16 \times 2\frac{1}{8}$ inches, equal to 680 square inches cross section.

We are indebted to Mr. F. C. Kunz, Chief Engineer of the Pennsylvania Steel Company, and Mr. C. M. Ingersoll, Chief Engineer of the Department of Bridges, New York, for assistance in the preparation of the present article.

The Soap-Nut Tree Seeds.

At the beginning of the year 1905 the Hon. Mr. Kider, then United States consul at Algiers (Algeria), published a report on the soap tree industry. He described the tree as follows: "The Algerian soap tree originated from China, and has been propagated by seeds imported from that country. The name is given as *Sapindus utilis*. The tree is ornamental, and reaches a height of fifty feet. It begins to bear fruit when six years old. The wood is close grained, takes a good polish, and is admirably suitable for furniture. The average crop of a full-grown tree is about 200 pounds of fruit. The average income from a tree is from \$10 to \$20 per year. The composition of the fruit consists in a nut-shaped hull in which is a seed. In the hull exists the saponaceous matter (saponine) in the proportion of 30 to 40 per cent of the bulk of the hull. This saponaceous principle is set free by the shredding of the hull and using it with water just as if it were a piece of soap. A beautiful lather is the result, and the cleansing qualities are such that there is no soap made by human process that can compare with them. For toilet purposes the same applies. No human skill can produce or approach that marvelous product of nature. The hull can also be made into a powder, and the powder into a cake, so as to make the use of it easier. It can also be made into a liquid for hair wash, dentifrice, and various other preparations, and these various articles can be made by such simple process or processes, that in every household the commodity will become a source of economy, of recreation, and of pleasure.

"The seed has a kernel which contains a fixed oil in every respect preferable to the best imported olive oil, either for eatable or culinary purposes, and also for all kinds of industrial products in which the olive oil is used. The yield in oil of that kernel is twice the yield of the olive fruit; and when the production reaches an importance necessitating the use of the proper machinery, the oil will be produced as cheaply, if not more cheaply, than cottonseed oil. For a 'solid shortening' the delicious flavor of that oil will surpass anything ever produced.

"As a meal for poultry and other animals' feed, the expressed product is excellent. The leaves of the soap-nut tree supply a fodder of unequalled value.

"Medical authorities assert that the soap-nut may be used internally in cases of salivation, epilepsy, and as an expectorant. The seeds, pounded with water, are said to arrest a paroxysm of epilepsy. This fruit is also recommended by native practitioners for the cure of chlorosis."

The foregoing relates to the Algerian soap tree, the seed of which E. Moulie, a Southern perfumer, imported in 1905 and 1906 for free distribution, but it applies equally well to the Florida soap tree. The discovery of a full-grown soap tree in Florida, owned by Mr. J. H. Livingston, of Ocala, Fla., was due to Mr. Moulie's publication of the report of the American consul referred to. The tree also came originally from China, some seeds having been imported twenty-two years ago by the Rev. Benjamin Helm, who was a missionary in that country. Although these two species bear the same name, they are different varieties. The United States Department of Agriculture identified the American variety as *Sapindus mukorossi*, and it is the seeds of this variety that Mr. Moulie is now gratuitously distributing to those who care to apply to him.

HOW TO CONSTRUCT A BALLOON.—THE MAKING, INFLATING AND SAILING OF GAS BALLOONS.

BY B. COURTRIGHT, AERONAUT; MEMBER AERO SOCIETY OF GREAT BRITAIN.

This article is, as its caption indicates, a practical treatise on the construction, inflation, and sailing of balloons, and it has been prepared for those whose knowledge of aeronautics and balloon making is limited, and with the main object of elucidating, in plain

rarefied that the weight becomes equal, and here it will float.

But it is not necessary to confine ourselves to heated air for raising balloons. There are many gases which weigh less than air. Hydrogen is the lightest of all, with pure coal gas next in order. Pure hydrogen weighs but 0.005 pound per cubic foot, and coal gas about twice as much; so if a cubic foot of hydrogen weighs 0.005 pound and a cubic foot of air weighs

greater, but this may be done without making the machine eight times heavier than before, in fact we increase the surface only four times, and therefore save fifty per cent in its construction.

The table herewith gives the diameters, surfaces, capacities, and ascensive power in feet of balloons inflated with hydrogen or coal gas.

The next consideration is the material of which balloons are made. Silk is the lightest and strongest,



A London Factory. Examining the Gas Bag Before Shipment.

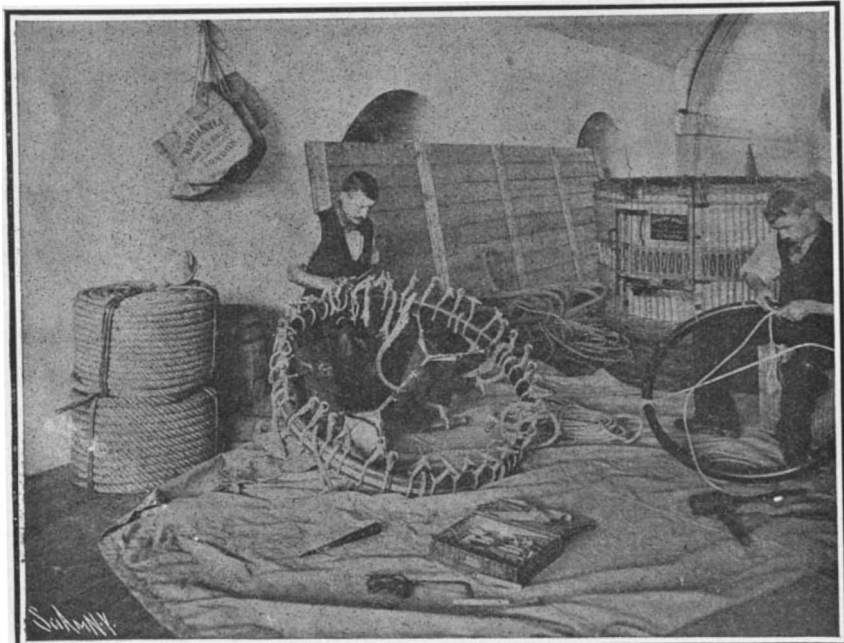

Roping the Concentrating Hoops.

English, the elementary principles of aeronautics, which to many have been enveloped in a haze of mystery. During the past few years many novices have entered the field of aeronautics; and with the founding of societies and aero clubs, the present seems a most opportune time for such an article to make its appearance. Compared with other sciences, aeronautics has been retarded by a lack of information on the subject. Since the discovery of the balloon in 1783, a number of books on aeronautics have appeared, but none, to the writer's knowledge, giving full and complete instructions on the construction and operation of practical aeronautical machinery, excepting, possibly, John Wise's book (which is very old), and Moedebeck's "Pocket-Book of Aeronautics," which book is more for the use of the experienced aeronaut than for the amateur.

It is a well-known fact that when a body is immersed in any fluid, if its weight be less than an equal bulk of the fluid, it will rise to the surface; but if heavier, it will sink; and if equal, it will remain in the place where it is left. For this reason smoke ascends in the atmosphere, and heated air in that which is colder. Upon this simple principle depends the whole theory of the balloon.

By heating a quantity of air to about 500 deg. F., we double its bulk when the thermometer stands at 54 deg. in the open air, and in the same proportion we diminish its weight; and if such a quantity of this heated air be inclosed in a bag, and an equal bulk of common air weighs more than the bag with the air contained in it, both the air and the bag will rise in the atmosphere, and continue to do so, until they arrive at a place where the external air is naturally so

0.075 pound, a cubic foot of hydrogen will lift 0.07 pound, and 1,000 cubic feet will lift 70 pounds; 1,000 cubic feet of coal gas, about 35 pounds.

It is necessary that balloons should be made to weigh as little as possible. On this account the form becomes an object of some consideration. A spherical form has been mathematically demonstrated to be the

Diameters.	Surfaces.	Capacities.	Ascensive Powers.	
			Hydrogen.	Coal Gas.
24	1810	7238	452	253
25	1963	8181	511	286
26	2124	9203	575	322
27	2290	10306	644	360
28	2463	11494	718	402
29	2642	12770	798	447
30	2827	14137	884	495
31	3019	15598	975	540
32	3217	17157	1072	600
33	3421	18817	1176	653
34	3630	20580	1286	720
35	3848	22449	1403	789
36	4070	24430	1527	854
37	4301	26522	1658	923
38	4536	28731	1796	1000
39	4778	31060	1942	1087
40	5026	33510	2094	1175
45	6362	47713	2982	1560
48	7280	58000	3975	2080
50	7854	65450	4691	2390
55	9508	87114	6445	3049
60	11310	113098	9069	3955
65	13273	143794	12687	5043
70	15394	179595	17225	6286

best, having a greater capacity under a smaller surface than any other, and this holds good whether the balloon be large or small. The cubical contents of a sphere, or any other form of which balloons and airships are made, increase much faster than their surfaces. Suppose we increase the capacity of a balloon eight times; the tendency to rise will be eight times

but cotton has largely taken its place for reasons of economy and for the fact that its surface is less easily charged with static electricity. A cotton balloon, say from 36 to 40 feet diameter, with its car, net, etc., would weigh about 400 pounds, while a silk one of the same size would weigh about one-half as much. Although other kinds of silk will do, pongee is the best. It is very strong and light and takes varnish well. However, the writer has always preferred to use fine half-bleached muslin or cambric. It is cheap and is sold in any lengths, and varies from one to three yards in width. Other material than silk or muslin is unfit for ordinary gas balloons.

Before any of the material is cut to form the gores it must be varnished three or four times with a special varnish invented by John Wise, the great American aeronaut, made in the following way: Take an iron or copper kettle of 15 or 16 gallons capacity, and half fill it with pure linseed oil. The boiled oil that one buys from paint dealers is not fit for the purpose. Place the oil over a fire, and let it heat slowly to a degree at which it will char a piece of wood when immersed in it. At this point it will foam and emit vapor, and if not well secured from the air will burst into flame. This can be prevented by placing a tight cover with a small airhole in it on the kettle. This will keep the air from it, and the boiling can be kept up for an hour or more without any danger of its catching fire. When sufficiently done it will be very thick and stringy and of a dark red. Upon cooling it will get almost as hard as rubber, but it must be thinned with turpentine as soon as it has cooled enough to stand it. When cooled it is very elastic, more so than India rubber. It improves by keeping, and if

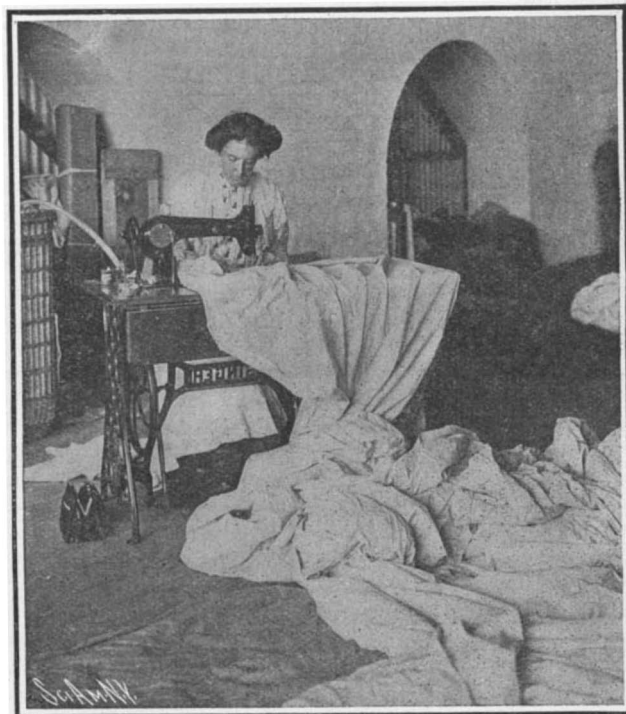

Sewing Together Segments of Cloth Into Balloon Cases.

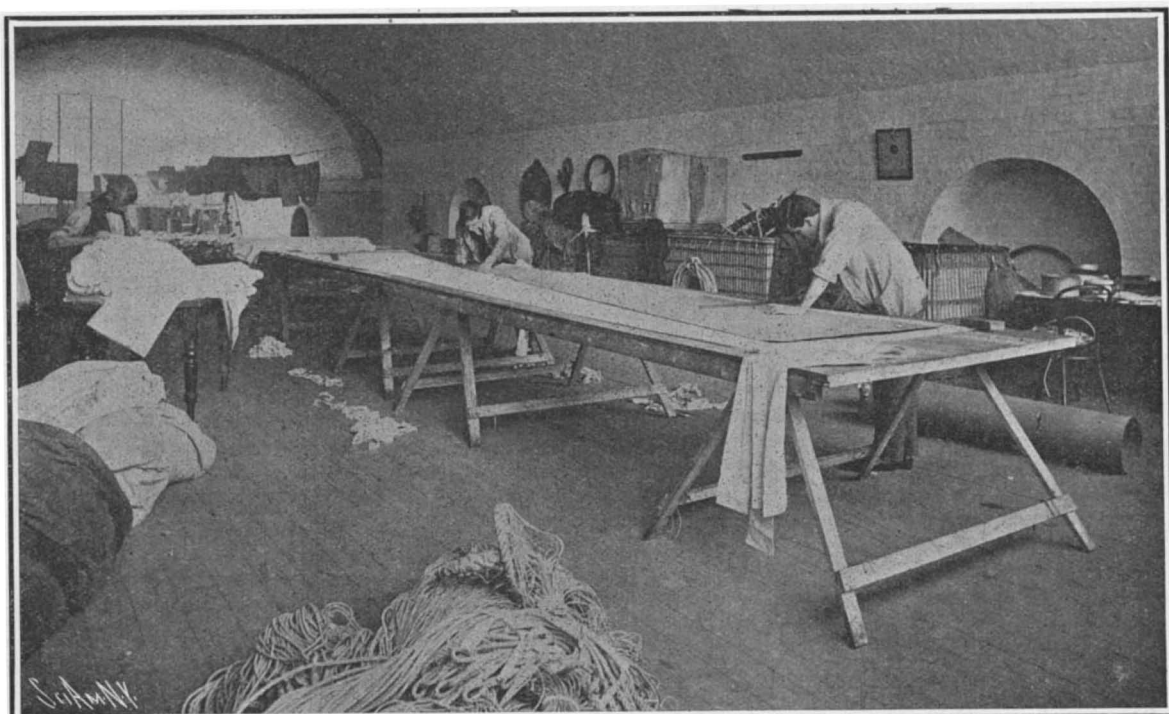

In an English Balloon Factory. Cutting the Cloth Into Properly Shaped Segments.
HOW TO CONSTRUCT A BALLOON.

placed in a glass vessel so that the light can get to it, it will settle, separate the pure part from the black carbonaceous matter. It will dry in the sun in five or six hours, and requires no driers. It will take about 25 or 30 gallons of it diluted with turpentine to varnish

applied in three or four coats makes a far tighter envelope than if applied in one or two, for the pores left in the first coat are not all covered by the second, and the pores in the second are not all covered by the third, and so on. Having varnished the material, it must be

seventeen cross lines as in Fig. 3. At each cross line in both figures there is affixed a natural sine. Now, whatever the width (EF or MN) of the half gore may be, it must be multiplied by each one of these natural sines, which will give the length of the line of each

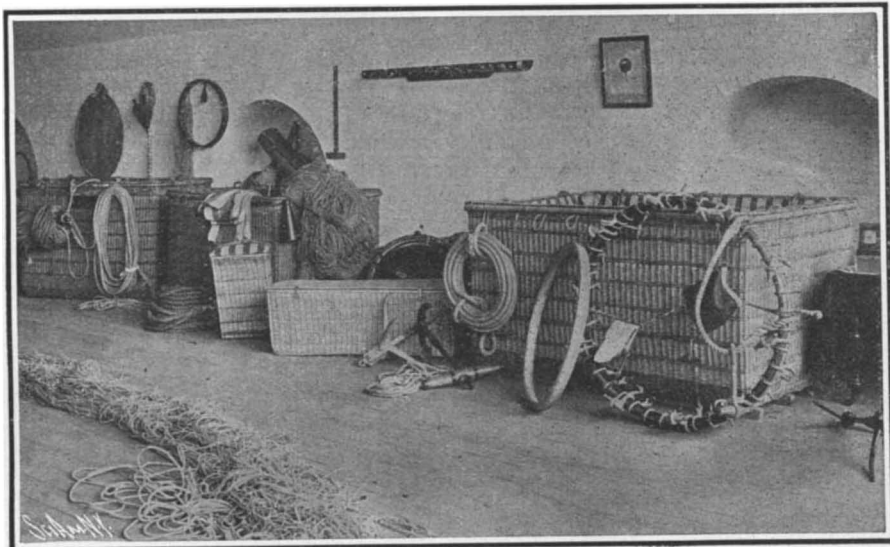

Cars and Accessories in an English Factory.

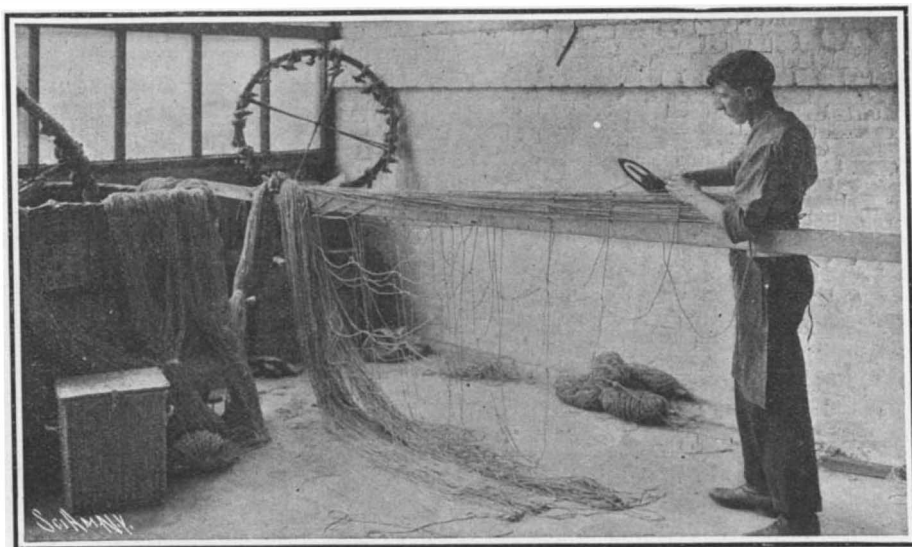

Knitting the Net Which Covers the Balloon.

a balloon of 30 feet diameter, according to the number of coats applied.

The writer made a small cotton balloon in August, 1904, coated with this varnish. It was used but three times and then stored away in a large box, where it has remained for over three years without showing the slightest symptoms of spontaneous combustion and very little adhesiveness. In Europe many aeronauts still use the old preparation (Arnoul's)—mixing litharge, umber, or birdlime, etc., with the linseed oil, which causes stickiness at high temperatures, demands constant inspection when in storage, and is liable to spontaneous combustion.

Of late years balloon cloth has been varnished by machinery. The machine is very simple, and can be made by the aeronaut himself. Fig. 1 shows one form of a machine. The cloth unwinds from a roller, and is drawn through the varnish in the tub under another roller. It then passes over and under a series of blades or scrapers which remove the surplus varnish. After passing the scrapers it winds on a third roller, and is then unwound and hung up to dry. When dry it is run through the machine again. This is done three or four times, and it will be seen that the cloth, after the first coat, receives two coats at a time, one on each side. Therefore, if the cloth is run through three times it receives five very thin coats. This saves much labor, makes a very light and gas-tight bag, and is far superior to a hand-varnished balloon. To varnish the material by hand, it is hung up by one edge or stretched on a frame and the varnish is applied with a brush. The coatings should be put on very thin and should be well brushed or spread, so as to close the pores of the cloth. It is well to keep in mind that the cloth holds the varnish and the varnish holds the gas, therefore great care should be taken in its application. If applied in thick and uneven layers it gets porous, and does not produce a very impervious or light-weight envelope. The same amount of varnish

cut out into properly shaped segments or gores to form the bag. This is done in the following manner: The piece intended for a pattern gore is divided into four equal parts by having a line drawn through its middle in length and one across the middle in width.

division where the curve is to cut it. For example, line OP is equal to 0.86603 times EF , and line AB is equal to 0.81915 times MN . But a much quicker and better method to find the points where the curve is to cut the cross lines is as follows: Take a piece of wood, like a common ruler, which in length is equal to EF or MN . Divide this into ten equal parts and each part into tenths, which will make tenths and hundredths. Now the length of the first line above EF will be well over ninety-nine hundredths; the next line will be still over ninety-nine hundredths. The last line will be five-hundredths and a little over. The same rule applies to Fig. 3. After finding the point on the lines, draw the curve. By folding the pattern you can easily cut the other quarters of the gore into the same shape. A certain number of these gores (according to the diameter of the balloon) sewed together will make a sphere. Most aeronauts, especially the French, prefer the shape shown in Fig. 4. The neck, or tail as it is sometimes called, which is large enough for a person to pass in and out, as it is sometimes necessary to go inside the balloon, is made apart from the balloon and afterward sewed on.

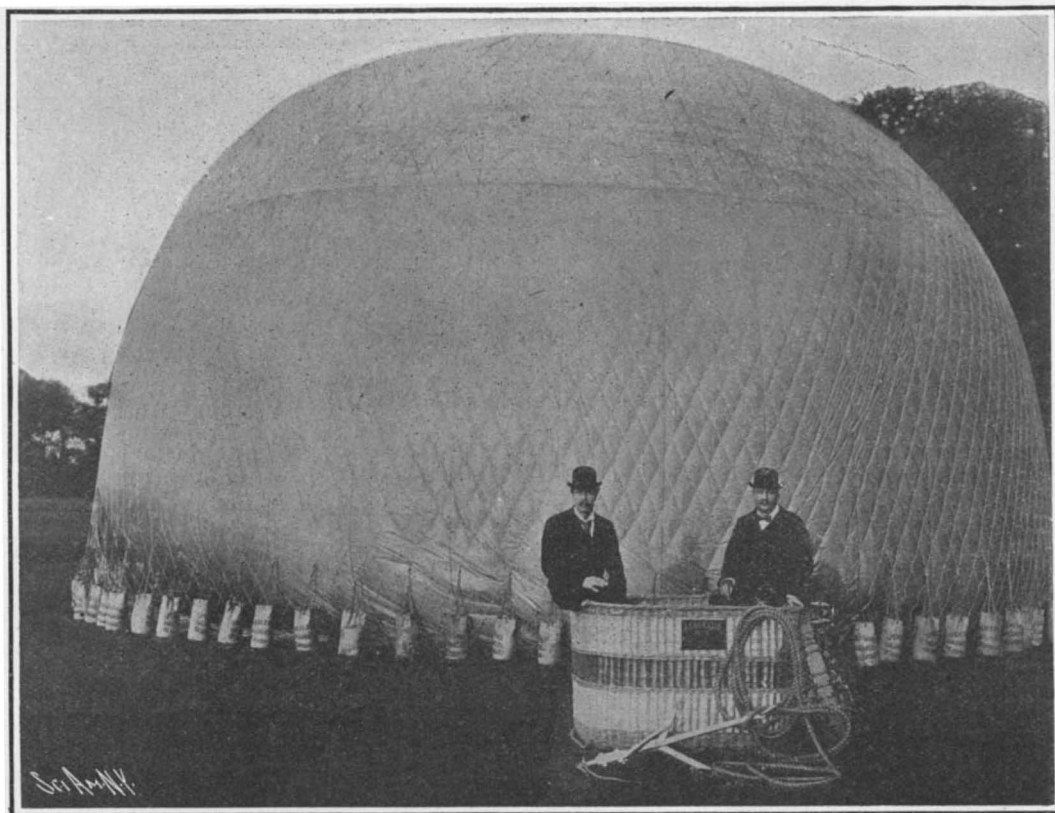

Inflating a Balloon, Showing the Anchor and the Arrangement of Ballast Bags.

Take any one of these quarters, and divide it into thirty equal parts as shown in Fig. 2. This makes twenty-nine cross lines to the quarter. If the balloon is to be a small one (say less than 29 feet diameter) divide the quarter into eighteen equal parts, making

the machine. Hand sewing will do, but the machine does the work better and quicker. The edges should overlap each other at least an inch and be sewed with a double stitch, and care must be taken not to pucker the seams. After the seams are sewed they must be varnished on both sides to stop up the needle holes. The easiest way to varnish the seams is to sew the gores into sections. Suppose there are forty-two gores; sew the gores into three sections, making fourteen gores to the section. Varnish the seams and sew the sections together, and then varnish the three seams thus made. The cloth should be double for about six square yards at the top of the bag where the valve is to be and where the strain will be the greatest.



Ascent of a Military Balloon.

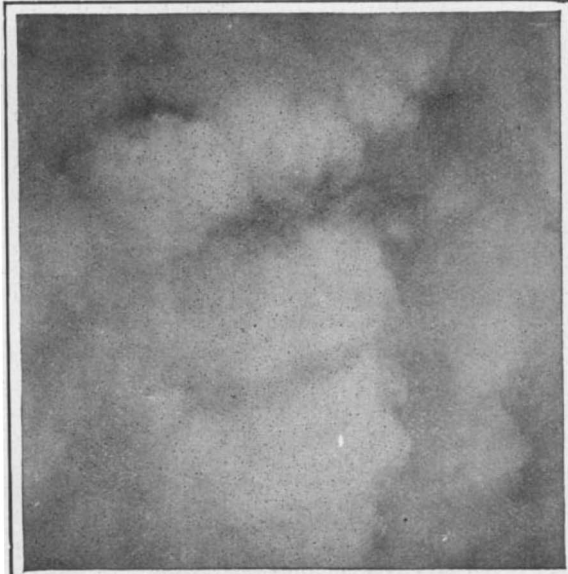

Looking Down at a Bed of Clouds from the Car of a Balloon.

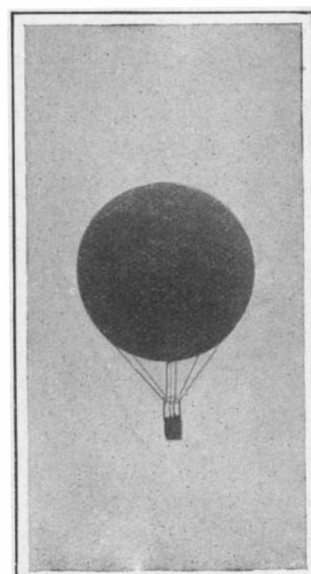

Ascent of a Military Balloon.

The size of the valve is governed by the size of the balloon. A balloon of a diameter less than 30 feet should have a valve with an opening of about 8 inches in diameter. Large balloons, say from 30 to 60 feet diameter, should have a valve twice this size. Some very large balloons have two or three, but one is all that is necessary in an ordinary balloon. There are many forms of balloon valves: clapper valves, rubber valves, tube valves, and plate valves. The simplest and one of the most efficient valves is shown in Fig. 5. It can be made in any size suitable for the balloon to be used. In order to have an 8-inch opening, two smoothly-planed wooden plates, 2 feet in diameter and about $\frac{1}{4}$ inch in thickness, are used. On their inside surfaces is glued a layer of chamois skin, or other suitable leather, which should project an inch over the edge of each plate to protect the cloth of the balloon. When the plates are made and the leather glued on, they are screwed together to hold them in place while the 8-inch hole is cut through the center. This hole may be round or square to suit the aeronaut. The opening is closed by a wooden clapper attached to the inside plate by light brass hinges. This clapper should have its surface next to the plate covered with leather. The clapper can be held shut by either of the two methods shown in the illustration. A brass ring is attached to the clapper, from which the valve cord proceeds down through the neck into the car. When the valve is completed, the plate with the clapper attached is placed inside the gas bag at its top and the other on the outside; they are then screwed together, the cloth being clasped between the two. The cloth in the opening is then cut out, making a free communication for the gas to escape when the clapper is drawn open. After the valve is placed in the balloon there should be two cleats sewed on the inside plate to keep the wood from warping. There should also be a strong cord of the right length fastened to the clapper and then to the plate, to prevent the clapper from opening farther than necessary when the aeronaut pulls the valve line.

Where the neck joins the main gas bag there should be placed a neck or tail valve. This valve may be made on the same principle as the main or maneuvering valve at the top of the balloon, only it should open outward under a slight pressure. This valve will avert the outflow of gas due to the wind pressure against the balloon's sides during inflation, and should the balloon meet with sudden gusts of wind when in the air. It also retards diffusion.

When the envelope is finished and the valve properly placed, it should be filled half or two-thirds full of air to test its perfection. This is usually done by a blowing machine, but ordinary blacksmiths' bellows will answer the purpose. The balloon thus filled should be left for a day or two; and if it seems insufficiently tight, the application of a very thin coat of varnish will produce a good result.

The network to cover the balloon is usually made of cotton seine twine, which is very soft and elastic and well adapted to the purpose. Its strength governs the size of the meshes of the net; the lighter the twine, the smaller the meshes should be. The net should cover at least two-thirds of the gas bag. Before beginning the construction of the net, we must first decide on the size and number of meshes around the equator of the balloon. We must then draw on paper, in the following manner, a diagram of a segment of meshes, extending from the equator to the valve rim: The width of a mesh at the equator of the balloon determines the width of the mesh segment, or gore, to be drawn and used as a guide. Suppose the width of the meshes at the equator is x inches, then the greatest width of the gore should be x inches. Taking this width as a basis, and employing the scale given in Fig. 2, we can obtain a pattern mesh gore and draw in the meshes, making them twice as long as wide, and from this we can determine the lengths of

the sides for the purpose of knitting. (See Fig. 6.) The knitting is best begun at the equator, and the first three or four rows of meshes will practically be the same size. The rest will gradually grow smaller until within about six feet of the valve, where they become so small that it is best to make them five or six times as long as wide, which alters them from a diamond shape to a much longer diagonal. The end cords of the meshes are provided with loops and strung on a rope rim, which must fit tightly around a groove in the valve pin. The net may be made to come down considerably below the equator by simply adding a few more rows of meshes to the lower portion of it. From the lower edge of the net proceed the cords to which the car is suspended. This part of the net is called the suspending net, and may be made in any shape to suit the fancy of the aeronaut. One style of suspending net is shown in Fig. 6. The suspending-net lines meet in a circle some eight or ten feet beneath the balloon, and are fastened to toggles on the concentrating hoop, which hoop is made of very tough wood.

There are different forms of cars. The square ones are usually preferred to the round. The one-inch ropes by which the car is hung from toggles fastened to the hoop, are worked in with the wickerwork of the car, going down its side, across the bottom, and up the other side.

The balloon is now ready for service; but to make

a shape which will receive a hogshead, with its under end open, into it, with space enough between it and the inside of the tube for the gas pipe to pass down between them and its recurve terminate under the inverted hogshead. The tube which carries the gas from the cooling tub is five inches in diameter. From this main tube to the balloon the gas passes through a hose made of strong muslin rendered gas-tight with balloon varnish.

The spot which has been selected for the ascension has a circle of the same circumference as that of the balloon's equator drawn upon it. The gas hose has its end at the center of this circle. The neck of the gas bag is then connected to the hose, and the balloon is spread out in regular folds circling its entire area, having the valve on top in the center. The net is then attached to the valve rim, and stretched evenly in every direction. Sand bags should be hooked to the outer edge of the net, to keep it in place while the balloon is being inflated. The gas is then turned on. The sand bags must be adjusted so as to keep the valve in the center as the balloon fills, and should be hooked in the same row of meshes all the way round the net. The balloon must not be allowed to rise faster than necessary to allow space for the inflowing gas, yet it must not be held down too tightly. There should be a man to every five sand bags, watching them closely and shifting them when necessary. When the last meshes on the lower edge of the net

are reached, the sand bags may be fixed to temporary ropes, which will allow the balloon to rise above the ground, in order to make attachments to the car, which must be overloaded with ballast. The gas hose is then disconnected, the temporary ropes removed, and the aeronaut climbs into the car, taking in his instruments, etc.

The men who have taken the place of the sand bags on the outer edge of the net walk in slowly toward the car, and when it is reached, release the net ropes. The balloon then stands erect, but the large quantity of ballast in the car will not permit it to ascend. Therefore, two or three persons take hold of the sides of the car, while the aeronaut empties out enough ballast to give the machine a good ascending power. The aeronaut then orders all to let go, and the balloon sails away. Of course, things do not proceed so smoothly under a strong wind; but the beginner should never attempt to make an ascension during a storm or in a high

wind. Serious results might happen even to the experienced aeronaut.

The anchor or grapnel is an important equipment of a balloon. Anchors are of different shapes and sizes, but in every case they should be of good steel or wrought iron and have sharp prongs. The anchor rope must be very strong, and its length governed by the size of the balloon. Every aeronaut should carry a guide or drag rope, a heavy rope 200 feet or more in length, which is allowed to hang over the edge of the car from the start. When the distance from the earth is less than the length of this guide rope, the rope begins to drag. Being thus relieved of the weight of the part of the rope which is on the ground, the balloon automatically stops in its descent, and floats along at a lower altitude.

The common instruments used in ballooning are the barometer, thermometer, and an index of rising and falling. This index is a light ribbon about a foot long fastened to the end of a stick, which projects from the side of the car. When the balloon ascends the ribbon hangs straight down, and when it descends the ribbon coils upward. A compass and map should always be carried along, to enable the aeronaut to tell the direction he is sailing and his whereabouts. By using a $\frac{1}{4}$ -inch rope from 800 to 1,000 feet in length with light ribbons tied to it, one at its lower end, another 100 feet higher up, a third another 100 feet higher, and so on, the aeronaut can tell the direction of a current he

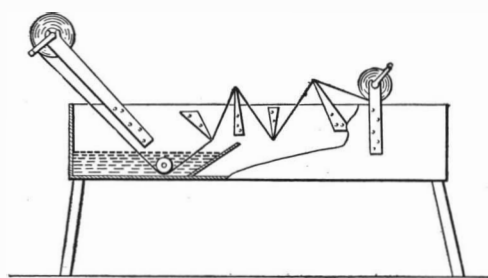

Fig. 1.—Machine for varnishing balloon cloth.

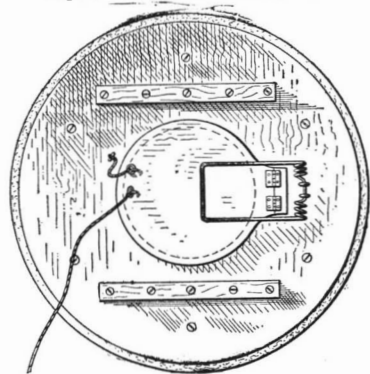

Fig. 5.—Inner side of a balloon valve.

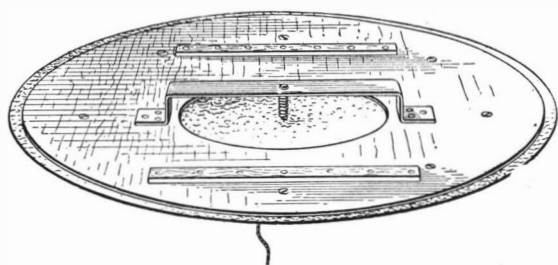

Fig. 5a.—Upper side of a balloon valve.

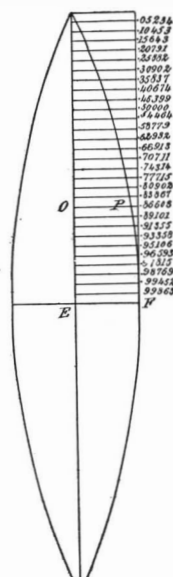

Fig. 2.

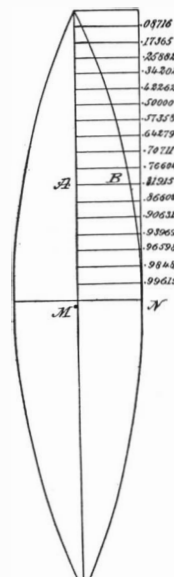

Fig. 3.

The method of shaping the segments of cloth for the balloon.

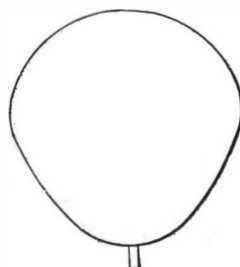

Fig. 4.—A form of balloon generally favored by aeronauts.

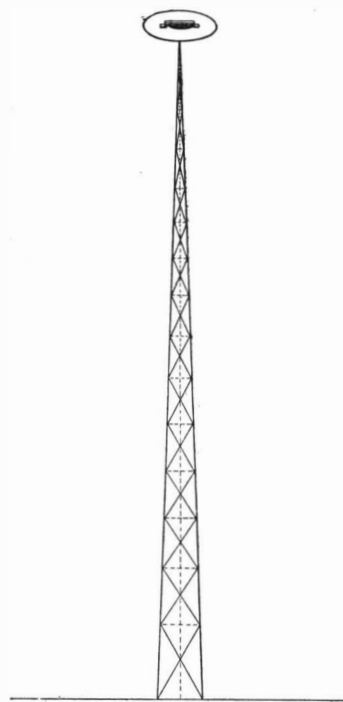

Fig. 6.—A mesh gore and pattern of suspension net.

HOW TO CONSTRUCT A BALLOON.

it ascend it must be inflated with hydrogen or coal gas. Hydrogen is the lightest gas known and therefore is best suited for balloons, but its production is very expensive. Hence coal gas, which is much cheaper, has almost entirely taken its place. Fairly good coal gas can be obtained in large quantities, and most gas companies are usually glad to supply the aeronaut with any number of cubic feet he may require.

Many kinds of hydrogen-gas generators have been invented and used by aeronauts, but the simplest and cheapest form of generator is the employment of four large wooden tanks of 270 gallons each for retorts. Each one must contain 140 gallons of pure water and 250 pounds of iron turnings or small pieces of zinc. Into each of these retorts 288 pounds of sulphuric acid must be poured at once. The four retorts together will produce 5,000 cubic feet or more; one retort, about 1,200 cubic feet. As many of the retorts may be put in operation as the aeronaut chooses. By emptying and refilling the generators, a balloon can be inflated in a few hours. The gas should be run through a head of ice water of about fifteen inches in depth contained in a cooling tub. There should also be a peck of lime dissolved in the water to absorb any impurities which might otherwise pass into the balloon. To carry the gas from the retorts to the cooling tub, three-inch tin tubes are sufficient. The cooling tub should hold at least 150 gallons of water, and be of

may be descending into some time before he reaches it, a knowledge which may be very important. In Europe there has been invented an instrument called a statoscope, which is being much used by aeronauts. It is so sensitive to changes of pressure as to indicate a rise or fall of nine or ten feet in a second, and therefore of great assistance in knowing when ballast is to be thrown out.

To make a good landing in bad weather is a difficult task, especially if the aeronaut is a novice. It requires a great deal of experience and skill, and can be learned only from practice. However, a few suggestions may be helpful. If the ballast has all been used, it will be impossible for the aeronaut to control the balloon's descent to any degree. If some woods be in the way he should not become alarmed, for the car will rebound the moment it strikes the branches of the trees, and will bounce along without any unpleasant consequences to the aeronaut, and at the first clear spot he can land. If the balloon comes down on a small lake or river, the car will sink only a few inches in the water, and if there is enough wind it will soon reach shore, the gas bag acting as a sail. The balloon may be provided with a rip cord, which with a quick jerk will rip a great slit in the envelope, emptying it almost instantly. This cord is generally fastened securely to the outside of the balloon at a point a little above the equator; from here it is run up about twelve feet, where it enters the balloon; and at this entrance it must be secured by cementing a piece of varnished silk over the opening to make it gas-tight. From this point the cord proceeds down through the neck of the balloon into the car. The valve cord and rip cord should be of different colors, so that no mistake may occur in their use.

When the aeronaut has landed and the gas is being discharged from the valve, he should not leave the car until the balloon is nearly empty. When the balloon is emptied and the net taken off, it is rolled up and put into a canvas bag, which should always be carried along. By following the above instructions, any person with ordinary ingenuity should be able to build



Experiment Suggesting the Part Played by the Neck Muscles.

a balloon and ascend with it. The cost is not as much as is generally imagined. A cotton balloon, say 40 feet in diameter, with all necessary fixtures, should not cost over \$300 to make and inflate with coal gas. Of course, a silk one would cost more. A surprising number of present-day aeronauts have no practical knowledge of balloon construction. They leave this matter to regular balloon-makers, who receive a handsome remuneration for their work, some manufacturers receiving as much as \$2,000 for a machine that did not cost them over \$800 or \$900 to make.

In the United States, a favorable country for aeronautics, the amateur who goes up in a balloon is generally looked upon as a reckless and daring person. This is because the public thinks only of the so-called dangers and perils of ballooning, and is ignorant of the great pleasures and of the irresistible attraction which holds those who have once made an ascent. Today the world's most promising and fascinating problem is the navigation of the air; and let us hope that in the near future the airship will be as common as the automobile. In the meanwhile, let us put the old round balloon to some good use; invent some means of rising and descending at will, without loss of gas or ballast, and a trip can be made to the pole or around the world.

A duplicate of the Farman prize-winning aeroplane, fitted with the regular Antoinette 50-horse-power water-cooled motor or with an air-cooled Renault or R. E. P. engine if the purchaser prefers it, can now be had in England for \$6,000, or in America for \$8,400, which includes the import duty of 40 per cent ad valorem.

THE EVER-SHIFTING EYEBALL.—SOME NEW EXPERIMENTS AND SOME NEW CONCLUSIONS.

BY J. F. SPRINGER.

There is probably no subject of research in the entire field of physiological psychology more promising than the relations of the eye to the mind. A number of American workers, as, for instance, Dodge at Wes-

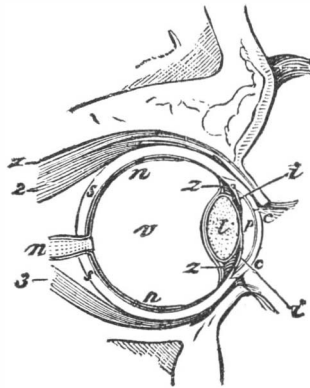

The Eye, Vertical Section.

- 1. The levator muscle of the eyelid. 2. Superior oblique muscle. 3. Inferior rectus muscle. n. Optic nerve, which spreads out internally to form the retina, n', n'. v. Vitreous humor. 2, 2. Ciliary processes. l. Lens. p. The anterior chamber. c. Cornea. i. Iris.

leyan University, Stratton at Johns Hopkins, and Judd at Yale, are investigating along this line. It is the purpose of this article to deal with certain simple, yet important, experiments in connection with visual psychology. In order to understand them clearly, however, it will be well to have certain technical matters plainly before the mind.

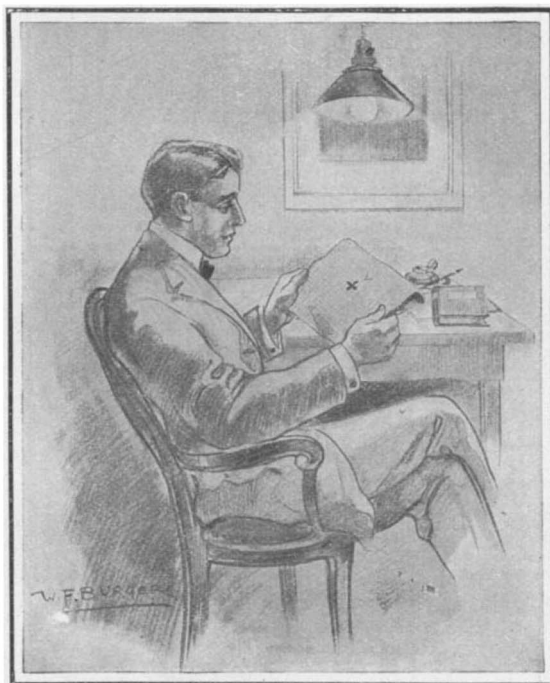

The Moving Image of the Fixation Point.

EXPERIMENTS IN VISUAL FIXATION.

The globe of the eye is the spherical body shown in the accompanying section. In reality, this globe is hollow, its interior surface to the rear being covered with an expansion of the optic nerve. This is the retina, n, which receives in its rods and cones the images of the external world. A horizontal ray of light entering from the front would meet the retina in its so-called yellow spot. This has been said to be the region of clearest vision. At its center is the depression termed the *fovea centralis*. In the center of the retina there are no, or very few, rods—cones alone appearing. The front of the globe consists of a translucent substance, c, called the cornea. There are, of course, many other details, but our space is limited.

The globe of the eye is capable of several possible rotational motions. The point within, however, which does not participate in any of these movements is the "center of rotation." The line drawn from this center of rotation to an assumed point of interest upon the object of visual attention has been called the "line of regard."

The older psychologists assumed that this "line of regard" intersected the retina in a fixed point in the fovea—the necessary movement to secure this being accomplished by the rolling of the eyeball. They also assumed that there was possible a point of regard, which could be maintained for a time. These assumptions are now challenged upon experimental grounds. It is now denied that it is necessary in fixation that a particular point of the center of the retina should be brought to the line of regard; in fact, it is denied that any part of the fovea is necessary to fixation. This is a conclusion of considerable importance, but which we cannot at this time consider. Besides, it is denied

that the center of interest is a point, the claim being that it is always an appreciable area.

Prof. Raymond Dodge maintains these results in a recent monograph. He claims that at no time is the globe of the eye quiescent in its socket. And in this he is supported by other investigators. In proof of incessant motion of the eyeball relatively to its socket, Prof. Dodge cites a very simple experiment, which requires practically no apparatus. By viewing a very bright object intently for a time, we may perceive an after-image of the object upon fixing the attention upon, say a white piece of paper. Suppose now we observe intently a wedge-shaped white-hot piece of metal. This will give rise to a definite after-image. Such an image is formed upon a certain definite portion of the retinal surface. In fact, the various portions of the glowing object have stimulated certain definite elements of the retina. Thus, the point of the wedge has set in vibration a certain limited number of the minute retinal elements. And, let it be carefully observed, these elements will remain—at least approximately—the same throughout any rotations of the globe of the eye during the persistence of the after-image. Suppose now we make some small ink mark upon a piece of cross-section paper, and fix our attention upon this mark. At the first instant of fixation of attention upon the mark, the after-image will be seen occupying a certain position relative to the fixation mark on the paper. But as we continue our effort to fixate the mark, we shall observe that the after-image is never still relatively to the fixation mark. As the location of the after-image on the retina is fixed, this apparent relative motion of the wedge point on the paper can mean nothing else than that the image of the fixation point has a movement over the retinal surface. That is to say, there is a continual movement of the globe of the eye during the fixation effort.

It has seemed desirable to measure these fixation movements of the eyeball. And, as Prof. Dodge points out, this after-image method would be excellent for this purpose, if it were not for the subjective effects of the experiment interfering with the accuracy of the measurements. These effects are two. In the first place, the subject of the experiment notices the change

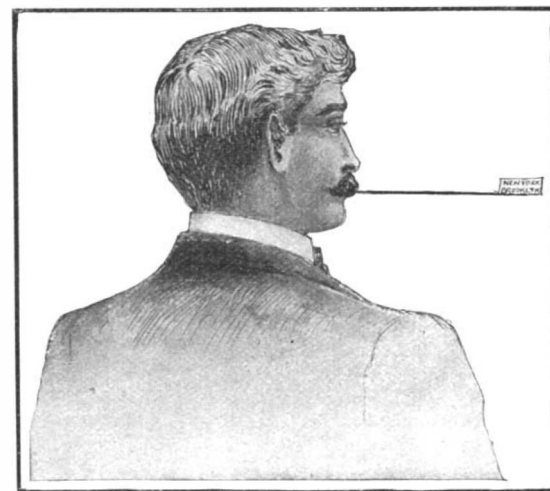

Experiment to Show That the Eye Does Not Remain Quiescent.

of position of the after-image relatively to the fixation mark, and endeavors to correct it. Thus the movement to be measured is checked, and the globe of the eye makes but a part of the excursion it would make under other conditions. In the second place, there is a tendency on the part of the subject to abandon the fixation mark, and to fix the attention upon some part of the after-image. This causes a shift of the eyeball, but it is not a shift due to the effort to fixate the mark. These two tendencies operate contrary to each other. But this mutual compensation is not sufficiently perfect to eliminate the irregularities. So another method of measurement had to be adopted. However, experimenting with this after-image method, Prof. Dodge found that his own movement of the eyeball was about ten minutes of angular measurement.

These fixation movements of the globe of the eye are (except perhaps to a very small extent) below the threshold of consciousness. They are therefore not under direct control. And besides, they are complicated with other eye movements.

Thus any movement of the head will—if the eye remains quiescent in its orbit—carry the globe of the eye with it. This would not be a fixation movement. However, some motions of the body are compensated for by involuntary movements of the eyeball, others are not. Thus, there is such co-ordination between the eyes and the head, that it has been found impossible to move the head and keep the eyes relatively quiescent—unless indeed the eyes are strongly converged. Thus, the head may be moved back and forth, through quite an arc and with a very fair degree of rapidity, while reading, without seriously blurring the print. This is a compensatory movement, and is not

a voluntary one, for the reason that the compensation is taking place with considerable rapidity, whereas it is known that to get a voluntary movement in response to the changes going on—that is, a reaction—requires more time. Again, suppose a bit of reading matter to be attached to a light rod, and the rod held between the teeth in suitable position to afford opportunity to read. Then let the head be moved back and forth. The effort to read is attended with difficulty, or even becomes impossible. If the eye remained quiescent in its orbit, this difficulty should not arise, inasmuch as head and reading matter retain their relative positions. These movements of the eyes in their sockets in response to movements of the head are probably associated with movements of the neck muscles. For, if the subject be placed in a revolving chair, and so arranged that the chair may be swung rapidly back and forth without moving the head relatively to the body, and an attempt be made to read a bit of printed matter attached to some fixed object and at a suitable distance, it will be found that blurring occurs.

These experiments suggest that all fixation movements—whether large or small—are due to efforts in compensation of bodily movements. With the utmost effort, however, to restrain the body and fixate the eye, it is found by using refined methods of detection that minute fixation movements still occur. To what can these be due? If, as just suggested, they are due to compensations for bodily movements, then these bodily movements are apparently quite minute. In investi-

interval following the supposed somatic movement. If then, through instrumental investigation, proximate and simultaneous photographic time records be made both of the bodily and fixation movements, the fixation movements should continually be subsequent to the bodily ones.

Again, with objects of regard (say incandescent figures) having the same shape but differing in size, the completeness of relief from fatigue afforded by a slight shifting would be greater the smaller the object. With the larger objects, then, the full movement to secure relief would be larger in amplitude, and would seem to persist for a longer time. By using different-sized similar objects, and measuring amplitude and time of the fixation oscillations, it would seem possible to secure confirmation or refutation.

The experiments here described are not, by any means, to be regarded as representing the extent of Prof. Dodge's investigation. They are really preliminaries to an elaborate experimental inquiry. But simple as they are, they do establish the points for which they are cited. And as such they are recommended as simple means by which one may convince himself of highly important truths.

NEW TYPES OF LIFE BELTS.

BY OUR ENGLISH CORRESPONDENT.

The ordinary type of lifebelt possesses the disadvantage that unless correctly donned, the wearer's equilibrium is in serious danger of being upset when

Transatlantic Steam Navigation Company at Havre before numerous interested government and other officials, including representatives of the British Admiralty and Commander Gibbons, the United States naval attaché at Portsmouth. On this occasion the inventor demonstrated the ease and rapidity with which the belt can be assumed, and the impossibility of the wearer's vertical position in the water being in any way disturbed or threatened. Owing to the position of the belt across the chest and back, the wearer's head was kept several inches above the water. Even if one should become unconscious through exhaustion, it would be almost impossible to be drowned, for when floating on the back or face, either of the two cushions will keep the head well above the water.

The second belt is the invention of Mr. Schwab, of London, and is called by him the "balloon waistcoat." In appearance the garment is an ordinary waistcoat, but it is lined with a bag of waterproof material, which surrounds the body and is inflated by blowing through a rubber tube. The bag can be inflated in about three minutes. Like the Focketyn belt, the balloon waistcoat has the great advantage, over the ordinary cork jacket, of lifting the upper part of the body out of water, so that the arms have perfect freedom of motion. Consequently, the wearer can readily seize floating wreckage or a buoy or line that is thrown to him, or swim toward safety.

Mr. Schwab has been successful in solving one great problem which confronts inventors—the attracting of publicity. He recently flung himself into the lake of a

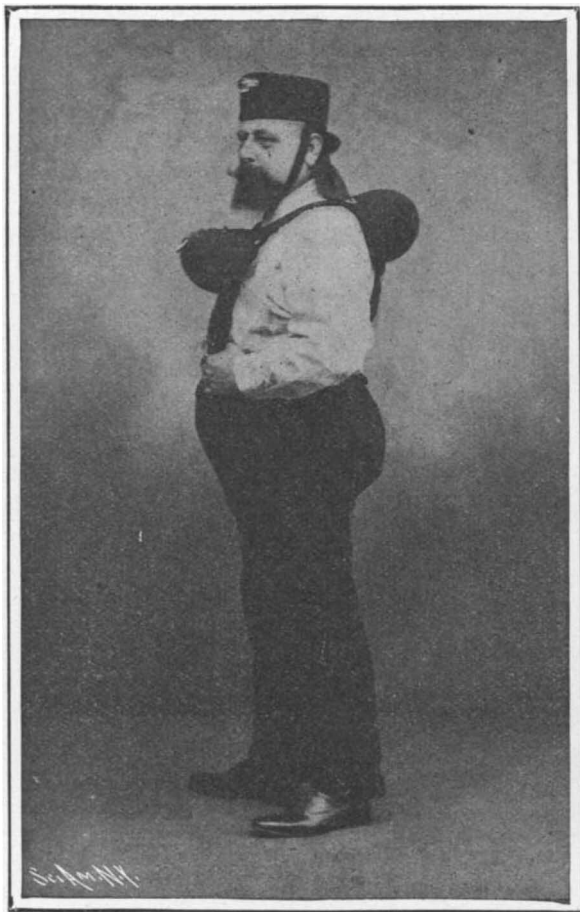

The Focketyn Lifebelt and Helmet.



The Schwab Waistcoat Inflated.



Fastening the Waistcoat After Inflation.



Walking Ashore After the Experiment.

NEW TYPES OF LIFE BELTS.

gating this subject with suitable apparatus, it has been found that certain movements tallied with the pulse, others seemed to be due to breathing movements, and so on. The circulation of the blood—to say nothing of respiration—no doubt causes minute movements of the head and neck, and these in turn occasion infinitesimal corrective motions of the globe of the eye. Again, the numerous opposed muscular attachments at various points in the body are, generally speaking, no doubt in a continual oscillation, also requiring incessant compensation.

Now, although these fixation movements may very properly be said to be involuntary, and not subject to a conscious will, still, at the same time, their automatic occurrence in response to the press of conditions implies a subconscious (or unconscious) motive. Prof. Dodge suggests as one of the possible physiological motives that of retinal fatigue. Thus, whether the object of regard consist of a mere point or a surface, the image formed on the retina would tend to tire the elements concerned, and relief would be experienced by a shifting of the image over the retinal surface. There would thus exist a possible motive for a movement of the eyeball to accomplish this shifting of the image.

It would seem that this hypothesis might be tested in two ways. First, consider the retinal element A, supposing it to have just been brought under stimulation by some somatic movement. If the fatiguing of A is to afford a motive for a displacement of the globe of the eye, then that fatiguing must occur after a real time

in the water. Recently a series of demonstrations have been carried out in Europe by the Société Civile pour l'Exploitation des Appareils et Engins de "Sauvetage l'Insubmersible" of Antwerp with the lifebelt invented by Mr. Jack Focketyn of that city, which while of simple design is so arranged that the wearer's head must always be kept above the water. As may be seen from the accompanying illustration, the device comprises two buoyant cushions, one resting on the chest, and the other across the upper part of the back, connected together by straps passing over either shoulder and a strap round the waist. The belt can be put on or taken off in three seconds. Its total weight is between 6½ and 7 pounds.

In connection with the lifebelt proper the inventor has devised a special helmet resembling a Russian cap, fixed to the head by a strap passing under the chin, and provided with a flap at the back to drop over the neck as a protection from the heat of the sun, etc. In the front of this cap is carried a small electric lamp fitted with a powerful reflector, charged from a small battery of from three to four hours' capacity. The light thus projected can be seen at sea for a distance of some 400 or 500 yards, and is of great utility in assisting the rescue of persons at night. Moreover, owing to the position of the lifebelt, both the arms and legs are left entirely free and unencumbered, so that the wearer can either keep himself afloat or assist himself by swimming if desired.

An interesting demonstration was recently carried out with the apparatus in the basins of the French

London park. When a rescue reached the supposed suicide, they found him reading and smoking a cigar.

The Current Supplement.

South America, especially the Argentine Republic, has been the scene of many remarkable railroad engineering feats for the provision of communication between difficult and inaccessible districts, more particularly among the Andes. One of these remarkable undertakings is described in an article of the current SUPPLEMENT, No. 1682, under the title "A South American Aerial Rope Railroad." Some possible developments of the gas engine are forecast. Mr. Harry W. Perry writes on the motor buses of New York and Philadelphia. Another automobile article of interest is that which describes the tests made by the French War Department with automobile trucks. Mr. R. G. Skerrett's astonishing letter on the submarine boat affair, which is now occupying the attention of Congress, is brought to an end. Mr. Edward W. Parker's instructive paper on the coal briquetting industry in the United States is brought to a conclusion. Some recent developments in freight steamship design are described. Details of Julliot's airship are given. Mr. H. W. Pearson's remarkable paper on the Basis for a New Geology is continued. The very striking article describing the theory of the Origin of Suns and Nebulæ, submitted by the well-known Swedish physicist Svante Arrhenius, is likewise concluded. The usual electrical, science and trade notes will be found in their customary places.

RECENTLY PATENTED INVENTIONS.

Of Interest to Farmers.

DRAFT-EQUALIZER.—C. PERES, Lebo, Kan. The invention relates to improvements in equalizers intended for use especially on gang plows, and has for its object to produce a simple and efficient construction by means of which the side draft incident to equalizers in common use may be obviated.

Of General Interest.

AEROPLANE.—G. WHITEHEAD, Bridgeport, Conn. In this patent the invention has reference to aerial navigation, and the object is to provide a new and improved aeroplane arranged to readily maintain its equilibrium when in flight in the air, to prevent upsetting, shooting downward head foremost, and to sustain considerable weight.

REINFORCED BAR FOR CONCRETE.—C. F. VARNEY, New York, N. Y. The invention relates to improvements in bars, rods, or trusses designed for use in the construction of concrete beams, walls, floors, columns, and the like. The object is to provide a construction in which there are two or more tension members arranged parallel or at any angle to each other and connected by shear members, adjacent ends of a plurality of the latter being intertwined to hold them together and form the first-named tension members.

SIGNALING APPARATUS.—W. T. STANWORTH, Norfolk, Va. This apparatus is intended especially for marine use. The signaling devices are preferably metallic plates which may be of any suitable configuration to conform to any code of flag signals, may bear letters or symbols of any desired code, are durable, can be made much simpler than the bunting flags, are not subject to the same deterioration as bunting flags, and the opportunity afforded for the use of letters will facilitate signaling by code.

HOSE-COUPLING.—W. SKERMAN, Brisbane, Queensland, Australia. In this case the invention relates to coupling for hose sections or other fluid conductors, and it is useful in any instance involving a sectional fluid conductor, notably in railway air brakes and in the compressed air connections of rock drilling and analogous machines.

ATTACHMENT FOR MOLDERS FLASKS.—J. N. PERKINS, Richmond, Va. The invention pertains more especially to improvements in the socket members which are usually fixed to the side of the drag and receive the dowels or pins attached to the cope and operating to direct and retain these parts of the molds in perfect register when assembled.

PROPULSION OF SUBMARINE BOATS.—G. F. JAUBERT, 155 Boulevard Maiesherbes, Paris, France. The object of this inventor is to permit of adopting an internal combustion engine for operating submarine or submersible vessels both on the surface and when submerged, without necessitating two separate motors for these purposes, while avoiding the inconveniences and complications resulting from employing electric accumulators.

JEWEL-HOLDER.—A. T. HUNT, New York, N. Y. The more particular object here is to produce a device suitable for exhibiting jewels in such manner as to give them the appearance they would have when worn upon a ring mounted upon the fingers. To this end the invention relates more particularly to the production of an annular member, more or less analogous to a finger ring and provided with gripping jaws movable relatively to each other for engaging and releasing jewels.

LABEL-PASTING BOARD.—L. DAUM, New York, N. Y. The board is adapted to have a surface for the reception of adhesive material and is adapted to receive labels to be coated with said material, and means are adapted whereby when the labels have been laid upon the coated surface of the board they may be conveniently and simultaneously raised from the board a portion of their length, or a distance enabling them to be quickly removed.

SCREW-PROPELLER.—R. E. COON, Portland, Ore. The propeller is designed to permit the pitch of blades to be altered or entirely reversed so as to permit the boat to be backed without reversing the engine, or to permit the blades to cut through the water edgewise without any propelling effect in either direction. The invention may be applied as well as a hydraulic motor by being anchored in a flowing stream of water, or as a wind wheel by being mounted to receive on its blades the impact of wind currents.

PIPE.—A. K. BOWMAN, Pittsburg, Pa. This pipe arrests the nicotine and other poisonous matter before reaching the mouth; collects and confines the saliva as well as the residue from the smoke as it passes in the direction of the bowl; cools the smoke and the stem of the bowl, and provides for the uniform burning of the tobacco within the bowl as by effecting a central draft therein.

PHONOGRAPH-HORN.—C. A. BEPPLER, New York, N. Y. One of the purposes of this improvement is to so construct a phonograph horn that the tip can be adjusted with equal facility to either a disk or a cylinder record without changing the position of the body or the bell of the horn.

ROPE-GRAB.—L. STEPHENS and E. L. STEPHENS, Macksburg, Ohio. The invention is

an improvement in tools and devices employed for fishing out and recovering ropes lost in oil wells; and more particularly is an improvement upon a grab for which Mr. L. Stephens formerly received Letters Patent of the U. S. In the present invention both jaws are free or disconnected from the head of the tool and are pivotally attached to the central stem which is pendent from the head of the tool.

Heating and Lighting.

HEATER.—H. BEVAN, Burlington, N. J. The invention pertains to improvements in furnaces for heating air to be discharged through flues into various rooms of a dwelling or other building, the object being to provide a heater having a large heat radiating surface, so that the air may be heated with an economical use of coal or other fuel.

Household Utillies.

DOOR STOP AND FASTENING.—W. SCOTT, Fredericksburg, Va. This attachment is for use on swinging doors for holding the doors open in any required position and also for fastening or locking them closed. It is so constructed that it may be employed as a door stop alone, it being in such case projected at the bottom of the door and engaging a socket in the floor, or it may be engaged with the door jamb so as to fasten the door closed.

CLOTHES-DRIER.—M. B. FITTS, Minneapolis, Kan. This improvement is embodied in the construction of the clothes-hangers proper, in their attachment to and support on the ropes or wires, in means for detachably connecting the several hangers, means for moving the hangers outward, and means for lowering, raising, and securing the ropes or wires at one end of the same.

DEVICE FOR SLITTING SWEET CORN.—G. A. BAHN, Austin, Tex. This device is intended for use in slitting the rows of grains or kernels of boiled or roasted sweet corn preparatory to eating off the cob the edible or most palatable, easily digested, and wholesome pulpy and juicy portion which is thus released from the tough, unnutritious, and indigestible fibrous covering.

COMBINED WARDROBE APPLIANCE.—J. MORRISON, JR., and M. P. BENSON, Upper Troy, N. Y. The more particular purpose in this instance is to produce a combinational device capable of use in several distinct relations. It contains two complete brushes capable of being united into a single brush and also of forming, when extended, a garment hanger having several advantages.

Machines and Mechanical Devices.

SOUND-REPRODUCER.—R. B. SMITH, New York, N. Y. The reproducer is such as is employed in connection with talking machines. The more particular object of the inventor is to provide for greater freedom of movement of the stylus lever in order to permit a more faithful reproduction of the vibrations and to avoid undue wear upon the record and stylus. Means permit the lever to travel freely in a direction lateral to the general direction of travel of the diaphragm.

BORING ATTACHMENT FOR DRILLS.—O. OSBORNE, Zanesville, Ohio. This invention concerns itself especially with the construction of a boring attachment to be used with drill presses. The spindle can be raised or lowered in the usual manner, these movements being permitted by the sliding connection of an arbor through a bushing. The former greatly increases the rigidity and strength of the mounting for the arm.

TYPE-WRITER.—P. GRÜTZMANN, Stettin, Germany. This device may be varied and it may be applied to any type-writer in which the ribbon is normally moved over the printing place for effecting the print of the type struck. The ribbon need not be taken out of the type-writer at all, when multiplying the writing by means of a mineograph or cyclostyle. All that is necessary for rendering the ribbon idle or active at will is merely to shift a part in one of the opposite directions.

STYLUS FOR TALKING-MACHINES.—S. GOLDFADEN, New York, N. Y. The aim of this inventor is to provide a stylus which can be adjusted in numerous different ways so that it will always have a good point to trace the record, thereby actuating the diaphragm in such a manner that the sound waves produced will be even and the sounds harmonious and clear.

Prime Movers and Their Accessories.

DISTRIBUTING-VALVE.—H. LENTZ, 123 Kurfurstendam, Halensee, near Berlin, and W. VOIT, 10 Grunewaldstrasse, Berlin-Steglitz, Germany. The invention is characterized by the fact that the double seat tubular valve of known form is combined with a hollow rod forming one with it and prolonged on both sides of the valve for the special purposes of improving the control, of facilitating the evacuation of the oil, of the products of condensation and other substances contained in the box of the spring loading the valve and in the distributing chest, and at the same time effecting the lubrication of the distributing mechanism.

Railways and Their Accessories.

CAR-DOOR.—G. O. HELVIG, Dawson, Minn. The intention in this improvement is to produce a door which can be opened and closed with great facility, and which will operate effectively to permit the loss of grain or similar produce which sometimes occurs in the cracks or small openings at the doorways of cars.

FENDER.—R. D'ORONZIO, New York, N. Y. This invention is directed to improvements in car fenders of the character for which Letters Patent were formerly granted to Mr. D'Oronzio, among the objects of the present invention being to produce a fender in which the locking mechanism for withholding the fender in a contracted position will be removed to a protective point, and the movable portion located at the front of the fender will, when struck, have the force thereof overcome by suitable buffers.

Pertaining to Vehicles.

FIRE-FIGHTING APPARATUS.—E. F. SANFORD, Merced, Cal. The invention relates to ladder and hose trucks, and its object is to provide an apparatus, preferably in the form of a motor vehicle, and arranged to permit of conveniently carrying the fire ladders, hose and a chemical tank, and allowing removal of the same for immediate use in a comparatively short time. Mr. Sanford has also invented another fire-fighting apparatus, the purpose of which is the provision of apparatus in the form of a chemical tank, removably mounted on the hose truck and arranged to permit using the tank when detached from the hose truck, and to allow using the truck for its legitimate purpose independent of the tank.

NOTE.—Copies of any of these patents will be furnished by Munn & Co. for ten cents each. Please state the name of the patentee, title of the invention, and date of this paper.

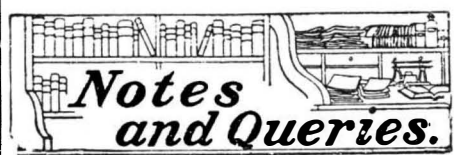

HINTS TO CORRESPONDENTS.

Names and Address must accompany all letters or no attention will be paid thereto. This is for our information and not for publication. References to former articles or answers should give date of paper and page or number of question. Inquiries not answered in reasonable time should be repeated; correspondents will bear in mind that some answers require not a little research, and, though we endeavor to reply to all either by letter or in this department, each must take his turn. Buyers wishing to purchase any article not advertised in our columns will be furnished with addresses of houses manufacturing or carrying the same. Special Written Information on matters of personal rather than general interest cannot be expected without remuneration. Scientific American Supplements referred to may be had at the office. Price 10 cents each. Books referred to promptly supplied on receipt of price. Minerals sent for examination should be distinctly marked or labeled.

(10705) J. N. L. asks how to metalize insects so as to render them capable of coating by the galvanoplastic process. A. Dissolve 1 ounce of phosphorus in 1 pound of bisulphide of carbon by frequent agitation. Add to this solution 1-3 pound of beeswax and mutton tallow 1-3 pound. Dissolve by gentle heat and guard against fire, as the mixture is very inflammable. To this add 1 pint of spirits of turpentine and 2 ounces of pure unvulcanized rubber dissolved with 1 pound of asphaltum in bisulphide of carbon. When the solution is complete, it can be applied to insects, flowers, etc., which are then dipped in a weak solution of nitrate of silver or chloride of gold. In a few minutes the articles are covered with a thin film of metal. They can be plated in the usual way. Remember that bisulphide of carbon is extremely inflammable. Experimenting should be done in the open air.

(10706) H. E. B. writes: I have need of a resistance of 25 ohms in the form of a strip of German silver 3/8 inch wide, 24 inches long. How thick must it be, or what gage? If I used it 1/2 inch wide, 24 inches long, what gage must I use? A. To get 25 ohms resistance with a strip of German silver 1/2 inch wide and 24 inches long will require that it be five millionths of an inch thick. If it be 3/8 of an inch wide, it may be a thought thicker. German silver has 13 times the resistance of copper. Hence a copper wire for the same size might be 26 x 2 feet or 26 feet long. And if 26 feet have 25 ohms, one ohm will be 0.04 feet long. Our wire table gives No. 39 wire as having 1.20 feet per ohm, which is near enough. Hence a German silver wire of the same size would have 25 ohms for a length of 2 feet. The problem then is to find the thickness of a plate whose sectional area is as great as a No. 39 wire, and whose width is a half inch. The diameter of the wire is 0.00353 inch. Its area is 0.00001 square inch. One half of this is 0.000005 inch.

(10707) S. R. R. asks: Why cannot the high-voltage alternating currents induced in the secondary of an induction coil be changed to direct currents and used the same as other currents of high voltage? A. The induction of an alternating e. m. f. is a neces-

sity of the action of an interrupted direct current. When the primary circuit is made, the induced current in the secondary is in the opposite direction from the current which induced it, since that is the proper effect of an increase of magnetic flux upon the turns of the winding; when the primary circuit is broken, the opposite effect is produced, and the induced current is in the same direction as that of the current which induced it. The induction of an alternating current by an interrupted direct current is therefore a necessity. Now, as to the transformation of such an alternating current into a direct current. When a condenser is employed with an induction coil, the induced e. m. f. upon making the primary circuit is much weaker than that which is set up by breaking the circuit. Because of this fact, when the spark terminals of an induction coil are separated so far that the e. m. f. set up upon making the primary circuit cannot throw a spark across the gap between them, the spark passes only upon the breaking of the primary circuit, and the induced current is a direct current, acting by impulses, there being as many impulses per second as there are interruptions of the primary current at the vibrator or interrupter. This is the method in which induction coils are ordinarily used for experiments. If one would see the spark at making the primary circuit, he can produce it by bringing the spark terminals nearer together, till a spark is produced upon making the primary circuit. This spark is from positive to negative in the opposite direction from the spark upon breaking the primary circuit. No way has been discovered for using such an arrangement as a source of power or for lighting lamps, so that it can compete with the alternating-current dynamo, generating an electromotive force, high enough for all practical purposes. Any transformer is operated at some loss, and the induction coil, throwing a spark through a wide gap of air, is not an economical transformer.

(10708) G. A. C. says: The writer has noted with interest the accounts of the pendulum experiment which have been published lately in the SCIENTIFIC AMERICAN, and wishes to say that the experiment was successfully performed at Lima College during October, 1907. The pendulum was hung in the tower of the college building, its length being 49.2 feet, and its weight about 85 pounds; No. 20 steel piano wire was used as a support. An amplitude of about 10 feet was obtained, and the pendulum would swing about five hours with one starting. A transit was used to measure the deflection from its initial position; the transit was first set up, and then the pendulum was started parallel to the line of sight; *ab* shows the initial direction of the pendulum, and *t'*—*T* the direction after the pendulum had been swinging a recorded length of time; thus the angle *tT'* was known, and the experiment could be verified. A. There was no intention to imply that the

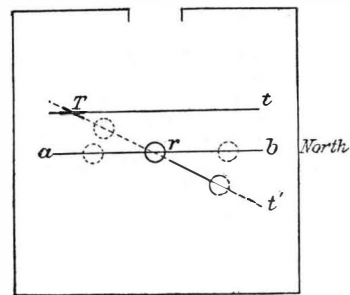

performance of the Foucault pendulum experiment which we described was the first time such an experiment had been made in America. Indeed, the professor who prepared the article which appeared in our columns has been in the habit of giving the experiment to his classes for many years. The experiment has been made at many colleges. The writer of this note has done it very often for more than twenty years. It was performed at Bunker Hill monument twice with a pendulum over 200 feet long; and if we are not mistaken, at the Washington monument with a pendulum nearly 500 feet long. Some papers have recently contained the statement that the experiment has never been done in America till this year. This is entirely erroneous. It may be done with a pendulum of any length more than perhaps 15 feet, and with any weight above 15 pounds. No special direction of swing is necessary, and the experiment need not be carried beyond a half hour to obtain a demonstration.

(10709) M. J. H. asks: 1. Can you tell me if it is possible to get mica in solution? If so, how? A. Mica is not soluble. It may be ground to a powder and formed into a paste with shellac or some varnish. 2. Is there any form of silica soluble in water, or any other simple solvent? A. There are soluble silicas. Soluble glass, sodium silicate, or potassium silicate, are of this sort. These substances are often called water glass. 3. I once saw some small clay vessels made on the potter's wheel; after a vessel was finished, the exhibitor poured some transparent liquid upon it from a bottle, which glazed and hardened it at once. Can you give a formula for such a liquid? A. You will find a large number of formulas for glazes in the "Scientific American Cyclopaedia of Receipts, Notes and Queries," price \$5 by mail.

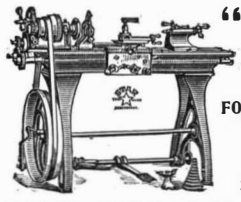

"Star" Lathes FOR FINE, ACCURATE WORK

ENGINE AND FOOT LATHES MACHINE SHOP OUTFITS, TOOLS AND SUPPLIES...

FOR PATENTEES A New Book Entitled: INVENTIONS How to Protect, Sell and Buy Them...

PATENTS Our Hand Book on Patents, Trade-Marks, etc., sent free...

FRICITION DISK DRILL FOR LIGHT WORK. Has These Great Advantages:

Keystone Well Drills for Artesian and Ordinary Water Wells; Mineral Prospecting and Placer Testing...

LARGEST DEALERS OF AUTOMOBILES. New and second-hand, in the World.

KING Folding CANVAS BOATS Lighter, more durable than wood. Serviceable in salt water.

RIDER AGENTS WANTED in each town to ride and exhibit sample bicycle. Write for special offer.

"Porox" Ignitor Storage BATTERIES High Capacity. Light Weight. Proved as the best for both ignition and light.

If You Are Thinking of a Row-Boat, Launch, Runabout, Motor-Boat or Cruiser, WRITE US. We'll show you "quality craft."

Strong Arms For 10c. in stamps or coin I will send, as long as they last, one of my charts showing exercises that will quickly build up shoulders, arms, forearms, and hands...

WELL DRILLING Machines Over 70 sizes and styles, for drilling either deep or shallow wells in any kind of soil or rock.

Table listing various mechanical items and their prices, such as Bunsen burner, Butter, oils, etc., Button, collar, D. A. Hart, etc.

Red Breast Packing Sayen-Reed Asbestos Packing Mercer Packing. Marked improvements have been recently made in the manufacture of Steam and Water Packings...

\$887.16 Earned in 11 Days. When the owner, with only one assistant, actually earned \$887.16 in eleven days cleaning houses with one of our Portable House-Cleaning Wagons...

WATERMAN CANOE MOTOR In 1, 2, 3 and 4 Cylinders. Small, neat, complete. Standard type. 2 H. P. Weight 35 pounds.

PROTECT YOUR OPERATOR AVOID DAMAGE SUITS. Let us send you full details of THE RACINE WOOD SHAPER GUARD.

The MAXIMUS Self-Cleaning TIMER Increases power and speed of engine. Stops spark-plug troubles. Saves gasoline and batteries.

FOX MOTORS HIGH-SPEED HEAVY DUTY. Our "square deal" policy is as important to us as it is to the buyer.

LIGHT THAT NEVER FAILS Will produce better light and more of it for less money than any other artificial lighting device made.

THE STRELINGER (Four cycle, one to four cylinder) Absolutely the Best Marine Engine Ever Made.

The Bungalow Number of American Homes and Gardens. Do You Own a Bungalow? Are You Building a Bungalow? If so, read the Special Bungalow Number of American Homes and Gardens.

IT IS MANIFEST

To any business man or accountant, after a five-minute examination, that the Universal Adding and Listing Machine operates easiest, most conveniently and does the best work on account of having the register right above the keyboard in plain sight so you can tell at a glance if the machine is clear or how much has been accumulated; of having the carriage on top of the machine like it is on a typewriter where you can conveniently reach it; of having the paper roll handy to get at; of a paper feed that handles a single loose sheet or carbon copies and permits the roll paper to be pulled up and torn off properly without using both hands; of a keyboard that restores when the handle is two-thirds of the way back so the operator doesn't have to wait to set up another item; of being able to take a total or sub-total without waste of time and effort to pull the handle a blank stroke; of having totals and sub-totals always printed in red and of fixed alignment, accurate work, etc.

In actual use the Universal is better than it looks, the key action is light, the lever pull is smooth and easy. It would help you on your work by adapting itself to your requirements without changing your office or accounting methods.

The Universal is made in many sizes and styles to suit the small merchant or the largest concern and can be had to operate by hand or electricity as desired. The Universal is sold absolutely on its merits, can be purchased for cash or on easy payments and is fully guaranteed.

Just give us an idea about your class of work and let us tell you all about the Universal - it won't cost you anything and you ought to know about the most modern Adding and Listing Machine made.

Universal ADDING MACHINE CO. 3835 Laclede Ave. ST. LOUIS MO.

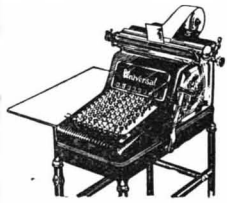

Do You Appreciate

Absolute Reliability and Easy Starting?

Our 1908 Models will contain more real motor value than has ever before been incorporated in one small motor.

They are made especially for the man who wants the best.

CUSHMAN MOTOR COMPANY 2026 N. St., Lincoln, Neb., U. S. A.

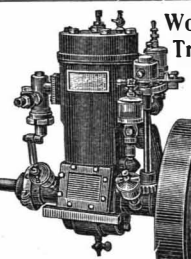

Would You "Make the Round Trip" Without Uncertainty?

Investigate the

Hildreth Marine Motors

We are ready to

"SHOW YOU"

Send for valuable facts about Marine Motors.

THE HILDRETH MFG. CO.

703 Sheridan, Lansing, Mich., U.S.A.

Invincible Marine Motors

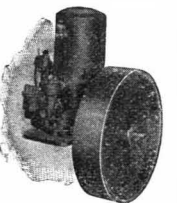

are the latest and most approved type, 2-Cycle engines for practical use. They are simple, sensible, strong and serviceable, made in three sizes, 2 H. P. and 3 1/2 H. P., single cylinder, and 7 H. P. double cylinder.

Our engines are sold with complete boat outfit under Factory guarantee, at net factory prices, which are very reasonable. Descriptive catalog free. Send today.

THE INVINCIBLE MOTOR CO., 453 Unity Building, Chicago, Ill.

Tools! Tools! Tools!

We keep all kinds. Send your name on a postal and get our 88-page Booklet

Montgomery & Co., 109 Fulton St., New York City



"KNIGHTS OF THE GRIP" Earn from \$2,000 to \$10,000 a Year and Expenses.

We will teach you to be one in eight weeks by mail and guarantee you a position as a Traveling Salesman with a reliable firm. No former experience required. Salesmanship is the highest paid of all professions. Hundreds of calls for our graduates. Send for our free book, "A Knight of the Grip," today. Address Dept. 408, National Salesman's Training Ass'n., Offices Modanock Bldg., Chicago, Ill., Lumber Exchange, Minneapolis, Minn., or Scarritt Bldg., Kansas City, Mo.

A Home-Made 100-Mile Wireless Telegraph Set

Read SCIENTIFIC AMERICAN SUPPLEMENT 1605 for a thorough, clear description by A. Frederick Collins, of the construction of a 100-mile wireless telegraph outfit. Numerous, adequate diagrams accompany the text. Price 10 cents by mail. Order from your newsdealer or from

MUNN & CO., 361 Broadway, New York

Advertisement for Gillette Safety Razor. Includes text: 'I Want You to Know My Razor as I Know It.' and 'Over Two Million sold in past three years.' Also features an illustration of a man shaving and a Gillette razor.

Gillette Safety Razor logo and text: 'NO STROPPING NO HONING'.

Advertisement for 'THE BEST LIGHT' lamp. Includes text: 'Produces a powerful, white, steady light, brighter than electricity or acetylene, cheaper than kerosene and absolutely safe.' and 'No Grease, No Smoke, No Dirt, No Odor'.

Advertisement for Remington Typewriter. Includes illustration of a man and a woman at a typewriter. Text: 'The typewriter user always expects more and better service from the Remington Typewriter than from any other writing machine. He has reason to, a right to, and we want him to.'

Remington Typewriter Company logo and text: 'Remington Typewriter Company (Incorporated) New York and Everywhere'.

Table listing various mechanical and scientific items with their corresponding page numbers. Items include: Engines, means for forcing liquids to, A. M. Zimmerman 882,226; Engines, vaporizer or carburetor for gas, C. D. Shain 882,023; Envelop and letter sheet, combined, C. W. Cook 882,297; Envelop fastener, L. M. Norwood 882,015; Etching apparatus, plate, J. N. Axt. 882,443; Evaporator, E. Zarenba 881,990, 882,043; Exercising apparatus, J. P. Thomas 882,181; Explosive mixing machine, G. P. Jones 882,114; Extension screen, metallic, T. Limoge 882,397; Eyeglass or spectacle mounting, H. Silbert 882,540; Fabrica, forming woven pile, J. K. Dalkranian 882,454; Fabrics, machine for cutting pile designs on, G. D. von Hofe 882,313; Fare register operating mechanism, W. H. Honiss 882,063; Fastener, P. Sicotte 882,430; Fence post, concrete, F. P. Van Hook 882,131; Fire alarm box, J. D. Williams 882,439; Fire escape, J. W. Hall, Sr. 882,409; Fire extinguisher, W. A. Bradshaw 881,893; Firearms, front sight for, J. E. Thompson 882,182; Flushing apparatus, L. Rupp 882,270; Flour and other grain products, apparatus for bleaching and ageing, Mears & Craig 882,526; Flour and other grain products, bleaching and ageing, Mears & Craig 882,527; Fluid pressure generator, M. Warren 882,085; Flush receptacle, F. P. Wheeler 882,225; Flushing apparatus, automatic, R. Brocke 882,451; Fly trap, J. F. & R. F. Richbourg 882,124; Fly trap, G. Fredrickson 882,306; Fly wheel, S. P., Jr., & J. P. Wetherill, Jr. 882,037; Flying machine, E. L. Drake 882,189; Flying machine, T. J. Whalen 882,435; Flying machine, E. R. Ernst 882,457; Fog signaling apparatus, T. L. Willson 882,059; Folding bench, angle-metal, W. H. Maxwell 882,010; Folding table, A. E. Howlett 882,064; Food, making leguminous, W. A. Schwalbe 882,173; Frog box, Willard & Donaldson 882,184; Fume condensing apparatus, J. R. Moffitt 882,073; Funnel, B. F. Bee 881,891; Furnaces, sheet for boiler, Rogerson & Rencher 882,420; Fuse and fuse box, F. L. Sessions 881,965; Fuse, mine, L. Lheure 882,154; Gaiter, H. Cohen 882,235; Game counter and the like, H. G. Hose 881,926; Garment fastener, F. E. Wilson 882,087, 882,483; Garment fastening device, D. Basch 882,445; Garter fastening device, man's, R. A. Moore, Jr. 881,939; Gas analyzer, automatic, H. J. Westover 881,986; Gas generator, Mears & Craig 883,528; Gas lighting device, W. K. Elliott 882,055; Gasoline engine and pump, drain, G. G. Forester 882,496; Gasoline trap, W. J. Kramer 882,393; Germicide, solar, J. O. Day 882,100; Glass articles, device for manipulating, F. G. Farnham 881,913; Glass, marble and the like, machine for grinding and polishing the edges of plates of, V. Kimon 882,115; Glass sheets, implement for cutting shaped sections from, C. F. Chapman 881,899; Glass tubes, machine for heating, J. T. Fagan 882,190; Gloves, apparatus for facilitating the putting on of india rubber, C. A. Hoeffteke 882,312; Governor mechanism for engines, W. E. Gannon 881,917; Grain machine for separating hulled from unbulled, A. P. MacDonald 882,156; Grain shocker, C. M. Cochran 882,052; Grate bar, C. W. Rollin 881,960; Grooving or routing tool, J. M. Massey 882,331; Hammer frame, power, L. J. Clossy 882,492; Harness fitting, W. H. Ferris 882,459; Hat mold, F. H. Lee 882,324; Hay rack, E. H. Moyer 882,407; Headers, comb reel for, J. C. Eichelberger 882,376; Heater, G. T. Bartlett 882,229; Heating system, steam, J. A. Donnelly 882,300; Heel, boot or shoe, Hamel & Vollmayer 881,921; Heel, cushion, R. W. Perry 882,268; Heel support, shoe, V. E. Harris 882,109; Heels or soles of boots and shoes, metallic protector for, J. H. Vinton 882,542; Hinge for screen doors, spring, E. Bommer 882,289; Hinge, spring, W. K. Bucher 882,140; Hoist, E. Y. Moore 882,202; Hone holder, R. J. Brandenburg 882,137; Hoop shaving machine, A. A. Dailey 881,907; Horseshoe, H. P. Kennedy 882,007; Horseshoe, Dunn & Francis 882,494; Hose coupling, E. Gummell 882,497; Hose coupling, air, W. W. Kilpatrick 882,503; Hot water heater, C. M. Wheelock 882,436; Hub, wheel, R. L. Wilson 882,441; Hydraulic press, W. Asfalck 882,045; Ice cream freezer, T. L. Cahoon 882,032; Ice making apparatus, E. T. Williams 882,224; Igniting apparatus, electrical, E. S. Huff 882,003; Immersion regulator, A. E. Jones 881,930; Implement, rotary, C. W. Keen 881,932; Induction coil, M. S. Brigham 882,048; Induction coil, J. O. Heinze, Jr. 882,198; Ingot compressing apparatus, J. Illingworth 881,927; Insect destroyer, W. R. Crann 882,142; Instep supporter, A. Toporzer 881,974; Insulating and testing system, cable, T. Cope 882,141; Insulator, electric, C. R. Slusser 881,967; Insulator pin, W. Scharfhausen 882,424; Insulators, wire tie for, W. E. Callane 882,095; Internal combustion engine, T. Veitch 882,221; Internal combustion engine, A. G. Melbush 882,401; Ironing board, G. A. Britton 882,003; Jar closure, F. Loffi 882,116; Journal box, A. O. Buckius, Jr. 882,487; Jug holder, C. R. Brown 882,231; Kettle, electric, D. C. Smith 881,968; Kitchen utensil, A. Koepfen 882,151; Knives of machines, guard for the, P. Knuth 882,252; Lace fastener, shoe, G. H. Nicholls 882,479; Ladder, extension, J. A. Catlich 882,371; Ladder jack, O. C. A. Block 881,906; Lamp, H. E. Fine 882,146; Lamp, automobile, L. Bleriot 881,892; Lamp bases, manufacture of incandescent, M. M. Merritt 882,258; Lamp, incandescent, M. M. Merritt 882,257; Lamp, inverted gas, E. R. Wilner 882,222; Lamp, revolving flash, E. E. Adams 882,442; Lamps, combined base ring and bracket for signal, J. F. Horn 882,309; Lantern, J. F. Horn 882,201; Lantern holder, C. W. Leaning 882,396; Lasting machine, C. F. Pym 882,018; Lasts, making, J. J. Smith 882,274; Latch, vehicle door, F. C. Altmann 882,136; Lead ores, reducing, A. Francis 882,193; Leather dressing from sapped or exhausted tanning liquors, making, G. W. Childs 882,480; Leather dressing from tanning liquors, making liquid, G. W. Childs 882,490; Leather, extraction of glue from mineral-dressed or chrome-tanned, A. R. Weiss, Jr. 882,481; Leather rolling press, C. Voss 882,033; Lever for lifting jacks, G. R. Booth 882,447; Lifting jack, M. L. Jenkins 882,004; Lifting jack, I. J. Keeler 882,066; Lightning arrester, F. P. Canby 882,096; Lightning arrester, N. J. Neall 882,265; Liquid concentrating apparatus, P. Kestner 882,322; Liquid fuel furnace, J. W. M. & M. M. Burdon 882,294; Loading apparatus, N. D. Hansen 882,384; Lock, D. W. Crockett 881,999; Lock, H. F. Kell 882,067; Lock, E. Eichler 882,303;

Locomotives, skeleton eccentric for, G. M. Ried	882,537
Logs, device for recovering—submerged, F. J. Hathway	882,310
Loom, F. Ott	882,120
Loom shuttle, J. A. & O. J. Perkins	882,267
Loom shuttle box, rotary box, A. E., A. & G. Walker	882,361
Loom take up mechanism, G. S. Cox	881,904
Looms, wett replenishing mechanism for, Gabler	882,106
Looms, yarn selecting mechanism for tufted fabric, J. K. Dalkranian	882,455
Looper hook, W. H. Zellers	882,090
Mail bag catching and delivering apparatus, J. C. Dayton	882,237
Mail bag deliverer and catcher, W. H. Rogers	882,345
Mail bag receiving apparatus, L. H. Burch	882,293
Mail pouch delivering apparatus, C. A. Willis	882,223
Mail receiving case, A. Haentze	882,381
Manure spreader, B. M. Buehler	882,370
Marking device, R. L. Herman	882,199
Marking gage, Anderson & Johnson	881,887
Mask, baseball, G. H. Ridlon	881,957
Massage apparatus, pneumatically operated, T. A. McCall	882,532
Match, safety, G. E. Schultz	882,427
Measuring device, self-registering land, J. Finn	882,191
Measuring machines, stamping attachment for cloth, F. Wolf	882,283
Metal and producing the same, expanded, N. E. Clark	882,491
Metals contained in copper-nickel matte, separating the, J. M. Neil	882,075
Milling apparatus, A. W. Handy	881,922
Mining apparatus, J. W. Hunsaker et al.	882,148
Mirror, folding hand, P. C. Petersen	881,947
Mitten pressing machine, R. S. Lewis	882,326
Mold, See cement or concrete block mold.	
Molding machine guide, W. L. G. Williams	882,440
Mortise joints, method of and means for making, J. L. Gilman	882,001
Motor, C. W. Manzel	881,935
Mower reaping attachment, J. W. Pridmore	882,164
Music leaf turner, H. H. West	882,036
Needle threader, M. E. & A. T. Lassen	882,204
Nut lock, W. F. Brown	882,369
Nut lock, C. L. Hine	882,389
Oar, J. Lehman	882,072
Oil, means for burning, T. C. Mason	882,205
Oil switch, electric, J. D. Hilliard, Jr., & C. E. Parsons	882,388
Oiler, windmill, H. E. Brown	881,896
Ore and materials, rotary screen for, H. G. King	882,070
Ore concentrating table, G. E. Woodbury	882,511
Ore concentrators, drive mechanism for, G. E. Woodbury	882,512
Ore separator, magnetic, R. R. Moffatt	882,158
Ore treating process, W. G. Swart	882,217
Ores, roasting and sintering, Dwight & Lloyd	882,518
Ores, treating, Dwight & Lloyd	882,517
Ozone producing apparatus, A. C. Wood	882,509
Package or mail catcher, G. Zucher	882,227
Packing, rod, J. C. Edgecumbe	882,103
Padlock, S. R. Fram	882,192
Pail support, milk, J. Schuster	882,211
Paper and the like, treatment of gum, R. A. McLaurin	882,336
Paper box or container, J. C. Kimsey	882,522
Paper hanging device, J. F. Brennan	882,092
Paper making machine roller and manufacturing same, W. E. Sheehan	882,351
Peanut picker, J. A. Warren	881,979
Pen, drawing, G. Schoenher	882,172
Pen, fountain, E. R. Smith	882,179
Pencils and the like, attachment for, F. W. Evans	882,377
Percolator, hot construction, G. E. Savage	882,080
Pessary, therapeutic, F. M. Siner	882,176
Piano action, R. Eastwood	882,302
Piano action frame, F. G. Billings	882,288
Pianos, lock slip for automatic, R. K. Thumler	882,433
Picture card, A. Kinnicut	882,150
Picture display machine, H. A. Farrand	881,916
Picture hanger, M. B. Franklin	882,243
Picture hanger, O. S. Olson	882,339
Picture holder, G. N. Marvin	881,936
Piles, means for sinking, F. B. Gilbreth	882,520
Pin tag or ticket, C. Winkler	882,088
Pipe, W. J. Williams	882,281
Pipe coupling, train, W. Z. Pullman	882,017
Pipe cutter, R. L. Thomas	882,432
Pipe cutting and crimping machine, Jansen & Moats	882,502
Pipe expanding apparatus, C. Fell	882,305
Pipe wrench, H. W. Simms	882,272
Planers, cuter guard for buzz, C. O. & A. D. Porter	882,122
Planter attachment, W. D. Gilbreth	882,379
Planter marker attachment, G. W. Goldsboro	882,462
Planter, potato, C. F. Schmidt	882,349
Plastic, A. Sargent	882,538
Plate doubling machine attachment, F. Westwood	882,434
Plow disk and the like, P. Speirs	882,353
Plug seat switch, B. O. Wells	881,985
Pneumatic action, H. Meyer	882,402
Pneumatic dispatch apparatus, sending mechanism for, H. D. Waterhouse	881,980
Pocketbook, H. A. Dodge	882,493
Potato masher, W. A. Prindle	882,078
Poultry fountain, J. Cullen	881,906
Power shovel jack-arm and mounting, J. B. Webber, Jr.	882,086
Power transmitting mechanism, W. O. Worth	882,513
Preserving jar, A. Wilkin	882,438
Printed paper strips in true register, device for assembling, P. Ashelm	882,366
Printing press, especially of the bed and platen type, A. Burbach	881,998
Printing presses and similar machines, dampening device for, G. W. Prouty	882,536
Pulley, friction, H. H. Balliet	882,444
Pulley, loose, C. M. Swanson	882,028
Pump, M. Latta	882,524
Pumping jack, L. R. Stone	881,972
Punch holder, L. J. Sloat	882,178
Puzzle device, R. Haldenwang, Jr.	882,464
Rack, See clothes rack.	
Radiator wall sections, connection for, J. A. Holfelder	882,315
Rail joint, G. C. Brown	882,201
Rail joint, insulating, B. Wolhaupter	882,041
Rail tie, metallic, L. R. Custer	882,298
Railway frogs and the like, heel block for, Weaver & Reinohl	882,982 to 882,984
Railway gate, automatic, J. Pernat	882,342
Railway joint chair, C. Herndon	882,200
Railway signaling apparatus, J. D. Taylor	882,275
Railway tie and rail joint means therefor, Hueschwerlen & Roulig	882,319
Railway tie, concrete, H. H. Clough	882,051
Railway ties, rail fastening for concrete, H. H. Clough	882,050
Railway trains, safety appliance for, R. C. Millard	882,157
Rake attachment, hand, O. Hubbell	882,467
Ranges, etc., water heating attachment for, B. W. Vest	882,541
Ratchet mechanism, E. A. Schade	882,539
Razor, J. E. Parkinson	882,413
Razor strop, C. W. Babcock	882,228
Reamer and boring head, R. N. Melvin	882,529
Recording and duplicating device, J. C. Proebstel	882,123
Reel for ruckings, etc., L. Sonn	882,431
Refrigerator car, M. Cooper	881,902
Register, N. D. Nelson	882,076
Retorts, extracting apparatus for horizontal, C. Eitle	882,304
Ring traveler, A. B. Potter	882,077
Rolling ribbed bars, T. W. Jenks	882,321
Rotary engine, C. E. Rhorer	882,168
Rotary engine, S. W. Vincent	882,360
Rotary engine, C. O. Sherman	882,428
Rubber goods, curing or vulcanizing, C. L. Pepper	882,341
Sand drier, C. Rifugal, C. McCall	882,256
Sanitary appliance, J. H. McCall	882,410
Sash fastener, G. Zellif	882,135
Saw attachment, I. H. Howe	882,318
Saw gage and filing tool, Z. N. Seelye	882,213
Saw, jig, A. Anderson	882,044

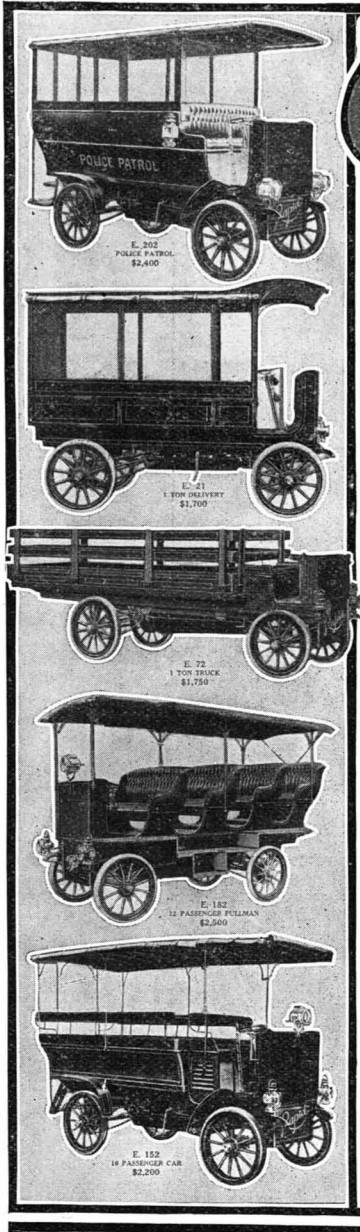

Rapid

DO YOU REALIZE the enormous advance which has been made in recent years in the making of commercial cars? Do you know that the Rapid line of power wagons offers a practical thoroughly tested car for every commercial purpose?

AS A PAYING INVESTMENT there are few things better for the man of limited capital than the Rapid line of passenger-carrying cars. These are made for 12, 16, 20 and 25 passengers, and are sure money makers in connection with hotels, summer resorts, sight-seeing service, or as a means of rapid transit between villages and suburban communities.

FOR COUNTRY CLUBS AND HOMES we call especial attention to our 12-passenger Pullman Car. This luxurious, easy-riding car provides the most fascinating, and at the same time, the most economical method of country and suburban transportation yet devised. Nothing has been spared to give it style, comfort and beauty.

FOR DELIVERY SERVICE, we have demonstrated in hundreds of cases the ability of a "Rapid" car to save money and give more efficient service than the old-fashioned horse-drawn methods.

WE MAKE SPECIAL CARS for every requirement, including drays, hearses, busses, hospital ambulances, police patrols, fire hose wagons, and anything special you may want.

Write me personally the kind of service you are interested in, and I will tell you just what our cars can do in your particular case.

B. P. HENRY, Sales Manager
RAPID MOTOR VEHICLE CO.

LARGEST MAKERS EXCLUSIVELY OF COMMERCIAL MOTOR CARS IN THE WORLD
135 Rapid Street, PONTIAC, MICH.

We have some excellent unassigned territory for responsible agents of ability who own a garage.

To Book Buyers

We have just issued a new 112-page catalogue of recently published Scientific and Mechanical Books, which we will mail free to any address on application.

MUNN & COMPANY
Publishers of SCIENTIFIC AMERICAN
361 Broadway, New York

HOW TO MAKE ELECTRICAL BOOKS

Choice of 28 Books for 10 cents.
Other Books, Castings for Dynamos and Motors. Send for Casting Bulletin and Book List. Write us for any book you want.
BUBIER PUB. CO., S. Lynn, Mass.

BABBITT METALS—SIX IMPORTANT formulas. SCIENTIFIC AMERICAN SUPPLEMENT 11-23. Price 10 cents. For sale by Munn & Co. and all newsdealers. Send for catalogue.

MARINE GASOLINE ENGINES

A Motor Boat Encyclopedia
A Scientific and Practical Book on Marine Engines and Motor Boats written by experts in a style easily understood by all, whether familiar with this subject or not. A book of 64 pages and 20 illustrations. This 100% Practical Treatise also describes the Ferro Marine Engine in detail. Send 10 cents for it today. Costs us much more—worth many times this amount to you. Catalog FREE.
The Ferro Machine and Foundry Co., 75 Wade Building, Cleveland, Ohio
Eastern Branch—2d floor, 41 Cortlandt Street, N. Y. City

"Columbus" THE BUGGY

COLUMBUS BUGGIES
BUILT BY US
The Standard for Quality Everywhere
NOW SOLD DIRECT FROM OUR FACTORY TO YOU
SAVING YOU THE HOME DEALER'S PROFIT

A "Columbus" is the vehicle you should buy. Don't take chances when you can go direct to the manufacturer, getting the genuine Columbus Quality and Columbus Style, saving the 40% to 60% Dealer's Profit. Every Vehicle Sold on One Full Month Approval Trial and Guaranteed Two Years.

We want you as a customer—once a Columbus customer—always a Columbus buyer. When you do business with this company, you are dealing with an old reliable manufacturer with a reputation built on quality and square dealing. We have buggies now in use sold over 15 years ago. We have thousands of customers who would not have anything else.

FREE OUR CATALOGUE OF COLUMBUS BUGGIES, Runabouts, Phaetons, Surreys, Stanhopes, Carriages and Harness will be mailed to you absolutely free. Write for it now.

THE COLUMBUS CARRIAGE & HARNESS CO.,
2063 So. High Street, Columbus, Ohio

AUTOMOBILES \$100 AND UP

We will mail our large Illustrated Bargain Sheet of new and slightly used Automobiles on request. This sheet shows accurate photographic views of more than 50 Automobiles offered as low as \$100. Every car guaranteed as represented. Write plainly to

S. GRAHAM AUTOMOBILE CO.
Established 17 years. 601-603-605 Madison St., CHICAGO, ILL

Twice-Two Cycle Engine

Greater mechanical simplicity. Perfect combustion—no smoke—no odor. Higher efficiency—single cylinder. 5-inch bore—6-inch stroke. 600 revolutions per minute—12 horse power by actual brake test.

Simplicity of the TWO-CYCLE with more efficiency than the FOUR-CYCLE

"Seeing is believing." We are ready to "show" YOU.
THE TWICE-TWO CYCLE ENGINE CO., Inc.
20 South Canal Street, Chicago

Classified Advertisements

Advertising in this column is 75 cents a line. No less than four nor more than ten lines accepted. Count seven words to the line. All orders must be accompanied by a remittance. Further information sent on request.

BUSINESS OPPORTUNITIES.

START A MAIL ORDER BUSINESS of your own, but not with a cheap trick or novelty. I made \$50,000 in five years and began small. I will show you how to start right. Send for free booklet. Heacock, Box 363, Lockport, N.Y.

WANTED.—Good industry, fine location, natural gas, solid rock foundation, plenty water, reasonable price for labor. Address Board of Trade, Cedarville, Ohio.

PATENTS WANTED.—We market patented articles on royalty basis. Give full description and selling price. Best references. No agents. Continental Company, 535 Missouri Trust Bldg., St. Louis, Mo.

PARTNER WANTED.—One who can furnish money and manufacture in Europe a patented invention on a royalty basis. Partner, Box 773, New York.

PATTERN LETTERS AND FIGURES (White Metal and Brass) for use on patterns for castings. Large variety, prompt shipments. Send for catalog. H. W. Knight & Son, Seneca Falls, N. Y.

PATENTS FOR SALE.

UNITED STATES PATENT 845,492, Canadian Patents Nos. 103,617 and 107,167. For the Process of Making Wrought or Steel Fluid and Non-Fluid Oil Cups and Plugs. For locomotive rods, guides, eccentrics and compressors, etc. The best and cheapest cups made. \$3,000 in service. No reasonable offer refused. For particulars address J. T., 614 S. 2d St., Albuquerque, N. M.

IMPROVED TRENCHING HOE OR LAWN TRIMMER. U. S. Patent 871,565. On a royalty basis. E. B. Cahoon, 32 S. Balch Street, Akron, Ohio.

FOR SALE ON ROYALTY.—Patent No. 793,279. Improved natural or artificial gas mixture for all pressures. Warrants investigation. Correspondence solicited. F. H. Crawford, 52 W. Gay St., Columbus, Ohio.

FOR SALE.

FOR SALE.—King Four Cylinder, Four Cycle Engines. Cylinders 5x5 1/2 inch. Price \$375. Northern Motor Car Co., Detroit, Mich.

HELP WANTED.

OFFICE MANAGER, \$1,000; Chief Draftsman, \$1,500; Timekeeper, \$1,000; Private Secretary, \$1,000; Specialty Salesmen, \$1,200. Other positions open. Write Hapgood, 305 Broadway, New York.

WANTED thoroughly competent steam specialty Salesman. One that can sell high grade goods. Address M. M. Co., 1041 Grand River Avenue, Detroit, Mich.

AGENTS WANTED.

YOU CAN DECORATE China. Burnt Wood, anything, plain or in colors, from photographs. No talent required. A new art appeals to everybody. Cost small, profits enormous, decorating or teaching. Outfits supplied. Stamp for information and agent's prices. B. K. Vallance Co., Elkhart, Ind.

AGENTS WANTED in every county to sell the Transparent Handle Pocket Knife. Good commission paid. From \$75 to \$300 per month can be made. Write for terms. Novelty Cutlery Co., No. 2 Bar St., Canton, O.

TYPEWRITERS.

TYPEWRITERS.—Hammond, \$10; Remington, \$12; Smith Premier, \$18; Oliver, \$20. All guaranteed for one year. Send for catalogue. Harlow Typewriter Exchange, Dept. B, 217 West 125th Street, New York.

AERONAUTICS.

INSTRUCTION.—Three courses; Balloons, Dirigibles, Aviation, prepared by Lieut. C. Espitalier, French Army. A. C. Triaca, Director. Catalogue on request. International School Aeronautics, 2 East 29th Street, New York. Telephone 2515 Bryant.

MALLET, Paris, Spherical Balloons and Dirigibles. Chauviere, Paris, Aerostatic Motors. Antoinette Motors for Aviation. Hue Aeronautical Scientific Instruments. American Representative: A. C. Triaca, 2 East 29th Street, N. Y. Tel. 2515 Bryant.

BOOKS AND MAGAZINES.

ELECTRICIAN AND MECHANIC.—Practical monthly magazine for electrical and mechanical students and workers. Publishes illustrated directions for constructing dynamos, motors, gasoline engines, wireless telegraphy, electroplating, electrical wiring, mechanical drawing, using tools, furniture construction, boat building, all kinds of mechanical work. One dollar yearly; trial subscription for three months, twenty cents. List of electrical and mechanical books free. S. A. Sampson Pub. Co., 6 Beacon St., Boston, Mass.

HOUSEHOLD NEEDS.

BUTCHER'S BOSTON POLISH is the best finish made for floors and interior woodwork. Not brittle; will not scratch or deface like shellac or varnish. Send for free booklet. For sale by dealers in Paints, Hardware and House Furnishings. The Butcher Polish Co., 356 Atlantic Avenue, Boston, Mass.

PHOTOGRAPHY.

AMERICAN PHOTOGRAPHY succeeds American Amateur Photographer. Camera and Dark Room and Photo Beacon. The editors of each now join in making a magazine which should be in the hands of every photographer, professional or amateur. 15 cents monthly, \$1.50 per year. Three specimen copies for a quarter. Am. Photographic Pub. Co., 361 Broadway, New York.

GRE-SOLVENT.

GRE-SOLVENT instantly dissolves Machine-grease, Paint, Ink, etc., from hands. Beneficial to skin. Sells like wildfire to every mechanic. Agents wanted. Big profits. Free sample. Do it now. Utility Co., 646 W. 44th St., N. Y. City.

OLD COINS AND STAMPS.

\$5.75 PAID FOR Rare Date 1833 Quarters. Keep all money coined before 1875 and send 10c. at once for a set of two coin and stamp value books, size 4x7. It may mean your fortune. C. W. Clarke & Co., Le Roy, N. Y.

How to Construct an Independent Interrupter

IN SCIENTIFIC AMERICAN SUPPLEMENT, 1615, A. Frederick Collins describes fully and clearly with the help of good drawings how an independent multiple interrupter may be constructed for a large induction coil. This article should be read in connection with Mr. Collins' article in SCIENTIFIC AMERICAN SUPPLEMENT, 1600, 'How to Construct a 100-Mile Wireless Telegraph Outfit.' Each Supplement costs 10 cents; 20 cents for the two. Order from your newsdealer or from MUNN & CO., 361 Broadway, New York

Table listing various scientific and mechanical items with their corresponding prices, such as Scaffolds, Scrapers, Sewing machines, and other tools.

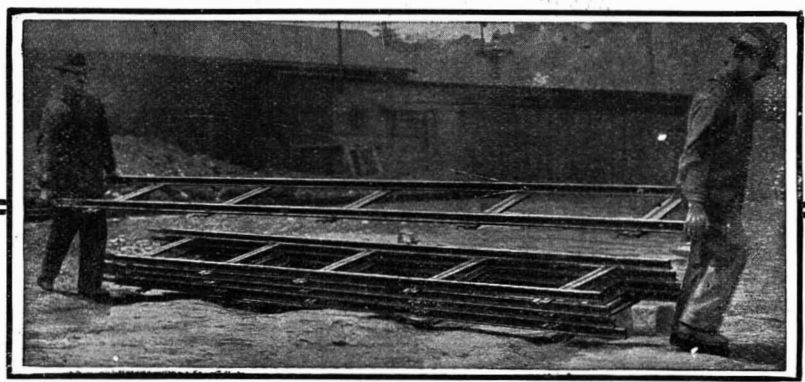

Two Men and a Monkey Wrench

can lay a Koppel track anywhere— And do it in a marvelously short space of time. The Koppel system of Portable and Industrial Railways solves the problem of economical transportation of raw materials or finished products. It is in use today in contracting operations and manufacturing plants the world over.

We design and manufacture cars of all kinds, portable track, rails, switches, turntables, and so forth

Write today for descriptive catalogue No. 59.

ARTHUR KOPPEL CO.

Sales Offices and Warehouses: NEW YORK, PITTSBURGH, CHICAGO, SAN FRANCISCO, BOSTON, BALTIMORE

Our Book Department

WE OFFER our patrons and subscribers the advantages of a long established and widely experienced department, devoted to the publication and distribution of modern, up-to-date books pertaining to all branches of Engineering, Mechanics, Chemistry, Science, Industrial Arts, Trades and Manufactures.



- List of books including 'The Scientific American Reference Book', 'The Scientific American Boy', 'Experimental Science', etc., with their respective prices.

MUNN & Co., Publishers, 361 Broadway, New York

Pioneer Perfect Frames are the Standard

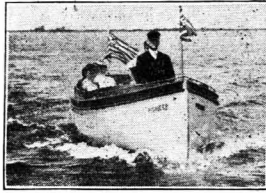

of knock-down boat construction. You can easily build this boat yourself with Pioneer Perfect Frames, the only frames having ribs bent to exact shape, set up, trued, tested and beveled for planking before being knocked down for shipment to you.

Frames we furnish, absolutely free, patterns and instructions for completing your boat. Order Pioneer Frames TO-DAY on the Easy Payment plan and see for yourself the simplicity of the Pioneer System. If you haven't time, or cannot get material conveniently to complete your boat yourself, write us for low-priced, perfect Beeking, Planking, Fittings, Engines, etc. Write TO-DAY for FREE Book of Pioneer Perfect Frames and Full-Size Patterns, etc., or send 25c. for 104-page boat-builders' book. 300 illustrations. All about our 40 types of boats, engines, etc. Money back if not satisfied.

PIONEER BOAT AND PATTERN CO., Wharf 229, Bay City, Mich.

Make Your BIKE into a MOTORCYCLE

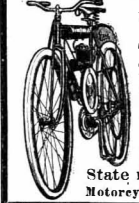

Without altering the frame and at little cost by attaching the new 1908 Erie 2 1/2 H. P. Attachment. This includes all parts so that any one can make a strong up-to-date machine that will climb steep hills. Sample sold at cost to introduce it. Send 4c. in stamps for Attachment Catalog S or Motorcycle Catalog C. MOTORCYCLISTS stamps for book on the care of Motorcycles. State make of your machine for acc. prices. Motorcycle Equipment Co., Hammondsport, N. Y.

CURTISS WORLD'S RECORD MOTORCYCLES



New Single and Double Cylinder Models for 1908 now ready. Diamond Medal, Highest Award, National Endurance run, won on a Curtiss. Send for Catalogue H and Booklet "Achievements."

G. H. CURTISS MFG. CO., Hammondsport, N. Y.

Hypnotic Therapeutics

By JOHN D. QUACKENBOS, A.M., M.D. This volume is the result of seven thousand personal experiences of the author with hypnotic treatment of the physically and morally diseased, and is permeated with the conviction that Hypnotism is the greatest regenerative force of the age. It presents an unparalleled record of the most amazing psychopathic cases, ranging from the mere pain of abnormal bashfulness to the depravities resulting from physical excess and the wildest mental delusions. The treatise is true to science, and nevertheless is written for "the man in the street." Dr. Quackenbos is well known in the world of Medical Hypnotism, and his views carry authority. As a record of humanity, the book will amaze and impress all sorts of readers. Crown 8vo, \$2.00 net.

The Chemistry of Commerce

By ROBERT KENNEDY DUNCAN The Chemistry of Commerce is a graphic narrative of the wonderful work of applied chemistry in the industrial world to-day. It affords an engrossing story of the invention and manufacture of commodities that are close to the business or home interests of each one of us. It is packed with information upon such topics as the making of artificial rubies and diamonds, of non-breakable Welsbach mantles, of the distillation of perfumes in quantities sufficient to float a frigate, of the coloring of glass, of the engineering feats accomplished by high temperatures, the preparation of drugs like camphor and quinine, the extraordinary future of industrial alcohol. Illustrated. \$2.00 net.

Worlds In The Making

By SVANTE ARRHENIUS Under this picturesque title is set forth a wonderful theory of independent modern scientists. From the principle of the mechanical radiation pressure of life—that rays of light falling upon a surface tend to push that surface back—a new theory of world-building is evolved. Illustrated. Crown 8vo, \$1.60 net.

HARPER & BROTHERS NEW YORK CITY

60 YEARS' EXPERIENCE PATENTS TRADE MARKS DESIGNS COPYRIGHTS & C. Anyone sending a sketch and description may quickly ascertain our opinion free whether an invention is probably patentable. Communications strictly confidential. HANDBOOK on Patents sent free. Oldest agency for securing patents. Patents taken through Munn & Co. receive special notice, without charge, in the Scientific American. A handsomely illustrated weekly. Largest circulation of any scientific journal. Terms, \$3 a year; four months, \$1. Sold by all newsdealers. MUNN & Co, 361 Broadway, New York Branch Office, 625 F St., Washington, D. C.

Table listing various items and their prices, including wrappers for boxes, fettsback, and wrenches.

DESIGNS. Table listing various designs such as altars, badges, bottles, and display cabinets with their respective prices.

TRADE MARKS. Table listing various trade marks including ammunition, antiseptics, bags, beer, binders, biscuits, and boots.

Table listing various items and their prices, including fuses, game, hair, harmonicas, insulated wire, locks, and magazines.

Table listing various items and their prices, including paper, pens, railway supplies, remedies, and shoes.

Table listing various items and their prices, including soap, staples, and tobacco.

LABELS. Table listing various labels for products like whisky, dental cream, and soap.

PRINTS. Table listing various prints and designs such as Adler's Latest Spring Apparel and Holtite.

A printed copy of the specification and drawing of any patent in the foregoing list, or any patent in print issued since 1863, will be furnished from this office for 10 cents, provided the name and number of the patent desired and the date be given. Address Munn & Co., 361 Broadway, New York. Canadian patents may now be obtained by the inventors for any of the inventions named in the foregoing list. For terms and further particulars address Munn & Co., 361 Broadway, New York.

Along the New Line to the Pacific Coast. Through the Dakotas, Montana, Idaho and Washington, the building of this railway opens up a country full of money-making possibilities. Rich farm lands are now selling at \$10 per acre, and upwards. They are bound to increase in value within the next few years. Three new towns—Lemmon, Butte County, South Dakota; Hettinger, Adams County, North Dakota; and Bowman, Bowman County, North Dakota—have recently been established. Three months ago the sites of these towns were open prairie lands. Today at each place a well-built town, with a population of close to 500, is established; many trades and professions are represented. But there is plenty of room for more along the Pacific Coast extension of the Chicago Milwaukee & St. Paul Railway. Pamphlets describing these openings are free for the asking. F. A. Miller, Gen. Passenger Agent, CHICAGO. W. S. Howell, Gen. Eastern Agent, 381 Broadway, N. Y. CITY.

LET US BE YOUR FACTORY STAMPINGS, MODELS, EXPERT WORK THE GLOBE MACHINE AND STAMPING CO. 970 Hamilton St., Cleveland, O.

ICE MACHINES Corliss Engines, Brewers' and Bottlers' Machinery. THE VILSTER MFG. CO., 893 Clinton St., Milwaukee, Wis.

MODELS & EXPERIMENTAL WORK. Inventions developed. Special Machinery. E. V. BAILLARD, 24 Frankfort Street, New York.

RUBBER Expert Manufacturers Fine Jobbing Work PARKER, STEARNS & CO., 228-229 South Street, New York

Experimental & Model Work Cir. & advice free. Wm. Gardam & Son, 45-51 Rose St., N.Y.

ELECTRIC GOODS.—Big Cat. 3 cts. Want Agents. Ohio Electric Works, Cleveland, O.

MODELS & EXPERIMENTAL WORK, Gears, Dies, Tools, Novelities manufact. M. P. SCHELL, 1759 Union Street, San Francisco

SEALED PROPOSALS. SEALED PROPOSALS will be received at the office of the Light-House Engineer, Tompkinsville, N. Y., until 1 o'clock P. M., March 28, 1908, and then opened, for the erection of a keeper's dwelling at Stonington Breakwater Light-Station, Conn., in accordance with specification, copies of which, with blank proposals and other information, may be had upon application to the Light-House Engineer, Tompkinsville, N. Y.

WANTED.—SECOND-CLASS LABORATORIAN, \$4.00 per diem. An examination will be held at the Navy Yard, New York, N. Y., April 1, 1908, to fill the above position. For application and further information address Commandant Navy Yard, New York, N. Y.

MODELS & INVENTIONS PERFECTED & GEARS UNION MODEL WORKS 193 So. CLARK ST. CHICAGO.

Telegraphy Circular free. Wonderful automatic teacher. 3 styles \$2 up. OMNIGRAPH CO., Dept. 52, 39 Cortlandt St., New York.

Do Your Own Printing \$5 press prints cards, labels, etc. Circular book, newspaper press \$18. Money saver, maker. All easy. Rules sent. Write factory for press catalog, type, paper, etc. THE PRESS CO., Meriden, Conn.

Scientific American Index of Manufacturers NEWLY REVISED EDITION of 1908 64 PAGES, 2500 ENTRIES, FREE SOME ten years ago the publishers of the SCIENTIFIC AMERICAN issued an index of leading manufacturers. This book has proved so popular that the demand has warranted an entire new edition. This invaluable list tells where to buy almost any article, and buyers who fail to find the information they desire can have their wants specially looked up without charge, and if necessary we will advertise their wants in our inquiry column without expense. The first edition of this index is only 15,000 copies, so that early application is necessary. MUNN & CO., Publishers Scientific American Office 361 Broadway, New York

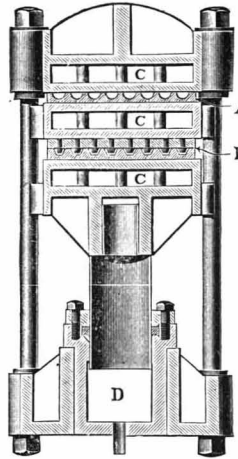

We request manufacturers, inventors and others needing special articles in rubber to send us descriptions of their requirements with drawings or wood models for estimates as to cost of producing in rubber.
A full line of Mechanical Rubber Goods of every description.

Vulcanizing Press for Rubber Specialties

A Single Plate Mold. B Double Plate Mold. C Steam Spaces in Press Plates. D Hydraulic Pressure 2000 lbs. square inch.

NEW YORK BELTING & PACKING COMPANY, Ltd.
91 & 93 Chambers Street, New York

Scales All varieties at lowest prices. Best Railroad Track and Wagon or Stock Scales made. Also 1000 useful articles, including Safes, Sewing Machines, Bicycles, Tools, etc. Save Money.. Lists Free. CHICAGO SCALE CO., Chicago, Ill.

BRISTOL'S Recording Instruments
For Pressure, Temperature and Electricity in all ranges
INSURE SAFE & ECONOMICAL OPERATION
Write for Catalog T, stating conditions
THE BRISTOL CO., Waterbury, Conn., U.S.A.
New York, 114 Liberty Street Chicago, 753 Monadnock Building

BAUSCH & LOMB Levels and Transits

Embody the latest improvements and represent the most advanced ideas in the construction of engineering instruments. Fitted with variable power eyepiece which permits a range of from 12 to 25 diameters, thus enabling the instrument to be used according to the varying conditions of the atmosphere.

Bausch & Lomb Optical Co.
Carl Zeiss, Jena. George N. Saegmuller
San Francisco
Washington
London
Frankfort
ROCHESTER, N. Y.

WM. H. BRISTOL Electric Pyrometers
Portable or Recording Forms
All ranges to 2900° F. Practical, Accurate, Inexpensive. Guaranteed to give satisfaction. Send for circulars.
Wm. H. Bristol, 45 Vesey St., New York

Mullins Sheet Metal Statuary
Unequaled for Architectural Adornment
Highly artistic effects that are exceedingly durable, and that cost much less than cast or sculptured work.
Complete illustrated catalogue mailed on request.
Write for estimates on all kinds of sheet metal work.
The W. H. Mullins Co., 203 Franklin Street Salem, O.

LUFKIN TAPES AND RULES ARE THE BEST.
For sale everywhere. Send for Catalog No. 16.
LUFKIN RULE CO. Saginaw, Mich., U.S.A. New York and London.

A MONEY MAKER
Hollow Concrete Building Blocks Best, Fastest, Simplest, Cheapest Machine. Fully guaranteed.
THE PETTYJOHN CO. 615 N. 6th Street, Terre Haute, Ind.

THE STRONGEST LIGHT METAL
McADAMITE
Specific Gravity 3.20
Tension, - 44,000 lbs. to sq. in. Compression, 126,000 lbs. to sq. in.
Transverse, 87,000 " " " Torsion, - 60,000 " " " "
Send for test bar or a pattern for sample casting
U. S. McADAMITE METAL CO. BROOKLYN, N. Y.
19 Paper Vc Street

That Lake—Those Woods
Model 31, \$1,400

is at your command with a
Rambler
Your favorite lake, your country home, the pool where the big ones lurk, are just at the end of a pleasant ride.
Every type of the Rambler has been rigidly tested and proven right and the thousands in constant use under all conditions of road and weather have established a record of positive reliability that has earned the title
The Car of Steady Service
There are tangible reasons for this superiority that we are ready to prove. Our catalog gives details and a demonstration will convince; both are at your service, write today. Two other models, a Touring Car and a Roadster, at \$2,250 each.

Thomas B. Jeffery & Company
Main Office and Factory, Kenosha, Wisconsin.
Branches and Distributing Agencies:
Chicago, Milwaukee, Boston, Philadelphia, San Francisco. Representatives in all leading cities.

A Startling Discovery in Photography
The ISOSTIGMAR LENS
(Manufactured by R. & J. Beck under Letters Patent)
The Product of an Entirely New Idea. 3,000 Sold the First Three Months in London. Best of all Anastigmats. Increased Efficiency; Cost reduced 50 per cent. Comparison of Prices: Previous Anastigmats, 4 x 5, \$45.00-\$51.00. Isostigmars, 4 x 5, \$18.00-\$25.00.
Isostigmars at the Kodaks. Lenses sent on 10 days' trial on receipt of price or through your dealer. Price lists of Isostigmars. Enlarging Outfits and Photoscripts for Tinting Negatives, sent free.
Reflecting Lantern for Opaque Objects
Will show on the screen Book Illustrations, Engravings, Post Cards and opaque objects, brilliantly illuminated in Natural Colors. Made in two styles. **The College Projector**, a large, powerful instrument for classroom and auditorium work. Now in use at Harvard, Cornell, University of Pennsylvania, Swarthmore, Leland Stanford, Girard College, etc., etc. **The Post Card Projector**, on same principle, but simpler and inexpensive. For showing post cards and other illustrations in Natural Colors. With the Post Card Projector a collection of cards becomes a constant source of instruction and amusement in the home, school or lodge. Send for lists of Projectors, Stereopticons and Moving Picture Machines. Our Latest Clearance Lists of Microscopes, Stereopticons and X-Ray Apparatus sent free.
WILLIAMS, BROWN & EARLE, Dept. 6, 918 Chestnut Street, Philadelphia, Pa.

The Largest Parts and Supply House in America
Everything for the Automobile and Automobilists
Manufacturers, Distributors and Jobbers
AUTOMOBILE PARTS AND ACCESSORIES
Neustadt Automobile & Supply Co.
"The Growing House" 3932 Olive St., St. Louis, Mo.
Our 1908 Catalogue, 200 pages, over 1000 illustrations and 5300 descriptive quotations, yours for the asking

Engineering News

(ILLUSTRATED)
214 Broadway, New York

The leading weekly Engineering paper of the world, devoted to the interests of Civil, Mechanical, Mining, and Electrical Engineers. 100 to 125 pages weekly. Send for free sample copy.

COLD GALVANIZING. AMERICAN PROCESS. NO ROYALTIES. SAMPLES AND INFORMATION ON APPLICATION.
Established 1820.
NICKEL AND Electro-Plating Apparatus and Material THE Hanson & VanWinkle Co., Newark, N. J. 28 & 30 S. Canal St. Chicago.

The Holsman Automobile
SIX YEARS OF SUCCESS
Rides Like a Carriage
1907 Sales Over \$600,000.00
THE STANDARD of high-wheeled automobiles and the pioneer of this type. The only high-wheeled automobile, manufactured that has a record in a public contest—and Holsman records date back to 1902. Suitable for all seasons and all kinds of roads. **Solid Rubber Tires, Economical and Efficient.** Air-cooled motor. No live axles, friction clutches or differential gears. Exceptional hill-climbing power.
Manufactured and Sold by
The Oldest and Largest Manufacturers of Carriage Automobiles in the World
THE HOLSMAN AUTOMOBILE CO.
437 Monadnock Block, CHICAGO, ILL., U.S.A.

GOERZ PHOTO LENSES SHUTTERS
ANSCHÜTZ CAMERAS
RIFLE TELESCOPES
TRIEDER BINOCULARS
Send 9 cents for beautiful de luxe general catalogue.
C. P. GOERZ AM. OPTICAL CO.
52 E. Union Square N. Y. City
1514 Heyworth Bldg. Chicago Ill.
703 Call Bldg., San Francisco, Cal.

HIGH GRADE AIR GUNS, DARTS, SLUGS, STEEL TARGETS, 22-100 CAL. SAFETY RIFLES.
Manufactured by
H. M. QUACKENBUSH
Herkimer, N. Y.
SEND FOR CATALOGUE A

ALLEN Soldering Stick
Gives Perfection of Joints—is Free from Acid. The Perfect Solder-Flux. Sample free for dealer's name. No name—no sample.
L. B. ALLEN CO., Inc., 1335 A Columbia Avenue CHICAGO

I TEACH Penmanship BY MAIL
I am the man who won the World's First Prize in Penmanship. By my new system I can make an expert penman of you by mail. I also teach Book-keeping and Gregg Shorthand by mail. Am placing my students as instructors in commercial colleges. If you wish to become a better penman write me for full particulars. I will send you FREE one of my Favorite Pens and a copy of the Ransomer Journal. Inclose stamp.
C. W. RANSOM,
3866 Euclid Ave. KANSAS CITY, Mo.

HELMETOIL LUBRICATES SEND TOP SAMPLER FREE
15-21 S. CLINTON ST. CHICAGO, ILL. U.S.A.