

SCIENTIFIC AMERICAN

[Entered at the Post Office of New York, N. Y., as Second Class Matter. Copyright, 1908, by Munn & Co.]

Vol. **XCVIII**.—No. 10.
ESTABLISHED 1845.

NEW YORK, MARCH 7, 1908.

[10 CENTS A COPY
\$3.00 A YEAR.]

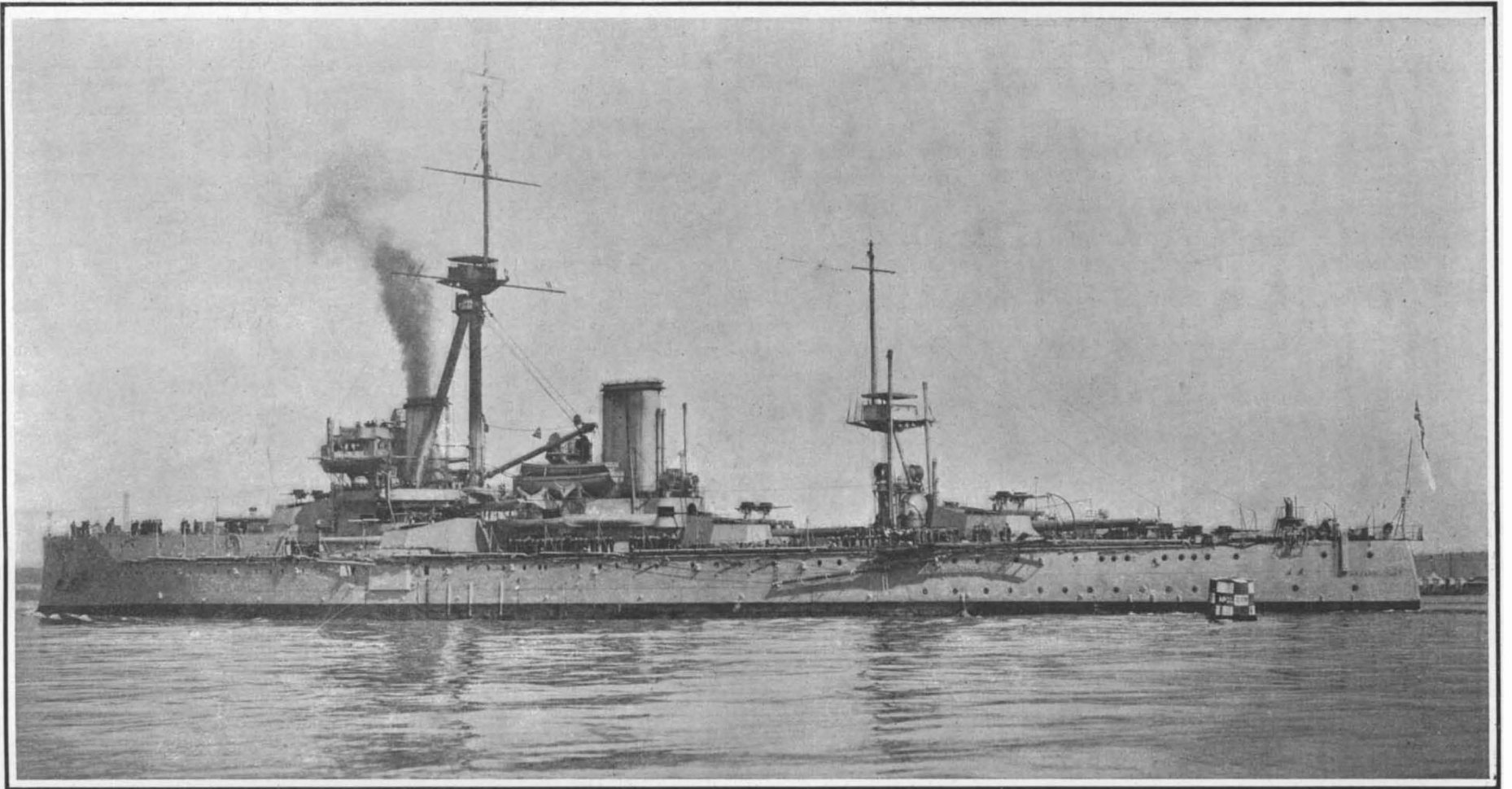

Displacement, 17,900 tons. **Speed**, 21 knots. **Coal supply**, 2,000 tons. **Fuel oil**, 400 tons. **Armor**: Belt, 11 inches; turrets, 11 inches; deck, $2\frac{3}{4}$ inches; side armor, 11 inches to 8 inches. **Guns**: Ten 45-caliber 12-inch; twenty-seven 12-pounders. **Torpedo tubes**, 5 submerged. **Date**, 1906.

All-Big-Gun Battleship "Dreadnought." Also Class of Six Similar Ships of 18,600 and 19,500 Tons.

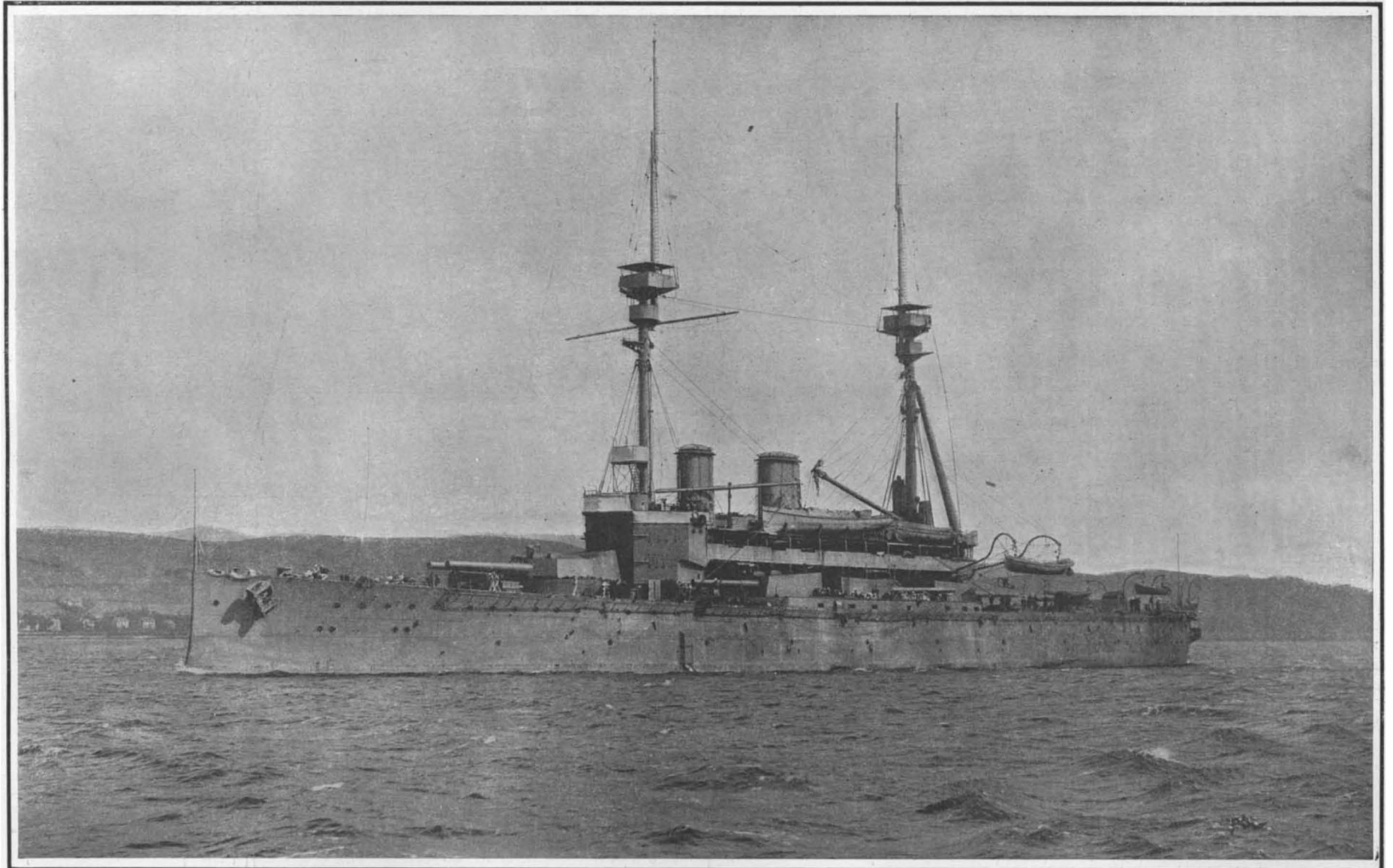

Displacement, 16,600 tons. **Speed**, 18.8 knots. **Coal supply**, 2,000 tons. **Fuel oil**, 400 tons. **Armor**: Belt, 12 inches; side armor, 7 inches; 12-inch turrets, 8 inches to 14 inches; 9.2-inch turrets, 7 inches; deck, 2 inches. **Guns**: Four 12-inch; ten 9.2-inch; fifteen 12-pounders. **Torpedo tubes**, 5. **Date**, 1906.

All-Big-Gun Battleship "Agamemnon." Also "Lord Nelson."

SCIENTIFIC AMERICAN

ESTABLISHED 1845

MUNN & CO. - - - Editors and Proprietors

Published Weekly at

No. 361 Broadway, New York

CHARLES ALLEN MUNN, *President*

361 Broadway, New York

FREDERICK CONVERSE BEACH, *Sec'y and Treas.*

361 Broadway, New York

TERMS TO SUBSCRIBERS.

One copy, one year, for the United States or Mexico \$3.00
 One copy, one year, for Canada 3.75
 One copy, one year, to any foreign country, postage prepaid, 18s. 6d. 4.50

THE SCIENTIFIC AMERICAN PUBLICATIONS.

Scientific American (established 1845) \$3.00 a year
 Scientific American Supplement (established 1876) 5.00 "
 American Homes and Gardens 3.00 "
 Scientific American Export Edition (established 1878) 3.00 "

The combined subscription rates and rates to foreign countries, including Canada, will be furnished upon application.

Remit by postal or express money order, or by bank draft or check.

MUNN & CO., 361 Broadway, New York.

NEW YORK, SATURDAY, MARCH 7, 1908.

The Editor is always glad to receive for examination illustrated articles on subjects of timely interest. If the photographs are sharp, the articles short, and the facts authentic, the contributions will receive special attention. Accepted articles will be paid for at regular space rates.

HEAVY TRAFFIC THROUGH THE NEWLY-OPENED HUDSON TUNNEL.

The ceremonies attending the opening of the up-town twin tunnels of the McAdoo system below the Hudson River were carried through with marked enthusiasm; and the popularity of the new route is attested by the fact that, during the first twenty-four hours, 70,000 people were carried to and fro beneath the river. The value of this route, as forming a link in the chain of continuous communication between New Jersey and New York city, is evidenced by the fact that already a contract between the Erie Railroad and the Hudson River Tunnel Company has been signed, and the president of the railroad has announced that connection with the new tunnels will be made within a few months' time. Although the new route will prove to be of great convenience to long-distance passengers arriving over the transcontinental lines that have their termini in Jersey City, its most marked effect will undoubtedly be felt in promoting suburban travel in New Jersey, by placing the charming residential towns and districts of that State within easy and convenient touch of the business sections of New York. Moreover, the obvious advantages of having direct communication with New York without change of car will prove a stimulus to the railroads to electrify their suburban lines, and equip them with electric trains that can pass through the tunnels to the New York terminus.

DOUBLE-DOOR CARS FOR SUBWAY CONGESTION.

Mr. Bion J. Arnold, the engineer who was called in by the Public Service Commission to make a study of the improvement of Subway transit facilities in New York, has reported to the Commission that the real solution of the problem of accelerating travel in the Subway is to be found in the car. He recommends that the present cars be equipped with double doors at the ends of each car, with a view to separating the streams of entering and leaving passengers, and getting rid of the interference which lies at the root of the present delay. Mr. Arnold has thus laid his hand upon the very feature to which the SCIENTIFIC AMERICAN for several years has pointed as the true cause of traffic congestion, not merely upon the Subway, but upon all railroad lines that are overcrowded. Long before the Subway was opened, indeed, we urged that the side-door car was absolutely indispensable, if the full capacity of the system was to be realized.

Mr. Arnold recommends that a second door be provided at each end of the car immediately adjoining the pocket into which the present doors slide when they are opened. The present doors are to be used exclusively by passengers boarding the car, and the new doors by those who are leaving it. As the matter now stands, when an express car draws up to the platform, a closely-packed crowd of passengers inside the door of the car finds itself confronted by another densely-packed crowd of passengers outside the door. Under the new system, the two crowds will be separated; and the instant the doors are opened, the one crowd will find unobstructed entrance into the car, and the other unobstructed exit from it. The time for loading and unloading, as far as the movement of passengers is concerned, will thus be cut in half. Moreover, he suggests that the present method of opening the doors by hand, and of signaling by bell cord, be replaced by the use of pneumatic means for opening and closing doors, with automatic "go-ahead" indicators to the motormen, which will operate the

moment the last door is closed. By these changes Mr. Arnold estimates that the time taken for unloading and loading trains at stations will be reduced from 55 seconds to 30 seconds, and that the capacity for trains through a given station can be raised from less than thirty to forty per hour.

URGENT NEED FOR THE CATSKILL WATER SUPPLY.

The new system for the supply of pure mountain water to New York city is the most extensive project of its kind ever undertaken. The Catskill water is noted for its purity and abundance; and when New York decided to go back into the mountains, and drive tunnels and build dams and dikes for collecting and impounding the water, it planned everything on a most ambitious scale, with a view to anticipating the exceedingly rapid growth of New York city which is certain to occur with the years to come. The main sources of supply are to be drawn from four creeks, Esopus, Rondout, Schoharie, and Catskill. The total area of all the watersheds is over 900 square miles, and their combined supply, when they have been fully developed, will exceed 800 million gallons daily. The works which are now projected will have sufficient capacity to bring into the city every day not less than 500 million gallons.

That there is urgent need for the construction of these works is proved by a consideration of the facts regarding the present consumption of water by New York city, and the maximum present capacity of the aqueducts through which the city's water supply is brought in. At present the Croton water flows to New York through two conduits, known as the "Old" and the "New Aqueduct," whose combined maximum capacity is 380 million gallons per day. Now, during one month of last year, the city used an average of 345 million gallons per day, all of which was drawn through the aqueducts from the Croton watershed. The rate of increase of consumption of water by the city for seven years past has been 15 million gallons per day each year; so that at this rate of increase the city will soon be calling for more water than the existing aqueducts can carry. Furthermore, the safe average yield of the Croton watershed per day in a series of dry years is only 336 million gallons per day.

What the city's future demand for water will be is shown from the following figures. To-day the population of Greater New York is about 4,350,000. The total consumption of water is 500 million gallons per day, of which the Croton system, when completely developed in 1910, can furnish according to the figures of the Board of Water Supply only 336 million gallons. At the end of 1915, it is estimated that the population of Greater New York will be 5,260,000, and its water consumption 710 million gallons per day, or 250 millions above the present available supply. It is estimated that by the year 1930 the population will have increased to almost 7,000,000, and the consumption to over 1,000 million gallons daily.

It should be a source of the liveliest satisfaction to the people of this city that in the present serious emergency, the task of providing a new supply of water is in the hands of a Board who have succeeded in organizing their working forces without the least interference from politicians. It is the boast of the chief engineer, Mr. Waldo Smith, that he has been able to select his large staff of engineers purely on their merits. Moreover, the recent attempt to exercise political control in the matter of the letting of the \$12,000,000 contract for the Olive Bridge dam, proved to be an ignominious failure, the higher courts deciding that the action of the Board in rejecting the lower bid, on the ground that its engineers pronounced it impracticable, was entirely justified.

THE ALLEGED PATENT OFFICE FRAUDS.

For the first time in its honorable history of over a century, an official of the United States Patent Office is charged with a crime so serious in its nature, that every manufacturer, every inventor, and every patent lawyer will find it hard to give it credence. Upon information furnished by the Commissioner of Patents, a grand jury has indicted Ned W. Barton, Third Assistant Examiner of the United States Patent Office; Henry E. Everding, a patent attorney; and John Allen Heany, an inventor, for having entered into a conspiracy to appropriate the discoveries of inventors, and in furtherance of this end with having destroyed and falsified Patent Office records. The Patent Office examiner in question is an able man, who enjoyed the respect and confidence of his colleagues; the patent attorney occupies an enviable position as a patent expert of ability; the inventor involved has made a name for himself as an investigator of exceptional ingenuity, if not genius, whose dogged pertinacity enabled him to perfect inventions which promise radically to improve our methods of lighting. The indictment alleges that on January 19, 1905, Heany made an application for Letters Patent covering an invention for a tungsten incandescent electric lamp. It is charged that an official letter addressed by the Commissioner of Patents to the in-

ventor on March 28, 1905, and an amendment filed July 27, 1905, by the attorney, were destroyed, and that Barton, conspiring with Everding and Heany, substituted for the original application of Heany new papers, in which were incorporated the ideas of inventors who had also filed applications for patents which covered inventions in the same field, and which necessarily came before Barton to pass upon, so that Heany's application, bearing as it did the original date of filing, falsified, naturally took priority. In order to carry out such a scheme, it was necessary to destroy original records, to file substitutes, and to change the dates of receiving stamps.

The carbon filament lamp remains to-day what it was when Edison brought it to perfection in 1879. In the twenty-eight years that have elapsed since that time, not a single notable improvement has been made to increase its efficiency, which circumstance indicates not that inventive ability is lacking on the part of the great lamp companies, but simply that this type of lamp has reached the end of its possible development. It was not astonishing, therefore, that some attempts should be made to devise lamps of a totally different character. It was known that several elements are infusible enough to serve as lamp filaments if they can only be made in that form. Among them tungsten seemed promising. The temperature at which carbon volatilizes is considerably lower than that of tungsten, which means that a tungsten filament can be subjected to a considerably higher temperature than a carbon filament. From this circumstance alone we may conclude that the tungsten lamp will be more efficient than the carbon. The chief difficulty is the production of pure tungsten filaments. The very infusibility of the metal is the chief obstacle to its being made into wire; for such metals are generally obtainable only in a fine powder by reduction from their oxides, or in partially fused lumps which contain carbon and are not in a condition suitable for wire drawing. Mr. Heany attacked the problem twelve years ago. That he was successful may be gleaned from the fact that for five years he has been manufacturing tungsten lamps on a commercial scale, and that the best metallic lamps now on the market are of his invention. The problem was also attacked in recent years by Dr. Alexander Just and Franz Hanaman, by Dr. H. Kuzel, and by the Welsbach Company. With all of these men Mr. Heany naturally came into a legal conflict of international character and importance. Their respective claims to priority have not as yet been finally adjudicated. The victor in the struggle will have practically a monopoly of the metallic-filament industry.

The patent with the falsification of which Barton, Everding, and Heany are charged is not basic, covering as it does merely the use of very fine filaments of tungsten mounted in an electric lamp in such a manner that they can be used practically and perfectly as an ordinary carbon filament is used. If the charges are sustained, no doubt Mr. Heany's more vital patents may be made the subject of investigation.

The very rigid system of recording cases as they are received in the Patent Office, the searching nature of the inquiry which is conducted in every interference case, renders any attempt such as this is alleged to be almost foolishly reckless on the part of the examiner. He must inevitably be detected. The incident, astonishing as it is, should occasion no alarm. In the present case, common sense and fairness demand that judgment be suspended until a jury has declared the men at the bar innocent or guilty. The Patent Office needs no defense. It has been the one governmental bureau that has been conducted with ability and without a trace of corruption. Commissioner Moore has put it: "No examiner has ever been shown false hitherto to the trust imposed upon him in all the one hundred and eighteen years of existence of the United States patent system."

Some interesting experiments concerning the possibility of dispatching messages by kites have been carried out at Brighton, England, by Mr. S. H. R. Salmon, a meteorological scientist. He designed a special kite of the diamond-box type, fitted with a keel to insure additional stability and provided with a line 400 feet in length carrying a drag 30 feet long and weighing 12 pounds. A wooden bottle was attached to the kite, containing a message requesting the finder of the bottle to return it to him with full information as to the point where picked up, etc. This was sent into the air from the beach at Brighton in a wind favorably blowing toward the coast of France, but the kite was never heard of again. A second kite was then built, varying in design, being of the rhomboid box type, carrying a shorter length of line and a lighter and longer drag, the measurements being respectively 200 feet, 6 pounds, and 66 feet. This was launched in the same way as before, and in less than twelve hours was picked up at Vierville near Calvados in France, after traveling 103 miles. A third experiment was equally successful, the kite fouling a fishing boat 1½ miles off Berck, a distance of 75 miles from Brighton.

THE HEAVENS IN MARCH.

BY HENRY NORRIS RUSSELL, PH.D.

Our map shows clearly the principal constellations. The finest group is in the southwestern sky, in and near the Milky Way. Argo, the southernmost of these, is seen only in southern latitudes, but Canis Major above it is one of the ornaments of the sky, and Orion is even more so, though it contains no one star equal to Sirius. Above these groups are Canis Minor and Gemini, the last almost overhead, while Auriga is northwest of the zenith and Taurus west of it, lower down.

These constellations contain seven stars of the first magnitude (marked by the largest circles on the map) which is one-third of the whole number of such bright stars in all the heavens.

Aries is setting, a little north of west. Venus and Mars, which both pass through this constellation during the month, are much brighter than any of its stars. To the right of Aries is Andromeda, and above this is Perseus, whose most remarkable star is the variable Algol (shown on the map). This star loses about three-quarters of its light at regular intervals of 2 days 20 hours and 49 minutes, and it is known that the obscuration, which lasts about eight hours altogether, is due to its eclipse by a dark companion, which revolves about it very near it. Eclipses of this sort, visible in the eastern United States, take place at 7 P. M. on March 2 (Eastern standard time), at 9 P. M. on the 22d, and 6 P. M. on the 25th. The times of the other minima (which are unobservable here) can be found by adding multiples of the period.

Of the northern constellations, Cepheus and Cassiopeia are below the pole on the left, and Draco and Ursa Minor on the right, while Ursa Major is high up in the northeastern sky. He is high up in the east, below Jupiter, which is in Cancer, and very high.

Virgo and Boötes are just rising, and in the southeast Hydra has dragged about half its enormous length into sight.

THE PLANETS.

Mercury is morning star all through the month, but is not well visible until its end. On the 27th he reaches his greatest elongation, nearly 28 deg. from the sun. At this time, however, he is a good way south of the sun, and consequently he rises only about an hour before him.

Venus is evening star, and is now exceedingly conspicuous, setting at about 8:45 P. M., in the middle of the month. She is growing brighter as she approaches us, and is visible in broad daylight if one knows just where to look for her. On the afternoon of the 5th she is about 6 deg. north and 3 deg. west of the moon, which may help in picking her up. (The diameter of the moon measures about half a degree.)

Mars is also evening star, and is moving slowly eastward through Aries into Taurus. Venus is overtaking him, but she does not catch up with him till early next month.

Jupiter is in Cancer, visible almost all night, and finely placed for observation.

For the sake of those who have telescopes, we remark that eclipses of his satellites occur as follows.

The 1st satellite disappears behind the planet on the 18th at 10 P. M. and comes out of eclipse on the other side at 1:30 A. M. The later eclipses follow regularly at intervals of 1 day 18½ hours. The similar data for the other satellites are:

- Eclipse of the 2d, March 2, noon to 4 P. M.
 - Eclipse of the 3d, March 1, 7 P. M. to 2 A. M.
 - Eclipse of the 4th, March 1, 6 P. M. to 11 P. M.
- and thereafter at intervals of 3 days 13¼ hours, 7 days 4 hours, and 16 days 18 hours, respectively. Half way between every two eclipses the satellites and their shadows travel across the planet's disk. The evening of the 26th is especially notable as the 1st

satellite is eclipsed, while the 3d and 4th and their shadows transit over the disk.

Saturn is in conjunction with the sun on the 20th, and is practically invisible this month. Uranus is morning star in Sagittarius, too low to be well seen. Neptune is in Gemini, and comes to the meridian about 7:20 P. M. on the 15th.

THE MOON

New moon occurs at 2 P. M. on March 2, first quarter at 5 P. M. on the 9th, full moon at 9 P. M. on the 17th, and last quarter at 7 A. M. on the 25th. The moon is nearest us on the 1st and the 29th, and most remote on the 13th. She is in conjunction with Mercury on the 2d, Saturn on the 3d, Venus on the 5th, Mars on the 6th, Neptune on the 18th, Jupiter on the 13th, Uranus on the 26th, Mercury again on the 29th, and Saturn on the 31st.

Princeton University Observatory.

SAND BUILDING-BRICKS.

The increasing use of building-bricks or blocks made of sand and cement in Europe has given rise to a number of questions as regards the various qualities of this building material; and at first the manufacturers (usually on a small scale and working independently of each other) were not able to answer such questions.

dice in the minds of those who have to carry them; it is only a question of the weight on the foundations.

It is a well-known fact that good "klinkers" absorb only a very small amount of water, as their surface is not only smooth but practically coated with a glaze. For this reason they must be laid in cement mortar. But the sand blocks with a crushing strength, called for by the municipal building authorities; of 2,000 pounds per square inch, are porous enough to be laid in ordinary lime mortar, even when it is permitted by the building inspectors to use them instead of "klinkers."

The matter of bad-smell has often been laid at the door of the new building material. This, however, should be only when they are just from the works, or when they are laid up just after being wetted by the rain. As, however, the crust gets harder and harder with time, the odor is not perceptible when it is time to paper the rooms.

One advantage of the sand blocks is that as they are always rectangular, and have smooth faces and sharp edges and corners, there are not so many "wasters" as is the case with bricks, where there are often many that are badly burned or only half burned. This enables more rapid work, outside of the question of saving in the material itself. The sand blocks

break less in handling and laying than the burned clay bricks; they are also of more regular quality. Further, there is no difficulty in making radial, half, and quarter blocks, so that they are convenient for architects who wish to have special ideas carried out.

The sand blocks are free from saltpeter—a freedom which is not shared by most clay bricks. They have the great advantage that they call for no plastering in cellars, workshops, and workrooms, or even in corridors, this effecting a great saving in construction.

Further, the blocks may be used in work where color schemes are carried out.

As regards fireproof qualities, reference may be made to the burning of the Virksche sand-block works in Malchow, Mecklenburg. From the report concerning this fire the following is taken:

"The two stacks, which remain standing, and one of which was made of the best clay bricks, and the other of sand blocks, present the most remarkable appearance. The latter is entirely unchanged in its external appearance; the blocks remain smooth and sharp-cornered, although they were subjected to a heat so intense that the lightning-rod was melted. The stack built of clay bricks did not experience

such intense heat, as is shown by the unchanged condition of the lightning rod; but for all that, it showed considerable damage. A cross of white hard brick built into this stack was uninjured, while the ordinary brick surrounding it was notably injured."

Tests of the fireproof quality of the new material have been made by the building authorities in Hamburg, Rostock, Colberg, etc.; but the most important were those in Berlin. The report concerning them states that "good lime and sand blocks are equal, in resistance to fire and to water-jets, to the ordinary burned bricks."

A further advantage claimed for this material is that it permits perfect bond between the mortar and itself.

Drill bits that are to be used in sandstone should be tapered somewhat and then flattened instead of drawn to a cutting edge. When a chisel bit is used for drilling sandstone the bit is apt to wear sharp. Rock drill bits for use in medium hard rock should have sharp chisel bits, so that if the hardness of the rock increases, the angle of the bit will become more blunt and the cutting edge become shaped to a curve instead of a straight line, which will prevent the chipping off of the corners.—Engineering.

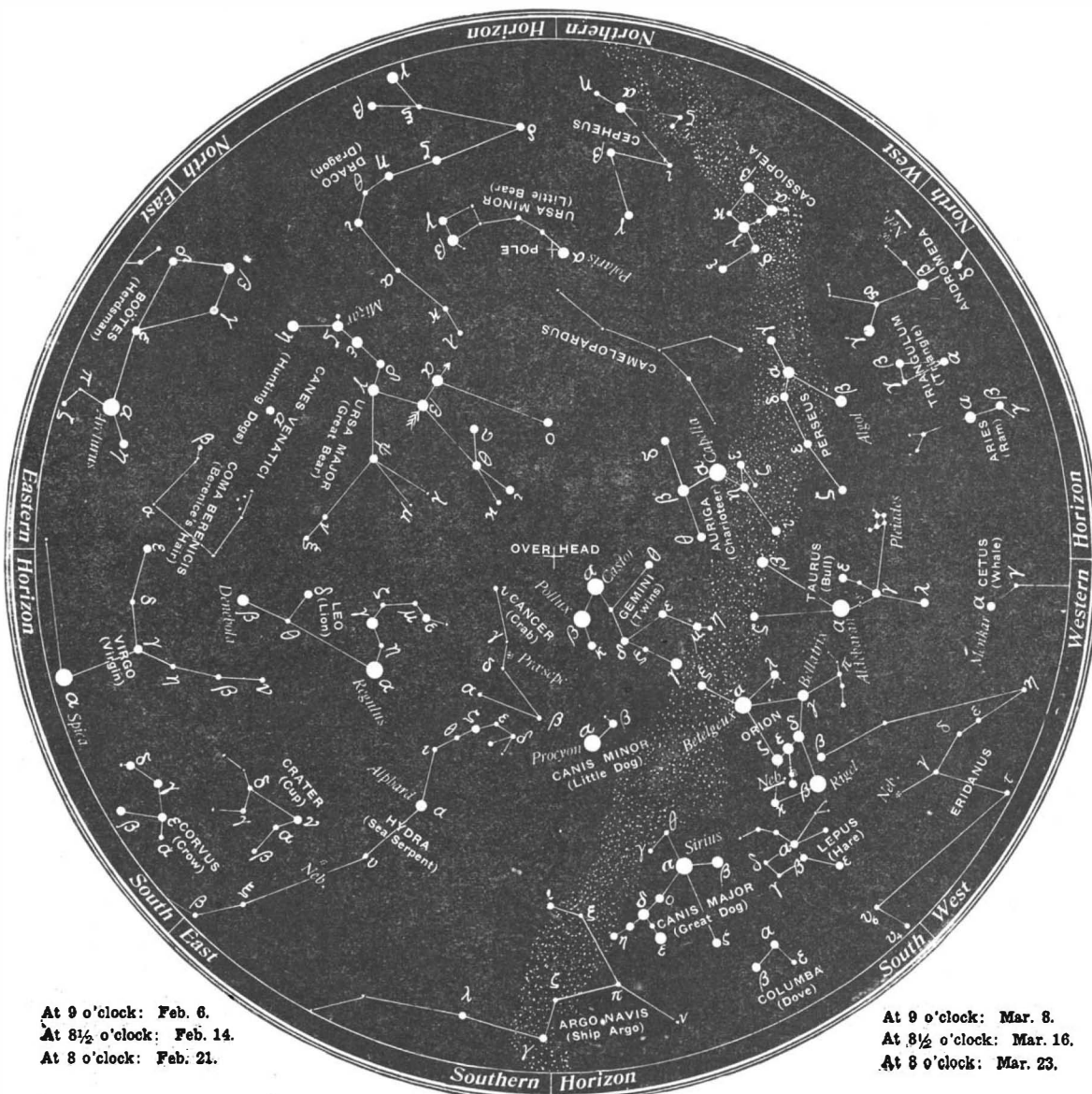

NIGHT SKY: FEBRUARY AND MARCH

At present, however, they are in possession of more and more data, going to show what the material can and what it cannot do.

As regards resistance to frost, Herr Carl Dickow, of Trebitsch, writes that he had a boatload of these blocks which were exposed during the winter to the very severest frost; some of them being partly under water. In the spring, when the snow was gone, the blocks withstood the alternate freezing and thawing action very well.

As regards their weight and lack of porosity, it would be borne in mind that like should be compared with like. It is not fair to compare the weight of sand blocks, standing 3,200 pounds pressure per square inch, with soft inside clay bricks standing only 1,280 pounds, and then complain that the sand blocks weigh a few ounces more than the others. A sand block standing 3,200 pounds pressure should be compared with the so-called "klinkers" or hard-burned brick (for which only 2,000 pounds crushing strength is required). But "klinkers" weigh 10½ pounds against the 7½ to 8 pounds of the sand blocks. And as in any case bricks, as well as other building blocks, are nowadays brought to the place where they are laid by elevators instead of on laborers' shoulders or backs, the question of weight should raise no preju-

EXPERIMENTS WITH RECENT FRENCH AEROPLANES.

The photographs which we reproduce herewith show the Gastambide-Mangin aeroplane in flight and its appearance after the accident which happened during its first test, as well as the constructional details of the new Farman and Bleriot aeroplanes.

The first-mentioned aeroplane was fully described in the SCIENTIFIC AMERICAN of January 18. During the first experiments which were made with it at Bagatelle on February 14, this machine, mounted by M. Boyen, succeeded in making a short flight of about 150 feet. This first flight was so successful that the aviator thought he could do even better. In the subsequent trial, after the machine had run along on the ground for 250 to 300 feet, it rose in the air and covered a distance of nearly 500 feet, though swaying all the while to the right or to the left and varying in its height above the ground continually. The flight was suddenly terminated by a dive sideways, as the result of which the bow and the propeller dug forcibly into the ground, the machine turned a somersault, and came to rest upside down. The resulting damage is apparent from the photographs. The aviator received no serious injury and was able to crawl out of the wreck unaided.

This wrecking of the Gastambide-Mangin aeroplane upon its first test is only a repetition of what has occurred to almost all the other monoplanes that have been built and experimented with abroad, and it would seem to show that this type of machine is extremely dangerous and unstable, even though the constructors make use of the dihedral angle for the purpose of

enhancing its transverse stability. The machine had no horizontal rudder or no balancing tail of any size, and it may have been due to this fact that it made a sudden dive. In their effort to obtain simplicity the constructors evidently failed to provide proper means

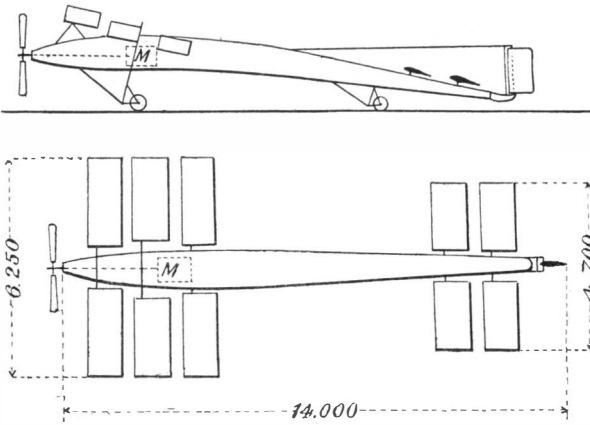

Side and Plan Diagrams of New Farman Aeroplane.

The front planes are not in superposed pairs as shown in upper diagram but are single like those in the rear. The rearmost plane is pivoted to act as a horizontal rudder.

for controlling the longitudinal stability. Even M. Bleriot, who experimented successfully last summer with a Langley type, single-surface, following-plane machine, had several bad falls with his first machines, while, when he changed to a monoplane, this machine was demolished on December 18 last by a fall caused,

however, by the breaking of the wings while in flight. M. Esnault-Pelterie and Count de la Vaulx also suffered bad falls with their monoplane machines; so that this type is now in little favor and is generally thought to be extremely dangerous.

On the other hand, M. Henry Farman made 250 or more flights and landings with his double-surface following-plane machine, without sustaining serious damage in any of the landings. M. Farman, however, has decided to try a new type of machine which he has designed, and a general idea of which can be seen from the diagrams, while the photograph of the body framework shows the length and delicate appearance of this structure. This framework is 14 meters (45.93 feet) long over all including the vertical rudder. Attached to it on each side at the front are three planes arranged in steps. The total spread of the forward planes is 6.25 meters (20.51 feet), while that of the rear planes is 4.7 meters (15.42 feet). The total supporting surface is about 24 square meters (258 1/3 square feet), which corresponds to a loading of the surfaces of 5 1/2 pounds per square foot, if we consider the weight of the machine as 650 kilos (1,433 pounds)—a figure which it will probably exceed. A glance at the photograph will show the comparatively small size of one of the supporting planes, as a frame of one of these planes is seen standing beside the body framework. M. Farman proposes to equip his new machine with either a 50-horse-power Renault, 8-cylinder, air-cooled motor, or with an 8-cylinder, 80-horse-power, Antoinette motor. The speed at which the machine should rise is calculated to be 80 kilo-



Gastambide-Mangin Aeroplane Before Its Accident.

Spread of wings, 32.8 feet; supporting surface, 258 square feet; weight, 880 pounds; propeller, 6 1/4 feet diameter x 4 1/4 feet pitch; engine, 50 H. P., 8-cylinder V motor.

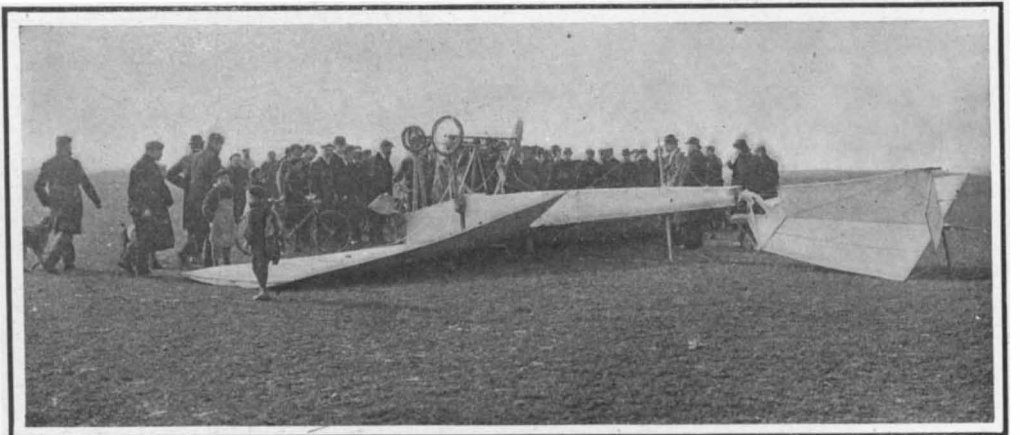

The Aeroplane Upside Down After the Accident.

The relatively small size of the tail, which was broken off in the accident, is noticeable in the above illustration.

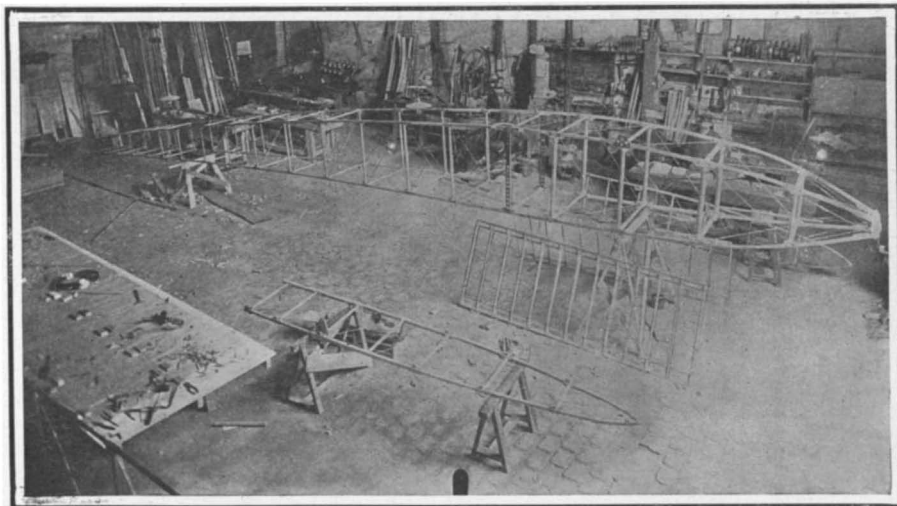

The Body Framework of the New Farman Aeroplane.

The small size of the planes can be seen from the frame of one of these which stands beside the forward saw horse. Length of body about 45 feet.

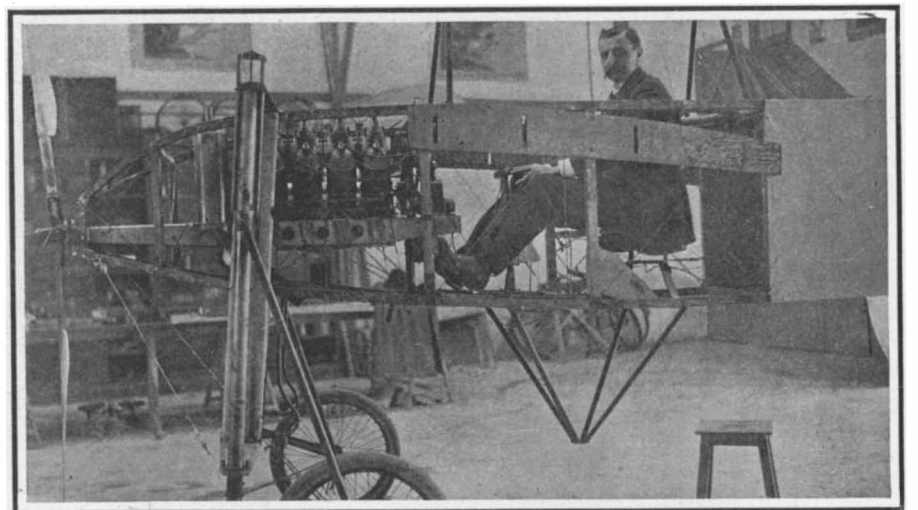

Front End of Body of the New Bleriot Aeroplane.

This photograph shows the spiral-spring mounting of the front wheels and the plate for attaching one of the planes to the body.



The G-M Monoplane in Flight.

The photograph shows the machine tipping to one side before it crashed to the ground.

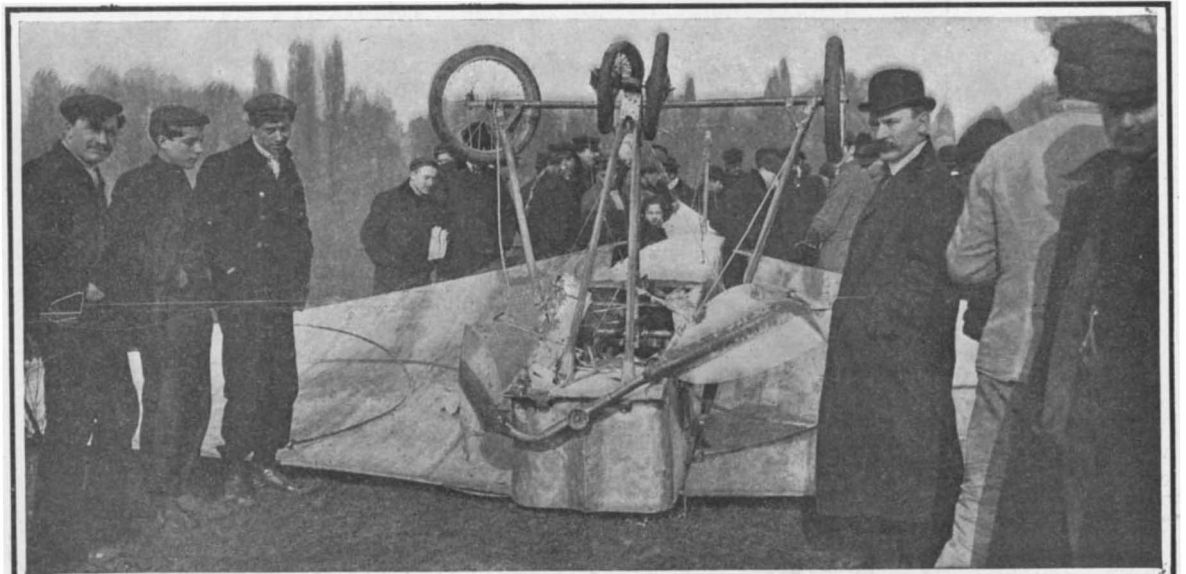

Front View of the Demolished Aeroplane, Showing Damaged Propeller.

The wings are built up on strong wood and aluminium girders and numerous parallel steel strips running in a fore-and-aft direction. Owing to this strong construction, they were not badly damaged.

meters, or 50 miles, an hour. While M. Farman may succeed in flying with this machine, one can readily see that it will be a difficult matter to attain the requisite speed for soaring, and that when he is once in the air, the machine will probably lack stability. Should it upset at any such speed, the aviator runs a

the machine have been carefully withheld, the authorities in order to secure secrecy having established the constructional camp in the midst of the wild mountains of Scotland, whither the component parts of the apparatus, after completion at the balloon factory at Aldershot, are being conveyed for assembling.

PROGRESS OF THE CATSKILL WATER SUPPLY.

Progress on the Catskill water supply, the greatest municipal undertaking of its kind in the world, has now reached a point where it is possible to give some photographic representation of the work being done; and it will be seen from the accompanying views that ground has not only been broken, but that the work of moving the material is, at some points of the line, in full swing. As a matter of fact, about \$20,000,000 worth of work is under contract, in which is included about 11 miles of aqueduct and the great Olive Bridge dam and dikes which are to form the Ashokan reservoir. About sixty million dollars' worth of work is also surveyed and in shape for contracts.

The principal feature of the system, which is designed to bring 500 million gallons of Croton water to New York daily, is the creation, by the construction of the Olive Bridge dam, of a huge artificial basin, which will be known as the Ashokan reservoir, and will impound 130 billion gallons of water. The dam, of which we show several views, will be built partly of solid masonry and partly of earth. The masonry portion of the dam will occupy the center of its length, and will extend for about 1,000 feet. It will be of the

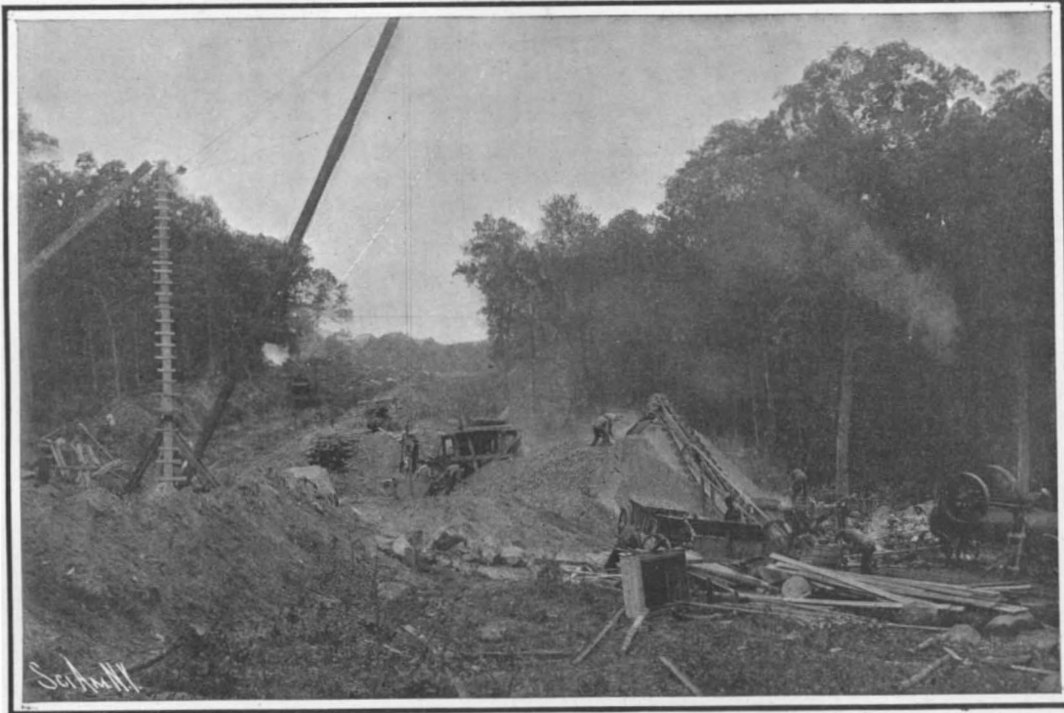

Mixing Concrete for Culvert Under the Aqueduct. Trench for Aqueduct is Seen in the Background.

far greater chance of serious injury than with those aeroplanes that have already met with disaster while traveling at a speed of about 30 miles an hour.

M. Louis Bleriot, whose aeroplane experiments last summer with a Langley-type machine were fully described and illustrated in SUPPLEMENT No. 1654, has, since the demolition of his No. 6 machine, undertaken the construction of two new aeroplanes, and these are now about completed. One of our illustrations shows the front end of the body framework, which in both these new aeroplanes will be twice as long as that of the No. 6, i. e., 14 meters (45.93 feet). The photograph shows the method of attaching the planes and of mounting the motor. The engine shown is an 8-cylinder Antoinette motor of 50 horse-power; but Bleriot expects to try a 16-cylinder motor of the same type and horse-power in the other machine. The body framework is rectangular in cross-section at the front end, as shown, but the rear portion is to be made triangular in shape, similarly to the body of the Antoinette aeroplane of Levavasseur and Capt. Ferber. M. Henry Kapferer, another enthusiastic aviator, has recently completed at Montesson a new Langley-type aeroplane, with which he expects to experiment shortly at Issy-les-Moulineaux.

Aeroplane Developments in Great Britain.

BY OUR LONDON CORRESPONDENT.

During the past year but little investigation in mechanical flight has been effected in Great Britain. For some months past, however, the government has been interested in the construction of a heavier-than-air machine which has been designed by Mr. W. S. Dunn, the experiments with which will be carried out within the next few weeks. Details concerning

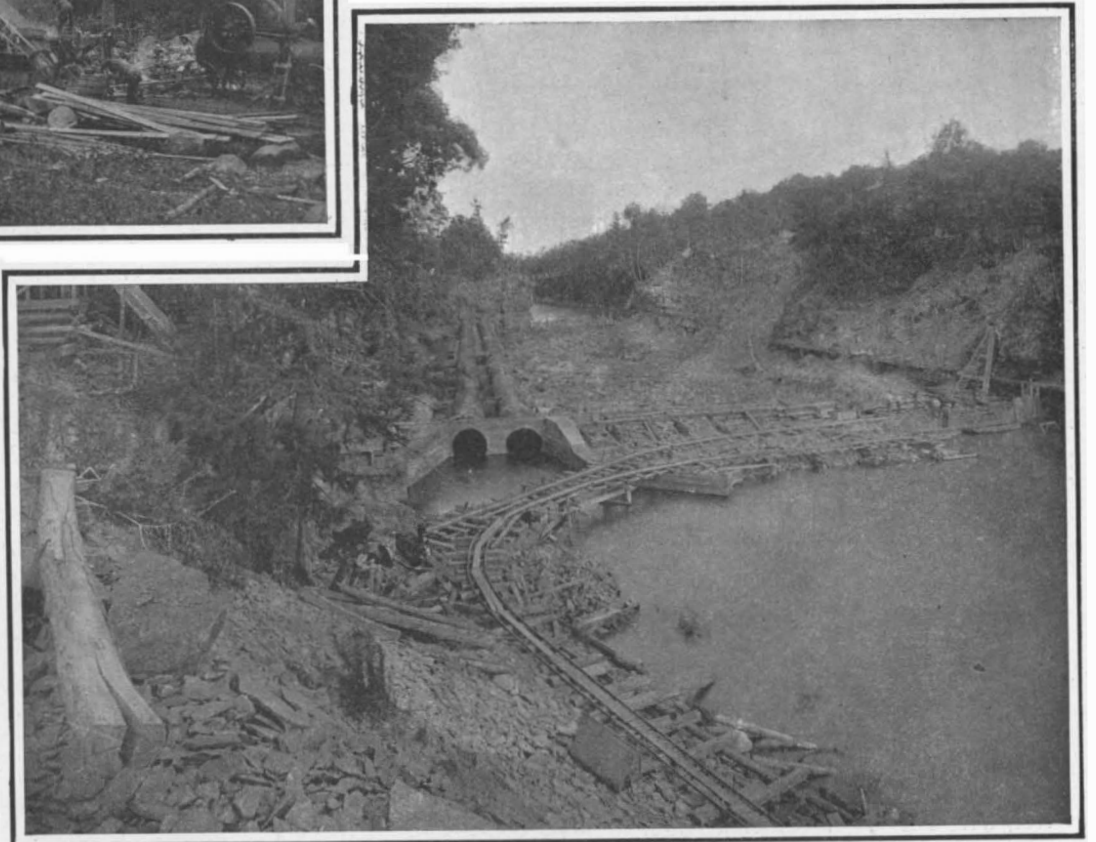

Site of Olive Bridge Dam, Which will be 220 Feet High and 5,650 Feet Long. The Two 8-Foot Pipes Are for By-passing the Esopus Creek During Construction.

The machine is, however, fundamentally based upon the gliding apparatus evolved by José Weiss, but several radical modifications have been introduced. Aluminium tube enters very extensively into its construction, to insure economy in weight while securing an adequate factor of strength, and the planes are covered with a strong thick black silk. Instead of having only two wings, as was the case in the Weiss machine, the present aeroplane has four planes, each about 50 feet in length, disposed in pairs one above the other on either side. The framework is tightly

(Continued on page 166.)

general cross section shown in the accompanying engravings. From foundation to crest it will rise 220 feet in height. The earth-and-core-wall portions of the dam, which will extend from the masonry section to a junction with the sides of the valley, will have a total length of 5,650 feet, making the crest of the dam over one mile in length. In addition to the dam, there will be a series of dikes, which will be built across depressions in the country, where they will be necessary to hold the water up to the desired level. These dikes alone will be on a vast scale, and together with the waste weir will have a total length of 3.8 miles.



Excavation of Trench Preparatory to Building the 17½-Foot Concrete Aqueduct. The Aqueduct Will be Constructed Upon a Carefully-Leveled Foundation and Covered in with Earth Rolled Down in Layers.

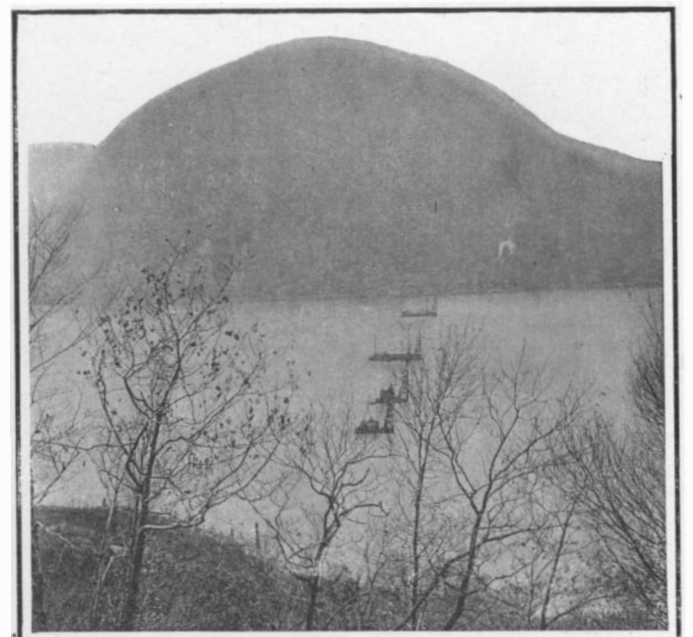

Hudson River at Storm King Mountain, Showing Scows From Which Borings Are Being Made for the Aqueduct Syphon by Which the Water Will Pass Below the River.

The contract for the Olive Bridge dam and reservoir has been let for \$12,000,000, and, as will be seen from the accompanying engravings, the preliminary works at the site of the dam are well under way. As it will be necessary to excavate at the site of the dam down to solid rock, provision has to be made for by-passing the waters of Esopus Creek, and for the present this is being done by means of two 8-foot steel pipes, which are sufficient to take care of the usual flow of the creek. Freshets will, of course, flood the works; but before the excavation is carried down to any considerable depth, the waters of the creek will be taken care of by the construction of a channel along the side of the valley. Ultimately, the water will be allowed to flow through a tunnel formed in the masonry of the dam, which will be closed when the dam is completed. The Ashokan reservoir will constitute a lake of considerable magnitude; for it will be 2 miles in width and 12 miles in total length. Besides impounding the waters of the Esopus, the reservoir will receive those diverted from Schoharie Creek by means of a 10-mile tunnel through the mountains, and from Catskill Creek and adjacent small watersheds through another aqueduct.

From Ashokan reservoir the water will flow by gravity through a concrete aqueduct 17 feet high and 17 feet 6 inches wide to a storage reservoir at Kensico, having a capacity of 40 billion gallons. From Kensico it will flow to a large filtration plant at Scarsdale; whence it will flow to a reservoir at Hillview, Yonkers. The Hillview reservoir will be at sufficient elevation to enable the water to flow by gravity for distribution throughout Greater New York.

In those portions of the aqueduct where the water flows at hydraulic grade, the aqueduct will be built of concrete; but wherever it must cross those deep glacial gorges of which the small channels of such streams as Rondout Creek are only a slight surface indication, tunnels will be driven in solid rock far below the surface of the ground, and lined with concrete. At each end of such tunnels will be a vertical shaft, thus forming a huge inverted siphon. Of such works the most perplexing and costly will be the crossing of the Hudson River at Storm King, where the river is 2,800 feet wide. Although the depth of the river at this point is only 90 feet, the borings, which have been carried down 617 feet, have not yet encountered solid rock. As the aqueduct approaches the river at an elevation of 400 feet above its surface, it follows that the inverted siphon must reach a depth of at least 1,000 feet and Heaven only knows how much deeper than that. One of our illustrations is taken from the easterly shore of the Hudson River looking toward Storm King Mountain, which is seen in the background. The four scows anchored across the river are engaged in boring operations. Of the four borings, one had been driven to a depth of 617 feet when it was lost by the collision of a disabled steamer, which ran down and carried away the scow.

The construction of the masonry portion of the Olive Bridge dam will include some novel features which do not appear in the recently completed Croton dam. One of these is the provision of vertical drainage pipes built into the masonry of the dam for intercepting any seepage water that may enter from the up-stream side. All masonry dams are liable to this seepage, which, passing through the masonry and issuing from the downstream face, produces a gray and white discoloration, which not only is unsightly in appearance, but also gives the impression that the dam is not tight. This seepage will occur in the best constructed dams, and does not in any way indicate poor construction. The location of these vertical drainage pipes is shown in the cross section of the dam, Fig. 1. They terminate at top and bottom in inspection galleries.

Another interesting feature of the dam is the provision, at intervals of every 84 feet of its length, of vertical expansion and contraction joints. These extend from crest to foundation, and are intended to localize the expansion due to changes of temperature, and prevent the occurrence of those unsightly cracks which occur when large masonry masses such as this are cooling down to normal temperature. It will surprise some of our readers to learn that when cement is setting, the temperature of the interior of a large mass of masonry, such as this, will rise to as high

as 130 degrees. From this temperature the mass gradually cools to a normal internal temperature in this climate of say about 50 degrees; and, of course, there is a corresponding contraction of the mass when this takes place. If the dam is built absolutely monolithic, the expansion will produce fine hair cracks at one or more points, and these will not necessarily follow the joints in the masonry, the huge masses of stones themselves being torn asunder during the shrinkage. By providing vertical expansion joints, the strength of the masonry to withstand horizontal thrust of the water is not impaired, and at the same time the total movement due to changes of temperature is divided among a large number of joints and becomes inappreciable at each. The joints are formed by molding concrete blocks with a smooth stepped face, the stepping, of course, running across the dam, transversely to its axis, as shown in Fig. 3. The joint will be washed with some suitable kind of preparation, which will admit of easy separation while at the same time being watertight.

The Largest Proposed French Airship.

The French War Department is actively pushing the construction of the new dirigible "La République," and is expecting to have this new aerial warship ready next May. The 1908 budget includes the construction of two dirigibles of like size, and when these are completed the government will undertake to build several larger airships of nearly twice the size. The plans

Aeroplane Developments in Great Britain.

(Continued from page 165.)

braced with piano wire to secure rigidity. The motive power will consist of two French gasoline motors, in which it has been possible to reduce the weight to approximately 1.5 pounds per horse-power. These engines drive two propellers in opposite directions. In this instance the twin-engine system has been adopted, the power being transmitted through suitable gearing to secure the requisite peripheral speed for the propellers.

The aeroplane is to be mounted upon a lightly-built, four-wheeled bicycle carriage constructed of aluminium, which is driven along the ground in order to secure the necessary impetus to enable the aeroplane to ascend. The greatest difficulty has been experienced in connection with this part of the apparatus. It is essential that it should form part and parcel of the machine, so as to enable it to ascend wherever and whenever desired, but at the same time its presence rather militates against the utility of the apparatus, since in descent it has been found that there is always the liability of the impact with the ground being so severe as to render the bicycle carriage useless for its purpose, thereby preventing an immediately succeeding ascent.

Another smaller aeroplane, or rather motor-propelled kite, is being constructed at Aldershot. This comprises a large model of the successful Cody man-lifting kites, which are now extensively adopted for recon-

noitering purposes instead of the more cumbersome captive balloon, an engine being incorporated in order to impart the necessary "lift" in lieu of the pilot kites. The mechanical equipment installed is sufficiently powerful to force the kite into the air with a man attached. The trials that have been carried out in the constructional building have been completely successful, but no efforts to test the system to ascertain its efficiency under ordinary atmospheric conditions have yet been made, the energies of the establishment being at present concentrated upon the completion of the second dirigible balloon, that is to be tested during the next few weeks.

The trials are also to be carried out shortly upon the Brooklands automobile track with the new Moore-Brabazon aeroplane. This machine in its design is a combination of the Farman and Chanute systems.

There are the two superposed plane surfaces, or wings, together with the smaller front plane to control inclination and declination in the air. Instead of the cellular tail adopted by Farman, and which the latter inventor hopes to abandon entirely, as it acts as a serious drag upon the machine, there is a special contrivance that has been evolved by the builder to insure right and left horizontal steering. A Buchet motor of 25 horse-power drives a propeller of the usual type.

Testing Locomotives.

A new locomotive engine undergoes a thorough test before it is sent out on the road to take its share of work. When a new engine is taken into a shop it is turned over to a mechanic whose duty it is to fit it up and make all connections and adjustments of the interior mechanism. This completed, the engine is turned over to a fireman, who steams it up and blows it off in order to remove any grease that may have accumulated in the boiler, or such foreign substances as might cause a boiler to "foam" while in service. The engine is then turned over to an engineer, whose duty it is to "break" it in. The engine is steamed up again, and if it will run is taken for a little tryout about the yard.

If all goes well and there is no heating in the journals or brasses, the engine is worked for a few hours, and then the steam is again blown off. It is next sent out on a long-distance trip, at a speed varying from one to twenty miles an hour, and drawing about half its full load.

Heating is one of the principal diseases of an engine, and it is this feature the engineer looks to more than anything else. The mechanical sense of the experienced engineer is so developed that he can detect the least defect about his engine.

The Austrian state railroads recently made contracts for 1,754,000 sleepers. Of these 28.9 per cent are to be oak, 26.5 larch, 42.4 fir, and 1.8 beech.

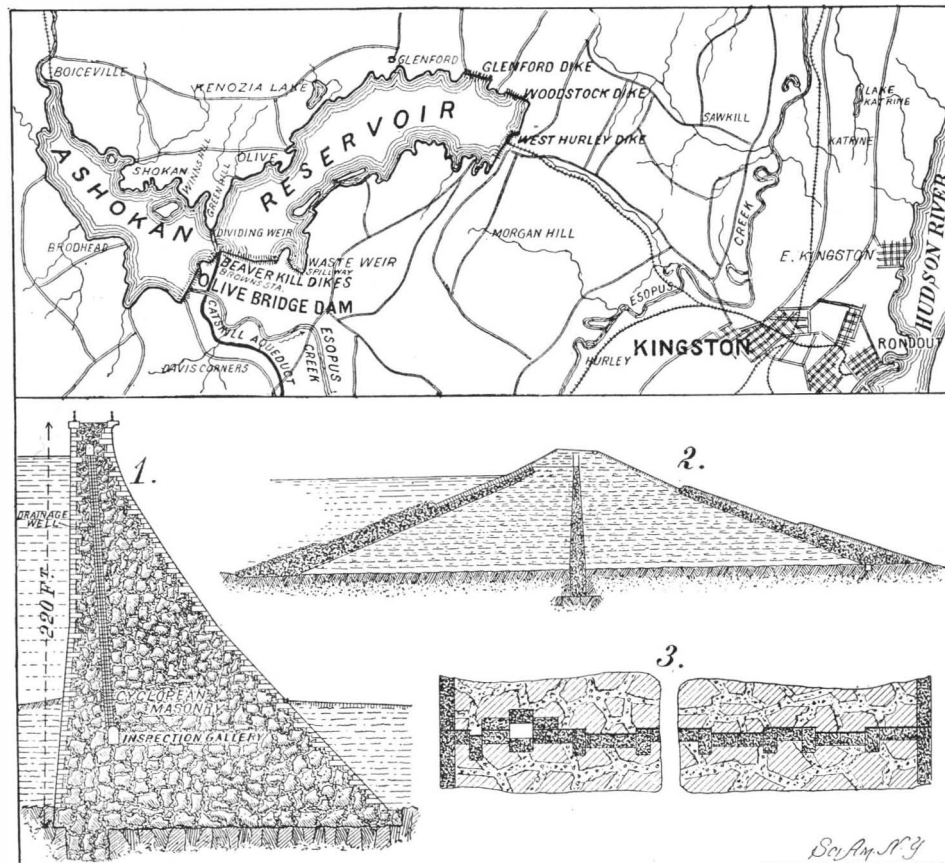

1. Cross-section of masonry portion of dam. 2. Cross-section of earth-and-corewall dam. 3. Horizontal section through an expansion joint in dam.

Plan and Details of the Ashokan Reservoir and Dam.

PROGRESS OF THE CATSKILL WATER SUPPLY.

for the first of these have been drawn up recently by the Lebaudy brothers, and submitted to the War Department. The length of these new airships will be 100 meters (328 feet); the greatest diameter, 11½ meters (37¾ feet), and the capacity between 7,000 and 8,000 cubic meters (247,198 and 282,512 cubic feet). The horse-power will be 240, and will consist of two 120 horse-power, four-cylinder Panhard engines driving two separate propeller shafts extending the entire length of the body and carrying a propeller at each end. Thus, there will be four propellers, two (one at the front and one at the rear) being operated by each motor. In case of a breakdown of either of the engines, the other is sufficiently powerful to drive the airship to its destination.

There are also to be two lifting propellers mounted on vertical shafts for the purpose of obtaining stability under the most adverse conditions. The envelope will be constructed of waterproof fabric supported upon a rigid frame in a similar manner to that of the Zeppelin airship, while the ballonette to allow for expansion and contraction will also be retained.

Following out the plan of the Italians Crocco and Ricaldoni to use their hydroplane gliding boat with aerial propellers as the body part of a new Italian dirigible which is being constructed, it is proposed to use the motor boat "Panhard-Tellier," which has its engines already installed, as the body part of the new French dirigible. It is expected to obtain a speed of 60 kilometers (37.28 miles) an hour. The lifting power of the new airship will be in the neighborhood of eight tons.

Correspondence.

Trap-Door Spiders' Nests.

To the Editor of the SCIENTIFIC AMERICAN:

To me Mr. Hutchinson's article on tarantulas was interesting. Confined to a valley by an injury, I made a recreation of locating trap-door spiders' nests. I have found three nests to the square foot, but only once; they are often many yards from their nearest neighbor. The entrance is usually on a slope of about 45 degrees, from $\frac{1}{2}$ inch to $\frac{3}{4}$ inch in diameter, and is down 3 to 4 inches; then it inclines upward and then down again, where it expands to 2 or 3 inches in diameter. The walls are covered with three thicknesses of web resembling tissue paper. The doors are of many thicknesses, with hinge on the upper side.

If the nest has been in existence but a short time, moss, grass, or whatever happens to be growing near, will be found eking out an existence in the soil placed in the concave lid, making the searcher look very diligently. A door can be built and covered with earth in one night, but the fit is not so good as when done less hurriedly.

A stick $\frac{1}{2}$ inch in diameter, 7 inches in length, placed in the open door was removed in a night, as were also two pebbles and a rough piece of clay, weighing from one to two ounces, which were placed to support the stick. I never found more than one adult in a nest, although I have found several half grown and once an adult with scores of young the size of bird shot.

JOSEPH HAZELL.

N. San Diego, Cal., January 28, 1908.

Tideman and the Experimental Model Basin.

To the Editor of the SCIENTIFIC AMERICAN:

I read with great interest the "Simple Explanation of Model Basin Methods," by D. W. Taylor, naval constructor, U. S. N., published in your issue of December 7, 1907, the "Ten Years of the United States Navy" number.

Notwithstanding the historical part of this article is reduced to the most simple facts, I was sorry to perceive it is not anywhere stated that the Dutch government was the first to follow the basin experiments of Mr. William Froude, by constructing a model basin at the Amsterdam dock yard more than thirty years ago. The basin was built and the first experiments were made by Mr. B. J. Tideman, at that time chief naval constructor of the Dutch navy. According to information received from one of my friends, a naval architect, the results of these experiments, obtained in 1875-76, were published in the "Memoriaal van de Marine" (Memorial of the Dutch Navy). Further data are given by P. Dislère in his "Exposé Sommaire des Expériences faites à Amsterdam sur la résistance des Carènes," 1878; C. Busley in his work, "Die Schiffsmaschine," Vol. II., 1886; J. Pollard and A. Dubeout in their treatise, "Théorie du Navire," 1894.

The Dutch installation rendered great service in many directions. Even the Russian government had recourse to it, not only for defining the form, but also for calculating the resistance of the well-known "Livadia."

It is generally acknowledged that in regard to speed, predicted by Mr. Tideman, the "Livadia" was quite a success.

J. K. E. TRIEBART, C.E.

Nijmegen, Holland.

[It is well known that Tideman made a number of model experiments and also valuable experiments on plane friction. In Naval Constructor Taylor's "Resistance and Propulsion," published nearly fifteen years ago, are tables giving coefficients of frictional resistance obtained by Tideman. Tideman, however, made his experiments, not in a model basin, but in a dock in the Royal Dockyard at Amsterdam, using more or less improvised and temporary appliances, some of his apparatus following along the lines of Beaufoy, who made experiments in the Greenland dock at Deptford more than a hundred years ago. It appears certain from consulting one of Tideman's original papers that some of his model experiments were made in a dock over a portion of which there was a shed open at one end. He speaks of having been careful to avoid making experiments on windy days and gives the specific gravity of the dock water. It is quite possible to make model experiments without having a model basin, and the French made model experiments many years ago in a dock at Brest, although they did not build a model basin until a year or so ago. Many people have made model experiments in open water—Herreshoff, for instance, in this country. It does not seem, from the best information, that Tideman's experiments were made in a model basin, or that the Dutch navy ever built a regular model basin.

With reference to the "Livadia," it may be remarked that, in addition to Tideman's model trials, a good-sized boat representing the "Livadia" and supplied with its own power was built by the contractors for the "Livadia" and tested near Glasgow, just as the contractors for the "Mauretania" in the last few years built a 50-foot self-propelled model of the vessel.]

II.—THE BRITISH NAVY OF TO-DAY.

About ten years have elapsed since the SCIENTIFIC AMERICAN published a series of articles on the leading navies of the world. On December 7, 1907, we devoted a special issue of the SCIENTIFIC AMERICAN to a description of the American navy of to-day; and we now propose to publish, at stated intervals, a series on the leading navies of the world, which will enable our readers to compare our standing with that of the other great powers. In the interval which has elapsed since the Spanish war, the growth of naval power has been something phenomenal. During the same decade, and mainly as the result of the lessons of the Japanese war, there has been a marked change in the theory of warship design and construction. The big battleship, armed exclusively with heavy guns, has taken a more commanding position relatively to other types of ships than it held before. It is realized to-day, more than ever, that it is the big, heavily-armed ship, carrying a large number of the heaviest weapons, that will be called upon to decide the issues of future naval campaigns. Certain types of ship, which ten years ago were popular, and were built in large numbers and of great size, have become practically obsolete. New types have been developed; and increased importance has been given to certain other types which were formerly considered of subordinate value.

The ideal navy of to-day concentrates the greatest part of its numbers and displacement in battleships; and to these all other types of vessel are considered as auxiliary. Next in importance to the battleships are the armored cruisers; but the latest design of these has become so large and powerful, that they have merged into the battleship class, and the indications are that as a distinct class the armored cruiser will soon disappear. The fleet of the future will consist of battleships, fast scouting vessels, sea-going torpedo boats, and submarines. The protected cruiser has had its day and those that exist will be retained merely for scouting purposes and the protection of sea-going commerce.

The policy of Great Britain, as affecting the relative strength of its navy, is the same to-day as ten years ago. She aims to maintain a navy which will be fully equal to that of any other two naval powers; a task which, because of the rapid growth of her competitors, is becoming exceedingly onerous.

SUMMARY.—In the present articles we shall follow the method of classification adopted in the well-known Brassey's Annual, and include under the head of first-class battleships, all those which are less than twenty years old and of 10,000 tons displacement or over. On this basis we find that the British navy possesses in battleships built or nearing completion, fifty-five first-class battleships of an aggregate displacement of 809,450 tons. Of second-class battleships and coast-defense ships she has eleven, of an aggregate displacement of 113,780 tons. Of first-class cruisers, ranging from 9,800 tons to 17,250 tons displacement, and from 20½ to 25 knots speed, she has forty-eight of an aggregate displacement of 584,750 tons. Thirty-eight of these vessels are of the armored cruiser type, and ten of them are protected cruisers. She has twenty-seven second-class cruisers of from 5,600 tons to 7,700 tons displacement, and from 19 to 20 knots speed; and their aggregate displacement is 169,510 tons. Of third-class cruisers she possesses forty-six ships aggregating 148,735 tons, whose displacement varies from 2,135 tons to 4,360 tons, and the speed from 19 to 22 knots. Her torpedo-boat destroyer fleet includes 160 vessels of from 240 to 800 tons displacement, and from 25 to 37 knots speed. Her submarine fleet consists of sixty-one boats built or building, varying in displacement from 120 to 500 tons, and with a speed on the surface of from 8 to 16 knots.

BATTLESHIPS.—Among the fifty-five battleships of the British navy, the oldest are the eight ships of the "Royal Sovereign" class, built under the Naval Defense Act and launched in 1891 to 1892. Because of their great size, they created a sensation somewhat similar to that which marked the appearance of the "Dreadnought;" for they were a great advance upon any existing battleships. They are of 14,100 tons displacement, and on trial the "Royal Sovereign" made a speed of between 18 and 19 knots. They are protected by an 18-inch belt of compound armor, which covers about two-thirds of the length of the vessel amidships, but they have no belt armor at the ends, where protection is afforded only by a curved but heavy protective deck. They are what are known as "soft-ended ships," and, as the fate of the "Osliabia" proved at Tsushima, they would be at the mercy of a well-directed heavy-gun fire striking their unarmored ends. They carry four 13-inch low-velocity guns, in barbets which afford protection to the gun carriage and turning gears, but none to the guns themselves. The secondary armament consists of ten 6-inch guns mounted in closed 6-inch armor casemates, five on each broadside. The present sea speed of these ships is from 14 to 15 knots an hour. One of the class, the "Hood," was built with her 13½-inch guns mounted in turrets on the main deck. Her freeboard is only about 12

feet, and she is, consequently, a wet ship in heavy weather. The "Barfleur" and "Centurion," of about 11,000 tons displacement and 18.5 knots trial speed, carry four 10-inch and ten 6-inch guns. They are protected by a partial 12-inch belt of compound armor. They were launched in 1892, and, though fast, are not considered to be ships of great value to-day. A little larger than these is the "Renown," of 12,350 tons and 18 knots trial speed, whose main armament consists of four 10-inch guns. She is not of any greater value than the "Barfleur," and at present is used as a naval yacht for the conveyance of dignitaries to distant stations. The next important battleships were those of the "Magnificent" class of nine ships, launched between 1894 and 1896. They are of 14,900 tons displacement, and mark a considerable advance in fighting efficiency over the "Royal Sovereign" class. In them for the first time Harveyized armor was adopted, of which they carry a 9-inch belt amidships; but they also are soft-ended vessels. The main armament consists of four 12-inch 35-caliber and twelve 6-inch 40-caliber guns. The belt is carried up in its full thickness to the main deck, and the waterline protection is amplified by carrying the sloping edge of the protective deck down to the bottom of the belt, the slopes being 4 inches in thickness. Except for the soft ends and the comparatively low velocity, 2,300 feet per second, of the 12-inch guns, these are excellent ships for their time, having the large coal capacity of 2,000 tons with an additional storage for 400 tons of oil.

The "Canopus" class of six ships, launched between 1897 and 1899, are about 2,000 tons smaller than the "Magnificent" class but they have a higher speed and a larger coal supply. On trial they made from 18 to 18½ knots, and they have a maximum storage capacity of 2,300 tons of coal. To secure these last qualities the armor was seriously cut down, the belt, which in these ships is continuous, having a maximum thickness amidships of only 6 inches, although it is assisted by a protective deck which is 2½ inches on the slopes. They carry four 12-inch 35-caliber guns in barbette turrets, protected by 12-inch and 8-inch armor, and twelve 6-inch 40-caliber guns in casemates of 5-inch armor. In the next six ships, of the "London" and "Formidable" classes, the displacement was raised to 15,000 tons and the sea speed to about 18½ knots, a speed which has been equaled and even exceeded on their recent sea trials while in service. They are protected by continuous belts, which are 15 feet wide by 9 inches in thickness, and in these ships the first use was made of Krupp armor. Back of the 9-inch belt are the slopes of the protective deck, which are 3 inches in thickness. They mount a powerful wire-wound 12-inch gun of 40 calibers length and 2,750 foot-seconds velocity. Each ship carries four of these in 12-inch barbets with 10-inch turret protection. The secondary battery consists of twelve 6-inch 45-caliber guns, mounted behind 6-inch armor, in completely inclosed casemates. These are among the best ships in the British navy. They are fast steamers, and have a coal capacity of 2,100 tons. They are well protected, and the armament of high-velocity, wire-wound guns is up-to-date.

Next in order of construction are the five battleships of the "Duncan" class, all launched in 1901. These are among the best steamers in the British battleship fleet; for they made recently in a sea trial, while on active service, speeds of from 19.4 to 20.1 knots. Their displacement, however, is 1,000 tons less than the preceding class, and, since they carry the same armament, protection had to be sacrificed, and the thickness of the belt was cut down to 7 inches, with a 2½-inch sloping deck.

In 1902 the battleships "Queen" and "Prince of Wales" were launched. In them the displacement was raised to 15,000 tons and the thickness of the belt was restored to 9 inches; the armor in these, as in the three preceding classes, being of Krupp steel. The 12-inch 45-caliber guns are mounted in 12-inch barbets, with 10 inches of armor on the turrets. Twelve 6-inch 45-caliber guns are mounted in separate, completely inclosed, casemates, with 6 inches of armor on the face. The sea speed on the last trials was respectively 18.2 and 18.6 knots.

In 1903 the government purchased from Chili two battleships which are now known as the "Swiftsure" and "Triumph." They are of 11,800 tons displacement, and the armor plan shows 10 inches on the barbets, 8 inches on the turrets, and a 7-inch continuous belt. The 7-inch side armor is carried up amidships to the upper deck, from main turret to main turret, and behind this protection are mounted ten 7½-inch 50-caliber guns, while in four casemates on the upper deck are four more of the same weapon. The main battery consists of four 45-caliber 10-inch guns. This is an exceedingly powerful armament, the 7½-inch gun firing a 200-pound projectile with a velocity of 2,800 feet per second. The ships have a sea speed of over 19 knots an hour, and they carry a maximum supply of 2,000 tons of coal.

In the "King Edward VII." class of eight ships,

launched between 1903 and 1905, the big armor-piercing gun makes its appearance for the first time in this navy in the secondary battery. The ships are of 16,350 tons displacement, and the armament consists of four 45-caliber 12-inch, four 45-caliber 9.2-inch, and ten 6-inch guns. They have a 9-inch belt, above which is a wall of armor 8 inches and 7 inches in thickness extending to the upper deck. The 12-inch guns are mounted in 8-inch armored turrets above 12-inch barbettes, and the 9.2-inch guns are carried in four 7-inch armor turrets, two on either broadside. The ships carry 2,150 tons of coal and 400 tons of oil, and they have a sea speed of from 18.7 to 19.4 knots an hour.

From now on the influence of the Japanese war is shown in the British designs. The next two battleships, the "Lord Nelson" and the "Agamemnon," have about the same displacement as the "King Edward VII." class, and they are of the "all-big-gun" type. They mount four 12-inch 40-caliber guns in 8-inch armor turrets on 14-inch armored barbets, and upon the same upper deck they carry ten 9.2-inch 45-caliber guns in five single 7-inch armor turrets. The armor protection is excellent, consisting of a continuous belt 12 inches thick amidships, with 7 inches of armor protection extending from the belt to the upper deck. The sides of these ships, therefore, are unpierced by any gun ports, and all the guns are carried within turrets, and from 25 to 27 feet above the water. The ships are of 18.5 knots speed. The excellent photograph which we show of the "Agamemnon" was furnished us by the builders, Hawthorn, Leslie & Co., Ltd., Newcastle-on-Tyne, who inform us that her speed on her recent trial was 18.8 knots an hour.

The "Dreadnought," which has been accepted by the navies of the world as the type of ship of the future, marks a great advance in size and power over any previous battleship. With an overall length of 520 feet and a normal displacement of 17,900 tons, she mounts ten 12-inch guns of the new 45-caliber pattern, with a velocity of 2,900 feet a second. The forward guns are carried on a forecastle deck whose freeboard is 28 feet. On either broadside, aft of these, is a two-gun turret. The other two turrets are mounted on the axis of the ship, as shown in the illustration. The belt is 11 inches thick, with a 2 3/4-inch protective deck. The barbets have 11 inches of armor, and the turrets 8 inches. She is driven by four turbines at a speed of about 21 knots an hour. Three similar ships to the "Dreadnought," with about 700 tons greater displacement, and mounting a more powerful 12-inch gun of 50 calibers length, are nearing completion, and three

others, to be known as the "St. Vincent" type, of between 19,000 and 20,000 tons displacement, have recently been laid down.

SECOND-CLASS BATTLESHIPS.—The second-class battleship and coast-defense vessels are of such doubtful value as to call for no detailed description here. It is not unlikely that several of them will be used for similar target practice to that which was recently carried out on the old battleship "Hero."

ARMORED CRUISERS.—The first armored cruisers to be built for the British navy were the six 12,000-ton 22 1/2-knot vessels of the "Cressy" class. Their leading characteristics are a 6-inch belt from bow to after casemates, a 3-inch deck, 6-inch protection (all of this armor being of the Krupp type) on the barbets, and 5 inches on the casemates. All of the armored cruisers have a raised forecastle deck, giving a freeboard of from 28 to 30 feet forward. In the "Cressy" class, one

and one aft, and ten in 4-inch armored casemates. These vessels can stow 1,600 tons of coal and 400 tons of oil, and they are remarkable for their high sea speed, which in the last trial on service ranged from about 23 1/2 to 24 1/2 knots an hour. In 1903 to 1904 six ships of the "Hampshire" class were launched. They are of 10,850 tons, and protected by a 10 1/2-foot belt 6 inches amidships. They carry four 7.5-inch 45-caliber guns in four 5-inch armor turrets and six 6-inch guns in casemates. They stow 1,800 tons of coal, and have a speed of about 23 1/2 knots an hour. In 1904 followed the "Duke of Edinburgh" and "Black Prince," of 13,550 tons and about 22 1/2 knots speed. They have a 6-inch belt, and are armed with six 9.2-inch 50-caliber guns in six turrets and ten 6-inch 50-caliber guns mounted behind 6 inches of continuous side armor. Similar to these in speed, displacement, and protection are the four ships of the "Warrior" class, which mount

six 9.2-inch 50-caliber guns in six 6-inch armor turrets and four 7.5-inch 50-caliber guns also in separate 6-inch armor turrets. These ships are of 23 knots speed, and carry 2,000 tons of coal and 400 tons of oil.

In 1906 followed the three powerful ships of the "Minotaur" class, of 14,600 tons displacement, 23 knots speed, storing 2,000 tons of coal and 400 tons of oil. They mount four 9.2-inch 50-caliber guns in two 2-gun turrets, one forward and one aft behind 6-inch armor, and ten 7.5-inch 50-caliber guns in ten 6-inch armor turrets, all guns being mounted on the forecastle or the upper deck and having a command of from 25 to 32 feet. There are now nearing completion the three mammoth armored cruisers of the "Invincible" class, of 17,250 tons displacement, designed to be driven at 25 knots by turbine engines of 41,000 horsepower. Their armament consists of eight 12-inch

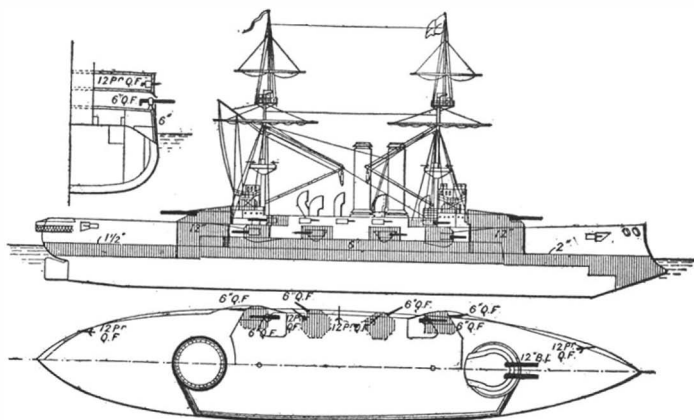

Displacement, 12,950 tons. **Speed,** 18.5 knots. **Coal,** 2,900 tons. **Armor:** belt, 6-inch; side, 6-inch; deck, 2 1/2-inch; barbettes turrets, 8-inch to 12-inch; casemates, 5-inch. **Guns:** four 35-caliber 12-inch; twelve 40-caliber 6-inch; ten 12-pounders. **Torpedo tubes,** four. **Date,** 1898.

Battleship "Canopus." Class of Six Ships.

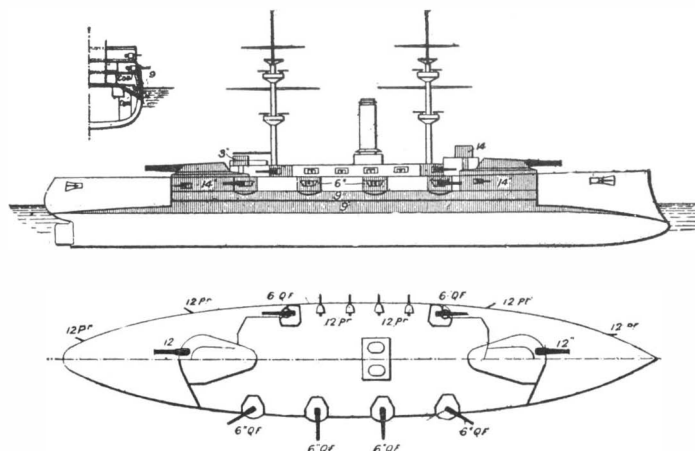

Displacement, 14,900 tons. **Speed,** 17.5 knots. **Coal,** 2,000 tons. **Oil** 400 tons. **Armor:** belt, 9-inch; barbettes turrets, 10-inch to 14-inch; deck, 4-inch; casemates, 6-inch. **Guns:** four 35-caliber 12-inch; twelve 40-caliber 6-inch; sixteen 12-pounders. **Torpedo tubes,** five. **Date,** 1895.

Battleship "Magnificent." Class of Nine Ships.

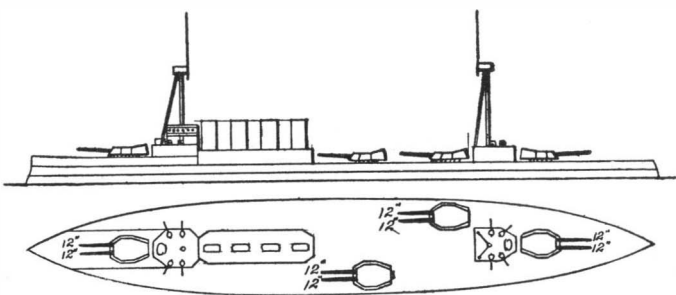

Displacement, 17,250 tons. **Speed,** 25 knots. **Coal,** 2,500 tons. **Armor:** belt, 7-inch; side, 6-inch; turrets, 9-inch. **Guns,** eight, 45-caliber, 12-inch. **Date,** 1907.

Armored Cruiser "Invincible." Class of Three Ships.

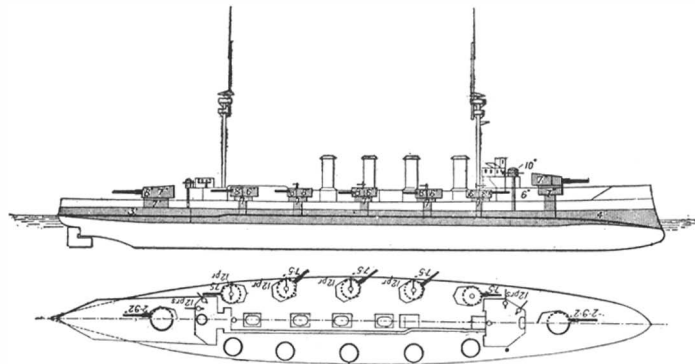

Displacement, 14,600 tons. **Speed,** 23 knots. **Coal,** 2,000 tons. **Oil,** 400 tons. **Armor:** belt, 6-inch; side, 6-inch; deck, 1-inch; turrets, 6-inch to 7-inch; **Guns:** four 50-caliber 9.2-inch; ten 50-caliber 7.5-inch; sixteen 3-pounders. **Torpedo tubes,** five. **Date,** 1906.

Armored Cruiser "Minotaur." Class of Three Ships.

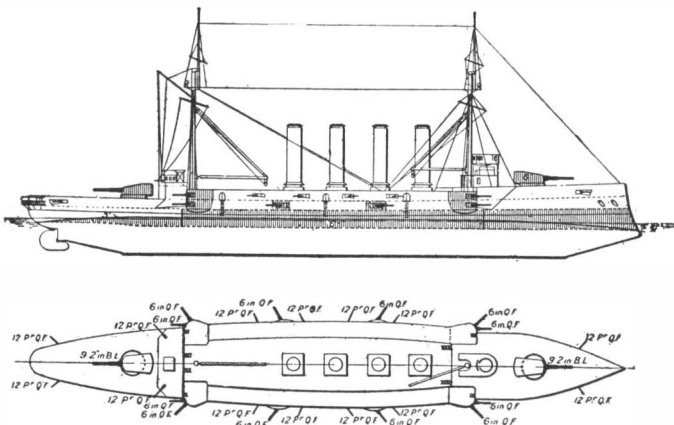

Displacement, 12,000 tons. **Speed,** 22.5 knots. **Coal,** 1,600 tons. **Armor:** belt, 6-inch; deck, 3-inch; turrets and casemates, 6-inch. **Guns:** two 40-caliber 9.2-inch; twelve 45-caliber 6-inch; twelve 12-pounders. **Torpedo tubes,** two. **Date,** 1900.

Armored Cruiser "Cressy." Class of Six Ships.

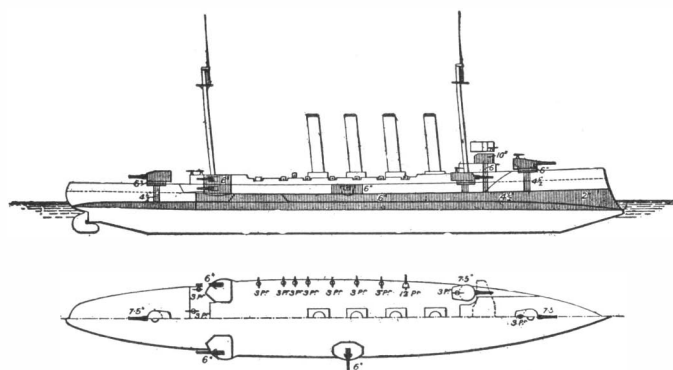

Displacement, 10,850 tons. **Speed,** 23 to 24 knots. **Coal,** 1,800 tons. **Armor:** belt, 6-inch; deck, 2-inch; turrets and casemates, 6-inch. **Guns:** four 7.5-inch; six 6-inch; two 12-pounders; twenty-two 3-pounders. **Torpedo tubes,** two. **Date,** 1903.

Armored Cruiser "Hampshire." Class of Six Ships. Also Ten Ships Somewhat Less Powerful.

THE BRITISH NAVY OF TO-DAY.

9.2-inch 40-caliber gun is mounted on the forecastle deck and another aft on the quarter deck. The secondary battery consists of twelve 45-caliber 6-inch guns in casemates on the gun and berth decks. These six ships were launched from 1899 to 1901.

In 1901 the fine and very fast vessels of the "Drake" class were launched. The particulars are: Displacement, 14,100 tons; speed, 23 1/2 to 25 knots; battery, two 9.2-inch 45-caliber and sixteen 45-caliber 6-inch guns; and the armor consists of a 6-inch belt, a 3-inch deck, and 6 inches of protection on the barbets and casemates.

Between 1901 and 1903 were launched ten armored cruisers known as the "County" class, of 9,800 tons displacement, with an 11 1/2-foot belt 4 inches thick amidships, and carrying fourteen 6-inch 45-caliber guns, four in two 5-inch armor turrets, one forward

45-caliber guns, mounted in four turrets so disposed that six guns can be fired ahead or astern and eight on either broadside. These ships are to have about 7-inch waterline protection, and they will be practically battleships in their powers of offense and defense.

PROTECTED CRUISERS.—The protected cruiser has had its day, and in the British navy none of its class has been built for some years. Great Britain possesses no less than eighty-three of this type, ranging in displacement from 2,135 tons to the 14,200 tons of the "Powerful" and the "Terrible." The larger vessels carry two 9.2-inch guns in turrets and from twelve to sixteen guns in casemates. Their future duties will be confined to scouting; the convoy and protection of merchant ships; and to station duty. They will never lie in the line of battle, except against vessels of their own class. It is probable that during the next few years the majority

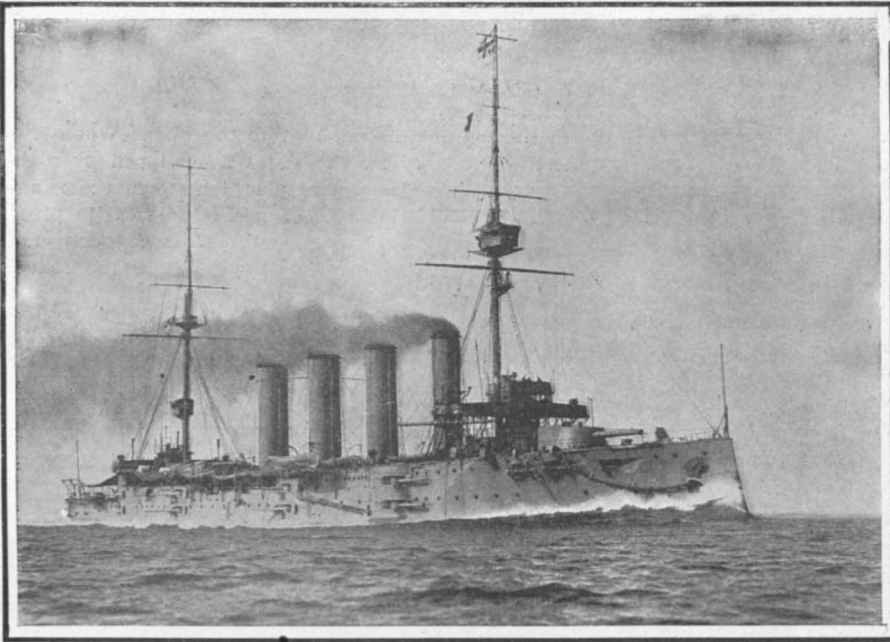

Displacement, 14,100 tons. Speed, 24.5 knots. Coal, 2,500 tons. Armor: belt, 6-inch; side armor, 6-inch; turrets and casemates, 6-inch. Guns: two 45-caliber 9.2-inch; sixteen 45-caliber 6-inch. Torpedo tubes, two. Date, 1901.
Armored Cruiser "Good Hope." Four Ships.

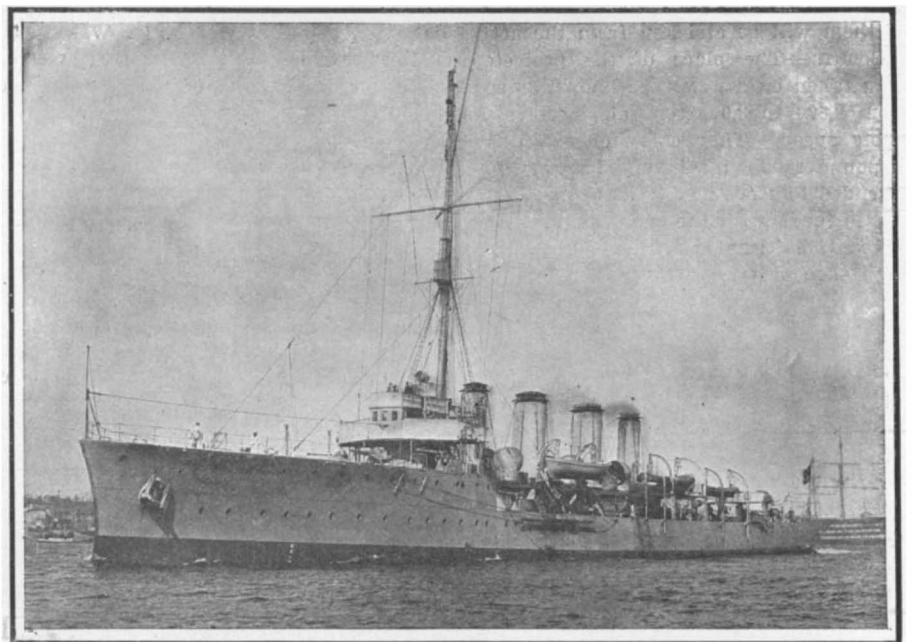

Displacement, 2,670 tons. Speed, 25.6 knots. Coal, 380 tons. Armor, 2-inch deck. Guns: ten 12-pounders; eight 3-pounders. Torpedo tubes, two. Date, 1904.
Scout "Attentive." Six Ships.

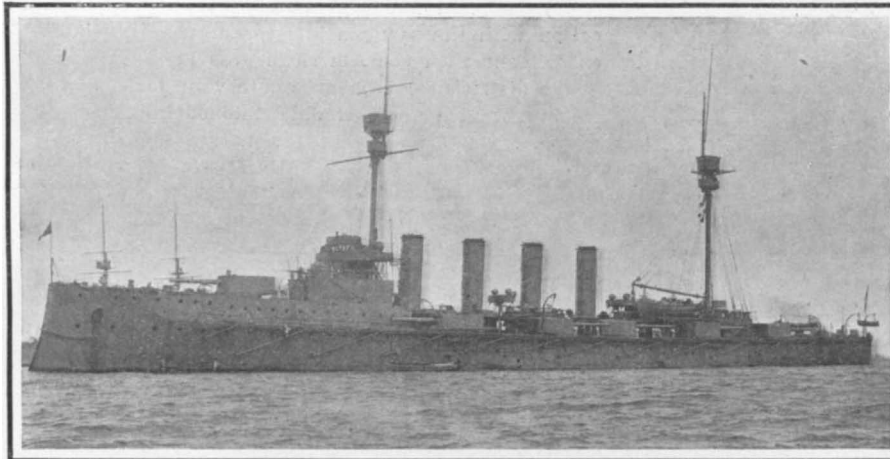

Displacement, 13,550 tons. Speed, 22.5 knots. Coal, 2,000 tons. Oil, 400 tons. Armor: belt, 6-inch; side, 6-inch; deck, 1-inch; barbette turrets, 6-inch to 7-inch; casemates, 6-inch. Guns: six 50-caliber 9.2-inch; four 50-caliber 7.5-inch; twenty-five 3-pounders. Torpedo tubes, three. Date, 1905.
Armored Cruiser "Achilles." Four Ships.

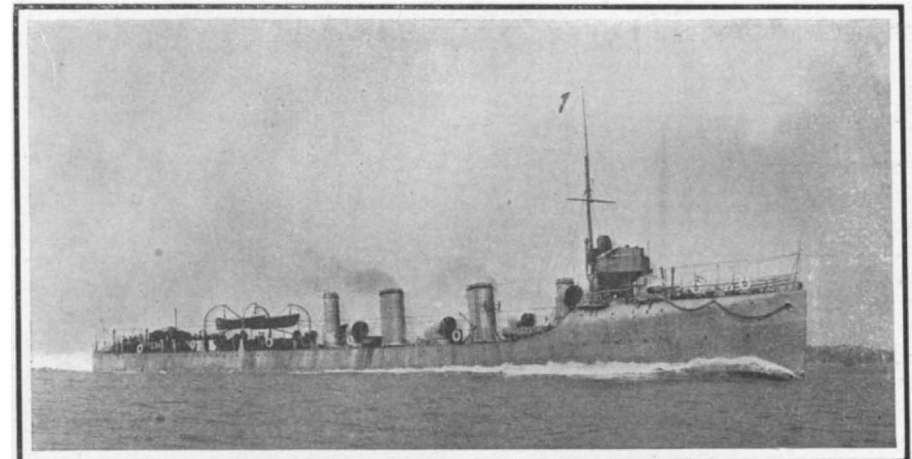

Displacement, 765 tons. Speed, 34 to 36 knots. Oil, 95 tons. Guns, three 12-pounders. Torpedo tubes, two. Date, 1907.
Destroyer "Mohawk." Five Boats.

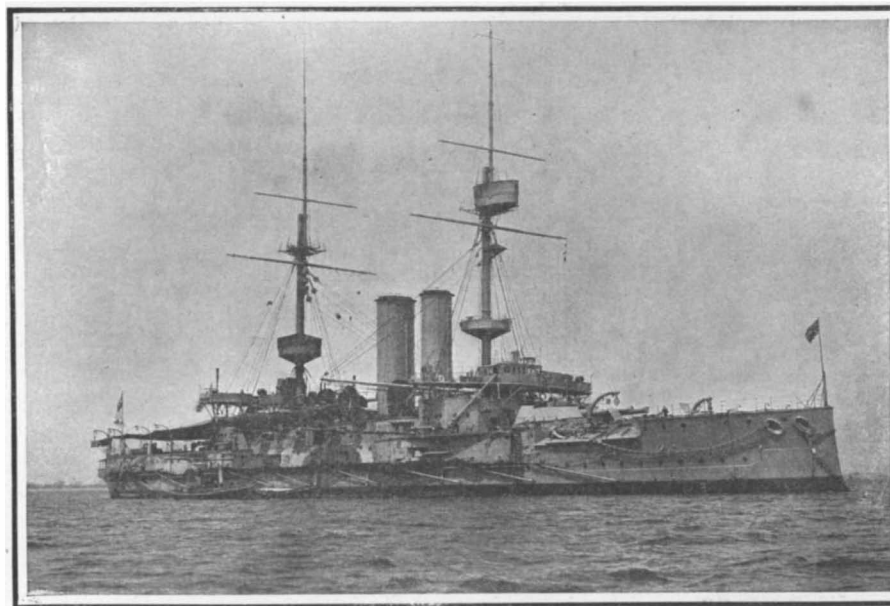

Displacement, 12,950 tons. Speed, 18.5 knots. Coal, 2,300 tons. Armor: belt, 6-inch; side, 6-inch; deck, 2 1/2-inch; barbette turrets, 8-inch to 12-inch; casemates, 5-inch. Guns: four 35-caliber 12-inch; twelve 40-caliber 6-inch; ten 12-pounders. Torpedo tubes, four. Date, 1898.
Battleship "Ocean." Six Ships.

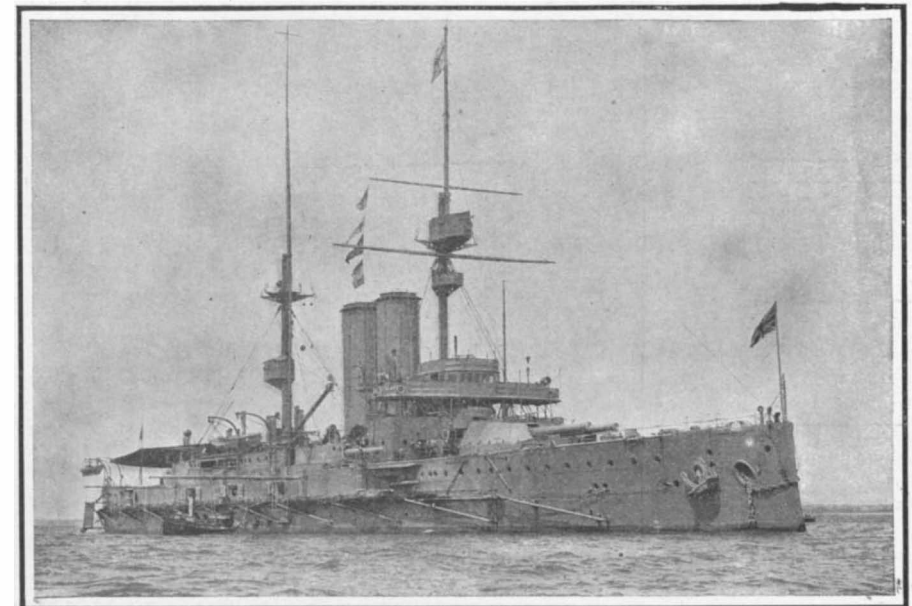

Displacement, 16,350 tons. Speed, 19.4 knots. Coal, 2,150 tons. Oil, 400 tons. Armor: belt, 9-inch; deck, 2-inch; side armor, 7-inch to 8-inch; turrets, 12 inch and 7-inch. Guns: four 40-caliber 12-inch; four 45-caliber 9.2-inch; ten 6-inch. Torpedo tubes, five. Date, 1903.
Battleship "King Edward." Eight Ships.

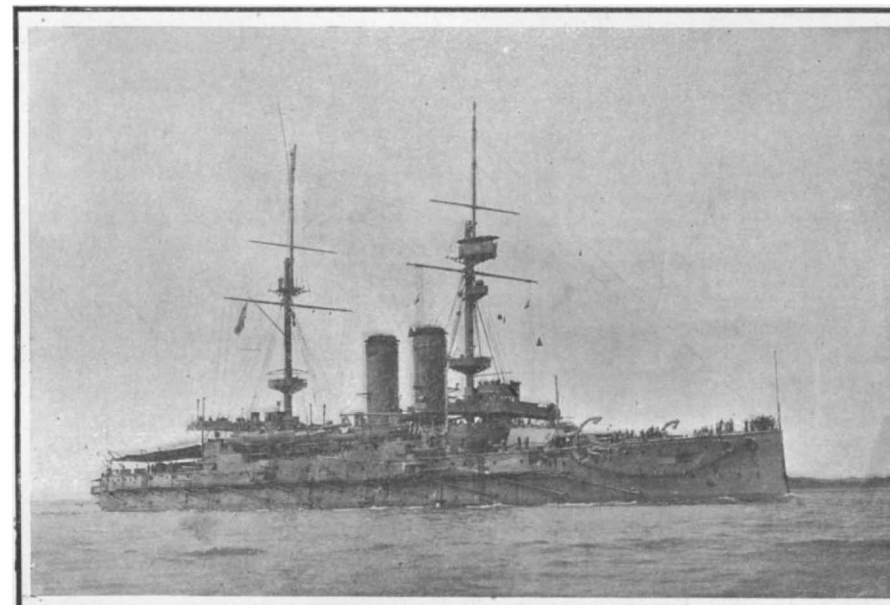

Displacement, 14,000 tons. Speed, 19.5 knots. Coal, 2,000 tons. Armor: belt, 7-inch; side, 7-inch; deck, 2 1/2-inch; barbette turrets, 6-inch to 11-inch; casemates, 6-inch. Guns: four 40-caliber 12-inch; twelve 45-caliber 6-inch; sixteen 12-pounders. Torpedo tubes, four. Date, 1901.
Battleship "Russell." Five Ships.

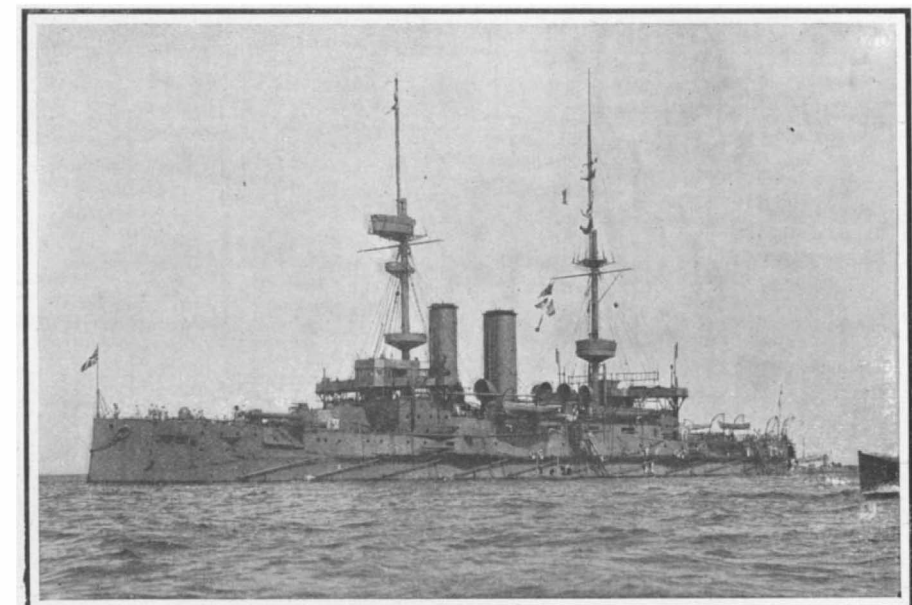

Displacement, 15,000 tons. Speed, 18.5 knots. Coal, 2,100 tons. Armor: belt, 9-inch; side, 9-inch; deck, 3-inch; barbette turrets 10-inch to 12-inch; casemates, 6-inch. Guns: four 40-caliber 12-inch; twelve 45-caliber 6-inch; sixteen 12-pounders. Torpedo tubes, four. Date, 1898-1902.
Battleship "Bulwark." Eight Ships.

of them will be stricken from the active list.

SCOUTS.—The place of the protected cruisers has been taken by a new type known as scouts; vessels of from 2,800 to 3,000 tons displacement and 25 to 25½ knots speed. They carry only a light armament of 12-pounders to repel torpedo-boat attack. They are intended to serve merely as the eyes of the fleet, keeping in touch with the enemy and bringing the fighting element, battleships and armored cruisers, into touch with each other. Great Britain possesses six of these vessels. Because of their small coal supply of only 380 tons, they are considered to be of doubtful value. The new ships of this class will be enlarged, to enable them to carry enough coal for extended operations with the fleets.

DESTROYERS.—The British navy possesses a fleet of destroyers of exceptional speed and good seagoing qualities. It is impossible within the limits of this article to describe these ships in any detail. They range in size from the early vessels of about 270 tons displacement and 27 knots speed up to the latest, of what is known as the "Tribal" class, which are of about 800 tons displacement and 35 to 37 knots speed. The majority of the boats are of about 350 tons displacement and 30 knots speed. In 1903 to 1905 the size was increased to 550 tons, the scantling was made heavier, and the speed lowered to 25½ knots, the idea being to provide vessels of stancher build and better seagoing qualities. Some thirty-four of this type were built; but in the latest "Tribal" class, above referred to, the length has gone up to 272 feet, the horse-power to 14,500, and the maximum speed to from 35 to 37 knots. A destroyer, the "Swift," is now under construction, which is 345 feet in length and is designed for a speed of 36 knots with 30,000 turbine horse-power. The later and larger destroyers are all driven by Parsons turbines, and the boilers fired with oil fuel.

SUBMARINES.—When England once took up the construction of submarines, she developed the type with characteristic energy. She now possesses forty of these vessels completed, and has twenty-one others proposed or under construction. The vessels already built or building range from 120 tons to 500 tons displacement, from 8 to 16 knots surface speed, and from 7 to 9 knots speed submerged. The first five were of the Holland type, and out of this the government evolved what is known as the Admiralty type, which combines the principles of both the Holland and the Lake submarine, the regulation of horizontal control being assisted in the later submarines by the use of hydroplanes.

The Current Supplement.

The use of pneumatic tools in iron foundries is the subject of the opening article of the current SUPPLEMENT, No. 1679. Although the action of the various constituents of the atmosphere on copper, tin, zinc, and their alloys is of great practical importance, it has never been studied systematically. The first step in this study has been made by Eduard Jordis and W. Rosenhaupt for oxygen. The results of their investigations are given. Those who advise women to adopt the profession of engineering should read Karl Drews's article on Women Engineers. He very clearly outlines the magnitude of the obstacles which women must surmount. Mr. R. T. Strohm writes on boiler blow-off connections, and gives various diagrams of the systems now used. The theory of high-speed tool steel is discussed by George Auchy. Sand hogs and the work they do constitute the subject of a very interesting article, in which the caisson foundations of sky-scrapers are described. A short but valuable article is that which tells now at the expense of a dollar or so a Nodon valve may be constructed, which connects through any lamp socket with the alternating system and serves as a rectifier. C. K. Francis shows how much water is required for the setting of Portland cement. The geology of the inner earth and the formation of iron ores is the subject of a paper by Prof. J. W. Gregory.

Hudson-Fulton Celebration.

At a recent meeting of the Hudson-Fulton Celebration Commission, it was voted to hold the celebration in 1909 one week later than planned, making it begin on Saturday, September 25, in order to insure a greater probability of good weather. It was decided to hold the official literary exercises in the Metropolitan Opera House on Tuesday evening, September 28, with possibly other meetings in the other boroughs.

According to *The Engineer*, amalgams for the frictional parts of electric machines are combinations of quicksilver, tin, and zinc. The quicksilver is heated to 302 to 392 deg. F., transferred to a wooden box, the melted tin and zinc added to it, the box closed by a lid and mixed by vigorous shaking. The proportions of the mixture, according to Singer, are (a) 6 parts of quicksilver, 2 parts tin, 1 part zinc; (b) 7 parts quicksilver, 4 parts zinc, 2 parts tin; various other proportions of these ingredients are sometimes used.

A SIMPLE WIRELESS TELEGRAPH DETECTOR.

BY FRANK J. KENNEY.

One of the requisites of a good wireless telegraph detector of the crystal type, is that it be so constructed as to permit easy removal and substitution of different metals for the electrodes, as different metals sometimes produce different results.

The necessary parts of a simple yet very efficient wireless detector are as follows: A base, of the dimensions shown in Fig. 1; 3 inches of ½-inch round brass rod; 4 inches of 3/16-inch round brass rod; some brass tubing, 3/16 inch inside diameter; two thumb nuts of brass or hard rubber, and two binding posts.

The 3/16-inch rod is cut into two equal parts, and both pieces threaded to within ⅜ inch of one end. The other rod is also cut into two equal parts, mak-

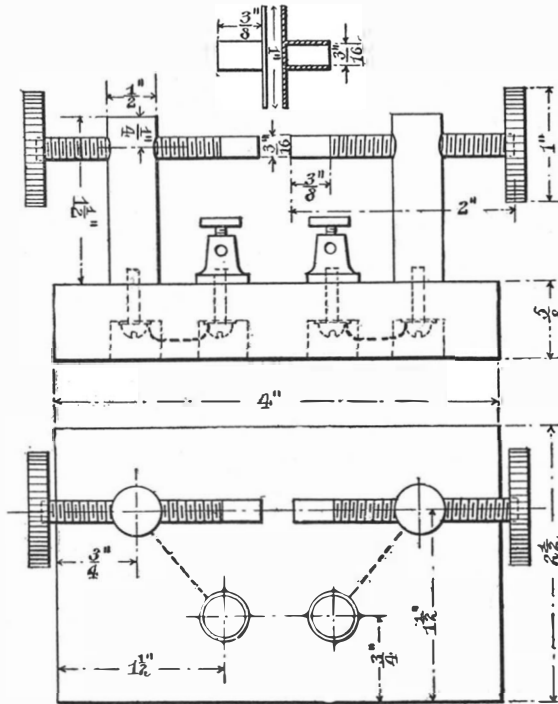

Fig. 1.—Details of the Construction of the Wireless Telegraph Detector.

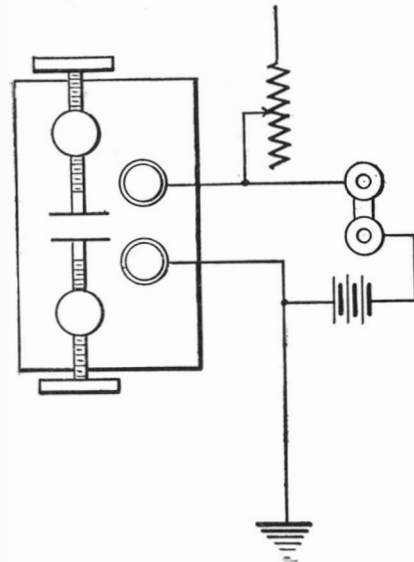
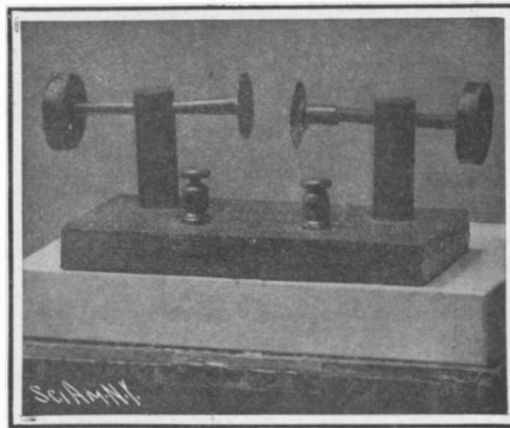

Fig. 2.—Electrical Connections of the Wireless Telegraph Detector.



A SIMPLE WIRELESS TELEGRAPH DETECTOR.

ing a pair of standards. At ¼ inch from the top of each of the standards a hole is drilled and tapped to receive the smaller rods. The other end of each standard must also be drilled and tapped to receive a machine screw, by which it is fastened to the base. The positions of the standards on the base are indicated on the drawing. The smaller or pressure rods are screwed in the holes on the standards, with the untapped ends facing each other, and the thumb nuts, having previously been tapped to fit the rods, are screwed on them.

The binding posts must now be mounted on the base, and connected to the standards by wires run underneath the base.

To make the removable electrodes, the brass tubing is cut in ⅜-*inch* lengths. One-inch disks of 1/16-*inch* brass, copper, and other metals are cut out, and at the exact center of each is soldered one of the brass tubes, with its length perpendicular to the disk. When it is desired to use them, the tubes are slipped over the ends of the rods, a crystal placed between them, and the rods screwed up so as to hold the crystal in place. Carborundum and silicon are the most common crystals, although there are many others that produce excellent results.

An American Agricultural Mission.

BY S. C. STUNTZ.

The demand for our young men as instructors in farm practice for other nations, whether for the tropical cultures of Liberia, for tobacco culture in South Africa, or for other cultures elsewhere, is attracting so much attention at present, that we incline to think of the position of the United States as instructor as something new. Nothing, however, is farther from the truth than this.

As early as 1813, but twenty years after Eli Whitney's invention had made possible the profitable production of cotton on a large scale in our Southern States, the Madras Presidency, realizing the American supremacy in cotton producing, sent out Bernard Metcalfe, who had had considerable practice in cleaning cotton with the saw gin in Georgia and Louisiana, to experiment with the American gins in several Indian cotton districts. His labor was in vain, for the natives would not give up their old-fashioned implements for the gin. The churka, as the native implement was called, consisted of two slightly separated rollers turned by hand, which, while removing the seeds, left the cotton matted, with fibers running in different directions, and entirely failed to remove the bits of leaf and broken seeds and other trash.

After Metcalfe's attempt, the Madras government continued its efforts to improve the domestic cotton and to naturalize New Orleans cotton until 1840, when the Court of Directors, resolved on making a further attempt to bring the Indian cotton up to successful competition with the American, sent Capt. Bayles of the Madras army to the South to secure ten planters or overseers to instruct the natives in the cultivation and cleaning of cotton. These planters were to receive \$1,500 per annum and a gratuity in case of success.

The captain, fearing opposition, succeeded in keeping his secret for some time, but when he had engaged a few planters, and bought a sixty-saw gin, a model gin-house, and other necessary machinery, the matter leaked out. The Natchez papers of April, 1840, with their numerous editorials and communications, show the jealousy with which the southern planters looked upon the British enterprise. Capt. Bayles was unable to get any planters in Georgia or South Carolina, and finally went to Mississippi and Louisiana, where he obtained eight and two respectively. Of these, the Mississippi Free Trader and Natchez Weekly Gazette of April 9, 1840, speaks as follows:

"Those persons who have lent themselves, or rather sold themselves, body and soul, for English pound sterling, will leave our shores (if they ever leave them) with the undisguised hate and scorn and execration of every southern man in the United States."

One of the correspondents of this paper sees in this movement, following as it did the British abolition of slavery, a menace to the slave-holding population of the United States.

No serious results followed the threats of the paper, though the captain felt it necessary to carry arms in fear of a personal attack. The captain and the ten planters arrived at their destination in October, 1840, after a stop in London. The results of their experiments, which closed in 1853, showed that American cotton could be grown, but with questionable profit; that Indian cotton might be improved, but only slightly; that American cotton would always command a higher price than Indian; and that the demand for the Indian cotton would always depend on the supply of the American. The planters who undertook the work all returned to the United States with the exception of one, who died at his work in 1846.

This interesting example of early agricultural mission effort will show the difference in point of view between 1840 and the present day, when we welcome every opportunity to share our trained students of agriculture with the rest of the world, in the realization that we are in every way the gainers from such acts of apparent altruism.

Ivory-Colored Enamel for Iron Goods.—Melt a mixture of 125 parts of pulverized flint glass, 20 parts of calcined soda and 12 parts of boracic acid. The molten mass is poured onto a stone or metal surface, allowed to cool and pulverized. A mixture of this powder and soda water-glass solution of 50 deg. B., to which about 8 parts of oxide of tin have been added, is poured over the objects to be enameled, which are then heated in a muffle until the entire mass is uniformly melted.

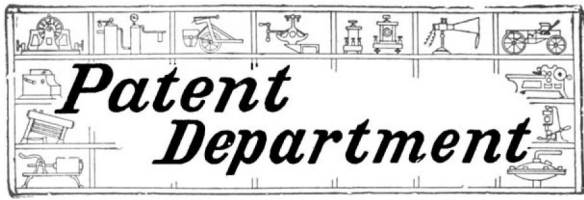

IMPROVED NUT LOCK.

A patent has just been issued on an improved nut lock which we illustrate in the accompanying engraving. The device may be used in any connection, but is particularly adapted for rail joints to prevent the nuts from working loose on the bolts which fasten the fish plates in position. The device comprises a plate *A*, which in practice is placed against the fish plate and is formed with openings to admit the bolts. The nuts are screwed on to the bolts and against the plate *A*. To retain them in this position locking rings *B* are provided. As shown in the detail view

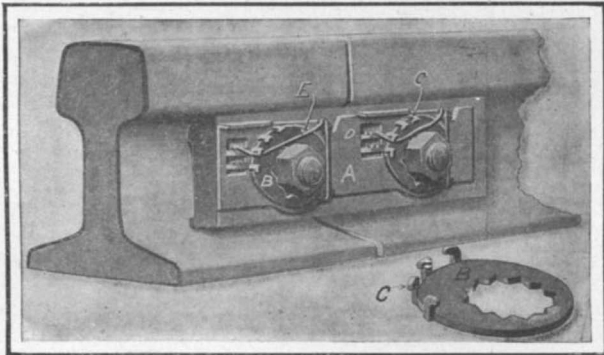

IMPROVED NUT LOCK.

these are formed with notched openings, the arrangement of the notches being such as to enable the locking ring to engage the corners of a hexagonal, or a square nut, or a similar nut in different positions. At a suitable point on the outer edge of the locking ring, a number of outwardly projecting fingers *C* are provided. The locking rings are fitted over the bolts as shown in the illustration. To the left of each locking ring the plate *A* is punched to form transverse bars *D* with serrated upper edges. A wire *E* which is made fast to the plate *A* at one end is hooked under one of the fingers *C* and its outer end is caught in one of the bars *D*, thus preventing the locking ring from turning and holding the nut in set position on the screw. The method of attaching the wire *E* to the plate is rather interesting. The wire is formed with a vertical section hooked both at the top and bottom. The plate is provided with tongues bent outward to form pockets in which the hooked ends of the wire are seated. To one side of the upper pocket a notch is cut in the plate so that in attaching the wire the lower end is first hooked and then the upper end is passed through the notch and laterally moved into the pocket. A patent on this nut lock has been secured by Mr. C. B. Stillwell, of Jacksonville, Florida.

STAMP-AFFIXING MACHINE.

A machine has recently been invented for quickly and accurately affixing postage stamps to letters and other matter. The machine comprises two frames, *A* and *B*, which are hinged together. The handle is secured to the frame *B*. A spring *C* is mounted between the frames *A* and *B*, on a screw which limits the relative motion of the two frames. The stamps are rolled with a strip of oiled paper on a spool which is contained in a casing *D*, and a spring bearing on the roll provides the necessary tension. The strip of oiled paper is carried down under the frame *A*, and at the forward end thereof is taken up on a spool *E*. The

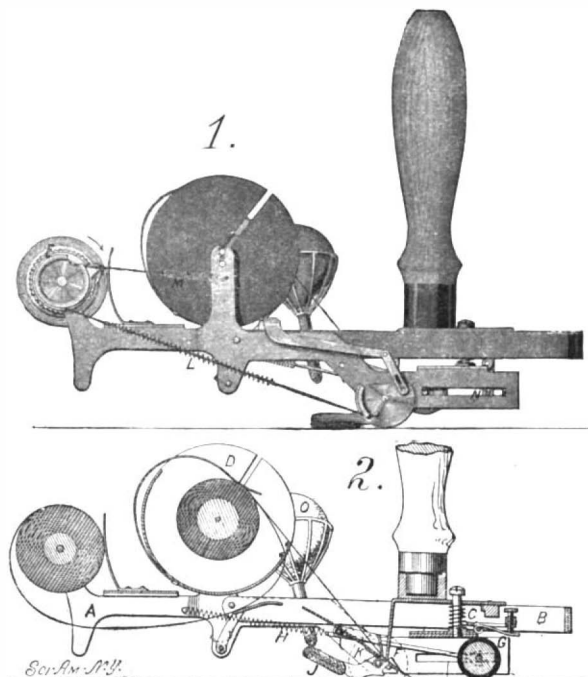

STAMP-AFFIXING MACHINE.

strip of stamps is conducted down through a throat *F* and close to a roller *G*, which is held in the normal position illustrated in Fig. 1 by springs *H*. A moistening pad *J* is provided directly in front of the roller *G* and this is connected to a pair of wheels *K*. The latter are flattened at one side. Connecting the wheels *K* with a drum on the shaft which carries a spool *E* is a cord *L*, provided with a spring. This drum carries a pawl which engages a ratchet on the spool *E*. A spring *M* connects the opposite side of the drum with the frame *A*. In use the operator rolls the machine forward, on the wheels *K*, thereby turning the spool *E* to take up the slack in the oiled paper, and also turning the spool which carries the stamps. When the flat part of the wheel *K* is encountered the machine will drop, and moistening pad *J* will be lifted out of contact with the letter, on which the stamp is to be affixed. The roller *G* will then be brought into contact with the letter and will press the stamp on to the moistened part. At the same time the roller *G* will travel bodily toward the rear of the machine and spring a trigger *N*, permitting the frame *B* to drop and bringing a depending plate thereon against the stamps close to the throat *F*. This will hold the stamp strip and cause the stamp to be detached therefrom. At one side of the machine a bulb *O* is provided in which water is kept to moisten the pad *J*. The inventor of this stamp affixing machine is Mr. Herman J. Wertzberger, of Alma, Kansas.

IMPROVED PLANE PROVIDED WITH ADJUSTABLE GUIDES.

The improved plane which we illustrate herewith is provided with adjustable means to limit the depth to which the cut of the plane may proceed. Guide blades are provided at each side of the plane which may be quickly adjusted. Means are also furnished for limiting the projection of these blades. In our illustration the body of the plane is shown at *A*. A recess is formed in the body to admit the blade or iron, and the side of the body is cut away, forming an opening through which shavings cut by the blade can leave the tool. Secured to one side of the plane is a guide plate *B*. The latter is made fast by a pair of screws which pass through slots in the plate and thus permit of any desired degree of adjustment of the plate below the sole of the plane. In the forward end of the tool a block is mounted to slide vertically and it may be moved to the desired adjustment by means of a thumb screw. Adjustably secured to this block by means of screws are a pair of guide blades *C*. The guide blades in operation form parallel grooves or guides exactly within and between which the main iron follows and cuts the shavings. The motion of these guide blades is limited by shoulders on the blades and the plane. Directly in front of the guide blades at one side is an auxiliary guide or supplemental sole *D*. This is secured to the lower end of a rod *F*. A transverse pin *E* formed with a cam groove is adapted to bear against the rod *F* and hold the latter at the desired adjustment. A pin *G* engages a second groove in the transverse pin *E* and serves to retain the latter in the tool. The plane is provided with the usual rack and pinion adjustment of the plane iron and a thumb screw serves to lock the blade in the set position. The inventor of this plane is Mr. Andro Nylund, of 5514 Nicolett Street, West Duluth, Minn.

AN IMPROVED WASHING MACHINE.

The washing machine illustrated in the accompanying engraving is provided with improved means for enabling the working parts to be brought into rubbing contact with both sides of the fabric which is being washed, and at successively different points thereon, so that the entire piece of material may quickly and thoroughly be renovated. The machine comprises a suds box *A*. At the forward end of the machine are two upright frame members *B*, each formed with a slot *C*. Mounted to slide in these slots is a corrugated rubber board *D*. The frame which carries this board is connected to a crank *E* at the upper part of the machine. The crank is secured to the hub of a wheel *G*, which is geared to an internal gear *F*. By turning the wheel *F* the crank *E* is revolved, causing the rubber board *D* to vibrate up and down. Facing the board *D* is a second corrugated board *H*. The latter is secured to a frame *J*, which is held in suspension by a pair of links *K*. The upper link *K* is made fast to a square shaft which carries a lever *L*, and by operating this lever the board *H* may be moved toward or from the board *D*, as desired. The lever *L* may be hooked in the rack *M*, to hold the board *H* at the desired position. Journalled in the frame members *J* are a pair of rollers *N*. The upper roller is mounted to slide in vertical grooves, and springs *O* serve to press it against the lower roller *N*. The tension of each spring may be regulated by operating a hand wheel, as indicated in the illustration. In use after the garments have thoroughly been soaked the board *H* is rocked away from the board *D* to permit placing the garments between the boards. The lever *L* is then adjusted to press the garments between

the boards and by means of a crank handle the rollers are turned to draw the material downward. The board *D* is now reciprocated to rub the garment and occasionally the rollers are turned to bring a fresh surface into contact with the rubber boards. A patent on this washing machine has just been secured by David A. Sawyers, of Unionville, Iowa.

Annual Loss Caused by the Cattle Tick.

It has been calculated that the cattle tick causes an annual loss in this country of nearly \$100,000,000,

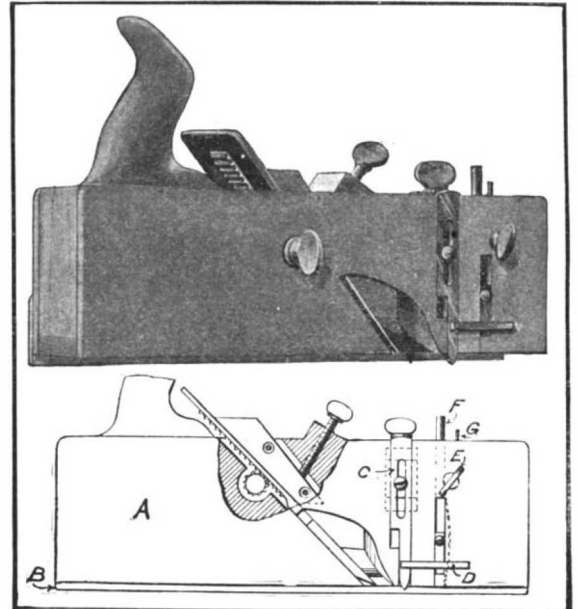

IMPROVED PLANE PROVIDED WITH ADJUSTABLE GUIDES.

according to a report of the Department of Agriculture. The loss foots up to at least 10 per cent of the value of the cattle raised every year. The quality of the stock attacked is lowest and the loss is the greatest in the regions where, without the tick, the natural conditions are most favorable to the production of the finest cattle with the least loss. This insect makes profitable cattle raising almost impossible in the South, and as any successful system of agriculture must be grounded upon an alternation of crops which, in turn, depends upon animal husbandry to maintain the fertility of the soil, our entire national system of agriculture is affected. Until this pest is destroyed, or at least controlled, the agricultural development of the infested regions is impossible.

Capt. Robert T. Lawless, who for many years has been in the employ of the Oceanic Steamship Company, has been proposed for membership in the Royal Geographical Society of England, owing to his invention of the stellar azimuth machine. This instrument solves spherical triangles mechanically, and with absolute accuracy, and makes unnecessary the use in navigation of an azimuth table. Capt. Lawless believes that every officer of every passenger liner should understand stellar navigation. The compass, he says, is the most useful of instruments, but the most frivolous and vacillating, and requires constant watching and testing. The compass should be checked up every four hours, and even then it may play tricks on the most experienced navigator. However, the stars are always true beacons, and the navigator who can steer by star sight, says Capt. Lawless, can be as sure of his course as if he had cross-bearings between two lights.

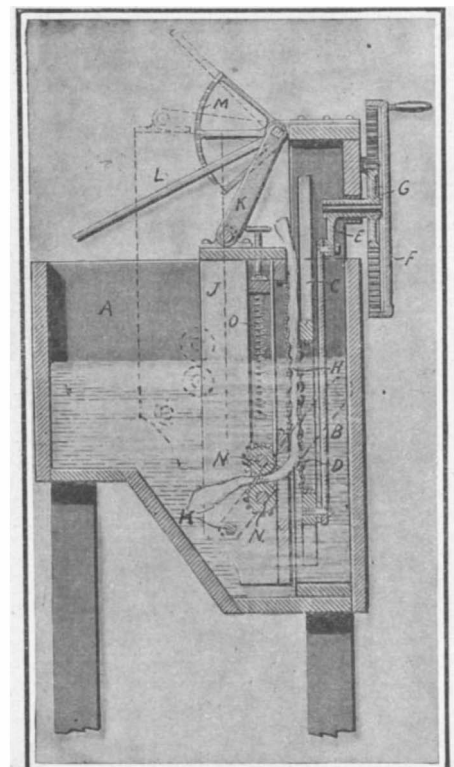

AN IMPROVED WASHING MACHINE.

INDEX OF INVENTIONS

For which Letters Patent of the United States were Issued for the Week Ending February 25, 1908.

AND EACH BEARING THAT DATE [See note at end of list about copies of these patents.]

Table listing inventions with patent numbers, including items like 'Abdominal supporter, M. Donaldson', 'Acoustical instrument, P. Seller', 'Adding machine, R. H. & W. A. McNair', etc.

'Star' Lathe advertisement featuring an illustration of the lathe and text: 'FOR FINE, ACCURATE WORK SENeca FALLS MFG. CO. 695 Water Street, Seneca Falls, N. Y., U. S. A.'

'Engine and Foot Lathes' advertisement: 'MACHINE SHOP OUTFITS, TOOLS AND SUPPLIES. BEST MATERIALS. BEST WORKMANSHIP. CATALOGUE FREE SEBASTIAN LATHE CO., 120 Culvert St., Cincinnati, O.'

'Foot and Power and Turret Lathes, Planers, Shapers, and Drill Presses.' advertisement: 'SHEPARD LATHE CO., 133 W. 2d St. Cincinnati, O.'

'PATENTS' advertisement: 'Our Hand Book on Patents, Trade-Marks, etc., sent free. Patents procured through MUNN & CO. receive free notice in the SCIENTIFIC AMERICAN MUNN & CO., 361 Broadway, N. Y. BRANCH OFFICE: 625 F St., Washington, D. C.'

'THE CLIPPER CLIP' advertisement: 'Its triangular shape prevents entangling and gives three times the capacity of any other Clip for attaching papers together. Best & Cheapest. All Stationers. CLIPPER MFG. CO., 401 West 124th St., New York, U. S. A. Send 10c. for sample box of 100; or 20c. for clips and desk tray.'

'Veeder Counters' advertisement: 'to register reciprocating movements or revolutions. Cut full size. Booklet Free VEEDER MFG. CO. 18 Sargeant St. Hartford, Conn. Cyclometers, Odometers, Tachometers, Counters and Fine Castings.'

'GUNSMITHS, TOOL MAKERS, EXPERIMENTAL & REPAIR WORK, ETC.' advertisement: 'From 9-in. to 13-in. swing. Arranged for Steam or Foot Power. Velocipede or Stand-up Treadle. Send for Lathe Catalog. W. F. & J. N. BARNES CO. Established 1872. 1999 Ruby St., Rockford, Ill.'

'Iron and Wire Fences' advertisement: 'Plain and heavy, also light and ornamental. Wire or Iron Fences. Highest grade at lowest prices. Write for catalog. FREE. Enterprise Foundry & Fence Co., 272 S. Senate Ave., Indianapolis, Ind.'

'JAGER Marine 4-Cycle Engines' advertisement: 'Skillfully designed and well built. Single lever control, combining automatic carburetor with spark advance. Develops wide speed range and reliability under most trying conditions. Sizes 3 to 60 h. p. Send for catalog. CHAS. J. JAGER CO. 281 Franklin, cor. Batterymarch St. Boston, Mass.'

'THE EUREKA CLIP' advertisement: 'The most useful article ever invented for the purpose. Indispensable to Lawyers, Editors, Students, Bankers, Insurance Companies and business men generally. Book marker and paper clip. Does not mutilate the paper. Can be used repeatedly. In boxes of 100 for 25c. To be had of all booksellers, stationers and notion dealers, or by mail on receipt of price. Sample card, by mail, free. Manufactured by Consolidated Safety Pin Co., Box 121, Bloomfield, N. J.'

'Wizard Repeating LIQUID PISTOL' advertisement: 'Will stop the most vicious dog or man without permanent injury. Perfectly safe to carry without danger of leakage. Fires and recharges by pulling the trigger. Loads from any liquid. No cartridges required. Over six shots in one loading. All dealers, or by mail, 50c. Rubber-covered Holster, 10c. With Pistol, 55c. Money-order or stamps. No coins. PARKER, STEARNS & CO., 226 South Street, Dept. G, New York'

'In Cash \$50,000 In Stock Of The Miami Cycle & Mfg. Co.' advertisement: 'which earned 10% during the season of 1907, is offered as proof that The World's Best Bicycle has less pressure on its crank hanger bearings than any ordinary bicycle built; therefore, that it pushes easier and runs faster with less energy and will climb hills easier. The explanation is found in the special Crank Hanger construction and large Sprockets of the Racycle. 1908 Models are built with drop-forged steel heads, crown and seat post clusters and the frames are made of English cold drawn weldless steel tubing made especially for us. We build RACYCLES as near non-breakable as money, materials and workmanship will permit. Write for 1908 catalog and pamphlet—"The Three Reasons", which contains our offer. We make no cheap RACYCLES but you can secure yours cheap if you secure us a name. THE MIAMI CYCLE & MFG. CO. Middletown, Ohio, U. S. A.'

Table listing inventions with patent numbers, including items like 'Concrete structure brace, A. J. Robinson', 'Controlling mechanism, safety, T. R. Bell', 'Conveyer cotton and cotton seed, W. B. Smith', etc.

Table listing inventions with patent numbers, including items like 'Hat holder, Crouse & Roberts', 'Hay rack, E. A. W. Beemer', 'Header and thresher, combined, Holley & Whitford', etc.

GENTLEMEN
WHO DRESS FOR STYLE
NEATNESS, AND COMFORT
WEAR THE IMPROVED

BOSTON GARTER

THE RECOGNIZED STANDARD
The Name is stamped on every loop—

The *Velvet Grip*
CUSHION BUTTON CLASP

LIES FLAT TO THE LEG—NEVER SLIPS, TEARS NOR UNFASTENS

Sample pair, Silk 50c., Cotton 25c. Mailed on receipt of price.

GEO. FROSTCO, Makers
Boston, Mass., U. S. A.

ALWAYS EASY



Learn Photo-Engraving or Photography
Engravers Earn from \$20 to \$50 per Week

The Only College in the world where these paying professions are taught successfully. Endorsed by the International Association of Photo-Engravers and the Photographers Association of Illinois. Terms easy and living inexpensive. Graduates placed in good positions. Write for catalogue, and specify the course in which you are interested. Address

Illinois College of Photography, or } 398 Wabash Ave.,
Bissell College of Photo-Engraving, } Effingham, Ill.
L. H. BISSELL, President

Pipe Cutting and Threading Machine
For Either Hand or Power

This machine is the regular hand machine supplied with a power base, pinion, countershaft, etc., and can be worked as an ordinary power machine or taken from its base for use as a hand machine. Pipe 1/2 in. to 1 1/2 in. diameter handled easily in small room. Illustrated catalogue—price list free on application.

THE CURTIS & CURTIS CO.
6 Garden St., Bridgeport, Conn. Branch Office, 60 Centre St., N. Y.



Motors

for airships and other purposes where light and powerful engines are required. 1 to 40 H. P. Air Cooled. 50 & 100 H. P. Water Cooled.

Adopted by War Department. Send for catalogue B.

G. H. CURTISS MANUFACTURING CO.
Hammondsport, N. Y.

B. F. BARNES
Eleven-inch Screw Cutting Lathe

For foot or power as wanted. Has power cross feed and compound rest. A strictly high grade, modern tool. Ask us for printed matter. Descriptive circulars upon request.

Rockford Drilling Machine Co.
Successor to B. F. Barnes Co.
Rockford, Ill.
European Branch, 149 Queen Victoria St., London, E. C.

ROBERTS MARINE MOTORS

are a scientific success and the users' delight. The Roberts is a Square Deal. Give us the opportunity to prove this to you. Sizes 1/2 to 30 H. P. Write for catalog.

THE ROBERTS MOTOR CO.
Box 309, Clyde, Ohio

Convert your Bicycle into a Motor-Cycle

with one of our Attachable Outfits. A full line of Finished Motors; also Rough Casting for Bicycle, Auto, Marine or Stationary. Send stamp for catalogue.

STEFFEY MFG. CO., 2941 West Girard Avenue, Philadelphia, Pa.



Fish Will Bite

Like hungry wolves, all the season, if you use **Magic-Fish-Lure**. Most wonderful bait ever discovered for attracting all kinds of fish. If you like to pull out the finny beauties right and left, and catch a big string every time you go fishing, don't fail to try this bait. Sent by mail prepaid for 25cents. Perfect satisfaction or money refunded. Interesting Booklet and Price List of Specialties Free. J. F. GREGORY, Desk N, 3319 Oregon Ave., St. Louis, Mo

A Home-Made 100-Mile Wireless Telegraph Set

Read SCIENTIFIC AMERICAN SUPPLEMENT 1605 for a thorough, clear description, by A. Frederick Collins, of the construction of a 100-mile wireless telegraph outfit. Numerous, adequate diagrams accompany the text. Price 10 cents by mail. Order from your newsdealer or from

MUNN & CO., 361 Broadway, New York

Plumb-bob, D. O. Morrill.....	880,387
Post office, separating case, M. Ewing.....	880,132
Potato cutter, M. M. Wheeler.....	880,057
Power press, H. Osswald.....	880,239
Power transmission apparatus, C. R. Keith.....	880,382
Power transmission mechanism, J. U. Baker.....	880,267
Press, S. M. Green.....	880,449
Pressure regulator, R. M. Dixon.....	880,128
Pressure regulator, M. G. Reynolds.....	880,402
Printing frame, E. R. Williams.....	880,345
Printing machine, pencil, H. C. Biette.....	879,849
Printing press, G. H. Pierce.....	879,897
Printing press, P. F. Cox.....	880,281
Printing press, traveling cylinder web, H. F. Bechman.....	880,001
Printing press, web, P. F. Cox.....	880,282
Pruning shears, A. F. Mischke.....	879,882
Pulley sustaining hanger, F. C. Stevens.....	880,415
Pump, M. Pollatschek.....	880,137
Pump, G. Grace.....	880,137
Pump and ball, sand, V. H. Palm.....	880,462
Pump, compound centrifugal, E. W. Riggs.....	880,327
Pump for oil wells, R. S. Fudge.....	880,019
Pump screening device, spray, A. W. Overhiser.....	880,240
Punching machine, T. A. Lindsey.....	880,085
Racket, F. Imlach.....	880,306
Radiator, B. F. Foss.....	879,953
Radiator, G. Hodgdon.....	880,079
Radiator packing joint, S. W. Jameson.....	880,217
Rail bonds, etc., forming, E. M. Bournoisville.....	880,271
Rail lift, T. J. Wasser.....	880,344
Rail tie, metal, G. L. Hindman.....	880,381
Railway fish plate, G. T. Wilson.....	879,935
Railway offset joint, J. H. Allen.....	879,938
Railway, pleasure, J. C. Reckweg.....	880,040
Railway rail joint, W. H. Lewis.....	880,394
Railway rail joint, insulated, K. Kohn.....	879,874
Railway signal apparatus, F. Graziano.....	880,072
Railway signaling system, W. W. Salmon.....	880,329
Railway spike, T. W. Carey, Jr.....	880,480
Railway switch, P. Stanson.....	880,339
Railway tie, Spera & Cocklin.....	879,921
Razor, safety, O. V. Ball.....	880,269
Razors, removable safety guard for, Johnson & McLaren.....	879,875
Reaping, mowing and the like machine, reel for, M. Schiller.....	880,104
Refrigerator, F. V. Detwiler.....	880,443
Relay, interlocking, E. McClintock.....	879,885
Retort drawing machines, mechanism for operating the rake and rake carriage of, H. E. Carpenter.....	880,439
Rifle sight lighting means, C. W. Getchell.....	880,294
River banks, means for protecting, R. B. McGregor.....	880,390
Rivet setting machine, J. E. Perrault.....	879,896
Rock cutting apparatus, cutter of, F. Lobnitz.....	880,227
Rock drill, B. H. Locke.....	879,971
Roll, Evans & Lewis.....	880,205
Rolls, automatic blocking attachment for strip, W. A. Wood.....	880,434
Roller press, C. Neilsen.....	880,935
Rotary engine, G. F. Burton.....	880,009
Rotary engine, J. Zura.....	880,182
Rotary engine, W. Seibert.....	880,333
Rotary internal combustion engine, J. H. Kanson.....	880,453
Sail boom, P. Tatchell.....	879,986
Sand blast machine, G. S. Slocum.....	880,337
Sap receptacle, S. W. Holland.....	880,142
Sash fastener, window, R. E. Hennings.....	880,874
Sash lock, L. S. Mattox.....	880,318
Sash weight, C. E. Rhorer.....	879,906
Sash, window, R. C. Fry.....	880,447
Saw gummer, G. E. Hawkins.....	879,962
Seal applying machine, bottle, E. D. Schmitt.....	880,406
Sealing machines, sealing head for bottle, E. D. Schmitt.....	880,408
Seesaw, W. L. Jenkins.....	880,490
Selling apparatus for stamps, tickets, and the like, coin controlled, C. R. Wedelin.....	879,991
Separator. See Air and dust separator.	
Separator drums, guiding device for suspended, I. P. B. Knudsen.....	880,383
Sewing machine, J. Fink.....	880,133
Sewing machine loop taker actuating mechanism, P. Diehl.....	880,200
Sewing machine table or cabinet, T. Kundtz.....	880,224
Sewing tool, cobble's, W. E. Ward.....	880,130
Shade and curtain bracket, R. H. Foley.....	880,135
Shaft coupling, Vandegrift & Johnston.....	880,255
Sharpening device for skates, etc., L. J. Moorman.....	880,153
Shaving cup, R. G. Foster.....	880,207
Sheet metal, apparatus for producing very thin, T. A. Edison.....	879,859
Sheet metal, producing very thin, T. A. Edison.....	880,484
Sheet metal vessels, die for forming, E. R. Stoddard.....	879,922
Shells, apparatus for removing the percussion caps from discharged, D. Larsson.....	880,147
Shipping box, folding, W. K. Allgire.....	880,347
Shoe, S. N. North.....	879,979
Show case, ribbon, W. E. Miller.....	880,151
Shutter bower, B. E. Beyer.....	880,064
Sign, automatically moving, G. J. Lord.....	880,315
Sign, electric, Young.....	880,263
Signal mechanism, alarm, Flora & Zorge.....	880,134
Signal system, J. A. Gehrung.....	880,136
Signals, electromechanical slot for, G. S. Pfisterer.....	880,398
Skirt supporter, Raymond & Dettmann.....	880,095
Skirt supporter, G. Gromer.....	880,299
Sleigh, M. R. Rudolph.....	880,165
Soda consuming furnace, B. Harris.....	880,380
Soap molding machine, F. Jurgens.....	879,968
Soldering copper, R. R. Stein.....	880,048
Soldering machines, runway or chute for can end, O. J. Johnson.....	880,144
Sound recording and reproducing machines, tilting turn table for, W. N. Dennison.....	880,369
Spark arrester, R. B. Kennington.....	880,309
Spark arrester, W. F. MacGregor.....	880,385
Spark arrester, C. M. Colquhoun.....	880,442
Spike pulley, E. Glomer.....	880,210
Spinning, drawing, roving and like frame, J. Farrar.....	880,068
Spinning machines, doffing means for ring, R. L. Cummock.....	880,014
Spinning machines, revolution indicating mechanism for, L. O. Goodwin.....	879,957
Sponge holder, J. S. Williams.....	880,260
Spraying device, automatic, W. Tyree.....	879,929
Spring motor, K. J. Lathrop.....	880,148
Stamp, hand, Lamb & Tilden.....	880,225
Staple forming and discharging mechanism, V. Hoxie.....	879,965
Starching machine, W. H. H. Tracy.....	879,926
Starching machine, B. W. Jones.....	880,455
Stay and fastener, garment, L. W. Farris.....	880,287
Steam boiler, C. Harter.....	879,961
Steam cylinders or other revolving bodies, steam fitting or joint for journals of rotary, A. Aldrich.....	879,845
Steam superheater, Prager & Hayden.....	880,399
Steam trap, D. Arthur.....	879,997
Steam trap, G. Lusebrink.....	880,087
Steel by the pneumatic process, manufacture of, A. Tropenas.....	880,253
Stereoscope, Clark & Douglas.....	880,481
Sterilizing apparatus, food, I. Hilaire.....	880,452
Strap, safety, W. H. Flecksing, et al.....	880,288
Street construction, F. J. Plym.....	879,898
Storm front, Cockerill.....	879,945
Stove, W. Rube.....	879,909
Stove, convertible heating and cooking, J. J. Shimek.....	880,106
Stove flue, E. E. Thompson.....	879,987
Stove grate, T. J. Stafford.....	880,472
Stove grate, cook, J. J. Shimek.....	880,105
Strainer, tea, B. von Butzingslowen.....	880,190
Strainer, apparatus, C. H. Butler.....	880,124
Street cleaning machine, O. Neukirch.....	880,392
Street or roadway structure, N. Lafon.....	880,312
Striper, J. F. Thomas.....	880,111
Surgical pad, J. A. Murray.....	880,389
Sweetmeat, such as chocolate, manufacture of, V. Hain.....	880,300
Swing, seesaw and rotary, I. S. Woodward.....	879,937
Syringe, J. Wilson.....	880,453
Tap and bush for beer kegs, H. J. Sandell.....	879,983
Target trap, G. Nicolai.....	880,394
Tedder attachment, J. H. Pletscher.....	880,094
Telephone alarm, automatic, Murdock & Gallagher.....	880,155
Telescope, A. Konig.....	880,028
Temperature regulation, A. R. Sprague.....	880,414
Throttle operator, automatic, A. S. Anderson.....	880,061
Tie. See Building block tie.	

If my Razor wasn't good enough for me to use I wouldn't ask you to try it!



You certainly cannot doubt the sound logic and wisdom of the many arguments I have advanced in favor of my razor.

You will admit that unless the "Gillette" possessed many points of superiority it never would have been accepted by two million men in the past three years as the best, most simple and satisfactory shaving device in this world.

In the first place my razor requires **No Stropping, No Honing**. It is always ready. That's why it's the most practical. You can shave in three to five minutes.

The thin, flexible, double-edged blades remove a harsh or soft beard with perfect comfort. No pulling, cutting or irritation of the skin. They are so inexpensive that when dull you throw them away as you would an old pen. No other razor so durable. The triple silver plated holder lasts a lifetime. None so convenient; the compact little case can be with you always—if travelling, either in your pocket or grip.

I know men who have shaved in the dark with the "Gillette." Many use it on the train, others while on hunting trips, fishing expeditions, etc.

That's the beauty of my razor, you can obtain a perfect shave under all conditions—wherever you are.

And I will guarantee you will agree with me right now—that **my razor just fits your case**. A trial will prove it to you. Action must accompany right thinking or you have no power of execution.

Put this correct line of thought into action. Get a "Gillette" today. All Jewelry, Drug, Cutlery, Hardware and Sporting Goods dealers sell it.

King Gillette

The Gillette Safety Razor Set consists of a triple silver plated holder, 12 double-edged flexible blades—24 keen edges, packed in a velvet lined leather case and the price is \$5.00.

Combination Sets from \$6.50 to \$10.00

Ask your dealer for the "GILLETTE" to-day. If substitutes are offered, refuse them and write us at once for our booklet and free trial offer.

GILLETTE SALES COMPANY
207 Times Building New York 207 Kimball Building BOSTON 207 Stock Exchange Building Chicago

Gillette Safety Razor

NO STROPPING NO HONING

THE RACING MACHINE SPARK PLUG



The Center Fire Plug Power increased 10 per cent. each explosion. Ignition in center of compression. Soot proof, quick action, perfect combustion. Agents Wanted. Sample Plugs, \$1.00 each. Give name of car and year. Write

GENERAL ACCUMULATOR & BATTERY CO., 128 Second St., Milwaukee, Wis.

The Bungalow Number of American Homes and Gardens

Do You Own a Bungalow?
Are You Building a Bungalow?



If so, read the Special Bungalow Number of **American Homes and Gardens** TO BE PUBLISHED IN MAY

The number will contain over 60 pages of helpful, practical information, packed with beautiful photographic reproductions of all kinds of bungalows, big and little, costly and cheap. Everybody's taste has been consulted. Besides articles on tastefully designed small houses accompanied by plans and half-tones, there will be contributions on the decoration of the bungalow, its furniture, plumbing and sewage disposal, in a word articles on everything that pertains to the bungalow, inside and out.

This issue will include:

- Furniture for the Bungalow, by Esther Singleton
- Draperies and Rugs for the Bungalow, by Alice Kellogg
- Economic Sanitation of the Bungalow, by John Gade
- Ornamental Log Cabins, by Dorothy Sythe
- Artistic Curtaining, by Phoebe Westcott Humphreys
- A Summer Camp at Arden, by Mabel Tuke Priestman
- A Garden Room, by Carine Cadby
- What is and What is not a Bungalow, by Tomaso Lenellis
- How to Build a Log Cabin, by Edward Fesser
- A Group of California Bungalows, by Helen Lukens Gaut
- A Connecticut Bungalow, by John Sherman
- Two New England Bungalows, by Mary Northend
- A Texas Bungalow, by Paul Thurston
- Ornamental Gateways to Bungalows
- A True Bungalow, by Francis D. Nichols

DOUBLE NUMBER. Price 50c.

MUNN & CO., 361 Broadway, N. Y. City

Classified Advertisements

Advertising in this column is 75 cents a line. No less than four nor more than ten lines accepted. Count seven words to the line. All orders must be accompanied by a remittance. Further information sent on request.

BUSINESS OPPORTUNITIES.

SOUTH DAKOTA CHARTERS.—More liberal—far cheaper than other States. Free blanks and information. For full particulars apply to Philip Lawrence, Former Assistant Secretary State, Huron, S. D.

DESIGN PATENT FOR THIRD TERM CAMPAIGN BUTTON. Three colors. Great money maker. Now is the time. Send for terms, etc. C. F. Pearson, 615 Marshall Street, Portland, Ore.

VENDING MACHINES FOR GUM AND SWEETS. Send for descriptive circular. Foreign rights for sale. For full particulars address S-D Machine Company, 465 Greenwich Street, New York City.

INVENTORS.—Send for free sample copy "World's Progress," devoted to interests of inventors. All latest developments in scientific and industrial world. World's Progress, 510 12th St., Washington, D. C.

PATENTS FOR SALE.

NEW AND USEFUL UMBRELLA RACK.—May 30th 1905. Also, Pencil and Fountain Pen Retainer, September 17th, 1907. Cheap to manufacture. Simple, made of one piece spring wire; would like to hear from factories interested. For particulars address A. M., 720 K Street, Sacramento, Cal.

FOR SALE.—New type greatly improved street car fender. U. S. Patent 841,647 and Canadian patent applied for. Impossible to injure person picked up by this fender. Address "Unhurt," Box 773, New York.

HELP WANTED.

CLERICAL AND TECHNICAL MEN. No matter what experience or position desired, we can interest you. Information free for the asking. Write, Haggoods, 305 Broadway, New York.

FOR SALE.

1905 FRENCH MORS AUTOMOBILE. 10-24 Horse power. Semi-enclosed with fixations. Seats seven. In first-class condition, with complete equipment in lamps, tools, tires etc. Can be seen in New York. Price \$2,500. Replies to Mr. R. W. C. Ellison, Bryn Mawr, Pa.

EXPERIMENTAL WORK.

EXPERIMENTAL MODEL AND ELECTRICAL WORK. Inventions perfected. Address Wagner Model Works, 9 Mohawk Street, Chicago.

MOTION PICTURES.

THE MOVING PICTURE WORLD, weekly, 10 cents per copy; yearly subscription, \$2. The only paper devoted to the moving picture. Illustrated song and lecture field. Moving Picture World, Box 450, N. Y.

BOOKS AND MAGAZINES.

"TROPICAL AND SUB-TROPICAL AMERICA," the new illustrated magazine on South and Central America, Mexico and West Indies. First number is out. Price \$1 a year. 3 months' subscription, 25c. Will show its value. Tropical America Pub. Co., 18 Frankfort St., N. Y.

ELECTRICIAN AND MECHANIC.—Practical monthly magazine for electrical and mechanical students and workers. Publishes illustrated directions for constructing dynamos, motors, gasoline engines, wireless telegraphy, electroplating, electrical wiring, mechanical drawing, using tools, furniture construction, boat building, all kinds of mechanical work. One dollar yearly; trial subscription for three months, twenty cents. List of electrical and mechanical books free. S. A. Sampson Pub. Co., 6 Beacon St., Boston, Mass.

HOUSEHOLD NEEDS.

BUTCHER'S BOSTON POLISH is the best finish made for floors and interior woodwork. Not brittle; will not scratch or deface like shellac or varnish. Send for free booklet. For sale by dealers in Paints, Hardware and House Furnishings. The Butcher Polish Co., 356 Atlantic Avenue, Boston, Mass.

ASTRONOMY.

STARS AND PLANETS.—Learn to know them at a glance! Astronomy in simplest and most fascinating form. The Luminous Revolving Planisphere shows clearly principal stars visible any hour in year. Simple, handy, reliable. Only 83c. T. Whitaker, 123 Bible House, N. Y.

EDUCATIONAL.

LEARN TO MAKE PORTLAND CEMENT.—Blocks, white or any color. Waterproofing. Sidewalks, Bridge, Roof, Floor. Re-inforcements. Valuable Book, \$1.00. Cement Institute, 86 Chestnut, St. Louis, Mo.

PHOTOGRAPHY.

AMERICAN PHOTOGRAPHY succeeds American Amateur Photographer. Camera and Dark Room and Photo Beacon. The editors of each now join in making a magazine which should be in the hands of every photographer, professional or amateur. 15 cents monthly, \$1.50 per quarter. Three specimen copies for a quarter. Am. Photographic Pub. Co., 361 Broadway, New York.

DEAFNESS.

TO THOSE HARD OF HEARING.—An efficient aid sent for trial, no expense, no risk, no contract, no money unless device be kept. For full particulars address A. O. Tiemann & Company, 107 Park Row, New York.

WATER FILTER.

THE DUPLEX FILTER is positively hygienic and self-cleaning. Lease by 257 physicians, 6 hospitals, shops, factories, private families. Write for agent's proposition. Duplex Filter Co., 1140 Broadway, N. Y.

GRE-SOLVENT.

GRE-SOLVENT instantly dissolves Machine-grease, Paint, Ink, etc. from hands. Beneficial to skin. Sells like wildfire to every mechanic. Agents wanted. Big profits. Free sample. Do it now. Utility Co., 646 W. 44th St., N. Y. City.

OLD COINS AND STAMPS.

\$5.75 PAID FOR Rare Date 1853 Quarters. Keep all money coined before 1875 and send 10c. at once for a set of two coin and stamp value books, size 4x7. It may mean your fortune. C. W. Clarke & Co., Le Roy, N. Y.

THE INTERNAL WORK OF THE WIND. By S. P. LANGLEY. A painstaking discussion by the leading authority on Aerodynamics, of a subject of value to all interested in airships. SCIENTIFIC AMERICAN SUPPLEMENTS 946 and 947. Price 10 cents each, by mail. Munn & Company, 361 Broadway, New York City, and all newsdealers.

Table listing various mechanical and electrical items with prices, including tile roofing, tire attachment, tools, and machinery.

DESIGNS.

Table listing designs such as emblem, fabric, hammock, hand bag, and musical testing machines.

TRADE MARKS.

Table listing trade marks for beer, chemicals, clothing, and machinery.

CRYSTAL Domino SUGAR advertisement with logo and text: 5 lb Sealed Boxes Only! Best Sugar for Tea and Coffee! By Grocers Everywhere!

A. W. FABER "CASTELL" Drawing Pencils advertisement featuring an image of a pencil and text: THE LATEST AND BEST A. W. FABER "CASTELL" Drawing Pencils. Made of the purest graphite in 16 degrees of hardness, 6B to 8H, of the utmost delicacy of tone, permanency, durability and intensity of color.

The Largest Air-Cooled Motor Made 5 HORSE POWER advertisement with image of a motor and text: 5 HORSE POWER Bore 6 x 6 inches. Plenty of cooling surface. No engine ever constructed with so few working parts.

\$40 MOTORCYCLE advertisement with image of a motorcycle and text: We have the largest line of New and used Motor Cycles, Parts and Supplies in the country, at the lowest prices. Every machine guaranteed. We are the largest and only exclusive Motorcycle House in the world. Send for our 1908 Catalog. Repairs a specialty.

GILSON MFG. CO. advertisement with image of a pump and text: GOES LIKE SIXTY SELLS LIKE SIXTY \$60 GILSON GASOLINE ENGINE For Pumping, Cream Separators, Churns, Wash Machines, etc. FREE TRIAL. Ask for catalog—all sizes.

DEAN ENGINES advertisement with image of an engine and text: DEAN ENGINES GAS-GASOLINE-ALCOHOL OUR Catalog is unique. It gives the bore and stroke of our engines—tells just what is included in each equipment; explains why we offer 30 days free trial and sell at prices that defy competition. Sent free on request. Address the DEAN GAS ENGINE & FOUNDRY CO. 110 Front St. Newport, Ky.

Instructive Scientific Papers ON TIMELY TOPICS Price 10 Cents each by mail. ARTIFICIAL STONE. By L. P. Ford. A paper of immense practical value to the architect and builder. SCIENTIFIC AMERICAN SUPPLEMENT 1500. THE SHRINKAGE AND WARPING OF TIMBER. By Harold Busbridge. An excellent presentation of modern views; fully illustrated. SCIENTIFIC AMERICAN SUPPLEMENT 1500. CONSTRUCTION OF AN INDICATING OR RECORDING TIN PLATE ANEROID BAROMETER. By N. Monroe Hopkins. Fully illustrated. SCIENTIFIC AMERICAN SUPPLEMENT 1500. DIRECT-VISION SPECTROSCOPES. By T. H. Blakesley, M.A. An admirably written, instructive and copiously illustrated article. SCIENTIFIC AMERICAN SUPPLEMENT No. 1493. HOME MADE DYNAMOS. SCIENTIFIC AMERICAN SUPPLEMENTS 161 and 600 contain excellent articles with full drawings. PLATING DYNAMOS. SCIENTIFIC AMERICAN SUPPLEMENTS 720 and 793 describe their construction so clearly that any amateur can make them. DYNAMO AND MOTOR COMBINED. Fully described and illustrated in SCIENTIFIC AMERICAN SUPPLEMENTS 844 and 865. The machines can be run either as dynamos or motors. ELECTRICAL MOTORS. Their Construction at Home. SCIENTIFIC AMERICAN SUPPLEMENTS 759, 761, 767, 641. Price 10 Cents each, by mail. Order through your newsdealer or from MUNN & COMPANY 361 Broadway New York

"Get There"
at a price to suit
you direct for a



BLACK MOTOR BUGGY
Built for country roads, hills and mud. Engine—10 H. P., 2 cylinders, air cooled, chain drive rear wheels, double brake. Speed 2 to 25 m. per hr.—30 miles on 1 gal. of gasoline. Highest quality finish, workmanship and materials. Absolutely safe and reliable. Write for Book No. A-27
BLACK MFG. CO., 124 E. Ohio St., Chicago, Ill.



Build Your Own Boat
BY THE **BROOKS SYSTEM**

I absolutely guarantee you will be satisfied. I will instantly refund your money if you are not. I stand back of every statement made in this advertisement. I have made them as strong and convincing as I know how. The goods warrant it.
C. C. Brooks

AND SAVE THREE-FOURTHS

I can sell you a boat for one-fourth of what a factory would charge, 100 cents worth of actual value and results for 25 cents.

My catalogue will prove what I claim. Give me a chance right now, to-day.

Read my guarantee—it means you take no risk. Seven years ago I originated the pattern system of boat-building.

Over 50,000 boats (more than the combined output of all boat factories) have been built from my system, mostly by inexperienced men and boys.

Boat Patterns, \$1.50 and Up

Anyone can build a boat by using my exact size printed paper patterns and illustrated instruction sheets. You cannot fail to build as good a boat as the professional boat builder.

Knock-Down Boat Frames

Many people prefer to buy my knock-down frames (all ready to put together) for their boats, instead of working up the rough lumber. I can in many cases supply knock-down frames at a lower price than you would pay for suitable raw material.

All parts of my knock-down frames are accurately shaped and machined, ready to put together.

Patterns and illustrated instructions needed to finish the boat, sent free with K. D. frames.

I can save you, (1) boat-builder's profit, (2) labor expense, (3) big selling expense, (4) seven-eighths the freight. You can figure this out yourself. If engine is desired, I make a special combination price with knock-down frame.

Remember, my guarantee means just what it says. The boat you build will be satisfactory—I guarantee it. I take all the risk. Write me personally for my **Boat or Engine Catalog**, mailed free.

BROOKS BOAT MFG. CO.
C. C. BROOKS, Pres.
(Originators of the Pattern System of Boat-Building)
402 Ship Street, SAGINAW, MICH., U. S. A.

The Motorcycle That Makes Good



THE MERKEL is so well built that the cost of repairs rarely exceeds that of a common bicycle; rides with an easy spring that practically eliminates all jolting and jarring; is so adjusted that the rider can from the handle bars absolutely control it at all times; and has ball bearing 3 H. P. motor, which may be had with magnet ignition. If you are looking for that kind of a machine, you should investigate the 1908 Merkel. Its record tells the story. Write us for an account of what the Merkel is doing at the various motorcycle contests.

But it is as a practical, every-day machine that we are most enthusiastic about the Merkel. Safe, economical and comfortable, it fills the needs of the motorcyclist who wants his money's worth.

Write for our catalogue—we send it free.
MERKEL MOTOR CO.
1128 26th Ave., Milwaukee, Wis.

BE A RAILROAD MAN

Firemen and brakemen earn from \$100 to \$185 a month. Graduates of this school in great demand. Actual railway officials teach you by mail during your spare time, at small cost. Free catalog, etc.
The Wenthe Railway Correspondence School, Box 586, Freeport, Ill.

USE GRINDSTONES!

If so we can supply you. All sizes mounted and unmounted, always kept in stock. Remember, we make a specialty of selecting stones for all special purposes. Send for catalogue "1".
The CLEVELAND STONE CO.
2d Floor, Wilshire, Cleveland, O.

60 YEARS' EXPERIENCE

PATENTS

TRADE MARKS DESIGNS COPYRIGHTS &c.

Anyone sending a sketch and description may quickly ascertain our opinion free whether an invention is probably patentable. Communications strictly confidential. HANDBOOK on Patents sent free. Oldest agency for securing patents. Patents taken through Munn & Co. receive special notice, without charge, in the **Scientific American**.

A handsomely illustrated weekly. Largest circulation of any scientific journal. Terms, \$3 a year; four months, \$1. Sold by all newsdealers.
MUNN & CO., 361 Broadway, New York
Branch Office, 626 F St., Washington, D. C.

Harness, certain, Covert Manufacturing Co.	67,887
Hinges and hinge blanks, Columbian Hardware Co.	67,864
Hoes, Withington & Cooley Mfg. Co.	67,882, 67,883
Hose supporters and garters, Minton Co.	67,939
Ink dividing bands, N-M-C-R Co.	67,872
Inks and ink pads, Fountain Ink Pad Co.	67,933
Insecticides, Strawsons	67,880
Iron compound, certain, C. Cederroth	67,891
Lamp mantles, gas, General Gas Light Co.	67,908
Lamps, vehicle, Roberts & Matthews	67,895
Lawn trimmers and edgers, H. O. Secrest	67,878
Lime and ready-mixed mortar, Rockland-Rockport Lime Co.	67,876
Liniments, Theoline Chemical Co.	67,920
Lubricators and oilers, International Patent Corporation	67,869
Machinery certain, Philadelphia Drying Machinery Co.	67,855
Match ignition strips, safety, C. M. Hunter	67,852
Matches, Nitedals Taendstikfabrik	67,873
Medicinal preparation certain, Mariani & Co.	67,912
Medicinal and toilet cologne, Robinson Bros. & Co.	67,896
Medicines and plasters, Societe anonyme des Produits Chimiques Speciaux	67,917
Medicines, certain, P. Chevreux	67,905
Medicines, certain, Societe anonyme des Produits Chimiques Speciaux	67,916, 67,918
Metal manufactures, certain, Gillette-Vibber Co.	67,868
Milk, Lacto-Bacilline Company of New York	67,937
Ointment, Robinson Bros. & Co.	67,937, 67,915
Packing, steam or machinery, Kuschnitzky & Grunhut	67,894
Paint, A. E. Kirk	67,888
Painters' materials, certain, Cleveland Varnish Co.	67,884, 67,886
Paste for destroying rats, mice, and roaches, A. W. Roseman	67,877
Picture machines, films, and attachments, moving, Viascope Mfg. Co.	67,961
Powder, stomachic, P. F. W. Barella	67,890
Press boards, Case Brothers	67,904
Remedies for stomach, liver, and bowel disorders, Fermo Co.	67,907
Remedy, certain, J. Friedlander	67,893
Remedy for croup, coughs, and colds, Camp-Croup Co.	67,903
Remedy for whooping cough and colds, H. Mole	67,913
Remedy, pile, C. H. Hoyt & Co.	67,910
Rings, chains, bracelets, and jewelry, A. Rosenberg	67,951
Shoe polish, Corry Chemical Co.	67,866
Soldering paste, salts, and sticks, Commercial Electrical Supply Co.	67,851
Spices, W. W. Harper Co.	67,843
Steel and iron, S. Osborn & Co.	67,875
Stoves, Bridge & Beach Manufacturing Co.	67,902
Stoves and ranges, Bridge & Beach Mfg. Co.	67,901
Tea, C. S. Morey Mercantile Co.	67,927
Thread and spool and sewing cotton, American Thread Co.	67,861
Tire filler, W. H. Sterling	67,941
Tobacco, chewing and smoking, American Tobacco Co.	67,949
Tobacco drying, cooling, and treating machinery, Philadelphia Drying Machinery Co.	67,854
Tonic beverage, H. & T. Dailey	67,892
Tonic beverage, non-alcoholic, Wake Chemical Co.	67,921
Tools, certain, A. Baldwin & Co.	67,848
Tools, certain, Chillington Tool Co.	67,850
Tools, certain, Simmons Hardware Co.	67,856
Velvetens, Mechanische Weberei zu Linden	67,948
Washboards, American Washboard Co.	67,862
Watches, South Bend Watch Co.	67,959
Water meters, Builders' Iron Foundry	67,950
Water, mineral, Glenn Springs Co.	67,909
Waters, mineral, L. Smith	67,898
Wheat flakes, Pacific Milling Co.	67,923
Whisky, Cook & Bernheimer Co.	67,854
Whiskey, C. Sandheger	67,958

LABELS.

"Art Filet Embroidery," for embroidered lace, Kursheedt Mfg. Co.	14,067
"Bassett's Egg Shampoo Cream," for a toilet preparation for shampooing the hair, Bassett Supply Co.	14,065
"Bony Brawn," for Scotch whisky, Hochstadter Co.	14,056
"Dextrose," for a prepared food for infants and invalids, Dextrose Food Co.	14,063
"Extra Fina," for cigars, Schmidt & Co.	14,055
"Fire Proof Stove Polish—no more red stove lids," for a stove polish, G. Ariens	14,066
"Janice," for candy, National Candy Co.	14,057
"Lilac Girl," for candy, National Candy Company	14,058
"S. S. Borden Co.'s Creamery Butter XXXX Brand," for creamery butter, S. S. Borden Co.	14,059
"Schilling's Best," for pepper, A. Schilling & Co.	14,060
"Schilling's Best," for cream tartar, A. Schilling & Co.	14,061
"Schilling's Best," for soda, A. Schilling & Co.	14,062
"Star Feed," for stock and poultry feed, Ralston Purina Co.	14,064
"Superior Portland Cement," for cement, Superior Portland Cement Co.	14,068
"The Boiler," for wash boilers, M. Kamenstein	14,069

PRINTS.

"Our Cutter," for men's and boys' coats, vests, and trousers, Ed. V. Price & Co.	2,230
"Our Schoolmaster" Series No. 5," for men's and boys' coats, vests, and trousers, Ed. V. Price & Co.	2,226
"Our Schoolmaster" series No. 6," for men's and boys' coats, vests, and trousers, Ed. V. Price & Co.	2,227
"Our Schoolmaster" Series No. 7," for men's and boys' coats, vests, and trousers, Ed. V. Price & Co.	2,228
"Our Schoolmaster" Series No. 8," for men's and boys' coats, vests, and trousers, Ed. V. Price & Co.	2,229

A printed copy of the specification and drawing of any patent in the foregoing list, or any patent in print issued since 1863, will be furnished from this office for 10 cents, provided the name and number of the patent desired and the date be given. Address Munn & Co., 361 Broadway, New York.

Canadian patents may now be obtained by the inventors for any of the inventions named in the foregoing list. For terms and further particulars address Munn & Co., 361 Broadway, New York.

How to Build a 5 H. P. Gas Engine at Home

IN SCIENTIFIC AMERICAN SUPPLEMENTS 1641 and 1642, E. F. Lake describes simply and thoroughly how a five horse power gas engine can be built at home. Complete working drawings are published, with exact dimensions of each part. Price by mail for the two Supplements, 20 cents.

Order from your newsdealer or from
MUNN & COMPANY
Publishers
361 Broadway, New York



Imbedded in Solid Rubber

The most vital part of a shaving brush is the setting of the bristles. The better the setting the better the brush—that's why

RUBBERSET
TRADE MARK
Shaving Brushes

last a lifetime without the loss of a single bristle, for the bristles are imbedded in a base of solid rubber that is impervious to hot water, soap or hard usage. The shape of a Rubberset brush is always perfect—the bristles are always alive—the handles never crack—the brush improves with age until you wouldn't part with it for ten times its price—yet it costs no more than ordinary kinds.

The name on every brush guarantees it.

At all dealers' and barbers', in all styles and sizes, 25, 50, 75 cents to \$6.00. If not at your dealer's, send for booklet from which you may order BY MAIL.

To the average man we commend the \$1.00 brush.

THE RUBBERSET BRUSH COMPANY,
74 Ferry Street, Newark, N. J.

LET US BE YOUR FACTORY
STAMPINGS, MODELS, EXPERT WORK
THE GLOBE MACHINE AND STAMPING CO.
970 Hamilton St., Cleveland, O.

METAL STAMPINGS
TOOLS, DIES and EXPERIMENTAL WORK

Well Equipped Factory for General Machine Work. Send sample or drawing for estimate.
Eastern Machine and Stamping Co.
Providence, R. I.

ICE MACHINES Corliss Engines, Brewers' and Bottlers' Machinery. **THE VILTER MFG. CO.,** 899 Clinton St., Milwaukee, Wis.

Our expert mechanics are
"UP TO THE MINUTE"
Your problems quickly solved. Let us make your models, or special devices in Metal.
Newark General Manufacturing Co., 34 Mechanic St., Newark, N. J.

MODELS & EXPERIMENTAL WORK. Inventions developed. Special Machinery.
E. V. BAILLARD. 24 Frankfort Street, New York.

NOVELTIES & PATENTED ARTICLES
MANUFACTURED BY CONTRACT. PUNCHING DIES, SPECIAL MACHINERY.
E. KONIGSLOW STAMPING & TOOL WORKS, CLEVELAND, O.

RUBBER Expert Manufacturers
Fine Jobbing Work
PARKER, STEARNS & CO., 228-229 South Street, New York

INVENTORS We manufacture METAL SPECIALTIES of all kinds, to order; largest equipment; lowest prices. Send perfect sample for low estimate and best expert advice
FREE
THE EAGLE TOOL CO., Dept. A, Cincinnati, O.

Experimental & Model Work
Cir. & advice free. Wm. Gardam & Son, 45-51 Rose St., N.Y.

EXPERIENCED IN DEVELOPING INVENTIONS
Model Machine and Electrical Work.
C. TIETZMANN, 198 Eleventh Avenue, Long Island City.

MODELS & CHICAGO MODEL WORKS
ESTABLISHED 1867
179 E. MADISON ST. CHICAGO, ILL.
WRITE FOR CATALOGUE OF MODEL SUPPLIES

VENTRILOQUISM
Learned by any Man or Boy at home. Small cost. Send to-day 2-cent stamp for particulars and proof.
O. A. Smith, Room 678, 2040 Knoxville Ave., Peoria, Ill.

DIE WORK | **SPECIAL TOOLS** | **MODELS**
Experimental Work for Inventors
H. TURNER TOOL CO., 215 S. Clinton St., Chicago

THE SCHWERTLE STAMP CO.
STEEL STAMPS, LETTERS & FIGURES
BRIDGEPORT, CONN.

Magical Apparatus.
Grand Book Catalogue. Over 700 engravings
25c. Parlor Tricks Catalogue, free.
MARTINKA & CO., Mfrs., 493 Sixth Ave., New York

Any one can Play any Guitar
WITH IT IN 10 MINUTES
Write **ALBERT PIETSCH**
605 Cedar St., Milwaukee, Wis.

INVENTORS, MANUFACTURERS. SPECIAL TOOLS—DIES—METAL SPECIALTIES—METAL NOVELTY WORKS
C2, 85-91 W. LAKE ST. CHICAGO

ARMY AUCTION SALE BARGAINS
Large 280 page illustrated 1907 Catalogue mailed free. (stamps). **Franco Bannerman, 501 Broadway, N. Y.**

DRYING MACHINES For all kinds of granular materials. S. E. Worrell, Hannibal, Mo.

SETS OF CASTINGS OF MODEL ENGINES
SEND 10¢ FOR 126 PAGE ILL. CATALOGUE.
ALSO TOOLS, GEAR WHEELS, & PARTS OF MODELS
GOODNOW & WIGHTMAN
Removed to 182 Milk Street.

MASON'S NEW PAT. WHIP HOISTS
save expense and liability incident to Elevators. Adopted by principal storeshouses in New York & Boston
Manfd. by **VOLNEY W. MASON & CO., Inc.**
Providence, R. I., U. S. A.

KUHLMAN TRANSFORMERS
Quality always. Single and 3-phase. Prompt delivery.
KUHLMAN ELECTRIC CO., ELKHART, IND.

THE LARGEST ENGINES IN THE WORLD



Keep **CHICAGO & ALTON** Trains On Time Between **CHICAGO · ST. LOUIS · KANSAS CITY.**
"The Only Way"
GEO. J. CHARLTON, GENERAL PASSENGER AGENT. CHICAGO.

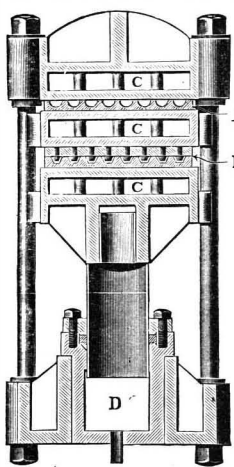

We request manufacturers, inventors and others needing special articles in rubber to send us descriptions of their requirements with drawings or wood models for estimates as to cost of producing in rubber.

A full line of Mechanical Rubber Goods of every description.

Vulcanizing Press for Rubber Specialties

A Single Plate Mold. B Double Plate Mold. C Steam Spaces in Press Plates. D Hydraulic Pressure 2000 lbs. square inch.

NEW YORK BELTING & PACKING COMPANY, Ltd.
91 & 93 Chambers Street, New York

Scales All varieties at lowest prices. Best Railroad Truck and Wagon or Stock Scales made. Also 1000 useful articles, including Saws, Sewing Machines, Bicycles, Tools, etc. Save Money. Lists Free. CHICAGO SCALE CO., Chicago, Ill.

LEARN TO BE A WATCHMAKER
Bradley Polytechnic Institute
Horological Department
Peoria, Illinois
Formerly Parsons Horological Inst.
Largest and Best Watch School in America

We teach Watch Work, Jewelry, Engraving, Clock Work, Optics. Tuition reasonable. Board and rooms near school at moderate rates. Send for Catalog of Information.

Make Your Own CONCRETE BLOCKS

Save dealers' and manufacturers' profits. Big saving in cost. Sand, Portland Cement, and water only materials required. No experience necessary. We furnish complete instructions and a simple, rapid outfit for \$33.25 and up. Buildings erected are handsome, durable, fire-proof, frost-proof and require neither painting or repairs. This is an opportunity to own your own home at a small cost. Investigate. Concrete machinery catalog free.

THE PETTYJOHN CO., 615 N. Sixth St., Terre Haute, Ind.

"HOW TO REMEMBER"
Sent Free to Readers of this Publication

Stop Forgetting

You are no greater intellectually than your memory. Easy, inexpensive. Increases income; gives ready memory for faces, names, business details, studies, conversation; develops will, public speaking, personality. Send today for Free Booklet. Address: DICKSON MEMORY SCHOOL, 700 Auditorium Bldg., Chicago

EFFICIENT POWERS

THAT ARE ADAPTED TO THE USES OF ALL CLASSES OF MECHANICS

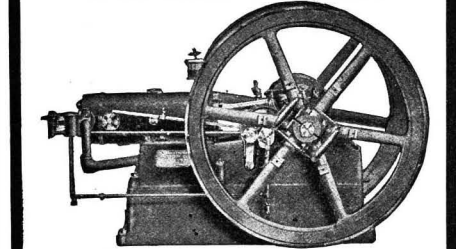

I. H. C. GASOLINE ENGINES
are built on strong, simple lines. Accessibility of parts, perfect control and operating economy are distinguishing features. These characteristics make I. H. C. engines unexcelled general purpose engines for shop, mill or factory use. They will always develop the full rated horse power because they are tested at the factory and are not sent out until they deliver a large per cent in excess of their rating. Minimum fuel consumption is also insured by this factory test.

Verticals in 2 and 3-horse power.
Horizontals (Portable and Stationary) in 4, 6, 8, 10, 12, 15 and 20-horse power.
Air Cooled Engines in 1-horse power.
Stocks carried by I. H. C. local agents. Call on them or write the Home Office for catalogues and particulars.

INTERNATIONAL HARVESTER COMPANY OF AMERICA
(Incorporated)
15 Harvester Building, Chicago, Ill.

RADIUM DECARBONIZER
chemically removes carbon from cylinders, piston valves and rings

INCREASES POWER 20 PER CENT
Volatilizes carbon, in which form it passes out exhaust. **Injury to metal impossible.** Agents wanted in certain localities. Sample quart can, \$1.50. Write to-day for particulars.

General Accumulator & Battery Co
128 Second Street, Milwaukee, Wis.

GIANT STEAM SHOVELS
Toledo, Ohio, U.S.A.
The Vulcan Iron Works Co.

THE STRONGEST LIGHT METAL

McADAMITE
Specific Gravity 3.20

Tension, - 44,000 lbs. to sq. in. Compression, 126,000 lbs. to sq. in.
Transverse, 87,000 " " " Torsion, - 60,000 " " "

Send for test bar or a pattern for sample casting

U. S. McADAMITE METAL CO.
19 Rapelye Street BROOKLYN, N. Y.

Every Quality That Counts

Model G Four Cylinders 25 H. P. \$2000

in making an automobile eminently luxurious and comfortable, thoroughly dependable under all conditions of service, with that detailed mechanical refinement which characterizes advanced motor car construction—these are the qualities conspicuously present in

CADILLAC

\$2000

Because of its smooth action, even balance and unflinching constancy of power, Model G has many times proven its supremacy in severe competition with cars of higher price and rated power and greater number of cylinders. A demonstration will be cheerfully given by your nearest dealer. Described in Catalog G 47.

If interested in smaller cars, get our booklet No. 47 entitled **"The Truth About the Automobile and What it Costs to Maintain One."** Giving valuable information on the low cost of maintaining the single-cylinder Cadillacs—Model T (4 passengers), \$1000, and Model S Runabout, \$850. Both described in Catalog T 47.

Model G Roadster \$2000

Another exclusive four-cylinder car is Model H, \$2500, described in Catalog H 47.

Prices include pair of dash oil lamps, tail lamp, and horn.

CADILLAC MOTOR CAR CO.
Detroit, Mich.
Member A. L. A. M.

Engineering News

(ILLUSTRATED)

214 Broadway, New York

The leading weekly Engineering paper of the world, devoted to the interests of Civil, Mechanical, Mining, and Electrical Engineers. 100 to 125 pages weekly. Send-for-free sample copy.

A Wonderful Automatic Pump
For supplying running water in summer hotels and resorts, sanatoriums, state institutions, irrigation purposes, dairy farms and country houses, the

Niagara Hydraulic Ram
has no equal. Requires no attention; no cost for repairs. Write for Booklet AA and guaranteed estimate.

NIAGARA HYDRAULIC ENGINE CO.
140 Nassau St., N. Y. Factory: Chester, Pa.

POCKET STEEL TAPES
1/4 in. wide. Nickel plated cases with rounded edges. Spring wind with center stop. Graduated in inches and 16ths.

86 in.	each	\$0.60
60 "	"	.75
72 "	"	.80
96 "	"	1.15

Send for 232 page catalog No. 18-B.

THE L. S. STARRETT CO., Athol, Mass., U. S. A.

THE Nulite Vapor Lamps
For Home, Store and Street

We also manufacture Table Lamps, Wall Lamps, Chandeliers, Street Lamps, Etc. 100 Candle Power seven hours ONE CENT. No Wick. No Smoke. No Odor. Absolutely safe. THEY SELL AT SIGHT. Exclusive territory to good agents. Write for catalogue and prices.

Chicago Solar Light Co., Dept. G. Chicago

CRUDE ASBESTOS
DIRECT FROM MINES

PREPARED ASBESTOS FIBRE for Manufacturers use

R. H. MARTIN,
OFFICE, ST. PAUL BUILDING
220 B'way, New York.

Mullins Steel Boats Can't Sink
—the fastest and safest boats built. Made of pressed steel plates, with air chambers in each end like a life boat, they are absolutely safe. Faster, lighter and more buoyant than wooden boats—practically indestructible—they don't leak, crack, dry out or wear out, and every boat is absolutely guaranteed. The ideal boats for pleasure, summer resorts, boat livery, etc.

Send for catalog of Motor Boats—Marine Engines—Row Boats—Hunting and Fishing Boats.

THE W. H. MULLINS COMPANY, 118 Franklin St., Salem, Ohio.

HENRY C. SQUIRES SONS are General Agents in Greater New York and Long Island for Mullins Boats and Launches. Squires Building, 44 Cortlandt St., N. Y.

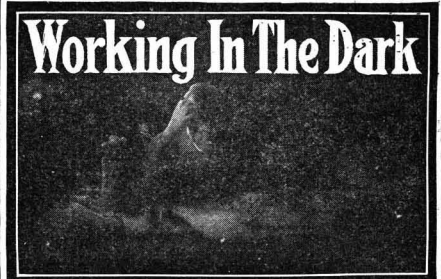

Working In The Dark

Don't work in the dark. Don't let opportunities for advancement slip by you just because you can't see them. Turn the searchlight of knowledge upon your every-day work; learn all there is to know about your trade, and get an insight into the trades related to it.

The American School of Correspondence has brought the light of special knowledge into the homes of thousands of wage-earners and shown them the way to a better position with a better future. Whatever your present education and circumstances are, it can help you by home study, without interrupting your work, to get easier work, shorter hours, and better pay.

Send for FREE illustrated 200-page handbook describing over 60 engineering courses. Advise us which of the following courses interests you:

- | | |
|------------------------------|-----------------------------------|
| Mechanical Drawing | Mathematics |
| Electrical Engineering | Heating, Ventilating and Plumbing |
| Mechanical Engineering | Architecture |
| Stationary Engineering | Hydraulics |
| Structural Engineering | Surveying |
| Locomotive Engineering | Telegraphy |
| Structural Drafting | Textiles |
| Telephone Practice | College Preparatory Course |
| Sheet Metal Pattern Drafting | |
- Mention Scientific American, 3-7-08.

AMERICAN SCHOOL OF CORRESPONDENCE
CHICAGO

MILLS FOR ALL MATERIALS.

OUR BUSINESS IS TO MAKE MACHINERY FOR GRINDING, GRAIN CRUSHING, ROCKS AND PULVERIZING ALL HARD SUBSTANCES. WE HANDLE ALL KINDS OF MATERIALS FROM COTTON-SEED TO ROOTS AND HERBS. BY AN UNEXCELLED PROCESS, IF YOU WANT ANY KIND OF A MILL OR GRINDING MACHINE, COME TO US AND YOU WILL GET THE BEST AND STILL SAVE MONEY.

DEAL WITH US ONCE AND YOU WON'T CHANGE. ESTIMATES FREELY FURNISHED.

SPROUT, WALDRON & CO.
SEND FOR CATALOG NO. 4.) MUNCY, PA.

MEDAL OF HIGHEST AWARD
JAMESTOWN EXPOSITION

Add TONE to your Stationery in the OFFICE, BANK, SCHOOL or HOME by using only Wasburne's Pat. "O.K." PAPER FASTENERS

There is genuine pleasure in their use as well as Perfect Security. Easily put on or taken off with the thumb and finger. Can be used repeatedly and they always work. Made of brass, 3 sizes, in brass of 100 fasteners each. Send 10c for sample box of 50, assorted. Booklet free.

THE O.K. MFG. CO., Dept. X, Syracuse, N.Y. No. 1B

DO YOU LIKE TO DRAW ?
That's all we want to know. Now, we will not give you any grand prize—or a lot of free stuff if you answer this ad. Nor do we claim to make you rich in a week. But if you are anxious to develop your talent with a successful cartoonist, so you can make money, send a copy of this picture, with 6 cents in stamps for portfolio of cartoons and sample lesson plate and let us explain.

The W. L. EVANS SCHOOL OF CARTOONING
442 Garfield Bldg., Cleveland, Ohio

UNDERWOOD MECHANICAL BOOK-KEEPING AS PERFECT AS UNDERWOOD MECHANICAL CORRESPONDENCE.

NO. 5. RETAIL BILL AND CHARGE

THE UNDERWOOD BILLING INVOICING

NO. 3. UNIT BILLER

NOTICE THESE THREE FORMS

BOOK-KEEPING CORRESPONDENCE TYPEWRITERS

MAKE IT POSSIBLE TO THOROUGHLY SYSTEMATIZE ALL BUSINESS

NO. 3. CONDENSED BILLER.

THE UNDERWOOD TYPEWRITER CO. INC.
NEW YORK OR ANYWHERE.

HELMET OIL LUBRICATES ANYTHING SEND FOR SAMPLE FREE

15-21 S. CLINTON ST. CHICAGO, U.S.A.