

SCIENTIFIC AMERICAN

[Entered at the Post Office of New York, N. Y., as Second Class Matter. Copyright, 1906, by Munn & Co.]

Vol. XCV.—No. 24.
ESTABLISHED 1845.

NEW YORK, DECEMBER 15, 1906.

[10 CENTS A COPY
\$3.00 A YEAR.]

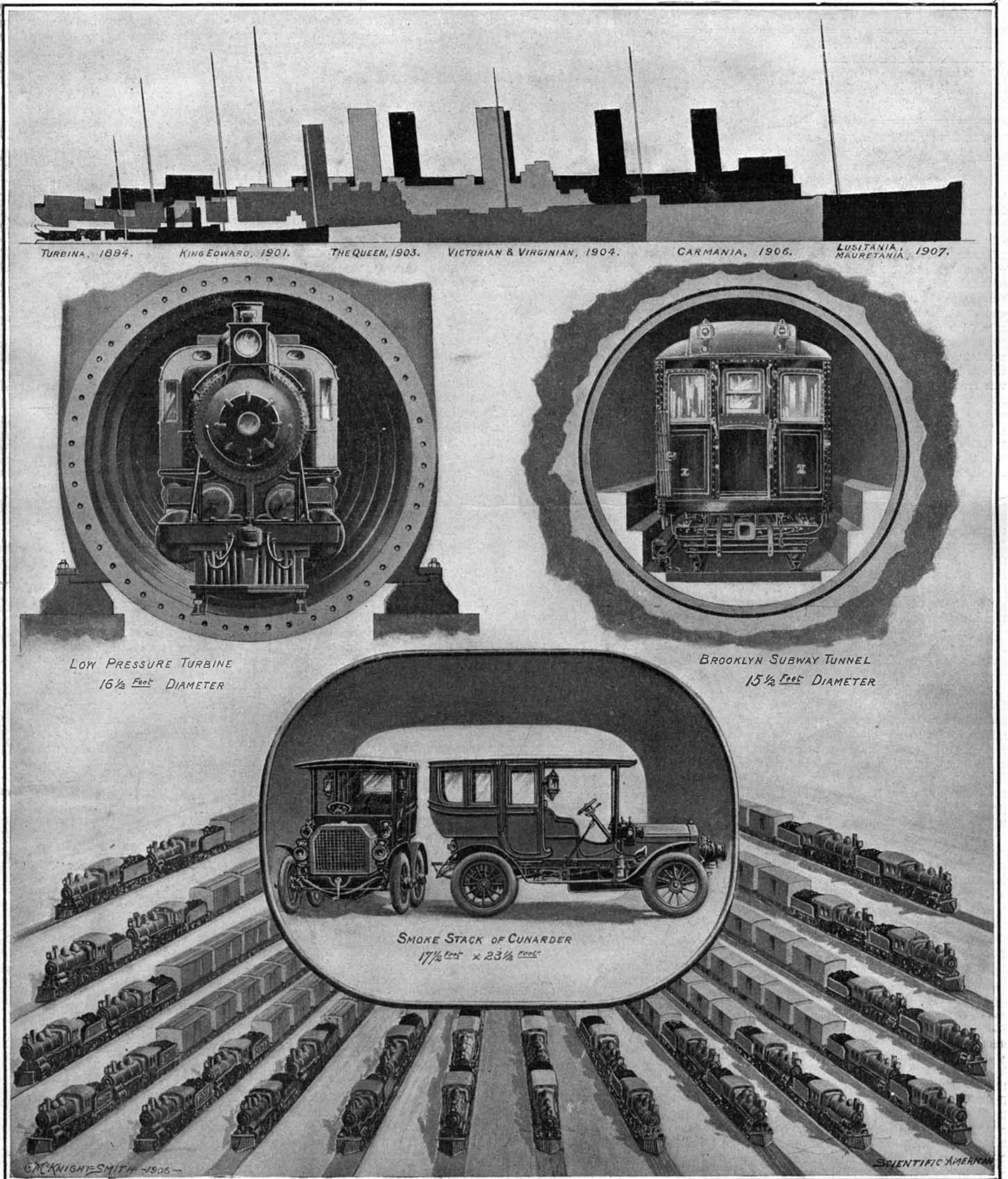

The 68,000 horse-power of the new Cunarder's turbines will equal the combined horse-power of 82 powerful freight locomotives. To generate sufficient steam for the turbines, one thousand tons of coal will be consumed in the 192 furnaces of the boilers every 24 hours.

WHAT THE MOTIVE POWER OF A 25¼-KNOT LINER MEANS—A COMPARISON.—[See page 447.]

SCIENTIFIC AMERICAN

ESTABLISHED 1845

MUNN & CO. - Editors and Proprietors

Published Weekly at

No. 361 Broadway, New York

TERMS TO SUBSCRIBERS

One copy, one year, for the United States, Canada or Mexico.....\$3.00
 One copy, one year, to any foreign country, postage prepaid, \$4 1/2. 4.00

THE SCIENTIFIC AMERICAN PUBLICATIONS

Scientific American (Established 1845).....\$3.00 a year
 Scientific American Supplement (Established 1876)..... 5.00
 American Homes and Gardens..... 3.00
 Scientific American Export Edition (Established 1878)..... 3.00
 The combined subscription rates and rates to foreign countries will be furnished upon application.
 Remit by postal or express money order, or by bank draft or check.
 MUNN & CO., 361 Broadway, New York.

NEW YORK, SATURDAY, DECEMBER 15, 1906.

The Editor is always glad to receive for examination illustrated articles on subjects of timely interest. If the photographs are sharp, the articles short, and the facts authentic, the contributions will receive special attention. Accepted articles will be paid for at regular space rates.

GENESIS OF THE FIRST SUCCESSFUL AEROPLANE.

In all the history of invention there is probably no parallel to the unostentatious manner in which the Wright brothers, of Dayton, Ohio, ushered into the world their epoch-making invention of the first successful aeroplane flying machine. At a time when the various experimentalists in the field of aeronautics were dumfounded by the failure of the deservedly-renowned Langley to make a practical flight with his government-backed \$50,000 machine, it was suddenly announced that two young machinists had produced an aeroplane which had made a continuous flight, with one of the inventors on board, of over twenty miles at a high speed and under perfect control.

Their success marked such an enormous stride forward in the art, was so completely unheralded, and was so brilliant that doubt as to the truth of the story was freely entertained; especially as the inventors refused either to give access to the machine or to make any statement as to its broad details.

The SCIENTIFIC AMERICAN, however, wrote to the seventeen eye witnesses who were mentioned as having seen the various flights and received letters from these reputable local residents, and published extracts therefrom, which completely set at rest all doubt as to what had been accomplished. Unfortunately, the foreign aeronautical world failed to appreciate the significance of the facts as thus made known; and when Santos Dumont made his recent short flight of a few hundred feet, with a machine built on the lines of the Wright brothers' aeroplane, he secured in Europe the credit for having made the first successful flight.

One of the editors of the SCIENTIFIC AMERICAN was recently accorded the first interview given to any technical journal, in which the Messrs. Wright gave some hints as to what they had actually accomplished, and outlined the investigation which led up to their final success.

After becoming interested in the problem of aerial navigation some ten years ago, the brothers experimented during several summers with a double-surface glider, with which they became so proficient that they could make long glides from the summits of the sand dunes and describe a letter S at the bottom. They improved their machine by the addition of a vertical and a horizontal rudder and a method of twisting the planes to preserve lateral equilibrium. After reaching sufficient proficiency in controlling the machine in gliding, the brothers undertook to transform it into a power-driven machine. As no light-weight gasoline motors were to be had at that time, they were obliged to build their own motor. They decided upon a four-cylinder, water-cooled, horizontal engine, which, when completed, weighed 250 pounds and developed about 16 horse-power, although it would show 24 horse-power for the first 15 seconds.

As they were unable to find any authorities giving definite rules for designing air propellers, they were obliged to work out a theory of their own on this important subject. They designed propellers for their machine, and calculated the speed at which it should travel with the horse-power at their disposal. In the first trial with a motor (in December, 1903) the machine flew at practically the speed the brothers figured it should attain; which speaks well for the truth of their theory of the action of screw propellers. In this first flight the machine went in a straight line a distance of 852 feet against a 25-mile wind. Having proved that the glider would fly with a motor, the brothers returned home, and during the spring of the following year resumed their experiments in a meadow some eight miles from Dayton, where they built a shed to house their machine. The greater part of the spring, summer, and autumn of 1904 and 1905 was spent in experimental work with the new aeroplane. A number of obscure difficulties were encountered, and it was found that the machine acted quite different-

ly from what it did when merely gliding without a motor. In fact, with the motor installed, the operator had to make some moves for control of equilibrium exactly opposite to those which were necessary when the machine was simply gliding. For starting the machine, a light steel rail some 75 feet long was laid on the ground. A small carriage having two double-flanged wheels was placed on this rail and supported the aeroplane. The machine was steadied by one man standing at one side and holding it. It was hitched to a post and held while the motor and propellers were started. Then it was suddenly released and allowed to shoot forward, whereupon it would rise in the air before the end of the rail was reached. As the field was a comparatively small one, approximately rectangular in shape, it was necessary to make sharp turns to keep within its boundaries. In making these turns trouble was often experienced, and there were a number of narrow escapes from serious injury. It was not till October of last year that the brothers found out the cause of this instability, which was not due to instability of the machine so much as to the method of operating it. Soon after this discovery, they were able to make their flight of 24 miles in 38 minutes, or at the rate of nearly 40 miles an hour.

By their method of starting on a special rail the Wrights were able to get in the air with the expenditure of much less power than would have been needed if they had mounted their machine on pneumatic-tired wire wheels running on ball bearings and had run it along on a smooth, hard road. The pull of a machine mounted and run in the latter manner, as is well known, is several times greater than that of one mounted in the former way. This would account for the excessive power required by Santos Dumont to get his aeroplane in the air, as he ran his machine on pneumatic-tired wheels on turf, where the resistance was greater still. It does not explain his comparatively low speed when once he was in the air, however, and this can only be explained by the great resistance of his machine and the inefficiency of the propeller.

One of the chief points wherein the Wrights claim to have made a marked improvement lies in the design of their propellers. Instead of propellers giving 40 to 50 per cent efficiency, they estimate that the new screws which they have designed give fully 70 per cent efficiency.

There is one important point wherein the brothers do not agree with Langley, viz., regarding a plane traveling at a very high rate of speed carrying a greater load with the expenditure of less power than when traveling at a lower rate of speed. That it will carry a greater load they admit, but that less horse-power will be required to drive it is contrary to the law of atmospheric resistance, which is that the resistance increases as the square of the velocity. As a result of this, they find that the weight carried per horse-power expended varies inversely as the speed. At 38 miles an hour, they were able to sustain 62 pounds per horse-power. Consequently, at 20 miles an hour, they could sustain about 125, or at 75, only about 30.

Elsewhere in this issue will be found a photograph and description of the Wright brothers' new motor, with which they are confident of driving their new and large aeroplane, with one man aboard, for a continuous distance of 500 miles at an average speed of not less than 50 miles an hour. Their past successes would seem to give promise that they will accomplish the feat, if not at the first trial, at least in the near future.

THE SEVENTH ANNUAL SHOW OF THE AUTOMOBILE CLUB OF AMERICA.

Among the many evidences of the rapid development of the automobile industry in this country, is the fact that the task of writing a critical review of the great annual exhibitions becomes increasingly difficult with each succeeding year. This is due to the fact that, in design and workmanship, the various makers have approximated so closely the one general type and standard of excellence, that one no longer perceives, at the first view, those striking points of difference, which formerly lent piquancy and broad interest to a properly-written review of these annually recurring events. In the earlier exhibitions, even of as late as three or four years ago, the problem of description resolved itself into one of judicious selection of subjects from the bewildering number of designs that were on exhibition. The great motor contest between steam, electricity and internal combustion was at its height, as was the question of the type and proper location of the motors and of the best form of transmission and drive. A little later there was the keen contest between spark coil and magneto ignition, and between automatically and mechanically operated valves. Today, however, these broad questions have been definitely settled, and with comparatively few exceptions, the cars shown in the Seventh Annual Exhibition of the Automobile Club of America conform, in everything but minor details, to one distinct, easily-recognized type.

To the majority of spectators the first impression

produced is doubtless one of admiration for the general shapeliness of outline and beauty of finish of the cars. This is true even of the smaller and cheaper makes which, by the adoption of certain inexpensive features, affecting the proportions and general contour of the machine, present that stylish appearance which, for some years, has been the distinctive mark of the high-priced, imported automobile. Moreover, the good looks of the moderate-priced cars have been secured without any material sacrifice of good workmanship and materials; and it is to-day possible to secure a powerful, reliable, and handsome American-made car, with sufficient power and durability to stand all the hard service of long-distance touring, at a first cost of from \$2,000 to \$3,000. It is probable that the majority of the cars, which are being sold to-day, range between these limits of price; while at the extremes we have on the one hand the high-powered car of 40 or 50 horse-power, with its limousine top, luxuriously upholstered, and provided with a dozen conveniences in the way of telephones, annunciators, heaters, refrigerators, and electric light, and costing from \$10,000 to \$14,000; and on the other hand we have the trim little runabouts, which are said to have given during the past year very good service, for the moderate sum of \$500.

The present *résumé* of the show will be supplemented in our forthcoming automobile number by illustrations of the more important machines and novelties exhibited. The type car carries a four-cylinder gasoline engine under a bonnet at the front end. This engine is generally of from 24 to 30 horse-power, and has the characteristics of water-cooled cylinders, mechanically-operated valves (the latter being placed generally at the side of the cylinders) and either high or low-tension magneto ignition. The drive is by propeller shaft and bevel gear through a three-speed progressive or four-speed selective type transmission. Such touring cars are capable of carrying five persons comfortably, and they are ordinarily provided with the increasingly-popular folding top. While there are many variations from this type, they form a comparatively small minority. The most striking development of the year is undoubtedly the great popularity of the high-powered runabout, provided with a rumble for the use of an additional passenger or for the mechanic, or even (as was recently seen on Broadway) for a full-fledged "tiger" in silk hat and cockade. These runabouts are a development of the small-powered runabout of previous years. They are of much greater power than their prototypes, some of them running as high as 40 or 60 horse-power. As far as smartness of appearance goes, they are decidedly the handsomest and most graceful-looking machines of the year, and they are doubtless destined to great popularity. We have already spoken of the limousine top, which, for winter use, bids fair to become in the larger cars almost the prevailing type. The addition of this top adds greatly to the appearance of size and weight of the cars, some of the largest of the limousine cars, and notably the foreign importations, being really imposing specimens of the coach builder's art.

Although some of the makers are showing six-cylinder cars, the present exhibition does not indicate that this is to become the prevailing type. In spite of its unquestioned advantages, due to the more even torque secured, there is the disadvantage of more complication due to a greater number of parts. There is a tendency to a steady increase in the cylinder capacity, which is due, no doubt, to the national temperament, which makes the driver prefer, if possible, to run continuously on the high speed, even where sharp hills have to be negotiated. On the other hand, we are inclined to think that equally good results could be secured if drivers would learn to make a more judicious use of the change-speed gears; for after a little experience, it will be found that as good average speed results would be obtained if the gears were properly manipulated with moderate-powered cars as are now sought by the more exclusive use of the high speed in connection with larger cylinders. The foreign makers, indeed, are already turning from their stock cars of 50 and 60 horse-power to the more moderate 40-horse-power cars of an earlier day.

The air-cooled type of engine seems to maintain its popularity; and judging from the results obtained during the year in the various endurance trials, this type is capable of showing as high and even higher economy, at least in the more moderate powered cars, as the water-cooled engines. The type was tested severely in the recent Vanderbilt cup and elimination races, where one make, using a positive feed of air through casings inclosing the cylinders, entered three cars each of 110 horse-power. The failure of these cars was due entirely to structural defects back of the engines, which, we understand, gave excellent running results, both in the elimination trials and in the race itself. While the steam car does not seem to gain in popularity, one or two first-class makes appear to be holding their own, and one of them, at least, has introduced an improvement in the way of a feed-water heater which is claimed to be giving excel-

lent results in fuel economy. Electric cars are holding their own for the particular class of work to which they are specially suited, although the reiterated promise that a new battery of large capacity and high economy will be placed on the market, does not yet appear to have been fulfilled.

Tires carrying some form of non-skid reinforcement bid fair to become the prevailing type of the future. Judging from the disastrous results in the last Vanderbilt cup race, American makers have not yet discovered a thoroughly reliable method of attaching the steel-riveted leather strips to the tires; and, indeed, it was due to the stripping of this reinforcement, that the excellent cars entered by the American contestants failed to make a better showing in that race. The best makes of American tires are showing first-class qualities in every respect, and as soon as we have mastered the non-skid problem, our best cars will be in every respect equal to the best of those turned out in Europe. In the matter of wheels there is a tendency to increase the size, 32 and 34-inch wheels taking the place of the 30 and 32-inch wheels of last season; while the diameters have increased to 3½ inches for the front and 4 inches for the rear wheels.

The prevailing type of transmission from the engine to the rear wheels includes the leather clutch, change-speed sliding gears, and either the shaft or the chain drive, with a preference in the majority of cars for the former. There is room for improvement in the design of the clutch; as is proved by some creditable efforts which are being made in this direction, and which were on exhibition at the Show. Two or three cars show double clutches, of which the smaller (generally metallic) takes hold first and gives the preliminary impulse to the car, while the larger and leather-faced clutch takes hold a moment later, as the car is accelerated to the higher speed. A modification which deserves special mention is that shown on a new racing car, which was built for the Vanderbilt cup race, but was completed too late to enter, in which the bevel gears are carried on a jack shaft, from which the drive is transmitted to the differential by means of spur gears. The object of this arrangement is to avoid any side thrust on the differential. In this particular car, moreover, was afforded an excellent opportunity to study the great refinement of materials and designs which is necessary in producing a modern racing car. The material throughout the car is chrome nickel steel, and the change-speed gears with their shaft, besides several minor parts, such as brackets, have been machined entirely out of the solid ingot.

The friction drive is still making a commendable struggle for recognition, and two or three cars which use this type, including a heavy motor truck, are on exhibition. In one of these there are two friction disk wheels, leather covered, carried on the main drive shaft, while between them is a transverse split shaft carrying two friction drive wheels. By means of a lever, placed at the right-hand side of the driver, the two friction disks can be thrown into the forward or reverse position, while the change of speed is effected by moving the same disks out or in to the center of the flywheel disks—this change of position being effected by a hand wheel located on the steering shaft below the steering wheel.

There are those who believe that the real future of the industry lies in the field of the motor truck. Certainly the displacement of the horse-drawn vehicle by the motor-driven truck is making steady progress. That the latter is destined ultimately to obtain almost exclusive control of the field, is assured by the fact that careful tests of the relative economy of the horse and the motor have shown that there is an average saving in favor of the latter of at least 20 per cent in cost; while over and above this are the many conveniences of storage, cleanliness, compactness, and more easy flow of traffic in congested districts, which may be urged in favor of the motor car. While most of the machines shown were driven by gasoline engines, some very powerful and excellently-designed electric-driven trucks were also on exhibition. One of the handsomest and most formidable of these was a five-ton truck, in which the motors were carried directly on the wheels. The axles and much of the gear of this truck were formed of manganese bronze, the parts being largely of a powerful I-section, and the whole truck showing evidence of a very careful and scientific design. A novelty among the gasoline trucks was one propelled by a two-cylinder two-cycle gasoline engine, which embodied all the best features upon up-to-date touring cars.

Space forbids any lengthy mention of the elaborate exhibition of sundries, which occupied an unusually large space in the Grand Central Palace. One of the most useful and commendable novelties was the provision of a tool and spare parts case, which was built into and formed the back of the tonneau. The whole of the back was covered by a board filled with recesses for the various tools arranged in convenient order. In the center of this board was a compact set

of drawers containing spark plugs, waste, oil cans, and a hundred-and-one small items liable to be needed in an emergency. There was also space for two spare shoes, while at the sides were pockets to contain a couple of spare inner tubes. The whole arrangement was closed in by a couple of hinged doors molded to the curve of the tonneau back.

To automobilists a few comments on the show which opened in Paris on December 7 may not be without interest. From cabled accounts it would seem that this year's show has very little that is new to offer. So far as outward appearances go, the Grand Palais looks very much as it did in 1905. Even last year's stands are used, because new designs would have involved a heavy expenditure. The cars too offer little, if any, novelty. The only striking feature of the show is the lavish use of 6-cylinder motors. Apparently about 75 per cent of the French designers have pledged themselves to six cylinders. The tendency evinced last year of using metal instead of leather clutches is more pronounced than ever. Almost without exception the more powerful models are equipped with metal clutches. Many cars too have been equipped with the live axle or Cardan system of transmission, the live axle being for the most part independent of the transverse shaft. It may be safely said that the live-axle machines outnumber those driven with chains.

THE PATENT OFFICE IN 1906.

The report of the Commissioner of Patents on the business of the Patent Office for the fiscal year ended June 30, 1906, shows that there were received during that year 55,619 applications for mechanical patents, 821 applications for design patents, 172 applications for reissue, 1,938 caveats, 10,888 applications for trademarks, 943 applications for labels, and 438 applications for prints. The number of patents granted, including reissues and designs, was 31,837, and there were registered during the year 10,408 trade-marks, 741 labels, and 354 prints. The number of patents which expired was 20,682, and 5,193 applications which had been allowed were forfeited by operation of law for non-payment of the final fee.

The total receipts of the office from all sources amounted to \$1,811,297.84; and the total expenditures were \$1,538,149.40, leaving a surplus of receipts over expenditures of \$273,148.44, which surplus was turned into the Treasury.

While the act of February 20, 1905 (33 Stat. L., 724), amending the trade-mark law so as to authorize, among other things, the registration of trade-marks used in interstate commerce, became effective under its terms on April 1, 1905, no registrations were made under said act until after the beginning of the present fiscal year. This was owing to the fact that the law requires publication of the trade-marks in the Official Gazette of the Patent Office prior to registration. During the last three months of the fiscal year 1905, 9,710 applications for registration were received, and during the present fiscal year the number received was 10,888. This represents an enormous increase in the work of this character to be performed by the office force; and the number of trade-marks registered during the past year, 10,408, also shows an increase amounting to 500 per cent over the registrations for 1903 and 1904, which were approximately 2,200 for each year. These increases are due entirely to the liberality of the new trade-mark law, which not only makes a wide extension of the class of marks susceptible of registration, but reduces the cost of the proceedings therefor.

From a comparative table of the general operations of the office embodied in the report it appears that during the last seven years there has been an average increase of more than 59 per cent in the various classes of work performed in the office. Yet the increase in the number of employees from 1899 to the close of the past fiscal year was only 11.9 per cent. By the legislative, executive, and judicial appropriation act of June 22, 1906, Congress provided for an increase of 29 examiners of all grades, and of 21 in the clerical force. This increase of course did not become available until after the close of the fiscal year; but it is confidently expected that a gratifying condition of the work of the office will be shown at the end of the next fiscal year. Indeed, it is stated that an improvement in the conditions can already be observed. In this connection the commissioner suggests that, inasmuch as experience has shown that the work of the office has a regular substantial growth in times of prosperity, this condition might well be met by a moderate, regular annual increase in the force of examiners and clerks. The applications of all classes awaiting action at the close of the year were 21,958, as against 16,077 at the close of the preceding year.

Substantial progress has been made in the reproduction of exhausted copies of patents, and practically all printed copies are reprinted without delay upon request. The correspondence, drafting, furnishing of copies of patents and of records have been transacted with a fair degree of promptness, and some improvements in methods in the clerical divisions have been made.

Attention is invited to the fact that, instead of obtaining the illustrations for the Official Gazette from private contractors, in connection with which system the dummy card process has hitherto been used, the entire work upon the Gazette is now executed at the government printing office, and, in the illustrations, zinc etchings have been substituted for the photolithographic reproductions which were made from dummy cards. The change has been found to work satisfactorily. The legislative, executive, and judicial appropriation act of June 22, 1906, made a reduction in the appropriation for producing the Gazette of \$70,000, and it is estimated that at least this amount will have been saved by the change described by the end of the next fiscal year.

The act of June 22, 1906, making appropriations for the legislative, executive, and judicial expenses of the government for the fiscal year ending June 30, 1907, contains the following provision:

"For rent for storage for patent office model exhibit, ten thousand dollars, or so much thereof as may be necessary; and the Secretary of the Interior shall dispose of a part or all of the models of said exhibits, either by sale, gift, or otherwise."

Immediately after the passage of this act, the commissioner of patents was instructed to ascertain what models could be disposed of as required by the act without injury to the interests of the service. From the report of the commissioner, it appears that a very large proportion of the models in the so-called model exhibit of the patent office form a valuable part of the records of the office, and that the disposal of the same would work a grave injury to the service, since reference thereto by the office, by patent attorneys, and at the instance of courts, is frequently necessary. A question also arose as to the effect of the foregoing provision upon section 484 of the Revised Statutes, which reads as follows:

"Sec. 484. The Commissioner of Patents shall cause to be classified and arranged in suitable cases, in the rooms and galleries provided for that purpose, the models, specimens of composition, fabrics, manufactures, works of art, and designs, which have been or shall be deposited in the patent office; and the rooms and galleries shall be kept open during suitable hours for public inspection."

The question was accordingly submitted to the assistant attorney-general of the department as to the effect upon section 484 of the Revised Statutes of the clause in the act of June 22, 1906, above quoted; and the opinion of that officer was to the effect that section 484 was not repealed by the enactment in question.

Thereafter a contract was entered into for the renting of the second, third, and fourth floors of the Union Building in Washington, the building in which these models have heretofore been exhibited, during the present fiscal year at a rental of \$10,000, the amount appropriated by the act. Subsequently, correspondence was begun with the secretary of the Smithsonian Institution to ascertain whether any portion of the models not a part of the records could be placed in the National Museum for exhibition purposes, and if so, which models were desired and could be accommodated in the buildings of the institution. The officers of the institution have indicated their willingness to receive and provide for a portion of the patent office models, and the selection of the models to be transferred to the custody of the institution is now under consideration.

THE CURRENT SUPPLEMENT.

In the SCIENTIFIC AMERICAN SUPPLEMENT, No. 1615, an article is published by Frank C. Perkins on electrically-operated pneumatic hammers in which German, American, and English types are described and illustrated. Dr. Hans Kuzel has invented a process by which the most refractory and obstinate metals can be made into lamp filaments. This process is described by J. Swinburne. It is not an easy task that confronts the amateur constructor of a large induction coil when he reaches a point in his work where he must choose the type of interrupter that he intends to use. Mr. A. Frederick Collins tells in a very clear way just how an independent interrupter can be constructed. His article is accompanied by complete drawings. Full details of construction are given. Some very interesting experiments have been made in Vienna for the purpose of studying the phenomena of fires originating on the stage of a theater, and determining the best methods of safeguarding the audience. The results obtained in this experimental theater are given. Other articles of interest are those entitled "Treatment of Rivers with Shifting Channels," "The Collecting and Testing of Carbonic Acid for the Purpose of Carbonization," "Greenhouse and Conservatory Heating," "The Accessibility of the Pajarito Ruins," "Mars as a Place to Inhabit," and "Gas as a Source of Power." Mr. Craig S. Thoms's article on "How Seeds are Carried" is concluded. Those interested in the gas turbine will find the article on the "Gas Turbine and the Turbine Compressor" of value.

RIGHTING A CAPSIZED LIGHTHOUSE CAISSON.

BY STUART STEVENS SCOTT.

There is now in progress off the mouth of the Magothy River, in the Chesapeake Bay, 20 miles from Baltimore, an engineering feat that has attracted much attention in the engineering world. The work consists of the righting of a gigantic caisson that is intended to be the foundation for a lighthouse, to be known as the "Baltimore" light, which is to stand at the entrance of the Craighill Channel, that leads from the Chesapeake Bay to the Patapsco River, but which, shortly after having been placed in position, capsized. The method employed in getting the great wooden box to its correct position is novel and interesting.

As will be seen by the line illustration, the caisson is designed to rest upon the bottom of the bay, 85 feet beneath the surface of the water and to be sunk through mud and sand to the required depth. Even after the caisson is righted the sinking of it to this depth will in itself be no mean task. It will be the first time that any attempt has been made to go to that depth for the foundation of a lighthouse, and the first attempt to sink a caisson of any kind to such a depth so far from shore, as the site of the structure is two miles from the nearest land.

In order to stand the strain and the great weight that is to rest upon it, for it is estimated that the completed structure will be a concrete monolith weighing nearly 10,000 tons, it was necessary to have the caisson of great size and strength, and it ranks as the largest of its kind ever built. The plans were prepared by the United States Lighthouse Department, and in the spring of 1904 the contract was awarded to a New York firm, the price for the structure complete being \$150,000.

The caisson was built in the harbor of Baltimore, and it is 48 feet square and 23 feet high. The first 7 feet is entirely of wood, the smallest timber being 12 feet long and 12 inches square, while the largest is 48 feet long and 12 inches by 24 inches. There was considerable difficulty experienced in procuring the large timbers, and when they arrived in Baltimore they were the largest single sticks that had ever been seen in that port. The timbers in the caisson were laid in alternate layers, lengthwise and crosswise, each course being laid in pitch and the seams firmly calked. As the line drawing shows, the structure is a bottomless box. It contains 1,100,000 feet of lumber, and it is bolted together with 26,000 spikes, ranging in length from 21 inches to 90 inches. On the lower lip of the caisson was placed a cutting edge of half-inch iron to assist it in biting its way through the bottom.

When the caisson was completed, with the first course of the iron plates placed in position the structure weighed 972 tons. Considerable difficulty was experienced in getting it into the water and it became necessary to dredge around it. When it floated it drew 20 feet, and in the first week in September, with two tugs towing the caisson, and a fleet of barges and scows bringing up the rear, the flotilla left Baltimore. The contractors were favored with beautiful weather; and when they reached the site of the lighthouse the bay was as smooth as glass. They placed the structure in the proper position and began to sink it by loading it with massive stones and cement. For several days the weather remained good, but during the second week a northeaster set in.

As the site is exposed to a sweep of 25 miles from the northeast, it was not long before the sea made up

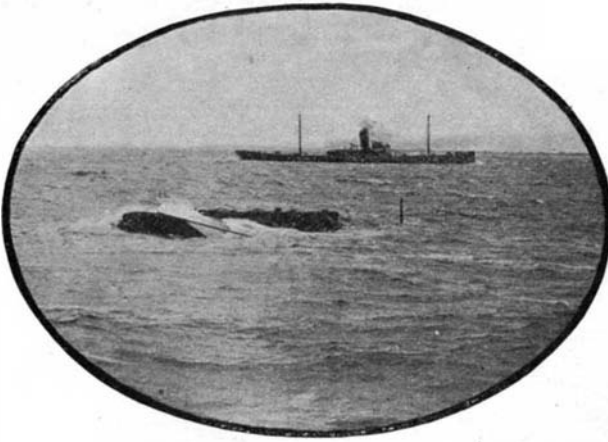

The Capsized Caisson as Abandoned After the First Attempt to Right It.

so heavy that the fleet of barges and tugs had to seek harbor, and the caisson, after being anchored as firmly as possible, long lines being led in every direction, was abandoned. The next morning the contractors observed that the caisson listed heavily; and they braved the raging storm in an effort to check its further settling, but although they risked their barges and the lives of their men in a valiant effort, the great

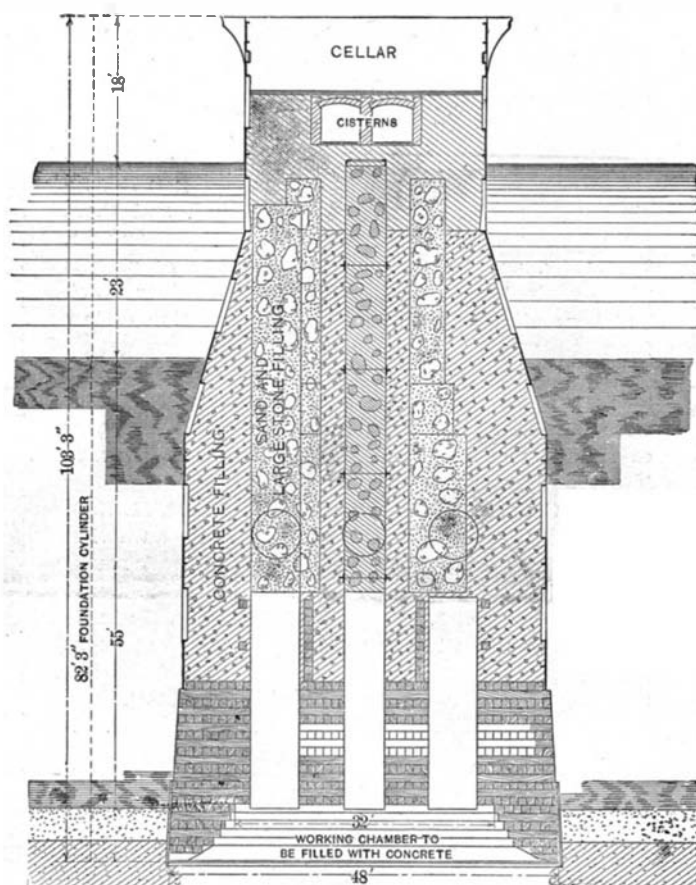

Vertical Section of the Baltimore Lighthouse Caisson, Showing Depth to Which It Will be Sunk.

wooden mass slowly keeled over until it lay on its side. The government, which on October 1 was to have made the first payment of \$50,000, declined to meet the obligation when it was learned that the caisson had capsized, and the contractors had to abandon the work.

The United States Fidelity and Guaranty Company, which was responsible for the amount of the contrac-

tors' bond, instructed Messrs. Wood & Flannery, the present contractors, to go ahead and see what could be done. This was in the fall of last year. They found the structure just awash, as shown in the first photograph, and they decided upon the course that is now being carried out.

Early last spring, after the ice had gone, they began the erection of a pier on either side of the caisson. Owing to the formation of the bottom, which was of soft mud for a considerable depth, it was necessary to drive 100-foot piles, and by the first of August the piers, 40 feet wide and 120 feet long, were completed. There were then laid on the upper side ten 50-foot 12-inch square timbers, bolted securely. The ends of the timbers projected out over the iron cylinder, and the whole was firmly bound with wire cables. Then, on the after part of the caisson and resting on the foundation of timbers, an A frame was erected. The frame is 55 feet high, and from the base there projected ten 70-foot weight arms, and to each of the latter there were swung 20 tons of pig lead, making a total of 200 tons. It was estimated that, by using the lower lip of the caisson as a fulcrum, the actual weight to be lifted would not exceed 500 tons, and it was estimated that the weights could be supplemented by derricks.

In order to obtain for the derricks as much of a purchase as possible, there were built two "sticks," each 70 feet long and 24 inches square, which the divers put in place through the central shaft in the caisson. From the ends of the "sticks" wire cables led to two great derricks, one on either pier.

When everything was in readiness the derricks were started, and slowly the caisson was raised until it is now in the position shown. It has been found that the weights have lost their effectiveness and the caisson, hanging at an angle of about 45 degrees, will come over no farther, although the derricks prevent it slipping back.

The contractors have rigged a powerful suction pump, and there is now in Baltimore a barge being fitted out with boilers and compressors, and the contractors are preparing to dredge away the mud from under the under lip and cause it to settle, keeping it in position by cables from the piers, and thus gradually bring it to an upright position. The caisson will then be sunk according to the original plans.

Cleaning and Taking Apart Machines.

When one has to take apart a machine for the purpose of cleaning it and of making any repairs that may be found on inspection necessary, the proper way is not to take the whole thing apart, then to put it together and next to test it to see if anything is broken or out of place; but to test the machine *before* taking it apart, then to inspect each piece and mend or straighten it, and after that to clean the whole thing and assemble.

If, on the contrary, cleaning is done before repairing, all the repaired parts will have to be cleaned again, thus not only increasing the cost of the job, but prolonging the time of delivery—which latter is a very important element when we are dealing with typewriting machines.

It is reported that a scheme is on foot to construct a dam across the Rhône at Seyssel in order that electrical energy may be generated there and transmitted to Paris by an overhead line.

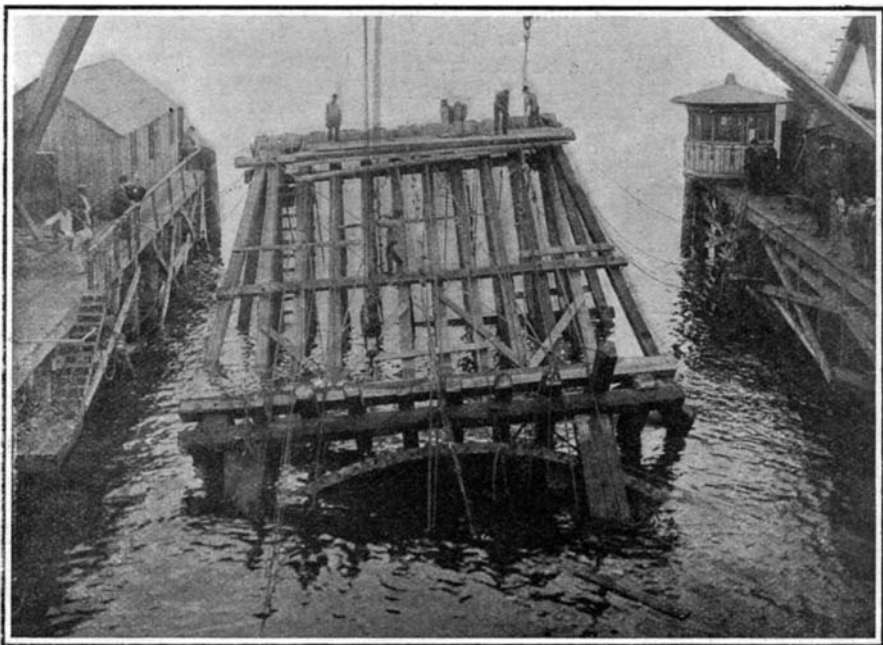

The Sunken Caisson After the First Stage of Righting.

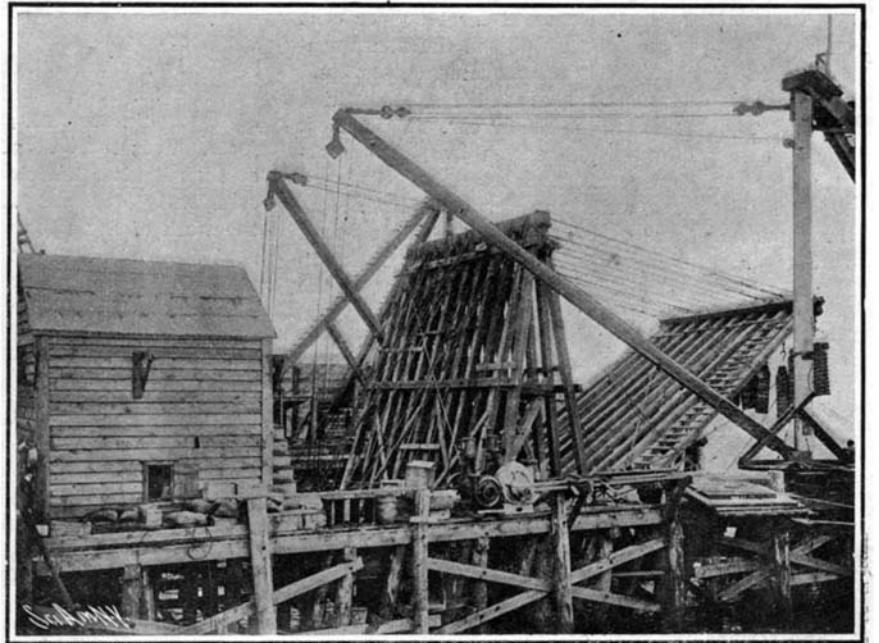

View Showing the A-Frames, Booms, Weights, and Derricks for Pulling on the Caisson.

AUTOMATIC APPARATUS FOR SELLING POSTAGE STAMPS, POST CARDS, AND NEWSPAPERS.

BY ROBERT GRIMSHAW.

Many will wonder just how the various apparatus which have been contrived to distribute tickets, chocolate packages, cigars, etc., are constructed, and how they operate. Of course, the construction and operation must vary with the nature of the article to be sold, but one principle extends through all—the opening of a certain orifice by the passage of a coin of definite size and weight and by means of no other. The one illustrated in Fig. 1, and which is not patented, is one of a number of suggestions made to the German Imperial Post Office Department for the distribution of postage stamps. With reference to the sketch, *M* shows a strip of stamps that is pushed along a path, *B*, by means of a comb-like device, *K*, which grips in the cross row of perforations. This comb, *K*, is automatically shifted in the direction of the length of the strip of stamps, and to an amount corresponding exactly with the length

of one stamp if they lie lengthwise of each other, or to the amount of the width of one stamp if the strip is as wide as the stamp is. Then while the piece *D* presses the strip of stamps against the path, the cutter *S* comes up and slices off one stamp at the perforation line. The knife, the pressure piece *D*, and the comb, *K*, are then brought back to their original positions, and are all three automatically locked against any further movement until freed by the passage of a coin of proper diameter, thickness, and weight. Fig. 2 shows a device proposed for the automatic sale of postal cards. These are mostly sold in pairs or in fives at a time. The trouble with these articles is that by reason of their rough edges they are apt to stick together. In the arrangement here proposed, the cards are arranged beforehand in twos or in fives or

as desired; the sets of two, five, or what not being piled up crosswise of each other in a cylindrical holder, *B*. The upper layer or set, *K*¹, is held by two springs, *F*¹ and *F*².

When a coin of the proper size and weight is dropped in the slot, the drum *B* can be turned so far on its axis that the upper layer or set of cards, *K*¹, is freed from the pressure of and from contact with the springs, and can fall out; while the second set, *K*², comes under the springs.

Germany intends to buy or make forty thousand "automatics" for selling postage stamps; so inventors might find it desirable to keep their eyes on this field.

Germany intends to buy or make forty thousand "automatics" for selling postage stamps; so inventors might find it desirable to keep their eyes on this field.

Dr. Cook Ascends Mount McKinley.

Dr. Frederick Cook's ambition to ascend Mount McKinley was born of his desire to try polar equipment in high mountain climbing, his fifteen years' experience in polar expeditions fitting him well for the venture. He had served as surgeon twice under Commander Peary, once in 1891 and again in 1901, and with Capt. Amundsen in the Belgian Antarctic expedition of 1897-99. Dr. Cook was accompanied on this trip by Prof. H. C. Parker, who teaches physics in Columbia University, New York; Russel W. Porter, topog-

rapher; Belmore H. Brown, naturalist; Walter Miller, photographer, and J. H. Beecher. The explorers left New York on May 1, and arrived at Seattle May 10, where they were joined by Fred Paine and Edward Barrelle, who acted as packers; John Dokkin, a miner, and several others, increasing the number to ten in all. The most interesting feature of the high-moun-

and a 25-horse-power engine for navigating swiftly-moving streams, was constructed in Seattle. On May 16 a start was made for Cook Inlet on the Alaskan coast, which point was reached May 28. In the boat, stocked with provisions for six months, the expedition went up the Susitna and Yentna rivers to the head of navigation, where pack horses were waiting to join them. The passes which the party found at the head of the Yentna River could not be traveled, so it was decided to try to reach the southeast of Mount McKinley. After a tramp of 65 miles through marshy country, the explorers were confronted with perpendicular cliffs rising to a height of 1,500 feet. As it was now early in August, it was decided to abandon the idea of reaching the summit for the time being, and to devote the time intervening to scientific work of a different nature.

Mr. Porter and two assistants went to the south of Mount McKinley, to make a map of the triangle between the Susitna and Yentna rivers. Mr. Brown and Beecher started for the mouth of the Matanuska River to collect zoological specimens, and Mr. Prince and Mr. Miller arranged to go to the mouth of the Keechatna River, also for the purpose of obtaining zoological specimens.

Dr. Cook, Barrelle, and Dokkin, while navigating the Susitna, Chulitna, and Tokositna rivers in the launch, discovered a glacier which sweeps the upper eastern slope of the mountain, and which proved to

be a good route to the summit of Mount McKinley. After exploring this glacier for three days, the northeastern ridge of Mount McKinley was reached. Although snow fell all day, this proved the most agreeable part of the journey. On the top of the ridge, which was reached the fourth day after leaving the boat, was a granite cliff which rose 4,000 feet in the air. Here a house was dug in the snow, as it was impossible to pitch a tent. By cutting steps in the ice, a climb of 2,000 feet was accomplished on the fifth day. As the explorers could not get back to the camping place where they had left Dokkin, beds were cut out of the ice. Wrapped in sleeping bags, the party rested for the night. A climb of 2,000 feet was made on the sixth day, which proved to be the last comfortable day the explorers spent on their way to the summit. They were attacked with nose bleeding, snow blindness, difficult breathing, and depressed heart action. On the seventh day a climb of 2,000 feet brought the expedition nearly to the top. On the eighth day the march for the summit was made very early in the morning. On the way up two peaks were encountered, of which the southwestern one was chosen. The summit was reached at 10 o'clock. So great were the sufferings of the explorers, that they remained but twenty minutes at the top. The American flag was planted about 200 or 300 feet below the peak, and a record of the trip with the names of the men, the line of march, the date, and the temperature was left. The descent was made in four days.

From observations made with his instruments, Dr. Cook believes that the mountain is 20,300 feet above sea level. It will take several months before

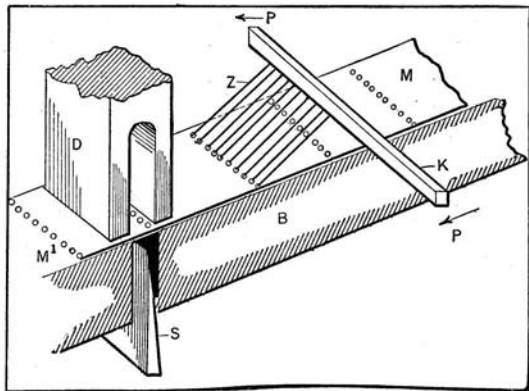

Fig. 1.

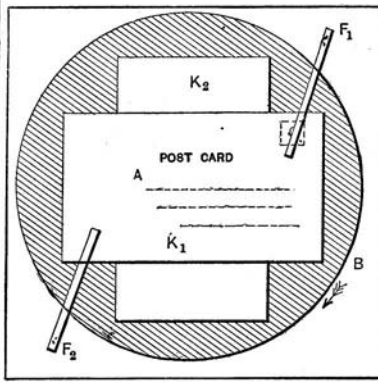
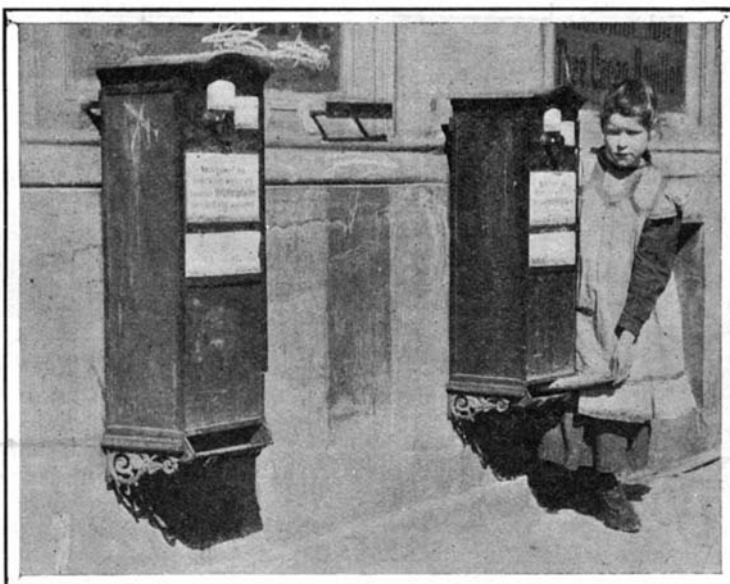

Fig. 2.

The Principle of an Automatic Postage Stamp and Post Card Selling Machine.

tain-climbing outfit was a large tent made of Shantung silk, which weighed three pounds and was large enough to hold three persons. Heretofore the tents used in mountain-climbing equipments weighed thirty and forty pounds. The sleeping bags were made of eiderdown covered with silk, and so fashioned that they could be used as coats. The Swiss axes which formed part of the outfit were covered with tubes, so that they



A Machine for Selling Newspapers.



Stamp Selling Machine.

could be used as tent poles. The food was much the same as that carried in polar expeditions—pemmican, dry beef, beef tallow in equal parts, and sugar, which was used instead of salt, as it would be difficult to get a sufficient supply of water to satisfy the thirst caused by using salt with the food. Each man's outfit, weighing about fifty pounds, was strapped to his back. A special launch, forty feet long, of shallow draft



A German Machine Which Sells Postage Stamps.

he will have completed his mathematical calculations in order to give the exact height. Barometric pressures and triangular measurements from twelve different points were taken. In scaling the mountain Dr. Cook realized a life ambition, and besides obtained geographical information about a country of which very little is known.

TOTAL ECLIPSE OF THE SUN IN JANUARY, 1907.

BY MARY PROCTOR.

"Eclipses are predicted, and science bows them in."

The next total eclipse of the sun takes place on January 13, 1907, and will be visible in central Asia. The track of the eclipse is wholly on land, and gives the last favorable opportunity for observing an eclipse until that of April 17, 1912, which may be witnessed for one minute in South America, and for a brief interval in Spain.

The best region for observing the 1907 eclipse is available by means of railways recently constructed in Russian territory. On this railway, and about two-thirds of the way from Tashkend to Samarkand, lies Jizak, only a few miles from the exact line of central eclipse. Fortunately, the railroad from Orenburg to Tashkend, practically a branch of the Trans-Siberian Railway, which has been in course of construction, is now completed. Other easily accessible places near Jizak, and well within the belt of totality, are Zamin, Nau, and Ura-Tiube. The last is practically central.

From the United States, the best way to reach Jizak is by means of Naples, Constantinople, the Black Sea, Tiflis, the Caspian Sea, Bokhara, and Samarkand. From Krasnowovsk on the Caspian Sea to Tashkend trains run regularly, there being two trains which leave Krasnowovsk daily at 5 A. M. and 7:15 P. M. respectively.

If we go farther east, the track of the eclipse leads into a region more and more difficult of access, although the totality lasts a few seconds longer, and the eclipsed sun is a few degrees higher. Only one station in Mongolia, Tsair-osu, seems likely to be considered. In *The American Journal of Science*, for March, 1906, Prof. David P. Todd, of Amherst Observatory, has given the position of ten possible observing stations, exact local times of the four phases, durations of totality, and other interesting facts.

As shown by the map (taken from the *Nautical Almanac* for the year 1907) the middle of the eclipse occurs at sunrise in a region north of the Black Sea, the track crossing the Caspian Sea, where the eclipse begins at sunrise. It reaches Jizak in Turkestan about a quarter to nine, totality beginning at 9 h. 59 m. 58.4 sec., and ending at 10 h. 1 m. 55.2 sec., the duration being about two minutes. Jizak is thirteen miles south of the central line, while Ura-Tiube is only two miles south, and practically central. There the eclipse begins at 8 h. 50 m. 52 sec., totality being at 10 h. 6 m. 37.1 sec., and ending at 10 h. 8 m. 40.9 sec., a duration of two minutes and seventeen seconds.

At Tsair-osu in Mongolia, which is two miles north of the central line, the eclipse begins at 12 h. 29 m. 58 sec., with totality at 1 h. 49 m. 41.6 sec., and ends at 1 h. 51 m. 36.7 sec., a duration of about one minute and fifty-five seconds.

It appears that no expedition from any of the well-known American astronomical institutions will observe the eclipse, and in all probability no eclipse expeditions from Europe will attend, on account of such unfavorable weather conditions liable to prevail, and uncertain communication with the difficult region (Russian Turkestan).

The following eclipse will be that of January 3, 1908, and will be wholly confined to the Pacific Ocean, with the possibility of observing stations on two islands. A brief account of these islands will show how little they are adapted for such work. One named Flint Island, one of the Line group, is situated west of the Marquesas Islands, in long. 151 deg. 48 min. W., and lat. 11 deg. 26 min. S. It belongs to the British, and was discovered in 1801. It is covered with brushwood and trees, and is visible from the masthead of a ship from a distance of sixteen miles.

This little island is about $2\frac{1}{2}$ miles long N.N.W. and $\frac{1}{2}$ mile broad S.S.E., and is fringed by a steep coral reef which dries at low water, and extends seaward quite a distance. In the interior of the island are two small lagoons of brackish water. Not a very promising prospect for the most enterprising observer, despite the fact that the duration of totality will be four minutes, and the sun's altitude will be 74 deg.

In 1880 the island was uninhabited, and the buoys formerly in use were gone. There is no rise and fall of tide, and the landing is said to be very bad, even for surfboats. These interesting facts are to be found in the *Monthly Notices of the Royal Astronomical Society* for March, 1906, and were contributed by Dr. A. M. W. Downing, F.R.S. He gives a still less favorable report of Hull Island. This island is situated halfway between the Marquesas Islands and Solomon Islands, in long. 172 deg. 13 min. W. and lat. 4 deg. 30 min. S.

Hull Island, one of the Phoenix group, belongs to

the British, and was discovered and so named by Wilkes in 1840. It has a lagoon and a little fresh water, and there are some coconut trees on it, about 50 feet high. A coral reef fringes the island, and landing is difficult except by entering the lagoon by means of the boat passages on the northwest side. There is no anchorage. In 1899 the island was uninhabited.

The winds are almost constantly from the eastward, but squalls accompanied by light rain occur in the neighborhood all the year round. The wind is variable from January to May, during which period bad weather is most common. Small chance there is there of observing the eclipse with any success, since it occurs on January 3, and totality only lasts 2 m. 51 sec. The sun's altitude will be 43 deg.

Both these islands have been leased to Lever's Pacific Plantation Company, and intending observers are requested to communicate with the officers of this company, situated at Port Sunlight, Cheshire. Such is the irony of fate, permitting one of the grandest sights the eye of mortal can ever behold to waste its glory on these almost inaccessible islands! On December 23, 1908, another eclipse track will cross the South Atlantic Ocean, and on June 17, 1909, an eclipse will occur in the neighborhood of Greenland.

The South Antarctic regions will be crossed by an eclipse track May 9, 1910, and another will visit Australia, May 28, 1911. On all these occasions, since the eclipse tracks lie almost wholly across oceans, or in inaccessible parts of our globe, no observations of value can be made. This is due to the fact that no device for securing accurate astronomical observations from the deck of a ship has yet been perfected, while to reach the inaccessible regions tedious and expensive expeditions are necessary.

At a meeting of the British Astronomical Association which met at Sion College, Victoria Embankment, on June 20 last, Mr. W. T. Lynn, one of the members, read a paper on the total eclipse of January 13, 1907.

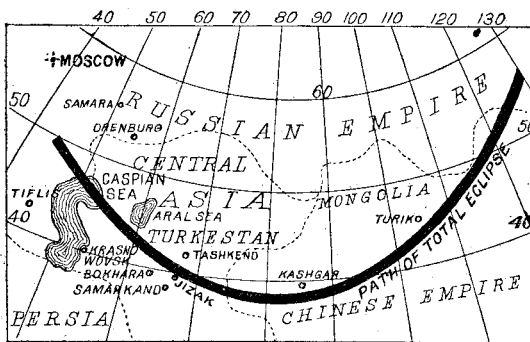

PATH OF THE ECLIPSE OF THE SUN, JANUARY, 1907.

In it he referred to the fact that "the Russian government has recently established an observatory at Tashkend, nearly due north of Samarkand, and no doubt the astronomers there will observe the total eclipse at the latter place." He also referred to the fact that the second catalogue of stars ever made was formed at Samarkand by Ulugh Beg. In 1437 Ulugh Beg, the grandson of Tamerlane, built at Samarkand the greatest astronomical observatory in the world, one hundred and forty years before Tycho Brahe erected Uraniborg in Denmark.

After Mr. Lynn read his interesting paper, Mr. A. C. D. Crommelin, the president of the Association, remarked that "unfortunately the next eclipse is one that only those should venture to go to see who are prepared to brave an Arctic degree of cold. As a general rule, they regarded an eclipse as a favorable one when its track is mostly over land, and as an unfavorable one when its track is mostly over water. The track of the eclipse of next January is entirely over land except for a few of the lakes of central Asia; and yet it is a very inaccessible eclipse, for it is over Tibet and Siberia in the depths of winter, and he is afraid the cold there will be very severe indeed." The president, however, called particular attention to the total eclipse of January 3, 1908, and hoped that some of the members of the association would be represented at this, although the journey would be a long one.

Is it any wonder, when we realize that although a total eclipse occurs every year from 1907 to 1912, and that none are easy to observe between those dates, that no effort has been made to observe the total eclipse of January 13, 1907, at one at least of the ten possible stations whose positions have been so carefully computed by Prof. David P. Todd.

Inasmuch as there is a difference between the civil and the astronomical day, some confusion may arise from the conflicting dates on which the eclipse will occur. The astronomical day begins at noon; the civil day at midnight, twelve hours earlier. Hence according to the one system the eclipse will occur on January 13, and according to the other on January 14.

Correspondence.

Alcohol from Cacti.

To the Editor of the SCIENTIFIC AMERICAN:

The profitable manufacture of denatured alcohol from cacti has been found to be feasible by G. A. Burns, chemist, manager of the Southern Pacific Hospital, San Francisco, prior to the fire, who is now in Los Angeles. Mr. Burns declares that much desert land in California and New Mexico can be reclaimed by the growing of cactus, the manufacture of alcohol from the plant, and the use of the alcohol as fuel for power plants to pump water for irrigating. Mr. Burns says he knows for a certainty from his own experiments that denatured alcohol can be produced in sufficient quantities from the common desert tree—so monotonous to the tired eyes of the tourist coming from the East—to furnish heat, light, and power for all general farming purposes. From five pounds of pulp he distilled, in a crude way, more than a gallon of alcohol, which was clear in color and burned readily with a very bright, warm glow.

The product contains four times as much energy as wood alcohol. He believes it can be produced cheaply, and that five acres planted to cacti would be large enough "power plant" to run a farm of 160 acres. The plants could be cut down, ground up by special machinery, and put through the process of fermentation and distillation like corn, wheat, or barley. The surplus steam escaping from a stationary engine on the farm could be utilized in the process of distillation. The Nevada cactus grows from two to five feet high and with great rapidity, or about as fast as corn in Kansas. This being the case, it would soon grow up from the stubble or stump, and in about six or eight months would again be ready to produce non-taxable alcohol for commercial purposes.

Mr. Burns first got his idea of the possibilities of the commercial value of the cactus from Mexico, where it is well known that the natives make a very potent liquor from cactus.

Cactus alcohol could be produced more cheaply than wood alcohol, besides being four times as powerful. The raw material too would be right on the farm.

The plan could be adapted readily to the valley of Las Vegas. It is fifty miles long and on an average thirty miles wide. It is of a sandy loam, very fertile and very level, and with only a trace of alkali at odd places, and those places are few.

"Everything," said Mr. Burns, "that California produces, with the possible exception of oranges, can be grown in this valley. Water can be had at from ten to twenty feet, and with cheap fuel to pump it to the surface, such as I am convinced can and will be obtained from the cactus, Las Vegas will become a little Eden."

ALLIE ALGER.

Sawtelle, Cal.

A Plea for the Preservation of the Salton Sea.

To the Editor of the SCIENTIFIC AMERICAN:

Conditions and circumstances connected with the flow of the Colorado River into what is known as the Salton Sink have occasioned considerable comment in various publications; and since the strenuous efforts of government and railroad engineers to divert the river back into its original channel have succeeded, it has been advocated that means should be taken to retain the new sea in approximately its present dimensions, the argument being advanced that evaporation from this new body of water has caused rains the past season in sections of the Southwest where like precipitation has been almost wholly if not entirely unknown before. In opposition to this it is contended that the unusual rains have been merely coincident, without being caused either directly or indirectly by the new lake.

When considered with more than passing notice, and contemplated from the standpoint that from a seemingly not greatly important incident might come results of unthought-of beneficent effect to a very great part of the whole country, and when such effect really seems developing, then the matter becomes an interesting one, and is apt to attract the attention of anyone who looks forward to future eventualities, as well as to the first visible results. I am of the opinion that those who contend for the permanent retention of the Salton Sea are correct in their conclusions that the new sea has caused and indicates a decided modification in climate; and the unusual rains in the West and Southwest, especially in the latter section, the past season may only have been an indication of what is to continue through other seasons of the year—as instance the recent unprecedented storms in the Southwest. Also I anticipate that if the Salton Sea is retained, climatic conditions in the West and Southwest will experience great if not wonderful changes; and if such changes do result, I apprehend that they are brought about, not entirely alone because of fresh water evaporation from the new lake, but also and very considerably because of the attendant chlorine evaporation, that has its source in the immense salt

beds at the bottom of the new sea. To achieve similar results (though as far as I know an unrecognized fact) is one of the purposes of the saltiness of the ocean; that is, that the evaporation of chlorine assists in producing rains; and, again, another purpose is that the evaporation of chlorine from the ocean provides the chlorine constituent of the ozone of the air.

It might not be an absurdity to anticipate that the permanent preservation of the Salton Sea would reclaim the arid waste, and make the desert to blossom as the rose; prevent and do away with the "hot winds" that sweep up from New Mexico across western Kansas and up into Nebraska, destroying millions of dollars' worth of crops; save the government millions of dollars that would otherwise be necessary for irrigation projects, which produce only small local results at great cost in comparison with the extensive benefits which might possibly be permanently secured without cost and without attention by the retention of the new sea.

There seems to be a chance for realization of anticipated hopes, and the matter may be worthy of serious consideration, as with sufficient rainfall the section now known as the arid Southwest would develop into the most wonderfully fertile region of the entire country.

M. REED.

Chicago, December 1, 1906.

THE MOTIVE POWER OF A 25¼-K

One of the most impressive manifestations of the modern steam engine is up-to-date freight locomotive starting or fifty cars, and gathering way, until it is thundering over the rails at a speed of thirty miles an hour. When we attempt to understand very well what is meant by the power of a single loaded freight car, it is necessary to compare it with the power of men as can lay their hands on a united propulsive effort. And hence, when we see not one, but forty or fifty loaded cars, started from rest and swung into their full stride by a single locomotive, the latter becomes symbolical in the popular mind of majestic power.

It is for this reason that, in our attempt pictorially to represent the horse-power which will be necessary to drive the new Cunard liners at 25¼ knots an hour, we have taken the average-sized freight locomotive as our unit of comparison. The least amount of power which the designers of the "Lusitania" and "Mauretania" found would be necessary to drive these ships at their contract speed was 68,000 horse-power. Now, the horse-power of the average freight locomotive is about 2,100, and, consequently, the total thrust on the four propellers of each of these ships will be equal to the total pull exerted by thirty-two modern American freight engines. One of these locomotives could haul on the level a train of fifty cars, whose total length would be just a third of a mile. Consequently, the whole 68,000 horse-power of the Cunarder, expressed in terms of locomotive work, would be sufficient to haul a train of 1,600 cars, whose total length would be over five miles. In our front page illustration the artist has given a graphic representation of these figures by grouping together sixteen double-header freight trains on parallel tracks.

To develop a minimum of 68,000 horse-power, and a maximum that will possibly run up to 75,000 or 80,000 horse-power, calls for a boiler and engine plant of truly titanic proportions. Steam will be supplied by twenty-five cylindrical boilers, of which twenty-three are double-ended and two single-ended, the former being 17 feet 3 inches in diameter and 21 feet long. The coal will be burned in these boilers on 192 furnaces, the total area of whose grates would be represented by a square measuring 64 feet on each side, containing about 4,000 square feet of surface. Night and day, an army of several hundred firemen will be continuously shoveling coal into these furnaces, where it will be burned at the rate of about 1,000 tons every twenty-four hours; and to insure that the coal is burned at a fierce white heat, the air will be forced through the grates continuously by means of powerful electrically-driven fans, the rush of air being also assisted by the four great smokestacks, through which the products of combustion will be discharged high up in the air at about 150 feet above the level of the grate bars.

These smokestacks are worthy of special mention, for in addition to their great height, they will be far larger in sectional area than any that have been previously constructed. In order to present less resistance to the atmosphere, which, even on a day when there is not a breath of air stirring, will be, on account of the great speed of the ship, equivalent to a 30-mile gale, the smokestacks will be made of a general elliptical section, slightly more pointed at the ends and not so flat on the sides as the sectional view shown on our front-page illustration. Each smokestack will measure 17 feet 6 inches on its minor axis

and 23 feet 6 inches on its major axis. That these are extraordinary dimensions is shown by the fact that two large limousine automobiles could be contained within one of the smokestacks, one standing in the direction of the axis and the other transversely to it, as shown in the illustration referred to. Another standard of measurement is afforded by the fact that two modern steam railroad tracks could be laid side by side within one of these smokestacks, and full-sized trains run within it with a slight clearance in every direction.

When the completed engine room is entered, it will be found that the machinery has been designed on the same colossal scale. Here are four turbines driving as many shafts, the two outer shafts being driven by two high-pressure turbines and the two inner shafts by two low-pressure turbines; while at the after ends of the low-pressure turbines, and on the same shaft, are two additional turbines for driving the ship astern. Each high-pressure turbine casing is 10 feet in internal diameter and 25 feet in length. These are big dimensions, but the surprise will come when one enters the low-pressure turbine engine room; for each of the low-pressure turbine casings has an internal diameter of 16 feet 6 inches. Here again, for comparison, we turn to the modern locomotive; for if a pair of rails were laid along the bottom of one of these massive cylinders, it would be possible for one of the largest of our modern express locomotives to pass through the casing and still have a slight clearance between its smokestack and the walls of the cylinder. As a matter of fact, this casing is larger than the cast-iron tube of the Subway tunnel, now being driven from the Battery to Brooklyn, which has an internal diameter of 15½ feet.

Attention is directed to the comparative profile diagrams at the top of the front-page engraving, in which is shown the rapid growth in size of turbine-propelled vessels. The diagrams start with the year 1894, when the little experimental "Turbinia" made her phenomenal speed, and finish with the year 1907, in the summer of which the new turbine Cunarders will make their maiden voyages to this port. The diagram is based upon a paper recently read by the Hon. C. A. Parsons, the inventor of the marine turbine, at a meeting of the Institute of Marine Engineers of Great Britain. The "Turbinia," which was built especially for experimental work, was launched in 1894, and her first engine was of the radial flow type, and gave about 1,500 horse-power. The success of the "Turbinia" led the British government to build two destroyers, the "Viper" and "Cobra," the first of which made a speed of 36.86 knots, which is equivalent to 42.5 miles per hour, the speed of the "Cobra" being slightly less. The "Viper," by the way, holds the record as the fastest vessel of any kind yet constructed; for, as far as well-attested official records go, no vessel of any kind has approached within several knots of this speed.

The next advance, shown in the diagram, was represented by the river Clyde passenger steamer "King Edward," 1901, which was 250 feet long, of 562 gross tonnage, and 3,500 horse-power. She was followed in 1903 by the "Queen," built by the Southeastern and Chatham Railway Company, which was 310 feet long, of 1,676 gross tons, and 7,500 horse-power. The turbine having proved itself for river and channel service, the next advance was the bold one of installing turbines in an ocean liner, and Allan Line steamers, the "Virginian," and "Victorian," each 520 feet in length and of 10,754 gross tons, were equipped with turbines of 12,000 horse-power. It was found that in these larger sizes important modifications of design were necessary, and the lessons thus learned were incorporated in a much larger ship, the "Carmania," built in 1905 for the Cunard Company. This vessel is 678 feet long, 72 feet beam, and 52 feet in molded depth, her gross tonnage is 19,524, and her horse-power 21,000. In the summer of 1907 the "Lusitania" and "Mauretania" will serve to put the marine turbine to a supreme test. These vessels are so much larger than anything existing as to be in a class entirely by themselves. They are 785 feet long, 88 feet broad, and 60½ feet deep. Their gross tonnage will be about 33,000, and they will displace 45,000 tons. Their horse-power, as already stated, is 68,000, and will probably work up to between 75,000 and 80,000.

The contract speed of these ships is 25¼ knots an hour on trial, and they are to show an average of 24¾ knots for a whole trip across the Atlantic.

When the Acetylene Flame Begins to Flicker.

When the flame of an acetylene lamp begins to flicker, showing the presence of wet gas, the strainer should be examined to see whether it is clean and dry, and if not, renewed. Failing this, it is possible frequently to insert a piece of blotting paper between the carbide and the metallic disk which rests upon it, thus drying the gas as it leaves the base of the container. In generators which are fed from above to the top of the carbide, this method is, of course, out of the question.—Bicycling World.

THE SECOND ANNUAL EXHIBITION OF THE AERO CLUB OF AMERICA.

In connection with the seventh annual show of the Automobile Club of America, the sister Aero Club gave its second exhibit of aeronautical apparatus both historic and modern. The exhibit this year was characterized by the up-to-date and practical character of the articles displayed, rather than by their historic interest, as was the case with the exhibit last year. There were, however, several historic machines that were not displayed last year. As heretofore, the walls of the room were covered with interesting photos, enlargements of balloon ascensions and airship flights. Besides a number of enlarged photos of the Wright brothers' gliding experiments, there were prints of Santos Dumont making a flight in his motor-driven aeroplane, as well as enlargements of this machine and its motor. Several baskets of the club balloons, one of them being that of the "United States," in which Lieut. Lahm and Major Hershey won the Bennett trophy, were on exhibition. Hung from the ceiling were the nacelles of two of the most successful American dirigibles—the "California Arrow" of Capt. Baldwin, and the airship which Leo Stevens built for Major Miller, and which is the only one in which a woman has made a flight.

The former airship, which has a cigar-shaped envelope of 9,000 cubic feet capacity, holds a record for speed of about 17 miles an hour. This is remarkable considering the size of the engine, which is only a 2-cylinder, 7-horse-power V motor, similar to that shown on page 449. The propeller, which is about 8 feet in diameter, makes about 400 revolutions per minute. Another interesting exhibit that hung from the ceiling was a peculiar winged kite exhibited by Henry Rodmeyer. This gentleman also demonstrated a model of a flapping-wing machine on the roof of the building on one day during the show. Another crude model of a beating-wing machine was exhibited and demonstrated daily by Mr. A. V. Wilson, who was one of the first American aeronauts to make a balloon ascension and parachute jump. This gentleman claims to have made a flight of over 1,700 feet in a beating-wing machine two years ago, the *reductio ad absurdum* of his claim being found in the fact that the machine—a cumbersome wood affair—was propelled by himself alone. A full-size flapping-wing machine, invented and constructed by Amos Drew two years ago, was one of the historical exhibits. This machine, which weighs 600 pounds and has 350 square feet of supporting surface, is fitted with a 3-cylinder air-cooled motor that is ridiculously small for doing the heavy work of flapping the long, narrow wings of the machine. The Gillespie aeroplane (which we illustrated some time ago) was another historical exhibit. Mr. Gillespie also had on exhibition a new double-surface model made up of four sets of twin planes.

Passing now to the new apparatus, about the only thing in the aeroplane line was a large model built of wood and cloth by the inventor, Miss E. L. Todd, who has sought to obtain automatic stability of the aeroplane by suspending the framework below it in a novel manner, while she has also provided for a rigid connection of the planes and the car when necessary. A. Roy Knabenshue showed the framework and motor of his aeroplane, all of which looked too light to be very practical. There was also shown an experimental helicopter apparatus of Carl Dienstbach. The body framework of Gustave Whitehead's latest bat-like aeroplane was shown mounted on pneumatic-tired, ball-bearing wire wheels and containing a 3-cylinder, 2-cycle, air-cooled motor of 15 horse-power direct connected to a 6-foot propeller placed in front. This machine ran along the road at a speed of 25 miles an hour in tests made with it last summer. When held stationary, it produced a thrust of 75 pounds. The engine is a 4¼ x 4 of an improved type. Whitehead also exhibited the 2-cylinder steam engine which revolved the road wheels of his former bat machine, with which he made a number of short flights in 1901. He is at present engaged in building a 100-horse-power, 8-cylinder gasoline motor with which to propel his improved machine.

The main feature of the show this year was the display of light-weight aeronautical gasoline motors. The lightest of these for its horse-power was the 5-cylinder, water-cooled motor built by Prof. Langley in 1903 for use on his full-sized aeroplane. This engine, the cylinders of which are in the same vertical plane arranged radially around the crankshaft, weighs but 125 pounds and develops 52.4 horse-power. Its weight per horse-power is therefore but 2.3 pounds. With spark coil, batteries, 25 pounds of water, etc., the total weight is but 200 pounds, or 3.8 pounds per horse-power. As it is only within the last two years that any motor of such small weight per horse-power has been produced, it will be seen that Prof. Langley was ahead of his time in this line as in others.

The next lightest motor per horse-power developed was a 4-cylinder, two-cycle, air-cooled engine, the invention of Mr. George J. Altham. This consists of two pairs of opposed cylinders placed side by side in adjacent vertical planes. One piston of each pair is con-

nected to a crank in the usual way, while four straight rods (see cross-section) tie it to the piston in the opposite cylinder. These rods pass through brass bushings in a plate that closes the base of the second cylinder. A separate annular chamber of the same size as the crank case is provided for the initial compression of this second cylinder. In the diagram the piston of the second cylinder is at the top of its stroke, while that of the first cylinder is at the bottom. The charge of the latter is being transferred around the piston through transfer box, *T*, and is being deflected upward, as indicated by the arrows. The exhaust is at the same time taking place on the opposite side of the cylinder. The second piston has just uncovered the inlet port, *I*, and the vacuum made by the upward stroke of the piston is drawing a charge into the space below this piston for the initial compression. The motor, it will be seen, is of the three-port type, there being no valves whatever. The carbureter used with this motor has a float chamber, from which extends a vertical pipe, *P* (see diagram), containing three small holes for spraying the gasoline. A special cone-shaped aluminium valve, *V*, surrounds this pipe and is held down by a spring, *S*. In starting, or when the motor is running at low speed, the air is drawn in through the inlet pipe, *A*, and down around the bottom of the valve, as indicated by the arrows. The narrow passage around the pipe, *P*, makes a strong suction, and causes the gasoline to be drawn upward and to flow in a proper mixture with the air into the inlet pipes, *B B*. As the speed of the motor increases and the suction becomes stronger, the valve, *V*, is raised from its seat, and allows the air to pass directly by it to the inlet pipes of the motor. As the valve, *V*, is raised, it uncovers two more holes in the spray nozzle pipe, *P*, thus allowing

more gasoline to be drawn and to mix with the air in a chamber provided in the top of the carbureter. Suction is, therefore, kept practically constant around the base of the spray nozzle pipe, and the amount of gasoline that is fed is controlled mechanically by the action of

the exhaust chambers and heads of the motors to keep them cool. All of the engines have a standard-sized cylinder having a bore and stroke of $3\frac{1}{4}$ inches. They are one of the most practical air-cooled motors built in this country, and the 8-cylinder engine, which weighs

125 pounds and develops 30 horse-power at 1,800 R. P. M., is the very latest attempt at making a high-speed, light-weight, multiple-cylinder motor for aeronautical work. This engine has a hollow crankshaft of $1\frac{1}{8}$ inches diameter. Its 5-pound flywheel carries twenty-three fan blades. The weight of this motor is slightly over 4 pounds to the horse-power. Although it is not so light in proportion to the power developed as is Langley's motor, still it has none of the complications made necessary by the water circulation system of the latter, and its cylinders are so small that it should be able to run without much difficulty from overheating.

The most interesting motor on exhibition was the new 4-cylinder, four-cycle, water-cooled engine built by Messrs. Orville and Wilbur Wright, of Dayton, Ohio, and intended for use on their new aeroplane. The cylinders of this engine are of cast iron and have a bore of $4\frac{1}{4}$ inches, while a 4-inch stroke is used. The engine weighs complete only 160 pounds.

The cylinders are mounted upon an aluminium crank case, and are jacketed with sheet aluminium. The valves are located in the heads of the cylinders, the exhaust valve only being mechanically operated. The motor is fitted with make-and-break igniters operated by cams on a transverse shaft placed beside the heads of the cylinders, this shaft being driven by bevel gears from the cam shaft of the motor. The time of the spark can be changed by a small handle provided for this purpose. The connecting rods are made of hollow steel tubing. A solid flywheel of light weight is used. The engine looks

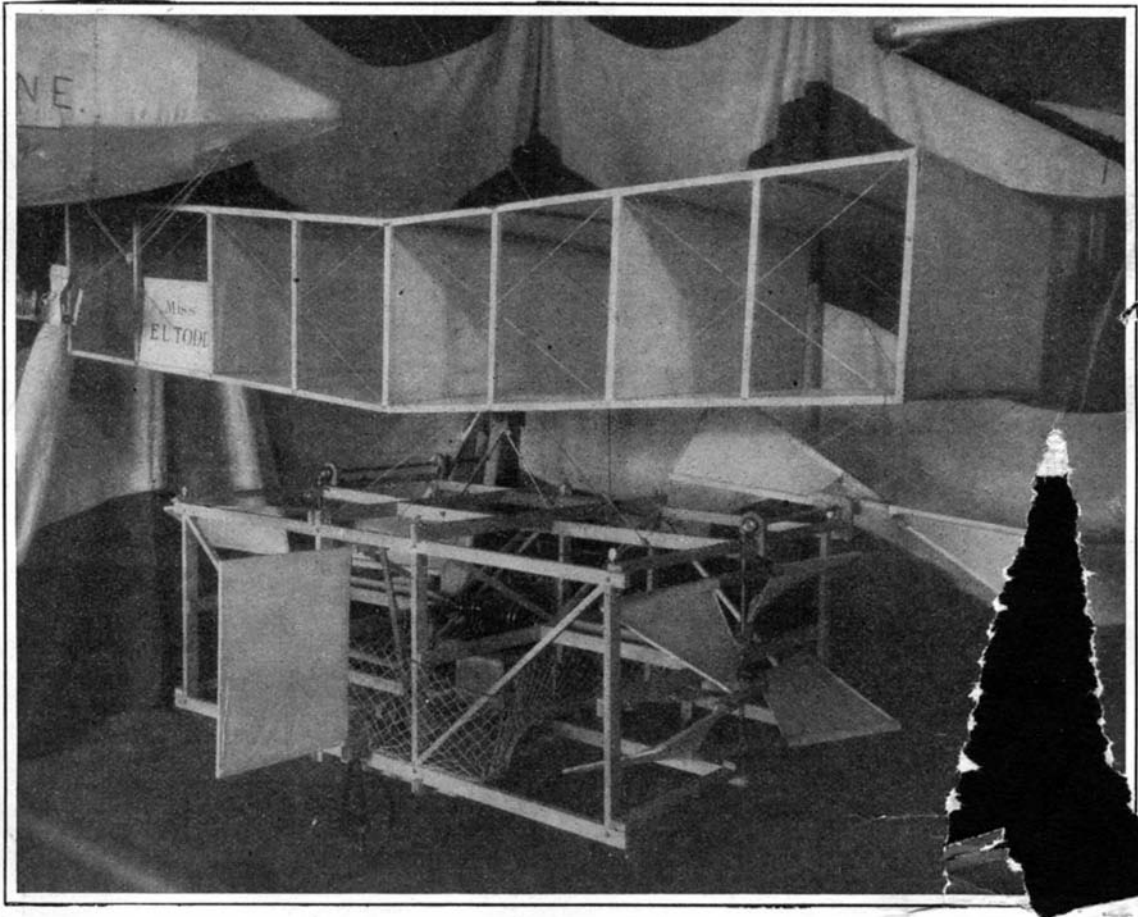

LARGE SIZE MODEL OF AN AEROPLANE HAVING BOTH LIFTING AND PROPELLING SCREWS.

the valve, *V*. The carbureter is rather different from the usual automatic type. It was specially designed for use with a two-cycle motor.

The Curtis line of motors, which has been developed from the original two-cylinder V motor intended for use on a motor bicycle, was very complete, and ranged from a single-cylinder motor to one of the 8-cylinder V type. All of these motors are air-cooled. The method employed for cooling most of them is the use as a flywheel of a large wire-spoked wheel carrying small fan blades. These blades create sufficient draft upon

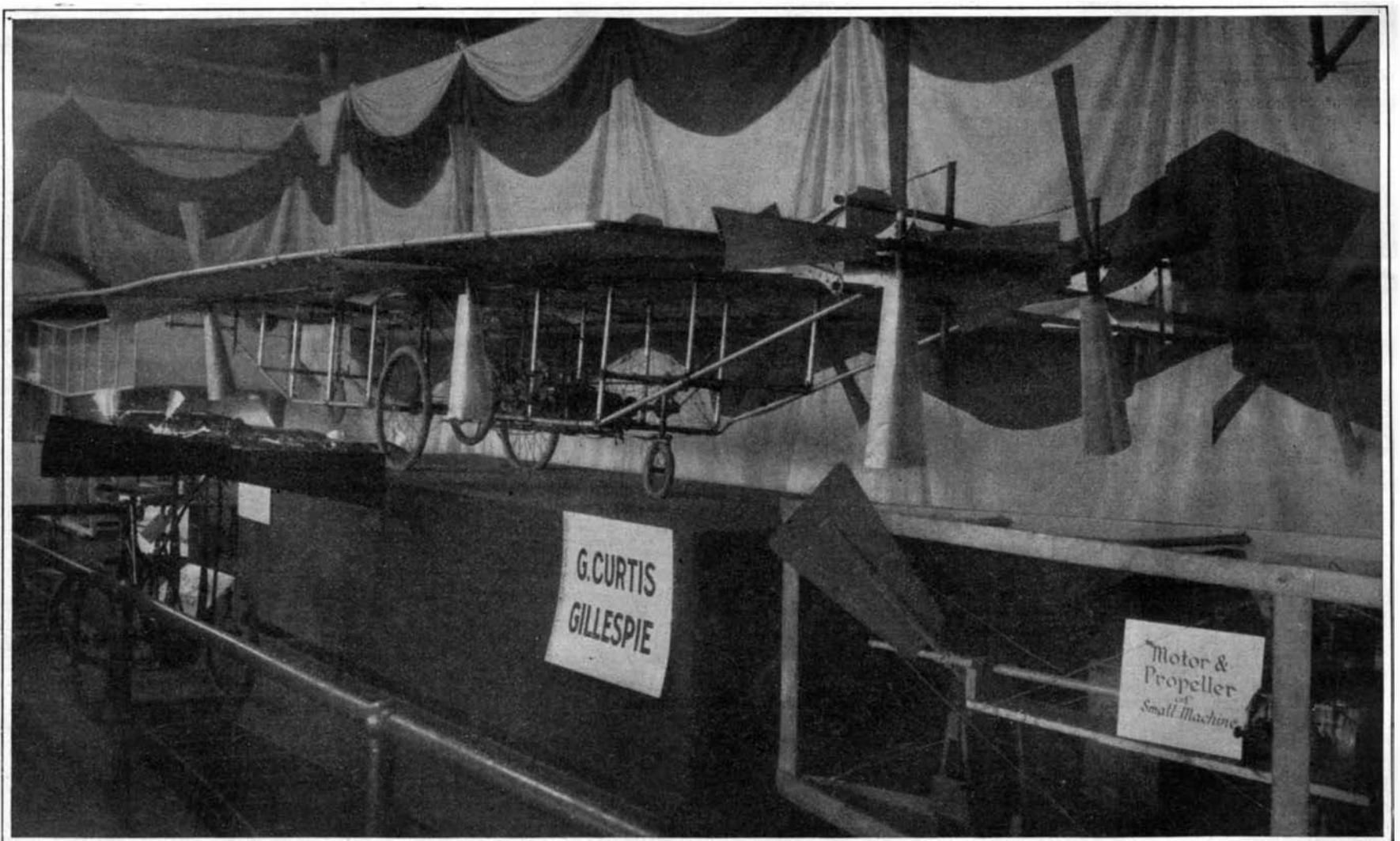

THE GILLESPIE AEROPLANE WITH MULTIPLE PROPELLERS.—AN INTERESTING HISTORICAL EXHIBIT.

Prof. Pickering's Wind Tricycle for testing propellers.

Rear End of Body Framework of Whitehead's Aeroplane. The motor and propeller seen belong to a smaller machine.

much heavier than it really is, and one can hardly realize that it weighs but slightly more than 5 pounds to the horse-power. The Wright brothers' original motor, with which they made a flight three years ago, was much heavier than the new one. its weight

Mr. Dey states that he can design large sizes that will come between 2 and 3 pounds per horse-power. The cylinders are made of heavy seamless steel tubing, which have been rotated before a gang of cutters in a milling machine, cutting grooves about $\frac{1}{4}$ inch deep

tator being used. A ball governor automatically changes the spark lead to correspond with the speed. There were several other 4-cylinder air-cooled motors on exhibition, but the ones described were the most novel and well-built of all.

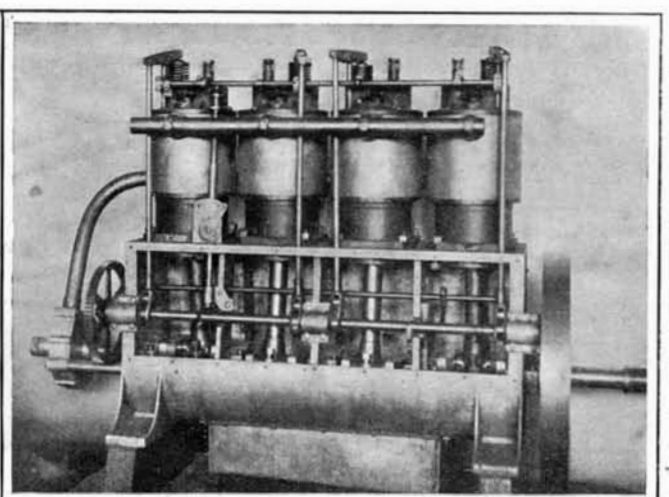
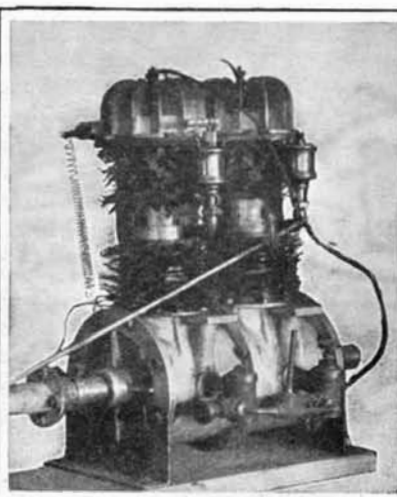
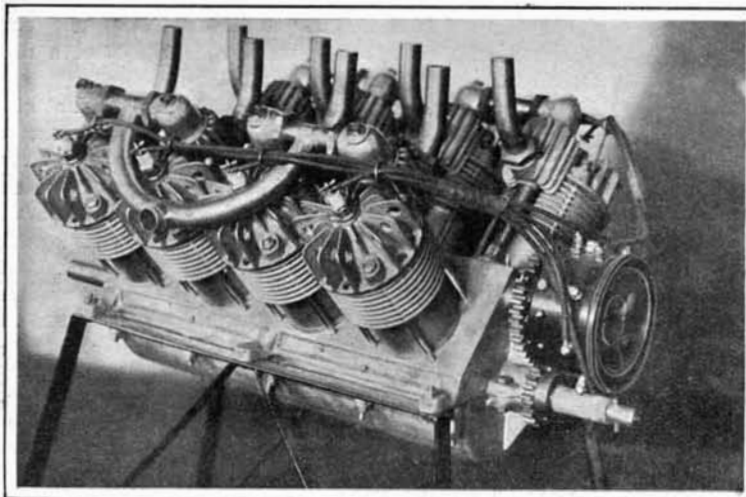

The Curtis 8-Cylinder, Air-Cooled, V-Motor, of 30 Horse-Power.

The Whitehead 2-Cycle Motor.

Wright Brothers' 28 to 30-Horse-Power Aeroplane Motor.

Weight, 125 pounds. Cylinders, $3\frac{1}{4} \times 3\frac{1}{4}$. Speed, 1,800 R. P. M.

Weight, 35 pounds. Horse-power, 6. Speed, 1,000 R. P. M.

Weight, 160 pounds. Cylinders, $4\frac{1}{4} \times 4$. Speed, 1,200 R. P. M.

complete being about 250 pounds. The valves were arranged in chambers upon the end of pipes that screwed into the cylinder heads. The valve chambers were not water-cooled, and it is probably due to this fact that there was a sudden loss of power after the motor had been run half a minute. The former motor developed but 16 horse-power. It was a 4-cylinder motor, water-cooled, and resembled the present motor in general contour. When used in the aeroplane, it is located in a horizontal position. The new motor is sufficiently powerful to drive an aeroplane carrying two men a distance of 200 miles at 45 miles an hour, or one man can be carried 500 miles at 50 miles an hour.

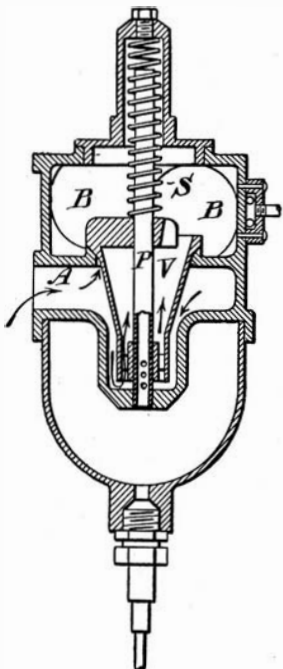

Cross-Section of Altham Carbureter.

Another interesting motor was a 4-cylinder one designed by Harry E. Dey, of 309 Arlington Avenue, Jersey City, N. J. It has a bore and stroke of $2\frac{1}{2}$ and 3 inches respectively, and is rated at $7\frac{1}{2}$ horse-power at 1,500 R. P. M. It can be speeded up, however, to about 2,500 R. P. M. Its weight complete with flywheel is 86 pounds. This engine was designed and used for automobile work. For aerial work it could be made much lighter, especially in larger sizes.

and 1-16 inch wide, leaving flanges about 1-32 inch thick between them, the remaining depth of the cylinder at the bottom of the grooves being 1-16 inch.

The heads, which are castings, are treated in the same manner, working from two centers, one being the center line of the valves. What the flanges lack in depth they more than make up for in numbers, so that the radiating surface is greater than that of a cast cylinder. The compression space is only 15 per cent of the total space, but the compression is not abnormally high, due to the unusually strong springs used upon the automatic type inlet valves.

This spring tension, however, may be lightened for emergency work by pressing upon the top of a counteracting spring placed above the main one. This is done by the four fingers attached to a horizontal rod above the valve chambers seen in the photograph. By this means the compression may be made abnormally high for emergency work of short periods. The crank case is a one-piece casting with the exception of the heads, which are bolted on by studs and nuts.

A small eccentric type pump placed on the end of the cam shaft and inclosed in the crank case pumps oil from a tank attached to the under side of the engine to the four crank compartments of the case, thus keeping up a constant level for the splash lubrication. Overflows to the tank are provided for taking care of the excess.

The connecting rods are made up of separate parts. The rod proper is made of rolled tool steel, while the bearing parts at each end are bronze castings riveted together. The design is such that it is next to impossible for them to come apart; the object sought being a very light strong rod for very high speed.

Ignition is by jump spark, a single coil with commu-

Official Meteorological Summary, New York, N. Y. November, 1906.

Atmospheric pressure: Highest, 30.43; date, 4th; lowest, 29.41; date, 15th; mean, 30.06. Temperature: Highest, 64; date, 18th; lowest, 27; date, 29th and 30th; mean of warmest day, 59; date, 19th; coldest day, 34; date, 29th; mean of maximum for the month, 50.8; mean of minimum, 39.0; absolute mean, 44.9; normal is 43.8; average daily excess compared with mean of 36 years, +1.1. Warmest mean temperature for November, 50 in 1902; coldest mean, 37 in 1873. Absolute maximum and minimum for this month for 36 years, 74 and 7. Precipitation: 1.28; greatest in

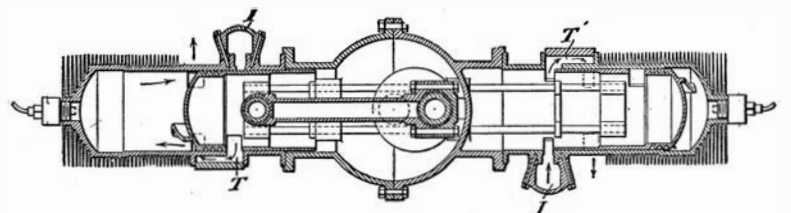

Cross-Section of Altham 2-Cycle Motor.

24 hours, 0.57; date, 15th and 16th; average for this month for 36 years, 3.46; deficiency, -2.18; greatest precipitation, 9.82, in 1889; least, 0.82, in 1890. Wind: Prevailing direction, N. W.; total movement, 9,919 miles; average hourly velocity, 13.8 miles; maximum velocity, 51 per hour. Weather: Clear days, 14; partly cloudy, 8; cloudy, 8. Snow: Trace, 13th; sleet, 15th; fog (dense), 22d; frost (killing), 2d. The temperature of September was 3.8, October 0.6, and November 1.1 in excess, making the autumn months of 1906 average 1.83 degrees above the normal. These months were each below the normal in rainfall except October, the total autumn deficiency being 2.61.

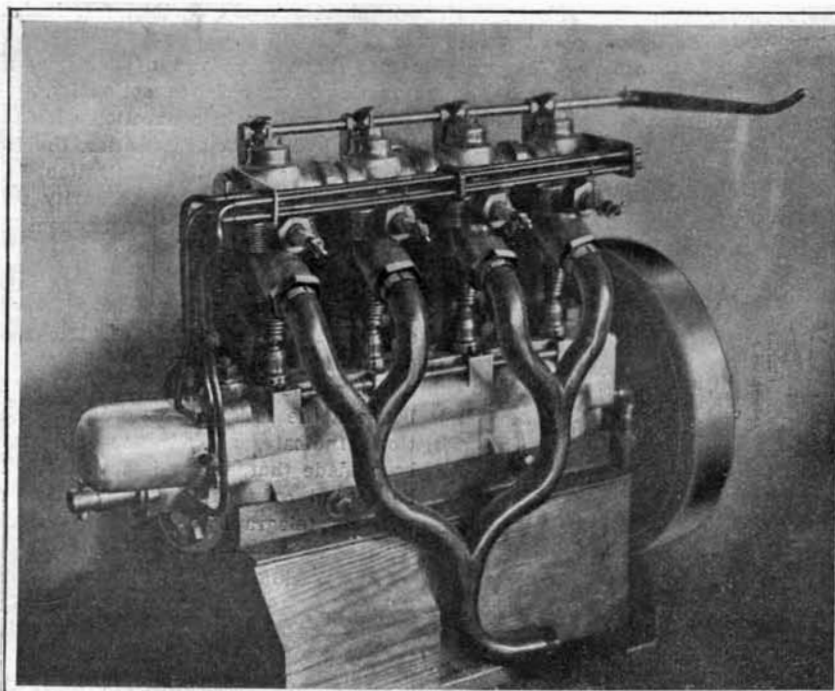

$7\frac{1}{2}$ -Horse-Power Air-Cooled Motor Governed by Variable Compression.

Weight, 86 pounds. Cylinders, $2\frac{1}{2} \times 3$. Speed, 1,500 R. P. M.

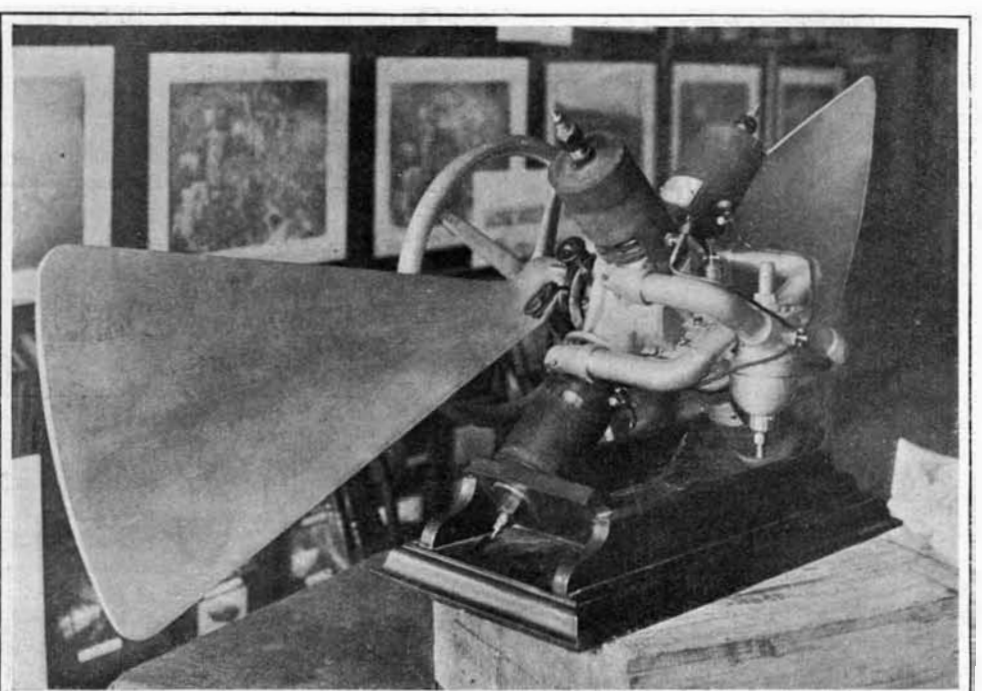

A New 9-Horse-Power, Air-cooled, 4-Cylinder, 2-Cycle Aeronautical Motor.

Weight, 35 pounds. Cylinders, $2\frac{1}{4} \times 2\frac{1}{4}$. Speed, 1,600 R. P. M.

THE POULSEN SELECTIVE SYSTEM OF WIRELESS TELEGRAPHY.

BY A. FREDERICK COLLINS.

A new system of wireless telegraphy that gives considerable promise of solving the extremely difficult problem of selectivity, i. e., the transmission and reception of a number of messages in the same field of force simultaneously and without interference, has been devised and tried out by Valdemar Poulsen, the well-known inventor of the telegraphone.

The arrangement by which Poulsen hopes to accomplish the paramount result that is summed up in the word selectivity consists essentially of a new type of generator for producing continuous electrical oscillations. This generator will be subsequently described in detail, and the advantage of such high frequency currents over those having a periodic character that have hitherto been employed will also be pointed out.

Ever since 1897, when Sir Oliver Lodge applied to wireless telegraph transmitters and receptors the combination of open and closed circuits, and introduced the methods of tuning the circuits at either station individually and syntonizing them collectively, have persistent efforts been made by physicists and others to secure a suitable degree of resonance by providing the proper values of inductance, capacity, and resistance, and when these conditions prevailed, it was concluded the receiving resonator system would respond to a specific radiating oscillator system and to this one only. It is a matter of common knowledge that these tuning effects have been brought to a highly perfected state, thanks to the development of instruments which enable the operator easily to determine the inductance and capacity values, the frequency of the oscillations and the length of the emitted waves to be measured. It is likewise well known that syntonization as it has been practised has not fulfilled the requirements of selectivity in its commercial aspects, although it works out admirably from a theoretical viewpoint.

Nevertheless, these tuned and syntonized systems have served their purpose in extending the signaling distance as well as in reducing the initial energy; but the fact that the oscillations set up were periodic, and that between each succeeding train of oscillations a long interval of time elapses—that is, long compared with the time required for the oscillations to surge through the system before they are damped out into the form of electric waves—has militated against their usefulness as a means to the end of securing selectivity.

Believing that continuous oscillations would remedy this inherent defect Poulsen employs for the purpose the musical arc, whose phenomena were discovered by Duddell in 1900. The apparatus for producing the arc consists of an arc light, fed by a direct current, around which is shunted a condenser in series with an inductance coil as shown in Fig. 2, in which *A* is a choking coil, *B* the inductance coil, *C* the condenser in the shunt circuit, *D* a regulating resistance inserted in the direct-current circuit, and *X* the arc light. Now when certain conditions are satisfied the arc will give out a musical note and at the same time it will transform a portion of the direct current into an alternating current the amplitude of which is constant; and the energy dissipated in the condenser circuit in the form of ohmic losses is supplied by the direct current.

Duddell ascertained, however, that the arc light will emit a musical note only when there is a small change in the potential difference between the electrodes of the arc, and when the corresponding change in the current through the arc is numerically greater than the resistance in the condenser, and numerically less than the resistance of the direct-current circuit in series with the arc. These conditions are fulfilled if the arc is formed between solid carbons. This is an exceedingly simple method of producing not only high-frequency currents but also a very easy way of setting up continuous electric oscillations.

When experimenting some years ago with the musical arc, Poulsen made an observation which he followed up by occasional experiments, and which finally led him to the construction of a generator for producing continuous electric oscillations. In his first apparatus the carbons were placed horizontally and co-axially, as shown in Fig. 4, thus permitting an ordinary alcohol lamp to be held under the arc in such a manner that the latter and adjacent parts of the electrodes were surrounded by the vapor from the alcohol. An ordinary ammeter, *A*, was placed in the direct current circuit, and the hot-wire ammeter, *B*, for measuring high-frequency alternating currents, was placed in the condenser circuit. The direct current was taken from a 220-volt lighting cir-

cuit. Now, when the arc light was placed in the spirit vapor as cited above, a musical note was emitted, the pitch of which diminished. At the same time the hot-wire ammeter indicated a considerable increase in the oscillating current, while the direct current decreased in value. The result was further accentuated by the arc light's glowing less brightly. In succeeding experiments hydrogen and hydrogen com-

by closing the condenser circuit, the colored spot became deeper and the purple core was very much more marked. This hydrogenic arc gave out musical notes, or rather electrical notes, the inventor tells us, of several hundred thousand oscillations per second, but it is possible to obtain some millions of oscillations per second. The excellent resonant effects that can be obtained with these oscillations indicate their continuity, and in a rotating mirror it will be seen that the oscillations are actually continuous.

With currents of high frequency spirits did not give as good results as hydrogen, nitrogen, coal gas, or ether. Again, it was shown to be necessary to draw the arc out to a certain length in order to start the oscillations, but when these have been started the length of the arc can generally be cut down a trifle without causing them to cease. If the length of the arc is increased, then the oscillations will continue, and will cease only when the distance between the electrodes has become so great that the arc is extinguished.

In some of his experiments Poulsen obtained in the condenser circuit—that is, the circuit in which the oscillations are set up—energy equivalent to about 1,560 watts (a little over 2 horse-power) the arc at the same time taking from the direct circuit about 3,170 watts, the efficiency thus being about 50 per cent. In these tests no effort was made to obtain the greatest efficiency or effect, the arc being placed in a water-cooled vessel without an outlet for the gas, this arrangement being necessary to determine the amount of energy consumed and transformed. It also lessened the intensity of the oscillations, since the composition of the gas was altered.

The Poulsen system of producing continuous electric oscillations is capable of taking care of a considerable amount of energy even when very high frequencies are used, as has been repeatedly proven by different experiments in connection with the ordinary lighting circuit of 220 volts. For instance, a resonating coil gave, when inserted in a properly balanced oscillating circuit, a noiseless, warm flame having a length of 12 centimeters; and if the flame is made short, it can be easily observed to be continuously oscillating, by means of a rotating mirror.

Another test was made by placing a large X-ray tube between the coils inductively coupled with an oscillation circuit, and in a short time the cathode and anti-cathode melted. Again, an ordinary 200-volt incandescent lamp glowed when placed in series with two persons, one of whom was connected with the oscillating circuit. Further, if the secondary coil of an ordinary induction coil is surrounded by a helix of thick copper wire, and the terminals are connected in series with a capacity of some microfarads capacity, the shunting in of the nitrogenic arc will produce a very loud singing flame 10 or 12 centimeters in length or more, and finally, an X-ray tube with this arrangement gives a very strong radiation.

From the foregoing it is obvious that such continuous electric oscillations are eminently adapted to the production and propagation of electric waves for wireless telegraphy, and that by properly proportioning the radiating aerial and receiving antenna the desired wave length can be emitted and utilized to produce a continuous resonance effect. The diagram, Fig. 3, shows two oscillating circuits tuned to the same frequency, and by means of which oscillating flames of about double the voltage can be obtained. To provide a wireless telegraph transmitter, it is necessary only to connect the radiating aerial wire with one side of the spark-gap *A* and the earthed terminal to the opposite side of the gap *B*.

The receptor may have any type of detector, although the magnetic detector is exceptionally well adapted for selective signaling in connection with the

Poulsen hydrogenic arc emitter, the latter being shown in the illustration, Fig. 1. It is stated on good authority that a dozen messages have been transmitted and received between as many experimental sets by means of this new selective system without interference; and if this extraordinary result can be duplicated over distances of 50 or 100 miles, as the experiments thus far made between the inventor's two Danish stations indicate, an advance will have been made that, in its importance, will be second only to the introduction of wireless telegraphy itself.

For cleaning pivot holes in small machinery, use a small soft stick, tapering so as to enter easily, but fitting tightly in the hole. This is put in and twirled around, and driven through until the hole no longer dirties it, when the hole may be pronounced clean; although a little petroleum, or better yet, benzine, may be used to "make assurance doubly sure."

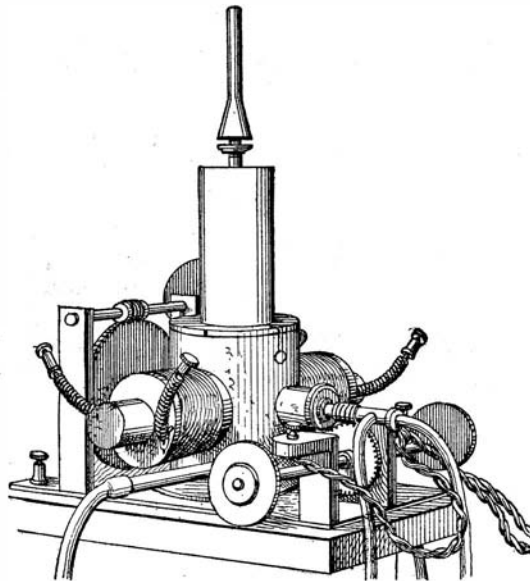

Fig. 1.—Poulsen Hydrogenic Arc Emitter.

pounds were used with approximately similar results, the length of arc required to give a maximum current in the condenser circuit being different than it was in those cases in which the arc was formed in air.

When copper and charcoal were employed as the electrodes, and a nitrogen compound was drawn through the walls of the carbon into the arc, where it was vaporized, the strongest continuous oscillations of



VALDEMAR POULSEN.

constant amplitude were obtained, and these currents were further reinforced by blowing the arc out to a greater length with an electro-magnet, thus increasing its resistance. This is what the inventor terms a hydrogenic arc, and when its image was projected upon a screen with the condenser circuit broken, the arc was observed as a greenish blue spot having a faint core of a purple tint. When the arc was made musical

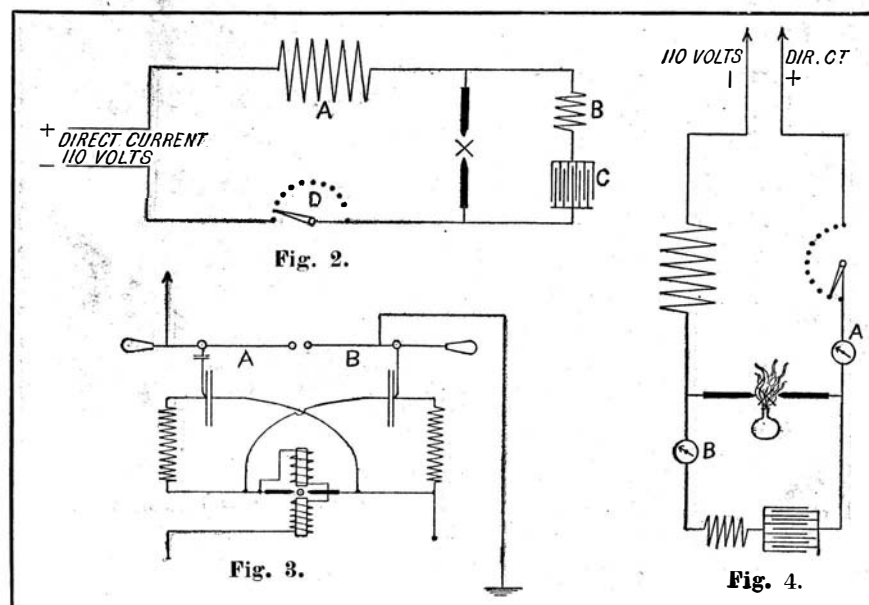

A DISEASE WHICH THREATENS THE AMERICAN CHESTNUT TREE.

BY G. G. COPP.

A new disease of remarkably destructive character has attacked the native American chestnut, and has gained a foothold and attained proportions which threaten the extinction of these trees in and about New York. The same disease is known to exist among the chestnuts of New Jersey, Maryland, and Virginia, but to what extent can only be ascertained by extensive and painstaking work in the respective fields.

The attention of George W. Merkel, forester and engineer at the New York Zoological Park, was first attracted by the immense number of dead and dying chestnuts in the park. He suspected the presence of a destructive fungus. He found that the disease was also creating havoc among the young chestnuts in the park nursery. He sprayed the young trees with Bordeaux mixture, and extended the treatment to the larger trees in the park. At best this treatment could be called only partially successful, and he appealed to Dr. W. A. Murrill, mycologist and first assistant in the New York Botanical Garden. This occurred last year, since which time Dr. Murrill has devoted all the time he could spare from other important duties to the careful study of the disease and to a long series of experiments as to its nature, cause, and cure. His investigations are not yet completed, but the ravages of the disease have now become so apparent that the subject is one of great economic importance.

As Mr. Merkel suspected, the disease is of fungous origin. Pure cultures were made by Dr. Murrill from affected chestnut sprouts in the Botanical Garden last autumn, and were transferred to agar and sterilized bean-stems and chestnut twigs. In each of these situations the fungus grew rapidly and fruited abundantly. Living chestnut twigs were infected and placed, with their ends in water, under bell jars for inspection and study of the fungous growth and action as a preliminary to experiments in the field.

This year, as soon as actual spring growth had begun, numbers of young chestnut trees in the Garden propagating houses were infected with active fungus transferred from bean stalks to the young trees. As Dr. Murrill had been led to expect by results obtained in his preliminary experiments, the fungus attacked the trees vigorously, and soon caused their death by girdling. The accompanying photograph illustrates some of these experiments. The tree shown on the right was inoculated April 3 in three different places. The small twig near the middle of the stem died on May 6, the larger one near the top on May 19. By August 26 the fungus had girdled the trunk at the lowest inoculation, indicated by the tuft of cotton, and had spread downward to the two lowest twigs.

Experiments with cut twigs, covered with glass tubes, were made on the tree in the center. Attempts were made to introduce the fungus into various buds and young twigs near the top of this tree without wounding the bark, but none of them was successful.

The tree on the left was treated on April 5 in the same way, several buds and young twigs from one to five inches in length being covered with the fungus for some time under glass; but all these attempts failed. The dead branch at the top was inoculated through a wound.

The work of observation was next carried into the open, where the ravages of the disease among the older trees throughout Bronx Park were watched, as they also were among young trees transferred from the nursery of the Zoological Park. In these instances infection had occurred naturally, and the fungus was found to be exceedingly active at the beginning of the season of growth, before the opening buds were able to utilize the large quantity of nourishment at hand.

The fungus works beneath the cortex in the layers of inner bark and cambium. Its presence is first indicated by the death of the cortex and the change of its color to a pale brown, resembling that of a dead leaf. Later the fruiting pustules push up through the lenticels and give the bark a rough, warty appearance; and from these numerous yellowish-brown pustules millions of minute summer spores emerge from day to day in elongated reddish-brown masses, to be disseminated by the wind and other agencies, such as insects, birds, squirrels, etc. In late autumn the winter spores are formed, which are disseminated from



Experiments With Young Chestnut Trees in the Propagating Houses.

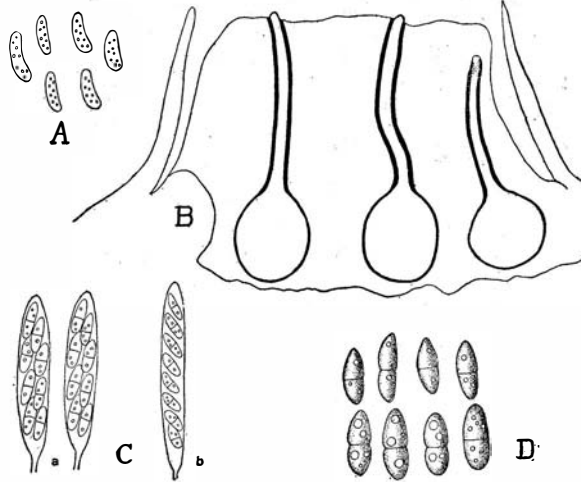

Fig. 3.

A, Summer spores; B, pustule in section showing perithecia; C, Asci with sporida, a, usual form, b, rare; D, sporida.

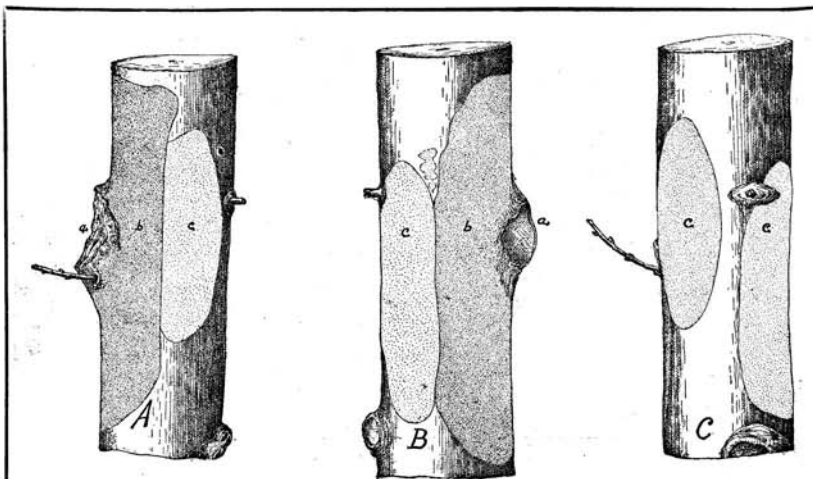

Fig. 1.—Trunk of an Infected Nursery Tree from Three Points of View.

a, Point of infection; b, area killed last year; c, development early last May.

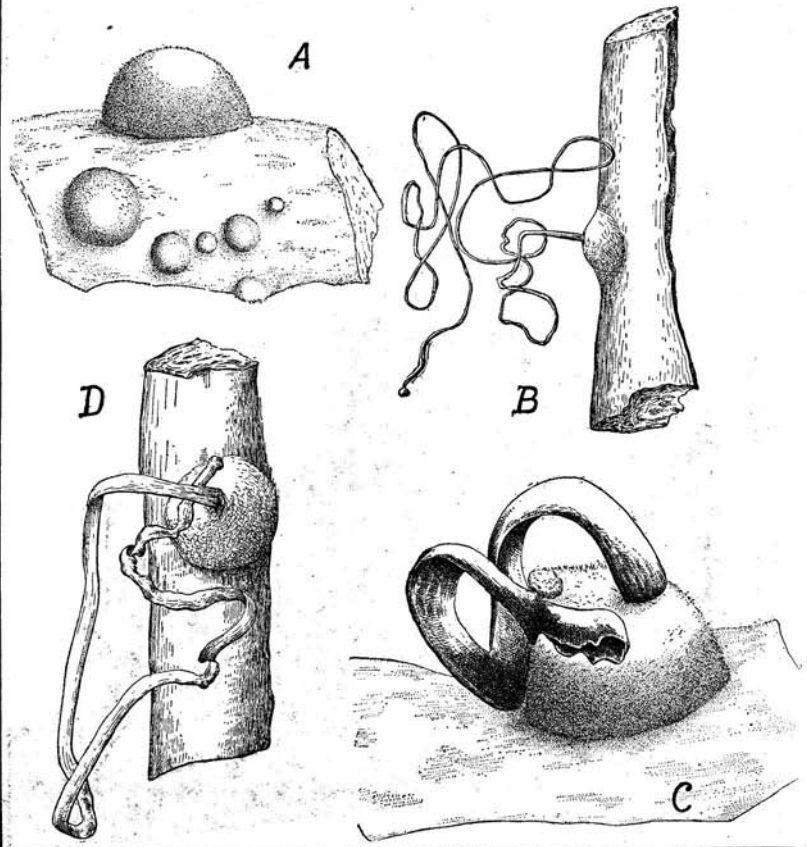

Fig. 2.—Fruiting Pustules and Spore Masses from Chestnut Cultures.

A, Pustules in stages of development; B, C, D, spore discharges in moist atmosphere.

A DISEASE WHICH THREATENS THE AMERICAN CHESTNUT TREE.

the dead branches the following spring. The present supposition is that infection takes place only through wounds or, possibly, through the lenticels. Wounds are, unfortunately, only too frequent, especially in the case of a tender, rapidly-growing young tree like the chestnut, which has the additional misfortune of attracting lumbermen and nut gatherers. If it escapes winter injuries to its trunk, the spring storms are sure to break the smaller branches and abrade the surface of the larger limbs; if it is not disfigured by the green fly and twig-bore during the summer, it is sure to be mutilated by savage hordes of small boys in autumn. Even the ubiquitous squirrel may spread the disease with tooth and claw while cutting off ripe burs and racing up and down the trunks; while every bird and insect that rests upon an infected spot is liable to carry the spores upon its feet or body to other trees.

The treatment of a disease of this nature must, of course, be entirely preventive. When once allowed to enter, it cannot be reached by poisons applied externally, nor can the spores, which issue continuously and abundantly through eruptions of the bark, be rendered innocuous by any coating applied at intervals. On the other hand, no poisonous wash, even though covering every part of the tree, can prevent the germination of the disseminating spores when they fall into a wound, since the wound opens fresh tissues unprotected by the poison.

The spraying of young trees with copper sulphate solution, or strong Bordeaux mixture, in the spring before the buds open might be of advantage in killing the spores that have found lodgment among the branches during the winter, but the real efficacy of this treatment is so doubtful that it could not be recommended for large trees, where the practical difficulties and expense of applying it are much increased. Nursery trees should be pruned of all affected branches as soon as they are discovered, and the wounds carefully dressed with tar or paint or other suitable substance. Vigilance and care should largely control the disease among young trees. With the older trees all dead and infected wood should be cut out and burned, and all wounds covered without delay. Particular attention should be paid to water, soil, and other conditions

of culture affecting the vitality of the tree, since anything that impairs its health renders it less able to resist fungous attack.

In conducting his experiments Dr. Murrill discovered that one or two of the older trees in the Garden are apparently immune. It is possible that careful study of such immune trees may disclose the cause of such immunity. Such discovery might readily prove an active agent in eradicating the disease. On the other hand, it may point to the securing of immune trees by selection, a process, however, which has the great disadvantage of being tediously slow and more or less destructive.

We are indebted to the New York Botanical Gardens for the loan of the accompanying illustrations.

Sir Oliver Lodge in the London Times gives the following résumé of our knowledge of radium: "The evidence for the generation of helium may be briefly summarized thus: Rutherford measured the magnetic deflection of the α -rays, or positively charged particles shot off by radium emanation at a certain stage of its disintegration (for it does disintegrate, it is not permanent), and inferred that the mass of each particle was comparable with twice that of an atom of hydrogen; consequently that the projected particles were material, and that the projected matter, if it were any single known substance, must be either hydrogen or helium, and most likely helium. Ramsay and Soddy then inclosed some of the emanation in a vacuum tube, and examined its spectrum. There was no sign of helium at first—as there would have been had it been merely an ingredient in a mixture—but the helium spectrum gradually made its appearance, in the course of a day or two, at approximately the rate to be expected on the disintegration hypothesis. The loss of much activity by radium when its emanation is removed from it and the gradual return of radio-activity when time is allowed for fresh emanation to be formed, are also facts to be remembered. The rest of the evidence for the slow disintegration of atoms is of a less direct kind, but it is voluminous and varied, and it seems to me that this evidence is extremely weighty."



IMPROVED CONCRETE BUILDING BLOCK.

With a view to expediting building operations, Dr. J. A. Douglass, of Alliance, Ohio, has invented a new form of residence building block, so designed that it can be made in large sizes to take the place of large stones or several bricks without unduly increasing the weight. The blocks are either molded with a stone face, or they may be scored to imitate courses of brick. Very evidently these blocks can be laid more readily than blocks of stone, and more quickly than an equivalent area of bricks. Another feature of the invention, which is hardly less important, is the peculiar arrangement of the air spaces to provide ventilation both vertically and longitudinally. Furthermore, separate inside and outside air spaces are provided, which are completely insulated from each other, to prevent radiation and thus secure greater warmth. The form of the block is clearly illustrated in the accompanying engraving. It will be seen to be of hollow form, open at the top and bottom. The forward and rear air spaces are separated by a central longitudinal wall. There is no communication between these air spaces, but by means of holes in the end walls of each block communication is had between corresponding air spaces of adjacent blocks. A vertical groove is formed in the end of each block, and a pair of diagonal grooves connect each vertical groove with the posterior air space. In the engraving the face of the block is shown to reveal a pair of openings, which

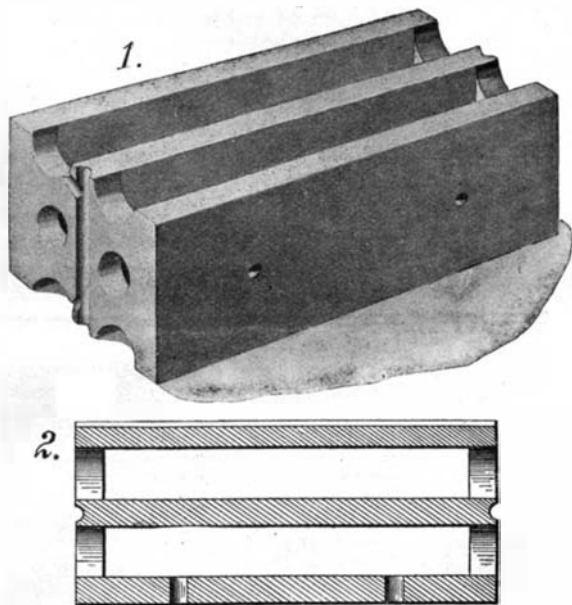

IMPROVED CONCRETE BUILDING BLOCK.

are formed in certain of the blocks. Oil-soaked wooden plugs are driven into these holes, and they provide means for attaching doors, windows, or various ornaments. It is the purpose of the inventor to do away with studding and lathing, thus affording a great saving in the cost, and adding to the fireproof nature of the construction. To this end the rear face of the block may be furrowed to allow for a coat of finishing plaster, or it may be left smooth for the application of calcimine.

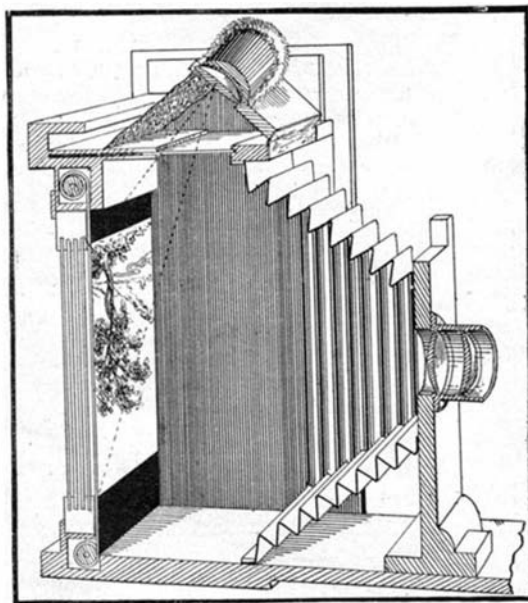

The Shutter Focusing Screen.

GAGE FOR MARKING WINDOW CASEMENTS.
Pictured in the accompanying engraving is a gage of simple construction, which can be used by carpenters for marking window casements so as to indicate the points at which the sash pulleys are to be attached. The gage is shown in use on the stile of a window.

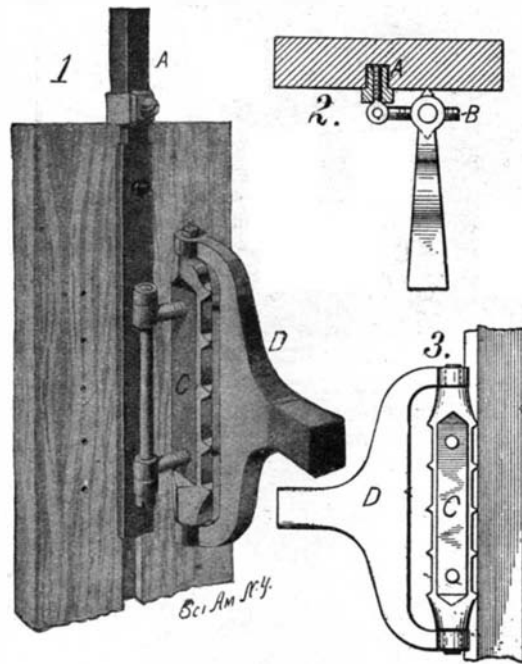

GAGE FOR MARKING WINDOW CASEMENTS.

In the stile is a centrally-disposed groove, which is to receive the parting strip. One of the elements of the gage is a T-bar A, the body of which fits into this groove. At the upper end of the bar the flanges are cut away, and on the reduced stem thus formed an adjustable clamp is secured. Mounted on a vertical bolt secured to the bar are a pair of arms B, which are threaded into a gage block C. This block is formed with spurs or teeth on opposite sides. At the extremities the block is provided with gudgeons, which afford means for the attachment of a yoke formed with a handle D. In use the clamp is adjusted to locate the gage block at a suitable distance from the end of the stile, while the block is adjusted to the proper position on the arms B before the latter are mounted on the bolt. The bar A is seated in the groove, and the handle D is then operated to press the spurs into the stile, marking the points where an auger should be applied for drilling the holes. After the seat for the pulley block has been cut out with a chisel, the gage block may be swung over to score the opposite side of the stile. The outer end of the handle D is of such form as to permit of its being struck with a hammer, if desired, for making an impression in the face of the stile. The inventor of this novel gage is Mr. Walton L. Chase, of Banning, Cal.

A COLLAPSIBLE ASH-PAN.

The removal of ashes from a stove or furnace is a most annoying detail of household work. The ash-pan is usually overfilled and cannot be removed without spilling. Furthermore, a large quantity of ashes is sure to collect in the ash-box around the pan, and this it is difficult to remove without raising clouds of ash dust. As a remedy for these evils, Mr. E. A. Bagby, of Louisville, Ky. (care of Waverly Hotel), has invented a collapsible pan, so arranged that when lifted out from under the grate it opens up into a deep bucket quite large enough to contain the entire charge of ashes. In addition to this, the pan is provided with a

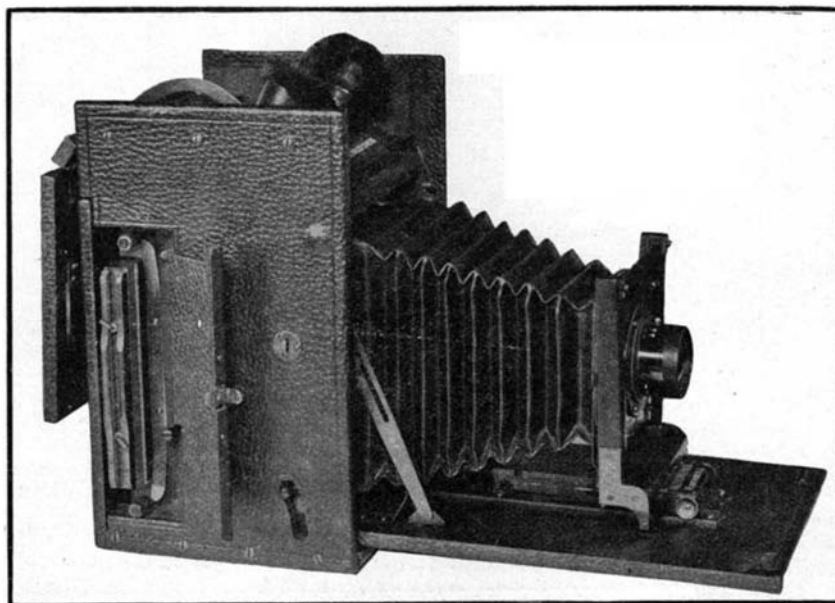

THE HALES FOCUSING CURTAIN SHUTTER CAMERA.

hopper, which catches all the dust falling from the grate and directs it into the pan proper. As may be seen in the engraving, the pan consists of three sections, the bottom one being in the form of an open box or tray, the middle one an open frame embracing the tray, and the upper one an open frame embracing the middle frame. Each of the frames is formed with inwardly-projecting flanges at the top and bottom adapted to engage an outwardly-extending flange on the section it embraces. A bail is pivoted to the upper frame, and when this bail is lifted, the pan sections will assume the positions shown in Fig. 2. In Fig. 1 the sections are shown in their telescoped position with the hopper in place. This hopper is extensible, being formed of sections slidable one upon another. This permits of adjusting the hopper to various sizes of grates. With the hopper in position, the capacity of the pan is doubled. The hopper may be folded small enough to be nested into the collapsed pan, thus making a very small and compact package for storage or shipment.

AN IMPROVED HAND CAMERA.

In many hand cameras using a focal plane curtain shutter it is customary to employ a pivoted mirror for reflecting the lens picture image upward to the underside of a horizontal focusing ground glass. Over the ground glass is a collapsible hood through which the operator observes the image and obtains the correct focus in the usual way; then on the movement of a release lever, the mirror flies upward out of the line of the picture image from the lens and at once releases the curtain shutter when an instantaneous exposure is made. The advantage of this form of construction is that the operator sees the size and position of the image to be photographed up to the time of exposure.

The modern anastigmat lenses now made are of

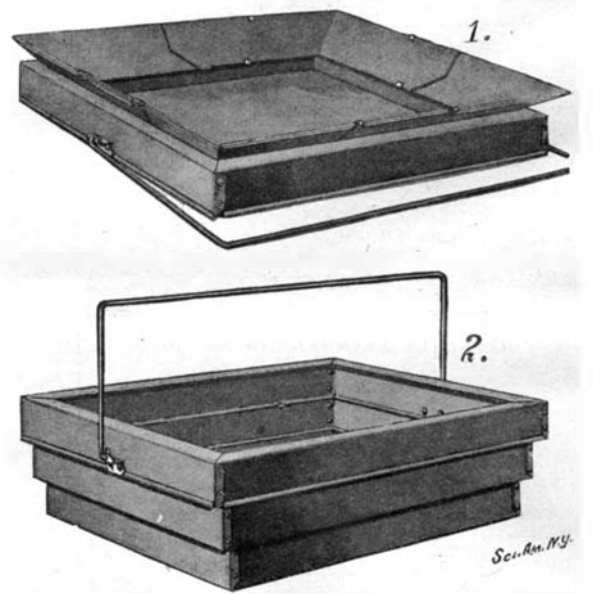

A COLLAPSIBLE ASH-PAN AND HOPPER.

such fine optical quality that ordinary cameras fail to show the extreme or microscopic sharpness of the image and do not bring out the fine results that such lenses are capable of producing.

In such cameras the so-called "grain" of the ground glass interferes with the fineness of the image, and the refraction of the glass also affects its sharpness. In cameras where a mirror reflects the image the picture is subject to distortion by any slight inequality of the mirror, and because of the distance the rays

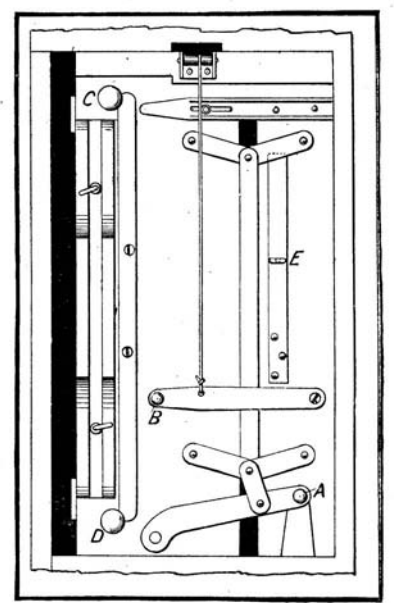

The Shutter Release Mechanism.

have to travel this defect is sometimes greatly intensified.

The camera shown in the accompanying illustrations, the invention of Henry W. Hales and manufactured under American and foreign patents by the Hales Camera Company, of Ridgewood, N. J., is designed to be more simple in operation than the mirror form of camera, and to be especially useful in enabling the operator to obtain and observe an accurately sharp, brilliant image projected directly upon a white focusing ground and in an apparent proper position on account of the way it is looked at.

The general appearance of the camera opened for operation will be seen in the perspective view and its novel features in the diagram views. The side forming the front and base of the camera is dropped down in the usual way and the lens portion drawn out on to a plate provided with a rack and pinion focusing adjustment. The top of the box folds backward over the rear of the camera and as it does so allows the eye observing apertures to be elevated into position by means of a light spring below. A curved arm shown at one side of the top is actuated downward when the top is closed, thereby automatically folding the eye-piece into place, when the camera is not in use. A convenient handle is on the outside of this top piece for carrying the camera. In appearance it is like an ordinary square shaped box.

The back portion of the camera as shown in the right diagram is made in two parts, one of which is rigid and the other movable. The latter part carries the focal plane curtain shutter and the plate holder. The shutter is of the ordinary simple form with a single horizontal slot of uniform width, but a part of its outer surface opposite the lens is whitened with a smooth, fine surface and forms, when the shutter is wound up, a perfect focusing screen, the full size of the plate, shown plainly in the left diagram.

Directly under the eye observing portion is a horizontal light cut-off slide which is kept closed by a spring and is only opened when the image is observed, by pressing down the handle B. This is connected by a thread passing over a roller to the lever operating the slide. In focusing the forehead rests against the eye apertures, in which spectacle lenses are located to partly magnify the image, and the operator looks backward at the image. The view is indicated by the dotted lines in the diagram. Inasmuch as the head is downwardly inclined the inverted image on the

screen looks in the right position. The foreground appears at the top of the screen and the sky below. A is the shutter release lever. Its function is, as soon as the focus is obtained and the image located in position on the screen, to first advance the movable back and the plate holder forward until the plane of the plate occupies the same focal plane as the former focusing surface of the curtain shutter did; then a trip at the top of the fixed back throws out the spring holding the shutter at C, releases the latter, causing the exposure to be made in the usual way. It will be seen that the shutter release A operates, in its downward movement, a vertical toggle bar which carries the movable back forward and closes it against the stationary back. After the exposure is made the curtain is wound up for another exposure by the knob C, and at D is another knob or shaft for increasing the tension of the actuating shutter spring. On the opposite end of this shaft is an indicator (not shown) for indicating the speed of the shutter. By the movement of the shutter lever A upward the movable part of the camera is pushed backward and the curtain shutter is placed in position for focusing.

E is a lock for the shutter lever. In the general view it is a small button, which on being pulled outward by the fingers brings a spring stop under the toggle connection and holds it from operating. On releasing E it springs inward out of the way of the toggle bar.

By placing the lever A in a half-way position the curtain shutter may be entirely rolled up, leaving the camera open in the back for ordinary time exposures with the use of the usual ground glass if so desired. The ordinary plate holder is used. In a trial of the camera we found it exceedingly easy to obtain an accurate focus on account of the brilliancy of the image on the white shutter. The camera presents a neat and attractive appearance. All portions of the metal work are blackened to prevent reflections, while the mechanism is simple, easily operated, and so far as can be made is what is called "foolproof." As the camera contains no ground glass or mirrors its weight is somewhat lighter than others.

Air at 82 deg. Fah., with moisture at 90 per cent of saturation, has its absorption power more than doubled when it is heated to 110 deg., since the saturation is reduced to about 42 per cent by the elevation of temperature.

The Irish International Exhibition.

The forthcoming International Exhibition at Dublin, Ireland, which will be open from May to October, 1907, will be the biggest undertaking of its kind ever organized by Irishmen, completely dwarfing any of the expositions previously held. So favorably has the enterprise been received that more than 1,000 guarantors have subscribed to the guarantee fund, which now exceeds \$900,000, and is constantly growing. Work on the exhibit buildings has gone on so rapidly that they will be finished some months before the day set for opening, May 1, 1907. Machinery Hall is already completed. It is believed that 3,000,000 people will attend the exposition during the time it is open.

Foreign countries, recognizing the opportunities which the exposition will afford, are making active preparations to send exhibits. France is preparing a French section which will equal that at the exposition at Liege; Russia has appointed an agent to make necessary arrangements for a large exhibit; Italy, Canada, and Australia and other countries will be well represented.

Exhibits will be classified in nineteen sections as follows: Irish industries; history and education; fine arts, including photography, engraving, etc.; arts and crafts; liberal arts; manufactures, textiles; engineering and shipbuilding; civil engineering and transportation; electricity; motors; gas lighting, heating and cooking; agricultural implements and chemical industries; horticulture and arboriculture; sport and fishing; mining and metallurgy; hygiene; women's section; agriculture and food products; cottage industries.

Opposite the main entrance will be the principal building, consisting of a central octagonal court, 215 feet in diameter, surrounded by a corridor capable of accommodating 7,000 people. The corridor will open into four radial wings each 164 feet long and 80 feet wide with a combined area of 52,000 square feet. The total area of the central building will exceed 100,000 feet. Around this will be grouped the pavilions for the British, foreign, and colonial exhibits. The machinery building will be 900 by 100 feet, giving a floor area of 90,000 square feet. The fine arts gallery, one of the features of the exposition, will have 30,000 square feet, and several other buildings ranging from 10,000 to 50,000 square feet are in course of erection. Altogether, the exposition will cover fifty-two acres of ground.

RECENTLY PATENTED INVENTIONS.

Pertaining to Apparel.

METALLIC BUTTONING DEVICE.—E. I. RAINS, New York, N. Y. This buttoning device yieldingly connects two garments or two parts of a garment with each other—for instance, connecting boys' pants with their shirt-waists and blouses—the device being arranged to readily compensate for strains in almost every direction and without danger of breaking or tearing the connected parts, especially when the wearer is bending in a forward position.

Electrical Devices.

ELECTRIC ALARM.—E. S. MOORER, Anderson, S. C. In this case the invention relates to electric alarms and admits of general use, but is of peculiar value in instances where it is desired for the alarm to be automatic in its action, so as to indicate the change in condition of an electric circuit due to the movements of a burglar, the presence of a fire, or the like.

Of Interest to Farmers.

COLTER AND STUBBLE-TURNER.—C. S. UPTON, Walla Walla, Wash. In this agricultural implement a disk-colter is journaled in a fork supported at the cranked lower end of a vertically adjustable colter standard secured to the plow beam; and in connection with the disk-colter a novel stubble turner is employed which is supported on the forward end of the colter fork and is adjusted to assume the proper position in the front of the disk.

Of General Interest.

CONVEYER.—I. PEABODY, St. Marys, New Brunswick, Canada. The objects of this invention are to provide certain improvements over the conveyer disclosed and claimed in the United States patent formerly granted to Mr. Peabody, whereby the conveyer-belt may be more economically manufactured and rendered more efficient in use. In the use of the improved strap-and-link connection there is no liability of the chain becoming detached or lost.

FURNACE.—W. F. CARR and J. P. McLIMANS, Coatesville, Pa. The object of this invention is to provide a means for removing slag and foreign substances while the furnace is under operation, thus permitting the furnace to finish its run, obviating the cooling off to remove deposits of slag and the like, which is the usual practice, and which is detrimental to the life and run of the furnace, also injurious to the brickwork, as the brickwork is often

drawn out when removing slag in the ordinary way, resulting in the stopping of the run.

FIREARM.—W. W. SMITH, Trenton, N. J. The purpose of the inventor is to provide a single or a double barrel gun with extension-barrels, said barrels being provided with removable interchangeable muzzle-sections, which may be made in various lengths and bored to suit all field purposes, and to provide readily-operated means for attaching the sections of the barrels and rendering them gas-tight where they connect.

MAGAZINE-FIREARM.—W. SONNENBERG, Winona, Minn. One purpose of this invention is to provide a form of breech-bolt and means for accurately guiding the same in the frame, together with means for automatically locking the breech-bolt when in firing position, which locking means are rendered inactive only when the hammer is in an uncocked position or through the medium of a push-button operated at the exterior of the frame.

GUN-SIGHT.—R. W. HENNESSY, Burntranch, Cal. The invention refers to a front sight for rifles adapted to be used with any character of peep-sight. The purpose is to provide a construction of front sight which will afford the person aiming a clear, concentrated, and practically-unobstructed view of the object at which the gun is aimed, and which will enable the marksman to see clearly both above and below and along the bead.

TABLE.—S. HALL, Chicago, Ill. The table is especially adapted for use in smoking-cars, and adapted to be removably attached to the sides of a car and to extend horizontally between the chairs in such manner as not to interfere with the comfortable use of the latter. The invention provides individual tables supported at one side of the chairs and held in front of them, which tables are adapted to receive glasses, ash-trays, or other articles used in such a car.

BOTTLE.—W. L. VANDERGoot and N. P. J. FOLEN, Portland, Ore. In the present patent the invention relates to bottles and more especially to those of the non-refillable type. The improvement has for its principal objects the provision of simple means for preventing the surreptitious filling of the bottle while not materially interfering with the freedom of delivery.

SAFETY DEVICE FOR WATCHES.—F. D. ELY, Salt Lake City, Utah. One of the principal objects of this invention is to provide a device that when mounted upon the rim of a watchcase will prevent the easy abstraction of the watch from a pocket in which it may be placed and which will also prevent a watch having a device thereon from falling out from a pocket and by striking on its edge or side "bank" the works of the watch, so that re-

pairs are required for restoring the same to normal operative use.

SILVERSMITH'S STOCK.—M. T. GOLD-SMITH, New York, N. Y. The inventor's object is to provide a stock designed for use in the manufacture of purses and like articles, and arranged to present smooth inner and outer surfaces to prevent handkerchiefs and other fabrics from being caught on undesirable projections, as is so frequently the case with fish-scale purses and like articles as now constructed.

FIRE-BUCKET.—J. W. BOWERBANK, Jersey City, N. J. The bucket or pail permits a fireman or other person to send with one charge successive powerful streams of the fire-extinguishing liquid accurately to the seat of the fire with a view to extinguish the same, to prevent the use of the bucket for other than extinguishing purposes, to allow the discharge of all the extinguishing liquid contained in the bucket without becoming air-bound, and to allow of directing the liquid to places not readily accessible to streams dashed out of ordinary buckets.

Heating and Lighting.

THIMBLE.—J. J. LE SAUVAGE, New York, N. Y. This invention refers to the thimbles employed in chimney-openings to adapt them to receive the smoke-pipes of heating apparatus. Its principal objects are to provide means for securing a capability for a movement of the smoke-pipe laterally of the thimble while still furnishing a proper closure between the pipe and thimble under normal conditions.

TIME GAS-LIGHTING MECHANISM.—N. F. ENGLUND, Ashland, Wis. The clock is set at the hour desired to extinguish the lamp. As the alarm rings a drum will turn and wind the cord, thus exerting a swinging force on an arm and turning the stem to shut off gas-supply. The arrangement may be reversed in connection with a gas-lamp using a pilot-flame, so as to automatically light the lamp at any stated hour or to control other lamps than those using a gaseous fuel.

Machines and Mechanical Devices.

SWAGE FOR INSERTED SAW-TEETH.—W. L. NEWELL, Buckeye, Wash. The invention is especially useful for swaging saw-teeth when removed from the body of the saw. The object is to provide means for holding the teeth against the anvil and swage during the swaging operation. It is an improvement on the invention described in application formerly made to Mr. U. Staley and Mr. Newell.

POWER-TRANSMITTING MECHANISM.—J. L. NELSON, Colona, Col. In this case the invention has reference to mechanisms for transmitting power, its principal object being to provide means for overcoming dead-centers. The power transmitted to and developed by the weight is taken off the pivot-pins, thus securing the maximum leverage of the weight and making two strokes for each stroke of the connecting-rod.

GOLD WASHER AND AMALGAMATOR.—J. J. SOUTHWICK, Great Falls, Mont. The improvement pertains to means for saving fine gold that is in flakes, and which in washing pay dirt is ordinarily floated and carried away with the water used to separate values from the dirt. It consists in the peculiar construction and in the novel method for amalgamating gold that is washed from waste matter as the rich dirt is passed through the machine.

ROAD LEVELER AND SCRAPER.—C. W. KAUFFMAN, Dale Township, McLean County, Ill. Mr. Kauffman's invention is an improved machine for leveling and scraping roads, streets, or farm land and the like. It contemplates the production of a device of this character which shall be of simple construction, and an effective means to level a road or other land, combined with a detachable drag-plate to adapt the machine to be used in the capacity of a scraper, when desired. In the operation of the machine the leveler-beam is used solely with the leveler-blade or in connection with the drag-plate, according to the nature of the work which is to be performed.

CLAM-SHELL BUCKET.—V. E. LANE, 325 Vine Street, Berwick, Pa. The main objects of the improvement are to provide a bucket which shall be self-filling and which will be capable of being emptied by a very simple operation. A further object is to provide automatic closing mechanism for a bucket of this character, thus doing away with the necessity of the auxiliary drum or hoist commonly used.

SAWMILL-DOG.—G. S. SERGEANT, Greensboro, N. C. In carrying out the present invention Mr. Sergeant provides a lower dog means for forcing the dog upwardly into the under side of the log and for forcibly releasing it from engagement with the log, and arrange the said means and devices for convenient operation.

NAIL-COATING MACHINE.—C. WAGGONER, Akron, Ohio. Briefly stated, the invention has reference to certain improvements in nail-coating machines whereby the operation of machines of this character may be rendered more economical and more easily controlled, such results being due to the oscillatory rather than to the rotary movement of the device.

Pertaining to Recreation.

TOY.—W. V. GILBERT, No. 30 Lonsdale road, Wanstead, N. E., London, England. This device is actuated by compression in opposing directions. It forms the chief feature in the toy for imparting the required movement to the eyes, ears, and other parts of the figure representing the head of a man or animal, whereby the moving features or parts are actuated in an unusual or extravagant manner, so that the figure may present preferably a grotesque appearance.

FIGURE TOY.—W. V. GILBERT, No. 30 Lonsdale road, Wanstead, N. E., London, England. In carrying out the invention Mr. Gilbert makes use of a spring device adapted to be actuated by compression on opposite directions. It is so constructed and arranged that what have been termed the "sides" or "wings" thereof are extended or lengthened so as to constitute the beak, jaws, or mandibles of the bird, reptile, insect, or other creature represented in whole or in part by the toy figure, such extended portion being preferably ribbed or corrugated.

BOWLING-ALLEY.—F. H. BEDELL, Brooklyn, N. Y. The floor of the alley has a triangular portion removed and replaced by a triangular metallic plate. The latter is of sufficient extent to contain all the bowling pins when they are set up in proper position thereon and is provided with a plurality of circular openings corresponding in number and position to those of the pins. By providing a metallic plate for receiving the bowling pins the life of the floor is prolonged, since the greater part of the wear is at the point where the balls strike the pins. Bowlers obtain many advantages through the means provided for placing the pins in correct position.

AMUSEMENT DEVICE.—D. J. B. CAFFODIO, New York, N. Y. The invention relates to amusement devices, and especially to the general type of such devices which are popularly known as "merry-go-rounds." The object is to produce a device which will give pleasure-seekers a new and enjoyable sensation. Bicycling, automobiling, and skating are prominent features of amusement provided by the operation of the device.

TOY OR TOY WAGON.—E. C. SEERREITER, Buffalo, N. Y. In this instance the object is to provide a toy or toy wagon built of easily-separable pieces to allow a child to readily take the whole article apart and to reunite the pieces and rebuild the article, thus furnishing means to keep the child occupied and at the same time serving as a medium for educational or manual-training purposes.

GAME-TABLE.—A. VAN B. BUSH, New York, N. Y. The invention comprises a table having a body with pockets formed therein adapted to receive a ball, a back-stop presenting a curved inner face, and an elevated tray adjacent to the back-stop having pockets adapted to receive the ball and an opening through which the ball may fall.

AMUSEMENT DEVICE.—A. BOECK and J. MÜLLER, New York, N. Y. The object of the invention which relates to amusement devices is to provide a tower having attachments enabling persons to climb to the top thereof and having means of rapid descent from the tower. A further object is to provide the tower with means of amusement to entertain visitors.

Pertaining to Vehicles.

ELASTIC TIRE FOR WHEELS.—L. BOIR-AULT, 8 Rue Emile Gilbert, Paris, France. This invention relates to an elastic tire compressing a series of corrugated flat springs arranged around the rim or felly and a cover or tread arranged around the said springs. It consists neither in arranging on a felly springs surrounded by a flexible tread nor in providing the felly with any kind of ribs, but in combining the springs with the ribs and with the tread to allow of the springs yielding totally in radial and partially in transversal direction, while they are in part rigidly supported in the latter and completely so in the circumferential direction.

WHIP-SOCKET.—R. H. HEBERLING, Wilmerding, Pa. The invention is an improvement in that class of whip-sockets which are provided with means for locking a whip to prevent its surreptitious removal. The grippers are held so that the whip is gripped with minimum force, yet when introduced its frictional contact with the rims of the grippers causes the latter to rotate on their pivots, so that as the whip descends the eccentricity of the portion in contact with it increases, and thus the gripping action becomes stronger and stronger.

Designs.

DESIGN FOR A KNIT FABRIC.—C. H. FRENCH, Canton, Mass. This ornamental design for a knit fabric is laid out by arranging rows of squares of dark material each united at two opposite ends. The position of the squares or diamonds is such that the separating body of light colored material presents an accurate zig-zag path the whole length of the pattern.

NOTE.—Copies of any of these patents will be furnished by Munn & Co. for ten cents each. Please state the name of the patentee, title of the invention, and date of this paper.

Business and Personal Wants.

READ THIS COLUMN CAREFULLY.—You will find inquiries for certain classes of articles numbered in consecutive order. If you manufacture these goods write us at once and we will send you the name and address of the party desiring the information. **In every case it is necessary to give the number of the inquiry.**

MUNN & CO.

Marine Iron Works. Chicago. Catalogue free.

Inquiry No. 8518.—Wanted, a machine for making down out of ordinary chicken feathers.

Pattern Letters. Knight & Son, Seneca Falls, N. Y.

Inquiry No. 8519.—Wanted, name and address of the manufacturers of a sheet metal locked box with envelopes inside, for holding valuable papers.

"U. S." Metal Polish. Indianapolis. Samples free.

Inquiry No. 8520.—Wanted, the address of the Royal Motor Works, of New York.

Handle & Spoke Mch. Ober Mfg. Co., 10 Bell St., Chagrin Falls, O.

Inquiry No. 8521.—Wanted, a machine (gasoline preferred) for sawing down trees, and cutting in cord lengths.

Sawmill machinery and outfits manufactured by the Lane Mfg. Co., Box 13, Montpelier, Vt.

Inquiry No. 8522.—Wanted, particulars of appliances and shifting type for marking aluminum strips and washers with names, addresses and consecutive numbering.

Make Alcohol from Farm Products.—New book, \$1.00. Spon & Chamberlain, 123 S. A. Liberty Street, N. Y.

Inquiry No. 8523.—Wanted, machinery for making small pin tickets.

WANTED.—Copies of our "Manufacturers' Index" issued some eight years ago. State price. Munn & Co., 361 Broadway, New York.

Inquiry No. 8524.—Wanted, the address of the Higginan Mfg. Co.

The celebrated "Hornsby-Akroyd" safety oil engine. Koerting gas engine and producer. Ice machines. Built by De La Vergne Mch. Co., Ft. E. 138th St., N. Y. C.

Inquiry No. 8525.—Wanted, machinery for manufacturing butterine, lard and oleomargarine.

Manufacturers of patent articles, dies, metal stamping, screw machine work, hardware specialties, machine work and special size washers. Quadriga Manufacturing Company, 18 South Canal St., Chicago.

Inquiry No. 8526.—For a firm wishing to undertake the manufacture of scissors.

Inquiry No. 8527.—Wanted, addresses of makers of matrices for type-casting machines or of steel dies for forming the matrix letters.

Inquiry No. 8528.—Wanted, name and address of the manufacturers of the Minerva Piano Player.

Inquiry No. 8529.—Wanted, makers of gas mantle knitting machines.

Inquiry No. 8530.—Wanted, parties to manufacture insect traps.

Inquiry No. 8531.—Wanted, parties to manufacture small compressed air motor.

Inquiry No. 8532.—Wanted, a machine for extracting gold from dry sand or gravel.

Inquiry No. 8533.—Wanted, spectacles having artificial eyes on back of the glasses.

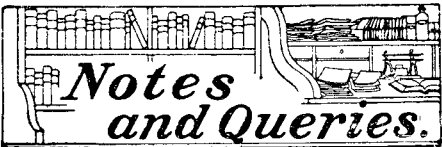

HINTS TO CORRESPONDENTS.

Names and Address must accompany all letters or no attention will be paid thereto. This is for our information and not for publication.

References to former articles or answers should give date of paper and page or number of question. **Inquiries not answered** in reasonable time should be repeated; correspondents will bear in mind that some answers require not a little research, and, though we endeavor to reply to all either by letter or in this department, each must take his turn.

Buyers wishing to purchase any article not advertised in our columns will be furnished with addresses of houses manufacturing or carrying the same.

Special Written Information on matters of personal rather than general interest cannot be expected without remuneration.

Scientific American Supplements referred to may be had at the office. Price 10 cents each.

Books referred to promptly supplied on receipt of price.

Minerals sent for examination should be distinctly marked or labeled.

(10250) W. B. M. asks: 1. What is the nature of the conductivity of selenium in carrying a current of electricity, as affected or influenced by light? A. We do not know the nature of electrical conductivity in any substance. 2. Does the exposure or influence of light act on selenium gradually or instantaneously? A. All action of light is practically instantaneous. 3. Is selenium a non-conductor in the dark, i. e., absence of light? A. Selenium is to be classed among the non-conductors. 4. Do any particular colors or rays of light affect it more quickly than others? A. We have no data at hand on this point. The best method of learning all about selenium is to go to some first-class library and go through the reports of learned societies. You will then have it all. We can send you articles in our SUPPLEMENT Nos. 462, 484, 492, and 1348 for ten cents each.

(10251) F. J. B. asks: I would thank you if you would treat upon the hardening of copper and aluminium, and if the discoverer of same would be amply rewarded. A. There is a very old belief that the ancients knew how to temper copper as we temper steel. No tempered copper is in existence, and there are scholars who do not believe it ever was done. We doubt very much whether there would be a wide use for hardened copper or aluminium, unless their tensile strength could be greatly increased by the process. We have assisted in making experiments to this end, but without success. If aluminium could be made as strong as iron, there would be a great market for the wire for electrical purposes.

(10252) F. S. writes: 1. A friend of mine got into an argument with me concerning electricity. I said it was made or generated by the use of a magnetic field or produced by the chemical changes which take place in a liquid cell. He said it was gathered or collected from the air in all cases, either by mechanical means or chemical means. He said he would not believe that I was right, and so I said I would see who was right; and please describe how it is made, so we may settle the question. A. Electricity is produced in batteries by chemical action; in most primary cells by dissolving zinc in sulphuric acid. It is produced in dynamos by revolving coils of wire in a magnetic field; in thermo-couples by heating the junction of two metals. The first two methods named are the ones by which most of the commercial current is generated. There is electricity always present in the atmosphere, which can be detected by the proper instruments, but which is seen by any one in thunderstorms. This electricity is, however, not used for any practical purpose. 2. I have a magneto-generator, such as are used in telephones, giving an alternating current because there are only two sets of coils on the armature. Why is it not possible to use a ring armature and have one continuous coil wound on it, having a one-piece commutator? Would it generate a continuous current by keeping the current up to a maximum instead of at zero and then a maximum, and about what would be the voltage? Could I increase the strength of the permanent magnetic field by wrapping it with magnet wire in the right direction, and if possible could you tell me the amperage of a telephone magneto-generator wound the way I have described? A. The current of the magneto is alternating because the armature is not provided with a commutator. A direct current can be produced by a single coil on an armature if there is a commutator. We do not know how much you can get out of your magneto; enough to ring a bell, surely, but not enough to do much more than this.

(10253) J. J. S. asks: 1. In making Leyden jars, I have had great difficulty in coating the inside with tinfoil. Will you kindly advise me on the following points: Would it do equally well to half fill the jar with tinsel, of course coating the outside with tinfoil? A. No. The tinsel will not be continuous, nor will it be in contact with the sides of the jar. 2. Would it do to shellac the inside up to the proper height and shake in bronze powder? A. Not so well as tinfoil. 3. In using tinfoil, should the bottom, inside and outside be covered? A. Yes. There is not much difficulty in placing the tinfoil properly in the jar. Cut the foil into strips of two inches or thereabout in width. Apply the paste to the inside of the jar with a long-handled brush. Put the foil in with forceps or in any other convenient manner, and bring it to its place and rub it down with a dry brush with long bristles. 4. I have made a Wimshurst machine with 18-inch plates, but can only get a spark of $\frac{3}{8}$ inch. Is this all a machine of that size is capable of, or have I made some mistake in construction? A. The spark is not long when a Leyden jar is not used. And indeed when the jar is used, its effect is to render the discharge intense rather than to lengthen the spark.

INDEX OF INVENTIONS

For which Letters Patent of the

United States were Issued

for the Week Ending

December 4, 1906,

AND EACH BEARING THAT DATE

(See note at end of list about copies of these patents.)

Table listing inventions and their corresponding patent numbers. Includes entries like 'Acid concentrating apparatus, sulfuric, L. Stange', 'Adjustment, combination, T. E. Lutz', 'Air brake, H. M. Marsh', etc.

Table listing inventions and their corresponding patent numbers. Includes entries like 'Bell ringing circuit, G. P. McDonnell', 'Binder, loose leaf, C. C. Maltby', 'Blind slot, K. Reinking, et al.', etc.

Soles and the like, machine for rounding or trimming and channeling boot and shoe outer, M. T. Denne..... 837,287

Sower, seed, C. Bristow..... 837,542

Speed changing device, F. W. Wandless..... 837,651

Spinning ring and holder, L. T. Houghton..... 837,406

Spoke socket, D. W. Orcutt..... 837,581

Spoon, W. E. Raney..... 837,506

Spring motor, H. S. Esch..... 837,815

Spring regulator, M. Gehre..... 837,557

Spring seat and bed, convertible, E. W. Summers..... 837,751

Stacking apparatus, H. H. Groo..... 837,300

Stalk cutter, T. L. Durham..... 837,810

Stalls, releasing device for, A. G. Dunham..... 837,289

Stamp, stationary, and cash box, combined, H. A. Whitehead..... 837,442

Stamping machine, J. A. McAnulty..... 837,633

Steam boiler, E. F. Edgar..... 837,392

Steam condensing apparatus, O. Kolb..... 837,308

Steam engine, C. L. Snyder..... 837,429

Steam generator, L. G. Bugbee..... 837,544

Steam trap, W. H. Odell..... 837,711

Steel, manufacture of, Weaver & Thackray..... 837,598

Steering device, T. P. & W. W. Wilson..... 837,528

Steering device for ships, J. Dieckmann..... 837,288

Stoker, automatic, J. P. Lockett..... 837,858

Stopper for laboratory flasks, bottles, and other containers, W. S. Johnstone..... 837,408

Store front construction, F. J. Plym..... 837,640

Storing apparatus, material, W. J. Selleck..... 837,586

Stove, J. M. Ericson..... 837,456

Stove, A. V. Erving..... 837,814

Stove, gas, H. S. Humphrey..... 837,471

Stoves and the like, return flue for, F. W. Menkey..... 837,320

Stovepipe securing means, A. W. Laughlin..... 837,478

Stump extractor, E. T. Shelton..... 837,587

Stump puller mechanism, O. A. Kleitz..... 837,305

Superheater, H. O. Keferstein..... 837,844

Surveying bore holes, means for, H. F. Marriott..... 837,415

Suspender spring, C. W. Wicks..... 837,761

Suspenders, C. Ludolph..... 837,578

Suspending bracket, V. Sjostrom..... 837,646

Switch cover, indicating electric, C. G. Perkins..... 837,498

Switch point locking mechanism, Maher & Harbison..... 837,860

Switch throwing device, F. Krausz..... 837,689

Switch throwing mechanism, L. E. Steele..... 837,593

Tab blanks, machine for infolding, Pine & Dormandy..... 837,500

Tag, T. F. Wilkinson..... 837,762

Talking machine, D. Apstein..... 837,274

Talking machine damper, J. C. Schleicher..... 837,585

Telegraph system, wireless, H. H. C. Dunwoody..... 837,616

Telegraph transmitter, C. W. Leiser..... 837,413

Telegraphy, wireless, L. De Forest..... 837,901

Telephone, S. J. Port..... 837,503

Telephone apparatus, G. Babcock..... 837,534

Telephone, hand, Houghton & Potter, Jr..... 837,470

Telephone mouthpiece safety guard, E. Stempel..... 837,594

Telephone receiver, S. C. Houghton..... 837,469

Telephone system, J. A. Aven..... 837,894

Telephone transmitter, F. W. Fahrenfeld..... 837,457

Telephone transmitters, attachment for mouthpieces of, J. G. Kitchell..... 837,304

Telephone wire ground connection, C. Lanz..... 837,693

Tent, M. W. Dalton..... 837,802

Test clamp, J. H. Williams..... 837,599

Thermometers, instrument for readjusting clinical, J. Peterson..... 837,339

Thermostat, Cortland & Heinrich..... 837,898

Thill coupling, G. W. Kohler..... 837,626

Thimble and needle threader, combined, E. M. Totten..... 837,357

Thimble, sewing, H. Bourne..... 837,896

Thread cutting device, J. Roemer..... 837,422

Tie plate, B. B. Moss..... 837,706

Tie plate and rail brace combination, W. D. Clark..... 837,282

Tightening device, labyrinthian, O. Kolb..... 837,850

Tire, pneumatic, H. C. Fairchild..... 837,458

Tire, spring, J. W. Barnes, Jr..... 837,376

Tires, safety valve for pneumatic, W. S. Arnold..... 837,772

Tobacco plants, implement for deadening, L. G. Ibrig..... 837,473

Tongue switch, W. C. Wood..... 837,766

Model H-1907

It's the motorist of experience who most quickly recognizes that scientific design, and workmanship so precise that all vital parts are made to gauges which do not allow a variation to exceed a thousandth part of an inch, produce the highest degree of perfection and efficiency in an automobile motor. This, combined with utmost care in the production of every individual piece of the entire car, makes this new

CADILLAC

remarkable for its smooth and perfectly-balanced action, its ease of control, its comfort of riding, 30 h. p.; 50 miles an hour; \$2,500. A demonstration will surprise you.

Dealer's name and booklet N sent on request.

Other Cadillacs are: Runabout, \$800; Light Touring Car, \$950, f. o. b. Detroit; lamps not included.

CADILLAC MOTOR CAR CO., DETROIT, MICH.
Member A. L. A. M.

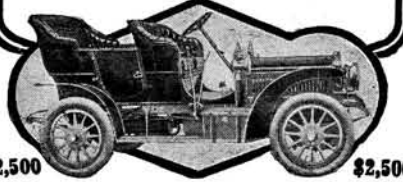

\$2,500

AUTOMOBILES

BOUGHT, SOLD AND EXCHANGED

The largest dealers and brokers in New and Second-hand Automobiles in the world. Send for complete bargain sheet No. 112.

TIMES SQUARE AUTOMOBILE CO.
217 West 48th Street, New York City

1906 THOMAS AUTO-BI

Model No. 44, Price \$145

Three Horse Power. Simplest motorcycle on the market. Agents wanted everywhere. Catalog free.

THE THOMAS AUTO-BI CO.
1450 Niagara Street Buffalo, N. Y.



USE GRINDSTONES?

If so we can supply you. All sizes mounted and unmounted, always kept in stock. Remember, we make a specialty of selecting stones for all special purposes. Send for catalogue "I."

The CLEVELAND STONE CO.
2d Floor, Wilshire, Cleveland, O.



Tool, combination, J. W. Turner..... 837,521

Tool, corrugating, J. Blumer..... 837,783

Tool, pneumatic, H. Leineweber..... 837,856

Top, spinning, L. A. Masette..... 837,316

Toy, mechanical, H. C. Murray..... 837,868

Toy railway, elevated, W. A. Lee..... 837,480

Trace carrier, Falkner & Foust..... 837,817

Track, H. L. Ferris..... 837,819

Tramways and the like, point mechanism for, E. Lawrence..... 837,312

Transit instrument, universal, D. W. Brunton..... 837,791

Trap, See Amalgam trap.

Trolley head for electrical tramway systems, Holmes & Allen..... 837,836

Trolley self-restoring, J. T. Andrew..... 837,771

Trousers hanger, G. I. Laraway..... 837,852

Trousers hanger and press, G. P. Louys..... 837,697

Truck, sewer pipe, F. H. Wippler..... 837,764

Truing up indicator, work, B. F. Ennis..... 837,677

Trunk strap, adjustable metallic, J. L. Mertins..... 837,321

Trunks, safety latch for, J. Wolf..... 837,366

Tube cutter, A. J. Dierzen..... 837,614

Tug, thill, J. E. Lawrence..... 837,313

Tunneling machine, J. E. Ennis..... 837,552

Type column, forming an integral, F. Pierce..... 837,879

Typewriter, M. J. Payne..... 837,338

Typewriter, H. Cross..... 837,611

Typewriter, book, W. M. Rule..... 837,343

Typewriter carriage release device, E. M. Ingersoll..... 837,569

Typewriter platen, C. K. Bradford..... 837,279

Typewriter platen spacing device, M. Klaczko..... 837,625

Typewriter ribbon mechanism, Fox & Barrett..... 837,554

Typewriter, device for indicating the printing point on, F. P. Shepard..... 837,588

Typewriting machine, Plummer & Blackmore..... 837,639

Umbrella notch and runner, J. B. Riehl..... 837,731

Undergarment, C. B. Stephenson..... 837,516

Vaginal irrigator, Farrington & Watson..... 837,459

Valve, A. E. Norris..... 837,876

Valve, local application and equalizing, Turner & Lewis..... 837,358

Valve, pressure regulating, E. McLean..... 837,332

Valve, reversing, B. Smartt..... 837,427

Valve body, F. Stratton..... 837,855

Vehicle frame, motor, Lambert & Fuller..... 837,477

Vehicle, motor, J. M. Lansden, Jr..... 837,628

Vehicle, motor, J. Post..... 837,722

Vehicle wheel, W. J. & J. R. Mitchell..... 837,326

Vehicle wheel, J. J. McIntyre..... 837,709

Vehicle wheel, H. C. Rickheit..... 837,885

Vehicles, means for elevating and transporting motor road, H. Adams..... 837,372

Vending machine, J. W. Patterson..... 837,337

Vending machine, coin operated, J. A. Webster..... 837,362

Vending machine coin operated, J. H. Miller..... 837,702

Vise, J. Goodrich..... 837,681

Vise, needle heading, E. T. Williams..... 837,527

Vulcanizing, H. W. Morgan..... 837,865

Wagon brake, M. W. Adkins..... 837,271

Wagon, dump, R. H. MacClernan..... 837,630

Wagon, dump, G. C. Price..... 837,723

Wagon jack, G. L. Snediker..... 837,352

Waikband, R. L. Gooding..... 837,399

Walls and removing old wall paper therefrom, apparatus for cleaning, Orcutt & Wilson..... 837,877

Washing machine, W. D. Whitney..... 837,525

Washing machine, J. Teel..... 837,596

Washing machine, J. Stauder..... 837,747

Washing machine, S. McGranahan..... 837,874

Washing machine gearing, W. Nahrwolt..... 837,334

Washing machine, laundry, H. T. Klug..... 837,686

Watch roller remover, W. N. Loud..... 837,577

Watch, stem winding and setting, L. Haubert..... 837,564

Water glass guard, W. G. Halliday..... 837,467

Water heater, R. C. Simpson..... 837,741

Weighing machine, T. S. B. Parnall..... 837,420

Welding apparatus, electric, Fulton & Brown..... 837,296

Welding compound, steel, G. Wiesmann..... 837,443

Well construction, D. M. Swain..... 837,433

Wheel, See Fifth wheel.

Winding machines, adjustable guide wire holder for yarn, A. J. Dronsfield..... 837,389

The Worth of an Idea

Only by a rare and lucky chance does the inventor *without* proper training ever receive the full worth of his ideas. By the wonderful system of instruction of the International Correspondence Schools, it is easy to acquire a complete training in any of the occupations named below, and without leaving home or present occupation, secure an almost incalculable advantage.

Mechanical Draughtsman, Civil Engineer, Chemist, Textile-Mill Supt., Electrician, Electrical Engineer, Mechanical Engineer, Telephone Engineer, Electrical Lighting Supt., Surveyor, Stationary Engineer, Building Contractor, Architectural Draughtsman, Architect, Bridge Engineer, Structural Engineer, Mining Engineer.

Write the I. C. S., state the line in which you are interested, and you will, without cost to you, receive full information of how to secure the training you need.

INTERNATIONAL CORRESPONDENCE SCHOOLS,
Box 942, SCRANTON, PA.

TOOLS FOR MECHANICS.

Send for Free Catalogue No. 16 B.

The L. S. Starrett Co., Athol, Mass., U. S. A.

\$80 TO \$175 PER MONTH

For Firemen and Brakemen, experience unnecessary. Instructions by mail at your home. High wages guaranteed; rapid promotion. We assist you in securing a position soon as competent. Send to-day. Full particulars at once. Inclose stamp.

National Railway Training School, Inc.
Room A22, Boston Bldg, Minneapolis, Minn.



A 25-Watt Dynamo \$5.00

Wrought-iron fields, rocking brush holder, compound winding giving steady voltage. Can be used as either shunt, series or compound. Runs equally well as a motor. First-class in every way. Send for one.

E. Q. WILLIAMS
587 S. Clinton St., Syracuse, N. Y.



\$3.00 A YEAR PUBLISHERS' NOTICE

American Homes and Gardens PUBLISHERS' NOTICE **\$3.00 A YEAR**

\$3.00 a year; or, with the SCIENTIFIC AMERICAN, \$5.00 a year.
Measures 10½ x 14 inches. 72 Pages. Colored Cover.

This is a thoroughly practical magazine, dealing with the home and its surroundings. An ideal journal dealing not only with buildings but with country life as well. The aim of the magazine has been to stimulate among its readers a wider interest in the beautifying of the home. The articles deal with not only the house exterior but the interior plans and arrangements and the subject of decoration as well. The garden, as an adjunct or frame of the mansion, receives its full share of attention, and each issue contains examples of artistically planned gardens, large and small, old and new. There will be published in each issue some large estate, and the reader will be taken over the buildings and grounds as a visitor. There will also be published articles dealing with all phases of practical country life.

DURING 1907 ARTICLES WILL BE PUBLISHED ON THESE SUBJECTS:

The Home Roof—A Neglected Opportunity;
How a Woman Made a Worn-out Farm Pay;
The Iris Garden;
The Kitchens of Our Forefathers;
Cement and Concrete in the Formal Garden;
Flowers for House and Table Decoration.



DURING 1907 ARTICLES WILL BE PUBLISHED ON THESE SUBJECTS:

Well designed Appliqué for the Home;
A Naturalistic Garden designed by its owner;
Something Concerning Driveways;
Life on an Olive Ranch;
Longfellow's Home;
Curtains and Draperies.

The magazine is beautifully printed on heavy coated paper, and is elaborately illustrated by handsome engravings made from photographs taken especially for this publication. The colored covers change monthly (see reduced black and white specimens above). AMERICAN HOMES AND GARDENS should have been a place in every home. Send \$3.00 to-day and receive the beautiful November and December issues without charge. Three sample copies, 25c.

MUNN & COMPANY, Publishers, Scientific American Office, 361 Broadway, New York

Classified Advertisements

Advertising in this column is 50 cents a line. No less than four nor more than ten lines accepted.

SALE AND EXCHANGE.

FOR SALE.—Specially built Aeronautic Motor delivering 16 Brake H. P. at 1000 r. p. m.

WANTED.—Copies of our "Manufacturer's Index" issued some eight years ago.

FOR SALE.—Engine Lathe, swings 9 3/4 in., takes 25 in. between centers.

BUSINESS OPPORTUNITIES.

INVENTIONS DESIGNED, perfected and made practical and valuable. We show how to make correctly.

WANTED.—To correspond with first-class artisans in the following lines: Model makers.

NEWEST DIRECTORY OF CIGAR AND TOBACCO Manufacturers, Leaf Tobacco Dealers, etc.

FOR SALE.—Portable Compressed Air House Cleaning Wagons and Machinery sold to responsible parties.

SELL PATENTS.—To buy or having one to sell, write Chas. A. Scott, 719 Mutual Life Building, Buffalo, N. Y.

WE MANUFACTURE METAL SPECIALTIES OF all kinds. Best equipment. Send sketch or model for estimate, stating quantity.

TYPEWRITERS.

TYPEWRITERS OUR OWN MANUFACTURE.—Fully guaranteed at special prices to those who will recommend the American \$50 Typewriter to their friends.

TYPEWRITERS.—Calligraph, \$5. Hammond, \$10. Remington, \$12. Remington two-color ribbon attachment, \$18.

WANTED.—Thoroughly experienced experimental mechanics on typewriter work by one of the front stroke visible writing machine companies.

SPECIAL BARGAINS.—Remington No. 2, writing two colors; Densmore, Hammond, Franklin \$15 each.

TYPEWRITERS.—All makes, all prices. Twelve stores in principal cities.

POSTAL Typewriter \$25. Only real typewriter at low cost. Combines Universal Keyboard, strong manifold, mimeograph stencil cutting.

HELP WANTED.

SUPERINTENDENTS AND FOREMEN with executive ability and experience in some high grade line should learn of openings at our 12 offices.

WANTED.—A Foreman to take charge of machine shop in manufacturing plant, having from 12 to 14 machinists in his charge.

WANTED TO BUY outright several Patents of small articles not requiring heavy machinery to manufacture.

WANTED.—Salesmen to handle high grade, art post cards as side line. Stationers, hotels, newsdealers, cigar stores, drug stores, dry goods merchants, all handle post cards.

UNUSUALLY GOOD SALARIES and a strong demand for men in the photo-engraving business. The wonderful increase in the use of illustrations in all newspapers and magazines creates an unfiled call for men to turn out cuts.

WANTED.—Competent Draughtsman and Designer with experience in handling men, for position with machine shop.

ACETYLENE GENERATOR PATENT FOR SALE.

A. Ross system, carbide to water, measured quantities. No. 690,773 (1900) for stationary lighting. B. Water to carbide, No. 738,070 (1902) for use on vehicles.

EXPERIMENTAL WORK.

JOHN F. FITZ, INC., 89 FRANKFORT ST., makers of patterns and models. Every facility for aiding inventors to perfect their ideas.

AGENTS WANTED.

AGENTS WANTED to sell best kettles in world for cooking, steaming, straining food of all kinds. No more burned or scalded hands.

PHOTOGRAPHY.

INTERESTED IN PHOTOGRAPHY? Then send 25c. for 3 months subscription to the leading American Photographic Magazine for over a generation.

WE PHOTOGRAPH any thing, any where, any time. Building, Paintings, Plans, Models, Machinery, Estates, etc.

LUMIERE PLATES, PAPERS & CHEMICALS. For 30 years the standard in Europe. A free Sample for the asking.

PATENTS FOR SALE.

PATENT RIGHTS for sale on new and novel massaging instrument; weights 1 1/2 ounces; wide field for same if put on the market.

PATENT FOR SALE.—Will sell outright or on royalty Patented Ventilated Lid for dinner pails, dairy and culinary vessels.

AUTOMOBILE PATENT FOR SALE.—Protects damaged tires, prevents skidding. Sure of big sale. Made cheaply.

OFFERS INVITED FOR PURCHASE OF UNITED STATES Patent covering novel and useful device for feeding horses.

PATENT FOR SALE.—I want to sell outright the proprietary rights in my new Improved Metal Fence Post, sure to be used in all parks, farms and gardens.

PATENTS SOLD ON COMMISSION.—If you wish to buy or sell a patent write for particulars to E. L. Perkins, 72 Broad Street, Boston.

MACHINERY FOR SALE.

ALWAYS ON HAND, good second-hand machinery, also boilers and engines, dynamos and motors.

THE VERY THING—a HAND PLANNER. Only \$40. New, good, guaranteed. Has self-hardening tool, outlasts dozen files.

STEAM BOILERS.

THE RECORD of the Hogan Water Tube Boiler proves it the safest, most reliable and efficient steam generator known.

FACTORY AND MILL SUPPLIES.

STOP PAYING WATER RENT at your mill or factory. Erect a Caldwell Tank on a Caldwell Tower or your building.

GAS-LIGHTING APPLIANCES.

THE "PNEU-WAY" of lighting gas! Lights Wellsbachs without electricity frantically on wall!

IDEAL EYE MASSEUR.

A MOST VALUABLE AND SUITABLE PRESENT Indistinct vision, muscular troubles, and chronic diseases of the eye successfully treated by scientific massage.

DRAMATIC.

YOUNG MEN WANTED to learn stage management, acting, stage dancing, makeup, etc. Engagements given to graduates at from \$25 to \$50 per week.

BOOKS AND MAGAZINES.

MAGAZINES, Newspapers and all periodicals at lowest club prices. Our catalogue contains a list of 3,000 periodicals and combination offers.

ASTRONOMY.

STARS AND PLANETS.—Learn to know them at a glance! Astronomy in simplest and most fascinating form.

DESIGNS.

Table listing designs with prices: Badge, B. A. Richardson, Jr. 38,330; Fence post, T. F. Jasper 38,335; Mower casing, lawn, M. E. Stanton 38,336 to 38,341; Rug, W. T. Smith 38,333; Spoons, forks, or similar articles, handles for, G. L. Crowell, Jr. 38,332; Stove, L. Carr 38,342; Toy figure, E. E. Quaintance 38,334; Watch charm or similar article, K. E. Savage 38,331

TRADE MARKS.

Table listing trade marks with prices: Acid or cresote preparation, carbolic, Vaporesolene Co. 58,072, 58,094; Ale, McCormick Brewery Co. 57,996; Ales, Arnold & Co. 58,019; Antiseptic mouth wash, F. Loeser & Co. 58,106; Automobiles, E. A. Gramm 57,993; Baking powder, E. Metzner 58,108; Beef oil or fat, Schwarzschild & Sulzberger Co. 58,136; Beer, Anheuser-Busch Brewing Association 57,991; Beer, Pabst Brewing Co. 57,998, 57,999; Beer, Ebbling Brewing Co. 58,030; Beer, ale, and porter, lager, Du Bois Brewing Co. 58,020; Bicycle crank hangers, Great Western Manufacturing Co. 57,964; Biscuits, Manaban Laxative Biscuit Co. 58,107; Bleacher, deodorizer, disinfectant, and germicide, A. Castaing 58,101; Boats, certain named, Racine Manufacturing Co. 58,016; Boiler compound, International Boiler Cleaning Co. 58,104; Boots and shoes, leather, W. McKittrick 57,913; Boots and shoes, leather, Copeland & Ryder Co. 57,959; Boots and shoes, leather, Starner-Copeland Co. 57,985; Bread, C. Trefzger 58,156; Butter and cheese, Blackman & Griffin Co. 58,127; Butter, peanut, J. Koehler 58,149; Buttons, lever cuff, W. H. Wilmarth & Co. 58,042; Calcium carbid, Advance Furnace Company of America 58,055; Calcium carbid, Acetylene Gas Illuminating Co. 58,095; Cameras, photograph, Folmer & Schwing Co. 57,887, 57,888; Candles and chocolates, C. E. Ball 58,153; Candy, Manufacturing Company of America 58,150

Wouldn't You Like to Own This 16 Shot Repeating Rifle? Only \$7.75

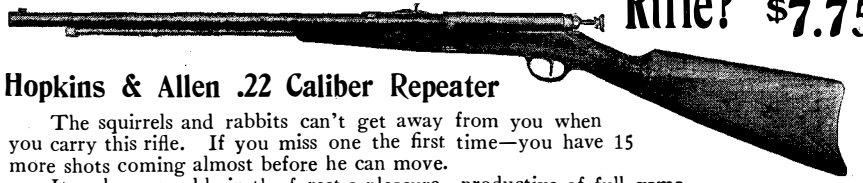

Hopkins & Allen .22 Caliber Repeater

The squirrels and rabbits can't get away from you when you carry this rifle. If you miss one the first time—you have 15 more shots coming almost before he can move.

Description: This is the finest and most reliable repeating rifle ever offered at the price. It shoots 22 long or short or 22 long rifle cartridges—16 shots for shorts and 12 for long or long rifle—and the ejector works like lightning.

Quick take-down pattern—full length 3 1/2 in., length of barrel 20 in.—weight 5 1/2 lbs. Has that excellent military bolt action—the first ever put on an American sporting rifle.

PRICE—Safe delivery guaranteed—\$7.75—IF YOUR OWN DEALER CANNOT SUPPLY YOU. We publish two delightful stories—"William Tell," the experience of an expert with his first Junior Rifle, and "My First Rifle." by the famous marksman, Capt. Jack O'Connell.

Showing Position Ejector in Ejecting Shell

HOPKINS & ALLEN ARMS CO., Dept. 138, Norwich, Conn., U. S. A. London Office: 6 City Road, Finsbury Square, London, England. The largest manufacturers of High Grade Shot Guns, Rifles and Revolvers in the World.

BALSAM SANITISSUE

A New Toilet Paper

Treated with aromatic Canada Balsam, which makes it the softest and strongest toilet paper made.

SCOTT PAPER CO., 504 GLENWOOD AVE., PHILADELPHIA.

I WILL HELP YOU MAKE MONEY

No matter where you are located or what your former occupation, if you are honest and ambitious, I will teach you the Real Estate, Insurance and General Brokerage Business thoroughly by mail.

EDWIN R. MARDEN, President Nat'l Co-Operative Realty Co. 556 Athenaeum Bldg. CHICAGO, ILL. or 556 Maryland Bldg. WASHINGTON, D.C.

THE "BEST" LIGHT

Produces a pure white, powerful steady light, is absolutely safe, and brighter than electricity or acetylene—cheaper than kerosene. NO GREASE, DIRT, SMOKE OR ODOR. Makes and burns its own gas.

THE BEST LIGHT CO., 87 E. 6th St., Canton, O.

Just Published

The New Agriculture

By T. BYARD COLLINS

12mo, 374 pages, 106 illustrations, cloth, price \$2.00

THIS new and authoritative work deals with the subject in a scientific way and from a new viewpoint. Dr. Collins has devoted his lifetime to the study of changing economic agricultural conditions.

MUNN & CO., Publishers of "Scientific American," 361 Broadway, New York

On almost every GOOD Car

You'll see



It turns on here like City gas. Connects here with lamps.

Contains ready-generated Acetylene Gas ready for use at any time at the turn of the key.

- Forty hours light at the turn of a key. Tanks last FOREVER. No bother. No trouble. No Carbide. No Water. No Dust. Just pure white light at the turn of a key.

This little tank holds enough Compressed Acetylene Gas (already generated and purified) to supply two big lamps for forty hours. Old empty tanks exchanged for new full ones at dealers and garages in over 400 cities.

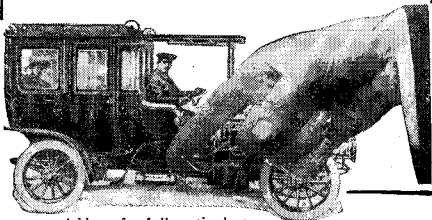

Address for full particulars THE PREST-O-LITE CO., Dept. 26, Indianapolis, Ind.

Tours

Personally Conducted— Exclusively First-Class—to California—January 10th, February 7th and March 2nd under the auspices of the tourist department, Chicago, Union Pacific and North-Western Line;

Include all expenses

—hotels, railway fare, sleeping car and dining car accommodations of the finest character, and numerous side trips. So arranged as to spend the disagreeable portions of the winter months in comfort and ease.

Write for itineraries and full particulars to S. A. Hutchinson, Manager, 212 Clark Street, Chicago, Ill.

ARITHMETIC

SELF-TAUGHT Do not despair because through neglect you have forgotten what you once learned about Arithmetic. PROF. SPANGENBERG'S NEW METHOD requires no teacher. 257 pages; sent prepaid on receipt of 60c. in stamps. Edition de Luxe \$1.00. GEO. A. ZELLER BOOK CO., 48 South 4th St., St. Louis, Mo.



"Econo" Emery Wheel Dresser

Size 12 in. Made of an abrasive nearly as hard as the Black Diamond. Will true or shape any wheel except the very hard carbide. The "Econo" is the roughing tool placed in the handle end of "Econo." Send for circular. Dresser sent on 15 days' trial. INTERNATIONAL SPECIALTY CO., 360 Holden Ave., Detroit, Mich.

STUDY HIGH GRADE INSTRUCTION BY CORRESPONDENCE

Prepares for the bar of any State. Improved method of instruction, combining the Text-Book, Lecture and Case-Book methods. Approved by the bench and bar. Three Courses: College, Post-Graduate and Business Law. Uniform rate of tuition. Send for Catalog.



Chicago Correspondence School of Law Reaper Block, Chicago

60 YEARS' EXPERIENCE

PATENTS

TRADE MARKS DESIGNS COPYRIGHTS & C.

Anyone sending a sketch and description may quickly ascertain our opinion free whether an invention is probably patentable. Communications strictly confidential. HANDBOOK on Patents sent free. Oldest agency for securing patents. Patents taken through Munn & Co. receive special notice, without charge, in the Scientific American.

A handsomely illustrated weekly. Largest circulation of any scientific journal. Terms, \$3 a year; four months, \$1. Sold by all newsdealers. MUNN & Co., 361 Broadway, New York Branch Office, 636 F St., Washington, D. C.

Table listing various products and their prices, including remedies for diseases, sheet metal ware, and various household items.

LABELS.

Table listing labels for products like 'American Club Cheese', 'Arabian Slave', and 'Hackett's Gape Cure'.

PRINTS.

Table listing prints for 'Dr. A. Grandjean's Hygienic Adjustable Bed Clothes Clamp' and 'Hackett's Gape Cure'.

A printed copy of the specification and drawing of any patent in the foregoing list, or any patent in print issued since 1863, will be furnished from this office for 10 cents, provided the name and number of the patent desired and the date be given. Address Munn & Co., 361 Broadway, New York.

What to Demand in a Closet

Absolute cleanliness assured by water capacity and width of water surface in bowl.

Water jet at bottom of bowl, which cleanses the inside of the trap, and insures bowl being absolutely washed out.

W. dep of sibi

Vac whic of br sy

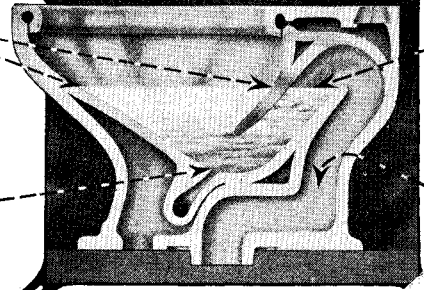

To know what a closet should be to be safe, study the sectional view showing the principle and action of the Sy-Clo Closet. If your closet is not self-cleaning, odorous, positive in its action when flushed, replace it with the Sy-Clo,—"the closet of health".



The Sy-Clo Closet as shown by the illustration of the sectional view, is formed in a single piece—fine hand-moulded china—without a crack or crevice where impurity can lodge.

FREE. Send us the name of your plumber, and we will send you a valuable booklet "Household Health". It will tell you how to be certain of the sanitation of your home, and may explain the cause of past illnesses you have never understood.

POTTERIES SELLING COMPANY, Trenton, N. J.

LET US BE YOUR FACTORY WRITE FOR ESTIMATE ON ANY ARTICLE YOU WANT MANUFACTURED STAMPINGS, MODELS, EXPER. WORK WRITE FOR FREE BOOKLET THE GLOBE MACHINE & STAMPING CO. 970 Hamilton St., Cleveland, O.

Bad Water DON'T DRINK Our Filters Purify, Deodorize, Decolorize. Booklet Free. Buhring Water Purifying Co. 68 Murray St., New York

"KNIFE" BALL BEARINGS Pat. For thrust or weight or both. No fitting, just push them on. All sizes 1-4 in. Shaft and up to 10 cts. in stamps for samples. PRESSED STEEL MFG. CO., 545 The Bourse, Phila., Pa.

FREE ILLUSTRATED BOOK We will on request send to you postpaid, this book, also our special plans by which you can secure any article in our catalog absolutely free. Write to-day—don't miss this chance. J. Andrae & Sons Co., 114 W. Water Street, Milwaukee, Wis.

ICE MACHINES Corliss Engines, Brewers and Bottlers Machinery. THE VILTER MFG. CO. 890 Clinton St., Milwaukee, Wis.

MODELS & EXPERIMENTAL WORK. Inventions developed. Special Machinery. E. V. BAILLARD. 24 Frankfort Street, New York.

RUBBER Expert Manufacturers Fine Jobbing Work PARKER, STEARNS & CO., 228-229 South Street, New York

GEO. M. MAYER, 1131 MONADNOCK, CHICAGO WORKING DRAWINGS

MR. INVENTOR Send us your models or drawings for our lowest prices. We can develop, perfect or manufacture your invention. MONARCH TOOL CO., 128 Opera Place, Cincinnati, O.

DRYING MACHINES. For Sand, Clays, Minerals, Wood Pulp, Fertilizers, Chemicals, Ores, Ground Silica and Alca and other Granulated Materials. S. E. WORRELL, HANNIBAL, MO.

Dies, Tools, Models and Special Machinery. Metal Specialties and Stamping Manufacture. HOEFT & MOORE, CHICAGO, U. S. A. OFFICE, 512 FIFTH AVENUE WORKS, DULWA & FRANKLIN STREETS

Specialties & Patents Bought and Sold American Commerce & Specialty Co., Inc., 95 Dearborn St., Chicago

THE SCHWERDTLE STAMP CO. STEEL STAMPS, LETTERS & FIGURES. BRIDGEPORT CONN.

NOVELTIES & PATENTED ARTICLES MANUFACTURED BY CONTRACT. PUNCHING DIES, SPECIAL MACHINERY. E. KONIGSLOW STAMPING & TOOL WORKS, CLEVELAND, O.

Experimental & Model Work Ctr. & advice free. Wm. Gardam & Son, 45-51 Rose St., N.Y.

LEARN PLUMBING A few months' instruction at our school under the supervision of expert plumbers, will enable you to earn regular plumber's wages. We have a special department to aid our students in securing a position after graduating. Write to-day for FREE ILLUSTRATED CATALOGUE. ST. LOUIS TRADE SCHOOL, 3972 Olive Street, St. Louis, Mo.

Magical Apparatus. Grand Book Catalogue. Over 700 engravings 25c. Parlor Tricks Catalogue, free. MARTINKA & CO., Mfrs., 436 Sixth Ave., New York.

LEARN WATCHMAKING We teach it thoroughly in as many months as it formerly took years. Does away with tedious apprenticeship. Money earned while studying. Positions secured. Easy terms. Send for catalog. ST. LOUIS WATCHMAKING SCHOOL, St. Louis, Mo.

MASON'S NEW PAT. WHIP HOIST for Outrigger hoists. Faster than Elevators, and hoist direct from teams. Saves handling at less expense. Manfd. by VOLNEY W. MASON & CO., Inc. Providence, R. I. U. S. A.

INVENTORS We manufacture METAL SPECIALTIES of all kinds, to order; largest equipment; lowest prices. Send sample or model for low estimate and best expert advice FREE. THE EAGLE TOOL CO., Dept. A, Cincinnati, O.

TYPEWRITERS ALL MAKES All the Standard Machines SOLD or RENTED ANYWHERE at 1/2 to 3/4 Mfr's prices. RENTAL APPLIED on price. Shipped with privilege of examination. Write for "Cat." TYPEWRITER EMPORIUM, 202 LaSalle Street, CHICAGO

How to Build an Ice Yacht

SCIENTIFIC AMERICAN SUPPLEMENT 1154 describes exhaustively and clearly the Building of a Lateen Ice Boat. Full working drawings accompany the text.

The SCIENTIFIC AMERICAN SUPPLEMENT 1197 contains an article in which the construction of an Up-to-Date Ice Sloop is carefully explained with the help of complete drawings.

In SCIENTIFIC AMERICAN SUPPLEMENT 1253 an illustrated article is published on A Jib-Headed Mainsail Sloop Ice Yacht.

In SCIENTIFIC AMERICAN SUPPLEMENT 1556 is published an article on Improved Ice Yacht construction, a craft being described having a Hollow Backbone and 250 Square Feet of Sail Area.

Each article is accompanied by Complete Working Drawings.

The entire set of four papers here enumerated will be sent by mail on receipt of 40 cents.

Any single number can be supplied for 10 cents.

Order from your newsdealer or from

MUNN & CO., 361 Broadway, New York

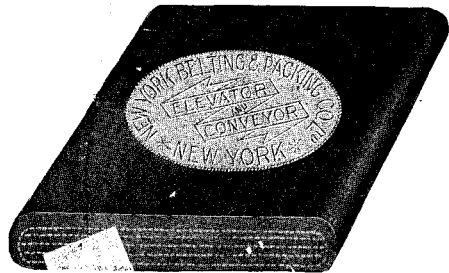

Rubber Elevator & Conveyor Belting

FOR CONVEYING AND LIFTING
BROKEN STEEL, COAL, COKE, WOOD
PULP, GRAVEL, SAND, SUGAR, etc., etc.

SPECIAL CONSTRUCTION
EXCEPTIONAL QUALITY

NEW YORK RUBBER & PACKING CO., Ltd.

91-93 CHAMBERS STREET, NEW YORK

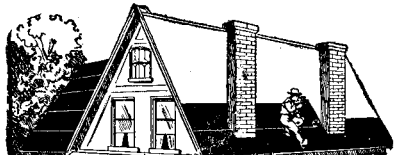

IF YOU OWN A ROOF, USE MICA-NOID Ready Roofing and save repairs. MICA-NOID is proof against water, wind, snow and climatic changes, and will last a life-time with reasonable care. We pay the freight. Samples upon request. Write today. Address **ASBESTOS MFG. & ROOFING CO.** Manufacturers of Everything in the Asbestos Line 218 CARR STREET ST. LOUIS, MO.

CRUDE ASBESTOS DIRECT FROM MINES

PREPARED ASBESTOS FIBRE for Manufacturers use
R. H. MARTIN, OFFICE, ST. PAUL BUILDING 220 B'way, New York.

CHARTER

Stationaries, Portables, Hoisters, Pumps, Saws and Boat Outfits, Combined with Dynamos.
Gasoline, Gas, Kerosene.
Send for Catalogue.
State Power Needs.
CHARTER GAS ENGINE CO., Box 148, STERLING, ILL.

Scales All varieties at lowest prices. Best Railroad Track and Wagon or Stock Scales made. Also 1000 useful articles, including Saws, Sewing Machines, Bicycles, Tools, etc. Save Money. Lists Free **CHICAGO SCALE CO.,** Chicago, Ill.

Bausch & Lomb Reading Glasses



The lenses of these large magnifying glasses are carefully ground and polished and are mounted in durable nickle-plated rim with ebonized handle. Every SCIENTIFIC AMERICAN reader ought to have one of these glasses. There are hundreds of things in every day work that are easier to see with a little magnification.

PRICES: 2 inch lens, \$0.75, Post Paid. Catalog on request.
3 inch lens, 1.20, Post Paid, request.
Bausch & Lomb Opt. Co., Rochester, N. Y.
NEW YORK BOSTON WASHINGTON CHICAGO SAN FRANCISCO

The Good Power

Should be simple, easy to run and keep in order, of full rated horse power, economical in fuel and the use of oil, free from the necessity of repairs and so constructed as to endure indefinitely. These power essentials apply in a high degree to the

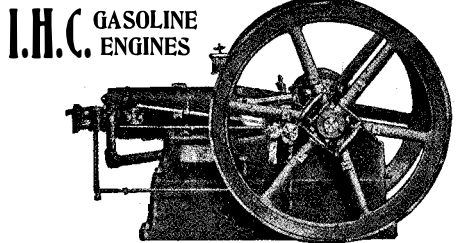

I.H.C. GASOLINE ENGINES
In addition they are adapted to every power use and requirement. They give perfect satisfaction under proper instalment. They are made in several styles—Horizontal (like cut here shown), Stationary or Portable, 4, 6, 8, 10, 12, 15 and 20 horse power. Vertical, 2, 3 and 5 horse power. Buying an I. H. C. Gasoline Engine puts you right and keeps you right on the power question. A complete investigation of these facts will serve your interest well. Better begin at once by writing for our engine catalog. International Harvester Company of America (Inc.) 7 C Monroe Street, Chicago, Ill.

LUFKIN TAPES AND RULES ARE THE BEST.

For sale everywhere. Send for Catalog No. 16.
LUFKIN RULE CO., Saginaw, Mich., U. S. A. New York and London.

Type XV 50 H.P. Price \$4,250

POPE-TOLEDO

1907 1907

If every prospective purchaser of a touring car knew what we know about Type XV Pope-Toledo, ten times our factory capacity would not supply the demand. We shall build Type XV so good that our capacity will be limited to 500.

Six to Sixty Miles an Hour on High Gear; Chrome Nickel Steel Construction throughout; Selective Gear-set; Four Speeds; Deutsch Waffen Fabrik Bearings; Mechanical Valves; Multiple Metal Disc Clutch.

Send for complete advance literature

Pope Motor Car Co., Toledo, O.
Members Association Licensed Automobile Manufacturers
We exhibit in New York at Madison Square Garden only January 12 to 19

STEAM USERS

Rainbow Packing

The original and only genuine red sheet packing.
The only effective and most economical flange packing in existence.
Can't blow Rainbow out.
For steam, air, hot or cold water, acid and ammonia joints.
Beware of imitations.
Look for the trade mark—the word Rainbow in a diamond in black, three rows of which extend the full length of each roll.
Manufactured exclusively by
PEERLESS RUBBER MFG. CO.
16 Warren St., New York

UNIVERSITY SHOE

(Trade-Mark.)
Heaviest oily grain leather—tan colored. Watertight construction. Comfortable and nearly indestructible. Send for pamphlet.
J. TWADDELL,
1210-1212 Market St., Philadelphia

This watch only \$21

In offering this fine high grade Hampden watch at \$21, we believe we are giving readers of the SCIENTIFIC AMERICAN the greatest watch value ever offered for the money. It is a gentleman's size, 2 1/2 full ruby jeweled, perfectly adjusted Hampden movement, open face, 20-year gold filled case, and is guaranteed to pass inspection on any railroad in the United States. Jewelers ask \$31 for this watch, but we will send it to you on receipt of \$21. We can also furnish the same watch in 17 jewel for \$12.85, the regular price of which is \$18 in jewelry stores. Either of these watches will be sent upon receipt of price with privilege of return if not exactly as represented. Isn't this a fair proposition? We also want to mail you our handsomely illustrated catalog of Watches, Diamonds, Cut Glass, Silverware, Embroidered Goods and Jewelry Novelties. Write for it today—it's FREE.
JOHN C. PIERIK & CO., 80 Pierik Bldg., Springfield, Ill.

As A Present

Why not one of these
NEW YORK STANDARD
"Chronographs?"

DUST and MOISTURE PROOF
WRITE FOR FREE BOOKLET SHOWING OTHER STYLES
\$7.50
In Silverode Case

They combine a 1-5 second hand with an accurate movement and will ever be a reminder of the donor.

All Jewelers Sell Them
They Are Fully Guaranteed

New York Standard Watch Co., 401 Communipaw Ave., Jersey City, N. J.

THE DIAGRAPH

(Trade Mark Registered)
The Improved Stencil Cutting Machine
Is a saving of 90 per cent in your Shipping Department worth considering? Just a word will bring our free illustrated booklet describing the Diagraph and our "No Error" System of shipping goods.
American Diagraph Co., 10 N. Second Street, St. Louis, U. S. A.

Saves Half Your Coal Bill

because the heat which usually goes up the chimney is caught and made to do its full duty by the

New Era Radiator

consisting of scientific arrangement of perpendicular tubes which arrest the most heat and create a greater circulation than any other known means. Saves half your fuel bills and heats an extra room without additional expense, and they fit any pipe. Ask your dealer, or us, for full particulars.

WILMOT CASTLE CO.,
17A Elm St., Rochester, N. Y.

BEAUTIFUL PENS IN SILVER AND GOLD

As Well As Plainer Ones of Equal Usefulness
Nothing So Appropriate for
XMAS The Season for giving

THE PAUL E. WIRT FOUNTAIN PEN

makes the most acceptable and lastingly appreciated Xmas gift for either lady or gentleman. There is no uncertainty about the recipient getting unending satisfaction from a **Wirt Fountain Pen**. It is ALWAYS READY—ALWAYS WRITES. Best by test of a quarter of a century.

Made in 100 styles, to suit all hands and purses. Sold by leading dealers everywhere. Send for Illustrated Catalogue and Price List.

Box C 23. Bloomsburgh, Pa.

GRAY MARINE MOTORS

4 h. p. bare engine will develop 5 h. p. Engines
\$54.00
Get prices on 1 1/2 to 24 h. p. Engines

Reversible engine. Jump spark. Perfect lubrication. Crank shaft drop forged steel. Connecting rod, bronze. Pistons ground to fit. All bearings either bronze or best babbit. Best material and workmanship throughout.
Gray Motor Co., 33 Lieb St. Detroit, Mich.

IT PAYS BIG TO amuse the Public With Motion Pictures

NO EXPERIENCE NECESSARY as our instruction Book and "Business Guide" tells all. We furnish Complete Outfits with Big Advertising Posters, etc. Humorous dramas brimful of fun, travel, history, religion, temperance work and songs illustrated. One man can do it. Astonishing Opportunity in any locality for a man with a little money to show in churches, school houses, lodge halls, theatres, etc. Big profits each entertainment. Others do it, why not you? It's easy; write to us and we'll tell you now. Catalogue free.
AMUSEMENT SUPPLY CO., 487 Chemical Bank Bldg., CHICAGO

HELMET OIL LUBRICATES ANYTHING

TRY IT. **CHESLEY & CO.**
15 to 21 South Clinton Street.