

LIBRARY



Sp. Col.
T51490
H6
V.1

PROPERTY OF
WARFORD DURFEE TEXTILE SCHOOL.

FIRST YEAR WEAVING.

BY James Holmes.

If a piece of plain cloth is examined through a magnifying glass, it will appear the same as shown in the lower part of Fig. 1. The vertical lines represent threads of warp and the horizontal lines picks of weft, in the upper part of the figure, is a number of squares, these squares are filled in and left blank to suit the pattern of cloth given below the squares; a row of squares down the paper equals a warp end; a row of squares across the paper equals a pick of weft.

WHEN A WARP END IS LIFTED A SQUARE IS FILLED IN.

In Fig 1, on the first Pick the 2nd and 4th ends are lifted, therefore, on the 1st row of squares the 2nd and 4th are filled in, and so on for the four picks. It is of the utmost importance that this matter should be thoroughly understood, and for that purpose the following examples are given, Fig 2. a three end twill Fig. 3 a four end twill, Fig. 4 a five end Sateen, and Fig. a wave pattern. Figs. 6, 7, 8, 9 and 10 shows the four designs given, (repeating) on ordinary design paper. Fig. 11 gives the plan of a cloth, with the 1st and 5th ends filled in, on squared paper, complete the work on the design paper. In Fig. 12 complete the plan of the cloth. In Figs. 13, 14 and 15 transfer the patterns of the cloths given to design paper, the first pick in Fig. 14 and the 4th pick in Fig 15 shows how the work must be done.

Figs. 16, 17, 18, 19, 20 and 21 are suitable designs for a sixteen shaft dobby, by special looming or drafting some of them could be woven on less than sixteen shafts. Peg and weave these designs. Transfer Fig. 22 to squared paper.

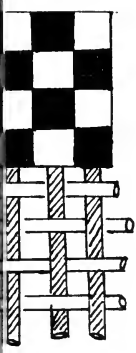

Fig. 1

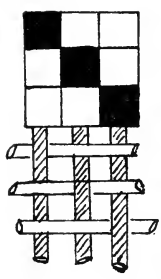

Fig. 2

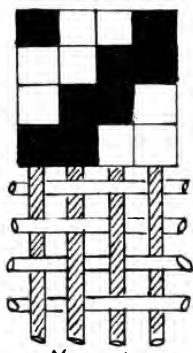

Fig. 3

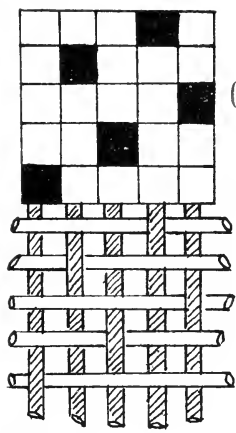

Fig. 4

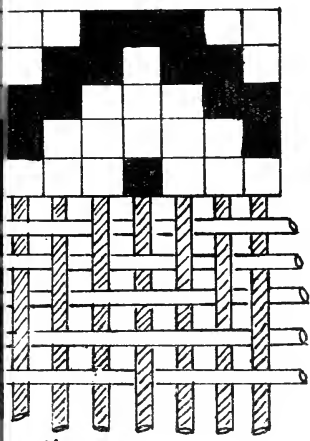

Fig. 5

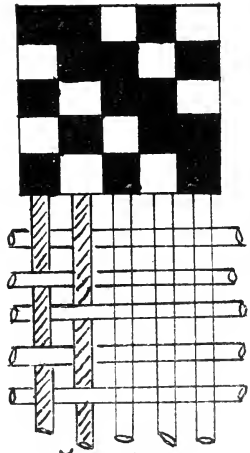

Fig. 12

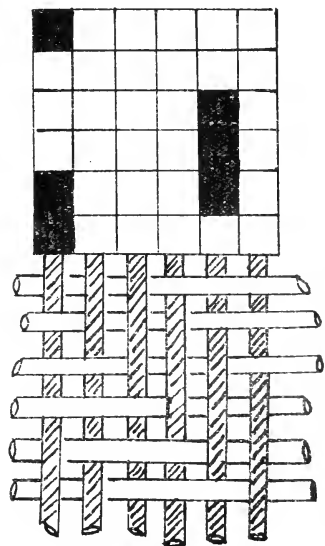

Fig. 11

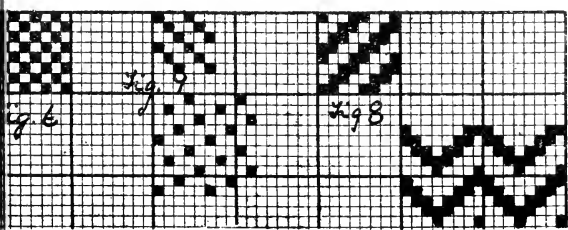

Fig. 6

Fig. 9

Fig. 8

Fig. 9

Fig. 10

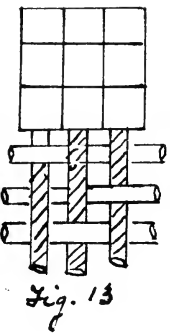

Fig. 13

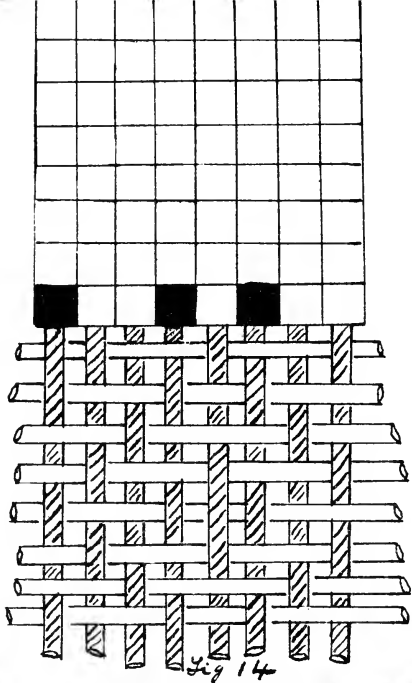

Fig. 14

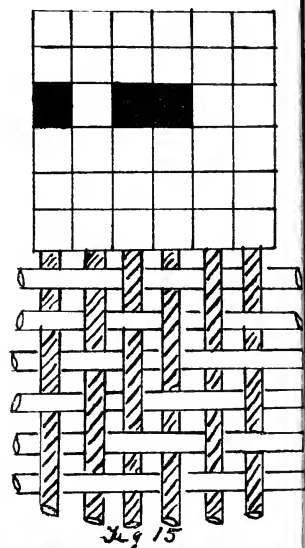

Fig. 15



Fig. 16

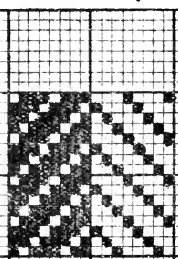

Fig. 17

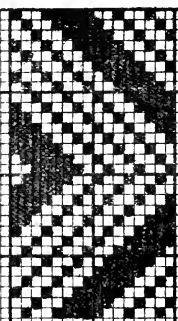

Fig. 18



Fig. 19

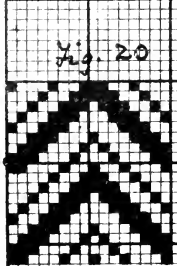

Fig. 20



Fig. 21

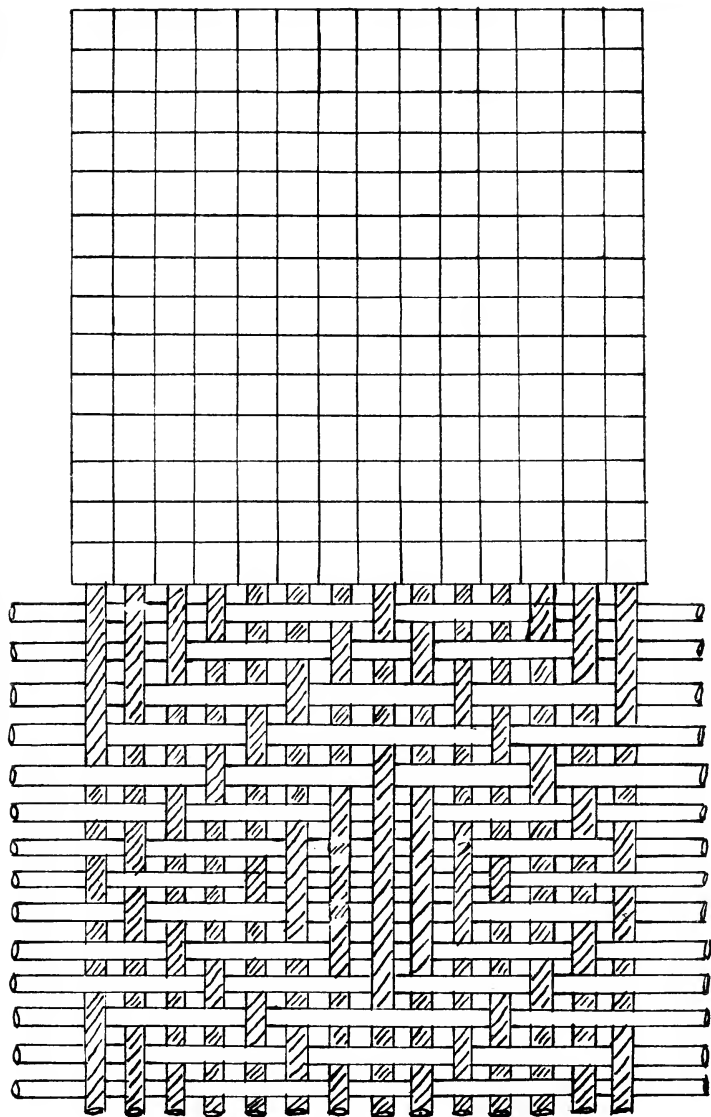

Fig. 22

TWILLS are the simplest form of weave. they can be made on any number of healds from three upwards. the number of ends lifted in any one pattern is the same on each pick. the filled in squares advancing one to the right or one to the left on each pick, depending upon the direction the twill is running.

Figs 23 and 24, 25, 26 are complete five end twills. Figs. 27, 28 and 29 six end twills. Finish Figs 30 and 31. Figs 32 and 33 are 8 end twills. Fig. 42, 9 end twill. Fig. 44 a 12 end twill. Fig 50 a 13 end twill. Fig. 52 a 14 end twill. Fig. 54 a 16 end twill. Finish the examples Figs 30, 31, 34, 35, 37, 38, 39, 40, 41, 43, 44, 45, 46, 48, 49, 51, 53, 55. Repeat Fig. 56 to fill the space provided.

WAVES DOWN THE PIECE, are made by running the twill in a given direction until the pattern would repeat, but instead of letting it repeat as a twill the direction of the twill is reversed as shown in the Figs 59, a 12 shaft, 60, a 14 shaft, 61, a 16 shaft. Finish the examples Figs. 62, 63, 64 and 65 by make wave patterns. Repeat Fig 66 on the space provided. make a wave from Fig 64 and repeat.

WAVES ACROSS THE PIECE. In these examples a knowledge of drafting the ends through the healds is required, for that purpose the squares above the pattern are used to represent the healds, and a x indicates that the thread below it, is drawn on the heald to which it is opposite. And all the ends weaving alike are drawn on the same shafts. The peg plan indicates the order of lifting the healds when making the cloth. Figs. 70 and 73 show complete examples. Finish the Figs 72, 74, 75, 76, 77 and 78. make suitable patterns and weave them for Fig 57, 68 and 79. Give the patterns on spaces 58, 69 and 80 of the cloth provided.

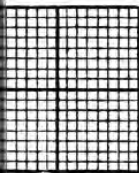
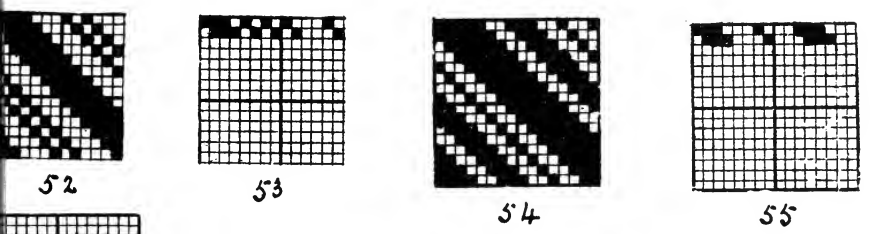
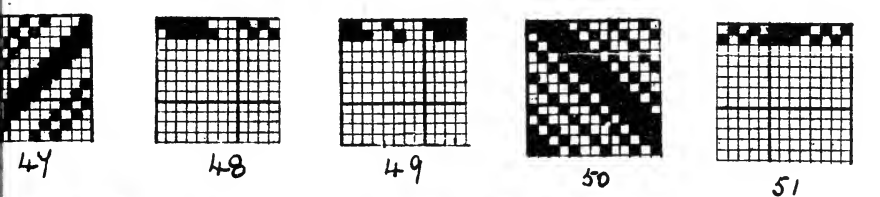
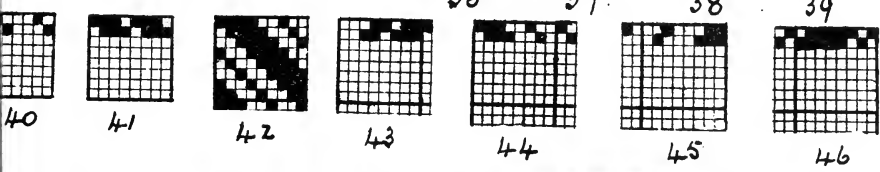
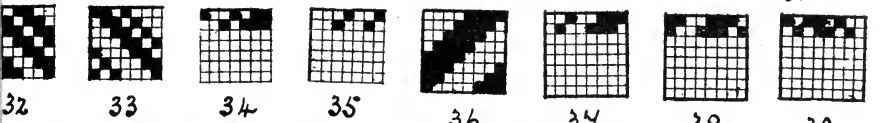
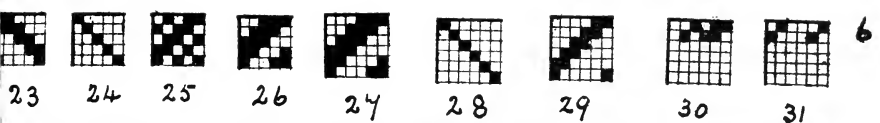

TWILL
WOVEN
SAMPLE
OF
CLOTH

CLOTH
for
ANALYSIS

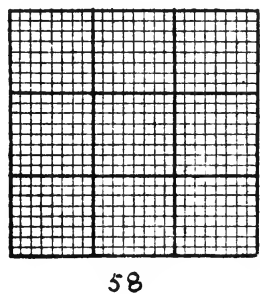

7

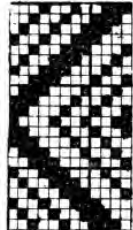

59



61

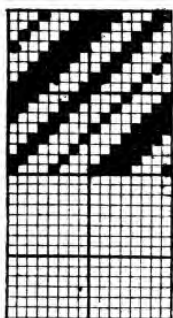

62

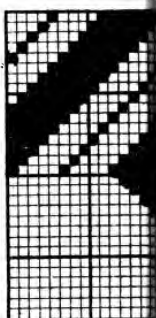

63

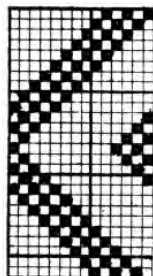

60

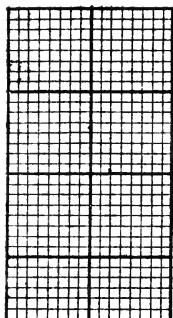

68

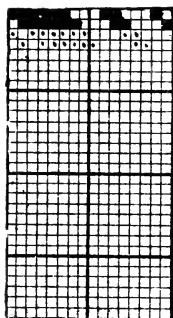

64

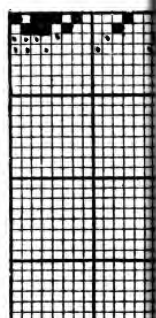

65

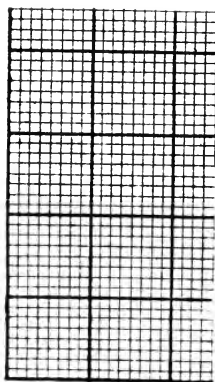

69

WOVEN
SAMPLE
of
CLOTH
WAVE DOWN
THE PIECE

CLOTH
for
ANALYSIS

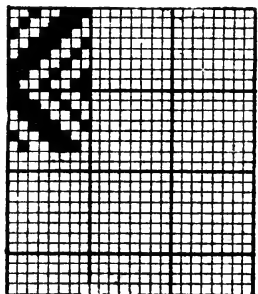

66

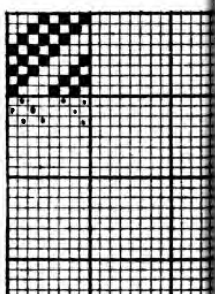

67

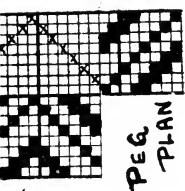

70

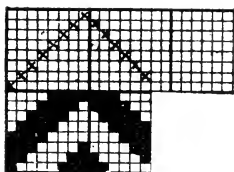
PEG
PLAN

71

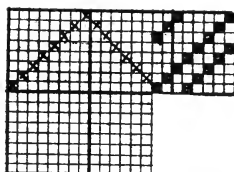

72

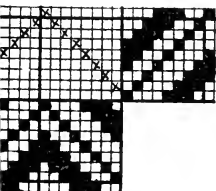

73

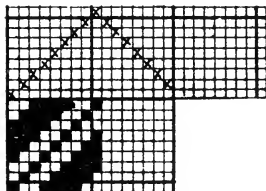

74

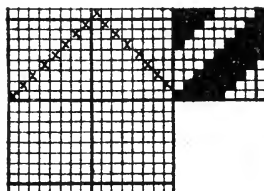

75

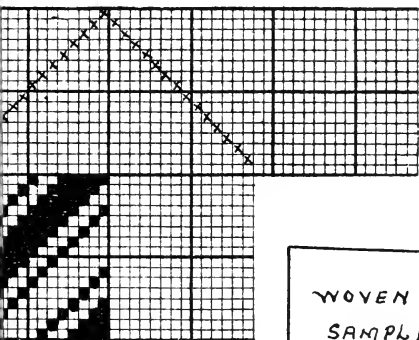

77

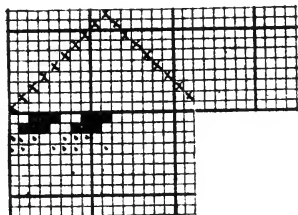

76

WOVEN
SAMPLE
OF
CLOTH.
WAVE ACROSS
THE PIECE

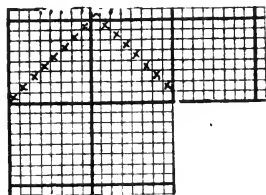

78

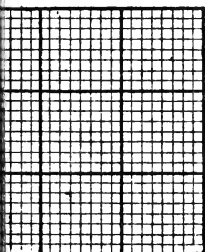

80

CLOTH
for
analysis

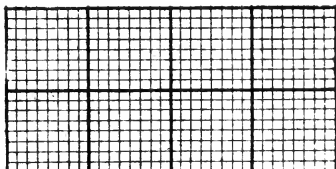

79

SPOT FIGURES can be made from twills, by first making the twill into a wave down the piece for the peg plan, and drawing the ends through the healds point or \wedge draft. Fig 81 gives a complete example showing the pattern looming and peg plan. Finish the patterns Figs. 82, 83 and 84. From the twill, and the looming shown make a spot in Fig. 85. In Fig 86 make a spot from the looming and peg plan given or in Fig. 88 make a spot effect and weave it.

On Fig. 89 put down the pattern of the cloth given show the looming and the peg plan

In Figs 90, 91, 92, 93 and 94 a number of spot patterns are given, more or less incomplete, fill the respective spaces with the patterns there given.

TO INCREASE THE SIZE OF A PATTERN BY AN ALTERATION IN THE LOOMING, on the drawing of the ends through the healds, when the ends are drawn in straight-gait over, the number of ends in the pattern is equal to the number of healds used. In Fig. 95 the number of ends in the pattern is 60, the number of healds used is only 8, as shown by the looming and the peg plan, the depth of the wave before it begins to turn is 16 picks. Fig. 96 is a six shaft, 3 times through from front to back and 3 times through from back to the front in the looming, the pattern repeats on 68 end and the depth of the wave is 18 picks, finish the design. Fig. 97 is an eight shaft with an irregular looming, carried to 24 picks to the round, finish the pattern from the looming and peg plan given. Fig. 98 is a 10 shaft irregular looming, carried to 24 picks to the round, finish the pattern.

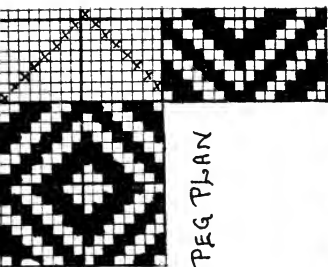

81

PEG PLAN

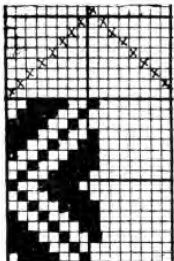

82

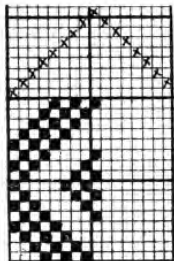

83

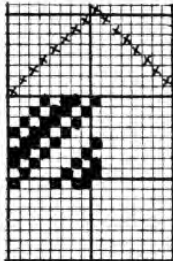

85

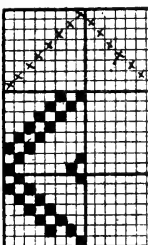

84

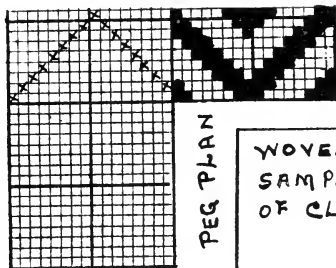

86

PEG PLAN

WOVEN
SAMPLE
OF CLOTH

CLOTH
for
ANALYSIS

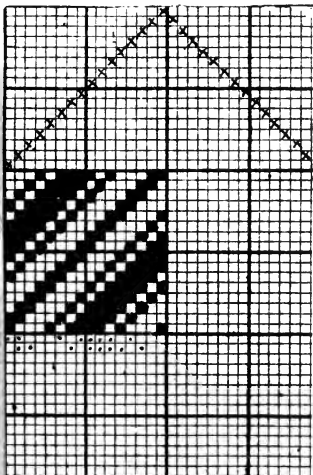

87

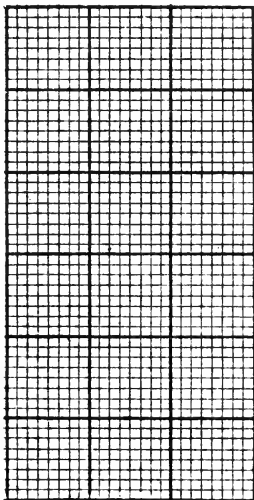

88

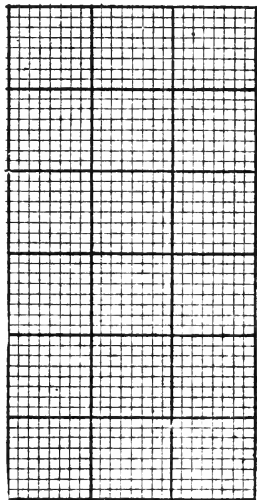

89

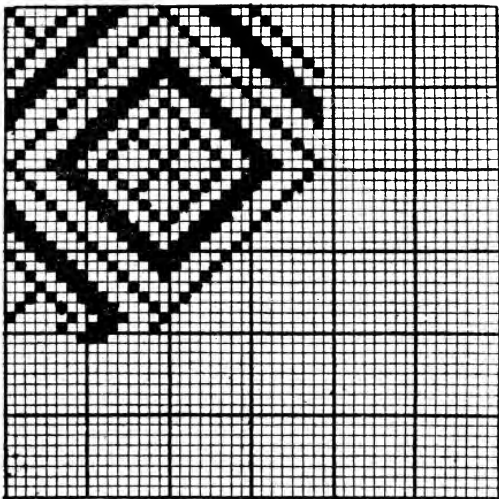

90

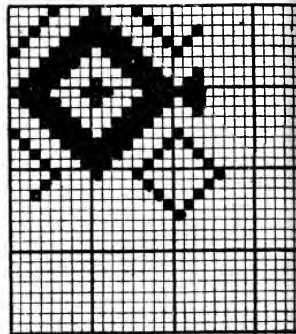

92

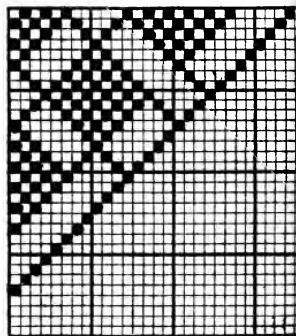

93

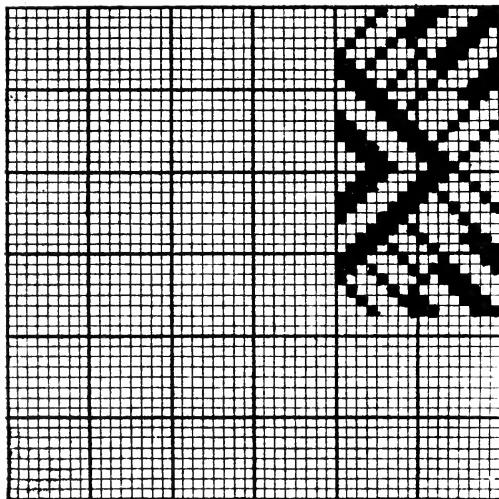

91

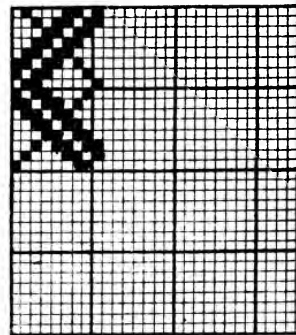

94

12

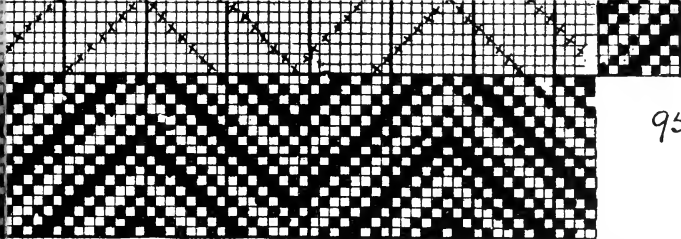

95

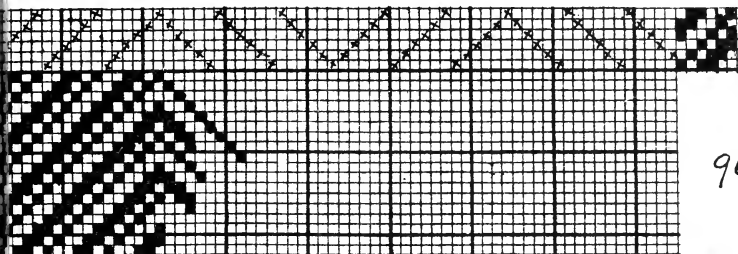

96

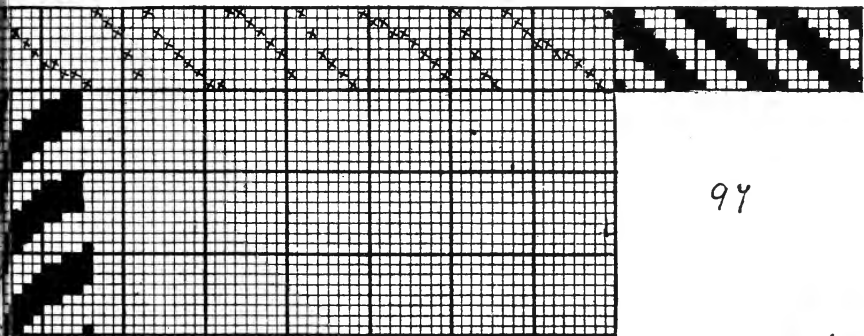

97

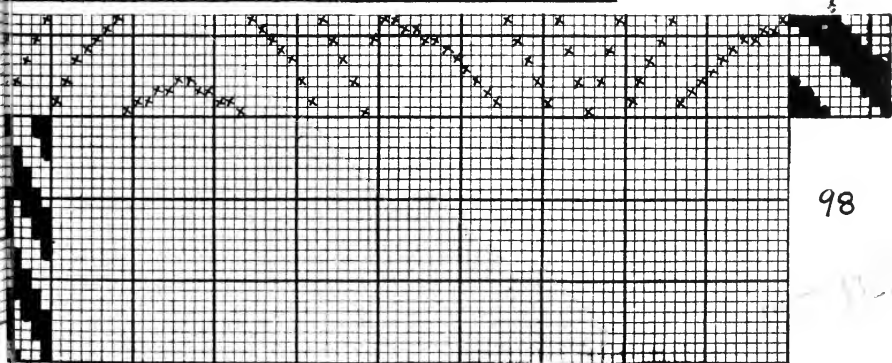

98

CHECKS, STRIPES and REVERSIBLE cloths are illustrated in Figs 99 to 103. Fig 99 gives a reversible twill check with looming on 8 shafts. Fig. 101 gives an incomplete satin check, complete the design from the looming given. Finish the stripe designs Figs. 100, 102 and 103. Show the looming for Fig 102.

Examples to illustrate the "looming," or "drafting" and the "peg plan." Figs 104 to 109 have been given at various times in the City and Guilds of London Exam. papers. In Fig. 104 fill in the ground weave, plain cloth, also put down the "looming" and "peg plan". From Fig 105 make a pattern on space 106. Show the "loom" and "peg plan". Give the "looming" for Fig. 104. Fig. 108 can be woven on 12 healds, complete the pattern. On the space 109 make a pattern on the same lines as 108 excepted for 16 healds instead of 12 healds.

STRIPED SHIRTINGS. Figs 110 and 111 give examples of striped shirting designs, such patterns are most effective when woven with coloured warps, the twill weaves to be in one colour and the "dobby" or "figured" stripe in another colour. Give the loomings and peg plans for Figs 110 and 111.

FIGURING WITH EXTRA WARP. Fancy figured effects in coloured goods, for Blouses and dress materials are obtained by the introduction of extra warps, two beams are required; the ground weave is usually plain or some simple weave, the plain or ground ends alternate one and one with the extra warp ends Fig 112 gives an example of an extra warp spot effect on a plain ground, show the "looming" and peg plan. On space 103 make an extra warp spot effect and weave it. On space 114 give the design for the cloth;

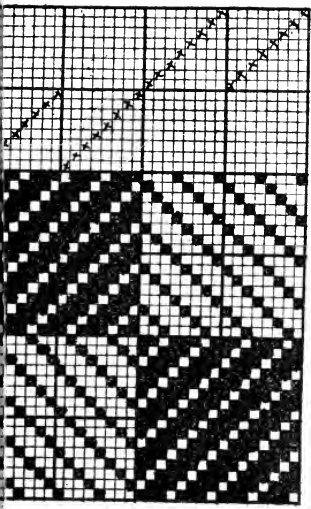

99

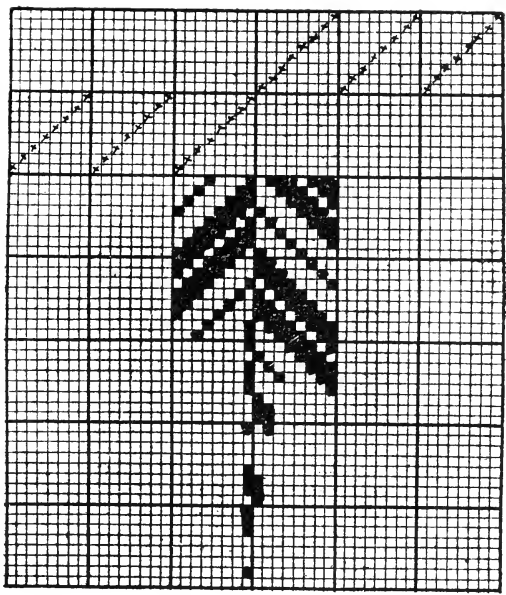

100

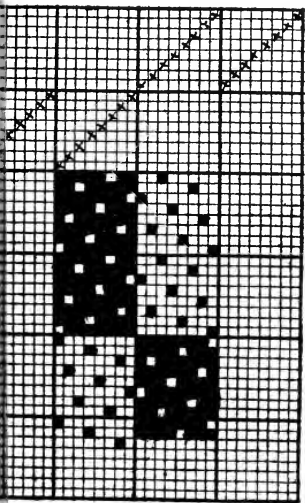

101

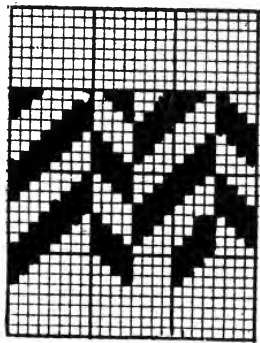

102

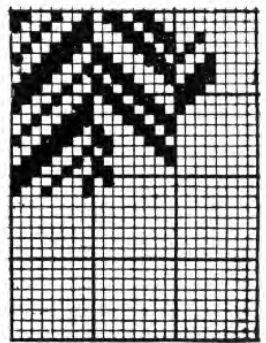

103

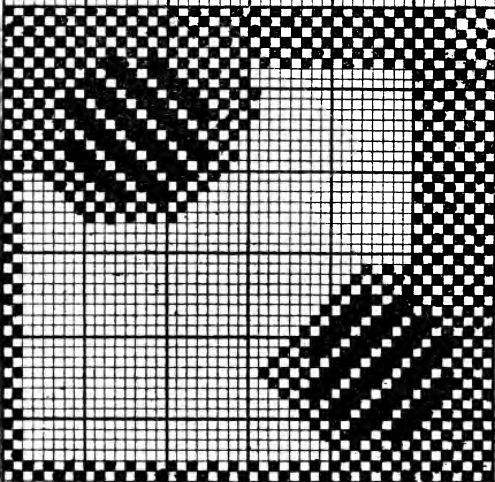
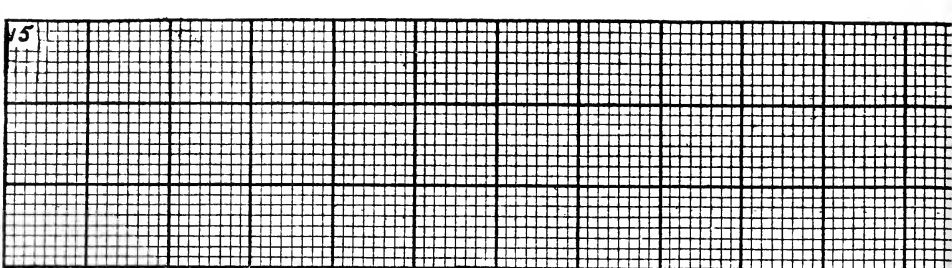

104

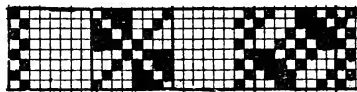

105

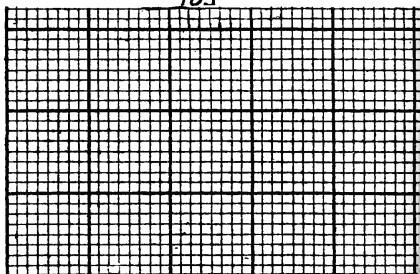

106

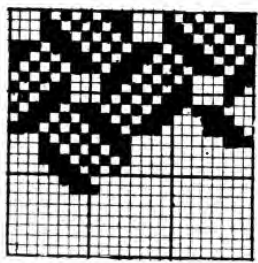

108

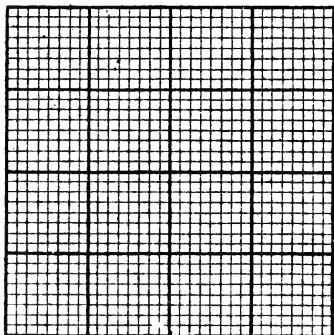

109

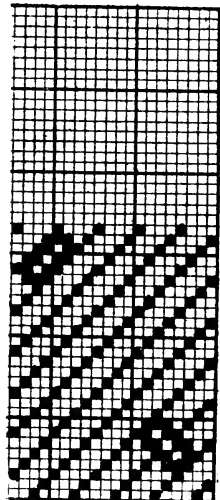

107

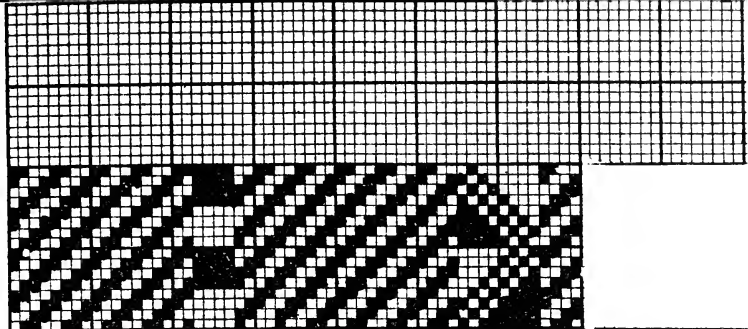

110

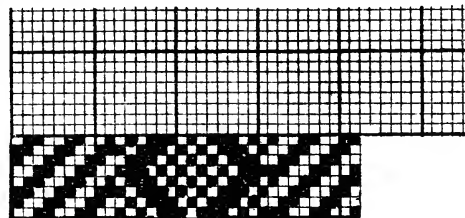

111

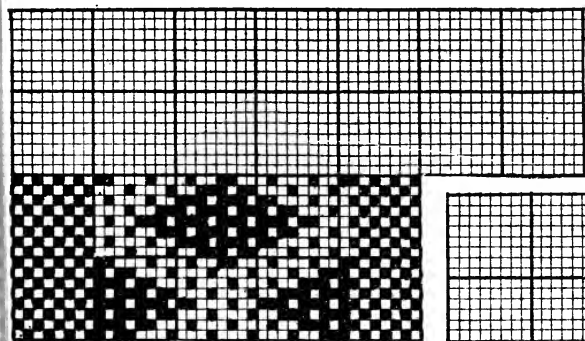

112

WOVEN
SAMPLE
OF
CLOTH

CLOTH
for
ANALYSIS

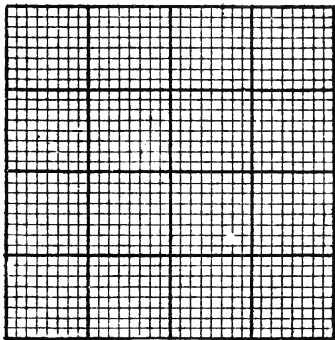

113

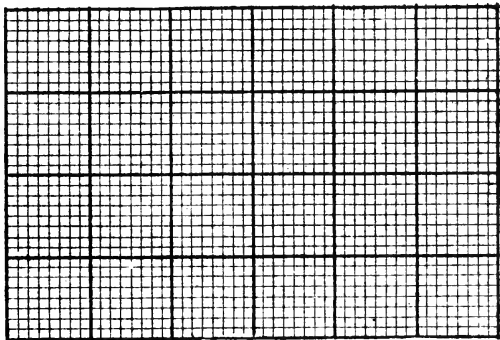

114

SATINS, HONEYCOMBS and cloths of similar character.

MOCK-LENOS. Examples for the better understanding of the LOOMING and PEG-PLAN.

SATINS can be made on any number of healds from four upwards: Four and six give imperfect satins. In selecting the binding points, or the lifting of the healds, all satins have a constant number of their own for a basis, depending upon the number of healds used, some of them have several numbers which can be taken for a basis. To find this number for any particular satin, let it be such a number that it will not divide equally into the number of healds used, let it also be such a number that it cannot be equally divided by any other number which will divide exactly into the number of healds used. This number is then taken for a basis, to find how the ends should lift in the satin under consideration. Taking for example a 5 end satin the number which can be taken for a basis is 2, therefore as shown in Fig. 115, on the 1st pick lift the 1st end; on the 2nd pick miss one square less than the number taken as a basis, and lift the 3rd end; on the 3rd pick miss one empty square and lift the 5th end; on the 4th pick the 2nd end is lifted; on the 5th pick the 3rd end is lifted in Fig. 116 the squares are shown filled in. In Figs 117, 118 the method of lifting is shown for a 8 end satin, basis 3. Figs 119 to 129 show a range of satin from 4 to 16 shafts. Fig 13 is a 10 end warp satin. In Figs 130 and 131 make satins and wear them. GRANITE WEAVES are made by adding filled in squares to the filled in squares of a satin weave Fig 133 to 136 Fig 138 give a honeycomb pattern, complete examples Fig. 139, 140 Figs 142 to 147 must be woven with coarse wefts. Put down the patterns from the loomings and peg plans in Figs 149 to 152. Give the peg plan for Fig 153.

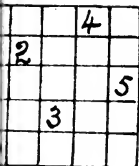

115

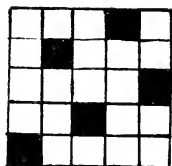

116

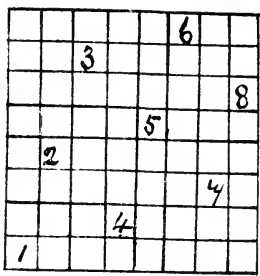

114

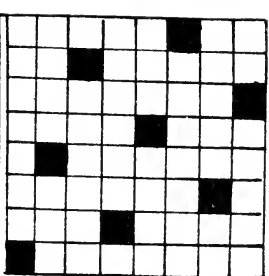

118



119



120



121



122



123

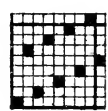

124

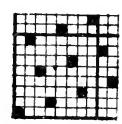

125

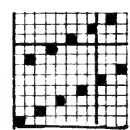

126

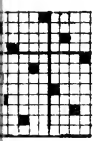

127

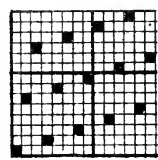

128

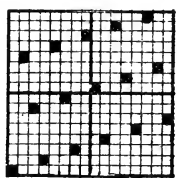

129

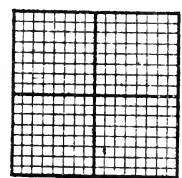

130

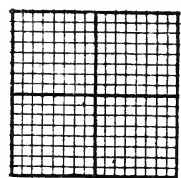

131



132

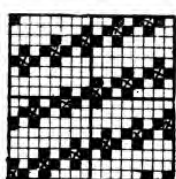

133

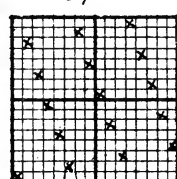

134

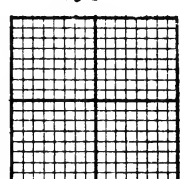

135

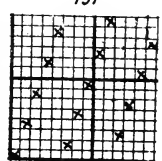

136

atin
 sample of
 look for
 analysis
 DESIGN on
 134

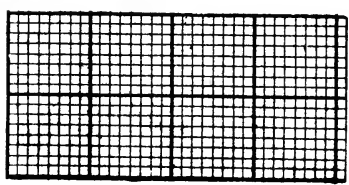

137

SATIN SAMPLE TO WEAVE DESIGN on 130-131	GRANITE SAMPLE TO WEAVE. Design on fig 125
--	--

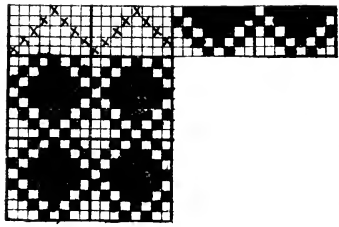

138

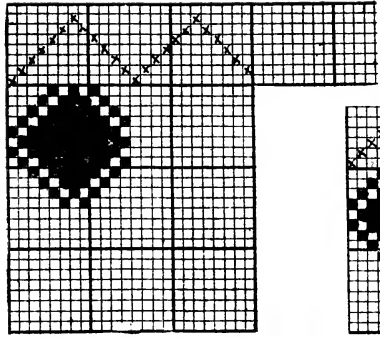

139

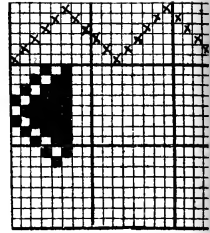

140

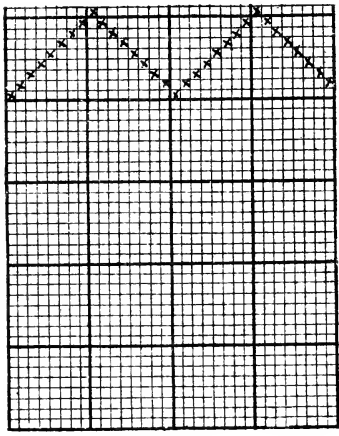

141

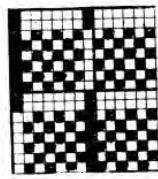

142

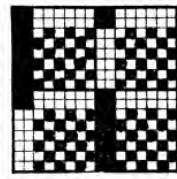

143

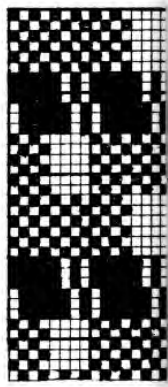

144

<p>HONEYCOMB CLOTH for ANALYSIS DESIGN ON 148</p>	<p>Honeycomb sample to weave DESIGN ON 141</p>
---	--

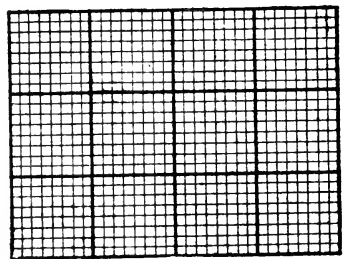

148

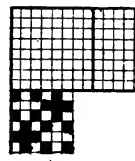

146

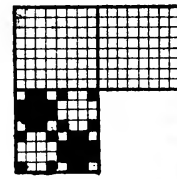

147

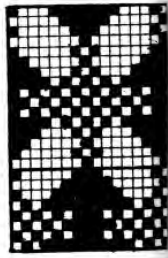

145

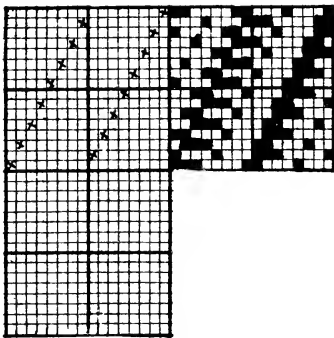

149

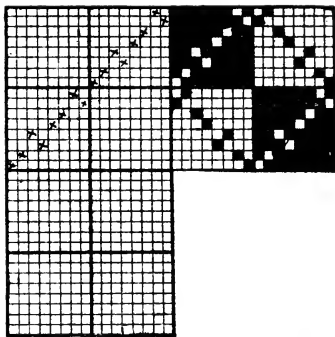

150

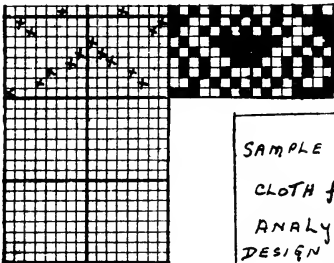

151

SAMPLE OF
CLOTH FOR
ANALYSIS
DESIGN ON
154

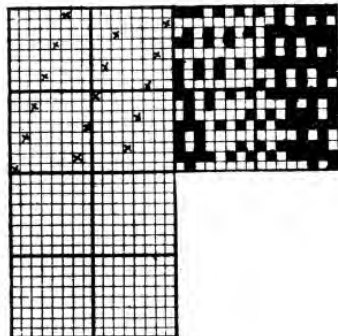

152

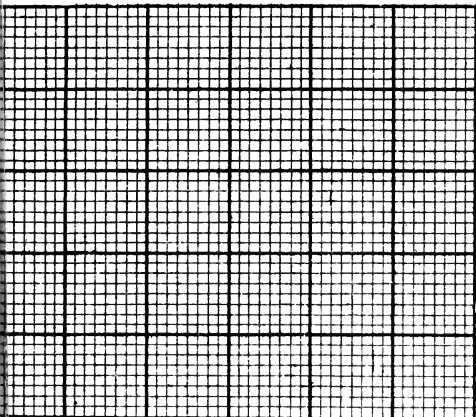

154

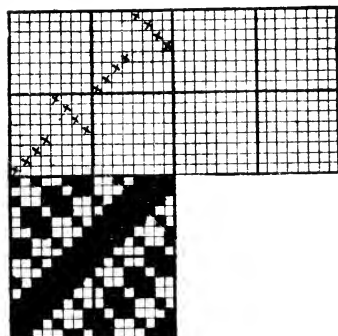

153

Honeycomb, Figs 155 to 158 are other examples of Honeycomb designs, full repeats of the pattern are shown in each case, Figs 156 to 158 require repeating to fill the space provided for them. On the space 159 make a design after the style of one of the four given, and weave it, or the space may be used for the analysis of a sample cloth.

Weft and Warp Corkscrew patterns.

Weft Corkscrews. The principle of construction of these cloths, is to employ a satin basis as indicated by the X^5 in Fig. 160, which is based on an eight end satin, one or more dots are afterwards added to the right or the left of the original satin mark, when one dot extra is only added as in this example, they are sometimes known as double satins. Fig. 161 is a 9-end satin basis, carried out to two repeats in ends and picks, with three extra dots added to the right of each satin mark. Fig. 162 is a 13-end satin, fill in, and complete, by adding to each satin mark 6 dots as shown. make a weft corkscrew design on the space 163.

Warp Corkscrews. There are several methods by which this type of cloth is made, Figs. 164, 165 and 166 have a satin basis as indicated by the X^5 and a number of squares are filled in above each satin lifting mark, on space 167 design and weave or analyze a pattern. Sometimes a tulle is taken as a basis as in Fig. 168, and the ends are rearranged, as shown in Fig. 169. The object aimed at being to bring a number of dots of one thread opposite to a number of blanks on the adjacent thread, From the tulle Fig. 170 make a Warp Corkscrew on space Fig. 171. Fig. 173 is made from 172, give the loomings for 173. Other times two plain ends are placed between each tulle end as in Fig. 175, which is made from 174. On the space 176 make a warp corkscrew and weave it, or use it for cloth analysis. Fine reeds and many picks per inch are required for effective patterns.

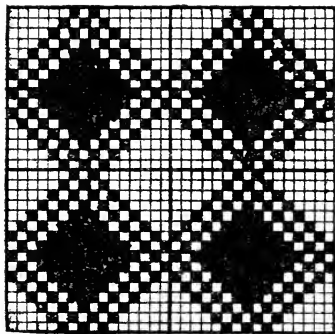

155

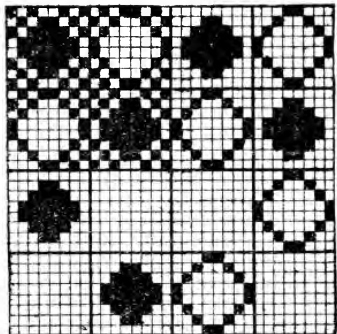

156

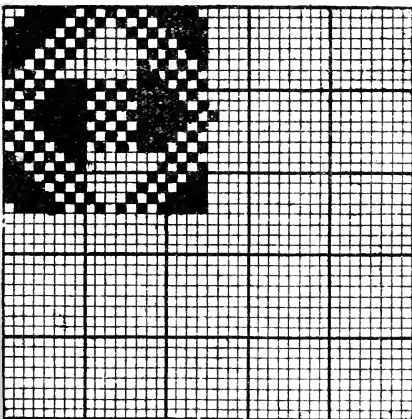

158

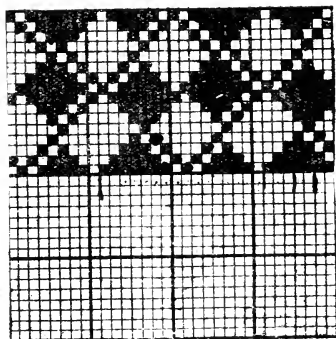

157

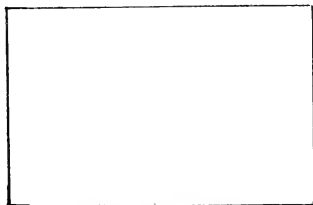

Honeycomb comb

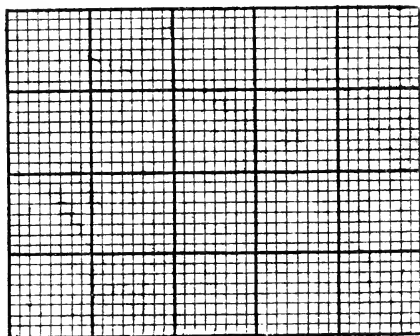

159

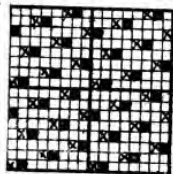

160

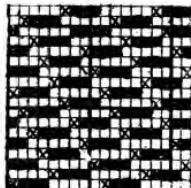

161

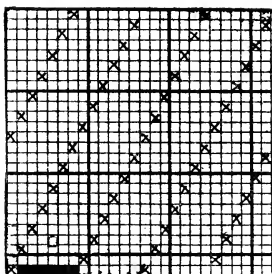

162

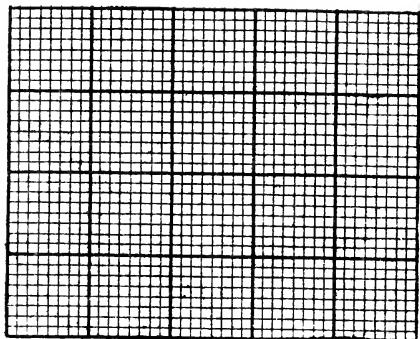

163

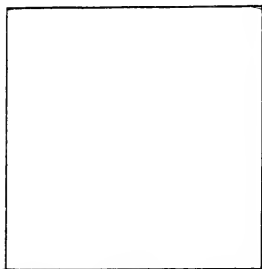
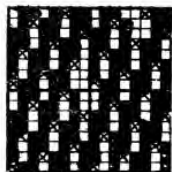
*Waft Corkscrew Clock*

164

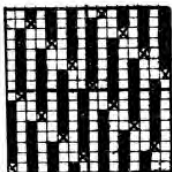

165

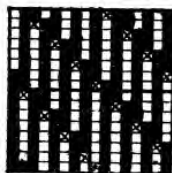

166

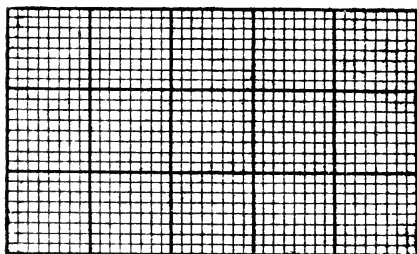

167

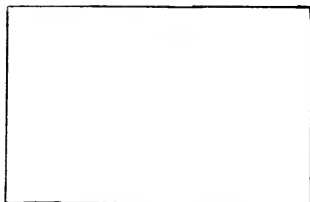
*Corkscrew Clock*



168

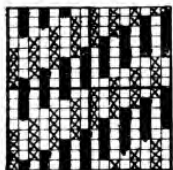

169



170

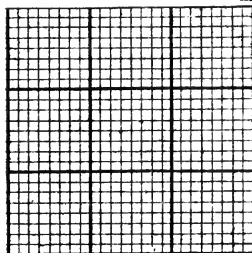

171

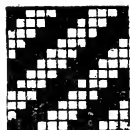

172

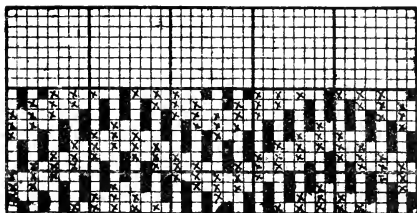

173



174

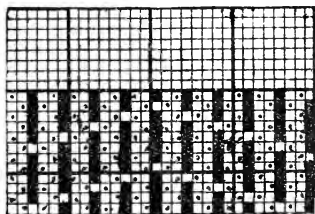

175

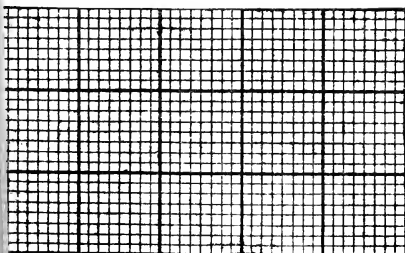

176

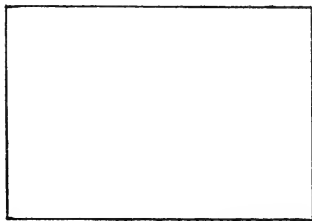

Warp Corkscrew Cloth

Fig. Zig-Zag Fancy Twills are made by taking a twill basis, and running the lines of twill in a given direction for a number of picks, and then reversing the direction for a number of picks, carrying the pattern out until it repeats in ends and picks.

Figs. 177 and 178 give examples which require 8 healds and repeat on 16 picks. Repeat 178 to 32 picks.

Take the filled in squares of 179 as a basis and make a zig-zag fancy twill. On 8 healds and 24 picks make a design from the basis 180.

Fig. 181 gives an example on 10 healds and 18 picks.

Make a design for 10 healds from the basis 182.

Make a design for 12 healds on the basis of 183. Space 184 may be used for cloth analysis on a woven sample of a fancy zig-zag twill.

Fig. 185 is for 16 healds and 32 picks, repeat the pattern to fill the whole of the space given.

Figs. 186 and 187 are zig-zag effects on 16 healds.

From the basis given in the two examples 188 and 189 make suitable designs for 16 healds and 32 picks.

190 and 191 give the basis for designs for 20 healds and 40 picks in each case, make suitable designs on these spaces.

If the looming is point on \wedge draft, the pattern becomes considerably enlarged, and a more varied and fancy effect is produced. In Fig. 192 the x^s indicate the looming, and the small dots the basis of the pattern. The upper part of the design is completed, repeat the pattern to fill the whole of the space. The pattern stands on 21 healds and 40 ends, and by repeating can be woven on a 200 or 400 Jacquard.

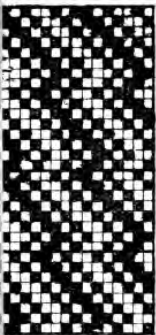

177

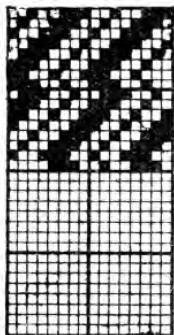

178

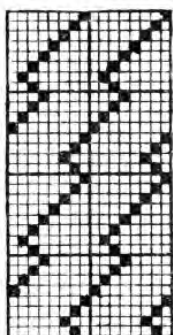

179

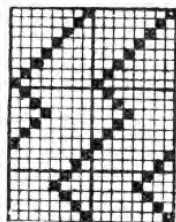

180

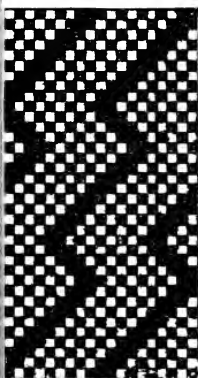

181

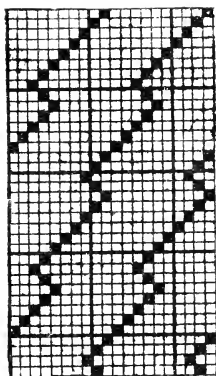

182

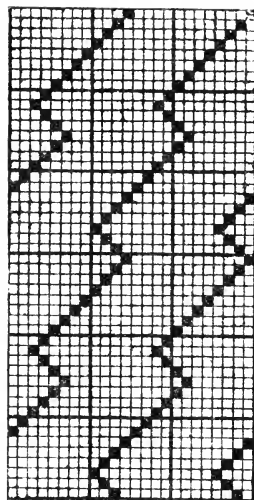

183

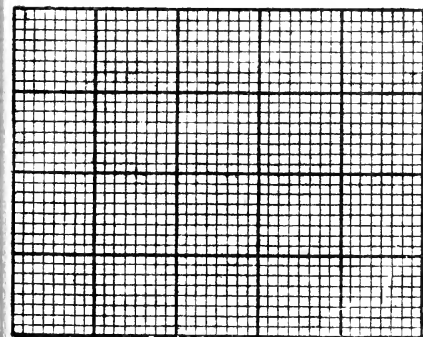

184



Both
Fancy Bag

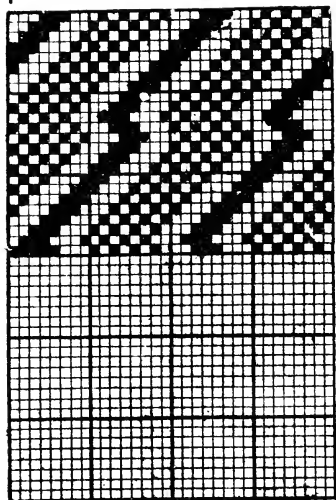

185

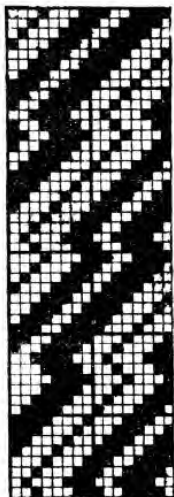

186

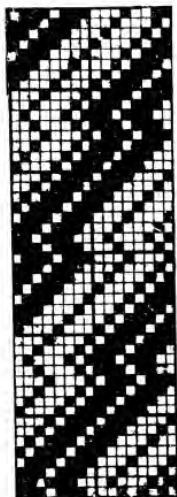

187

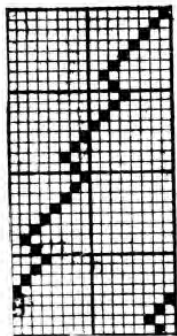

188

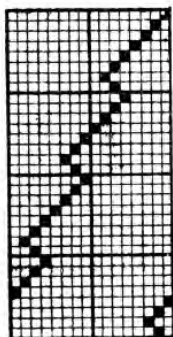

189

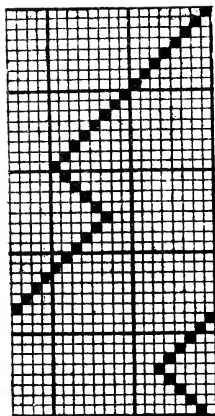

190

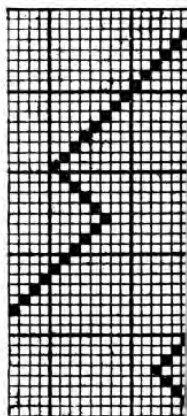

191

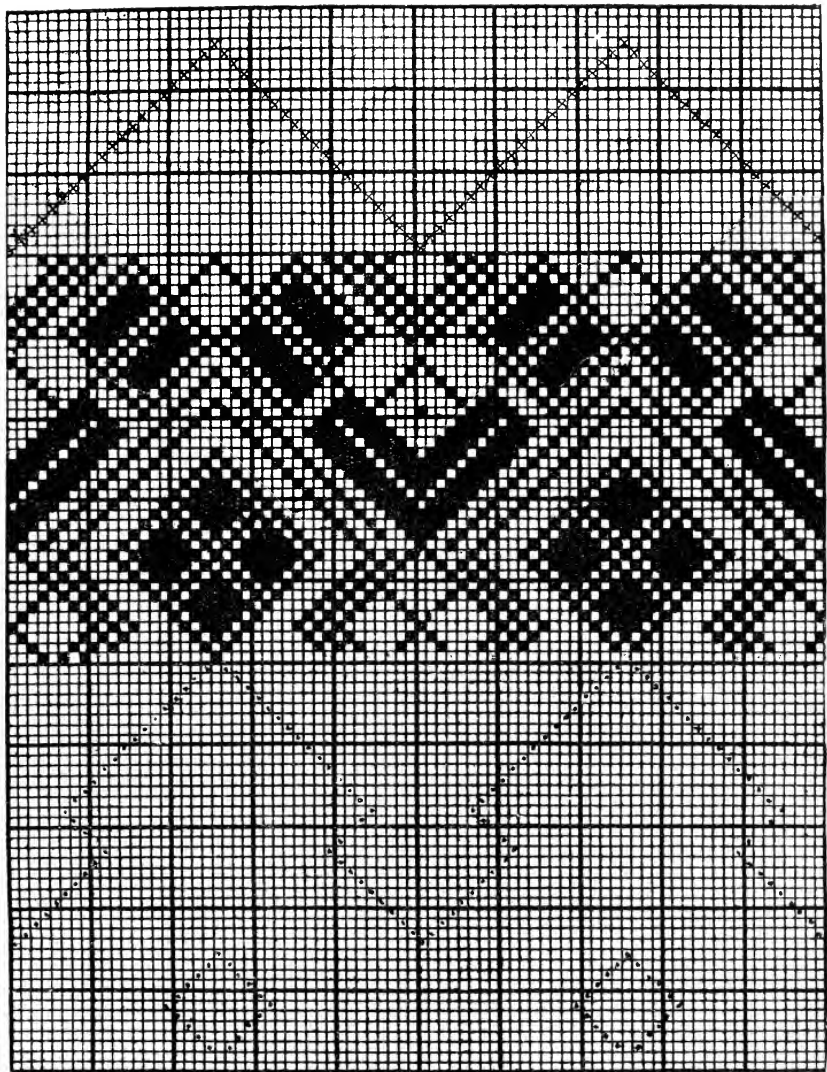

DESIGNING.

The dots in Figs 193 and 194 give the basis for making two separate designs on 16 heads, point draft looming, as indicated by the x^s in 193. Fig 193 repeats on 24 picks, and Fig. 194 on 32 picks. Build up suitable designs in each case, after the style of Fig. 192.

Regular Diagonals, are made by taking a skip twill basis as indicated by the x^s in Fig. 195. Afterwards add to the x^s in an upward or downward direction, a number of filled in squares. Figs 195 and 196 are examples made on 8 heads and repeating on 16 picks. On the spaces 197 and 198 make diagonal designs for 8 heads.

Figs 199 and 200 are examples of diagonals on 16 ends and 32 picks. On the spaces 201 and 202 make designs for 16 heads regular diagonals.

Spaces 203 ^{or 204} are for original regular, and fancy diagonal designs, to be woven, or for cloth analysis. Fancy Diagonals, when the filled in squares are not added to the x^s in regular order, fancy effects are obtained. Figs. 205 to 212 show the method of making fancy diagonals for 8 heads, Fig. 205 shows the first stage and 206 the completed design. Or as in Fig. 207 the diagonal line is made first, and the figures afterwards filled in as shown in the completed design 208. Or the figures made first as in 209, then make the addition as shown in fig 210, and afterwards complete, as shown in 211.

On the space 212 make a fancy diagonal on 8 heads. Figs 213 and 214 give examples of fancy diagonals on 16 heads.

On the spaces 215 and 216 make fancy diagonals for 16 heads.

Always particularly note that the designs repeat in ends and picks.

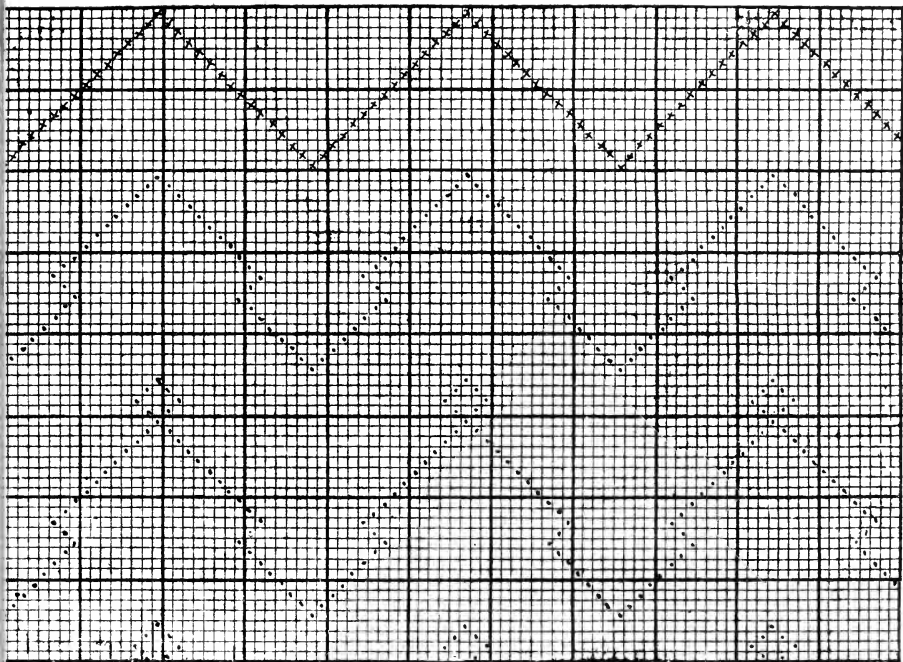

193

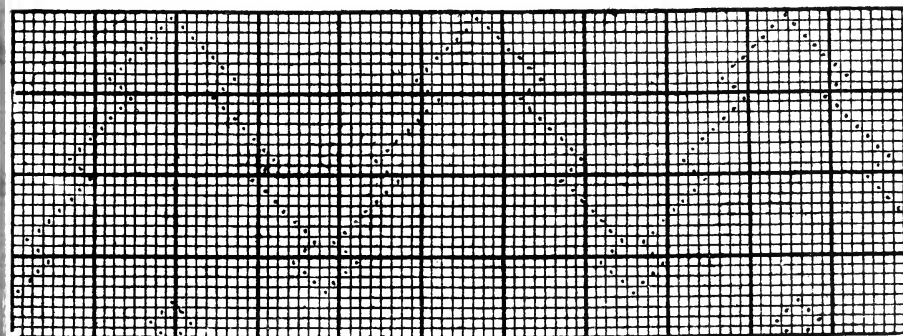

194

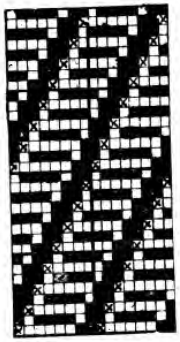

195

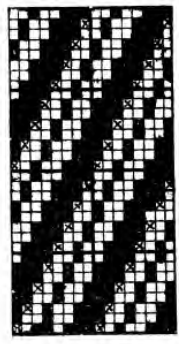

196

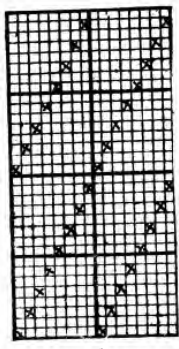

197

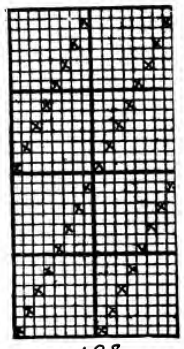

198

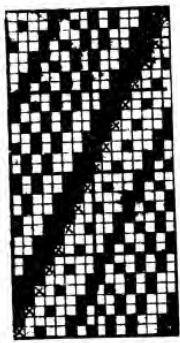

199

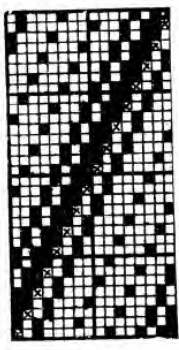

200

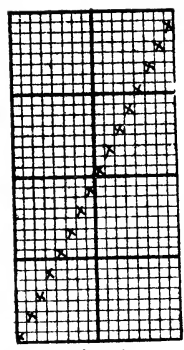

201

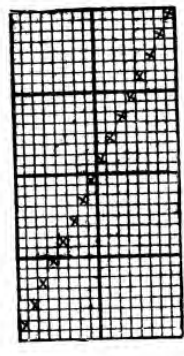

202

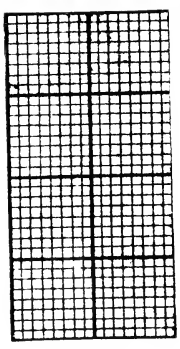

203

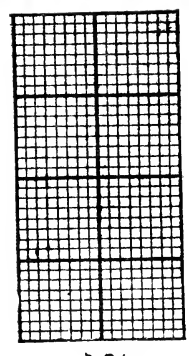

204

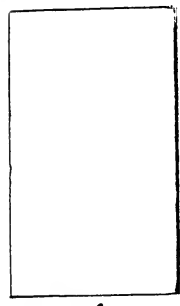

cloth
Regular
Diagonal

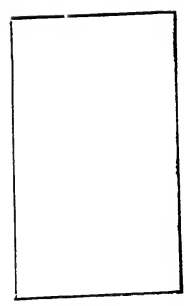

cloth
Fancy
Diagonal

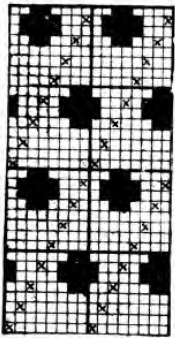

205

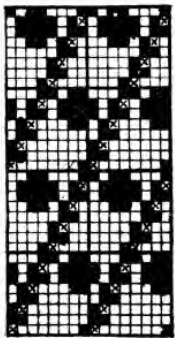

206

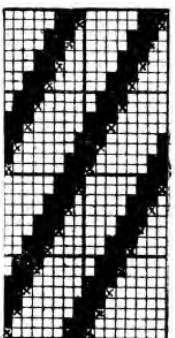

207

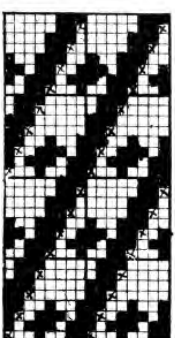

208

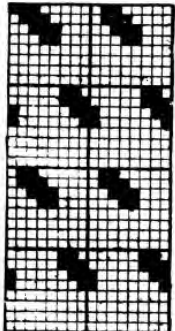

209

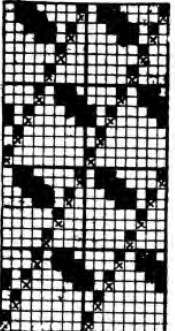

210

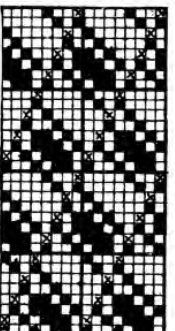

211

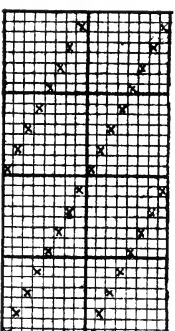

212

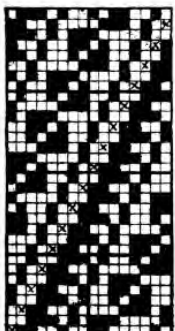

213

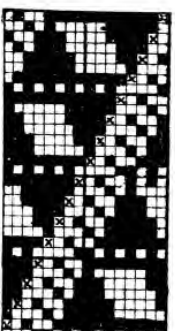

214

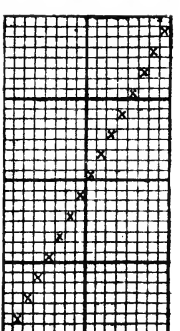

215

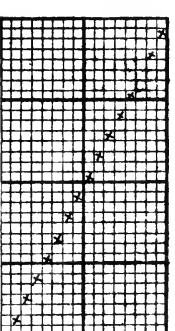

216

Re-arrangement of Twills. A variety of designs are made by rearranging the ends in a twill pattern.

Figs 214 to 240 are intended to illustrate examples made by the re-arranging the ends of a twill in satin order. Fig. 214 is an 8 end twill, the looming is indicated by \times^5 ; 218 shows the same pattern as 214 with the ends arranged in satin order as indicated by the looming. In like manner 220 is made from 219. 222 is made from 221. 224 is made from 223. On 226 re-arrange 225 in accordance with the looming of 226. Make a twill on 227 and re-arrange in satin order on 228. On 229 make a twill and re-arrange in satin order on 230. Make a twill on 231 and re-arrange on 232. 234 is made from 233. 236 is made from 235. On 238 re-arrange 237. On 240 re-arrange 239.

241 to 259 illustrate examples made by re-arranging the ends in skip order. 241 gives an 8 end twill and 242 gives the same pattern, with the ends re-arranged as shown by the looming in 242. On 244 re-arrange 243. On 245 make an 8 end twill and re-arrange in skip order on 246. On 247 make an 8 end twill and re-arrange in skip order on 248. 250 gives a re-arrangement of 249. On 252 re-arrange 251. 254 gives a re-arrangement of 253. On 256 re-arrange 255. On 258 re-arrange 257. Make a 16 end twill on 259, rearrange it on 260 and weave it.

Patterns can be made on a large scale with a limited number of heads by Combining Two Twills end and end. 261 gives a 7 end twill, 262 gives a 6 end twill. 263 gives the two twills arranged end and end, the resulting pattern repeating on 84 ends and 42 picks. On 266 combine the two twills 264 and 265 end and end, after the style of 263.

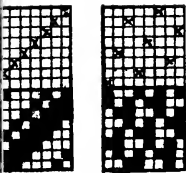

217



218

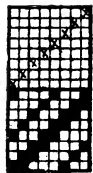

219

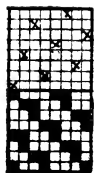

220



221



222



223

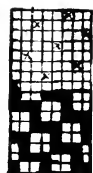

224

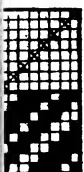

225

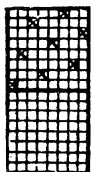

226

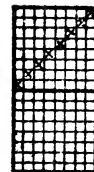

227

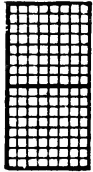

228

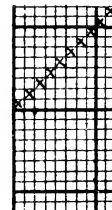

229

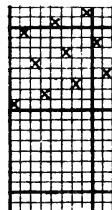

230

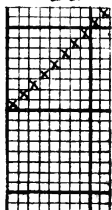

231

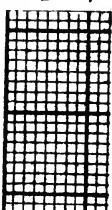

232

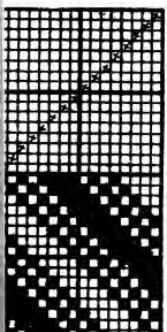

233

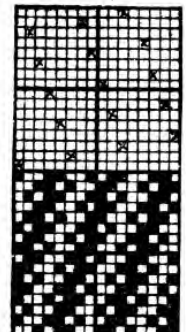

234

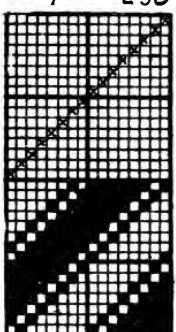

235

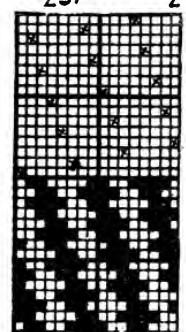

236

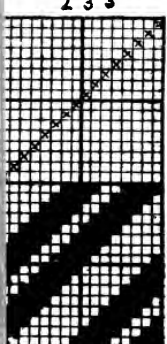

237

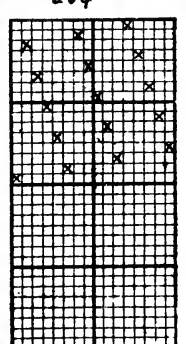

238

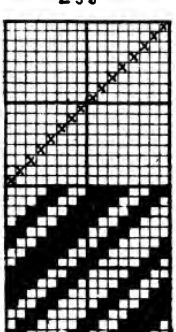

239

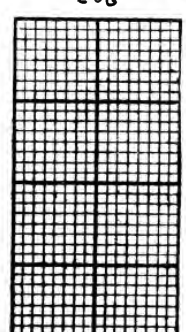

240

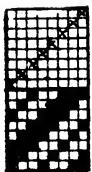

241

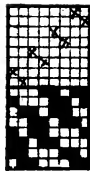

242

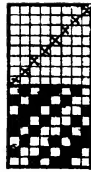

243

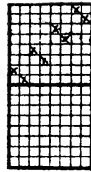

244

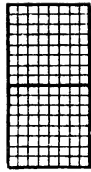

245

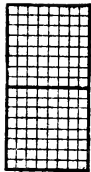

246

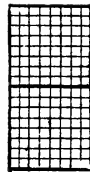

247

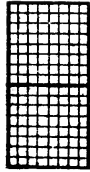

248

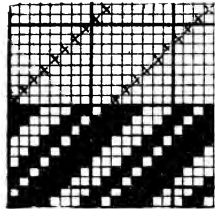

249

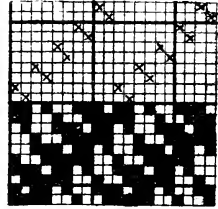

250

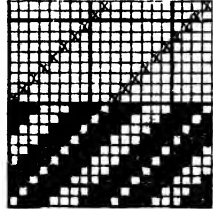

251

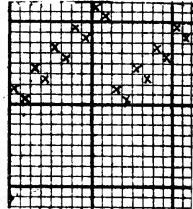

252

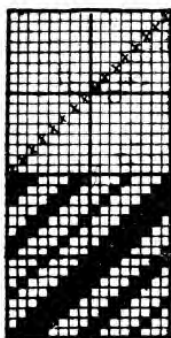

253

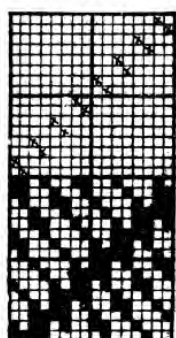

254

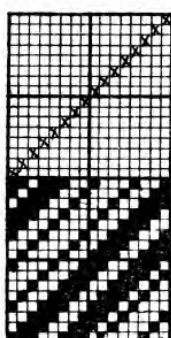

255

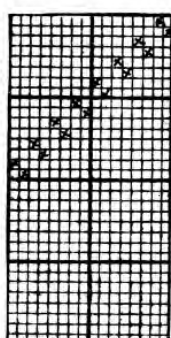

256

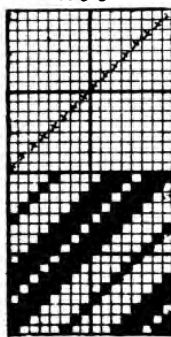

257

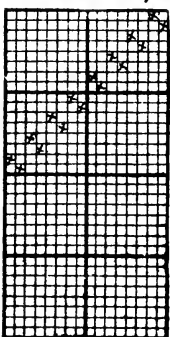

258

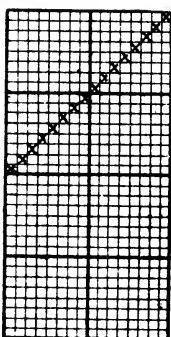

259

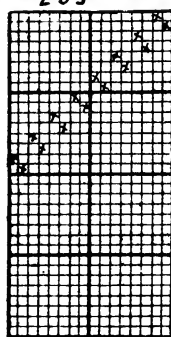

260



Blank

261



262

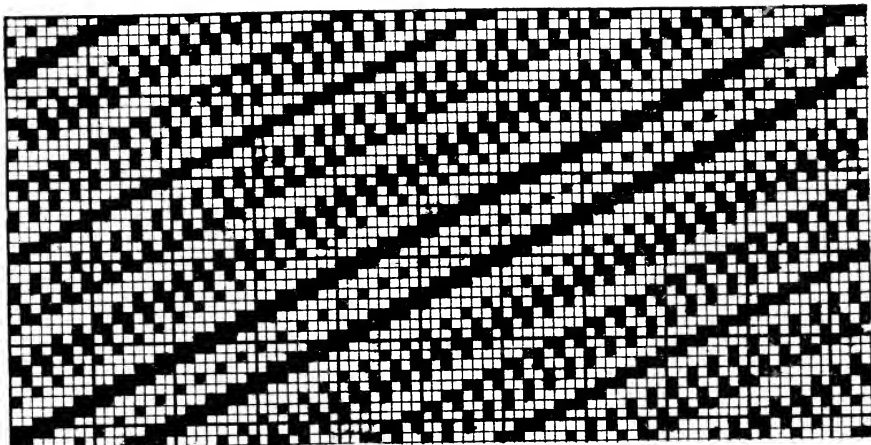

263

264



265

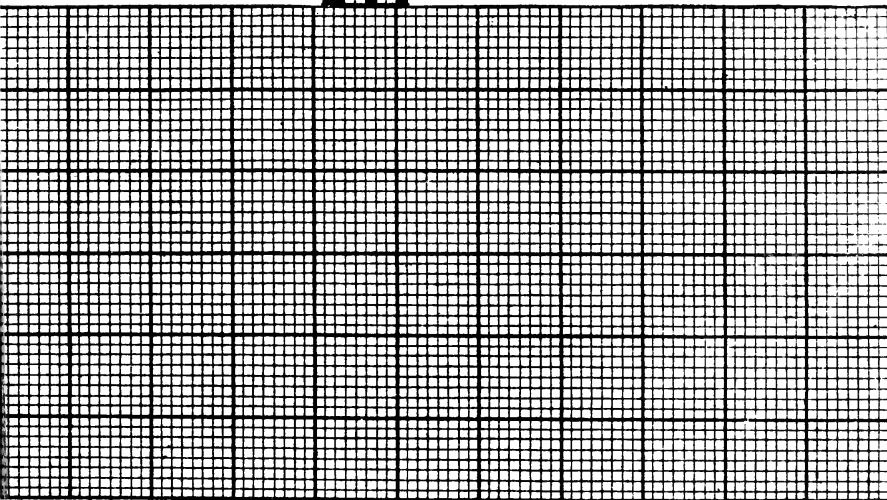

266

Many large patterns may be made by combination weaves, and special loomings, and from time to time patents have been taken out, for combination of weave, or loomings. In 1889 N. Reiser took out a patent for combining two twills. end and end as illustrated in Fig. 263 page 36. In 1899 F. Helliwell a pupil under my tuition took out a patent for the looming illustrated in Fig. 264, this looming increases the pattern producing power of a set of healds enormously, and the effects are generally pleasing, and if sufficient care is exercised in making the peg plan, long west floats are prevented, and a firm well balanced cloth is the result; in 264 there is a fair amount of plain weave, and this prevents long floats of west.

267 gives the peg plan for 264.

On 268 make a peg plan, and on 269 work out the resultant design from the looming given.

240 gives the peg plan for 241.

On 242 make a peg-plan and on 243 give the resultant design

Stripe effects are very much used in Textile designs, for cloths intended for Blouses, Dresses, Shirtings, Skirtings and many other purposes. 244 is a simple stripe design woven on 16 healds, the effect is produced by contrast in warp and weft, coloured weft makes the pattern most effective. 245 is a stripe of 4 end satin and a 12 heald dobby stripe. 246 is a figured and plain stripe alternating. 247 is a Harvard shirting on 14 healds. 248 is a shirting on 12 healds. 249 is plain alternating with a figured stripe. On the space 281 make a design after the style of 280 and weave.

267

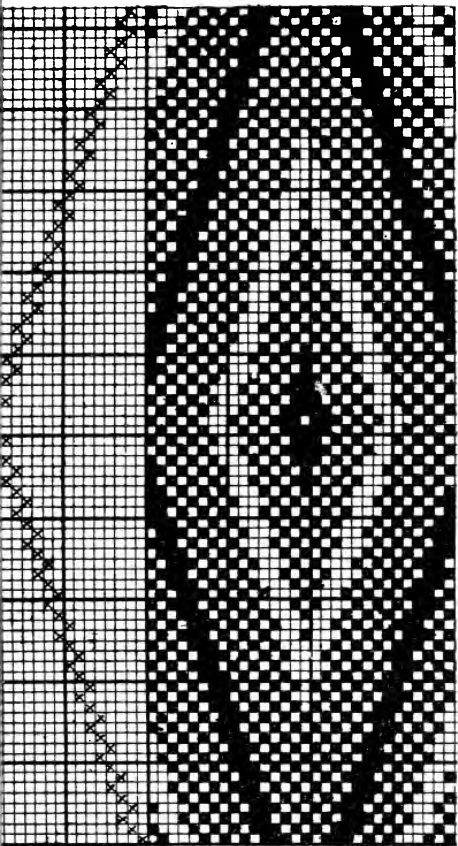

269

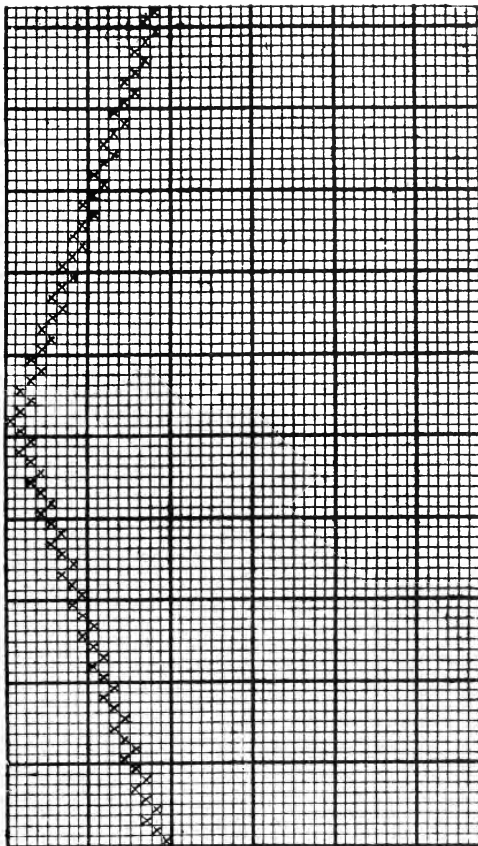

38

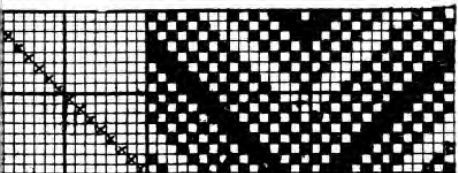

267a

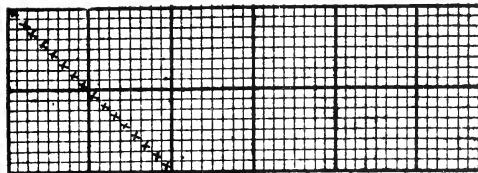

268

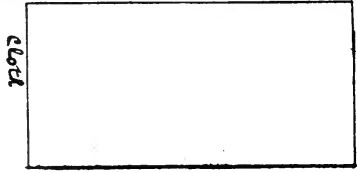
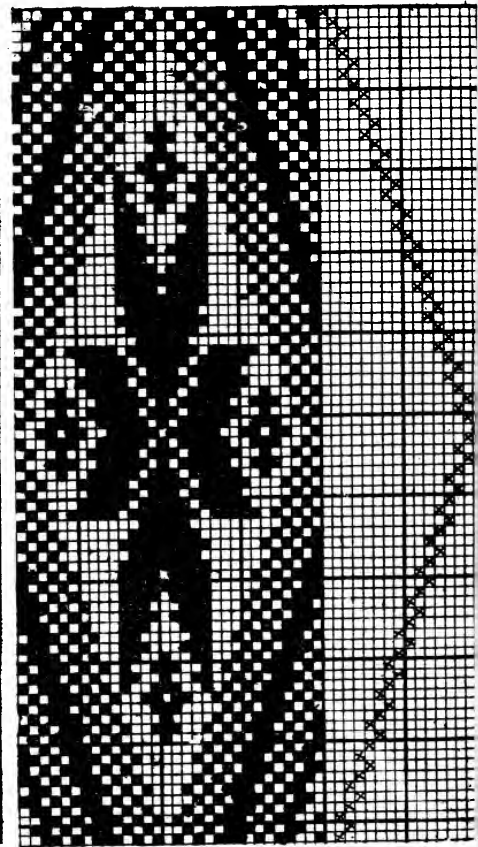
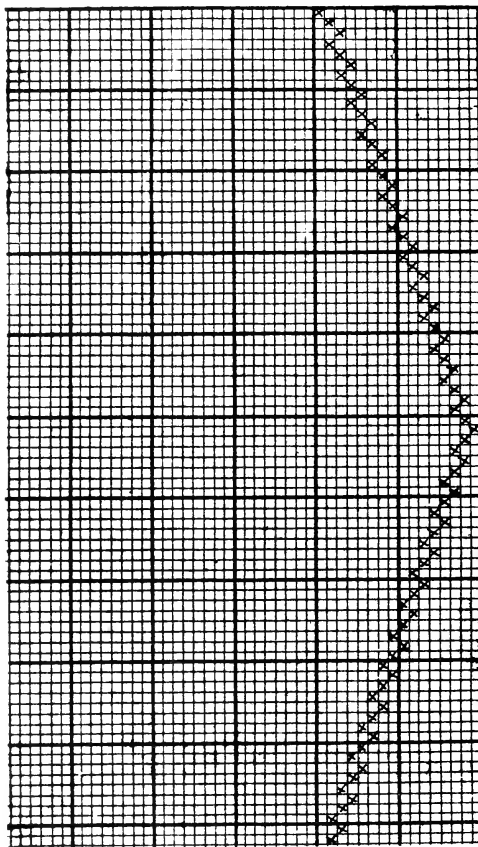
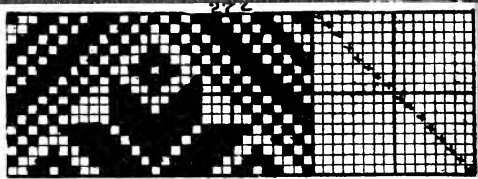
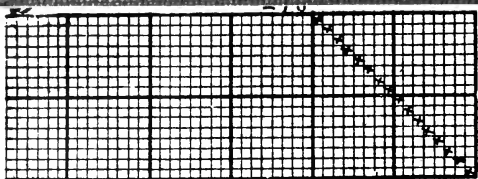

cloud

273

271

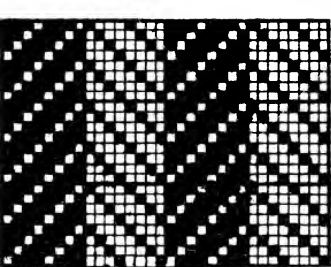

274

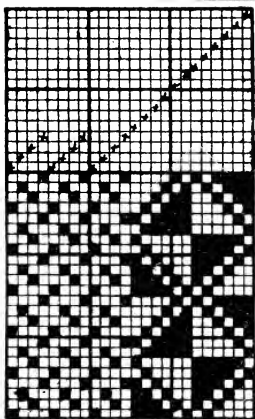

275

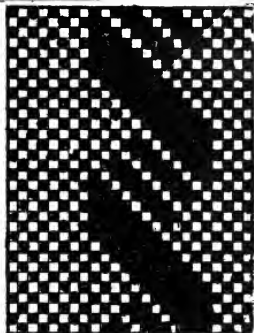

276

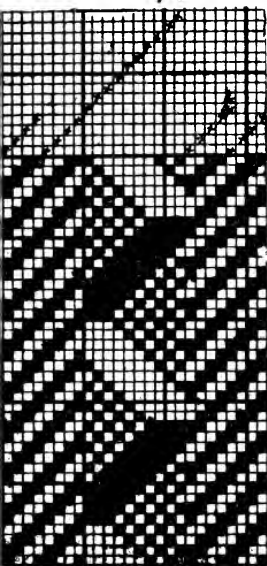

277

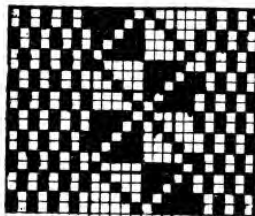

278

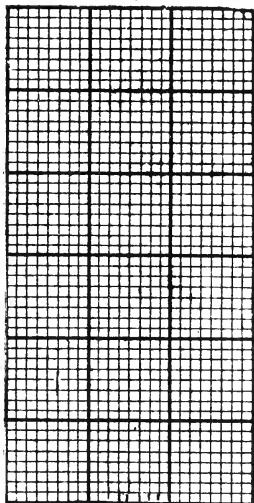

281

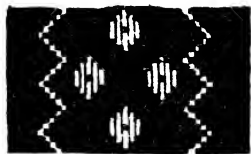

280

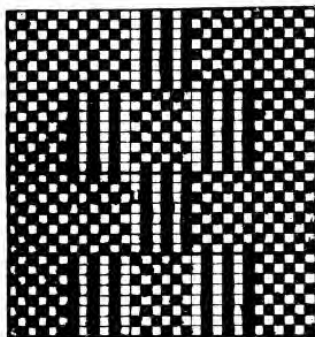

279

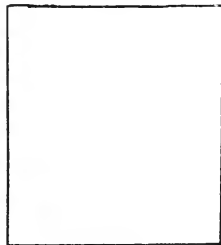

281

clock

Stripes. 282 gives a design for a twill stripe on 4 heads, and a figured stripe on 8 heads point draft looming, showing alternate figures in warp and weft; this interchanging of the warp and weft in making figures is very useful, and effective patterns are generally obtained. Fig. 283 consists of a twill stripe and a figured stripe on 8 heads repeating to 16 ends, complete the pattern. 284 is a 2 and 2 twill and a diagonal stripe on 8 heads repeating to 16 ends, complete the pattern. On 285 make a stripe pattern and weave it.

On 286 give the peg plan only for the cloth supplied.

Diamonds. The patterns in the cloth produce an all-over effect, the designs being geometrical in character. By using 16 heads with the ends drawn in point draft, an extensive range of designs can be made. Fig. 287 gives an example, the basis of the pattern is given in 289. 288 is suggested from the same basis, from the outline 289 build up a pattern after the style of 287 and 288.

Complete the pattern 290. 291 is suggested from 290. Make a pattern on 292 after the style of 290 and 291. On 293 make a pattern from the basis given, and repeat it to fill the space provided. On 294 make a diamond pattern after the style of 294 and weave it. On 295 give the lifting plan for the cloth supplied.

Complete 296 by filling the whole of the space provided. 297 is suggested from the basis of 296, build up a pattern on 298 after the style of 296 and 297. Complete 299, 300 and 301 are suggested from the same basis as 299. 302 is suitable for 21 heads point draft, it repeats on 40 ends and picks, it can be woven on 200 or 400 Jacquard. Carry the pattern out to fill the whole space provided.

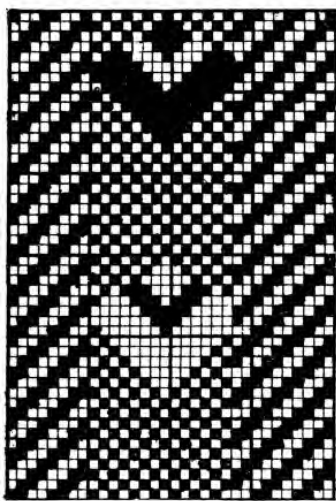

282

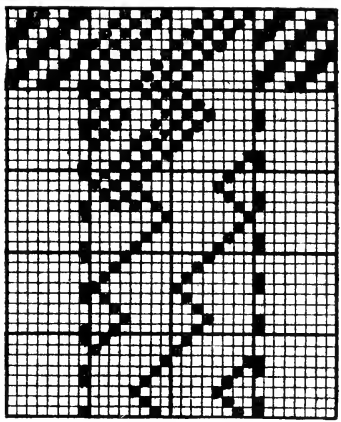

283

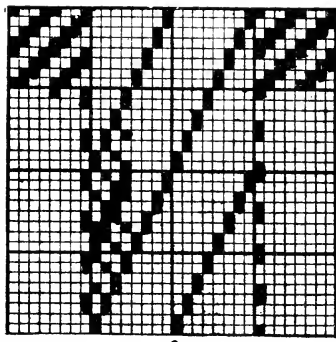

284

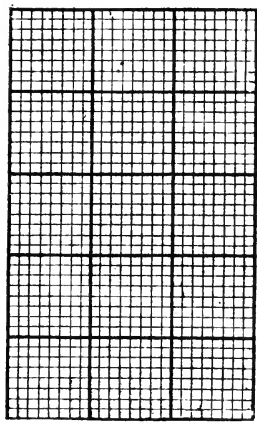

285

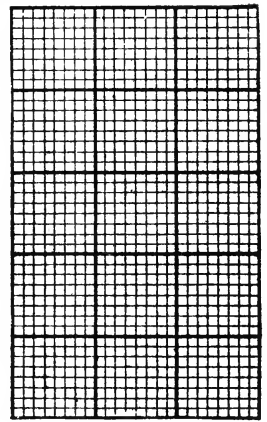

286

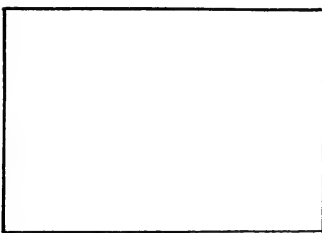

cloth

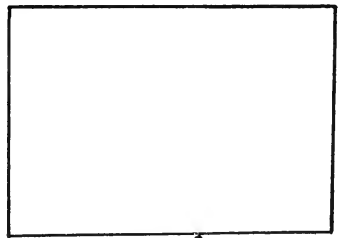

cloth

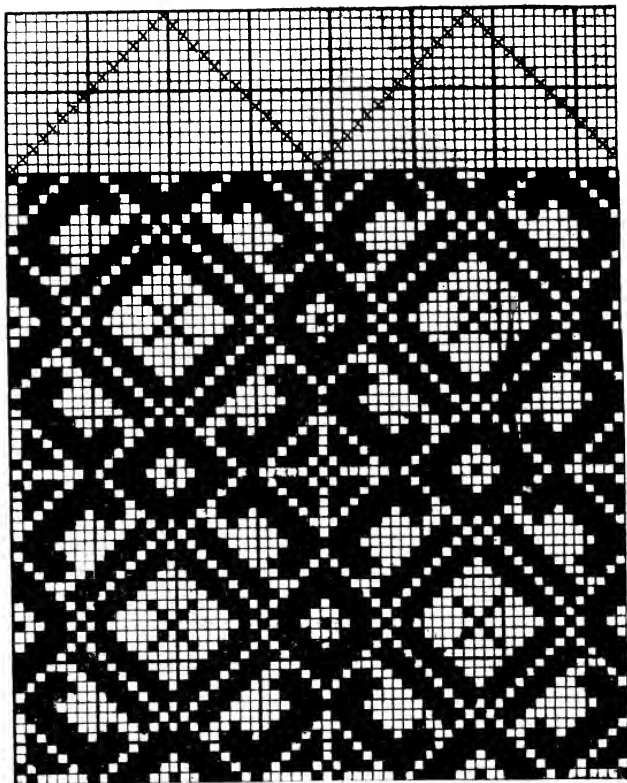

287

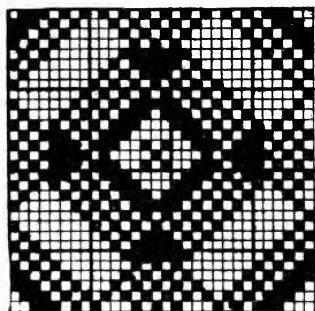

288

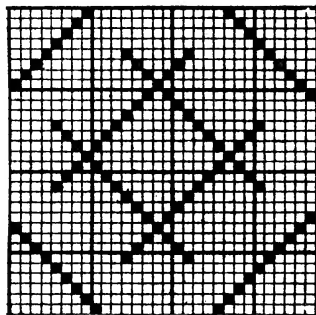

289

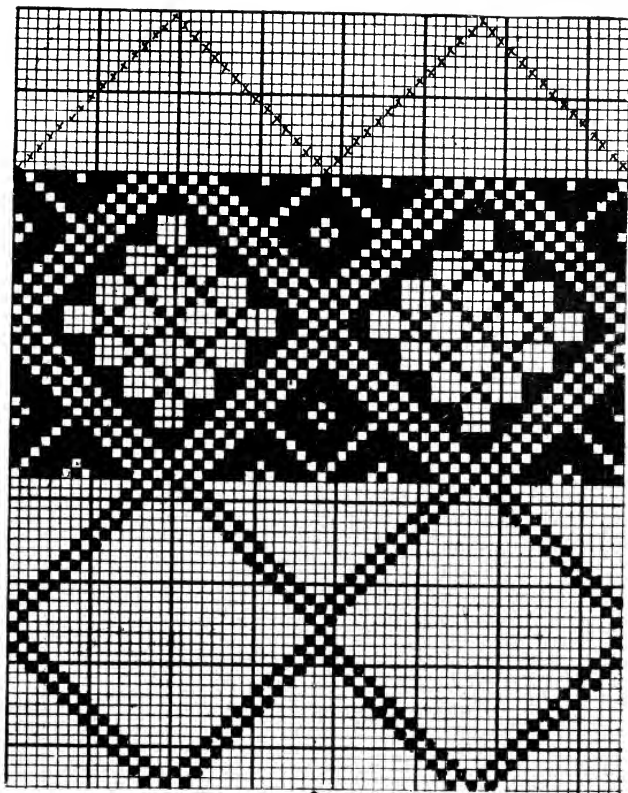

290

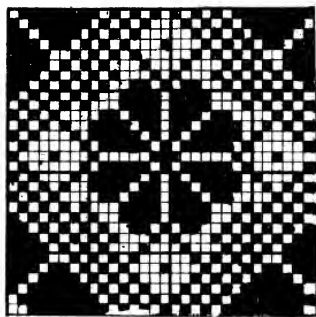

291

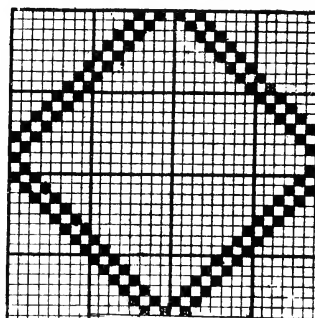

292

45

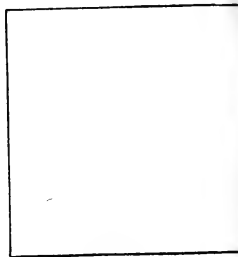
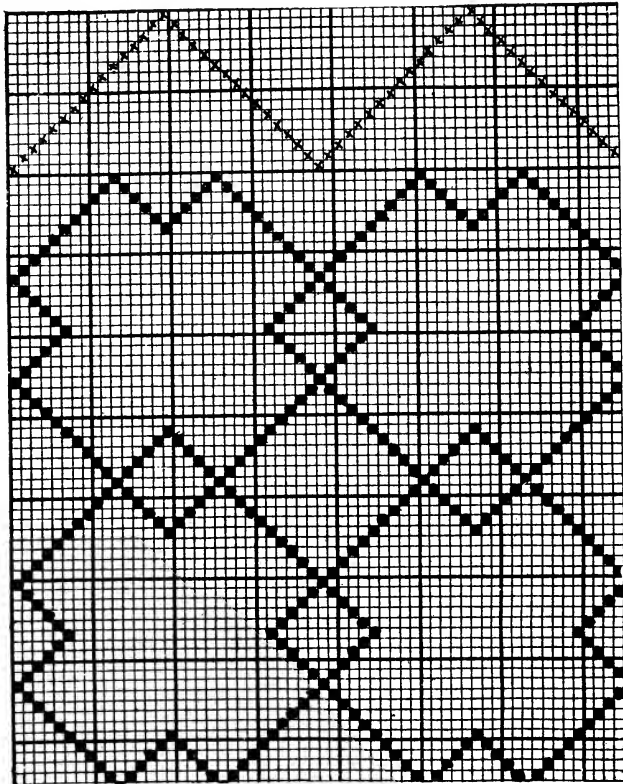

Cloth

293

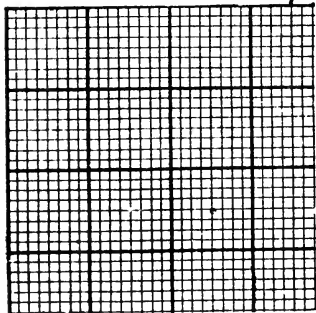

294

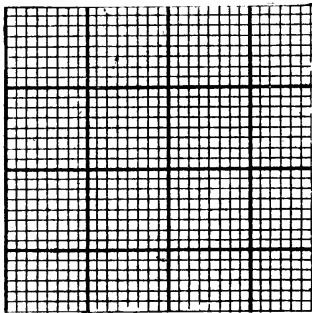

295

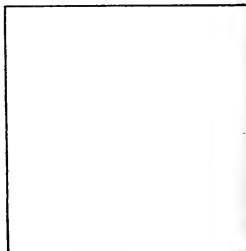

Cloth

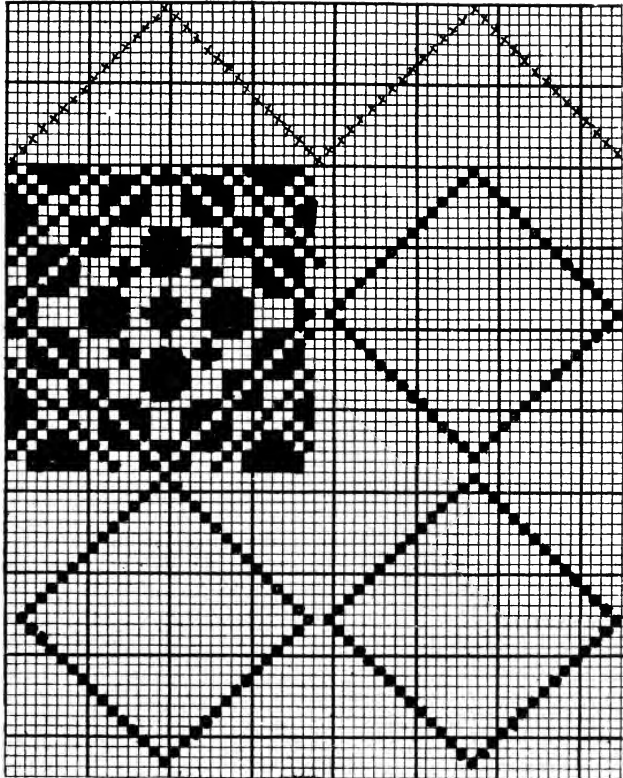

296

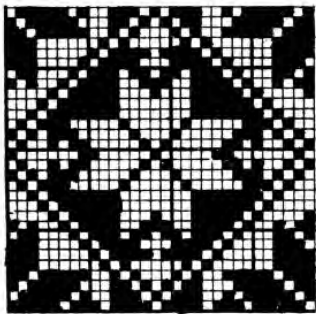

297

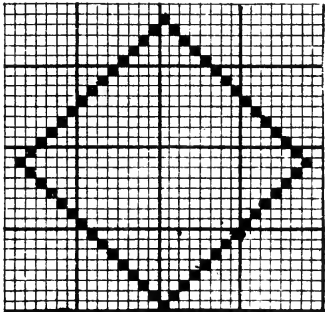

298

47

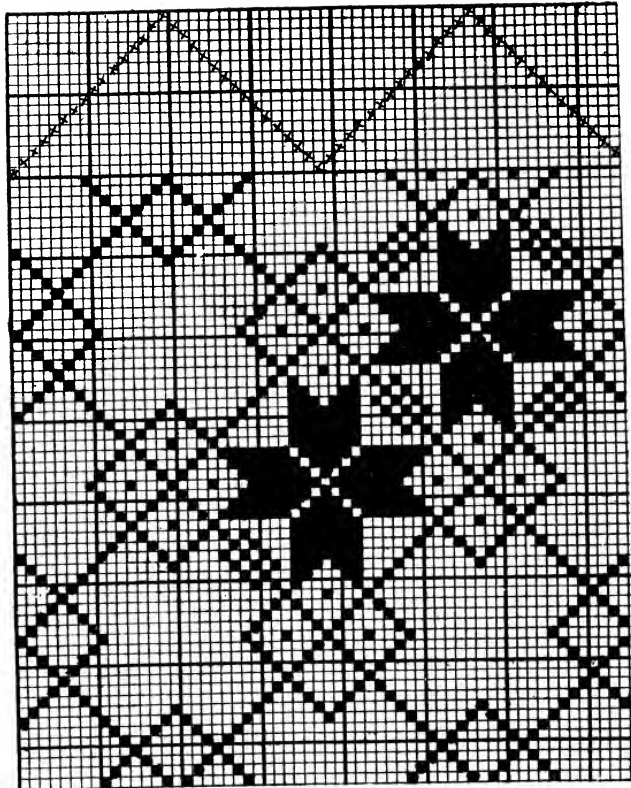

299

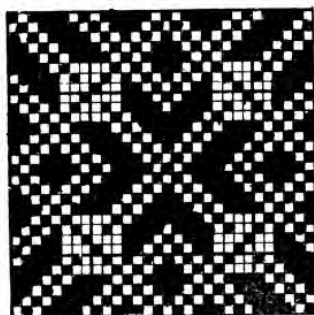

300

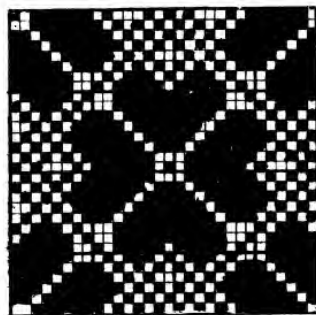

301

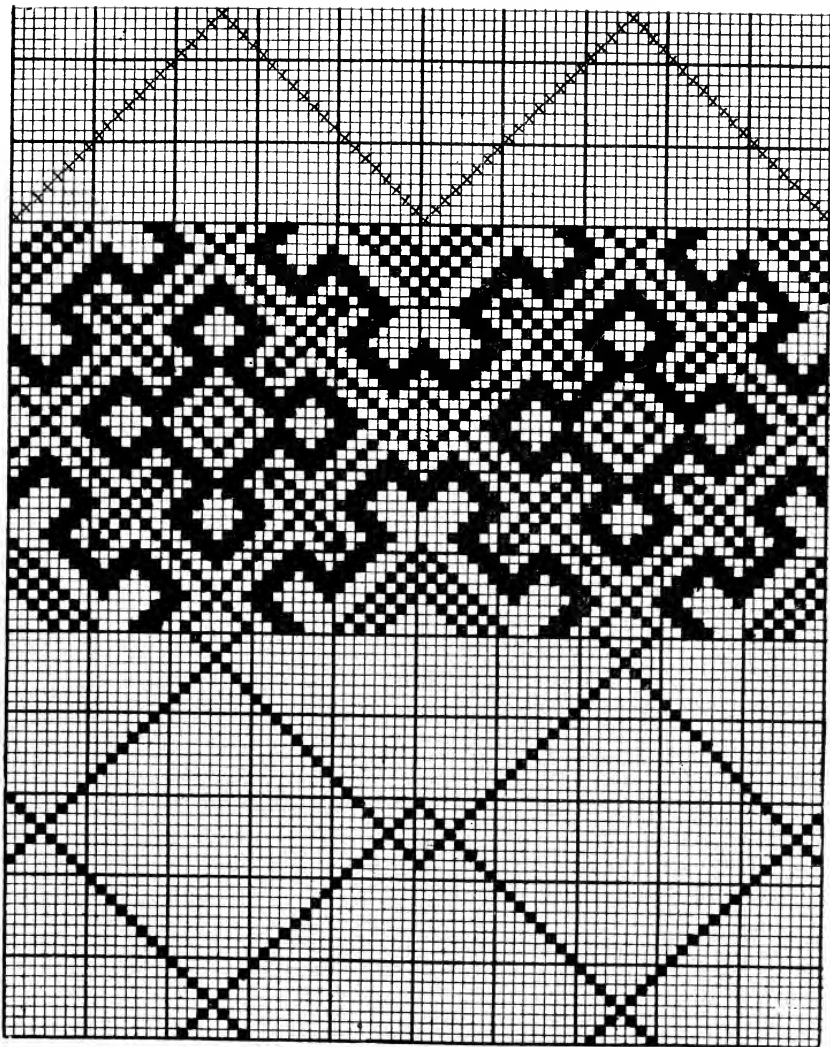

DESIGNING

49

Checks. Check effects are made by using one colour of warp and one colour of weft, and allowing a preponderance of warp to show on one check and a preponderance of weft to show on the adjacent check. Fig. 303 gives an example where a 3 and 1 warp twill shows on one check and a 3 and 1 weft twill on the adjacent check.

304 gives a warp and weft satin check. 305 gives a plain weave and warp and weft checks alternately.

306 a plain weave and counterchange figured check.

307 a solid warp and weft check. 308 is made in allowing 4 ends to weave in warp satin, then 12 ends plain, also 4 picks to weave in weft satin, complete the pattern; 310 is made after the same style; Complete 311 and 316 after the style of 308. 309 produces a curious and interesting effect, the floating ends and picks are pulled out of the straight line.

Complete 312 and 314. 313, 314 and 315 offer suggestions for checks. Use 318 for cloth analysis or woven sample

319 gives an example of a Swiss Check the 8 ends weaving satin are crammed in, 4 in a dent, the other part of the cloth being 2 in a dent, the 8 picks satin are crammed by stopping the take-up motion for one or two picks, by connecting the catch with one of the jacks of the Bobby and pegging for it, complete this design. Finish 320 which is a check on 40 ends and 40 picks

Hopsacks, Mats, or Basket weaves, these are very simple weaves much after the style of checks and illustrated in the examples 321 to 326, finish 326.

Towels these require a spongy warp and weft of rather coarse counts. 328 is the well known Muckaback design, the mat effect at the side is for the border at each side, and usually coloured warp, Give looming and peg plan. Finish 329, 330.

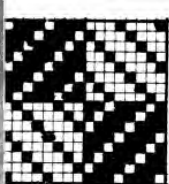

303

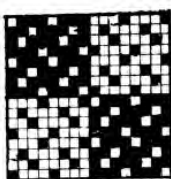

304

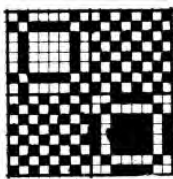

305

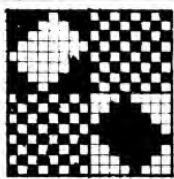

306



307

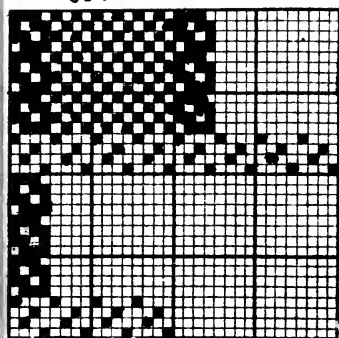

308

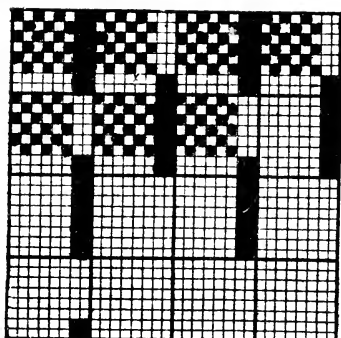

309

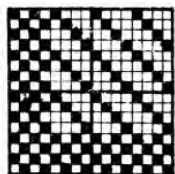

310

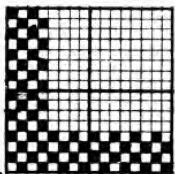

311

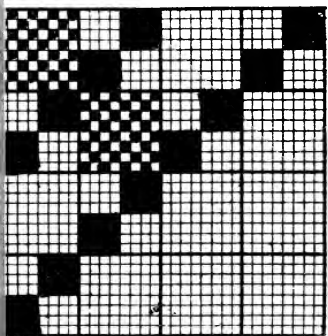

312



313



314

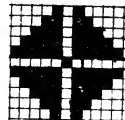

315

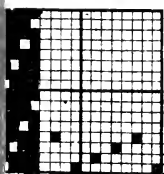

316

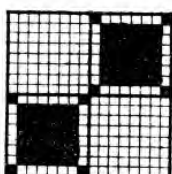

317

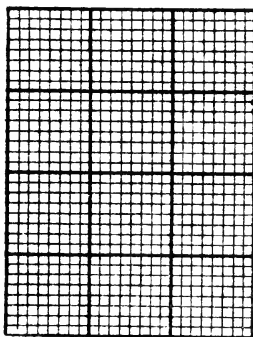

318

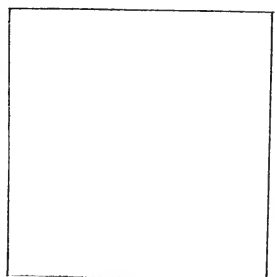

cloth

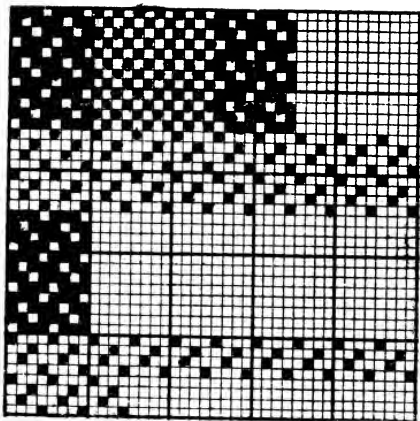

319

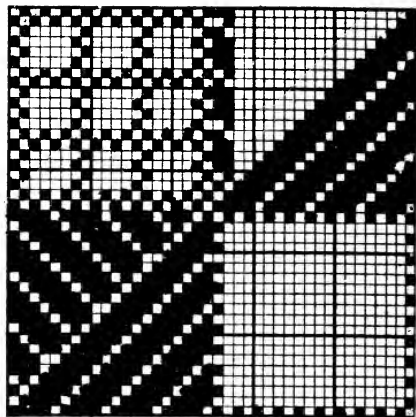

320



321

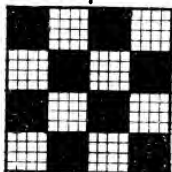

322

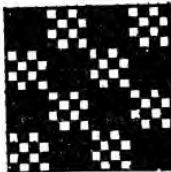

323

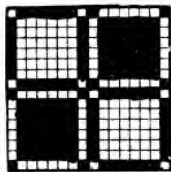

324

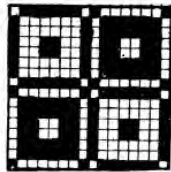

325

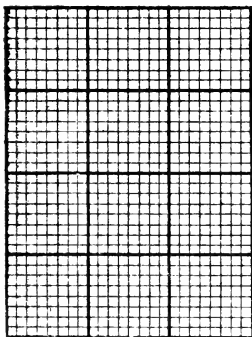

324

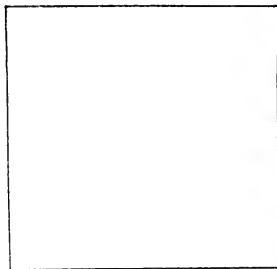

cloth

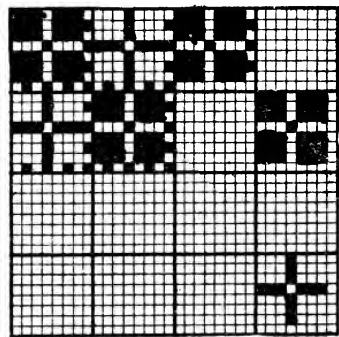

326

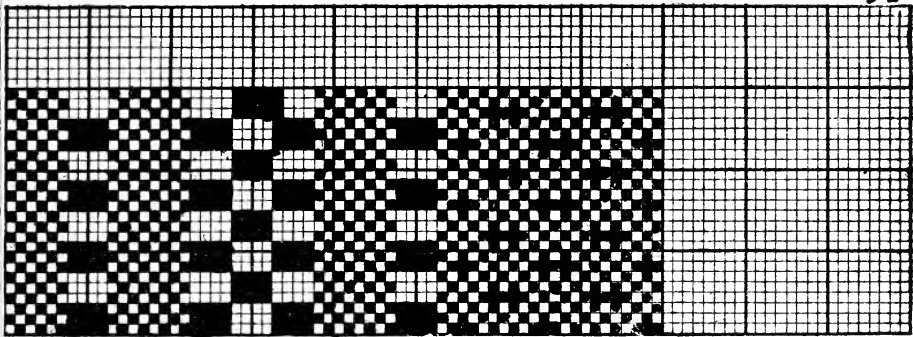

Border

328

Huckaback

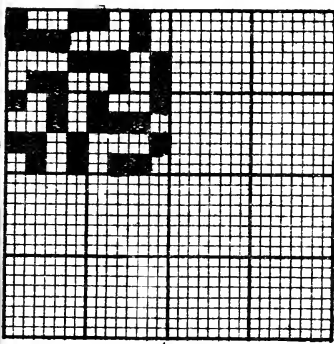

329

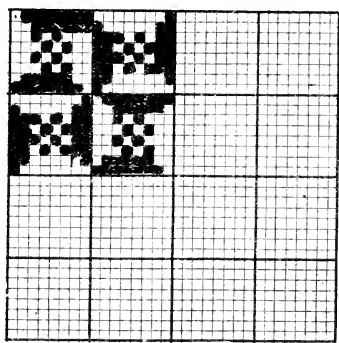

330

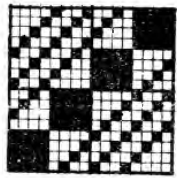

331

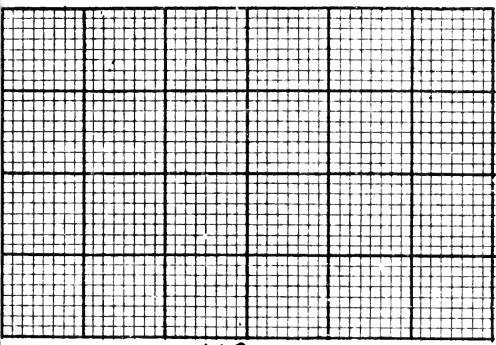

332

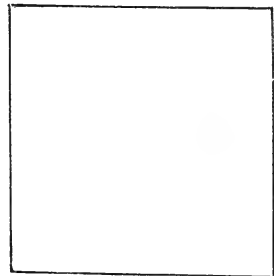

cloth

DESIGNING

Enlarged Fancy Diamond patterns are made by taking a basis as indicated by the outline in Fig. 333. and building up a pattern from it, repeat the pattern on the basis given.

334 is based on the outline 335. From 335 build up a suitable pattern. 336 is based on the outline arrangement shown, repeat the pattern to fill the space given. Design a pattern on 337 after the style of 336. 338 and 340 are suggested from 336. Complete 340. 339 is based on the outline 335.

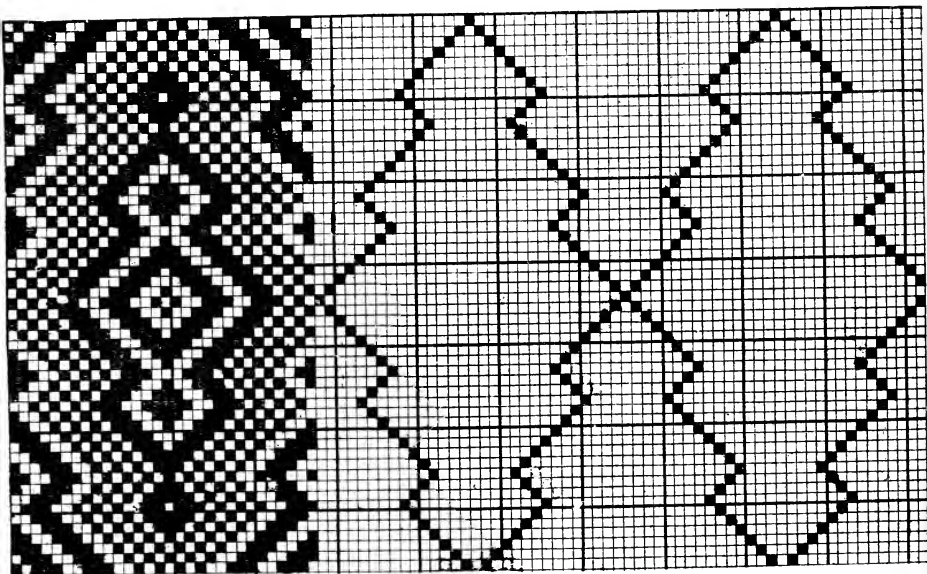

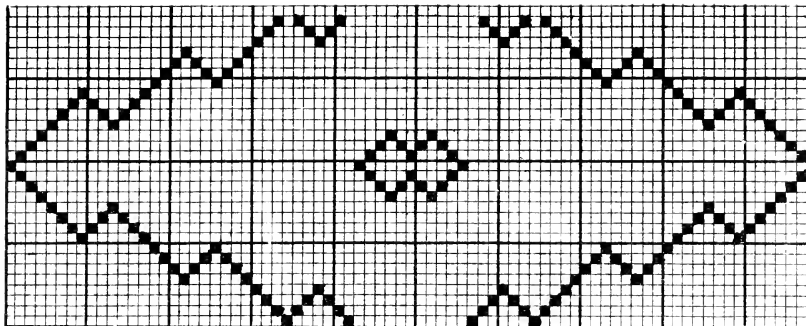

335

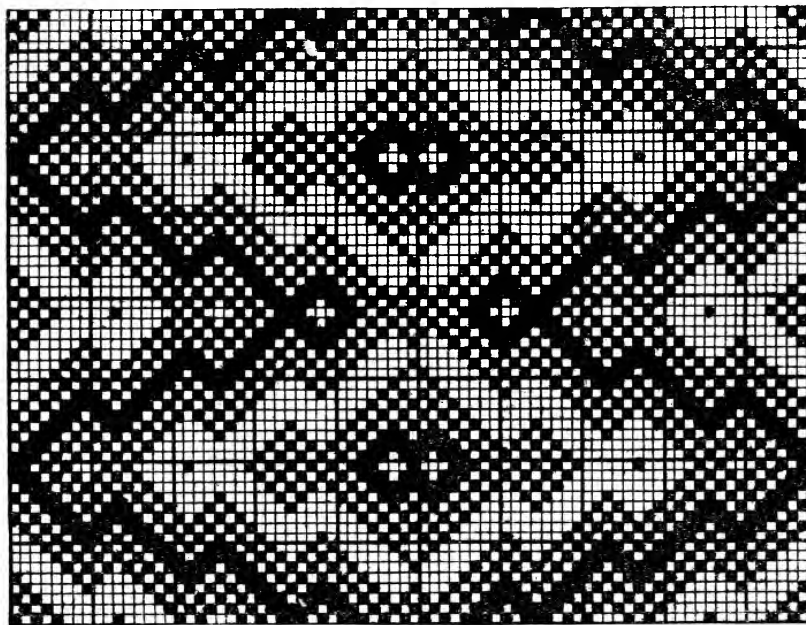

334

336

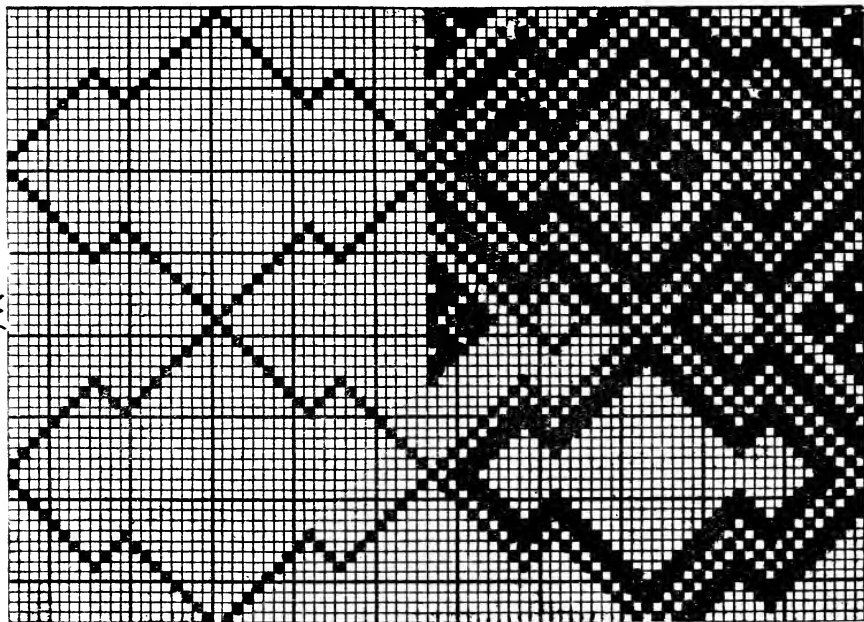

337

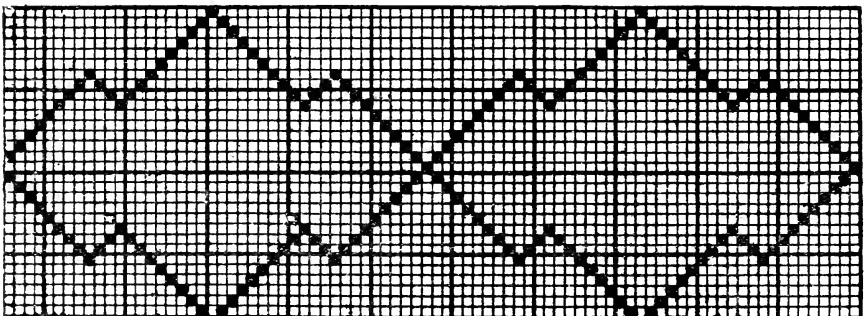

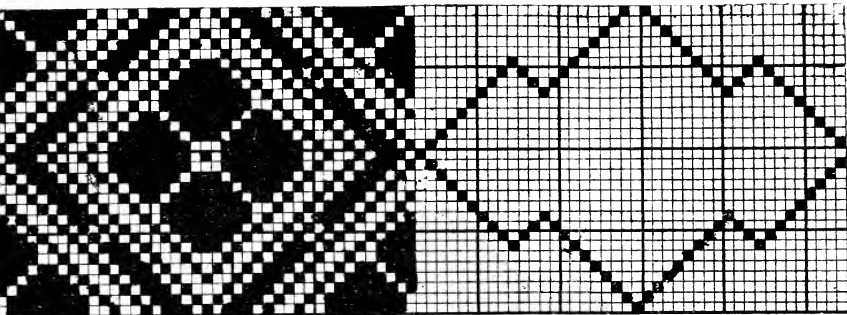

340

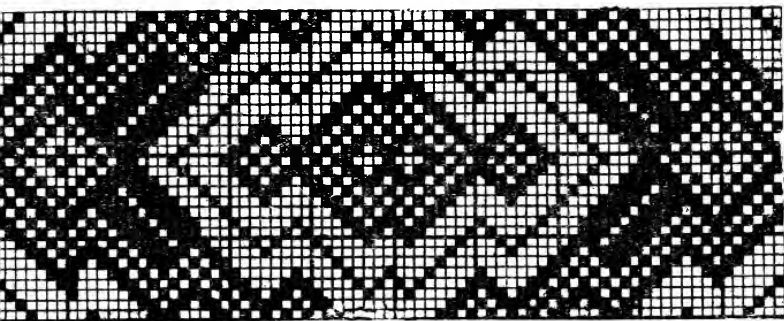

339

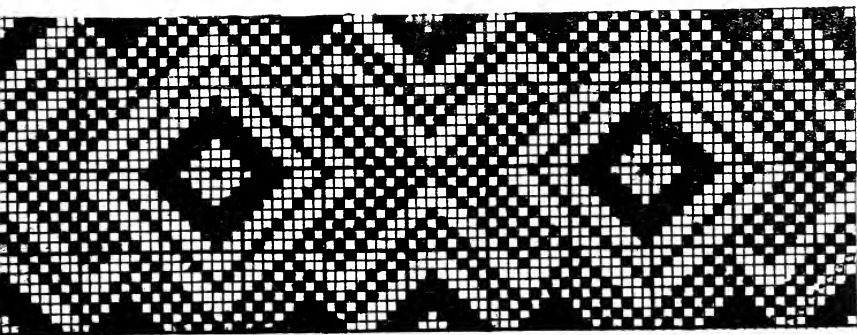

338

57 Crêpes or Crapes are patterns of an all-over effect broken up, so that the repeat of the pattern is not very easily followed. These are made in many different ways; the rearrangement of the ends of a twill in satin order will produce a Crape. Or the combining of two twills end and end. 341 and 342 are two 8 end twills, 343 to 350 show them combined, in each case the odd ends are taken from 341 and the even numbered ends from 342. In 343 the 2nd end is the same as no. 1 end in 342. In 344 the 2nd end is the same as 2nd end in 342. In 345 the 2nd end is the same as the 3rd in 342, and so on advancing a thread for every ^{up to} 350 ^{pattern.} Sometimes a twill is taken as in 351 and the ends rearranged, in 352 all the odd ends are taken from 351, and the even ends from 351, but in 352 the 2nd end commences with the 4th end of 352. In 353 the 2nd end commences with the 8th end of 351. In 354 the 2nd end commences with the 6th end of 351. On 355 make a twill and on 356, 357 and 358 rearrange it to make new patterns. Use 359 for cloth analysis or woven patterns.

Many crapes have a satin basis as shown in 360 to 363. On 364 to 367 make Crapes on the basis given.

Crapes are often based on a broken twill as shown in 368 to 371. On 372 to 375 make Crapes on the basis given.

376 to 379 illustrate other methods of producing Crapes. They are based on 376.

380 is the basis for 381, 382 and 383. and 384. 385 is the basis for 386 and 387. Make a Crape on the basis 388. 389 is a well known and much worn Oatmeal or Sand Crape.

390 shows the method of shading from solid warp to solid weft 8 end Satin. 391 shows the method of shading from warp twill to plain cloth.



341



342

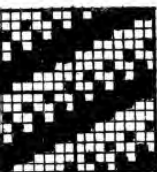

343



344

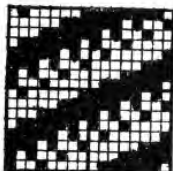

345

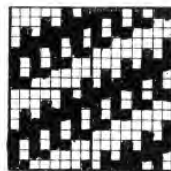

346

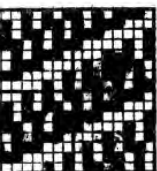

347

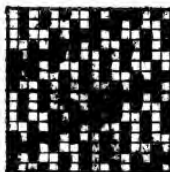

348

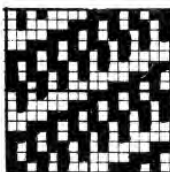

349

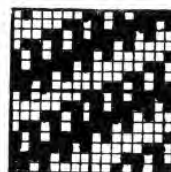

350

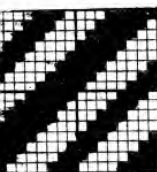

351

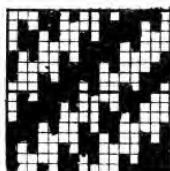

352

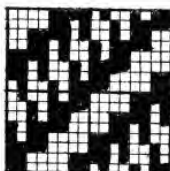

353

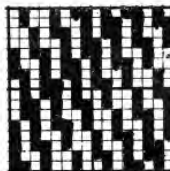

354

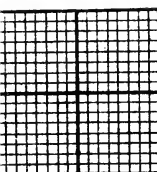

355

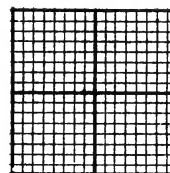

356

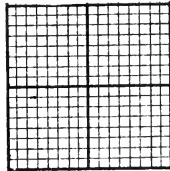

357

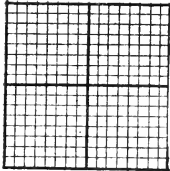

358

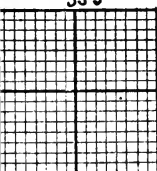

359

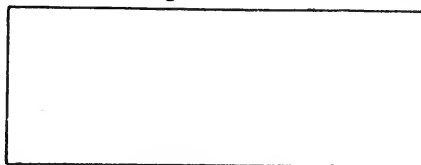

Blank

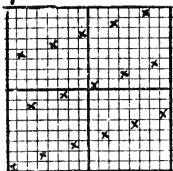

360

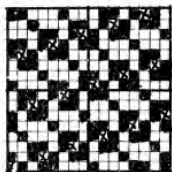

361

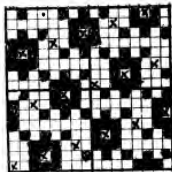

362

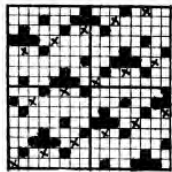

363

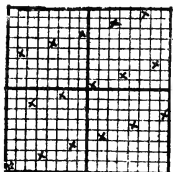

364

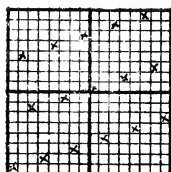

365

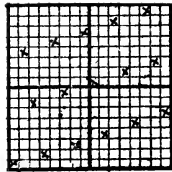

366

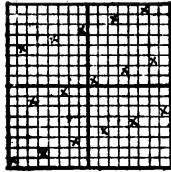

367

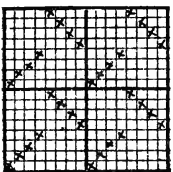

368

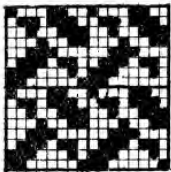

369

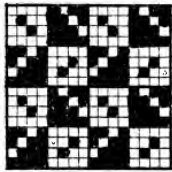

370

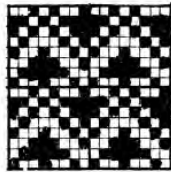

371

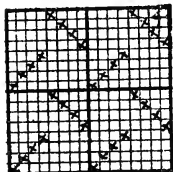

372

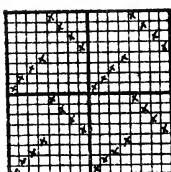

373

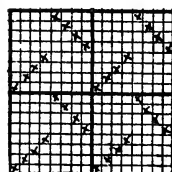

374

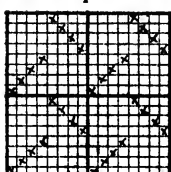

375

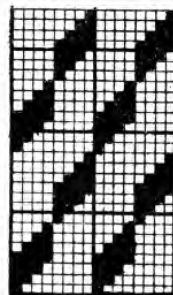

376

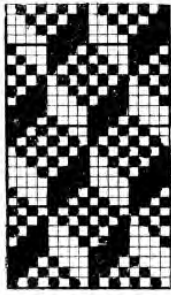

377

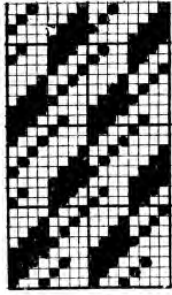

378

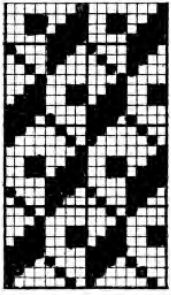

379

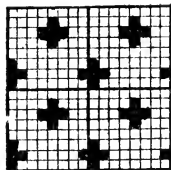

380

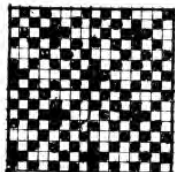

381

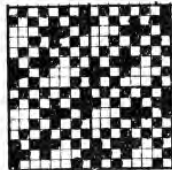

382

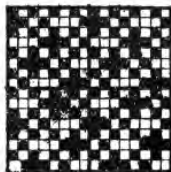

383

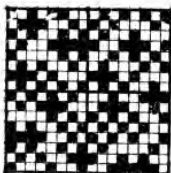

384

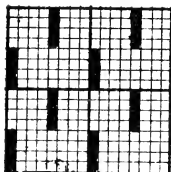

385

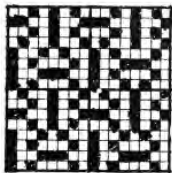

386

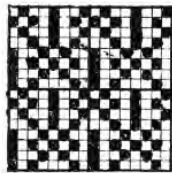

387

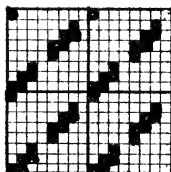

388

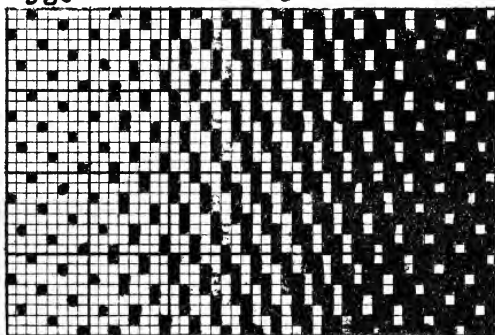

390

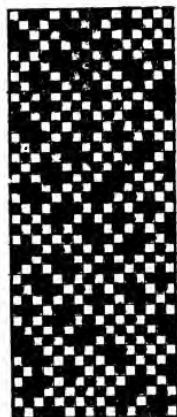

389

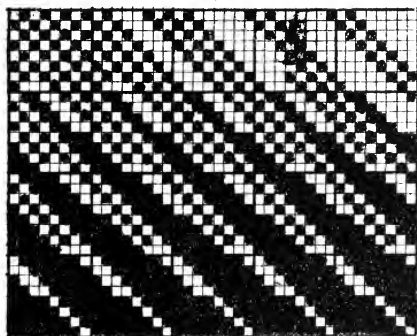

391

Spot figures arranged in alternate order, and surrounded with plain, twill, or satini ground make effective patterns, and with a set of heads 16 shafts loomed point draft, or loomed point draft on the 1st 8 heads and point draft on the 2nd 8 heads thus \wedge \wedge a good range of patterns can be made after the style of 392 and 393. 394 to 415 give a range of suitable spots. On 416 make a design, use one of the spots shown and surround with plain. Use 417 for cloth analysis or a woven sample of your own.

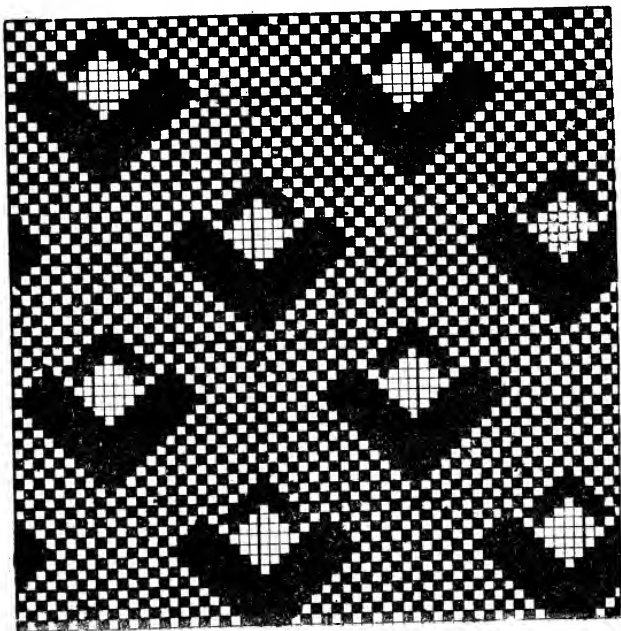

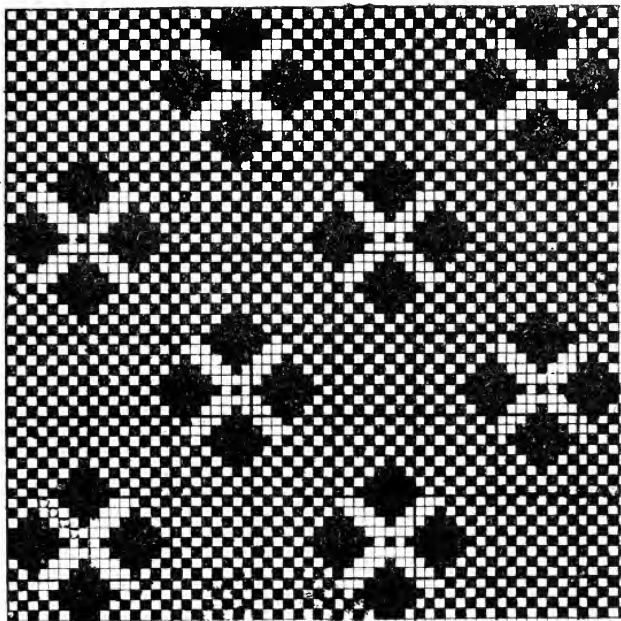

393

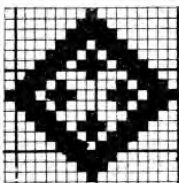

394

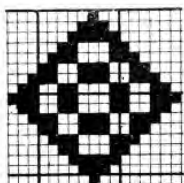

395

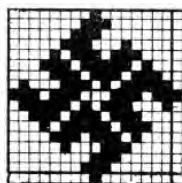

396

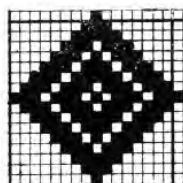

397

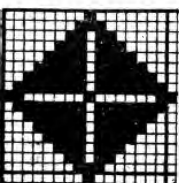

398

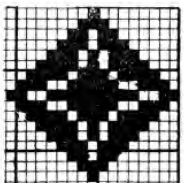

399

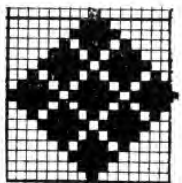

400



401

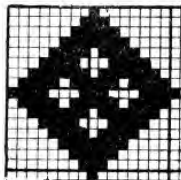

402

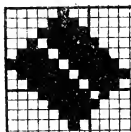

403

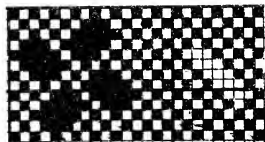

404

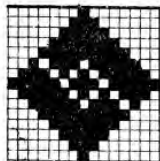

405

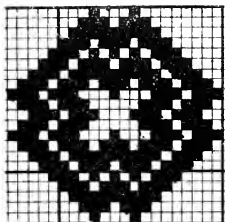

406

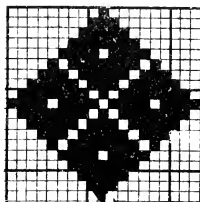

407

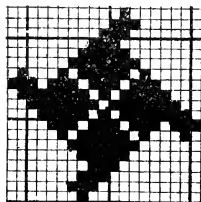

408

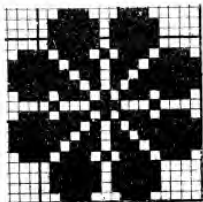

409

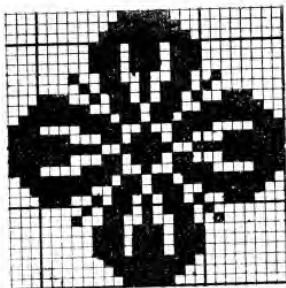

410

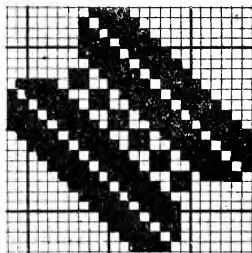

411

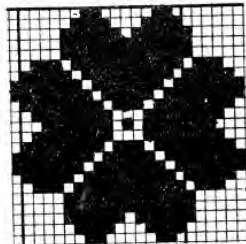

412

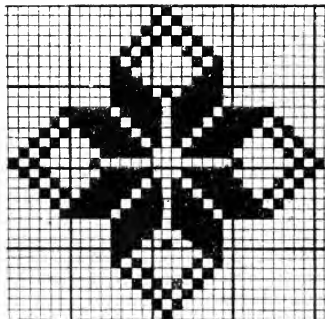

413

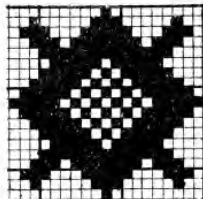

414

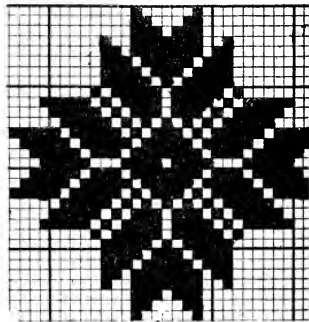

415

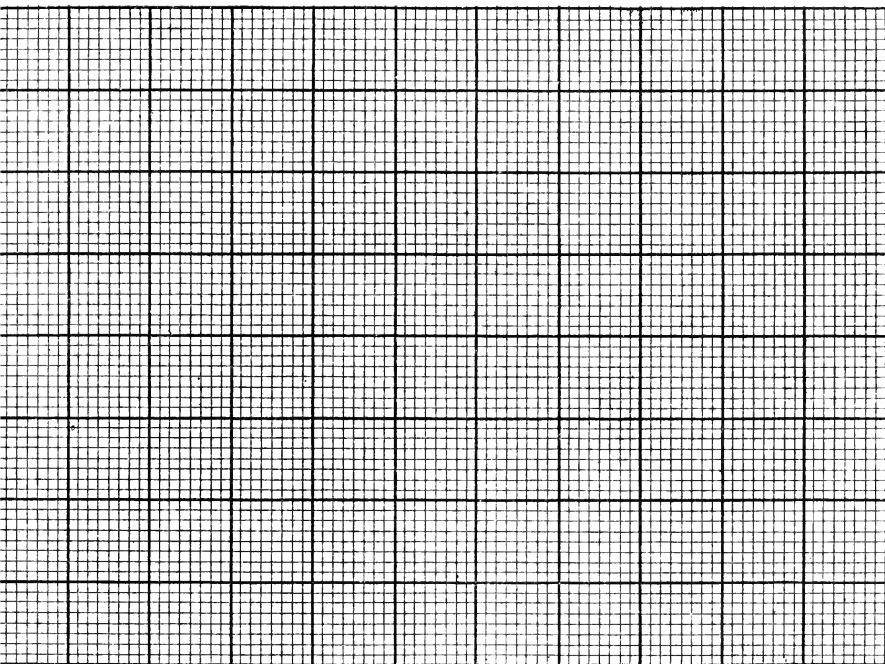

416

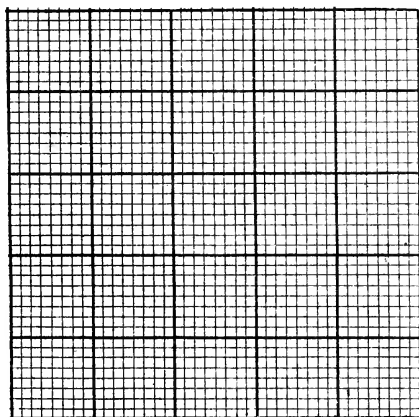

417

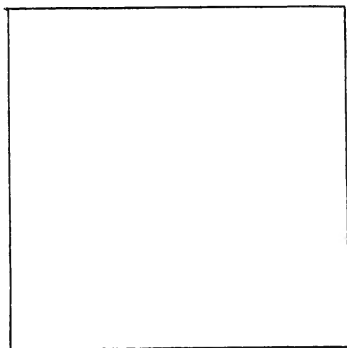

cloth



Figuring with Extra Warp.

418

Fig. 418 illustrates an extra warp pattern such as one made in a loom by border cloths; the pattern is developed in extra coloured warp, 16 jacks of a cloth, one required to weave the border and trimmings, with an additional four heads to weave the body of the cloth, which is a plain weave. In the border each coloured end is alternated with a plain end, also in the border the ends are dented 3 ends in a dent, in the body of the cloth the ends are one dented 2 ends in a dent.

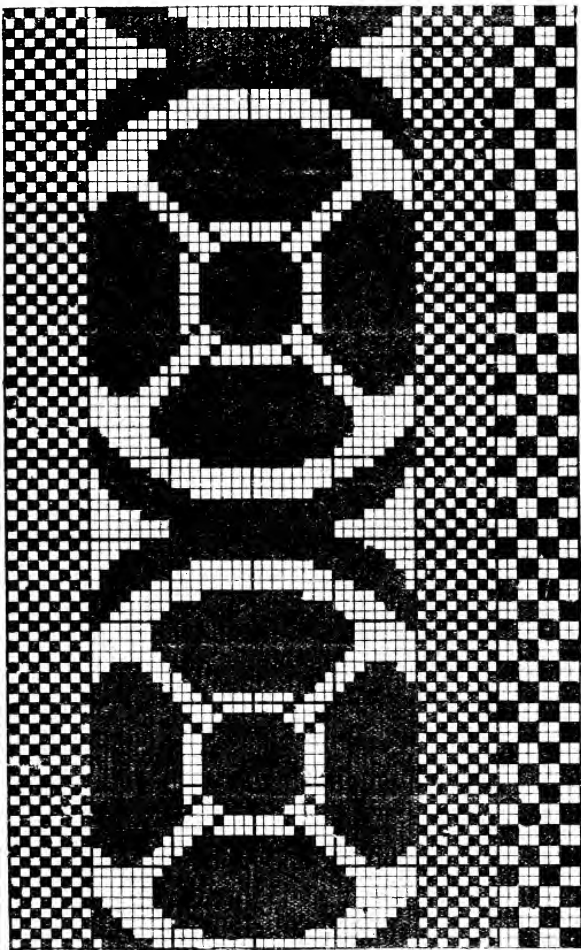

419

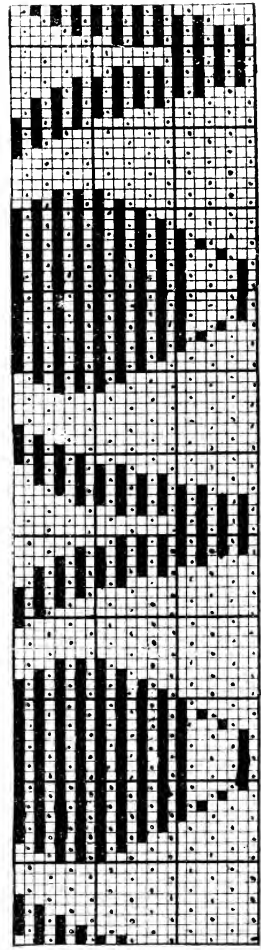

420

Fig. 419 shows 418 enlarged for design paper, and the manner in which the pattern is prepared from the sketch 418. 420 shows a portion of 419 as it appears when the cloth is analyzed, the end are arranged 1 end colour ■ 1 end ground □ white.



421

Figuring with Extra Weft

fig. 421 gives a sketch of an extra weft figure effect on a plain ground. A circular or Drop-Box loom is required. 422 shows one of the figures developed on design paper. 423 shows how the picks of weft are inserted namely, 2 picks □ plain, white weft; 2 picks ■ extra weft coloured. The floating weft from one figure to the next figure is afterwards cut away by a snaring process. 424 is a good idea for making stripe effects with a white warp and different coloured wefts, say GREEN, PINK, and BLACK. Use 425 and 426 for cloth analysis or woven samples. Extra warp or Extra Weft.

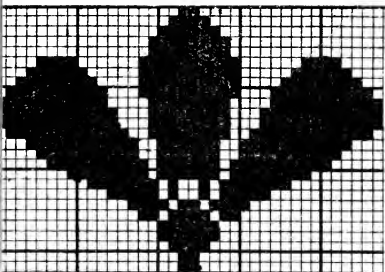

422

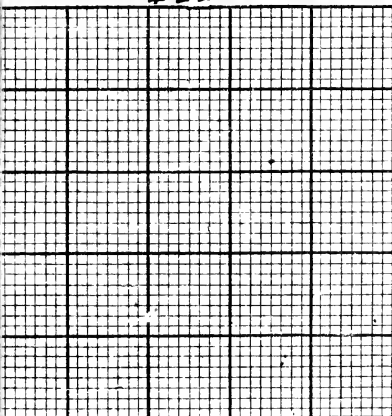

425

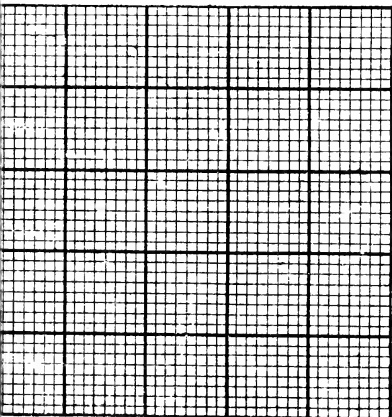

426

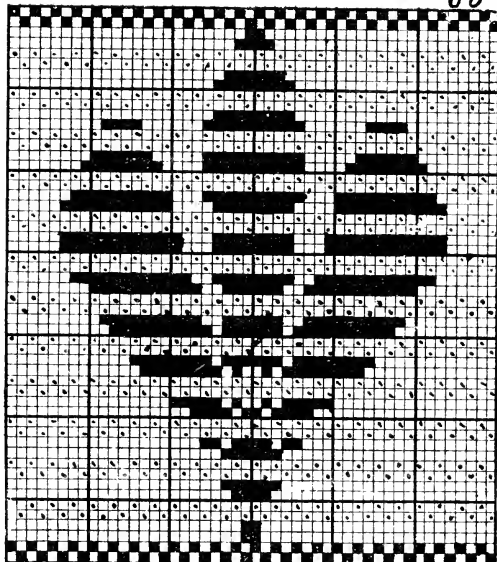

423

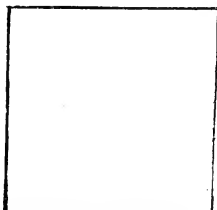

Extra Warp.

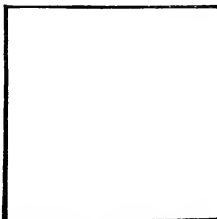

Extra Weft.

WEFT
Green

Pink

Green

Black

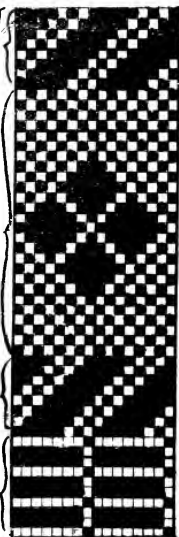

424

DESIGNING

Bedford Cords. Figs. 427 to 430 illustrate this class of weave, the general appearance of the woven cloth, is that of a cord down the piece; in 427 the width of the cord is 8 threads wide as shown by the \blacksquare 's, each cord is separated from the next cord by 2 ends weaving plain cloth \square . 428 is another cord, 10 threads wide, this example shows the contrary side of the cloth to 427. In 429 "padding ends" \square are introduced, these pad the cord from behind, and give a much fuller cord. The \blacksquare 's show the denting. 430 is a stripe made from a cone, and wave effect, give the loom and peg plan. 431 and 432 to be used for cloth analysis on woven samples.

WELTS are very similar to Bedford Cords, except that the cord runs across the piece, in 433 the ends are arranged 2 ends face \square plain cloth, 1 end back \blacksquare , with wadding picks \square ; the division is made between one cord and the next, by lifting the back ends into the face cloth \blacksquare . 434 shows the back ends \square binding on wadding picks. 435 shows a fast back, five weft interweaving in plain order with the back warp \blacksquare .

Piques. 436 & 437 illustrate types of Piques, the arrangement is 2 face ends \square , 1 back end \blacksquare , the face weave is plain, and the back ends are lifted into the face cloth \blacksquare , and pulling it down, produces an embossed effect on the face. \square are wadding picks. 438 is arranged 2 face \square 1 back in ends, the manner of lifting the back ends into the face cloth, produces a wave effect on the face \blacksquare .

In 433, 434, 437 and 438 \blacksquare is the denting. 439 & 440 for cloth samples.

Sustains on Cords, these cloths are generally known as weft pile fabrics, 441 to 443 illustrate them, \blacksquare are pile picks, \square are ground picks, the arrangement is therefore 2 pile picks, 1 ground pick. In 441 the back weave is a 2 & 1 twill, in 442 a plain back, in 443 a 2 & 2 twill back. The pile picks are afterward cut as shown in section Velvets, 445 to 447 illustrate this type of weave, \blacksquare pile picks, \square back picks. 445 is arranged 2 pile picks, 1 ground pick, plain. 446 is 3 pile ground, ground weave 2 & 1 twill. 447 is 4 pile picks 1 back pick. back or ground weave 2 & 2 twill. The pile weft is afterwards cut as shown in section. 448 for sample of cloth.

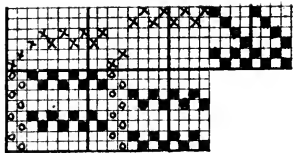

427

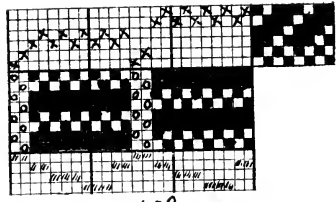

428

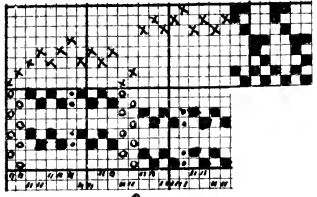

429

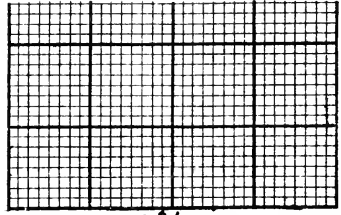

431

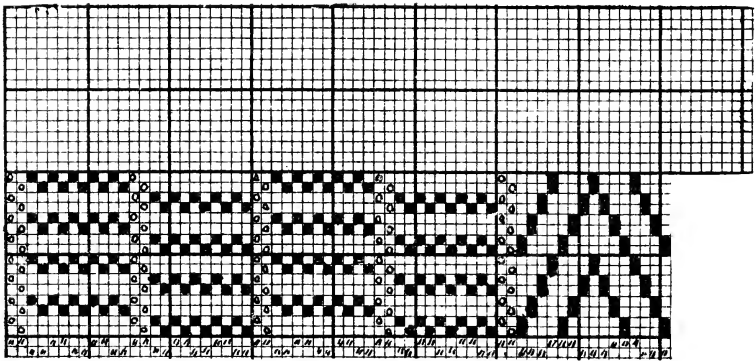

430

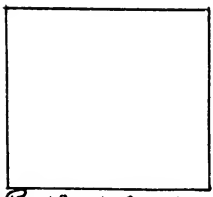

Bedford Cord.

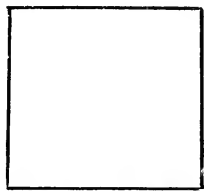

Bedford Cord.
padding ENDS

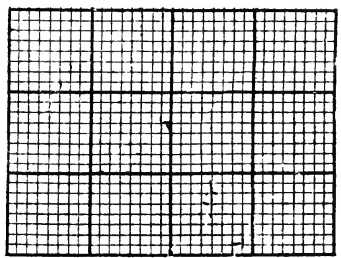

432

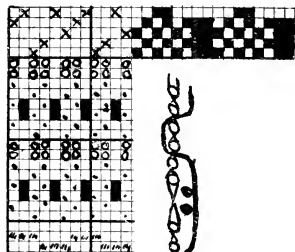

433

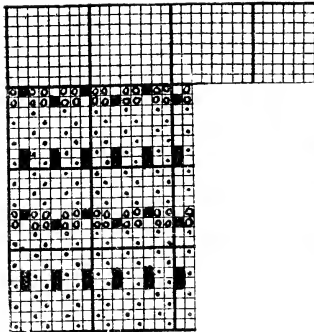

434

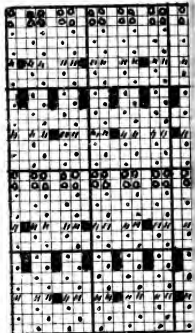

435

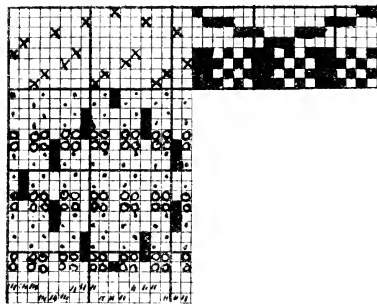

436

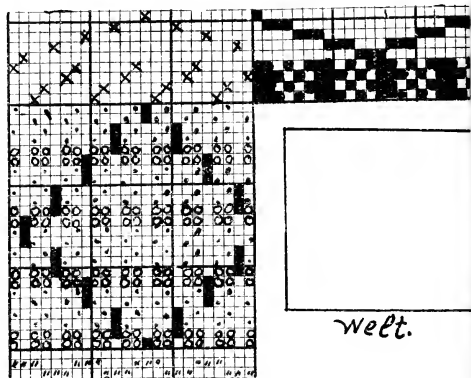

welt.

437

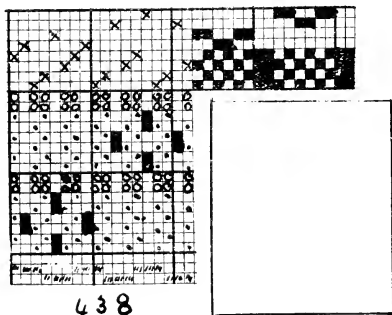

438

Pique

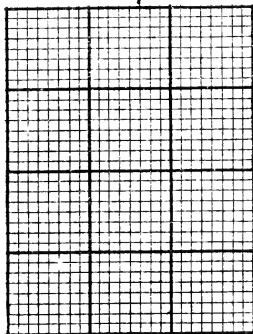

439

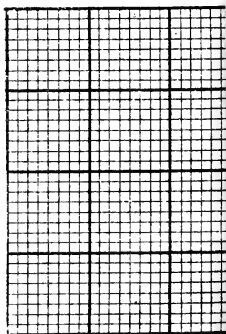

440

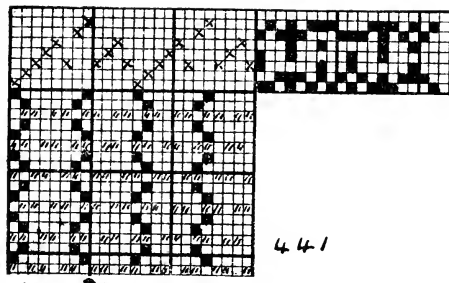

441

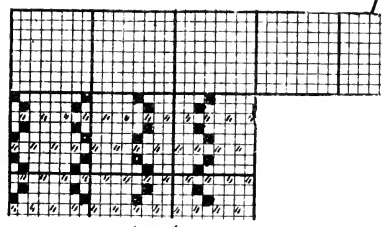

442

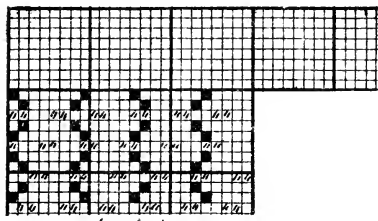
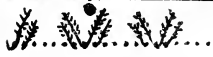

443

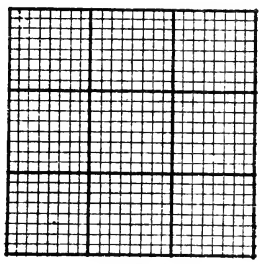

444

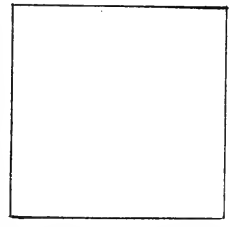

Justian or Cord

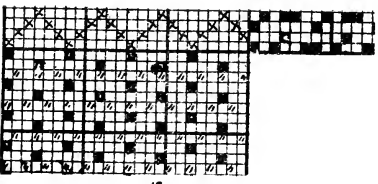

445

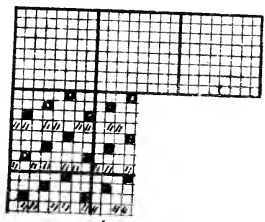

446

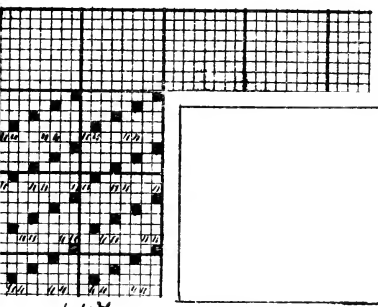

447

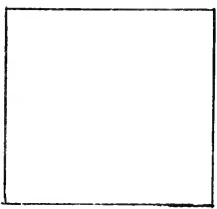

Velvet

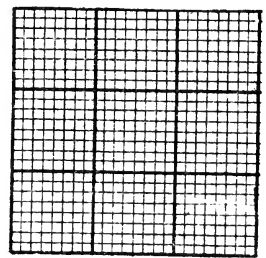

448

The first loom to run by power was invented by Dr. Cartwright, a Clergyman, in 1784. His loom was very much the same in its general principles, as they are made to-day. Successive inventors have improved upon it, and additional accessories have been added, in the form of Shedding motions, as Dobbies and Jacquards, Changing Shuttle box motions, Pick and Pick looms. The latest form of loom, but not in general use is the Automatic Loom, which supplies a new cop, as the previous cop is spent, without any attention from the weaver, and without a stoppage of the loom. At this stage the construction of the Plain or Calico Loom is of some importance, the naming of the principal parts, the different motions of the loom, and the object of each motion.

The THREE primary movements in a loom required to produce a piece of cloth are -

Shedding, this is the separation of the warp ends for the passage of the shuttle, this is brought about by means of Tappets, Dobbies or Jacquards.

Picking is the throwing-in of the weft by means of the shuttle.

Beating-up. The carrying of the weft forward to the fell of the cloth, by means of the slay and the reed. The other minor motions, all of which are necessary for the successfully working of the loom are -

Weft Fork motion, to stop the loom when the weft breaks.

The Brake, to prevent the loom running too-far, after the strap is thrown on to the loose pulley.

Stop-Rod and Loose-Reed motions, these prevent the breakage of the warp, when the shuttle stops in the Shed.

Shuttles to carry the weft.

Taking up Motions, to regulate the picks per inch in the cloth.

Embles for keeping the cloth stretched in the loom.

Fig 449 is an illustration of a plain loom and 450 & 451 show the two sides in greater detail.

44

677

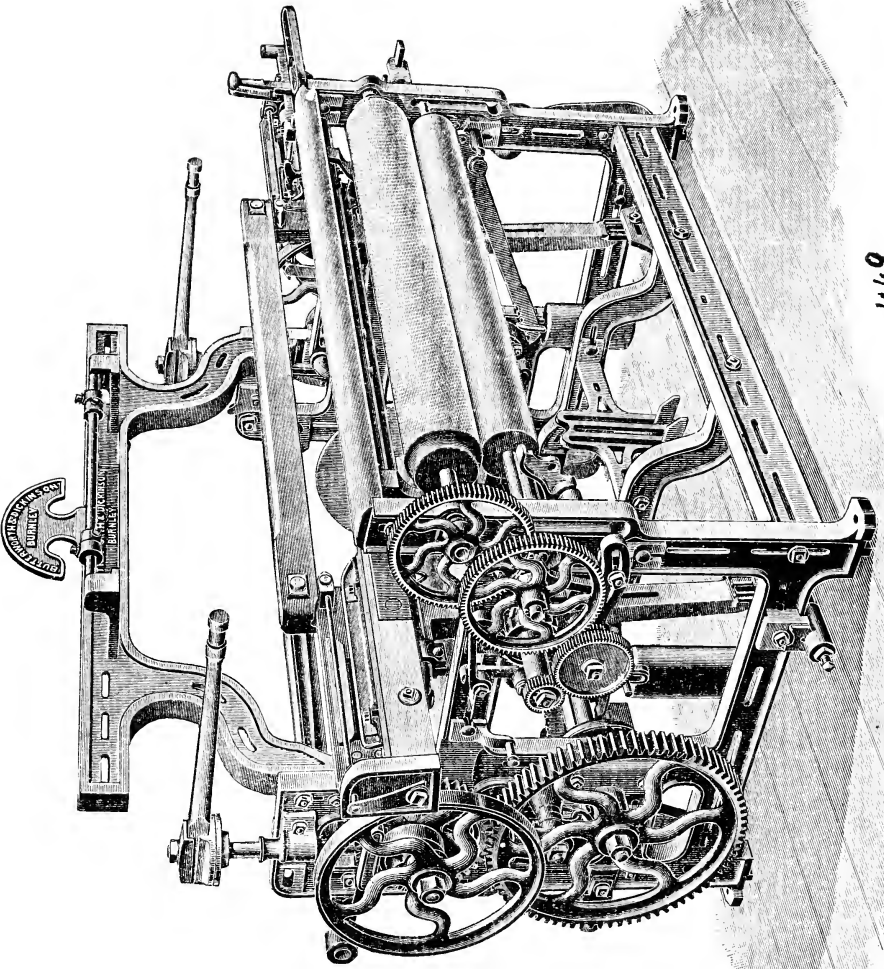

W. & A. G. BUCKLEY
LONDON

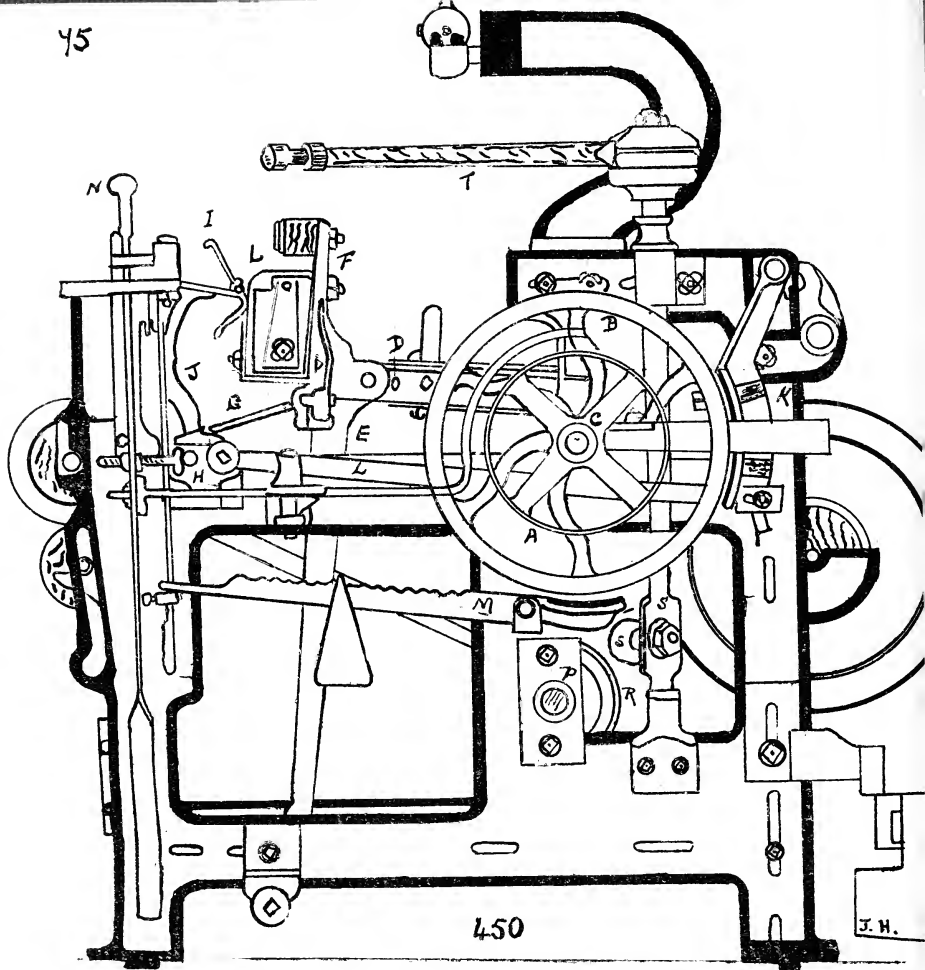

450

J. H.

A Driving Pulley, B. Brake wheel, C crank, or Top shaft, D. crank arm
 E, slay wood, F, Box-end and slay, G, stop-rod tongue for a
 fast need, H, Frog, I, Weft fork, J, Weft fork hammer and lever
 K, Baer brake, L connection rod from frog to back brake, M, brake,
 connected with Weft fork, N, starting handle, P, Bottom shaft, on
 this shaft are fixed the Shedding tappets, Picking tappets R, S is the
 Picking bowl, on shaft to which the picking stick T is fixed.

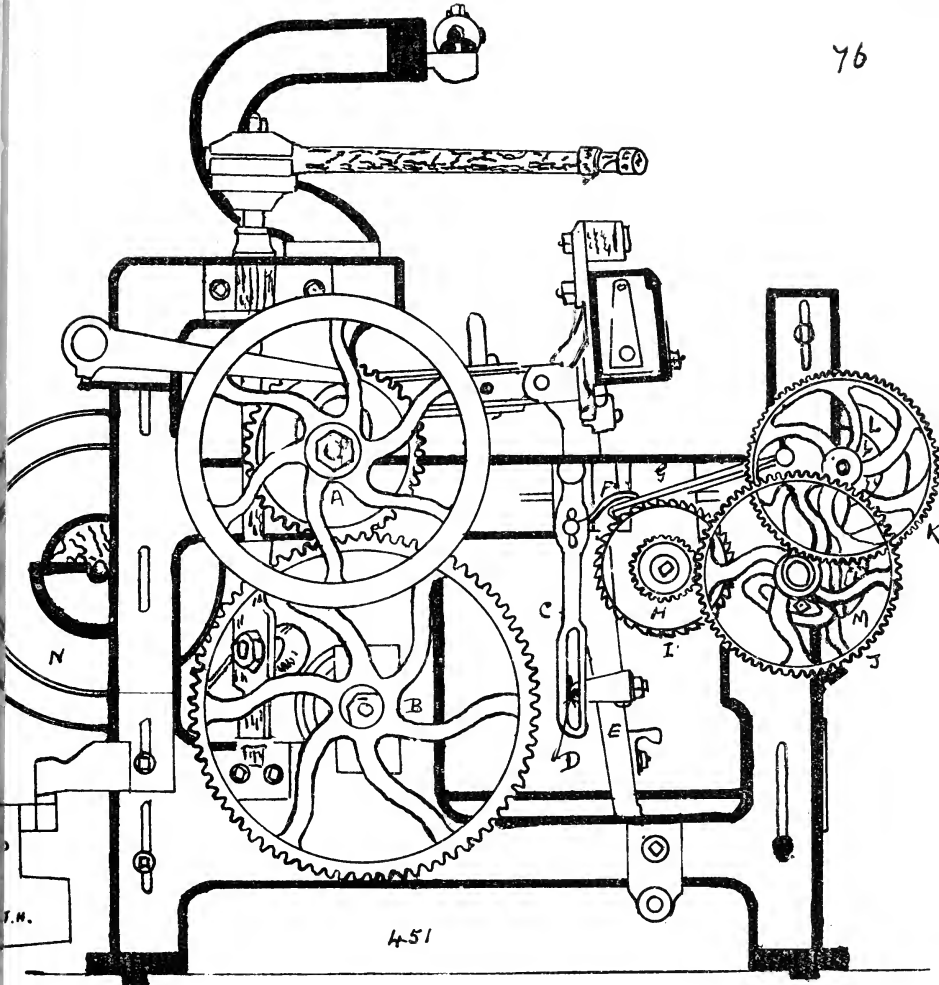

7, crank shaft on Driving wheel. B bottom shaft wheel. C, setting-up lever for taking-up motion, it receives its motions from a bracket and pin D fixed to the slay sword E on lathe arm. F, take-up lever catch. G, retaining catch. H, I, J, K, a train of wheels, the take-up motion, they are connected with the roller L, and L drives the cloth roller M by frictional contact. N Warp beam P Beam weight.

BOOM FITTINGS

The object of the two following plates is to make the student perfectly familiar with all the parts required to build a Plain Balio boom; they will also serve as suitable illustrations for Drawing lessons.

1. Shedding Beam Fixture, Left hand.	23. Boom Side. Planed framing	45. Strap-pont bracket, Right hand.
2. do. do. Right hand.	24. do. Common do.	46. do. do. Left do.
3. Loose Pulley.	25. Take-up Roller fixture, Right hand.	47. Front nail.
4. Fast Pulley.	26. do. do. Left do.	48. Weft Faller, Right hand.
5. Crank Bush, Right hand.	27. Shuttle-box, Left hand.	49. do do. Left do.
6. do do. Left hand.	28. do. do. Right do.	50. Cloth-beam lever Stud.
7. Bull Horn, Left hand.	29. Breast Beam.	51. Cloth-beam haver.
8. do do. Right hand.	30. Tappet shaft stay.	52. Back nail
9. Top-tree, Common Framing.	31. Tappet shaft stay Bush.	53. Weighting chain fixture.
10. Top-tree, Planed do.	32. Picking shaft Socket.	54. do. do.
11. Tappet shaft Bush, Left hand.	33. Picking shaft footstep.	55. Weft Hammer.
12. do. do. Right do.	34. Picking-bit, Left hand	56. do. do.
13. Bracket for Crank end stay.	35. do. do. Right do.	57. Weft Hammer bracket.
14. Right hand Crank end stay.	36. Plain Weaving Tappet.	58. Weft do. Stud.
15. Shedding beam Protection.	37. Tappet shaft.	59. Weft Hammer Boss.
16. do. do. do.	38. Weft hammer lifter.	60. Weft do. Haver
17. Frog, Left hand.	39. do. do. do.	61. Weft Lever
18. do. Right hand.	40. Spring rail fixture.	62. Catch-rod finger
19. Frog Plate	41. Picking Tappet Boss.	63. do. do.
20. Strap-pont Plate.	42. Picking Tappet Shell.	64. Picking-shaft spring hook
21. Spring Rail, on Rocking Rail.	43. Plain-head Stand, Left hand.	65. Crank (Shaft).
22. Starting handle.	44. do. do. do. Right do.	

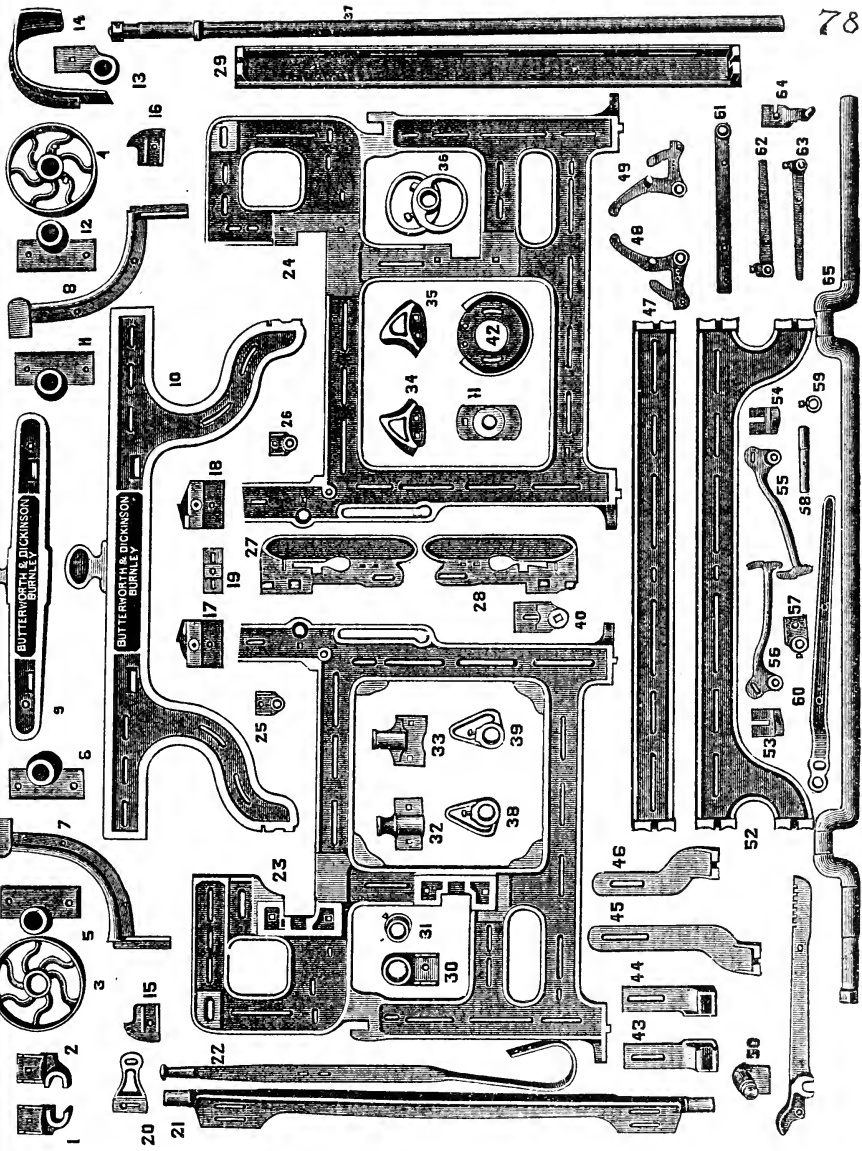

LOOM FITTINGS - continued.

66.	Handrail	93.	94-95	Lathe arm no. 2. 3. 4.	129	Dray.
67.	Handrail plate	96.	Stop. rod Spring.	130	Knock wheel	
68.	Lathe Plate on Slay Gate	97.	Stop rod.	131	Balance wheel.	
69.	Lathe on Slay plate left hand.	98.	Binder.	132	Crank wheel	
70.	Swell Pin.	99.	Binder	133	Tappet shaft wheel.	
71.	Swell hinge. Fast Reed	100.	Plain Treadle - grate. Double	134.	Eccentric	
72.	do. do. do.	101.	102. Treadle. grate left & right hand.	135	Take-up wheel slid L on R.H.	
73.	Swell left hand. Fast reed.	102.	Plain Treadle bowl.	136.	Take-up wheel Stud bracket	
74.	do. right do. do. do.	103.	Treadle bowl pivot.	137	Lathe wheel basket	
75.	Spindle Stud. fast reed.	105.	Plain Treadle.	138	Catch wheel - Stud.	
76.	Spindle.	106.	Plain Treadle heel.	139	Catch wheel - left Catch wheel	
77.	Box side.	107.	Plain Treadle pin.	140.	141 right & left Catch wheel	
78.	Box end, left hand.	108.	109. Shedding Beam lever.	142	Beam wheel	
79.	Box end, right hand.	110.	111. left & right hand Shedding Beam	143	Taking-up wheel.	
80.	Box back, left hand. Fast reed.	112.	Crank arm.	144	Change wheel.	
81.	do. do. right do. do. do.	113.	114. Long short Crank arm strap.	145.	146. Taking-up Lever.	
82.	Front plate, fast reed.	115.	116. Ribs stop for Crank arm	147.	Taking-up Lever Stud.	
83.	do. do. do. do. Fork side.	117.	Iron stop for Crank arm	148.	Taking-up lever Catch	
84.	Wet Fork.	118.	Sit for Crank arm.	149.	150. right & left holding Catch	
85.	Survell.	119.	Collar for Crank arm.	151.	holding Catch box.	
86.	Wet grate. Fast reed.	120.	121. Wet Brake.	152.	153 Taking-up lever Brackets.	
87.	Lathe on Slay.	122.	Wet Brake Stud.	154	Pin for do. do. do.	
88.	Box end spring.	123.	Wet Brake clip for wheel.	155	Catch rod.	
89.	Stop-rod Spring.	124.	Wet Brake weight.	156	Picking stick cap.	
90.	Stop-rod Cup.	125.	Fallen wire.	157.	158 upper & lower picking slide	
91.	do do do do	126.	Fallen wire bars.	159.	160 Picking bowl stud & Bush.	
92.	Lathe-arm. Fast reed. no. 1.	127.	Back Brake Bush.	161.	Picking Bowl.	
		128.	129. left & right hand Back (on Wall)	162.	163. Picking stick on shaft.	

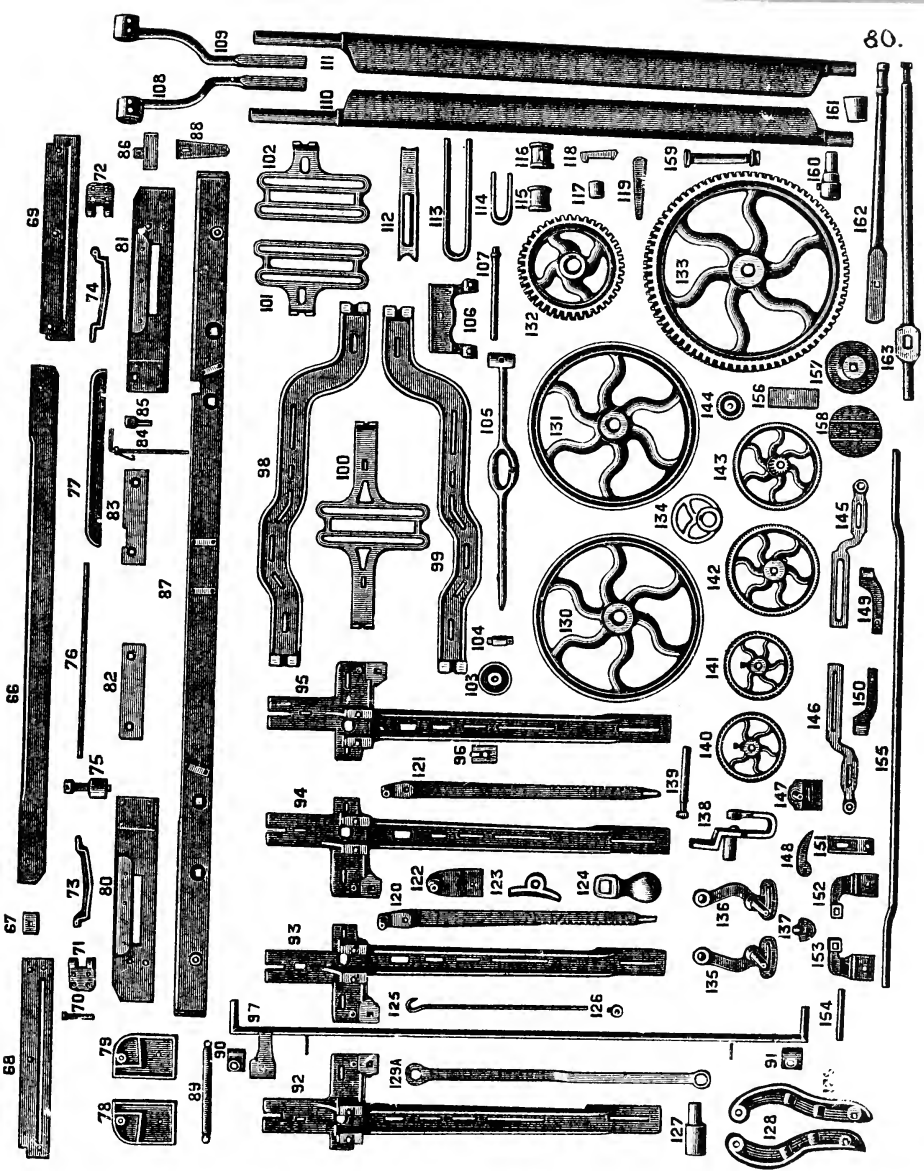

SHEDDING - Tappet and Top Rollers-

Tappets are used for working the healds, when making plain on Calico cloth. 452 illustrates the motion; the two healds are connected at the top, by means of straps to the top roller A, this roller carries two bowls, the strap from the back heald passes round the larger bowl and the strap from the front heald round the smaller bowl, the back heald by this means is lifted higher, and enables the same size of shed to be made by both healds at a point in front of the shuttle, and for the same reason the tappet working the back heald is made from $\frac{3}{8}''$ to a $\frac{1}{4}''$ of an inch larger than the tappet working the front heald. The tappets (only one is shown) B, act upon treadles C, and through the heald connections with the top-rollers shown, the sinking of one heald, causes the top roller to turn round, and lift up the other heald. Tappets up to 5 shafts or 5 picks to the round, are placed underneath the loom, with top roller arrangements to enable a sinking heald to bring up a rising one. 453 shows the arrangement for working three healds in the making of a Three end Twill, 2 down 1 up, these cloths are known as JEANS or JEANETTES the top rollers in this motion and the others to follow are worked on the lever principle, B is a roller in a fixed bearing, carrying two bowls A and C the diameters are in the ratio of 2 to 1, the larger bowl working the back heald, fixed to the smaller roller C is a strap which supports the swing roller D, the bowls on which, F, E bear a ratio to each other of 1 to 1 (a swing roller is not in a fixed bearing, it is free to move up and down a slot or groove provided for it, at the same time it is free to turn round when required). Treating the rollers as levers 454 assuming that the back heald is lowered 3". A goes up $1\frac{1}{2}''$, and lifts the centre of B, C, $1\frac{1}{2}''$, the front heald at the end of C is lifted 3".

455 illustrates the Four end Twill, 3 down 1 up, A is a roller in a fixed bearing, B and C swing rollers.

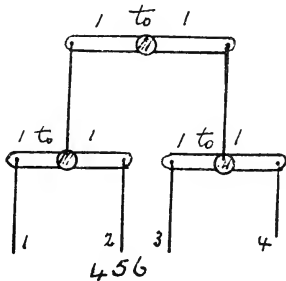
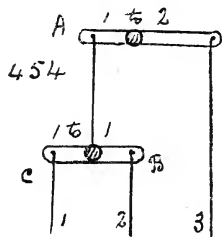
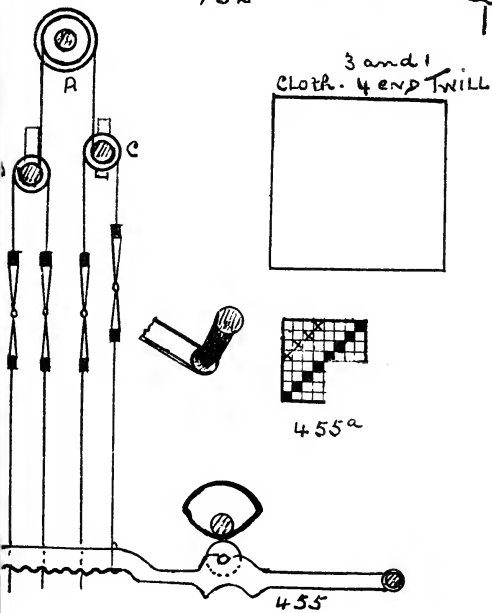
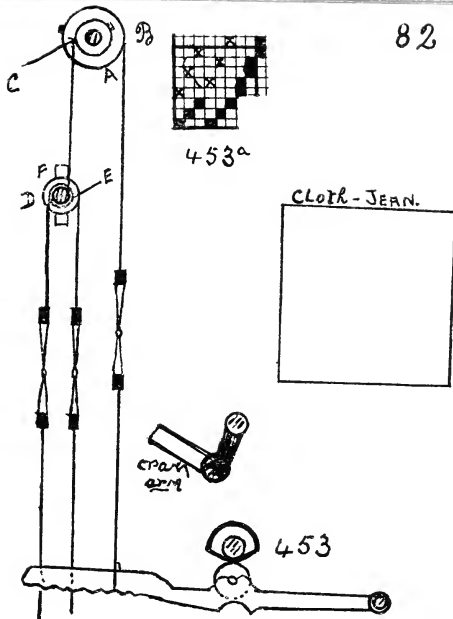
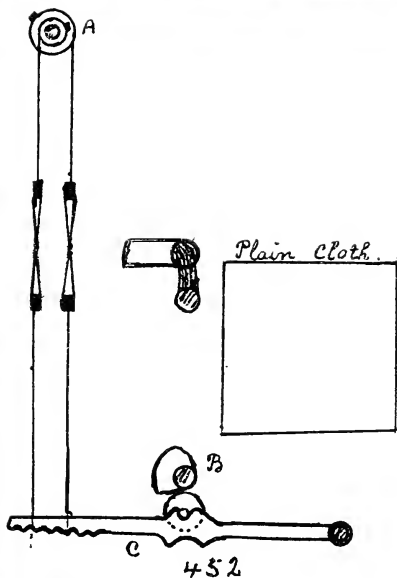

456. shows the arrangement of the rollers if treated as levers
 457. illustrates the Four end Twill 2 up and 2 down on
 each pick, the two rollers A and B are in fixed bearings. The
 two healds from one and the same roller, are never lifted
 or lowered at the same time, in the illustration the 1st
 and the 3rd healds are down, the 2nd and 4th up, treated as
 levers the arrangement is shown in 458. The cloths are known
 as double Twills, Cashmere Twills, Shallon Twills 2 and 2 Twills

459 illustrates the 5 end Twill or 5 end Sateen, 4 down
 1 up on each pick. A is a roller in a fixed bearing, B, C, and D
 being rollers, treated as levers their action is as follows:⁴⁶
 assuming that the 1st and 5th heald change their positions, the 1st
 to go down 2" and the 5th to move upwards the same distance
 2. 3. and 4 to remain stationary; A comes down 3", and the
 middle of A $1\frac{1}{2}$ "; bringing down C $1\frac{1}{2}$ ", the middle of the lever
 C, D comes down $\frac{3}{4}$ ", bringing down G $\frac{3}{4}$ ", and moving on
 the fulcrum I, A takes up the back heald 3".

453 shows the design, looming and peg plan for a JEAN.
 six healds are generally used, they are tied together and
 work in pairs.

455^a shows the design, looming and peg plan for a 3 or 1 Twill

454^a illustrates the design, looming and peg plan for a
 2 and 2 Twill, to enable the top roller motion to work
 this pattern, the looming must be as shown namely
 1. 3. 2. 4. This looming also allows this set of healds
 to be used for plain cloth without re-loomng, by
 tying the healds together in pairs and using a plain
 tappet.

459^a illustrates the design, looming and Peg plan for a 5 end Sateen
 The position of the Crank shaft in 452. 453. 455. 457. 459 show its
 position when Gaiting the warp, the healds are attached to
 their own rollers, the healds are then attached to the
 healds underneath, and the cords drawn tight, the
 lowered mail eyes to be on a line with the Slay.

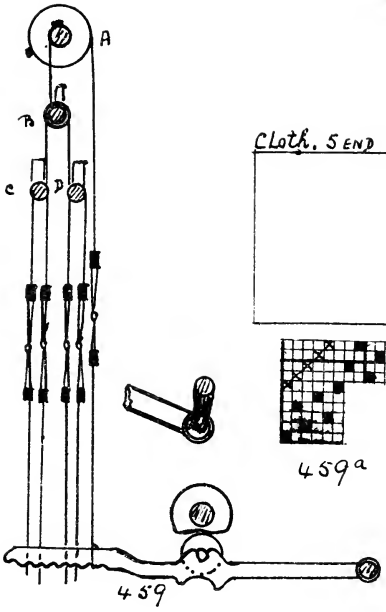

Clath. 5 END Sateen

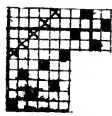
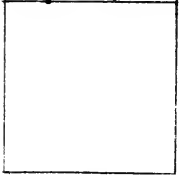

459a

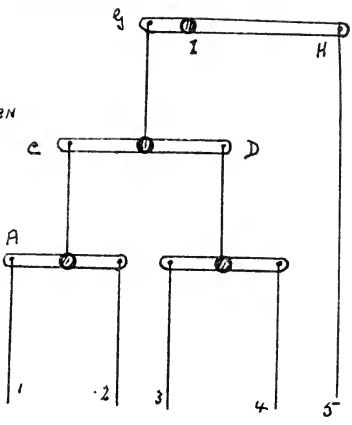

460

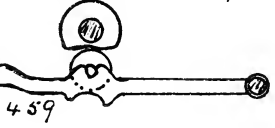

459

2 on 2 Jurell

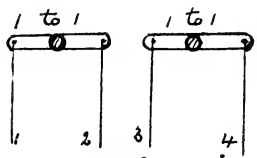
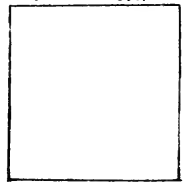

458

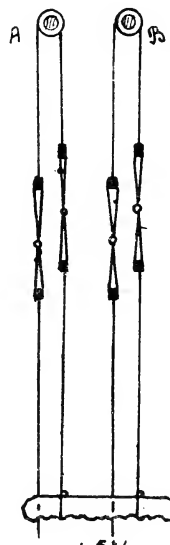

454



454a



SHEDDING-TAPPET CONSTRUCTION-

In the making of Plain cloth, tappets are used for changing the position of the healds and forming the shed for the shuttle they are of such a shape, that they change the position of the healds slowly, then keep them stationary for a time, sufficient to allow the shuttle to get into the opposite box. The length of time the healds are stationary is termed the dwell of the tappet, it varies from $\frac{1}{3}$ to $\frac{1}{2}$ a pick; in light running looms 36" reed space it is generally $\frac{1}{3}$ " of a pick.

461 shows how to construct a tappet to the particulars given. Let A equal the centre of the tappet shaft; at 1" from A describe the circle B which equals nearest point of contact; at $1\frac{1}{2}$ " from B, namely half the diameter of the treadle bowl describe the circle b, which equals a line described by the centre of the treadle bowl as it revolves in contact with the nearest point of contact; at 2" from b (the stroke of the tappet) describe the circle D which equals a line described by the centre of the treadle bowl as it revolves in contact with the leaf of the tappet. Let E, F divide the circles into as many parts as there are picks to the round, namely 2. Divide each pick into 3 equal parts, the 1st pick is divided E, I; I, J; J, F; the 2nd pick E, L; L, K; K, F; the spaces in the respective picks I, J and L, K, equals the dwell for one complete revolution of two picks, the spaces I, b; and J, K; equals the change. Divide the space on each side into 6 equal space by means of lines from the centre; on the line L, C describe the semicircle M, divide M into 6 equal parts, and drop straight lines on to the line L, C. describe the arcs of circles shown from A as a centre;

on the line I, J, describe circles $2\frac{1}{2}$ " dia. (treadle bowl) the inner edges of which gives the thick line for the dwell of the tappet, to obtain the shape for the change; at the points where the lines from the centre and the arcs of circles cut each other describe circles $2\frac{1}{2}$ " dia. The inner edges of these circles give the thick line for the change.

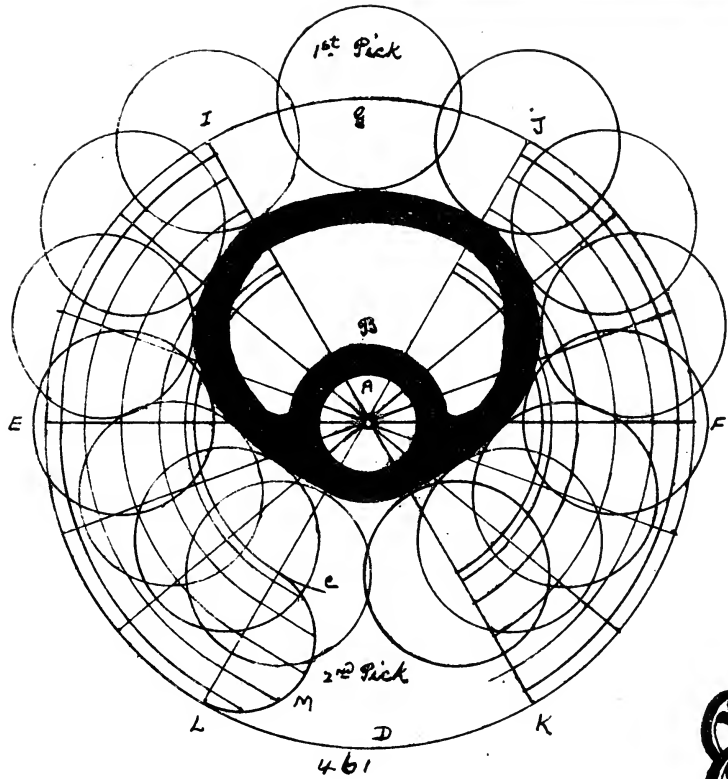

Scale - 1/2 inch = 1 inch.

Particulars for construction - Plain Tappet (up) down.

- ① Nearest point of contact with centre of tappet shaft = 1 inch; generally written briefly N.P.C.
- ② Size of treadle bowl 2 1/2" dia. T.B.
- ③ Stroke of tappet 2" (this equals the distance through which the treadle bowl is moved)
- ④ Dwell one third of a pick.

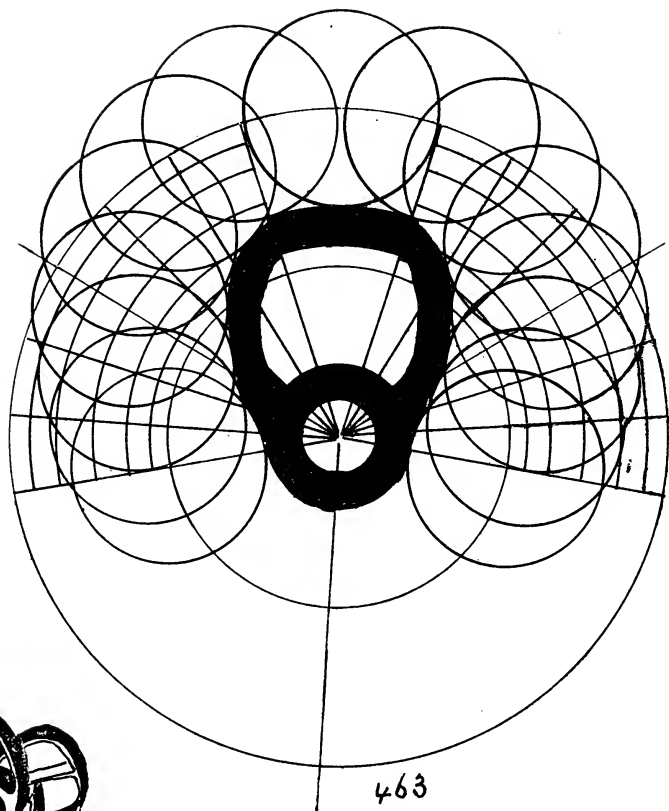

463



464

Scale - half inch = 1 inch
 Particulars for Tappet construction.
 Bend Swell, Tappet under loom. 1 down 2 up
 nearest point of contact = 1 inch
 Size of Treadle bowl $2\frac{1}{2}$ " dia.
 Stroke of Tappet 2 inches - Dwell $\frac{1}{3}$ of a pick.

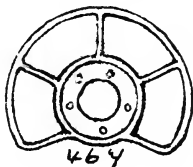
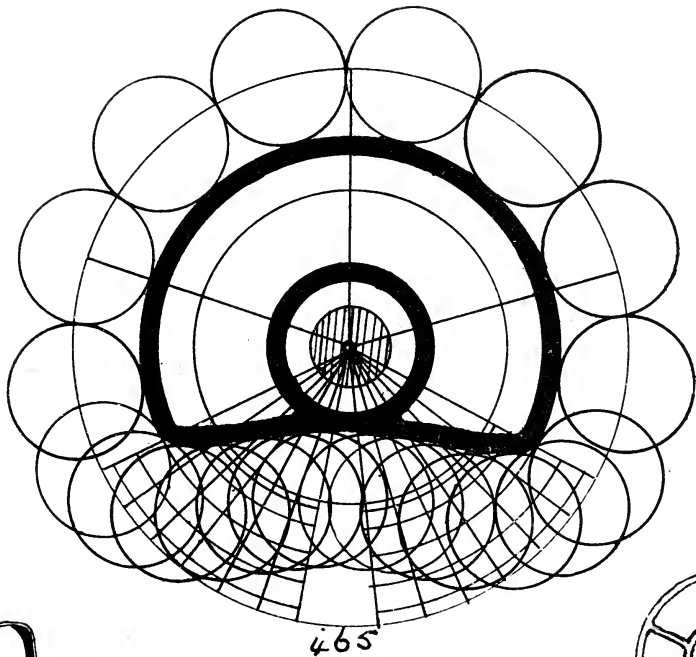

5 end Twill
tappet at the
side of the looms.

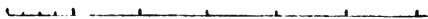

Scale - 5 end Sateen Tappet
↓ down, ↑ up

Tappet under the looms.

nearest point of contact $1\frac{1}{2}$ " inches
edge of Treadle bowl $2\frac{1}{2}$ " diameter
stroke 2". Dwell $\frac{1}{3}$ of a pick.

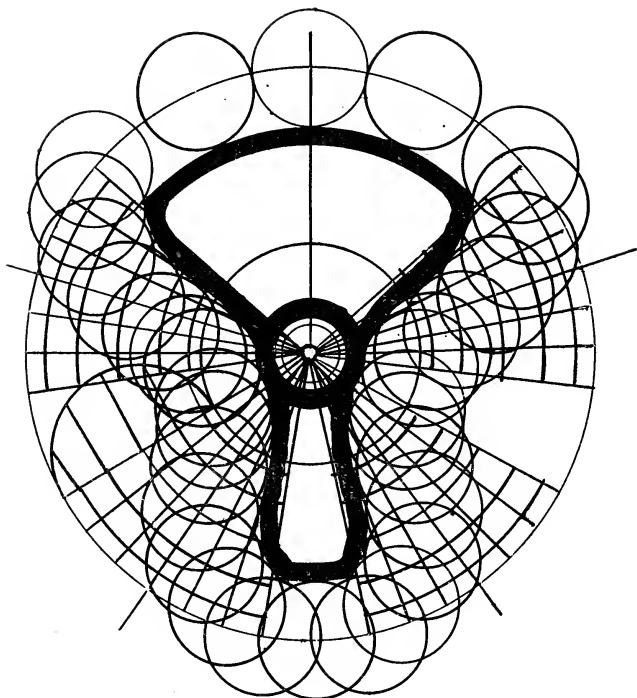

468.

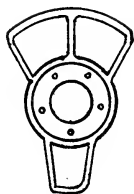

Scale.

The above tappet for a 5 end twill, the pattern is shown in the margin, is constructed to the following particulars. Tappet under the loom. Nearest point of contact with the centre of the tappet shaft 1 inch; Treadle bowl 2 inches diameter. Stroke 3 inches: Dwell $\frac{1}{3}$ rd of a pick.

Scale $\frac{1}{2}'' = 1$ inch.

Tappet under the loom, 2 down 1 up

Nearest point of Contact with the centre of the tappet shaft 1."

Treadle bowl 2 inches diameter.

Stroke 2". Dwell $\frac{1}{3}^{\text{rd}}$ of a pick.

Construct a 3 end twill tappet to the above named particulars



3 end twill Tappet

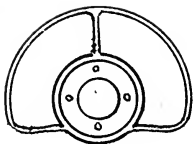

469

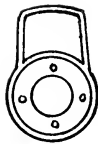

470

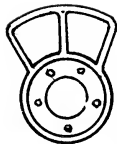

471

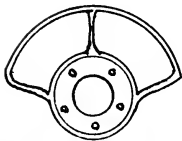

472

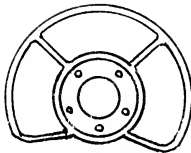

473

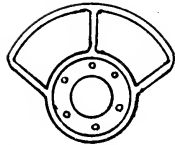

474



475

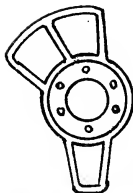

476

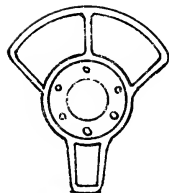

477

Figs 469 to 477 illustrate a number of tappets, the pattern for each tappet is shown beneath it, a leaf or projection on the tappet is represented by a blank on the design paper.

Scale $\frac{1}{2}$ inch = 1 inch

Construct a 2 and 2 Twill Tappet to the following particulars.

Nearest point of contact with the centre of the tappet shaft = 1 inch.

Treadle bowl 2 inches diameter.

Stroke 2". Dwell $\frac{1}{3}$ rd of a pick.



4 end twill
Tappet

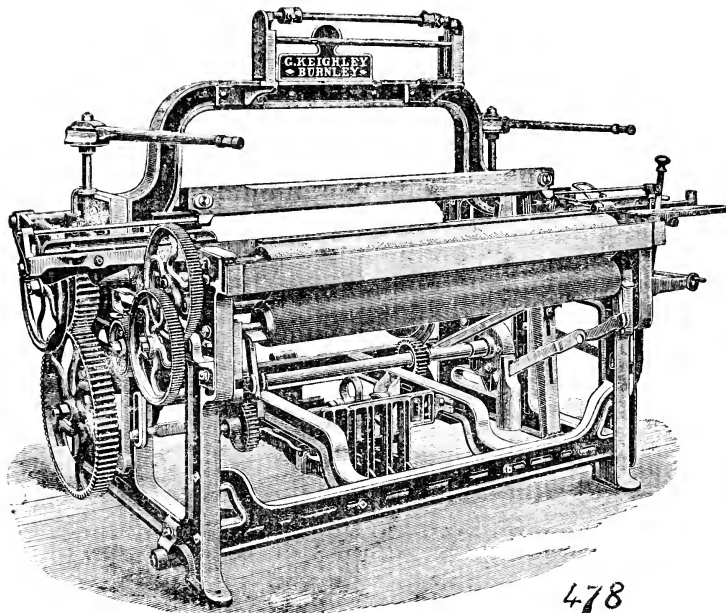

478

DRIVING and SPEED of TAPPETS.

When the tappets are fixed underneath the loom, as illustrated in 478. 479. 480, they are attached to a counter shaft A (see 479 and 480), at the end of this shaft is a wheel B, which is driven by one of three wheels C. D. E, fixed on the bottom shaft of the loom, the number of teeth in the wheels are respectively C 16; D 22; E 24, these three wheels are usually cast in one piece; G 48; H 96. The wheel B, is changed to drive the tappet shaft at the required speed,

Thus, on the principle of Driving and Driven wheels.

For 3 picks to the round $\frac{3 \times 48 \times 24}{96} = 36$ wheel B.

For 4 picks to the round $\frac{4 \times 48 \times 22}{96} = 44$ wheel B.

For 5 picks to the round $\frac{5 \times 48 \times 16}{96} = 40$ wheel B.

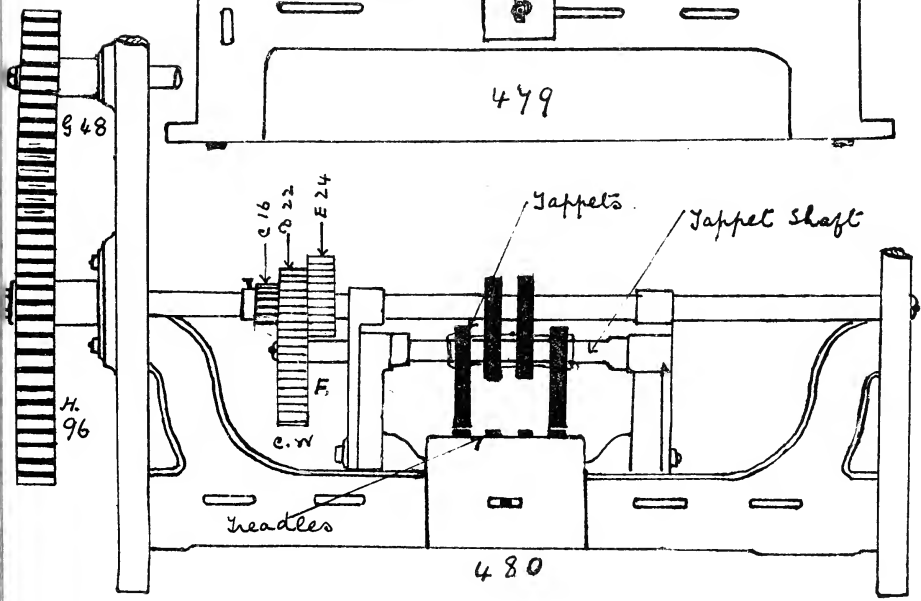
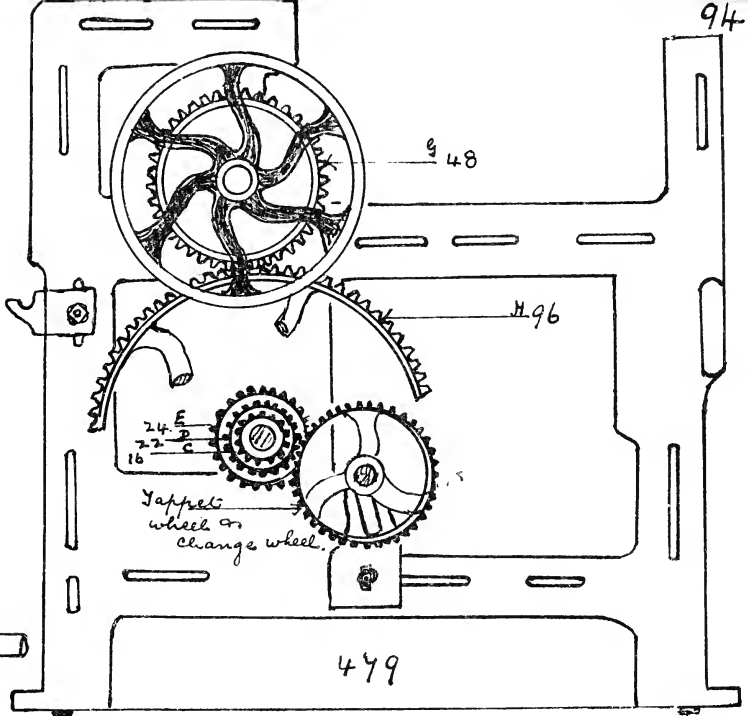

481, 482 and 483 illustrates the arrangement of the levers and treadle when the tappets are fixed at the side of the loom. The term "Cross-rod," or "Yorkshire loom" is generally given to this arrangement. The tappet shaft is extended on the off side, and serves as a convenient stud on which the tappet works, the proper rate of speed is obtained by changing the pinion wheel ^A fixed to the crank shaft, then introducing a carrier wheel ^B, to enable A and C to gear,

with a constant tappet wheel C of 120 teeth, the wheel A of 60 will give 2 picks to the round,
 wheel A " 40 " " 3 " " " "
 wheel A " 30 " " 4 " " " "
 wheel A " 24 " " 5 " " " "
 wheel A " 20 " " 6 " " " "

The tappets are fixed to a long collar which forms part of the wheel C. (see illustration)

If 7 picks to the round are required, 7 does not divide exactly into 120, another tappet wheel must \therefore be used, or "intermediate wheels" must be used. assuming that intermediate wheels are used, and

that a 20 wheel is used for the crank shaft (see sketch in margin) and a 120 tappet wheel, then the picks to the round namely 7 multiplied by the driver wheel A will give the intermediate driver wheel B, $7 \times 20 = 140$ and the driver wheel D of 120, will give the intermediate driver wheel C, namely 120.

The two intermediate wheels are therefore B, 140; C, 120; these wheels are too large for practical work therefore divide them both by 5; C = 24 and B = 28.

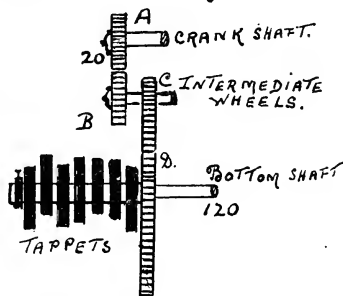

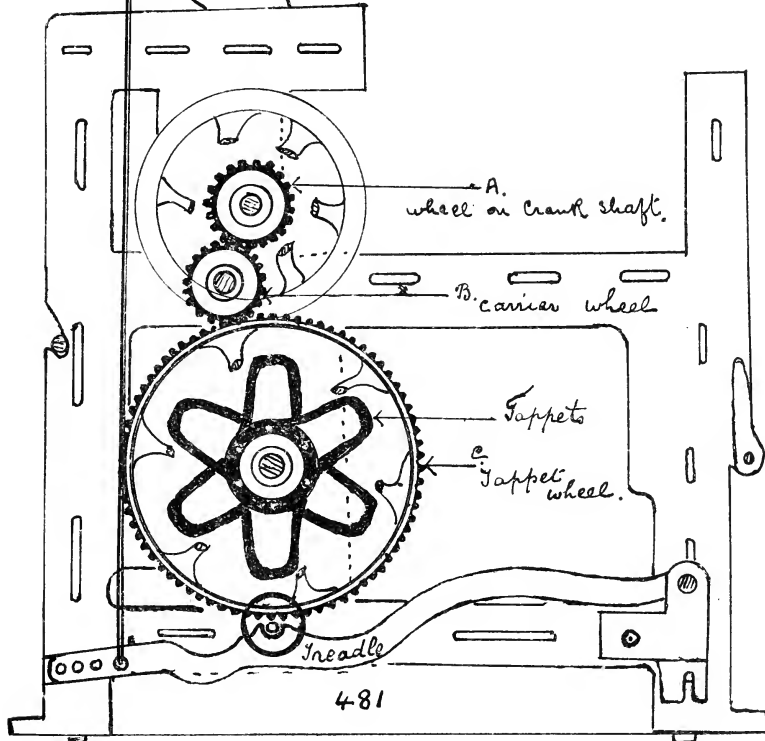
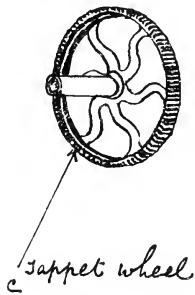
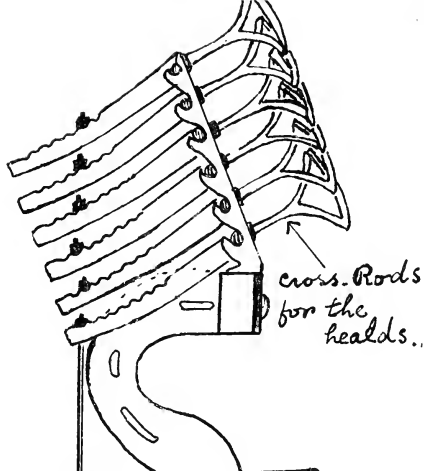

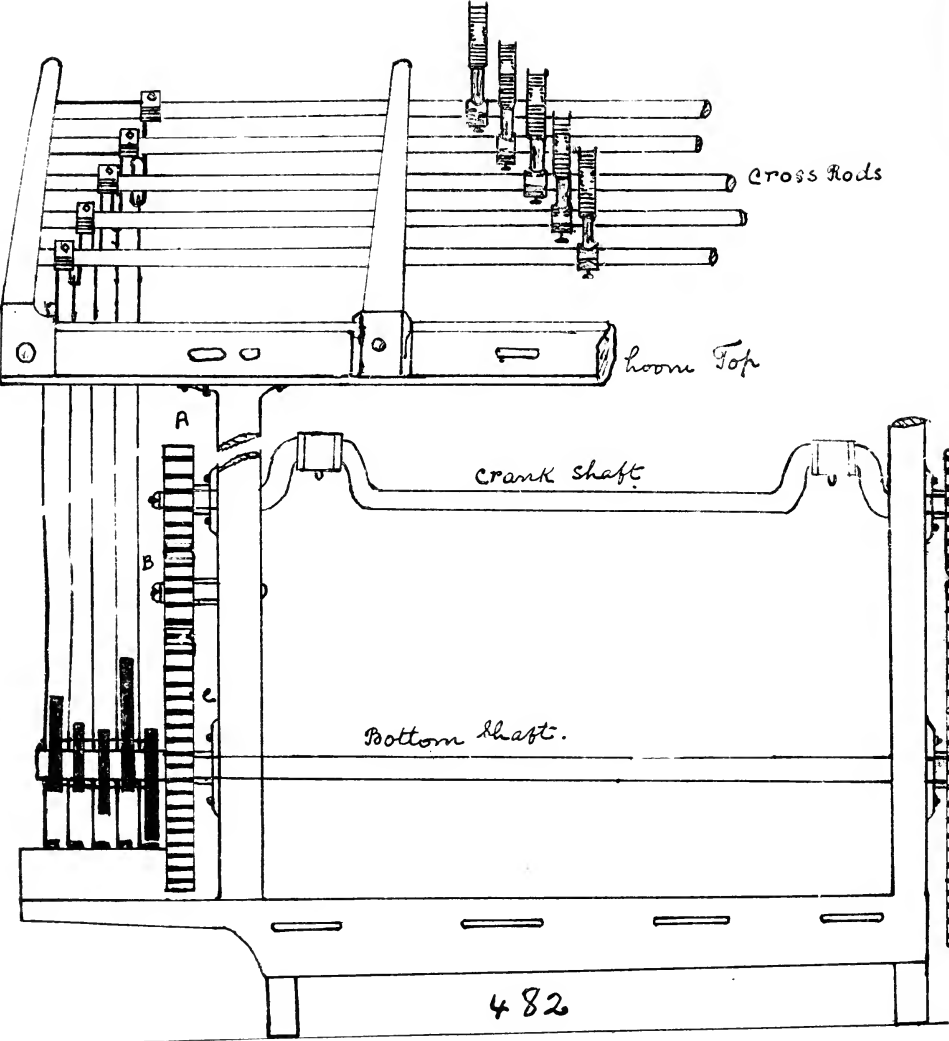

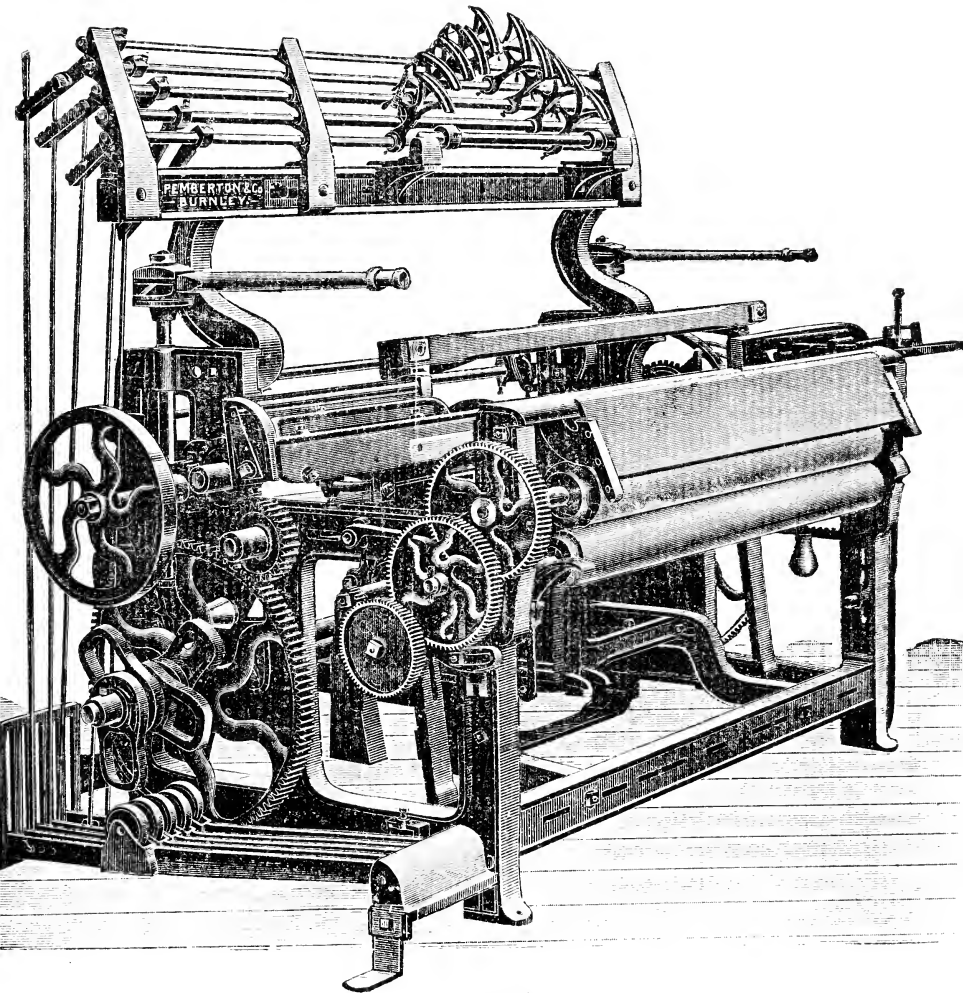

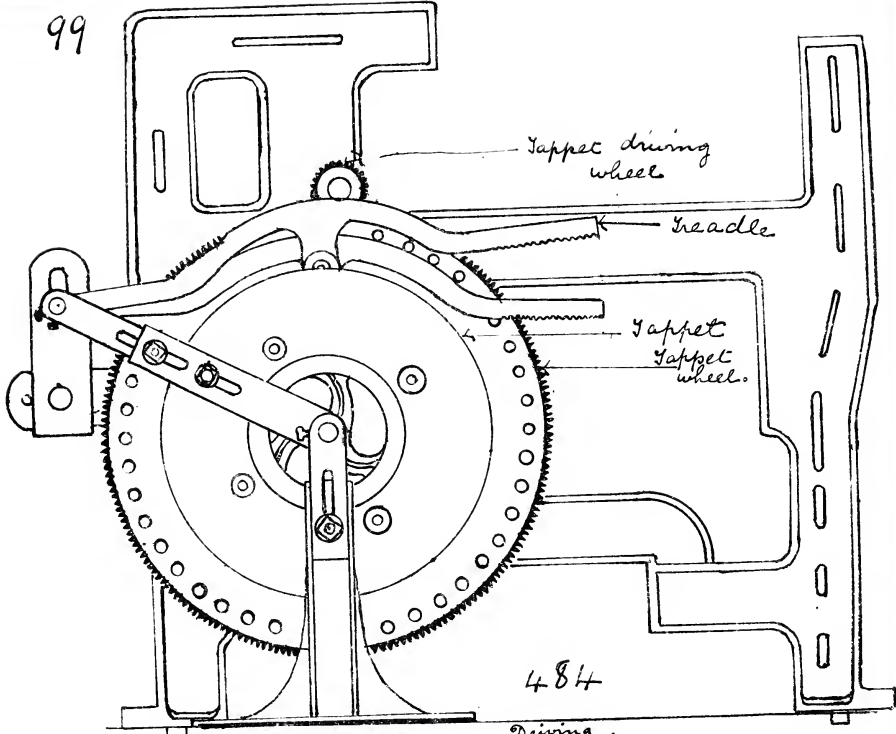

484

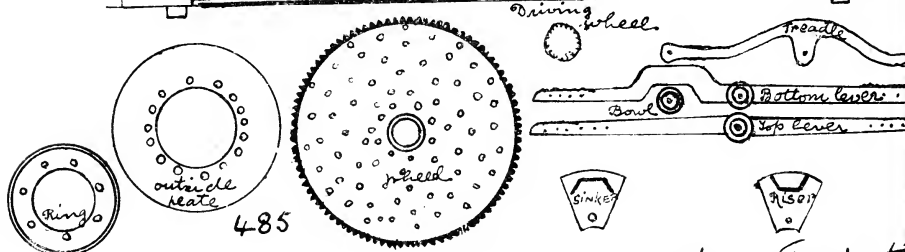

485

Fustian Loom with "Woodcroft Section Jappet."

This jappet is used for heavy cloths, such as Fustians, Conds and Velvets, it is illustrated in 484. 485 (details) & 486. It is made up of small peates or sections termed Risers and Sinkers, these act on treadles, the motion of which is conveyed to levers situated above & below the loom, the healds being attached to the other ends.

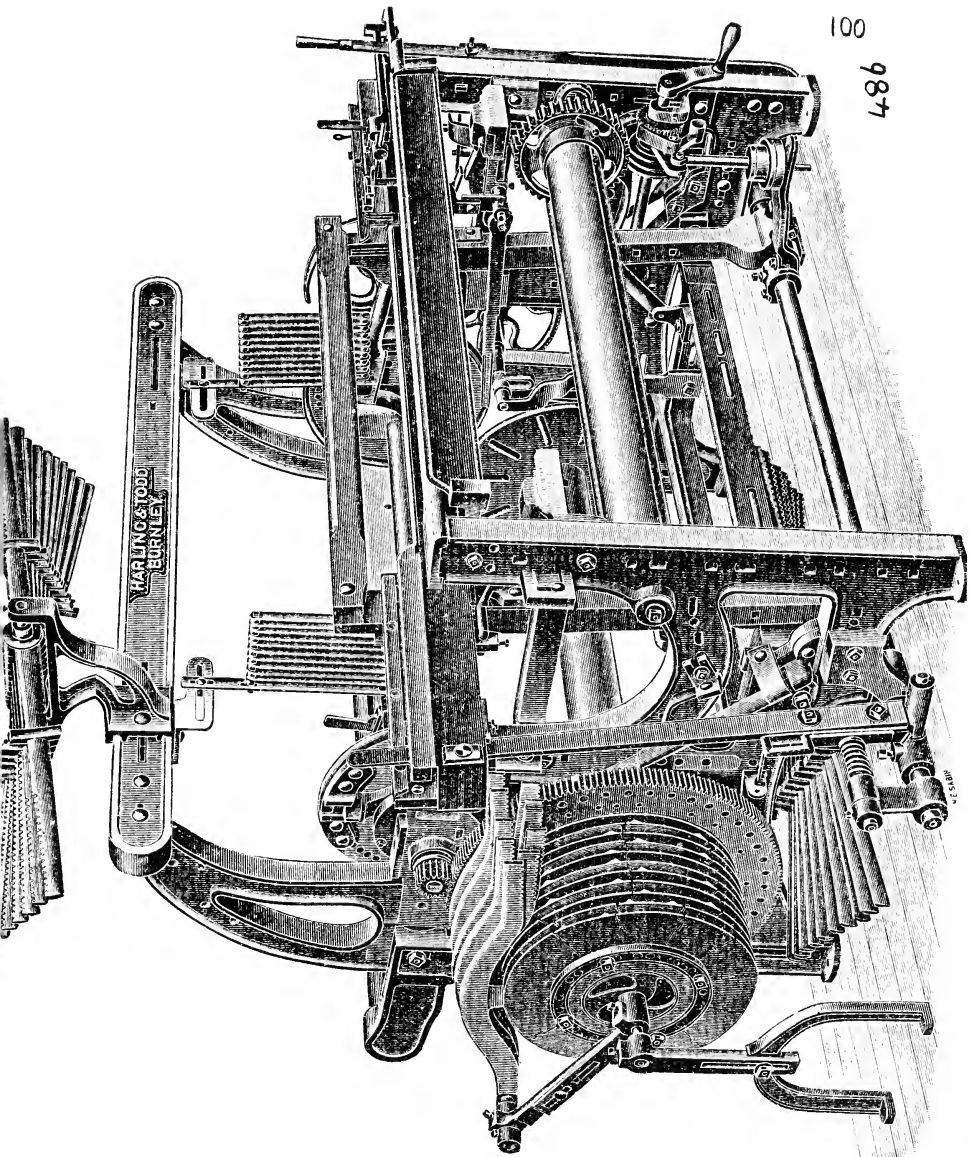

Tappets are sometimes fixed underneath the loom, and spring top motions used for lifting the heads, after they have been lowered by the downward stroke of the tappet. Figs 487, 488 and 489 illustrate the motion. The tappets are built up in sections, and secured to circular plates (see 487) by this means any order of lifting of the heads may be obtained. The tappet is driven from the bottom shaft of the loom as shown in 488; fixed to the bottom shaft is a bevel wheel A, it drives another bevel wheel B, on the same stud as B, is a wheel C driving D; D gears with and drives the tappet wheel E. F are the tappets. C is the change wheel, for altering the rate of speed of the tappet, when changing from one pattern to another. Fig. 489 gives a front view showing the connections of the treadles with the heads, and the heads with the spring-top motion. The reference letters in 488 and 489 refer to the same parts. This form of tappet is sometimes known as Jamison's Barrel Tappet. And when the tappet is fixed on the top of the loom, with springs underneath the loom, it is known as Smalley's Tappets, or as Jepson's Tappet.

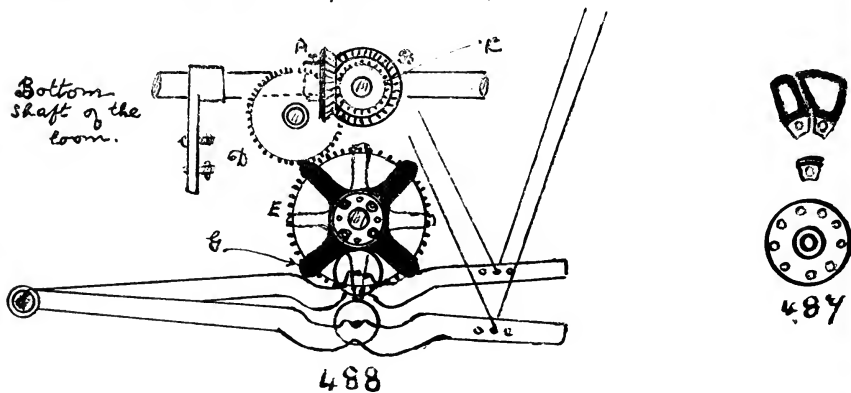

Spring top motion

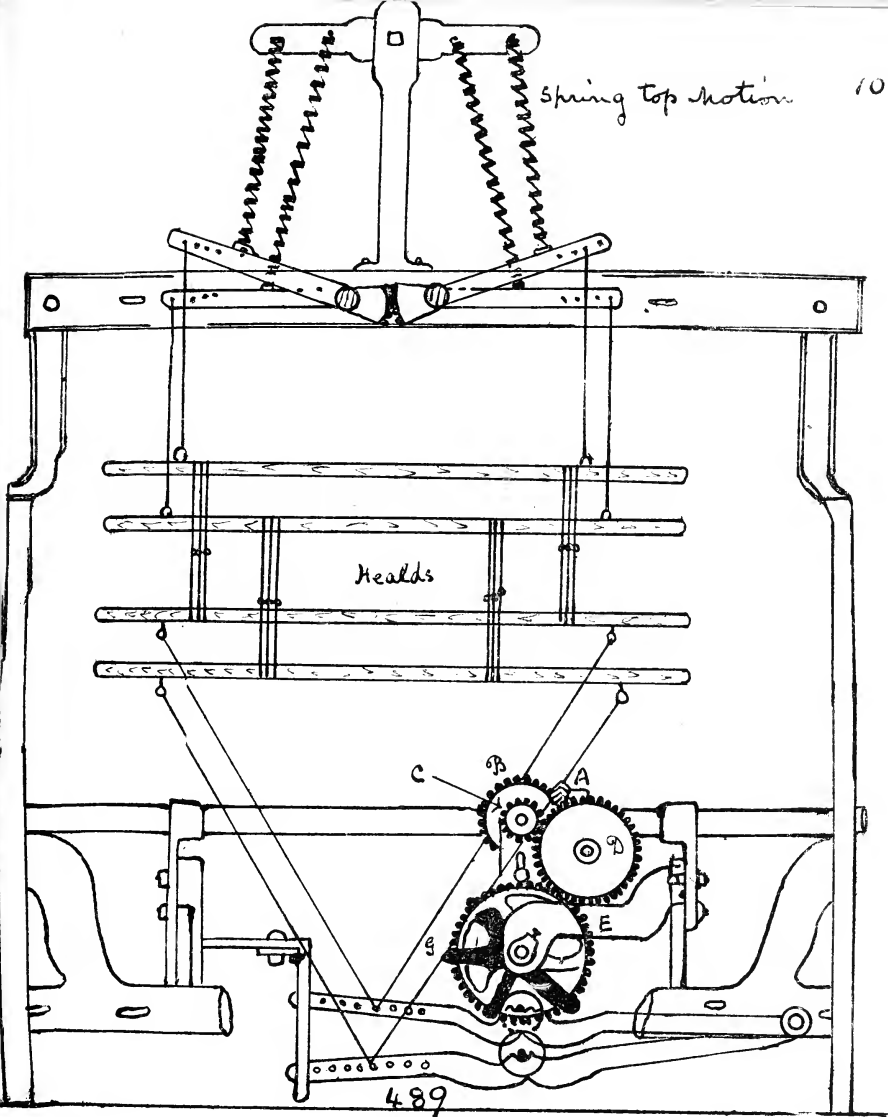

The type of Dobby in most common use in Lancashire and Yorkshire, is the Keighley type of dobbie; patented by Hattersley and Smith in 1868; Since the patent expired, nearly all loom makers have a special construction of this machine, some machinists have made dobbies a speciality notably Heptons or Place, Burnley. The dobbie machine is a shedding motion, used for conveniently working the healds up to 20 shafts, or for Dhooty Borders up to 40. By the aid of pegs placed in a revolving lattice, any heald can be selected and raised by the machine, a peg indicates a heald up, a blank a heald down. Figs 490, 491, 492 or 493 illustrate the machine. In 490, A, is a rod worked from a crank fixed on the end of the bottom shaft of the loom; A is attached to B, with arms E, D, working on the fulcrum C; to the ends of E and D are sliding knives F and G working in the grooves of the framing of the machine; resting over F and G are catches H and I, the ends of these are attached to the upright bar M, N; attached to M, N is the lever Q, with its fulcrum at S, this lever is connected by a link to the "Jack" levers R which carry the healds. U, is the barrel for carrying the lattice V, for the pattern, it is constructed, so that 8 lags are required to go once round it. Resting on the topmost lag are a number of heavy ended levers L, just double the number of what there are levers Q in the machine, the other ends of L, hold up the catches H and I, the catch I is held up direct, and H through the medium J; Y is a ratchet wheel fixed to the end of the barrel; T a pawl attached to E, its uses are to revolve the barrel.

Its action is as follows—: If a lag is in gear without any pegs, all catches I and H are lifted out of the way of the sliding knives, and no healds are lifted, if a lag is in gear with all the holes pegged, all the healds are brought up on the next pick, so that by pegging a lattice to suit a pattern, the healds are lifted to suit the pegs and blanks in the lattice, and any order of lifting for any heald can be obtained.

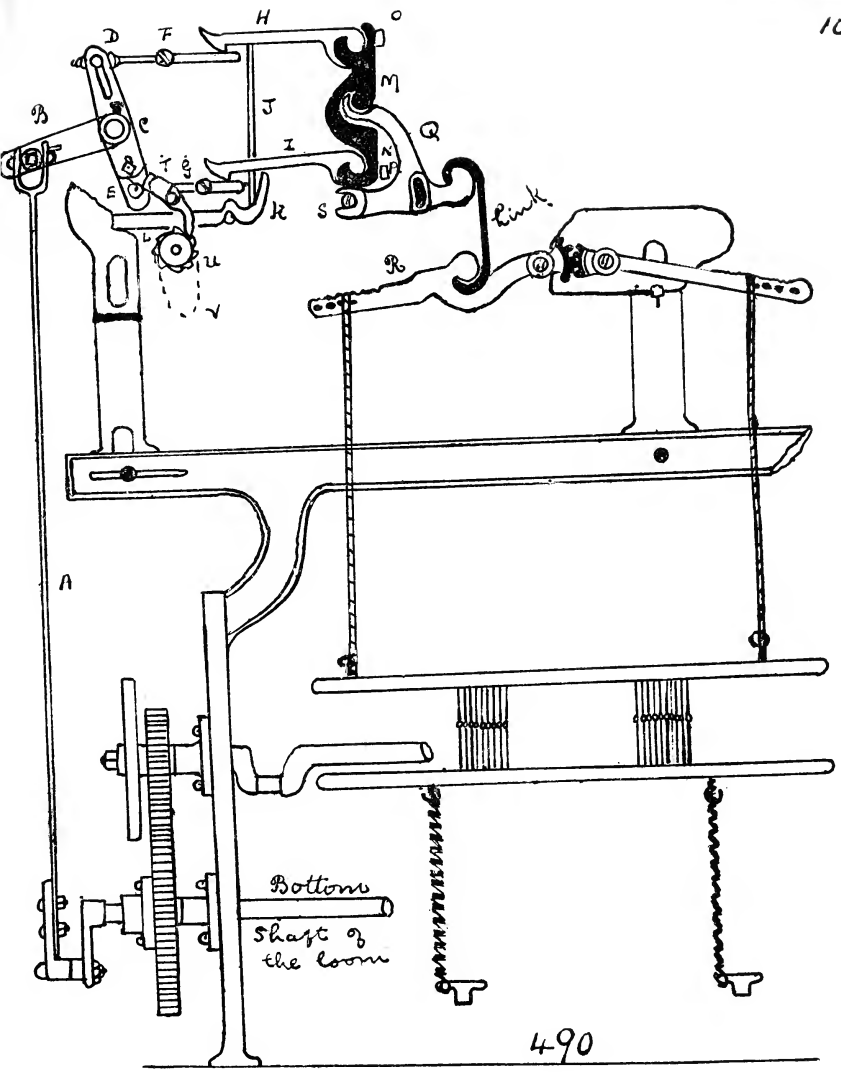

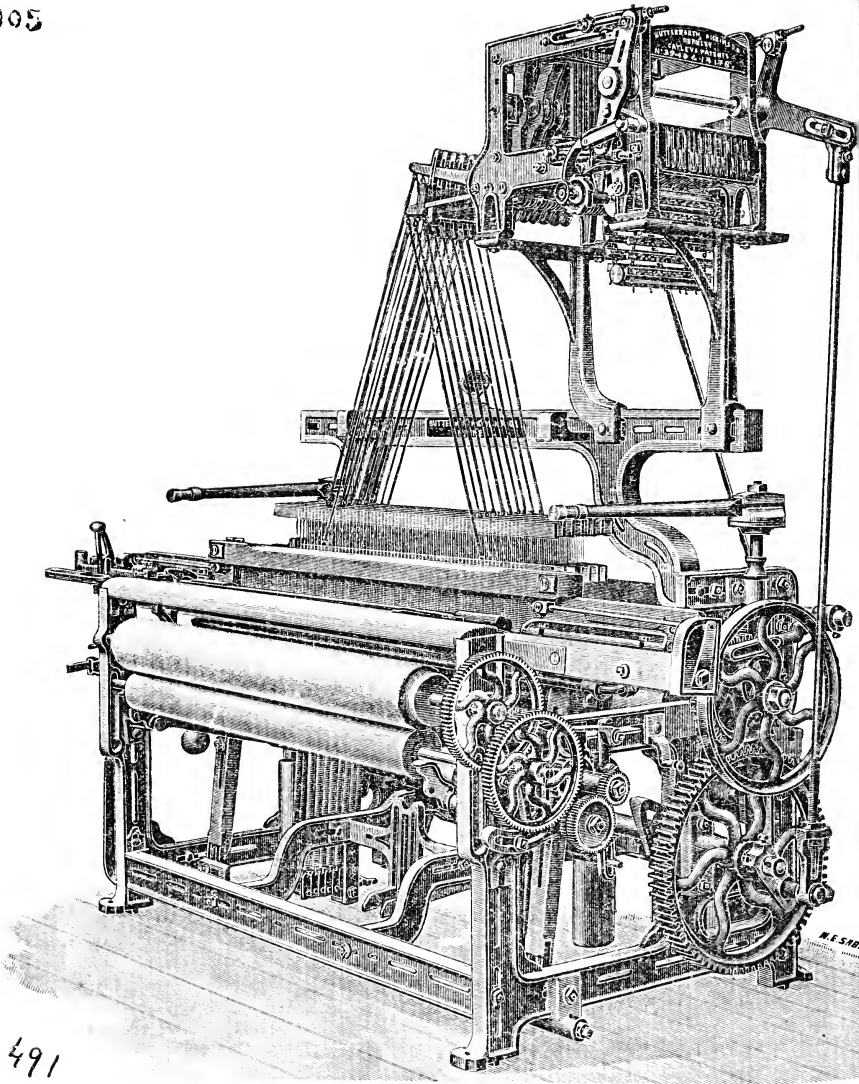

Two Barrel Dobby.
 on Weaving.
 Towels, Handkerchiefs,
 and cloths of like
 character. The Barrels
 are automatically
 changed when
 the cross border
 is required or
 can be changed
 by hand if
 required.

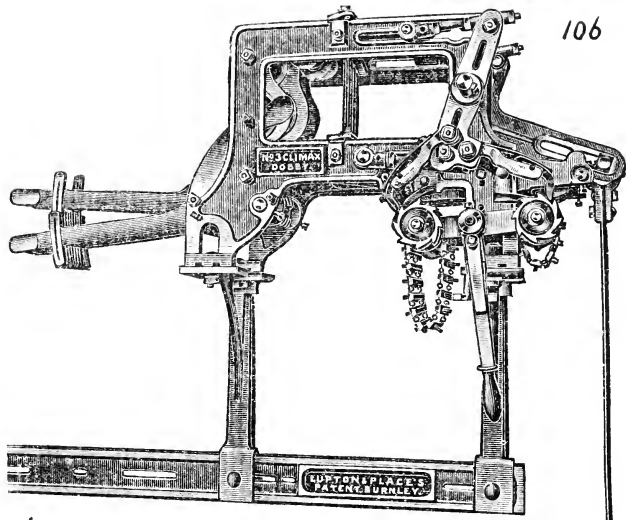

492

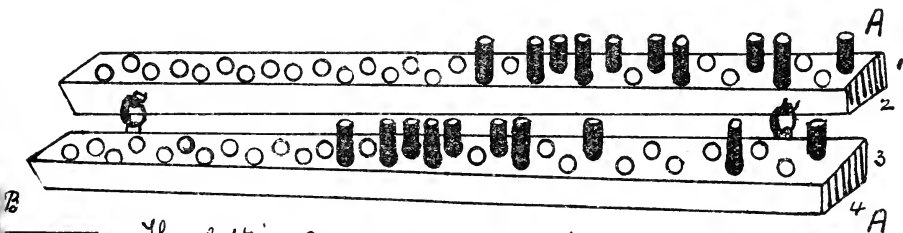

The lattice A shows the pegging of the
 pattern A for a "Right hand Dobby"

The lattice B shows pegging for the
 pattern B. for a "Left hand Dobby".
 The 2nd row is pegged for the 1st pick.

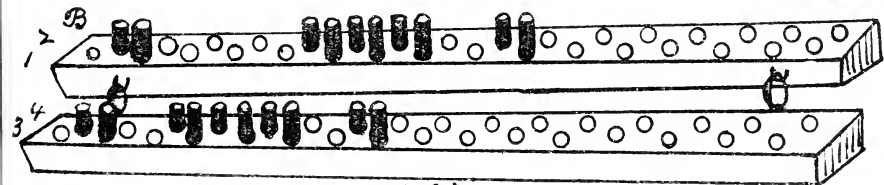
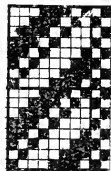

493

PICKING - THE CONE PICK -

after the separation of the warp threads by the healds, the shuttle, carrying the weft, is thrown across the loom, between the separated threads, this action is termed "picking". There are two methods of picking in common use, namely "Cone Pick" (Overpick) and "Underpick".

The cone pick is the most extensively adopted for quick running looms, 494 and 495 illustrate parts of the motion; the index letters refer to the same parts in both sketches. Fixed to the bottom shaft (B) of the loom, are two picking plates C, one on each side of the loom, they are made up of the "boss" which is keyed to the shaft, and the "shell" A, which is fixed by means of bolts to the boss, (this allows the position of the shell to be altered, so as to pick sooner or later; the "nose-bit" D, which is bolted to the shell; fixed to the loom side is the upright picking shaft; projecting from F and resting in contact with the picking tappet is the short lever E, termed the "picking bowl"; on the top of the picking shaft is the box G, it is made up of two parts, the surfaces which are in contact are furrowed, the top part holds the "picking stick" H, the whole is then firmly secured with a large bolt, the furrowed surfaces prevent the position of the picking stick from altering by the repeated blows given to the shuttle; at the free end of the picking stick is fixed the "picking band", which in its turn is fixed to the picker, the picker slides freely on the spindle in the shuttle-box. As the bottom shaft revolves, the nose-bit D strikes the picking bowl E, and turns the picking shaft part way round, this action moves the picking stick towards the inside of the loom and throws the shuttle. Just commence picking with crank at bottom.

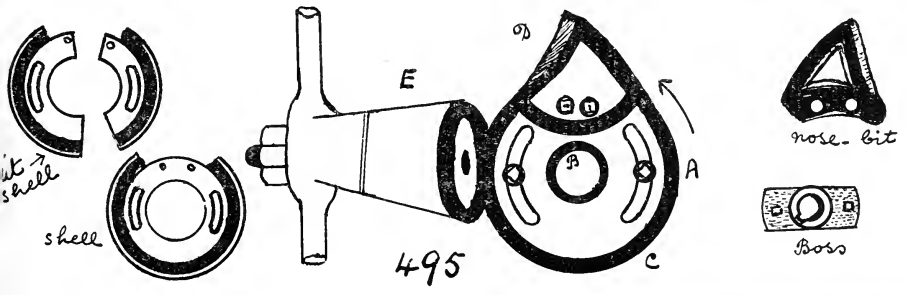
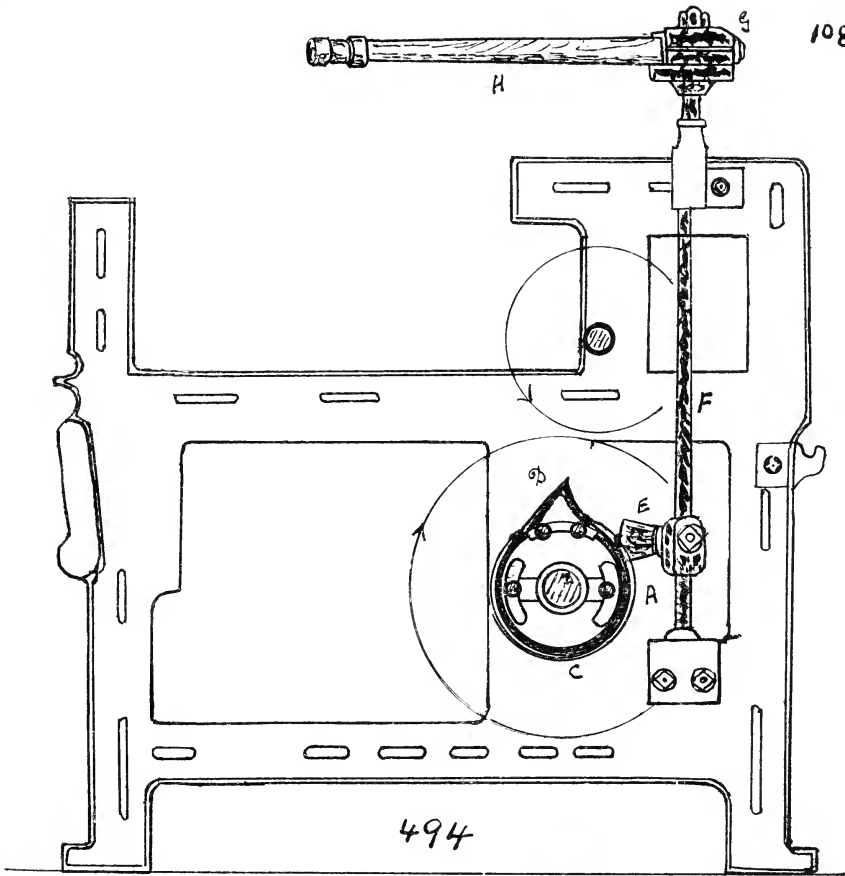

THE UNDERPICK.

This picking motion is illustrated in Figs. 496, 497, 498 and 499. 496 gives a front view and 497 a side view; 496 illustrates the end of the loom shown in 499, and 497 illustrates the end of the loom shown in 498. In 497, A is the bottom shaft of the loom, to which is fixed a short arm B; to the end of B is fixed a bowl C; D is a wood lever shod with iron at E; the fulcrum of D is at F; the free end of D passes over, and rests in contact, with a short lever G, at the foot of the picking stick H, (seen much better in 496) the picking stick H, passed up through the shuttle box I; the lower part of H is fixed to J, which forms part of the rocking rail of the loom. Refer now more especially to 496, the picking stick is fulcrumed at K; G is held up by means of the spring L; M is a short strap attached to the picking stick, the other end is fixed to the slay sword, this prevents the picking stick from going against the end of the box; the slay sword on to the upper end of the picking; and inside the shuttle box I is the picker.  This shows a plan of the picker. On the driving side of the loom see 496 and 499 the striker bowl C is fixed to the bottom shaft wheel. Its action is as follows. For every revolution of the bottom shaft, the bowl C strikes D, forcing it downward (see 497) this motion is communicated to G (see 496) and the picking stick working on the fulcrum E, moves towards the inside of the loom, and throws the shuttle. The spring L then comes into action, and lifting up G takes the picking stick back to the end of the box, no spindles or picking bands.

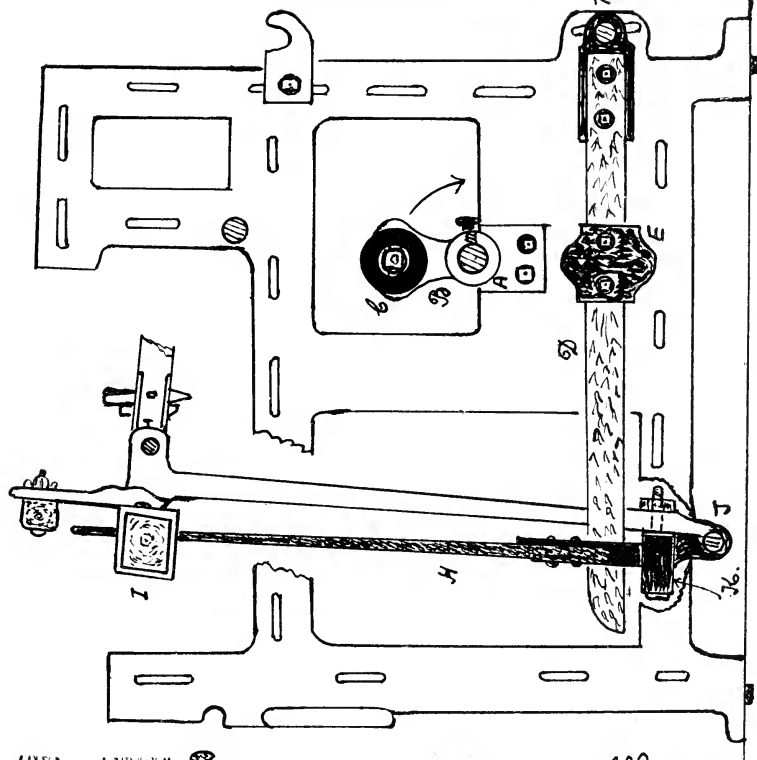

49Y

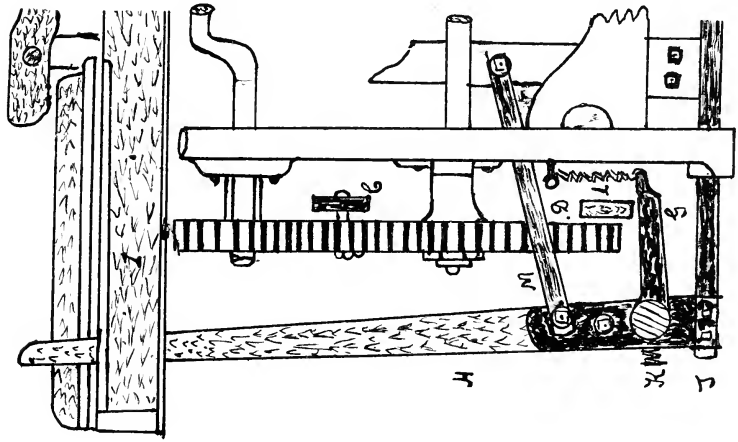

496

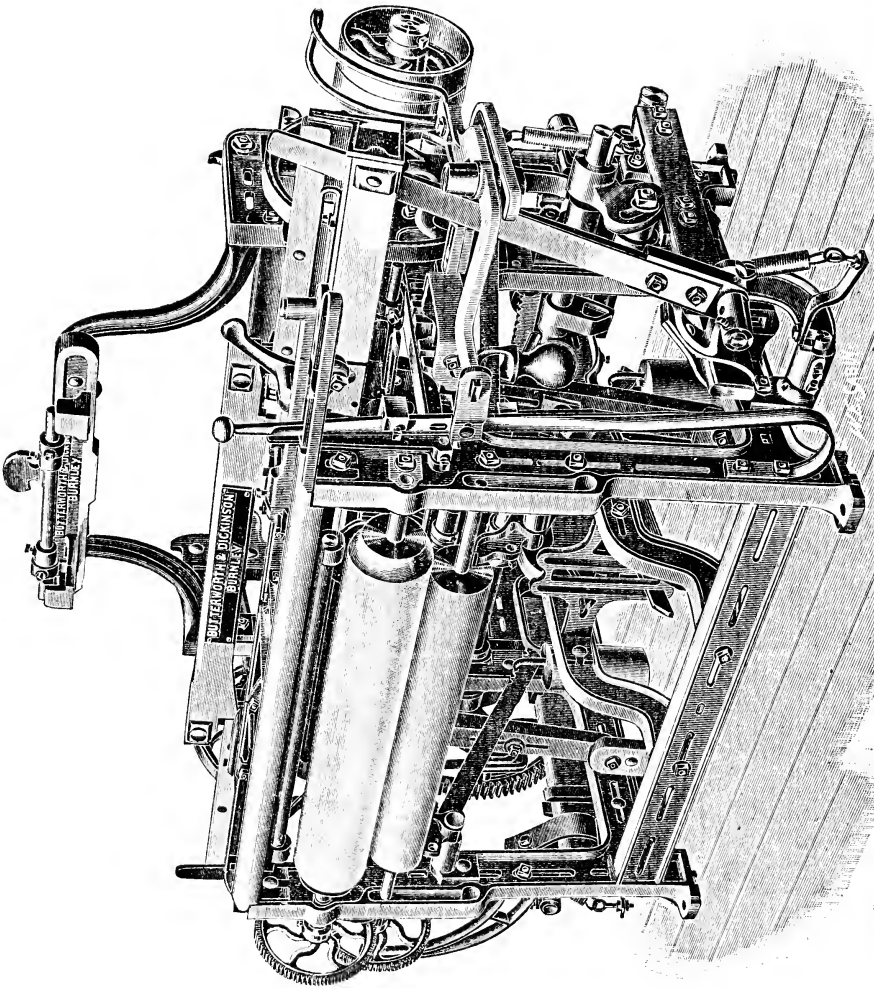

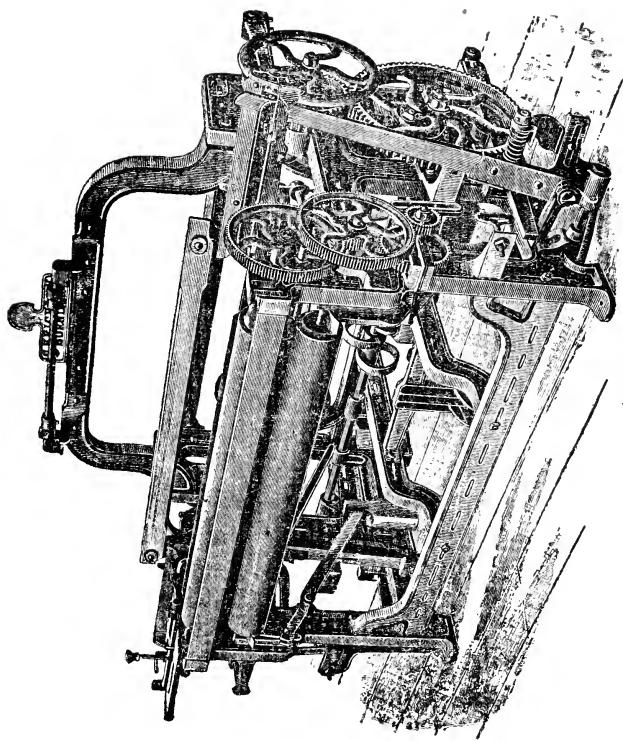

499

Beating-up.

The reed serves the double purpose of guiding the shuttle and beating up the weft; this last operation is termed "Beating-up". Fig 500. the slay to which the reed is fixed is not uniform in its motion, it moves quickly when beating up takes place, and slower when the reed is away from the fell of the cloth, and the shuttle moving from box to box, this variation in speed is for the purpose of giving more time for the shuttle to move across the loom, whilst the bottom shed is in contact with the shuttle race; and as the slay moves quicker when beating-up, the extra speed gives additional force to beat up the weft.

501 gives a graphic illustration of the movement of the slay, during one complete revolution of the crank; with a 10" crank arm and a 5" sweep. Let $F.B.$ = slay sword 26" and $C.E$ the sweep of 5", bisect $C.E$ at G , draw a line $D.J$ at right angles to $F.G$: at 10" less $2\frac{1}{2}$ " namely $7\frac{1}{2}$ " from D on the line $D.J$, namely at I will be the centre of the crank shaft; from I as centre describes the circles $L.K.M.J$. which equals a circle described by the crank in one complete revolution.

To prove by means of this diagram that the motion of the slay is eccentric, assuming that the motion of the crank is uniform, it will describe equal spaces in equal times. When the slay is at D the crank is at h . (prove these measurements) as the slay moves to C , the crank is at K , when the slay moves back to D the crank is at M , and the space $L.K.M$ is less than the space $M.J.L$, therefore, the slay moves quicker when beating-up. The eccentricity is increased, by shortening the crank arm, or giving a greater sweep. The slay-swords are set perpendicular, when the reed is to the fell of the cloth. The slay is slightly hollow and rounded in the centre, to show the reed a little ^{back} in the middle.

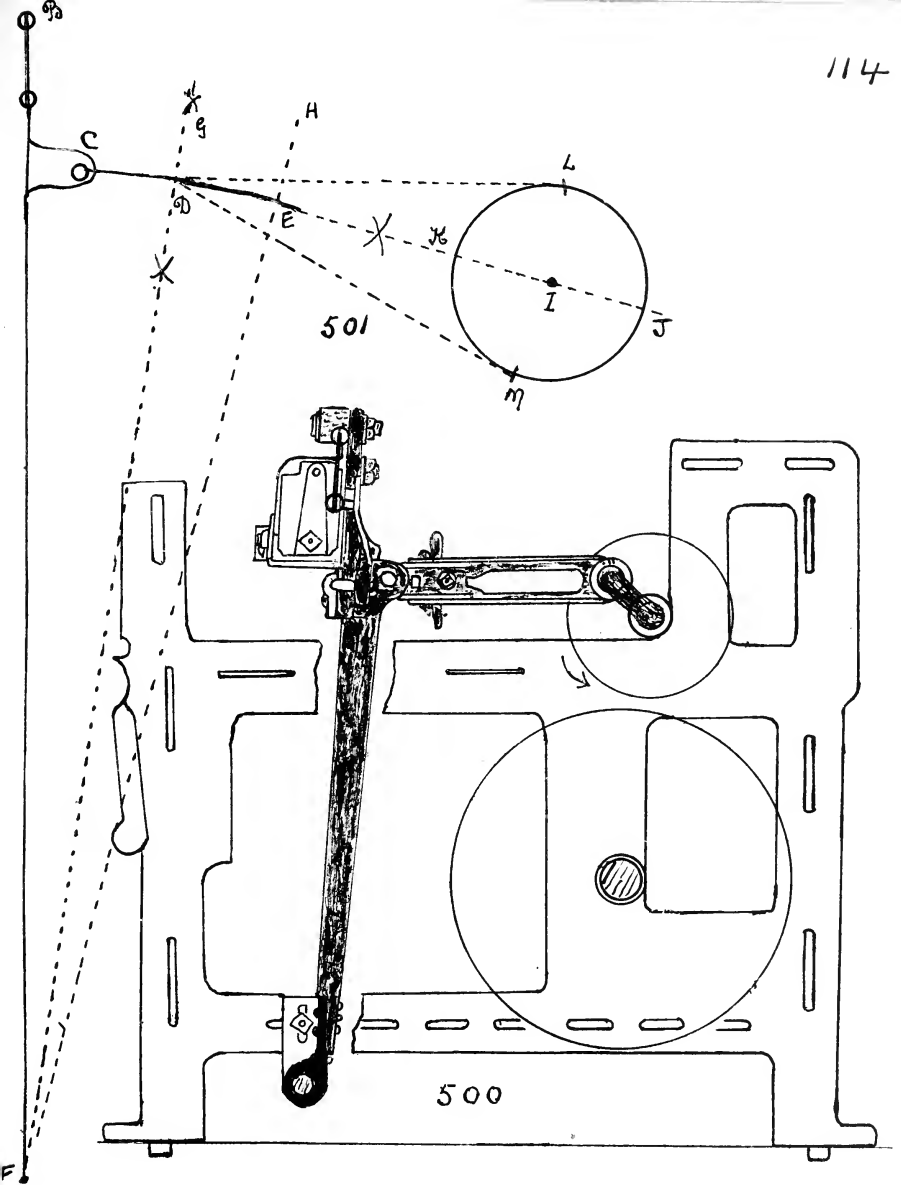

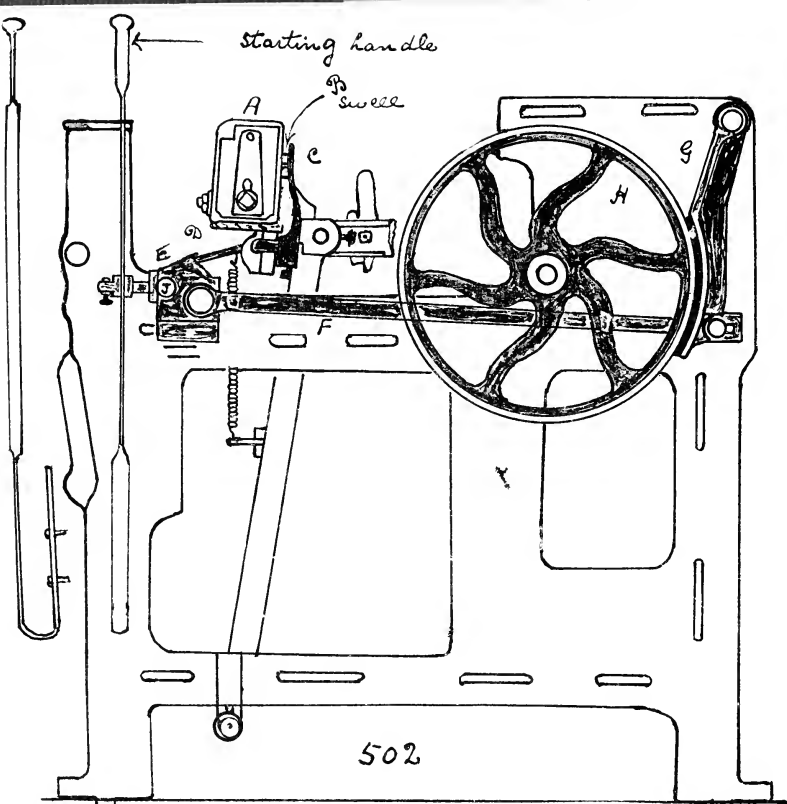

Fast reed loom - Stop-rod and Back-brake.
 when the shuttle stops in the shed, some provision must be made to stop the forward motion of the reed; this is shown in 502; each time the shuttle enters the box A, the swell B is pushed back, this action forces back the finger C, and lifts the tongue D clear of the frog E. If D strikes E the loom suddenly stops. E is free to slide on the loom side, and in doing so, (through the connecting rod F) the Back-brake G is brought into sharp contact with the brake wheel H; a pin J on the frog, pushes the starting handle out of position and stops the loom.

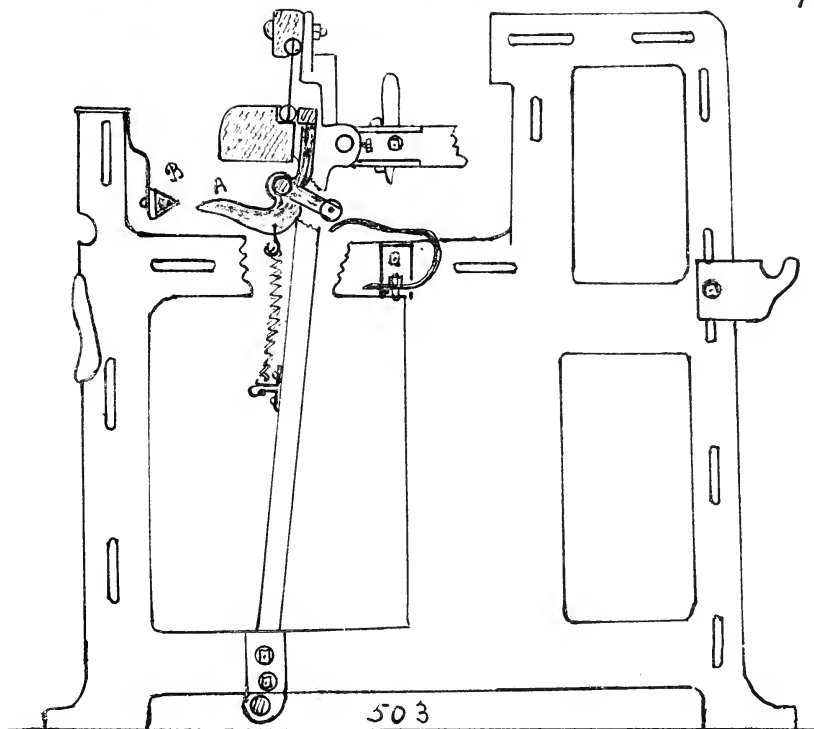

503

Loose reed loom.

503 & 504. In this loom, if the shuttle is caught in the shed, the reed gives way. The index letters are the same in both figs. Under ordinary conditions the lever A passes under the heater B, at each beat up and holds the reed firm, 503. If the shuttle is trapped, 504, the reed gives way, A passes over B, and C is lifted and striking the starting handle knocks it out of position & stops the loom.

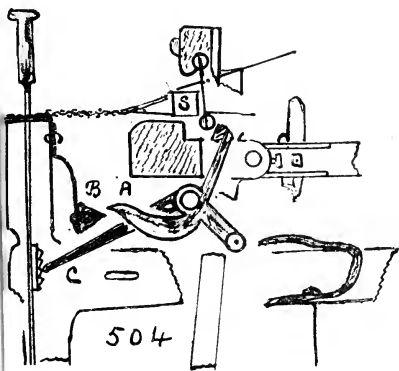

504

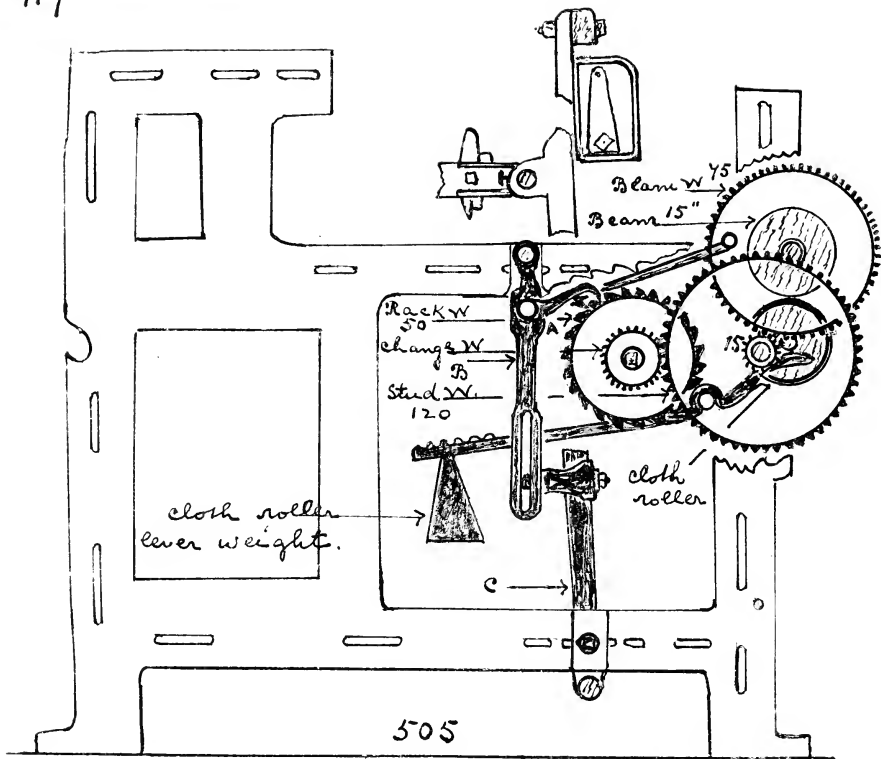

The Old Take-up Motion.

505, The work of a Take-up motion, is to pull the cloth forward as it is woven, and to wind it on to a roller, and also to regulate the picks per inch. It consists of a train of wheels operated by a pawl A, lever B, these are worked from the slay sword C. The Dividend is obtained thus

$$\frac{\text{Rack W. } 50 \times \text{Stud W. } 120 \times \text{Beam W } 75}{\text{Pinion } 15 \times \text{Cir. of Beam in } \frac{1}{4} = 60} = 500$$

$$500 + 1\frac{1}{2}\% \text{ for contraction} = 507.$$

$$\text{And } \frac{\text{Dividend}}{\text{change wheel}} = \text{Picks per } \frac{1}{4} \text{. or } \frac{\text{Dividend}}{\text{Picks per } \frac{1}{4}} = \text{change wheel.}$$

Teeth

- | | |
|--|------------------------|
| 1. Beam wheel. 89 | 8. Swing bracket. |
| 2. Carrier wheel. 90 | 9. Rack W. fixture |
| 3. Change wheel. | 10. Taking-up lever. |
| 4. Swing Pinion W. 24 | 11. Monkey tail. |
| 5. Standard wheel. 36 | 12. Taking-up catch |
| 6. Rack wheel. 24 | 13. Retaining catch. |
| 7. Swing or Quadrant | 14. Carrier wheel Stud |
| 15. Circumference of beam = 60.2 quarter inches. | |

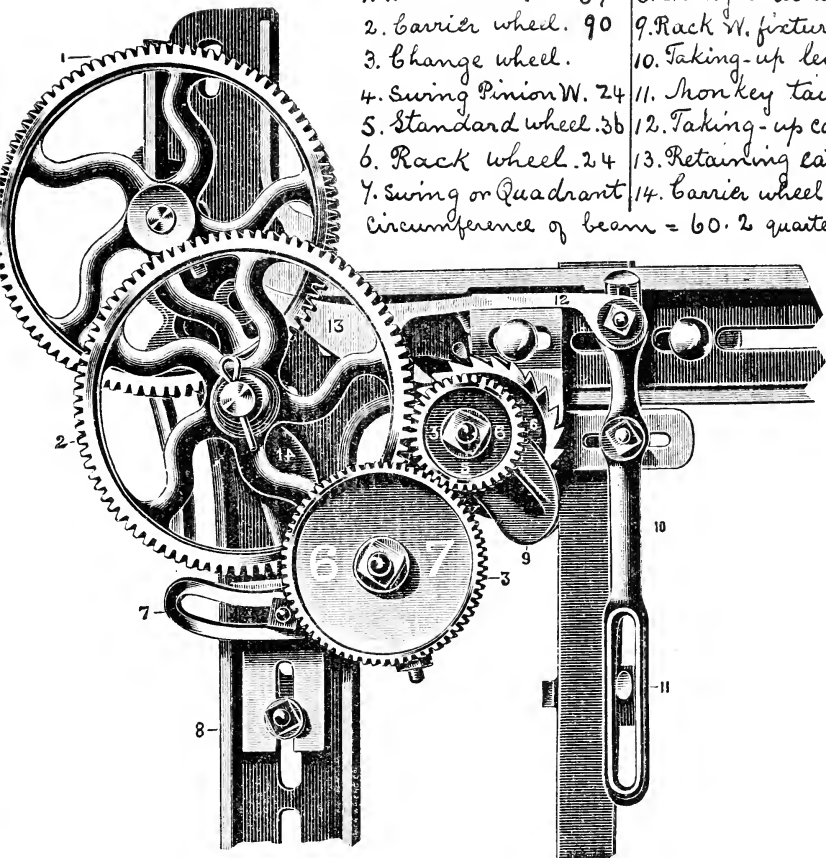

Pickle's Take-up Motion.

In this motion 506, if a 36 standard wheel is used, then, the number of teeth in the change wheel, represents the picks per inch put into the cloth, in the illustration 64 represents the picks per inch; on the change wheel divided by 4 = Picks per 1/4". with a Standard w. 24, then 3 teeth = a pick. With a Standard w. 18, then 2 teeth = one pick.

When the west breaks, there must be some means of stopping the loom, otherwise a lot of time would be wasted, and the arrangement shown in 504 is for the purpose of stopping the loom when the west breaks. Fixed on the bottom shaft A, of the loom, is a small tappet B; C, E, form a lever with the fulcrum at D, the part E is known as the hammer; resting on the top of E is the fork G. (see also 508) with its fulcrum at F. Its action is as follows, on each pick if the west is present, the prongs of the fork are prevented from passing through the grid^N (509) due to the west being drawn across it, and the sneck end is tilted up, just at the same moment that the tappet B comes into action with the lever C; if the west is absent the fork does not move, and the notch in the top of the hammer E engages with the sneck in the fork, and pulls the fork back; this action is more clearly shown in a plan view 510 A, the fork; B, the fork holder; C the west fork lever, with fulcrum at F; D, the starting handle resting in the notch in the frame-work of the loom, when the west fails and the fork remains down, the hammer draws it back ↓, this action pulls the starting handle out of the notch and stops the loom.

West-fork brake. For the purpose of stopping the loom, by the time it has run two picks after the west fork has acted, a brake is used as shown in 504, H is a bell crank lever with fulcrum at I (see 511) it is held up by the starting handle, and holds brake (leather covered) away from brake wheel J, when the west fork acts M falls down, and the brake acts.

The Tandemite West fork introduced by Thomas Pickles Burnley, has many advantages, it does not require to pass so far through the grid, it is more sensitive, and by using a rubber glove for one of the prongs, and a cat-gut grid, the most delicate west can be woven, with a minimum breakages



509

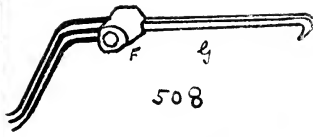

508

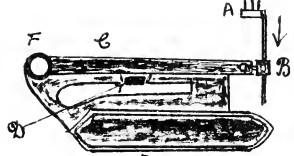

510

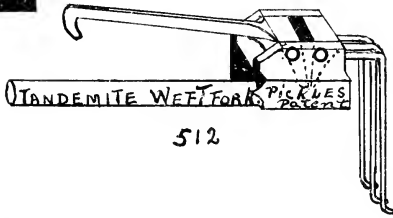

512



511

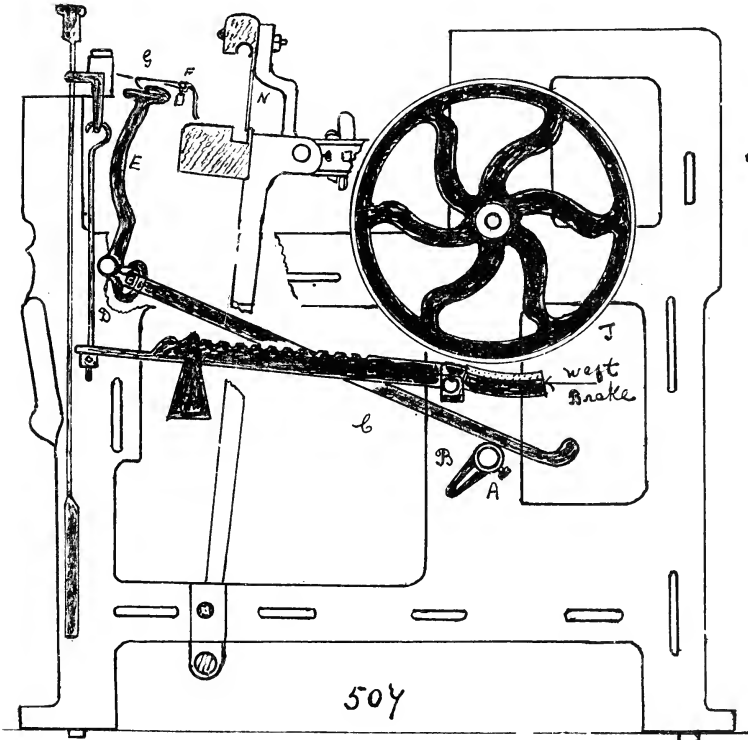

504

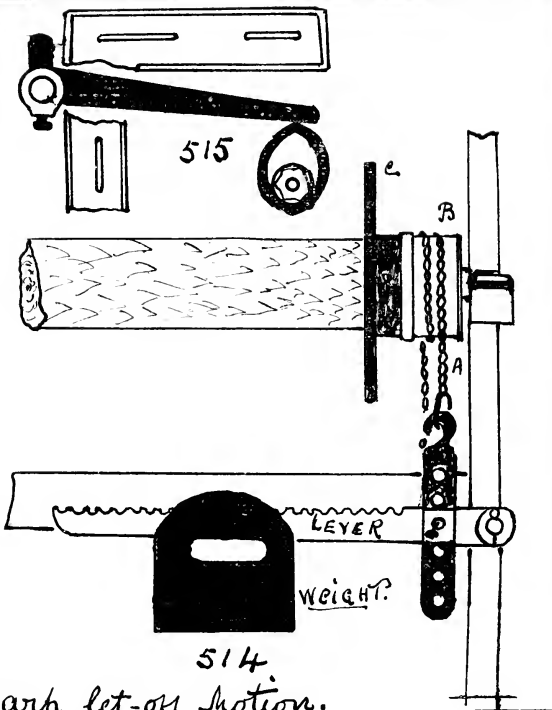
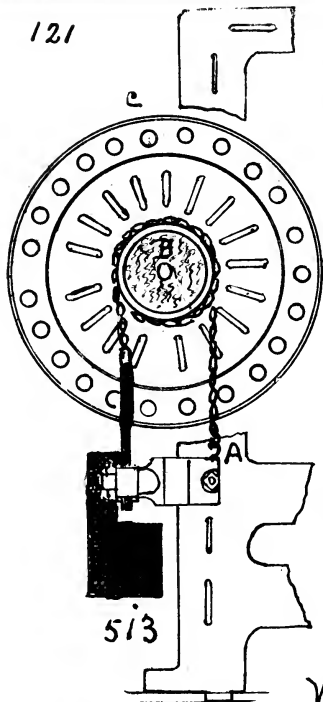

Warp let-off motion.

The simplest form of "let-off motion" and the one in most general use, is the weight and lever as shown in 513 and 514. Fig. 513 gives an end view showing a chain A passing round the collar B of the weaver's beam C, one end of the chain is secured to the loom framing, the other end is connected to a lever and weight; (see back view 514) by moving the weight along the lever, the tension on the warp can be increased or diminished. Fig. 515 illustrates the "vibrating back rest" it is worked from an eccentric and lever from the crank shaft: it tightens the warp when beating-up, and slackens it when the shed is made.

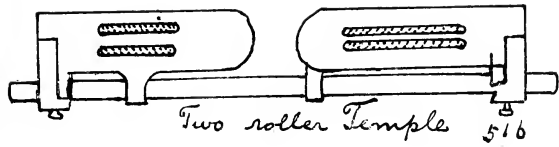

Two roller Temple 516

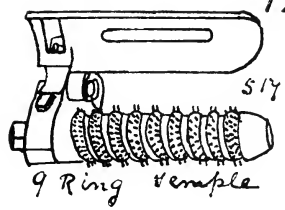

9 Ring temple 517

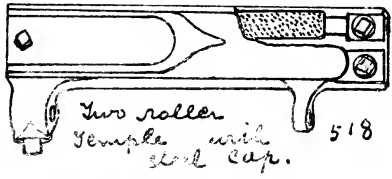

Two roller Temple with stock cap. 518

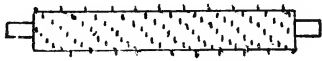

Temple roller. 520

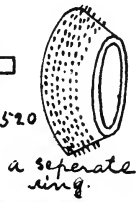

a separate ring.

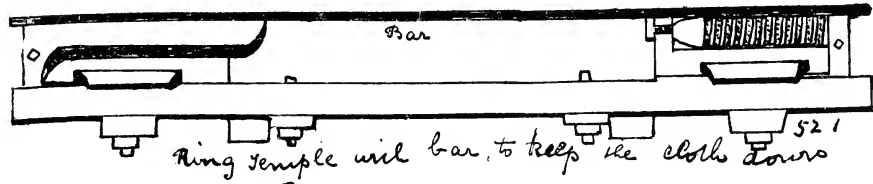

Ring temple with bar, to keep the cloth down 521

Temples

Temples are used for keeping the cloth stretched in the width in the loom also to keep the cloth well down. There are various kinds the principal makers are Hupton Bros. Accrington and Blegard Sons. Padikham

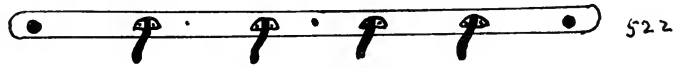

522

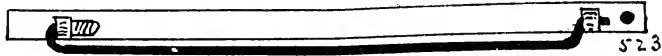

523

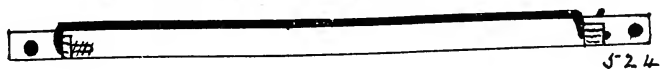

524

Shuttle Guards, are arrangements fixed to the slay cap, to prevent the shuttle from flying out of the loom! 522, shows a fixed guard, of projecting fingers fixed to the slay Cap. 523 movable guard in action. 524 out of action.

123 Shuttle-box details

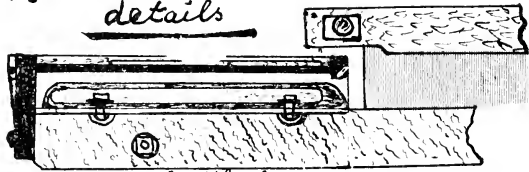

front of Shuttle-box

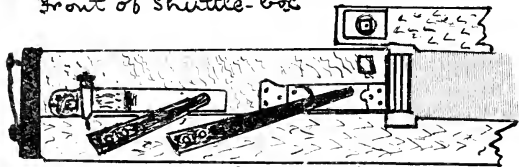

Back of shuttle-box
loose need loom.

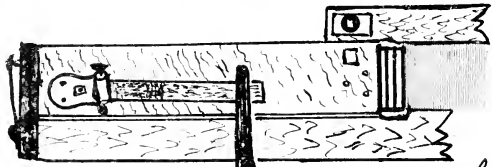

Back of the shuttle box
Fast need loom.

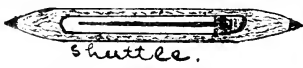

shuttle.

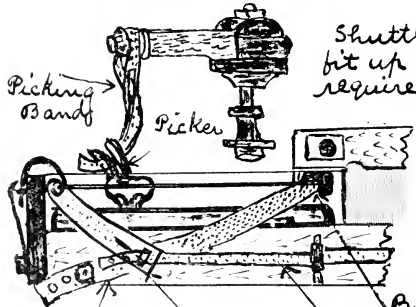

Picking Band

Picker

Shuttle boxes
bit up with the
required leather.

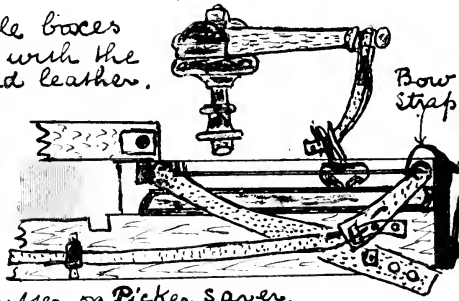

Bow Strap



Box front.



Box bottom



spindle



spindle
stud



Box
end.

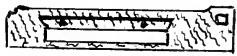

Box back



Picker

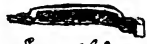

Swell

Buffer strap
adjusting strap for check strap.
Buffer on Picker saver.
check strap.

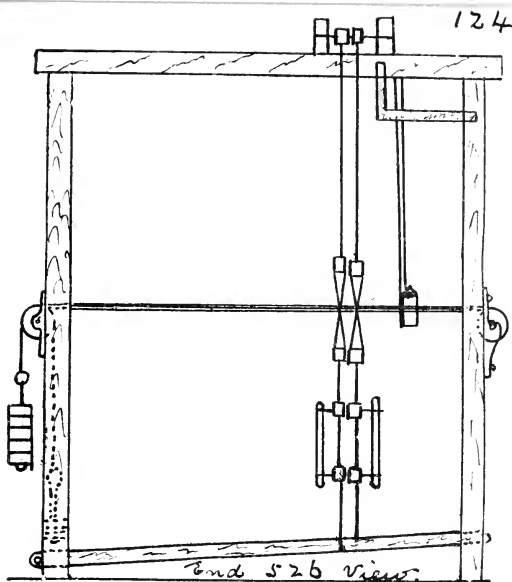
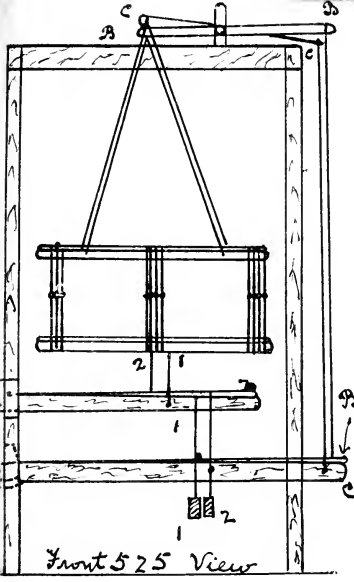

Hand Looms

Hand looms provided with a Dobby or Jacquard are very useful for pattern weaving especially where it is not convenient to use power. They are used for fine silk goods, and also extensively in India. Figs 525 & 526 illustrate the old type of hand loom with treadles; the weaver sits in front of the loom, and operating the treadles with his feet, and throws the shuttle by hand.

The downward tread of one treadle brings down no 1 heald and lifts no 2 heald. This is brought about (see 525) by connecting no 1. heald to no 1. treadle through the short lever A and the long lever B, by this means, if the action is carefully followed, it will be seen to operate as above stated; also no 2. treadle is connected to no 2. heald and long lever C; a tread on no 2 treadle brings down no 2 heald and lifts no 1 heald.

125 - The "Timing" and "Setting" of the parts in a Plain loom.

The principal motions of a loom, consists of the Shedding; Picking; Beating-up; Weft fork motion; Take-up motion; Stop-rod for Fast reeds; loose reed; Prakes, the adjustable "heather fittings"; the position of the "back-rest" and "breast-beam" of the loom. It is on the correct timing and setting of these parts, that good cloth is produced with a minimum amount of labour on the part of the weaver. Each of these parts will be briefly dealt with.

Shedding, The warp is gaited with the healds level, when the crank is on the top centre; the position of the set-screws on the top roller are

⊙, the heald eyes are on a level with the shuttle race, and the warp rests lightly on the slay. The sheds are regulated in size to suit the size of the shuttle used, but they must be no larger than what is absolutely necessary. The larger tappet works the back heald.

Picking, The picking is timed to suit the shedding, and it will generally be found that the shed is sufficiently open to receive the shuttle just as the crank goes on the bottom centre, this is therefore the most suitable time to pick; The pick must be smooth and even without any "jumping" or "jerky" action.

Beating-up, This action consists of the forward movement of the slay; the slay swords on Lathe arms are set perpendicular when the reed is to the fell of the cloth. It seldom requires any adjustment.

Stop-rod - Fast reed loom. The stop-rod tongue is set to dovetail well into the frog; the spring must be sufficiently tight to obviate any danger of the tongue slipping over the frog; if the spring is too tight there will be difficulties with the "Picking" as it will require more power to pull the shuttle out of the box.

Loose Reed Motion. The reed must be held firm at the moment of beating-up by allowing the "duck-bill" to pass underneath the heater; the reed must also be held firm when the shuttle travels across the loom, by allowing the roller to run on to the bent spring; at other times it must be loose, held only lightly by a spring. There must not be too much play for the shuttle in the, or the weft will get slack due to the rebound of the shuttle, and there will be trouble with the weft fork motion.

Weft fork Motion. The weft fork must be set to pass clear through the grid, without touching, it must also be free to "tilt" without touching the top or the bottom; the weft tappet is set to move the hammer at the same moment as the fork is tilted by the weft, namely about the time of beating-up.

Take-up Motion. The "hawl" is set to take one tooth for each beat up of the reed. The wheels must be perfectly free and not bind in any way. The "finger" must be set to act, so as to prevent taking-up when the weft fork acts.

Let off Motion. The weights are moved along the levers to increase or diminish tension. If ropes are used, care must be taken, that the weights do not touch the floor, chains

124. We preferably to ropes, the beam must not bind, or the flanges come into contact with the back^{rest}, due to crooked pikes.

The West brake must act promptly, to stop the loom with the shuttle in the box on the fork side, in two kicks after the fork has acted.

The Back brake must be kept well covered with leather, and act promptly. Keep oil off the brakes.

The Reed is set flush with the box back at each side of the loom, it is perhaps preferable to have it set a shade further back than the box back, for if it overfaces in the least the shuttle will fly out. Mr. Thomas Pickles in his "Ideal loom", uses and recommends the wire of the reed being flexible in the middle, and stiff a few inches from each side; the idea is a good one, and will conduce to less breakages of the yarn.

The Shuttle is made to suit the bevel of the box back; some overlookers prefer to have a shuttle a little lower at the front than the back.

The Back rest and Breast beam are set $1\frac{1}{2}$ " to 2 inches higher than the shuttle race.

The Check strap is a useful regulator for controlling the shuttle and preventing it from rebounding in the box, it is readily adjustable.

The Buffer leather must be kept clear of the spindle stud.

The spindle is set slightly higher at the stud than at the box-end.

Keep the shuttle boxes clean.

The Temples are set as low as possible.

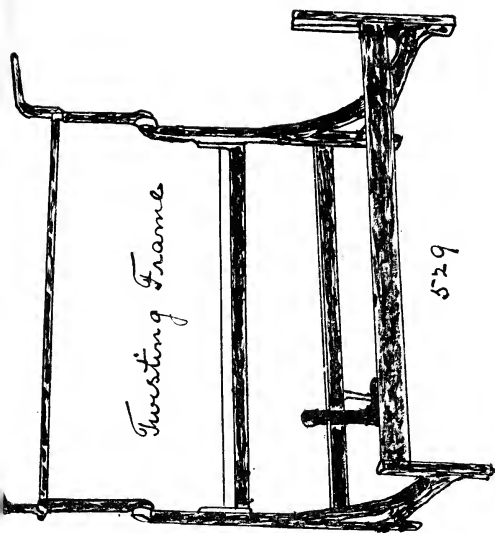

Twisting Frame

529

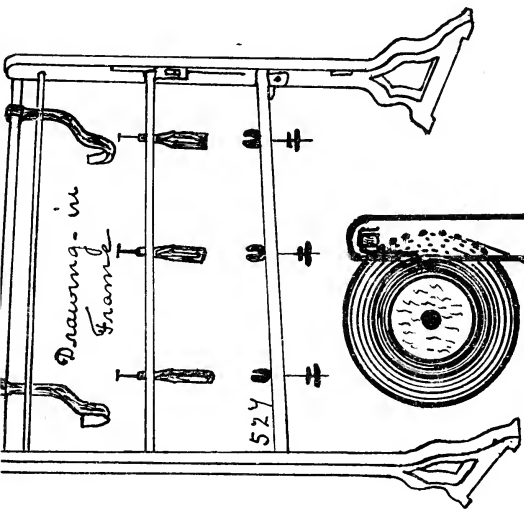

Drawing- in
Frame

524

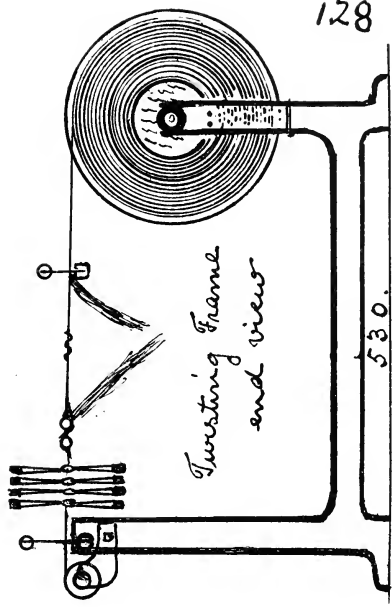

Twisting Frame
end view

530.

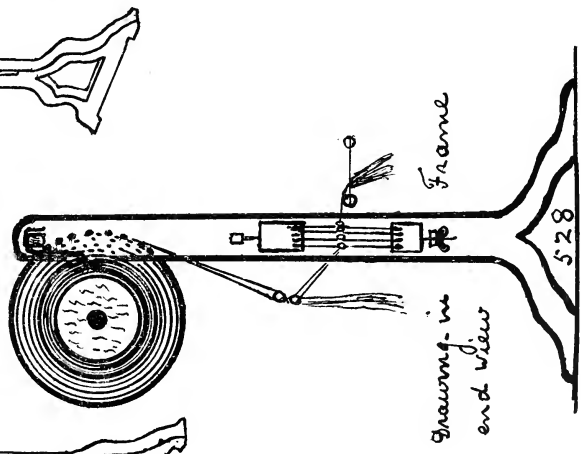

Frame

Drawing- in
end view

528

The different forms in which "Cotton Yarn" is supplied to the Manufacturer.

Cops are of two kinds, "weft cops" sometimes termed "pin cops" and "warp cops" often termed "twist cops". In the Grey trade in the making of "Burnley printers, Tull bateens, and similar cloths, if the manufacturer is not his own spinner, he buys his yarn in the cop. Both warp and weft cops are delivered by the spinner in skips and boxes.

The yarn from the "twist cops" is then wound on to warpers bobbins.



warpers
bobbin

The yarn from the bobbins is afterwards wound on to large beams termed "back beams".

these beams contain from 400 to 500 ends 15,000 to 20,000 yards in length; a number of these beams are afterwards combined together to

obtain the required number of ends for the weaver's beam, if a weaver's warp of 2000 ends is required 5 back beams of 400 ends each will be taken and combined together at the Slasher Sizing Machine. Sometimes it is found more profitable to allow the spinner to do the winding, and to buy the yarn direct from him on the "Back-beam."



WEFT
COP.



WARP
COP.

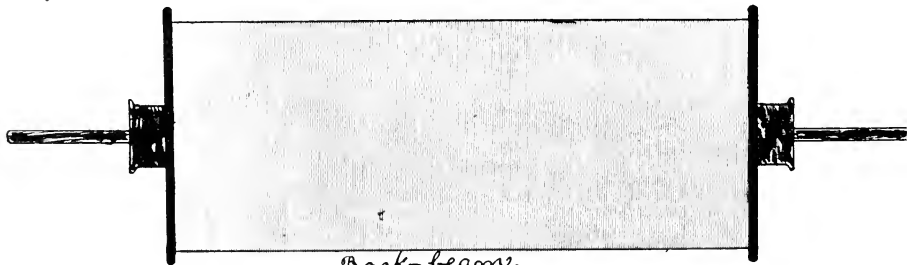

Back-beam.

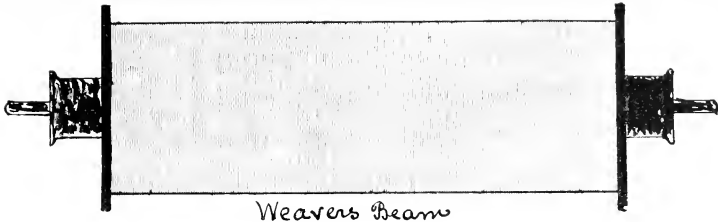

Weavers Beam

If the manufacturer is his own spinner, he will generally use "Ring twist" spun on to bobbins for warp yarn, it is better than "cop twist". If a manufacturer desires to use ring twist, and he is not his own spinner, he will buy the yarn on Back-beams or in Ball warps, as it is inconvenient and expensive to transport Ring bobbins



Ring Twist

Ring weft, spun upon small wood tubes is becoming extensively used by manufacturers, who are also their own spinners.



Ring weft.

The weft used in the Northrop loom is weft of this kind, it is better twisted and stronger than cop weft.

A coloured goods manufacturer may buy his yarn in several ways.

Weft, Coloured weft may be bought in pin cops, in which state it has been dyed, and although it is said that the Cops are not dyed uniform throughout, there is not often any complaints it is no doubt more evenly dyed, if dyed in the hand, and afterwards wound on to wood or paper tubes but it is more expensive.



Pin weft.



Pleached weft is also supplied in the Cop.

Warp Yarn may be bought in the hank in which state it is dyed and sized and wound on to bobbins at the Drum Winding Frame. These coloured bobbins are then creel in the creel of a Sectional Machine in the order of the colours required for the weavers warp, and wound

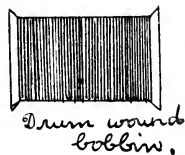

Drum wound bobbins.



"Cheese" of yarn.

on to small beams without flanges termed "cheeses" a number of "cheeses" are placed side by side on a modified beam, pressed close together, and wound on to the weavers beam. If a warp of 1760 ends is desired, 4 sections or cheeses of 440 ends will be required.

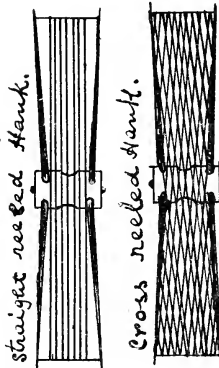

straight needed Hank.

Cross needed Hank.



Grey Ball warp

The warps may be bought in the "Ball" made to any number of ends and to any length by the spinner, these warps are then sent to the dyer, to be dyed the required colours, and returned to the Warp Dresser at the Weaving Mill, whose duty is to combine the



Dyed Ball warp.

different coloured ends of the warps, in the desired order to suit the pattern required, and wind the yarn on to the weavers beams.

When warps of one colour are required, Ball warps¹³² are often made in long lengths, by unwinding the yarn on to small tin bobbins, direct from the bobbins in the creel of a Beana warping machine.



A Ball Warp made into a Cheese of Yarn

but it is becoming the more usual thing to supply it in the hank, or on bobbins without

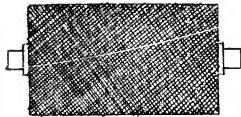

Drum wound bobbin without flanges. Cross. Winding

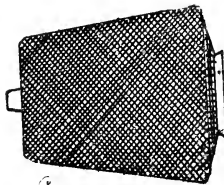

Cone of Yarn Cross. Winding as in the previous case, and used by unwinding from the end, in the same way as unwinding a cop.

Warps are often chained, the object being to reduce the length, so that they will move quickly pass through the dyeing machines. Doubled yarn, is sometimes supplied in the cop

but it is becoming the more usual thing to supply it in the hank, or on bobbins without flanges, in which form it can be readily transported, and used direct from the creel to be made into warps, or placed behind the sizing machine, in a creel, for selvege ends, or by the warp dresser for the same purpose. Or the yarn may be wound in cone form on to bobbins, cross-reeled



chained warp

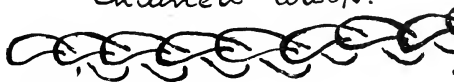



UMASS Dartmouth



3 2922 00389 297 0

UNIVERSITY MICROFILMS
SERIALS ACQUISITION
300 N ZEEB RD
ANN ARBOR MI 48106

^{570 021}
SPEC. COLL TS1579.H751 1912
Holmes, James, v.1
Manuscript notes on weaving

v. 1

RES.
677.022
H73 m
v. 1

LIBRARY
SOUTHEASTERN MASSACHUSETTS
TECHNOLOGICAL INSTITUTE
FALL RIVER, MASS.

