

---

IZH81

PUMP ACTION  
SHOTGUN  
WARNING AND  
INSTRUCTION MANUAL

European American Armory Corp.  
3855 North U.S. Highway One  
Cocoa, Florida 32926  
(321) 639-4842  
[www.eaacorp.com](http://www.eaacorp.com)  
E-mail: [eaacorp@eaacorp.com](mailto:eaacorp@eaacorp.com)

---

© Copyright, EAA Corp. 9/98

# EAA MODEL: IZH81 PUMP ACTION SHOTGUN

## WARNING AND INSTRUCTION MANUAL PLEASE READ THESE INSTRUCTIONS

<b>MODEL NUMBER</b> IZH81	<b>BARREL LENGTH</b> 20",24",26",28"	<b>CALIBERS</b> 12GA
<b>TYPE</b> PUMP ACTION		<b>FINISH</b> BLUE

### GENERAL INFORMATION:

Weight (average) - 20" = 5.9LBS., 28" = 6.7 LBS.  
Overall Length - 40" TO 48"

FOR YOUR SAFETY AND THE SAFETY OF OTHERS, this owner's manual contains important warnings and safety procedures which must be understood BEFORE using this firearm. Read the entire manual and if you do not understand any part of it or the operation of your shotgun, stop and seek professional firearms instructions. You can get a copy of this manual from European American Armory Corp. on request.

Record the serial number of your firearm:

# \_\_\_\_\_

and a description of it:

\_\_\_\_\_

Make a copy of this manual, proof of purchase/sales record for safekeeping in a secure safe or fireproof container. Such proof is necessary if the firearm is stolen or for warranty repair. Before handling any firearm, make sure you know the safety procedures and most importantly, keep the firearm pointed in a safe direction.

### WARNING

**\*\*YOU RISK INJURY OR DEATH BY HANDLING THIS FIREARM\*\***

Before handling this firearm, read, understand and follow the instructions in this manual. Always keep this manual with the firearm. If you lend, give or sell this firearm, be sure the manual goes with it. If there is anything you do not understand, seek advice from someone qualified in safe handling of firearms.

### WARNING

\*This firearm should always be transported unloaded in its case.\*

## TYPE OF AMMUNITION TO BE USED

It is suggested that high quality commercially manufactured ammunition be used in this firearm. Some factory ammunition works better than others and you should stick with the brand you find works well in your shotgun. Avoid military surplus or hot loaded ammo. The use of reloaded, high pressure or hand loaded ammunition will void the warranty.

## NOTICE

SHOTGUNS ARE CLASSIFIED AS FIREARMS OR DANGEROUS WEAPONS and are sold by European American Armory Corporation with the specific understanding that we are not responsible in any manner what-so-ever for their safe handling or resale under local laws and regulations.

European American Armory shall not be responsible in any manner whatsoever for malfunctioning of the firearm, for physical injury or for property damage resulting in whole or in part from (1) intentional or negligent discharge, (2) improper or careless handling, (3) unauthorized modifications and/or alteration to the internal/safety mechanisms, (4) defective, improper, high pressure, hand-loaded, or reloaded ammunition, (5) corrosion and/or lack of proper maintenance (6) neglect, or (7) other influences beyond our direct and immediate control. This limitation applies regardless of whether liability is asserted on the basis of contract, negligence or strict liability (including any failure to warn). Under no circumstance shall European American Armory Corporation be liable for incidental or consequential damages, such as loss of use of property, commercial loss and loss of earnings or profits.

## SAFETY PROCEDURES

1. We recommend that you get competent firearms instruction in safe handling before using this firearm. Please ask your dealer. All guns are extremely dangerous if carelessly handled or used. Remember that the firearm user is the primary "safety" and to depend on any mechanical devices is to be only half safe.
2. This firearm will fire if a cartridge is in the chamber and the trigger is pulled and the safety is disengaged.
3. DO NOT LOAD THIS SHOTGUN UNTIL YOU UNDERSTAND HOW THIS SHOTGUN OPERATES. KEEP this shotgun unloaded at all times except when ready to fire and you are sure of your target.
4. ALWAYS carry this shotgun in a case or original box **unloaded**.
5. NEVER point this shotgun at anything that is not your intended target even if this shotgun is unloaded. When loading, cleaning, unloading or handling, always be sure the muzzle is pointed in a safe direction and always keep your finger off the trigger.
6. NEVER assume any gun is unloaded. Before handling, check to make sure the chamber is empty. See unloading Instructions and then unload any

ammunition. Make sure you know that this or any firearm is fully unloaded before displaying or handling it. When handling any firearm, keep your fingers away from the trigger at all times until you intend to fire.

7. **WARNING:** The actual firearm does not contain any lead; however, it does fire ammunition containing lead or lead compounds known to the State of California to cause cancer, birth defects, reproductive toxicity, and other serious physical injury. Those who discharge a firearm, stand near someone who discharges a firearm or cleans firearms are hereby warned of the dangers presented by lead and lead compounds and should take protective health measures. Avoid exposure to lead while handling and wash your hands after contact. Proper air ventilation is absolutely necessary when shooting indoors.

## AMMUNITION WARNING

Old, Hot-loaded and/or re-loaded ammunition may be dangerous. Because of the poor or nonexistent quality control standards among some companies or people who make reloaded ammunition and the dangers of overloads and under loads (squib loads) which may occur, we recommend that only good quality new factory ammunition be fired in our firearms. [If you prepare your own hand loads, do NOT exceed recommended pressures in line with those generated by standard factory loads as manufactured by Remington, Winchester, Federal, PMC or other reputable companies.] Old ammunition may not fire with sufficient force to expel the projectile from the barrel.

## READING THESE SAFETY RULES WILL SAVE YOUR LIFE OR THE LIFE OF SOMEONE ELSE

Get instructions from a competent firearms instructor before using this or any firearm. Learn from a professional how to handle, load, unload, operate, fire and care for your gun.

NEVER PLAY with your firearm. It is not a toy and can be a very dangerous weapon that can cause serious personal injury or death.

Always keep the gun pointed in a safe direction. Treat every gun as if it is loaded...all the time. NEVER point any firearm (loaded or unloaded) at any person or anything you do not intend to shoot. Always keep your gun unloaded until ready to use and make sure that it is unloaded before cleaning.

Keep your finger OFF the trigger until you are actually aiming at the target and ready to shoot. Learn to rest your finger outside of the trigger guard.

Never rely on a gun's "safety" to protect you from unsafe gun handling. A safety is only a mechanical device, not a substitute for common sense and gun safety procedures.

Never leave a gun unattended or where it could fall and fire.

Store guns and ammunition separately **beyond the reach of children**. Make sure that they are properly secured so untrained individuals and children will be denied access to your guns and ammo.

Test your gun's operation and safeties only at a shooting range while the firearm is pointed in a safe direction.

Know your target and what is beyond. Ask yourself what your bullet will hit if it misses the target or passes through the intended target. Remember, a fired projectile can travel over a mile (including a ricochet) and is capable of going through walls.

Guns and alcohol or drugs do not mix. Don't take any alcoholic beverages and/or drugs before or during shooting activities.

Never pull a gun toward you by the muzzle. Don't climb a tree, cross a ditch or fence with a loaded gun.

Always empty guns before entering a house, car, truck, boat, RV, camp or any building.

When receiving a gun, always open the bolt and check to make sure the chamber is unloaded.

NEVER accept anyone's word that a gun is "unloaded" or "empty". You should immediately open the action and check to make sure it is unloaded.

Be careful with ALL ammunition. Even "blank" cartridges are deadly at close range due to the muzzle blast. Make sure your ammunition is in new and in good clean condition. Do NOT oil or grease ammo as this may damage the cartridge primer. Do NOT tamper with or alter the standard factory ammunition.

Keep firearms unloaded when not actually in use. Load the gun only when on the range preparing to fire and unload it before leaving the range.

Never put your hand over the muzzle of a gun.

ALWAYS WEAR protective shooting glasses and hearing protection when using firearms.

Spectators should be at least 10 feet behind and away from the shooter while the shooter is loading, shooting and unloading. Spectators should wear protection for hearing and sight loss and they should avoid distracting those shooting their firearms.

Never drop your gun. If you do drop it, unload it and check it for proper function before using it again.

Do NOT alter or modify your gun. Don't try to change your gun's trigger pull, because it may affect sear engagement and thereby cause accidental firing.

Do NOT remove any internal safety or safety device on the firearm. Safety mechanisms are designed to protect you from injury or death.

Do maintain and keep your gun clean. Keep in a dry place away from other metals and water. If your gun shows sign of corrosion or improper operation, have it serviced by a competent gunsmith.

Keep the muzzle pointed in a safe direction when loading and unloading your gun. Never point the muzzle at anyone.

Never shoot at hard flat surfaces or water....bullets ricochet.

If a gun fails to fire when the trigger is pulled, keep it pointed down range at the target for 60 seconds. Sometimes slow primer ignition will cause a "hang fire" and the cartridge will go off after a short pause. If it still fails to fire, keep muzzle pointed in safe direction and avoid exposure to the breech, as you attempt to unload your firearm.

Never let water, snow, mud or other material enter the barrel. Always be sure the barrel is free of any obstruction.

Since many ammunition identifications sound similar, be sure that you use only the correct ammunition for your gun. Do NOT use the wrong size or wrong strength ammunition in your firearm.

Repeated and prolonged exposure to gunfire may cause toxic levels of lead in your body. High levels of lead in the blood may result cancer, impotency, birth defects and other serious physical injury. When shooting indoors, make sure there is proper fresh air ventilation.

Teach children: 1. NOT to touch guns, bullets, cartridges, shells, flares or any explosive device and 2. If they discovery such a dangerous item or weapon, they must immediately report its location to their parents, school teacher and police.

Remember a firearm has the capability of taking your life or the life of someone else. Be careful with your firearm -- an accident is almost always the result of not following basic safety rules.

HOME SAFETY IS PROBABLY YOUR BIGGEST CONCERN. We suggest a gun lock such as Master Gun Locks. They work on most firearms and are available in gun shops and sporting goods departments. For more information write: Master Gun Locks; Master Lock Company, P.O. Box 10367, Milwaukee. WI 53210. You have invested this much in your new firearm, now invest a little more in your family's safety.

USED FIREARMS - If you got your European American Armory firearm as a used gun, BEFORE USING IT you should unload it and check all its functions to be sure it works correctly. Firearms are some times altered to work incorrectly, or parts may be removed, lost or replaced with incorrect parts. First, unload it and check it yourself and then take it to a good gunsmith who knows European American Armory firearms, and have him examine it.

WRITE US concerning any items or circumstances which you don't understand and which might relate to your safety and the operation of your firearm.

## W A R N I N G

BEFORE LOADING or firing a shotgun, examine the bore and the firing chamber to be certain they are clean and free of any obstruction. Even a heavy coat of oil, grease, snow or water may result in damage to the firearm and injury to the shooter and/or persons near the firearm. A misfire or unusual sound

upon firing is a signal to cease firing and to examine the chamber and bore. If there is any obstruction, clear the obstruction and clean the bore and chamber before firing.

## FIRING WARNING

When shooting, full eye and ear protection is mandatory at all times. Shooters and spectators must wear shooting glasses and sound suppressor to prevent eye injury and hearing loss. Vision loss and hearing impairment can occur with only one moment of non-protection.

## WARNING

Any bore obstruction, even if it is only partly blocked, may cause the gun to blow up if it is fired, or may cause damage to the gun such as a bulged barrel. To avoid injury or death to the shooter or bystanders, check the barrel before shooting or if a shot does not sound normal.

## WARNING

Always keep the muzzle pointed in a safe direction! Never attempt to load or unload any firearm inside a vehicle, building or other confined space (except a properly constructed shooting range). Enclosed areas frequently offer no completely safe direction in which to point the firearm. If an accidental discharge occurs, there is great risk of injury or property damage. Before loading, always clean all, grease and oil from the bore and chamber, and check to be certain that no obstruction is in the barrel. Any foreign matter in the barrel could result in a bulged or burst barrel or other damage to the firearm and could cause serious injury to the shooter or to others.

## WARNING

If there is any reason to suspect that a bullet or projectile is obstructing the barrel, immediately unload the firearm (See Unloading Instructions) and check the chamber and the bore. A bullet may be lodged some distance down the barrel where it can not easily be seen. Check the bore by using a cleaning rod to pass through the barrel. If a blockage is in the bore, **DO NOT ATTEMPT TO SHOOT IT OUT WITH ANOTHER CARTRIDGE, OR BLOW IT OUT WITH A BLANK CARTRIDGE OR A CARTRIDGE FROM WHICH THE BULLET HAS BEEN REMOVED. SUCH TECHNIQUE(S) CAN GENERATE EXCESSIVE PRESSURE, DAMAGE THE FIREARM AND CAUSE SERIOUS PERSONAL INJURY.** If the blockage can be removed with a cleaning rod, clean any unburned powder grains from the bore, chambers & mechanism before resuming shooting. If the blockage can not be dislodged by tapping it with a cleaning rod, take the firearm to a gunsmith.

## WARNING (Mechanical Malfunctions)

**STOP SHOOTING IMMEDIATELY AND UNLOAD YOUR FIREARM if your**

firearm develops: a mechanical malfunction; binding or stoppage; spitting powder/gas; a cartridge primer is punctured; a cartridge case is bulged or ruptured; or the sound on firing does not sound quite right. Do NOT try one more shot but unload your firearm and take it and the ammunition to a qualified gunsmith or send it back to EAA for examination. Do not assume that the shotgun is empty merely because you checked the chamber. You must also check the bore for any fired shot or wad jammed inside the barrel.

## EXPLODED VIEW DRAWING

### PARTS LIST

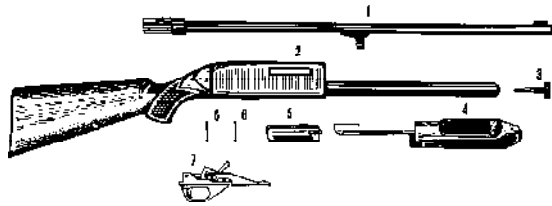

Fig. 3 - IZH81M Assembly Units

1. barrel with sleeve
2. receiver with stock & magazine tube
3. barrel nut
4. forend/slide bar assy
5. breech bolt with bolt lock
6. firing mechanism pin
7. firing mechanism with shell elevator

Fig. 4 - IZH81KM Assembly Units

1. barrel with sleeve
2. receiver with stock & magazine Tube
3. barrel nut
4. forend/slide bar assy
5. breech bolt with bolt lock
6. firing mechanism pin
7. firing mechanism with magazine catch
8. box magazine

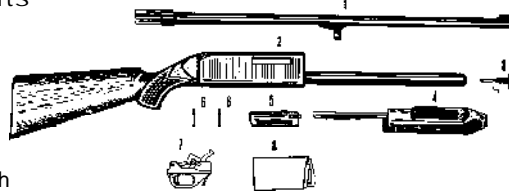

Fig. 5 - IZH81M or KM Version with Folding Stock

1. barrel with sleeve
2. receiver with stock & magazine tube
3. barrel nut
4. forend/slide bar assy
5. breech bolt/bolt lock/bolt slide assy
6. firing mechanism pin
7. firing mechanism with shell elevator
8. folding stock

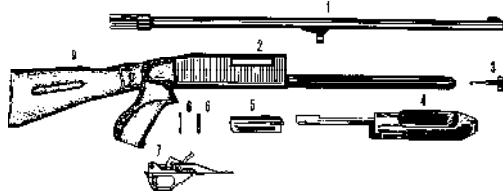
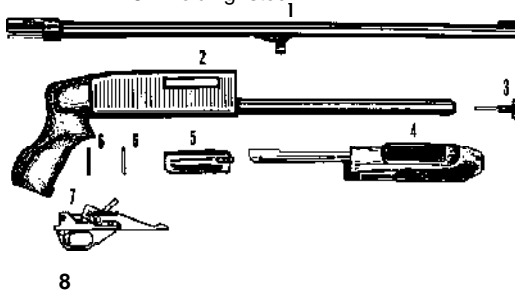

Fig. 6 - IZH81M or KM Version with Pistol Grip

1. barrel with sleeve
2. receiver with pistol grip & magazine tube
3. barrel nut
4. forend/slide bar assy
5. breech bolt/bolt lock/bolt slide assy
6. firing mechanism pin
7. firing mechanism with shell elevator





## External Control Parts:

**Cross Trigger Block Safety:** Located on trigger housing behind trigger, push button style. When red ring is exposed shotgun will fire if trigger is pulled!! Do not disengage safety unless you are ready to fire shotgun. (Safety Engaged - The red ring is not showing and the trigger is blocked from full travel; Safety Disengaged - The red ring is showing and the trigger has full travel...**MAKE SURE YOU UNDERSTAND HOW THE SAFETY WORKS BEFORE YOU LOAD OR USE THE SHOTGUN**)

**Trigger:** Located in the trigger guard with safety disengaged and trigger pulled to the rear shotgun will discharge.

**Forearm / Slide:** Located under barrel in front of the receiver. Moves rearward to remove spent or empty cartridge cases or to un-chamber a live round that is not to be fired... Forearm / slide moves forward to pick up a live cartridge from the magazine and carry it into the firing chamber.

**Action Unlock Button:** When pushed in will allow the opening of the slide for quick inspection or unloading of the chamber.

**Magazine Release Lever:** When pushed forward permits insertion or removal of the magazine. A pendulum motion of the magazine during insertion and/or removal insures lips of the magazine body to securely engaged on the release lever.

**Slide Guide Tube Cap:** Screws onto the end of the Forearm / Slide guide tube.

## Direction for Assembly

The IZH81 comes fully assembled. All you will need to do is remove the wrapping, clean the protective oil from the gun and insert the magazine.

### **Screw in Chokes Symbols / Markings (This is an option not all IZH81 shotguns have this feature)**

The end of the chokes are marked with slashes to determine choke

- / - Full
- // - Improved Modified
- /// - Modified
- //// - Improved Cylinder
- CI - Cylinder

Make sure that you fully install the choke tube before you fire the shotgun. The chokes are right hand thread. Make sure that you do not cross thread the chokes and after use remove the choke tube and clean the choke tube threads and location in the barrel where the choke tube thread into.

## Direction for Disassembly

Make sure the gun is unloaded and pointed in a safe direction. Make sure the safety is on. There is no excuse for not being careful.

**1) Fig 1:** With the bolt in the forward position unscrew the slide guide tube cap and remove the cap. Grasp the barrel and remove the barrel by pulling the barrel and barrel extension out of the receiver.

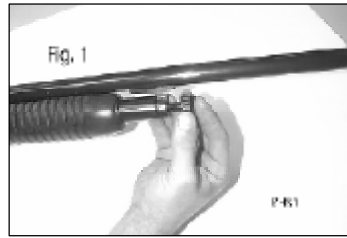

**2) Fig 2:** Grasp the forend / slide and pull the bolt and action bar forward out of the receiver and remove the bolt and action bar and forend / slide assembly from the slide guide tube. Be careful because once the bolt is removed from the receiver all the pieces from the assembly are free to separate. We suggest you keep the gun with the bolt up when you remove the assembly so the assembly does not separate.

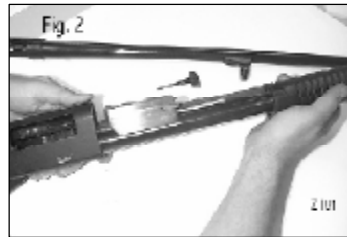

**3) Fig 3:** The trigger assembly can be removed with the barrel and bolt removed or without the barrel and bolt removed. To remove the trigger assembly all you do is remove the two pins that hold the trigger assembly in place and pull the trigger assembly from the receiver. The pins can be removed with a hammer and a punch.

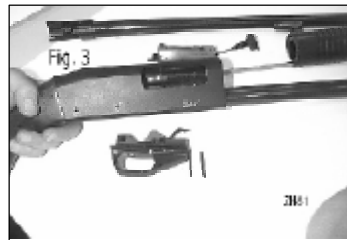

### To load your Shotgun

**1)** Make sure the shotgun is pointed in a safe direction at all times, the safety is engaged, and never allow fingers or objects to contact trigger.

**2)** Do not load shotgun until you are ready to fire.

**3)** Do not disengage the safety until you are ready to fire.

**4)** Make sure the ammo that you are using is the correct size and gauge. The barrel is marked with the gauge and chamber size, barrels marked 3" will also use 2 3/4" or 3" shot shells.

**5)** Visually inspect the chamber for obstructions by pulling back the forearm / slide until it stops movement (if the forearm / slide will not move to the rearward position depress the action unlock button) . The chamber should be free of oil or grease or obstructions... The chamber is the rear portion of the barrel where the cartridge slides into from the pressure applied by the bolt.



**6) Fig 4:** Insert five or less cartridges into the magazine.

**\*\*WARNING\*\***

Never insert the magazine into the receiver until you are ready to fire the shotgun...

**7) FIG 5:** With the forearm / slide in the rearward position, push the magazine release lever forward to permit insertion of the magazine. A pendulum motion of the magazine during insertion insures that the lips of the magazine body will be to securely engaged.

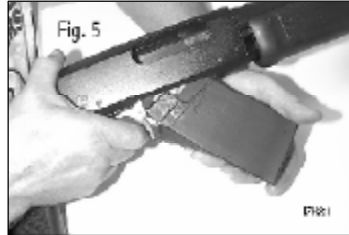

**8) FIG 6:** With the magazine in place slide the forearm / slide forward until the action locks. This procedure will load a cartridge into the chamber. The shotgun will now fire if the cross trigger block safety is disengaged.

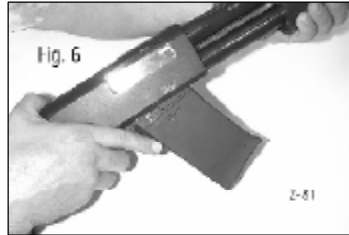

To Fire your Shotgun

**\*\*WARNING\*\***

Do not disengage the safety until the shotgun is pointed in a safe direction and you are ready to fire

After the last round has been fired and the magazine is still in the shotgun, the forearm and bolt will lock in the reward position when cycled. Never count on the locked back bolt as a signal that the gun is empty.... Use your eyes to verify that the gun is empty.

If a cartridge does not fire and the trigger has been pulled and the safety is disengaged... Stop! and do the following: **a)** Make sure the gun is pointed in a safe direction **b)** Engage the safety **c)** Wait 60 seconds **d)** Follow the instruction below for unloading the shotgun

If during firing the sound of any cartridge is noticeably softer or louder than the previous cartridge fired, Stop! Do not load another cartridge or fire another cartridge and do the following: **a)** Make sure the gun is pointed in a safe direction **b)** Engage the safety **c)** Follow the instruction below for unloading the shotgun **d)** With the shotgun unloaded visually inspect the shotgun for barrel blockage or damage and inspect the mechanical portion and receiver of the shotgun for damage before continuing.

PLEASE READ AND UNDERSTAND ALL WARNINGS IN THIS MANUAL BEFORE FIRING THE SHOTGUN, MAKE SURE YOU KNOW WHAT YOU ARE SHOOTING AT.

**1) Make sure the gun is pointed in a safe direction and that you are wearing ear and eye protection.**

- 2) Engage safety if not already engaged
- 3) To begin firing disengage the safety, make sure you are ready to fire and the shotgun is pointed in a safe direction to be fired. After you have fired the first round by pulling the trigger to the rear move the forearm / slide back to the rear and the spent cartridge will be ejected. When you move the forearm / slide forward the bolt will strip a round from the magazine and load it into the chamber. If you pull the trigger again the gun will fire. You may repeat this cycle until the magazine is empty and the bolt / action locks to the rear.

### To Unload Shotgun

1) Make sure that gun is pointed in safe direction and engage safety, if not already engaged. Never allow your finger or any object to come in contact with the trigger during the unloading operation...

2) **Fig 7:** Remove the magazine by pushing the magazine release lever forward until it touches the body of the magazine, while keeping the release lever in the forward position use a pendulum motion to swing the magazine out of the receiver.



3) **Fig 8:** With the magazine removed now push the action unlock button and slide the forearm / slide to the rear. If there was a spent or unspent cartridge in the chamber it will be ejected. Visually inspect the chamber to make sure that the gun is fully unloaded. Also check for any debris or foreign objects in the mechanism or barrel or chamber. If there is a cartridge stuck in the chamber and it did not come out when you moved the forearm / slide to the rear obtain a cleaning rod and push the cartridge out backward.

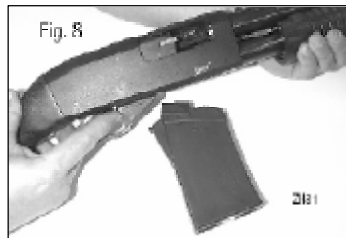

### MANUFACTURER'S WARNING

This firearm was manufactured to properly perform with the original parts as designed. It is your duty to make sure any parts you buy are correctly installed and that neither replacements nor originals are altered or changed. Your gun is a complex tool with many parts that must relate correctly to other parts for safe and accurate operation. Putting a gun together wrong or with modified parts can result in a damaged gun, injury or death to you or others through malfunction. Always let a qualified gunsmith work on your gun or at least, check any work not performed by a gunsmith. Firearms safety is your primary concern. **THE GUN OWNER MUST ACCEPT FULL RESPONSIBILITY FOR THE CORRECT REASSEMBLY AND FUNCTIONING OF THE FIREARM AFTER ANY DISASSEMBLY OR REPLACEMENT OF PARTS.**

## CLEANING AND MAINTENANCE OF SHOTGUN

**A)** Follow procedures for unloading shotgun as described previously

**B)** Follow procedures for disassembly of shotgun as described previously

**1)** Materials needed to clean this shotgun are: a cleaning rod, cotton bore patches, brass bore brush, powder solvent, a small soft brush and good quality gun oil.

**WARNING:** Lead or lead compounds are known to the State of California to cause cancer, birth defects, reproductive toxicity, and other serious physical injury. Those who clean firearms should take protective measures to avoid contact or exposure to such chemicals.

**2)** Using the bore brush with powder solvent scrub the barrel and chamber to remove any powder and lead residue in the bore. Always and lastly, swab with cotton patch with gun oil to coat and protect the bore and chambers from rust and corrosion.

**3)** Any powder fowling on the firing wall, barrel, etc. can be easily cleaned with a brush and powder solvent.

**5)** All external surfaces should be wiped down with light coat of rust preventative. Avoid using too much oil as dust and/or debris can get trapped in the oil creating a gum that in time will cause misfires.

**6)** CAUTION in using solvents in gun bore cleaning. Prolonged or excess contact with finish or bluing can damage the gun's finish. Be sure to wipe away all excess solvent and then lubricate with oil.

**7)** A gun should be cleaned after firing. In addition, external parts should be wiped with an oiled cloth after handling. A light oil is ordinarily all that is necessary in cleaning if the gun has not been fired or fired very little. If a gun is used frequently, it must be cleaned after each firing and regularly serviced by a professional gunsmith. If the gun has been stored, remove all excess oil and/or grease before firing. Always check to be sure that no cleaning patch or other obstruction remains in the bore or chambers before firing.

## DANGER -- AMMUNITION WARNING

Firearms may be damaged and serious injury or death to the shooter or bystander may result from any condition which contributes to the generation of excessive pressure or uncontrolled release of gas within the firearm. Such adverse conditions can be caused by bore or chamber obstruction, propellant powder overloads or by defective, incorrect or improperly loaded and assembled cartridge components. Even the strongest firearm can be blown up as a result of excessive pressure. It is extremely dangerous to use a cartridge whose pressure is greater than that developed by cartridges loaded to industry standards.

## AMMUNITION (CARTRIDGES) NOTICE

We specifically disclaim responsibility for any damage, injury or death

occurring in connection with or as the result of the use of European American Armory shotguns of faulty, non-standard, remanufactured, hand loaded or reloaded ammunition, used cartridges or cartridges other than factory cartridges for which the firearm was originally chambered.

#### LUBRICATION WARNING

Firing a shotgun with oil, grease or any other material even partially obstructing the bore may result in damage to the shotgun and injury to the shooter and those nearby. Do not spray or apply lubricants directly on ammunition. If the powder charge of a cartridge is affected by the lubricant, it may not be ignited, but the energy from the primer may be sufficient to push the bullet into the bore where it may become lodged. Firing a subsequent bullet into the obstructed bore will damage the shotgun and may cause injury to the shooter and those nearby. Use lubricants properly. You are responsible for the proper care and maintenance of your firearm and ammunition.

#### ONE YEAR LIMITED WARRANTY

This European American Armory Corp. firearms is warranted to the original retail customer for One Year from date of purchase against defects in material and workmanship. All parts and labor or replacement **at our option** are covered. Wood Stock and Wood Slide / Forend are not covered by the One Year Warranty. The warranty on the wood stock and wood slide / forend is 60 days from purchase and only covers manufactured and material defects.

Transportation to and from our repair facilities, government fees, damage caused by failure to perform normal maintenance, sales outside the United States, damage due to use of high velocity, high pressure, reloaded or other nonstandard ammunition, or any unauthorized repair, modification, misuse, abuse, or alteration of the product is not covered by this Limited Warranty.

Any implied warranties, including the implied warranties of merchantability and fitness for a particular purpose, are limited to one year from date of original retail purchase. Consequential or incidental damages and/or expenses, or any other expenses are not covered by this warranty.

To obtain warranty performance send your firearm with proof of retail purchase, freight prepaid to:

**European American Armory Corp.  
3855 North U.S. Highway One  
Cocoa, Florida 32926**

## W A R N I N G

Altering or modifying parts and/or internal safeties is dangerous and will void the warranty. This shotgun was manufactured to perform properly with the original parts as designed. It is your duty to make sure any parts you buy are made for this firearm and are installed correctly and that neither the replacements nor originals are altered or changed. Your gun is a complex precision tool with many parts that must relate correctly to other parts in order for proper and safe operation. Putting a gun together wrong or with incorrect or modified parts can result in a damaged gun, danger, and injury or death to you and others through malfunction. Always have a qualified gunsmith work on your gun or at least check any work not performed by a gunsmith.

## YOUR OWNERS' MANUAL

Always keep this manual with your firearm. Make sure you understand all the warnings, operation instructions and safety procedures. When you lend, give or sell the firearm, be sure this manual goes with it. You can get a copy of this manual from European American Armory on request.

ALL PARTS ORDERS ARE SUBJECT TO A \$10.00 CHARGE FOR SHIPPING AND HANDLING. Please state Model, Caliber, Serial Number, and Finish Color when ordering. For parts, information and service contact: European American Armory Corp., 3855 North U.S. Highway One, Cocoa, Florida 32926 Phone: (321) 639-4842.

**To plug magazine to less than 5RDS, remove magazine floor plate, insert plug and reassemble magazine.**

# PARTS LIST

Fig. 1 - IZH81M or KM Exploded View

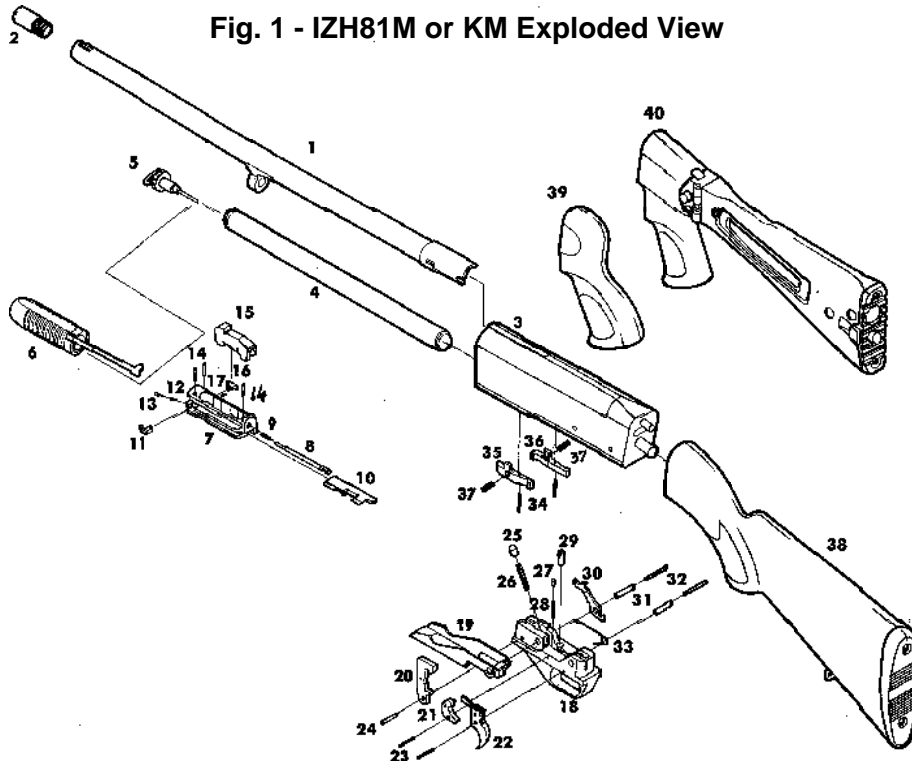

- |                            |                                    |
|----------------------------|------------------------------------|
| 1. barrel                  | 21. sear                           |
| 2. choke tube              | 22. trigger with pushing rod       |
| 3. receiver                | 23. pin                            |
| 4. magazine                | 24. hammer pin                     |
| 5. barrel nut              | 25. mainspring plunger             |
| 6. forend with slide bar   | 26. mainspring                     |
| 7. breech bolt             | 27. sear plunger                   |
| 8. firing pin              | 28. sear spring                    |
| 9. firing pin spring       | 29. detent button                  |
| 10. bolt slide             | 30. detent                         |
| 11. extractor              | 31. firing mechanism fastening pin |
| 12. extractor spring       | 32. dowel                          |
| 13. extractor plunger      | 33. elevator spring                |
| 14. pin                    | 34. interceptor pin                |
| 15. bolt lock              | 35. interceptor L.H.               |
| 16. extractor              | 36. interceptor R.H.               |
| 17. extractor spring       | 37. interceptor spring             |
| 18. firing mechanism plate | 38. stock                          |
| 19. elevator               | 39. grip                           |
| 20. hammer                 | 40. folding stock assy             |