EAA MODEL BAIKAL IZH18



Single Barrel Shotgun

(12, 16, 20, 28 GA and .410 Bore)

WARNINGS AND INSTRUCTION MANUAL

European American Armory Corp.
3855 North U.S. Highway 1
Cocoa, Florida 32926
(321) 639-4842
www.eaacorp.com
E-mail: eaacorp@eaacorp.com

EAA CORP MODEL IZH18 SINGLE BARREL SHOTGUN

WARNINGS AND INSTRUCTION MANUAL PLEASE READ THESE INSTRUCTIONS

MODEL NUMBER IZH18	BARREL LENGTH 26", 28", 30", 32"	GAUGES 12, 20, 16, 28, .410
TYPE SINGLE BARREL SHOTGUN	FINISH BLUE	

GENERAL INFORMATION:

Weight (average) - 28" = 6.9 Lbs.
Overall Length - 43", 45", 47", 49", 51"

FOR YOUR SAFETY AND THE SAFETY OF OTHERS, this owner's manual contains important instructions, warnings and safety procedures which must be understood **BEFORE** using this firearm. Read the **ENTIRE MANUAL** and if you do not understand any part of them or the operation of your shotgun, stop and seek professional firearms instruction. You can get a copy of this manual from European American Armory Corp. upon request.

Record the serial number of your firearm (located inside the receiver on the right hand side):

and a description of it:

Make a copy of this manual, proof of purchase/sales record for safekeeping in a secure safe or fireproof container. Such proof is necessary if the firearm is damaged, stolen or sent in for warranty repair.

 **W A R N I N G**
****YOU RISK PERSONAL INJURY OR DEATH
BY HANDLING THIS FIREARM****

Before handling any firearm, make sure you know the safety procedures and most importantly, keep the firearm pointed in a safe direction.

Before handling this firearm, read, understand and follow the instructions in this manual. Always keep this manual with the firearm. If you lend, give or sell this firearm, be sure the manual goes with it. If there is anything you do not understand, seek advice from someone qualified in safe handling of firearms. You must **ALWAYS** obey the following warnings, instructions and safety procedures:

1. Always keep the muzzle pointed in a safe direction.
2. Firearms should be unloaded and secured when not actually in use.
3. Don't rely on your firearm's safety.
4. Be sure of your target and what's beyond it.
5. Use only proper ammunition matching the precise gauge of your specific shotgun.
6. If your shotgun fails to fire when the trigger is pulled, handle with care.
7. Always wear ear and eye protection when shooting.
8. Be sure the barrel is clear of obstructions before shooting.
9. Don't alter or modify your firearm and have it serviced regularly.
10. Learn the mechanical and handling characteristics of your shotgun.
11. Shoot sober!

Type Of Ammunition To Be Used:

It is suggested that high quality commercially manufactured ammunition be used in this firearm. Avoid military surplus or old ammunition as it may not fire with sufficient force to expel the projectile or wad from the barrel. **The use of reloaded, high pressure or hand-loaded ammunition can be dangerous and will void the warranty.**

LEAD WARNING: The actual firearm does not contain any lead; however, it does fire ammunition which contains lead or lead compounds known to the State of California to cause cancer, birth defects, reproductive toxicity, and other serious physical injury. Those who discharge a firearm, stand near someone who discharges a firearm or clean firearms are hereby warned of the dangers presented by lead and lead compounds and should take protective health measures. Avoid exposure to lead while handling and wash your hands after contact. Proper air ventilation is absolutely necessary when shooting indoors.

NOTICE

SHOTGUNS ARE CLASSIFIED AS FIREARMS OR DANGEROUS WEAPONS and are sold by European American Armory Corp. with the specific understanding that we are not responsible in any manner whatsoever for their safe handling or resale under local laws and regulations.

European American Armory Corp. shall not be responsible in any manner whatsoever for malfunctioning of the firearm, for physical injury or for property damage resulting in whole or in part from **(1)** intentional or negligent discharge, **(2)** improper or careless handling, **(3)** unauthorized modifications and/or alteration of the internal/safety mechanisms, **(4)** defective, improper, high pressure, hand-loaded, or reloaded ammunition, **(5)** corrosion and/or lack of proper maintenance **(6)** neglect, or **(7)** other influences beyond our direct and immediate control. This limitation applies regardless of whether liability is asserted on the basis of contract, negligence or strict liability (including any failure to warn). Under no circumstance shall European American Armory Corp. be liable for incidental or consequential damages, such as loss of use of property, commercial loss and loss of earnings or profits.

FOLLOWING THESE SAFETY RULES CAN SAVE YOUR LIFE OR THE LIFE OF SOMEONE ELSE

Get competent firearms instruction in safe handling before using this firearm. Please ask your dealer for names of qualified instructors. All guns are extremely dangerous if carelessly handled or used. Remember that the firearm user is the primary “safety” and that reliance on any mechanical device should never replace safe handling procedures.

This firearm **WILL FIRE** if a cartridge is in the chamber and the trigger is pulled while the safety is disengaged.

DO NOT LOAD THIS SHOTGUN UNTIL YOU UNDERSTAND HOW IT OPERATES. KEEP this shotgun unloaded at all times except when you are ready to fire and sure of your target.

ALWAYS carry this shotgun in a case or original box unloaded.

NEVER point this shotgun at anything that is not your intended target even if the shotgun is unloaded. When loading, unloading, cleaning or handling, always be sure the muzzle is pointed in a safe direction and always keep your finger off the trigger. **NEVER** assume any gun is unloaded. Before handling, check to make sure the chamber is empty. See Unloading Instructions. Make sure you know that this or any firearm is unloaded before displaying or handling it. When handling any firearm, keep your fingers away from the trigger at all times until you intend to fire.

Get instructions from a competent firearms instructor before using this or any firearm. Learn from a professional how to handle, load, unload, operate, fire and care for your gun.

NEVER PLAY with your firearm. It is not a toy and can be a very dangerous weapon that can cause serious personal injury or death.

Always keep the gun pointed in a safe direction. Treat every gun as if it is loaded...all the time. **NEVER** point any firearm (loaded or unloaded) at any person or anything you do not intend to shoot. Always keep your gun unloaded until ready to use and make sure that it is unloaded before cleaning.

Keep your finger **OFF** the trigger until you are actually aiming at the target and ready to shoot. Learn to rest your finger outside of the trigger guard.

Never rely on a gun’s “safety” to protect you from unsafe gun handling. A safety is only a mechanical device, not a substitute for using common sense and following gun safety procedures.

FOLLOWING THESE SAFETY RULES CAN SAVE YOUR LIFE OR THE LIFE OF SOMEONE ELSE

Never leave a gun unattended or where it could fall.

Store guns and ammunition separately **beyond the reach of children**. Make sure that they are properly secured so untrained individuals and children will be denied access to your guns and ammunition.

Test your gun's operation and safeties only at a shooting range while the firearm is pointed in a safe direction.

Know your target and what is beyond. Ask yourself what the projectile will hit if it misses the target or passes through the intended target. Remember, a fired projectile can travel over a mile (including a ricochet) and is capable of going through walls. Never shoot at hard flat surfaces or water. . .shot ricochet.

Guns and alcohol or drugs do not mix. Don't take any alcoholic beverages and/ or drugs before or during shooting activities.

Never pull a gun toward you by the muzzle. Don't climb a tree, cross a ditch or fence with a loaded gun.

Always empty guns before entering a house, car, truck, boat, RV, camp or any building.

When receiving a gun, always open the action and check to make sure the chamber is unloaded.

NEVER accept anyone's word that a gun is "unloaded" or "empty." You should immediately open the action and check to make sure it is unloaded.

Be careful with **ALL** ammunition. Even "blank" cartridges are deadly at close range due to the muzzle blast. Make sure your ammunition is new and in good clean condition. Do **NOT** oil or grease ammunition as this may damage the cartridge primer. Do **NOT** tamper with or alter the standard factory ammunition.

Keep firearms unloaded when not actually in use. Load the gun only when on the range preparing to fire and unload it before leaving the range.

Never put your hand over the muzzle of a gun.

ALWAYS WEAR protective shooting glasses and hearing protection when using firearms.

FOLLOWING THESE SAFETY RULES CAN SAVE YOUR LIFE OR THE LIFE OF SOMEONE ELSE

Spectators should be at least 10 feet behind and away from the shooter while the shooter is loading, shooting and unloading. Spectators should wear protection for hearing and sight loss and they should avoid distracting those shooting their firearms.

Never drop your gun. If you do drop it, unload it and check it for proper function before using it again.

Do **NOT** alter or modify your gun. Don't try to change your gun's trigger pull, because it may affect sear engagement and thereby cause accidental firing.

Do **NOT** remove any internal safety or safety device on the firearm. Safety mechanisms are designed to help protect you from injury or death.

Properly maintain and keep your gun clean. Keep it in a dry place away from other metals and water. If your gun shows sign of corrosion or improper operation, have it serviced by a competent gunsmith.

Keep the muzzle pointed in a safe direction when loading and unloading your gun. Never point the muzzle at anyone. Never put your hand over the muzzle of a gun.

If a gun fails to fire when the trigger is pulled, keep it pointed down range at the target for 60 seconds. Sometimes slow primer ignition may cause a delay in full ignition of the cartridge. If after 60 seconds, the cartridge does not fire, keep muzzle pointed in safe direction and avoid exposure to the breech, as you attempt to unload your firearm.

Never let water, snow, mud or other material enter the barrel. Always be sure the barrel is free of any obstruction.

Use the correct ammunition for your gun. Do **NOT** use the wrong size or wrong strength ammunition in your firearm.

Teach children: 1. NOT to touch guns, bullets, cartridges, shells, flares or any explosive device and **2.** That if they discover such a dangerous item or weapon, they must immediately report its location to their parents, school teacher or police.

Remember a firearm has the capability of taking your life or the life of someone else. Be careful with your firearm — an accident is almost always the result of not following basic safety rules.

Use the Security Lock Provided with your Shotgun

This shotgun comes with a security lock to assist in protecting against unauthorized use. See **Picture A**. The shotgun must be unloaded when the security lock is in place on the shotgun. **WARNING:** Using the security lock cannot substitute for securing your firearm and ammunition in separate, locked locations.

The security lock operates as follows:

1. To open the Trigger Lock put the Key into the notches of the Trigger Lock Nut and unscrew it counter-clockwise. See **Figures 1 and 2**. Remove the Trigger Lock Screw.
2. To install the Trigger Lock on a single barrel break-open shotgun put the Trigger Lock window on the shotgun locking lever and then slide the Trigger Lock around the trigger guard. See **Figure 3**.
3. Screw the Trigger Lock Nut on the Trigger Lock Screw (clockwise) and tighten the nut with the key. **DO NOT TIGHTEN THE NUT TOO TIGHT OR YOU COULD DAMAGE THE LOCK SCREW.** See **Figure 4**.
4. To remove the Trigger Lock, unscrew the Trigger Lock nut with the key and detach the Trigger Lock Screw. See **Figure 5**.



Picture A



Figure 1



Figure 2



Figure 3



Figure 4



Figure 5

WARNING

Always store the key to the security lock: (1) in a separate location away from the shotgun; (2) in a secure location unknown and not accessible to others, especially children. Whether you secure your firearms by using the supplied security lock, a gun lock or a safe or some other mechanism, it is **YOUR RESPONSIBILITY** to store your firearms in such a manner that children and other unauthorized persons cannot gain access to them.

USED FIREARMS - Firearms are sometimes altered to work incorrectly, or parts may be removed, lost or replaced with incorrect parts. If you got your European American Armory Corp. firearm as a used gun, **BEFORE USING IT** you should take it to a good gunsmith who knows European American Armory Corp. firearms, and have him examine it.

WRITE European American Armory Corp. concerning any items or circumstances which you don't understand and which might relate to your safety and the operation of your firearm at: European American Armory Corp., 402 Richard Road, Rockledge, FL. 32955, Phone: (321) 639-4842.

WARNING (POTENTIAL OBSTRUCTIONS)

BEFORE LOADING or firing a shotgun, examine the bore and the firing chamber to be certain they are clean and free of any obstruction. Even a heavy coat of oil, grease, snow or water may result in damage to the firearm and injury to the shooter and/or persons near the firearm. A misfire or unusual sound upon firing is a signal to cease firing and to examine the chamber and bore. If there is any obstruction, clear the obstruction and clean the bore and chamber before firing.

Any bore obstruction, even if it is only partly blocked, may cause the gun to blow up if it is fired, or may cause damage to the gun such as a bulged barrel. To avoid injury or death to the shooter or bystanders, check the barrel before shooting or if a shot does not sound normal.

WARNING

Always keep the muzzle pointed in a safe direction! Never attempt to load or unload any firearm inside a vehicle, building or other confined space (except a properly constructed shooting range). Enclosed areas frequently offer no completely safe direction in which to point the firearm. If an accidental discharge occurs, there is great risk of death, personal injury or property damage. Before loading, always clean all, grease and oil from the bore and chamber, and check to be certain that no obstruction is in the barrel. Any foreign matter in the barrel could result in a bulged or burst barrel or other damage to the firearm and could cause serious injury to the shooter or to others.

WARNING

If there is any reason to suspect that a projectile is obstructing the barrel, immediately unload the firearm (See Unloading Instructions) and check the chamber and the bore. A wad, shot or some other matter may be lodged some distance down the barrel where it can not easily be seen. Check the bore by using a cleaning rod to pass through the barrel. If a blockage is in the bore, **DO NOT ATTEMPT TO SHOOT IT OUT WITH ANOTHER CARTRIDGE, OR BLOW IT OUT WITH A BLANK CARTRIDGE OR A CARTRIDGE FROM WHICH THE SHOT HAS BEEN REMOVED. SUCH TECHNIQUE(S) CAN GENERATE EXCESSIVE PRESSURE, DAMAGE THE FIREARM AND CAUSE SERIOUS PERSONAL INJURY.** If the blockage can be removed with a cleaning rod, clean any unburned powder grains from the bore, chambers and mechanism before resuming shooting. If the blockage can not be dislodged by tapping it with a cleaning rod, take the firearm to a gunsmith.

WARNING (EYE AND EAR PROTECTION)

When shooting, full eye and ear protection is mandatory at all times. Shooters and spectators must wear shooting glasses and hearing protection to prevent eye injury and hearing loss. Vision and hearing impairment can occur with only one moment of non-protection.

WARNING (Mechanical Malfunctions)

STOP SHOOTING IMMEDIATELY AND UNLOAD YOUR FIREARM if your firearm develops: a mechanical malfunction; binding or stoppage; spitting powder/gas; a cartridge primer is punctured; a cartridge case is bulged or ruptured; or the sound on firing does not sound quite right. Do **NOT** try one more shot but unload your firearm and take it and the ammunition to a qualified gunsmith or send the firearm back to European American Armory Corp. for examination. Do not assume that the shotgun is empty merely because you checked the chamber. You must also check the bore for any fired shot or wad jammed inside the barrel.

BASIC PARTS OF YOUR SHOTGUN

EXTERNAL CONTROL PARTS:

Trigger Block Safety: The safety mechanism of the shotgun provides protection against accidental and unintentional discharge under normal usage when properly engaged and in good working order. The safety mechanism is not a substitute for following the rules of safe gun handling. Do not disengage the safety unless you are ready to fire the shotgun. **MAKE SURE YOU UNDERSTAND HOW THE SAFETY WORKS BEFORE YOU LOAD OR USE THE SHOTGUN.**

WARNING

Make sure you understand how the safety works before you load or use the shotgun. The safety mechanism is not a substitute for following the rules of safe gun handling.



SAFETY ON

Figure 6



SAFETY OFF

Figure 7

The safety mechanism is a cross-bolt style safety button located behind the trigger. To place the safety in the “on” or “safe” position, push the button all the way to the right. When in the “on” or “safe” position, the safety blocks the rearward motion of the trigger, see **Figure 6**. To place the safety in the “off” or “fire” position, push the button all the way to the left. When in the “off” or “fire” position, a red ring is exposed on the left side of the safety button. You have now disengaged the safety and the shotgun is in the ready-to-fire position. See **Figure 7**.

WARNING

Do not touch the trigger while moving the safety button. When operating the safety button, make sure you push it to the full extent of its travel in the desired direction, either fully “on” or fully “off.” Half-safe or partially-safe is **UNSAFE**.

When the Red Ring is showing the shotgun **WILL FIRE** when the trigger is pulled!! Do not disengage safety unless you are ready to fire the shotgun.

Locking Lever: The locking lever is a lever-like protrusion extending from the rear of the trigger guard. See **Figure 8**. The locking lever is used to break open the action to



Figure 8



Figure 9

load and/or unload the shotgun. To break open the action, fully depress or squeeze the locking lever toward the stock. See **Figure 9**.

WARNING

When operating the locking lever, you must: (1) make sure the safety mechanism is in the “on” or “safe” position; (2) keep your fingers away from the trigger and outside of the trigger guard; and (3) control the direction of the muzzle of the shotgun.

Cocking Indicator: The cocking indicator is a protrusion from the top back of the receiver. If the internal firing mechanism is cocked, the cocking indicator protrudes from the receiver. See **Figure 10**.

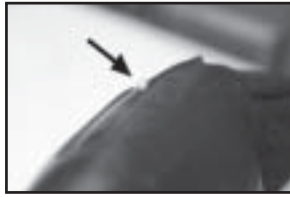

Figure 10



Figure 11

If the firing mechanism is not cocked, the cocking indicator retracts and does not protrude from the receiver. See **Figure 11**.

WARNING

The cocking indicator is merely an aid to help you confirm when hunting or shooting that your shotgun is cocked and ready-to-fire. **NEVER** rely on the status of the cocking indicator to justify careless handling of your shotgun. The cocking indicator may be broken or obscured. Always handle your shotgun as if it were loaded, cocked and ready to fire.

Trigger: The trigger is located inside the trigger guard. See **Figure 12**. If you pull the trigger with the safety in the “off” or “fire” position, the shotgun will fire.

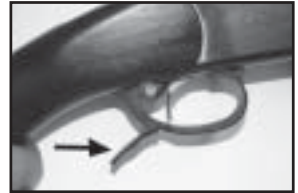

Figure 12

WARNING

NEVER pull the trigger until you are actually ready to fire. Keep your fingers off the trigger and outside of the trigger guard until you are ready to pull the trigger and fire the shotgun. When opening and closing the action and when engaging or disengaging the safety mechanism, make sure your fingers are outside of the trigger guard and away from the trigger.

Forend: The forend is the wooden grip piece which attaches to the barrel and locks the barrel to the receiver. See **Figure 13**. The forend has a mechanical latch



Figure 13



Figure 14

which is used to lock and unlock the forend to the barrel. See **Figure 14**. **NEVER** attempt to fire your shotgun without having the forend locked in its proper position on the barrel.

DIRECTIONS FOR ASSEMBLY OF SHOTGUN:

WARNING

Before you begin to assemble the shotgun, you **MUST (1)** look down the barrel from the breech end to make sure there is no ammunition in the chamber or obstruction in the barrel, and **(2)** make sure the safety is in the “safe” position.

Your shotgun was shipped with the barrel assembly (barrel and forend) detached from the receiver assembly. To assemble the shotgun, follow these instructions:

1) Remove the plastic bags or wrapping covering the parts. Then remove the forend from the barrel by pulling outward on the mechanical lever in the lower midsection of the forend and tipping the forend out and away from the barrel while pulling the lever out. Never force the forend off the barrel. See **Figure 15**.



Figure 15

2) Now fully squeeze/depress the locking lever and hold with one hand. See **Figure 16**.



Figure 16

3) Holding the barrel with one hand, engage the lower locking lug located on the lower portion of the barrel with the receiver. The half round cut out on the lower locking lug fits around the round bar in the forward lower portion of the slot in the receiver. With the barrel engaged into the receiver, swing the barrel up into the locked position, release the locking lever, which should move back to the fully locked position. See **Figure 17(a,b,c)**.



Figure 17a



Figure 17b



Figure 17c

4) Now that the barrel has been locked into the receiver, you must reattach the forend to the barrel. Pull the forearm latch out and place the forend on receiver. With an upward swinging motion lock the forend onto the barrel. Do not force

the forend into its locked position. While it may be necessary to push the latch into its final flat position, never force the latch into position. See **Figure 18**.



Figure 18

LOADING AND UNLOADING YOUR SHOTGUN

⚠ WARNING Never load or fire the shotgun unless the barrel is locked into position on the receiver, and the forend is locked in to the receiver and barrel.

⚠ WARNING Make sure the shotgun is pointed in a safe direction and the trigger block safety is engaged at all times while loading and unloading. **NEVER** allow your fingers or other objects to contact the trigger while loading or unloading.

⚠ WARNING Do not disengage the trigger block safety until you are ready to fire and have the gun pointed safely downrange.

⚠ WARNING
Do not load shotgun until you are ready to fire.

TO LOAD:

1) Make sure the ammunition that you are using is the correct size and gauge. The barrel is marked with the gauge and chamber size. Barrels marked 3" (76mm) will use only 2 3/4" (70mm) or 3" (76mm) shot shells and must not be used with 3 1/2" (89mm) shells. Barrels marked with 2 3/4" (70mm) will use only 2 3/4" (70mm) and must not be used with or 3" (76mm) or 3 1/2" (89mm) shells.

2) Visually inspect the chamber and barrel for obstructions by breaking open the shotgun by depressing the locking lever and tipping the barrel down. The chamber and barrel should be free of oil or grease or obstructions. See **Figure 19**.

3) After inspection, load the correct type of shot shell into the chamber making sure that the shell is flush



Figure 19

with the extractor (see **Figures 20 & 21**), then close the action by swinging the barrel up until it locks into the receiver and the locking latch should move to its fully locked position. See **Figure 22**. If the locking lever does not move to the fully locked position break open the action again and check to see if the shot shell is fully seated in the chamber. If the shell is fully seated then re-close the action. If the shot shell is not fully seated check the chamber for blockage and check the shell for deformation and retry closing the action once more. If the shell is the correct type and the chamber is not blocked and the shell is not deformed and the locking



Figure 20



Figure 21

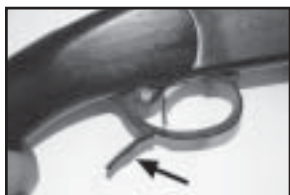

Figure 22



Figure 23

lever does not move to its fully locked position (see **Figure 23**) unload the gun (follow Unloading Instructions) and have a competent gunsmith look at the gun or return the gun to European American Armory Corp. for inspection. Do not force the shotgun closed.

lever does not move to its fully locked position (see **Figure 23**) unload the gun (follow Unloading Instructions) and have a competent gunsmith look at the gun or return the gun to European American Armory Corp. for inspection. Do not force the shotgun closed.

TO UNLOAD:

- 1) Break open the shotgun by depressing the locking lever and tipping the barrel down. See **Figure 24**.
- 2) Remove the shell from the chamber by grabbing it by the rim of the shell and pulling it from the chamber. See **Figure 25**.
- 3) Visually check the barrel to make sure that it is free from obstructions. See **Figure 26**.



Figure 24



Figure 25





Figure 26

FIRING YOUR SHOTGUN

WARNING

Never load a cartridge into the chamber until you are ready to fire the shotgun

 **WARNING** Do not disengage the trigger block safety until the shotgun is pointed in a safe direction and you are ready to fire.

 **WARNING** If a cartridge does not fire and the trigger has been pulled and the trigger block safety is disengaged...Stop! and do the following: **a)** Make sure the gun is pointed in a safe direction **b)** Engage the trigger block safety **c)** Wait 60 seconds **d)** Follow the instructions above for unloading the shotgun.

If during firing the sound of any cartridge is noticeably softer or louder than the previous cartridge fired, Stop! Do not load another cartridge or fire another cartridge and do the following: **a)** Make sure the gun is pointed in a safe direction **b)** Engage the trigger block safety **c)** Follow the instruction above for unloading the shotgun **d)** With the shotgun unloaded visually inspect the shotgun for barrel blockage or damage and inspect the mechanical operation and receiver of the shotgun for damage before continuing.

READ, UNDERSTAND AND FOLLOW ALL WARNINGS AND INSTRUCTIONS IN THIS MANUAL BEFORE FIRING THE SHOTGUN.

TO FIRE THE SHOTGUN:

- 1) Make sure the shotgun is pointed in a safe direction with the trigger block safety engaged.
- 2) Make sure you are wearing eye and ear protection.
- 3) Keep your fingers away from the trigger. See **Figure 27**.
- 4) Push the trigger block safety to the “off” or “fire” position with the red ring showing. See **Figure 28**.
- 5) With the butt stock held firmly against your



Figure 27



Figure 28

shoulder and the barrel pointed towards your intended target, place your trigger finger on the trigger. The shotgun will fire when you pull or squeeze the trigger with the requisite force. See **Figure 29**.



Figure 29

⚠ WARNING Once you have fired the shotgun, immediately push the trigger block safety to the “on” or “safe” position. Then follow the unloading instructions above while keeping the muzzle pointed in a safe direction.

DIRECTIONS FOR DISASSEMBLY OF THE SHOTGUN:

1) Make sure the shotgun is unloaded (**FOLLOW UNLOADING INSTRUCTIONS**) and pointed in a safe direction.

2) Make sure the trigger block safety is engaged in the “on” or “safe” position. See **Figure 30**.

3) Remove the forend from the barrel by pulling out the mechanical lever in the lower center of the forend and removing the forend in a downward outward swinging motion. Never force the forend off the barrel and receiver. See **Figure 31**.

4) With the barrel and receiver supported with one hand, depress the locking lever fully and tip the barrel down until it disengages from the receiver. Check the barrel for obstructions, damage and blockage after removal. See **Figure 32**.



Figure 30



Figure 31



Figure 32

⚠ MANUFACTURER'S WARNING:

This firearm was manufactured to properly perform with the original parts as designed. It is your duty to make sure any parts you buy are correctly installed and that neither replacements nor originals are altered or changed. Your gun is a complex tool with many parts that must relate correctly to other parts for safe and accurate operation. Putting a gun together wrong or with modified parts can result in a damaged gun, or personal injury or death to you or others. Always let a qualified gunsmith work on your gun or at least, check any work not performed by a gunsmith. Firearms safety is your primary concern. **THE GUN OWNER MUST ACCEPT FULL RESPONSIBILITY FOR THE CORRECT REASSEMBLY AND FUNCTIONING OF THE FIREARM AFTER ANY DISASSEMBLY OR REPLACEMENT OF PARTS.**

TO CLEAN AND MAINTAIN YOUR SHOTGUN:

- A) Follow procedures for unloading shotgun as described previously.
- B) Follow procedures for disassembly of shotgun as described previously.
- C) Materials needed to clean this shotgun are: a cleaning rod, cotton bore patches, brass bore brush, powder solvent, a small soft brush and good quality gun oil.

 **WARNING:** Lead or lead compounds are known to the State of California to cause cancer, birth defects, reproductive toxicity, and other serious physical injury. Those who clean firearms should take protective measures to avoid contact or exposure to such chemicals.

D) Using the bore brush with powder solvent, scrub the interior of the barrel and chamber to remove any powder and lead residue in the bore. Always and lastly, swab the interior of the barrel with cotton patch with gun oil to coat and protect the bore and chambers from rust and corrosion.

E) Any powder fouling on the firing wall, barrel, etc. can be easily cleaned with a brush and powder solvent.

F) All external surfaces should be wiped down with a light coat of rust preventative. Avoid using too much oil as powder, dust or other foreign material may get trapped in the oil. This could lead to congealed deposits which may interfere with the safe and reliable operation of the shotgun.

G) **USE CAUTION** while using solvents in gun bore cleaning. Prolonged or excess contact with solvents can damage the gun's bluing and finish. Be sure to wipe away all excess solvent and then lubricate with oil.

H) A gun should be cleaned after firing. In addition, external parts should be wiped with an oiled cloth after handling. A light oil is ordinarily all that is necessary in cleaning if the gun has not been fired or fired very little. If a gun is used frequently, it must be cleaned after each firing and regularly serviced by a professional gunsmith. If the gun has been stored, remove all excess oil and/or grease before firing. Always check to be sure that no cleaning patch or other obstruction remains in the bore or chambers before firing.

DANGER — AMMUNITION WARNING

Firearms may be damaged and serious personal injury or death to the shooter or bystanders may result from any condition which contributes to the generation of excessive pressure or uncontrolled release of gas within the firearm. Such adverse conditions can be caused by bore or chamber obstructions, propellant powder overloads or by defective, incorrect or improperly loaded and assembled cartridge components. Even the strongest firearm can be blown up as a result of excessive pressure. It is extremely dangerous to use a cartridge whose pressure is greater than that developed by cartridges loaded to industry standards.

AMMUNITION (CARTRIDGES) NOTICE

We specifically disclaim responsibility for any damage, injury or death occurring in connection with or as the result of the use of European American Armory Corp. shotguns with faulty, nonstandard, remanufactured, hand loaded or reloaded ammunition or with cartridges other than factory cartridges for which the firearm was originally chambered.

LUBRICATION WARNING

Firing a shotgun with oil, grease or any other material even partially obstructing the bore may result in damage to the shotgun and personal injury to the shooter and those nearby. Do not spray or apply lubricants directly on ammunition. If the powder charge of a cartridge is affected by the lubricant, they may not fully ignite yet the energy from the primer and/or powder may still be sufficient to push the projectile or wad into the bore where it may become lodged. Firing a subsequent cartridge into the obstructed bore will damage the shotgun and may cause personal injury to the shooter and those nearby. Use lubricants properly. You are responsible for the proper care and maintenance of your firearm and ammunition.

ONE YEAR LIMITED WARRANTY

This European American Armory Corp. firearm is warranted to the original retail customer for One Year from date of purchase against defects in material and workmanship. All parts and labor or replacement **at our option** are covered. Wood Stock and Wood Forend are not covered by the One Year Warranty. The warranty on the wood stock and forend is 60 days from purchase and only covers manufactured and material defects.

Transportation to and from our repair facilities, government fees, damage caused by failure to perform normal maintenance, sales outside the United States, damage due to use of high velocity, high pressure, reloaded or other nonstandard ammunition, or any unauthorized repair, modification, misuse, abuse, or alteration of the product is not covered by this Limited Warranty.

Any implied warranties, including the implied warranties of merchantability and fitness for a particular purpose, are limited to one year from date of original retail purchase. Consequential or incidental damages and/or expenses, or any other expenses are not covered by this warranty.

To obtain warranty performance send your firearm with proof of retail purchase, freight prepaid to:

**European American Armory Corp.
3855 North U.S. Highway 1
Cocoa, Florida 32926**

NOTICE: It is illegal to ship a firearm with ammunition in the firearm or in the same packaging. Firearms and ammunition must be shipped separately. For information about shipping ammunition, call European American Armory Corp. at (321) 639-4842.

W A R N I N G—ALTERATIONS OR MODIFICATIONS

Altering or modifying parts and/or internal safeties is dangerous and will void the warranty. This shotgun was manufactured to perform properly with the original parts as designed. It is your duty to make sure any parts you buy are made for this firearm and are installed correctly and that neither the replacements nor originals are altered or changed. Your gun is a complex precision tool with many parts that must relate correctly to other parts in order for proper and safe operation. Putting a gun together wrong or with incorrect or modified parts can result in a damaged gun, danger, and personal injury or death to you and others through malfunction. Always have a qualified gunsmith work on your gun or at least check any work not performed by a gunsmith.

YOUR OWNER'S MANUAL

Always keep this manual with your firearm. Make sure you understand all the warnings, operation instructions and safety procedures. When you lend, give or sell the firearm, be sure this manual goes with it. You can get a copy of this manual from European American Armory Corp. upon request.

ALL PARTS ORDERS ARE SUBJECT TO A \$10.00 CHARGE FOR SHIPPING AND HANDLING. Please state Model, Caliber, Serial Number, and Finish Color when ordering. For parts, information and service contact: European American Armory Corp., 402 Richard Road, Rockledge, FL. 32955, Phone: (321) 639-4842.

PARTS LIST

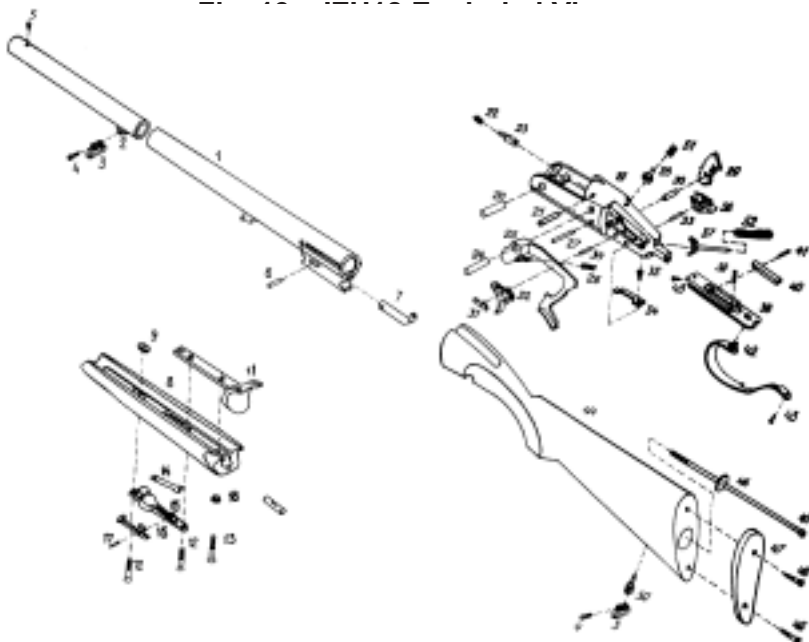

- | | | |
|----------------------|------------------------------|---------------------------------|
| 1. barrel with hook | 19. receiver | 37. pusher |
| 2. sling swivel base | 20. hinge pin | 38. base plate |
| 3. sling swivel ring | 21. firing pin dowel | 39. locking lever detent spring |
| 4. pin | 22. firing pin spring | 40. locking lever detent |
| 5. front sight | 23. firing pin | 41. locking lever detent pin |
| 6. extractor pin | 24. locking lever pin | 42. trigger guard |
| 7. extractor | 25. locking lever | 43. trigger guard screw |
| 8. forend | 26. locking lever spring | 44. stock |
| 9. forend nut | 27. locking lever spring pin | 45. screw |
| 10. hinge screw | 28. indicator | 46. washer |
| 11. forend hinge | 29. hammer | 47. butt plate |
| 12. hinge screw | 30. hammer pin | 48. woodscrew |
| 13. hinge screw | 31. sear | 49. woodscrew |
| 14. spring | 32. trigger | 50. stock sling swivel base |
| 15. catch housing | 33. trigger pin | 51. indicator spring |
| 16. forend catch | 34. trigger spring | 52. mainspring |
| 17. pin | 35. trigger spring screw | |
| 18. forend bushing | 36. safety | |

IZH18 EXPLODED VIEW ENLARGED

Fig. 1 – IZH18

1. barrel with hook
2. extractor spring
3. extractor
4. extractor pin
5. pin retainer
6. plunger
7. plunger spring
8. extractor sear
9. extractor sear pin
10. supporting pin
11. base plate
12. receiver

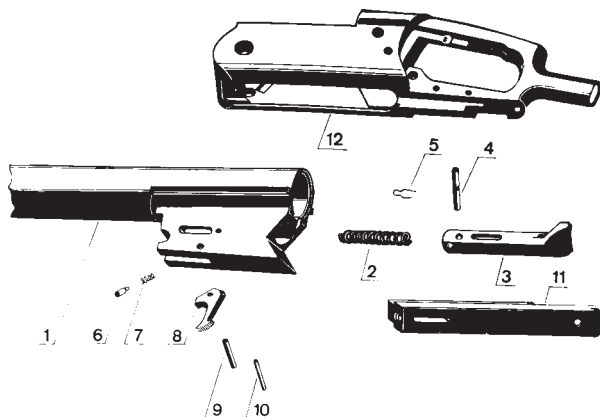

CHOKE TUBES

WARNING Never install or remove choke tubes while the firearm is loaded. Only install or remove choke tubes with the firearm unloaded, the action open and the trigger block safety engaged.

Screw in Chokes Symbols/Markings (This is an option—not all IZH18 shotguns have this feature)

The end of the choke tubes are marked with slashes to identify the choke constriction:

- / - Full
- // - Improved Modified
- /// - Modified
- //// - Improved Cylinder
- Cl - Cylinder

WARNING
MAKE SURE YOU FULLY TIGHTEN THE CHOKE TUBE.

Shooting with a loose choke tube can cause damage to your shotgun.

Additional information on screw choke tubes:

A) Only tighten or loosen choke tubes with flat key wrench supplied with shotgun. Note: wrench (and extra choke tube or tubes if supplied) are under the cardboard in front of the shotgun receiver in the box.

B) Never shoot the shotgun with a partially installed choke tube.

C) IZH18 shotguns are available with fixed choke or screw choke barrels. There are two types of screw chokes available: lead shot choke tubes and steel shot choke tubes. When installed, steel shot choke tubes protrude approximately 3/4" from the muzzle end of the barrel and the mating lip will be flush with the end of the barrel. When installed, lead shot choke tubes fit flush with or slightly below the muzzle end of the barrel. If you have lead shot choke tubes and intend to shoot steel shot cartridges or slugs, then you must use only the IC or Cylinder tubes. **DO NOT** fire steel shot or slugs in Modified, Improved Modified or Full lead shot choke tubes. If you have steel shot choke tubes, you may fire steel shot cartridges through any of those choke tubes. **DO NOT** fire slugs in Modified, Improved Modified or Full lead shot choke tubes or steel shot choke tubes.

D) Correctly installed choke tubes: Lead shot choke tubes should fit flush or slightly below the muzzle end of the barrel. Steel shot choke tubes will protrude out from the barrel about 3/4" and the mating lip will be flush with barrel end.

E) Before using the shotgun make sure that the choke tubes are installed correctly.

F) Keep choke tubes lubricated and installed. Never fire the gun with out a choke tube installed. Handle choke tubes carefully since the leading edge is very thin.

Notes on Shot Material and Chokes:

1) Shells using Bismuth or Tungsten-Matrix shot are subject to the same barrel and choke tube limitations as lead shot. Shells using Tungsten-Iron shot or Hevi-Shot are subject to the same barrel and choke tube limitations as steel shot.

2) On fixed choke guns, shells loaded with steel, Tungsten-Iron or Hevi-Shot should be fired only in IC or Cylinder barrels. **DO NOT** fire steel, Tungsten-Iron or Hevi-Shot shells in fixed barrels with Modified, Improved Modified or Full choke barrels. Lead, Bismuth and Tungsten-Matrix may be fired in all fixed choke barrels.

3) On fixed choke guns, slugs may be fired in only IC and Cylinder barrels. **DO NOT** fire slugs in fixed choke barrels with Modified, Improved Modified or Full chokes.

If you would like to buy extra choke tubes (skeet, trap, extra full, etc.) call 1-321-639-4842.

 **WARNING**

Children are attracted to and can operate firearms that can cause severe injuries or death.

Prevent child access by always keeping guns locked away and unloaded when not in use. If you keep a loaded firearm where a child obtains and improperly uses it, you may be fined or sent to prison.

 **ADVERTENCIA**

A los niños les atraen las armas de fuego y los pueden hacer funcionar. Ellos pueden causarse lesiones graves y la muerte.

Evite que los niños tengan acceso a las armas de fuego guardándolas siempre con llave y descargadas cuando no las esté utilizando. Si usted tiene un arma de fuego cargada en un lugar en el que un niño tiene acceso a ella y la usa indebidamente, le pueden dar una multa a enviarlo a la cárcel.

Importer:

European American Armory Corp.
3855 North U.S. Highway 1
Cocoa, FL 32926

Manufacturer:

Izhevsky Mekhanichesky Zavod
8, Promyshlennaya str.,
426063 Izhevsk, Russia