

MANUAL

TEC-9

TEC-9 MINI

TEC-9 STAINLESS



INTRATEC USA

WARNING

There are no excuses for unsafe handling of firearms, only regrets.

Never accept or pick-up a firearm without removing the magazine, checking the chamber to assure it is empty and placing the weapon on safe.

Always make sure the muzzle is pointed in a safe direction at all times.

Never store a firearm with a cartridge in the chamber or not on safe.

Never store firearms and ammunition together, keep them locked up and away from children or any incapacitated persons.

Never keep a loaded firearm in the home, car, boat or R.V.

Never attempt when carrying a loaded firearm to climb a wall or any obstacle.

Never touch the trigger when working the operating handle.

Never tamper with the magazine or use magazines not manufactured by INTRATEC.

Never alter any components of your firearm.

Never take medications, drugs or alcohol when handling firearms.

Never use old ammunition, use only recommended ammunition.

Never load or unload a firearm without assuring the muzzle is pointed in a safe direction.

Never load a firearm except immediately before shooting.

Never handle firearms without proper shooting glasses and ear protection.

Never place finger on trigger until ready to fire.

Never place hands near the muzzle at any time.

Never point a firearm at anything you do not intend to shoot.

When firing, make sure your "audience" is ALWAYS 5 feet in back of you and wearing proper ear and eye protection.

Never shoot at any water surface or any surface where a ricochet can occur.







Never shoot until you are sure of your backstop and what lies beyond it.

If the gun does not discharge after pulling trigger, do not change its down range position for at least 30 seconds, you could be having a "hang fire".

All malfunctions must be reported immediately and the use of the firearm discontinued until the problem is corrected by the manufacturer.

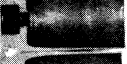
If you do not understand how to operate any of our products or have any questions about their safe handling, please write to us.

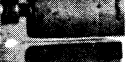
9 mm LUGER CASE DESIGN

Make	Sample	Wallthickness	Suitability
Norma		.037	Excellent
NATO Mil		.032	Excellent
S&W		.029	Very Good
Federal		.027	Recommended
Eagle		.027	Recommended
Frontier		.027	Recommended
Speer CCI		.022	Do Not Use
Winchester		.021	Do Not Use
*PMC		.018	Do Not Use

*.028 Wallthickness Manufactured after Feb. 28, 1984 Recommended.

The chart above reveals the structural design of the most popular case manufacturers.

Please refer to this chart before using any type of ammunition in your TEC-9. **Do not use any cases with a wallthickness of less than .027, also do not use any reloaded ammunition regardless of wallthickness.**

The reason behind this recommendation is that, in all blowback designed firearms like in the TEC-9, as a round is fired, the case begins to move rearward as the expanding gases are at its highest pressure. At this moment a small back portion of the case walls are not supported by the chamber walls. Therefore, making the rear wallthickness a critical factor.

If you have ammunition manufactured by other than the specified, please write to us and we will be glad to analyze it and advise of its use.

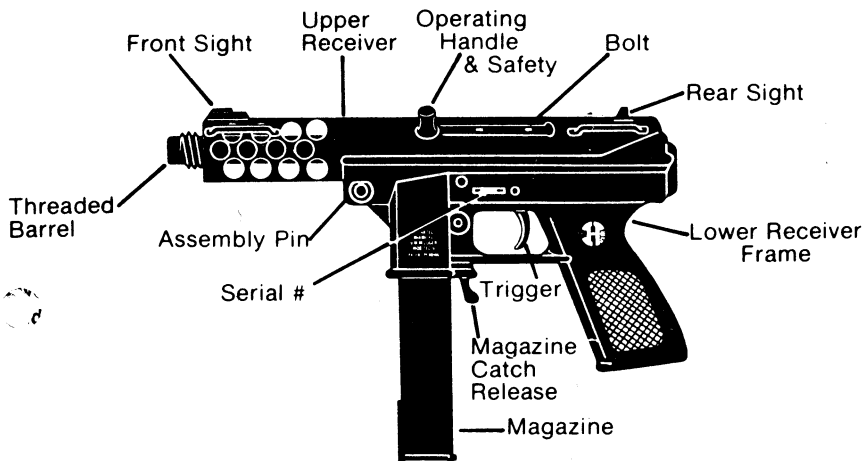

INTRODUCTION

The INTRATEC TEC-9 is a radically new type of semi-automatic pistol, designed to deliver a high volume of firepower.

It is designed and manufactured in the United States. Extensive research and computer assisted development has been incorporated into this model. Thanks to the advanced design and modern high speed manufacturing techniques, we can assure low cost, without compromising quality in materials and workmanship.

DESCRIPTION

The TEC-9 is a semi-automatic pistol which operates by elementary blowback and closed bolt position. The sights are standard open combat sights. The push in type safety securely locks the firing pin from traveling forward. It can be fired by one or two hands from most shooting positions.

TECHNICAL SPECIFICATIONS

	* TEC-9	† TEC-9M
Ammunition	9 mm Luger or Parabellum	
Weight unloaded	50 oz.	44 oz.
Weight of loaded magazine	22 oz.	12 oz.
Length	12½ in.	10½ in.
Barrel length	5 in.	3 in.
Sight radius	10 in.	7¼ in.
Muzzle velocity	1200-1400 fps.	1100-1300 fps.
Practical range, off hand	50 yds.	25 yds.
with rest	100 yds.	50 yds.
Magazine capacity	36 rds.	20 rds.

* TEC-9S SAME SPECS AS TEC-9

† TEC-9MS SAME SPECS AS TEC-9M

CONSTRUCTION

The tube shaped upper receiver houses the barrel and bolt. The forward end is provided with ***ventilation holes** for cooling of the barrel and improving sustained fire. The left side of the upper receiver has a slot for the operating handle.

The high impact frame forms the magazine well and grip. It also houses the trigger mechanism. The frame is attached to the upper receiver by an assembly pin and a disk at the rear.

The bolt is recessed at the back to house the striker and firing pin.

FUNCTIONING

When ready to fire the bolt is in a closed position, the striker and firing pin are held in the rear position by the sear. When the trigger is pressed the disconnecter pulls down the sear, which disengages the striker. The striker carries the firing pin forward, igniting the chambered round.

Simultaneously, as the gas pressure accelerates the bullet, the case pushes the bolt rearwards. Due to the much greater mass of the bolt compared with the bullet, the bolt has only moved about 1/16" when the bullet leaves the barrel. On its way rearwards, the bolt by the combined actions of the extractor and ejector, throws out the empty case. At the rear, the bolt is stopped by the increasing force of the recoil spring and driven forward again. The bolt on its way forward catches the top round in the magazine and feeds it into the chamber and then the TEC-9 is ready to fire once again. The complete cycle will take .08 seconds.

INSTRUCTIONS FOR USE

Before proceeding to use this weapon a word of caution is in order. The pistol is as safe to handle and use as we can make it, but there is no foolproof firearm. **Be sure that the muzzle is pointing in a safe direction at all times, whether the gun is loaded or not.** Make safe gun handling a habit. **Do not attempt to load and fire this weapon until you are thoroughly familiar with all its safety features and fully understand the operation of this firearm.**

LOADING THE MAGAZINE

Press the cartridges down between the magazine lips. As with all magazines, a light tap on the back ensures a uniform positioning of the cartridges.

*Not found on TEC-9M, TEC-9MS.



SAFETY

Push the operating handle completely in. This blocks the firing pin from traveling forward.

NOTE: The safety will not engage if the striker and firing pin are in the forward position. The bolt can not be cocked in the safe position.

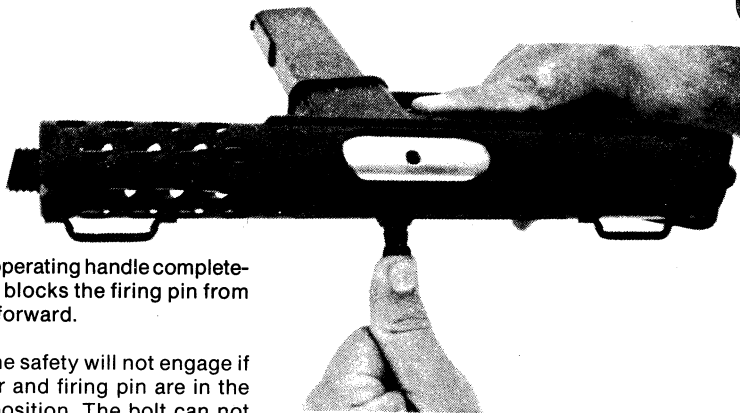

BEFORE LOADING

Be sure barrel & chamber are clean and free of grease or obstructions.

LOADING THE TEC-9

With bolt forward and operating handle in the safe position, insert a loaded magazine into the magazine well, finger away from trigger.

Make sure to pull out the operating handle from the safe position, and then pull the handle all the way to the rear, so the striker becomes engaged by the sear.

When release the handle, causing it to move forward and chamber the first round. **Warning: During this operation, keep fingers away from trigger and be sure the muzzle is pointing in a safe direction.**

The TEC-9 is now ready to fire, keep finger away from trigger until you are ready to shoot.



UNLOADING

Push the operating handle into the safe position. Press magazine catch forward and remove the magazine. Keeping fingers away from the trigger, remove safety and pull operating handle out and to the rear, causing any chambered rounds to be extracted. Work the operating handle back and forth 3 to 4 times and check that there are no cartridges in the chamber or on the bolt face.

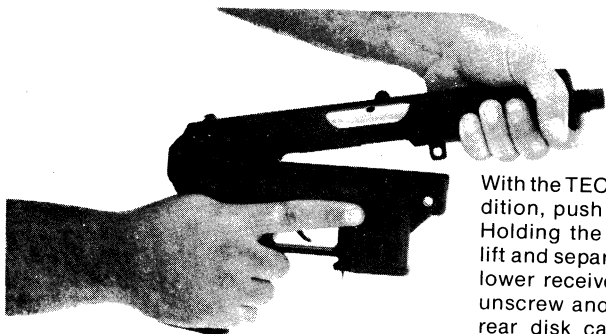

DISASSEMBLY

With the TEC-9 in the unloaded condition, push out the assembly pin. Holding the upper receiver firmly, lift and separate the upper from the lower receiver. Using quarter coin unscrew and remove the threaded rear disk cap. Pull the operating handle all the way back to the operating handle disassembly notch and lift and remove operating handle from bolt assembly. **Additional disassembly is not recommended for normal cleaning and inspection.**

REASSEMBLY

Assemble in reverse order. Note: Firing pin in bolt must be pulled to the rear and locked in place by pushing in safety before bedding upper receiver to lower receiver. Also lightly grease rear buffer to prevent binding before assembly of threaded rear disk cap.

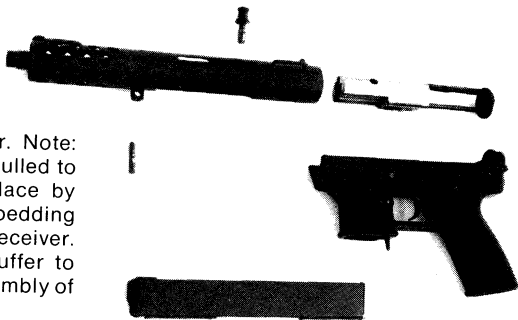

SHOOTING

Thanks to its dimensions and designs, the TEC-9 can be used in modes of fire impossible with most handguns. The illustrations below show four recommended positions found practical under extensive field tests.

WARNING: If, while firing, a weak or softer than Normal Report is heard, **stop immediately**, unload and check for barrel obstruction. **Never attempt to shoot out an obstruction, serious injury may result.** Your Gun cannot be fired until the barrel obstruction is removed. If you cannot remove the obstruction please return at once to the factory for safe removal.



For short range fast action

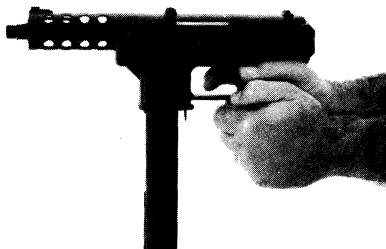

Weaver-stance for distance
up to 50 yds.



Prone with magazine rest at
ranges up to 150 yds.



Hipfire at shortest range

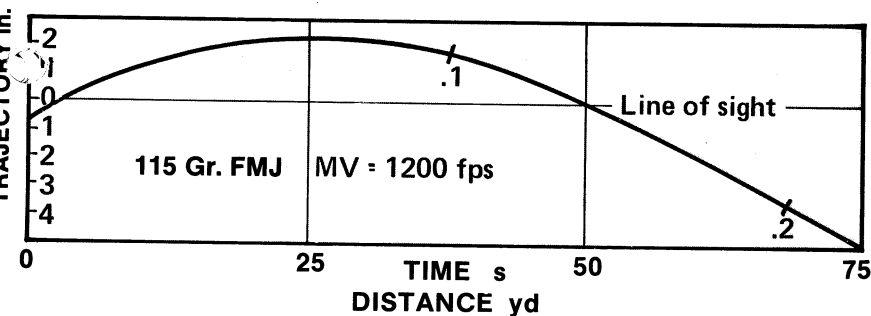

MALFUNCTIONING

Stoppages in the TEC-9 are almost invariably caused by the ammunition or its' maintenance condition. Irregular or very short ejection indicates underpowered cartridges.

Unreliable feeding indicates damaged magazine lips or unsuitably shaped bullets. You should also avoid unnecessary dry fire, which causes the bolt face and or the firing pin to be damaged.

General Rule: Place the TEC-9 on safe
Remove the magazine
Remove misfired or jammed cartridge

If any of the above problems are not solved by cleaning, immediately discontinue use of the firearm and contact INTRATEC to report malfunction and return for service.

WARRANTY

Failure to return the enclosed warranty card within 7 days will void the life time warranty on this product. This TEC-9 is warranted against defects in materials and workmanship for life to the initial purchaser only. During the warranty period, INTRATEC will repair or, at its option, replace at no charge components that prove to be defective, provided the gun is returned, shipping prepaid, to INTRATEC.

This warranty does not apply if your TEC-9 has been damaged by accident or misuse, or after any service or modification by other than INTRATEC, INTRATEC shall not be liable for consequential damages. NO OTHER WARRANTY, EXPRESS OR IMPLIED, IS PROVIDED.

SERVICE

Should your TEC-9 require adjustment, repair, or refinishing, we sincerely recommend that the weapon be returned unloaded to the factory. There is no other way to insure that the work will be done in a properly equipped and staffed shop. All returns must include the following information: Full Name, Street Address, City, State, Zip Code and Phone #.

No gun will be accepted for repair if not complete or if received loaded.

NON-WARRANTY

Charges are very reasonable, being based on the cost of parts replaced plus a labor charge for the time spent on the job. **A letter of instruction must be enclosed with the gun**, and shipment by individuals must be made prepaid, properly packaged, via U.P.S. Adherence to these suggestions will prevent loss of time in handling at the factory.

When your TEC-9 arrives for service, it will be carefully inspected, together with your letter of instructions. Next, a quotation covering the total cost will be sent to you. No actual work will commence before receiving your approval of our quotation.

CARE AND CLEANING

To ensure proper functioning, the TEC-9 should be disassembled and cleaned at reasonably frequent intervals. Preferably always after shooting.

Use any good commercial solvent, and after cleaning, lubricate sparingly with a light weight gun oil. Outside surfaces may be protected from corrosion by coating lightly with rust inhibiting oil or grease. Be careful not to drop magazines, as they may be sufficiently deformed to cause malfunctions. Always keep ammunition away from gun during cleaning.

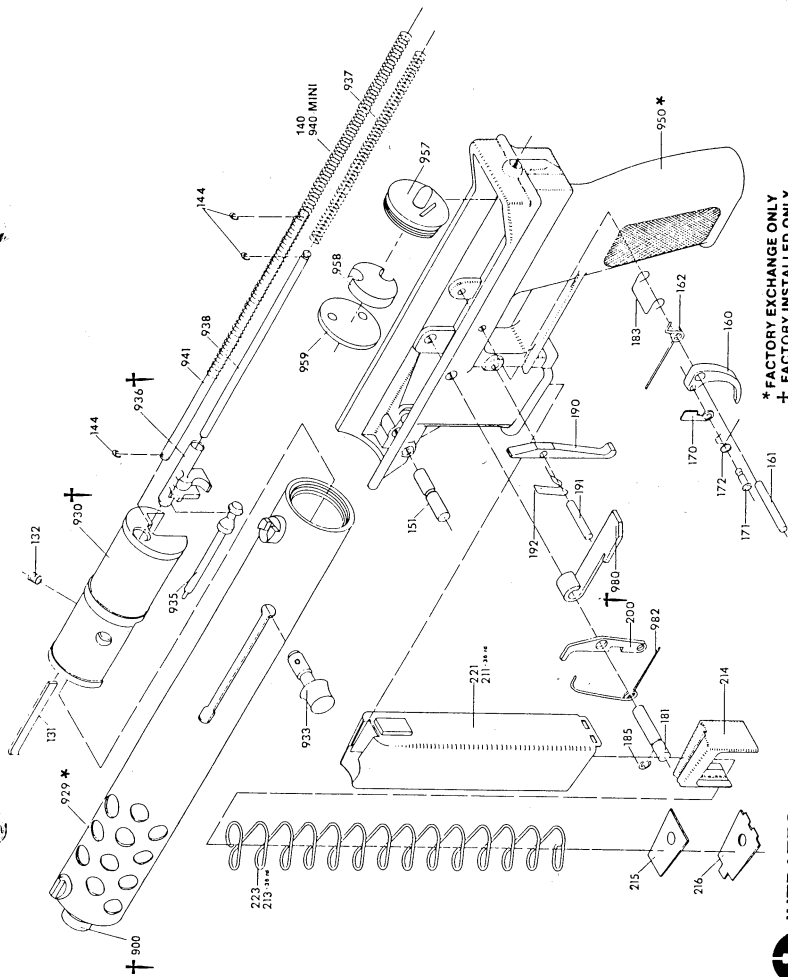

This schematic illustrates our current specifications. However, improvements are made from time to time and may not correspond exactly with your model. When ordering parts provide the serial number and date purchased.

* FACTORY EXCHANGE ONLY
 † FACTORY INSTALLED ONLY

INTRATEC
TEC-9

PARTS LIST

131 - Extractor	214 - Magazine Follower
132 - Extractor screw	215 - Magazine Locking plate
140 - Recoil Spring	216 - Magazine floor plate
144 - E-Ring (small)	221 - Magazine body (20 Rd.)
151 - Assembly pin	223 - Magazine Spring (20 Rd.)
152 - Rear cover	† 900 - Barrel
156 - Rear cover screw	* 929 - Upper receiver sub-assembly
160 - Trigger	† 930 - Bolt
161 - Trigger axis	933 - Operating handle
162 - Trigger spring	935 - Firing pin
170 - Disconnecter	† 936 - Striker
171 - Disconnecter axis	937 - Striker spring
172 - Disconnecter spring	938 - Striker spring guide
181 - Sear axis	940 - Recoil spring - mini
183 - Sear retainer	941 - Recoil spring guide
185 - E-ring (large)	* 950 - Frame
190 - Magazine catch	957 - Threaded rear Disk Cap
191 - Magazine catch axis	958 - Buffer
192 - Magazine catch spring	959 - Buffer plate
200 - Ejector	† 980 - Sear
211 - Magazine body (36 Rd.)	982 - Sear spring
213 - Magazine spring (36 Rd.)	

* Factory exchange only

† Factory installed only

For TEC-9 and TEC-9M parts add prefix 160 and part number above.

For TEC-9S and TEC-9MS stainless parts add prefix 165 and part number above.

**WHEN ORDERING PARTS PLEASE USE
PART NUMBERS AND FULL DESCRIPTION**

WARNING:

Improperly fitted part may cause dangerous malfunction, damage to the firearm or personal injury to the shooter. It is the purchaser's responsibility to have all replacement parts correctly fitted and installed.

Care has been taken in the preparation of this manual, however, INTRATEC U.S.A. INC. is not responsible for typographical errors and omissions contained herein.

Complete the order form below. Mail to INTRATEC with Money Order or send in order form alone with no Money Order, for C.O.D. Cash Deliveries.

Please Note: If order form is received with Money Order; shipping is prepaid by INTRATEC. ALL C.O.D. CASH Deliveries are not prepaid and will have C.O.D. Shipping Charges of \$2.00. ALL PRICES ARE SUBJECT TO CHANGE WITHOUT NOTICE.

TEAR HERE

Please send me the following items and quantities checked below.

✓	QUANTITY	ORDER No.	DESCRIPTION	PRICE
		175001	20 rd. Compact Magazine-Blue	24.95
		175002	20 rd. Compact Magazine-Stainless	34.95
		175003	36 rd. Hi-Capacity Magazine-Blue	32.95
		175004	36 rd. Hi-Capacity Magazine-Stainless	39.95
		175007	Deluxe Black Cordura case w/gold logo. 3 external mag pouches	32.95
		175009	Recoil Compensator Reduces Flash & Recoil	29.95
		175006	*Assault Grip Increases Control & Comfort	29.95
		175010	1" Nylon Sling With Keepers-Black	4.95
		175011	6" Barrel Extension - Non-Glare Blue	39.95
			SUBTOTAL	
			C.O.D. ORDERS	
			TOTAL	

*B.A.T.F. HAS RULED THAT THE ASSAULT GRIP MAY NOT BE PERMANENTLY ATTACHED TO THE TEC-9 OR SIMILAR MODELS

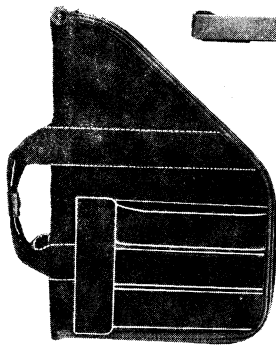

175007



175003



175009

175004

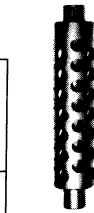

175011



175001



175002

Check one:

MONEY ORDER ENCLOSED

SEND MY ORDER C.O.D. CASH

Please Note: NO PERSONAL CHECKS WILL BE ACCEPTED. ALL PRICES ARE SUBJECT TO CHANGE WITHOUT NOTICE.



INTRATEC U.S.A. INC.
11990 S.W. 128th ST.
MIAMI, FLORIDA 33186