

How to make common things

John A. Bower

VEII

POWER

HOW TO MAKE COMMON THINGS.

8 12

HOW TO MAKE COMMON THINGS.

FOR BOYS.

BY

JOHN A. BOWER,

AUTHOR OF

"SCIENCE OF EVERY-DAY LIFE," "SCIENCE APPLIED TO WORK,"
"SIMPLE EXPERIMENTS," ETC.

With Illustrations. Third Edition.

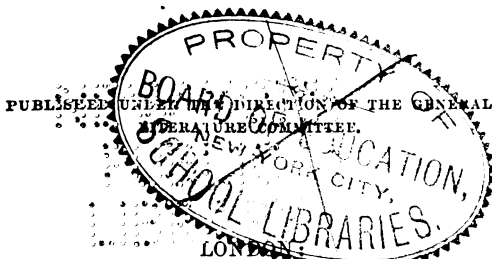

SOCIETY FOR PROMOTING CHRISTIAN KNOWLEDGE,
NORTHUMBERLAND AVENUE, W.C. ;
43, QUEEN VICTORIA STREET, E.C.
NEW YORK · E. & J. B. YOUNG & CO.

1895.
A.C.H.

THE NEW YORK
PUBLIC LIBRARY
583870
ASTOR, LENOX AND
TILDEN FOUNDATIONS
P. 1913 L

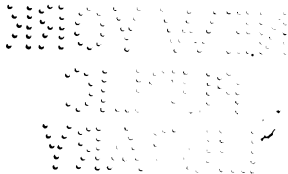

CONTENTS.

CHAP.		PAGE
I.	INTRODUCTION	7
	HOW TO MAKE A HAT-RAIL, ETC.	10
II.	HOW TO MAKE A BOX AND FIT IT	17
	TO MAKE A PAIR OF STILTS	25
III.	HOW TO MAKE A SET OF SHELVES FOR BOOKS OR OTHER OBJECTS	28
IV.	MAKING OF SEVERAL FORMS OF JOINT	40
V.	HOW TO DO OUTSIDE WOODWORK	58
	TO MAKE A SWING	60
	TO BUILD A SUMMER-HOUSE WITH TABLE AND SEATS	64
VI.	OUTDOOR BUILDINGS AND STRUCTURES	71
	TO MAKE A CARPENTER'S STOOL	82
	TO MAKE A SET OF STEPS	83
	TO MAKE A SHORT LADDER	84
	TO MAKE A DOOR	84
	TO MAKE FENCING	86
VII.	INDOOR WORK	89
	BUILDING BRICKS	97
	TO MAKE A READING-DESK OR MUSIC-STAND	98
	BOX FOR WINDOW GARDENING	100
VIII.	INDOOR WORK (<i>continued</i>)	104
	A PEN-TRAY	104
	A PAPER-KNIFE	105
	A BOOK-SLIDE	106
	STANDS FOR FLOWER-POTS	107

CHAP.		PAGE
	INDOOR WORK (<i>continued</i>).	
	TO MAKE TRAYS	108
	TO MAKE BRACKETS	108
	HANGING-SHELVES	111
	ARTISTIC TREATMENT OF WOODWORK	112
	WOOD CARVING	113
	INLAID PATTERNS	119
	FRETWORK	120
IX.	HOW TO MAKE PICTURE-FRAMES	123
	HOW TO BIND BOOKS AND MUSIC	132
X.	HOW TO MAKE MODELS	139
	TO MAKE A MODEL OF A YACHT OR OTHER SAILING VESSEL	150
XI.	WORKING IN METALS	166
	TO MAKE A SUPPORT FOR A FLOWER-POT OR A FLOWER-STAND	174
	TO MAKE A FIRE-SCREEN	178
	REPOUSSÉ WORK	180
	WIRE-WORKING	185
	METHODS OF SOLDERING	186
XII.	HOW TO MAKE SIMPLE APPARATUS FOR CHEMICAL EXPERIMENTS	191
XIII.	HOW TO COPY A MEDAL OR A CAST	205
XIV.	HOW TO MAKE SOME USEFUL ELECTRICAL APPLIANCES	214
	TO MAKE A GALVANOMETER	217
	TO MAKE AN ELECTRO-MAGNET	220
	HOW TO SOLDER TOGETHER WIRES AND FLAT METALLIC SURFACES	221
	TO MAKE A KEEPER TO THE ELECTRO- MAGNET	222
	ELECTROTYPING	222
	TO DO SILVER-PLATING	224
	TO MAKE A NEEDLE TELEGRAPH	225
	THE TELEPHONE	230
	GLOSSARY OF TERMS USED IN THIS BOOK	235
	INDEX OF ILLUSTRATIONS	237

HOW TO MAKE COMMON THINGS.

CHAPTER I.

INTRODUCTION.

IN these days all young people want "to make something." In most of our Public Schools, and in very many of our Elementary Schools, the importance of "tool-work" has been recognized, and workshops are now fitted up and put at the service of those who delight in "making things." In some of our technical departments provision is even made for doing metal-work. This little book is not intended for those who have such a complete set of tools as is provided under these circumstances, or who have a personal instructor in handicrafts, but for those who have the "desire and will" to do something by themselves without any elaborate appliances. Perseverance does most in the acquisition of this as in other branches of knowledge, and it is the "practice that makes perfect."

Nobody will learn to make a box, or fit up a cupboard, by merely reading about it, nor will the first attempts bring out such good results as later ones. The proper use of tools is of an immense

advantage, for a useful boy in a household can do many things to save the household purse. A lock, for instance, gets out of order. A lad handy with a screwdriver will take it off, look into it, and find it perhaps full of dust; he will brush it out, put a little oil into parts needing it, and at the same time the more inquisitive will learn how locks are made. The lock thus cleaned will be put together again and screwed into its place, and all done so neatly, that unless it is examined, persons generally would not be able to tell that it had been removed. Another lad may undertake the same bit of business, and by careless use of the screwdriver it may fly out of the grooves in the screws, scratch the parts surrounding the lock, chip off paint, and knock out pieces of wood, and be equally careless about the lock; pieces may slip out, and the whole thing be replaced so slovenly that the lock and its surroundings tell their own story.

Above all things care is necessary in doing even the smallest "job" well. A little thing well and neatly done always looks creditable, and it brings satisfaction to the one who has done it, and is always looked upon with some degree of pride by the parents of whoever has done it. Neatness and industry generally go together, while untidiness and slovenliness in work look like laziness, and proclaim a sort of "don't care" principle.

It will not be the fortune of all our readers to have special places where they can reserve a place for a workshop, or keep a room entirely to themselves for this sort of thing. Those who have, will, we hope, value it as a luxury; those who have not

can do a good deal of useful work without it. They may have to work in a back-kitchen or in a scullery; well, never mind—let them make the best of it. In the summer time many of them can work outside, and thus get more room.

As to tools, get some one who understands them to buy them for you, and second-hand tools can sometimes be had very cheaply. Do not, however, think those tools are the cheapest that cost the least money; they must combine good quality and fair price, or they may be very dear indeed.

For heavy work—by this we mean anything that comes outside model-making with thin wood, cardboard, and other light materials—you require a bench on which your work can be done. If you cannot get a small carpenter's bench, you can very likely fit up something for yourself that will answer the same purpose. A small deal table that is firm on its legs will answer the purpose; it must also be placed firmly against the wall. In addition to this a good strong stool is an advantage; it will do for holding wood on while it is being sawn.

In selecting your wood for making things it is of great advantage to have it dry and well seasoned. Boxes and packing-cases can often be bought cheaply, and form a good stock of wood for an amateur. Egg-boxes offer good lengths of wood for this purpose. The nails must be carefully drawn with pincers, and the lengths of wood stored up in some rather dry place. This wood is rough, and will afford material for planing, if you happen to possess such a tool as a plane. Successful planing can only be accomplished after some practice.

HOW TO MAKE A HAT-RAIL, ETC.

To begin with a very simple but a useful article—a hat-rail. Take a length of wood about $\frac{3}{4}$ inch thick, and saw off about 4 feet of it. To do this, mark off the distance by taking a rule—a two-foot rule you

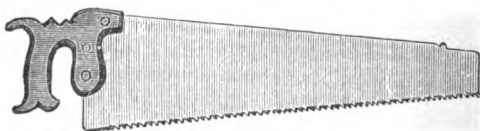

FIG. 1.—Hand-saw.

will most likely have by you ; measure it off from one end, and run a pencil-line along the line through which you wish to saw it. For this purpose you use what is called a hand-saw, as shown in Fig. 1. Place the wood on the stool, hold it firmly down with the left knee ; then take the saw, drawing it along the pencil line in which you intend to cut it, using but little pressure. Do this two or three times, so as to make a shallow groove, to act as a sort of guide to your saw in cutting. Hold the saw



FIG. 2.—Paring-chisel.

firmly in the hand, and do not let it “buckle” ; if it does this the blade will be spoilt. To avoid buckling keep the thrust forward very steady, pushing the saw downward by gentle pressure ; in drawing it back for the next cut use no pressure. Having cut off a length, the next thing is to get it a proper width. For this purpose, if it is much too wide, you had

better rip it down with a saw. If you only have a narrow piece to take off, it can be done with a paring chisel, such as is shown in Fig. 2. Such chisels as these are made from 6 to 10 inches long, and from $\frac{1}{8}$ of an inch to 2 inches wide. As you will not be able to get an assortment at the first, one about $\frac{3}{4}$ of an inch wide will perhaps be the most serviceable. To work with the chisel, keep the flat face upward, steady the wood to be cut with the left hand, pushing the end firmly against a ledge which must be nailed to the surface of your bench. If you are using a table for that purpose, a piece of wood about $\frac{1}{2}$ an inch in thickness nailed flat down to the edge of your table will answer this purpose.

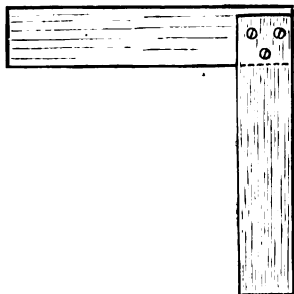

FIG. 3.—Carpenter's Square.

Grasp the handle of the chisel with your right hand; with your left steady it and push it forward, keeping, as we mentioned, the flat side of the chisel upwards. Having now got your piece of wood cut to the proper length and breadth, the next thing is to see that the edges are square with the sides; that is, that they are at right angles to each other. This is done by taking a carpenter's square, as shown in Fig. 3. It consists of a thin blade of wood or metal fixed at right angles into a piece of wood from half to three-quarters of an inch thick. By the square all your work must be tested. When

the thicker part of the square is held close to the edge, and run along the same, the small blade points out all along it a direction at right angles to that edge.

In all your work the square is a guide that you must never neglect. Before going on any farther, test the ends; see that they are "square." A smaller square is also used for testing the edges of work smoothed by the trying-plane. Now the next process is to smooth the front and edges of the rail. For this purpose you must have a plane. All boys like planing—they like to see the thin shavings turned off, curling up and collecting at their feet—but it is not so easy to get a smooth surface as you may imagine. It requires some patience and work to bring up a nice smooth surface. We have therefore introduced you to an easy piece of work to commence with. If you are using wood that has been made up before, as in the boxes we mentioned, see that there are no nails, pebbles, or lumps of grit in your wood, for anything of this kind will spoil the blade of your plane at once. If you buy new wood, you can sometimes have it already planed, but then you deprive yourself of the opportunity of acquiring skill, which is very important if you want to get a practical knowledge of carpentry work.

Now for a word or two about planes. If you go into a carpenter's shop, you see planes of different sizes and shapes, so that you may wonder which of them would best suit you. For your long rail you will find a jack-plane, as shown in Fig. 4, the best for producing level surfaces of all kinds. In this the "stock," which is the name given to the wood block

into which the plane-iron is fixed, is about 16 inches long. In the cross slit through the "side" of the stock, the plane-iron is held. This iron you will see consists of two parts; look well at them that you may know how to fix them together again if you require to separate them at any time for sharpening. You will see that they are held firmly in their place by a wedge of wood driven in at the top. Now, before using, turn up the plane, bring it on a level with the eye, and note how far the blade protrudes through the stock; for if it goes too far through, the shaving will be thick and the wood

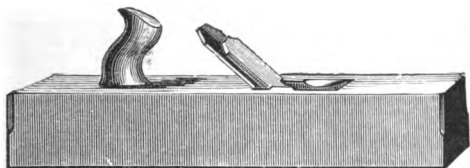

FIG. 4.—Jack-plane.

torn; if too little, no work will be done. To throw the blade backward give the forepart of the stock a smart blow with the hammer; if too little, a similar blow at the top of the iron will bring the blade back. After either operation, tighten the wedge so that the blade is held firmly. A little experience will soon enable you to get over this difficulty. The smoothing p'ane is not more than 8 inches long, and has no handle, as may be seen on reference to Fig. 5. This is more adapted for planing large surfaces than a length of wood such as we now have under consideration. The tool called the "trying-plane" is longer even than the jack-plane, and should only be

used in the direction of its length, and not obliquely. It is used for smoothing large surfaces and getting long straight edges; it is, however, too heavy for you to manage.

Now, to start upon the work of smoothing the surface and edges of the rail you have cut, place one end firmly against the ledge in the bench; then take the plane, and stand close to the bench with your left foot forward; take the handle of the plane in your right hand, holding firmly the front of the tool with your left. Then put the plane flat on the wood; then slide it backwards till the blade comes to the



FIG. 5.—Smoothing-plane.



FIG. 6.—Marking Gauge.

edge of the wood. Hold the front of the tool tightly down, then push it forward steadily; then you will find the iron "bite," and a shaving will come curling upwards through the slit in the plane. A few steady strokes such as this will no doubt give a fairly smooth surface. Then the wood must be turned so that the edges can be served in the same manner, so that all traces of the saw-cuts are removed. Having planed up your rail, test it again with the square, and look along the edges to see if they are straight, and having satisfied yourself that you have done a good piece of work, you may like to stain it in imitation of a harder wood. To do this for a dark

wood, mix a little raw umber and linseed-oil; stir them up well together till you get it to the consistency of thin paint; then put it on with a painter's brush, or rub it in with a piece of coarse flannel, putting as little of the colouring in as possible. You can rub it till it is nearly dry; the wood by that means will take the stain well. For a lighter wood like mahogany you can add some red ochre to the umber. These substances are all obtained at the oil-man's for a few pence, and are useful in giving a better appearance to many articles of home-make.

When the rail is quite dry you will want the pegs to mount on the rail. The double black peg is the cheapest, and we will assume that you choose half a dozen of these. They must be screwed on so that they are upright, and at even distances from each other. Here is a matter of measurement. Measure first of all 6 inches from each end; put your square so that the thick part slides on the edge of the rail, and the blade through the points at the distances so found. Mark with a pencil, lines running through these points, then divide the distance between these into five equal portions; draw cross lines at these points. The pegs must also be fixed at the same height from the lower edge of the rail; the measurement must therefore be made from the edge, and the mark for each must be made across the lines crossing the rail. There is a tool called a marking-gauge, that is useful for all such purposes as these. This is shown in Fig. 6. The block has an arm consisting of a thin piece of wood which can slide backwards and forwards through it, and at one end a pin which acts as a scratcher, and in the block is a thumb-screw by

which this arm can be held at any point. Having determined this point and fixed the scratcher, pass the block of the gauge along the edge of the rail, and scratch the same distance across any of the pencil-lines previously drawn. The use of this gauge will increase in favour the more it is used, for it saves a great deal of separate measuring for short distances.

Having determined on the exact position for each of the pegs, the next thing is to prepare to fix them. See that all your screws fit, and that when they are in their places they run "flush" with the screw-plate at the back of the peg. Place the rail flat on the bench; hold the peg in its proper place; take a brad-awl of the right size for the screw—rather smaller than bigger—or the screw will fit loosely; then carefully bore the hole, which shall be in the line marked on the board. The second must be in the same line immediately under it. Then screw both in tightly. Do the same with the second, and so on till they are all fixed. They should be upright and firm on the rail, at an equal distance from each other, and the whole will be a useful article in bedroom, hall, or passage, where clothes or hats are to be hung up. If finished in the careful and exact manner we have pointed out step by step, our young workman will have something to point to as good work, and will have acquired skill and method in his work that will help him on in making more difficult things, where several other tools must be employed.

CHAPTER II.

HOW TO MAKE A BOX AND FIT IT.

WE have an idea that when you are able to make a box, it will help you to make several other things that are made much in the same way; such as cupboards, cabinets, and articles that can be fitted up with shelves, partitions, and such like.

The first thing, you must make up your mind as to what you want the box for, because if it be to keep your tools or any such heavy things in, it must be of a much stouter make than one required to keep light articles in.

We will suppose you want to make a serviceable tool-box for yourself. In this case you do not want one large enough to keep your saws and tools of such length, unless you go in for a complete tool-chest, which is outside our instructions altogether.

Suppose you arrange that your box shall have outside dimensions of 18 inches by 14 inches and 12 inches deep, including a hollow lid of 2 inches, and a tray to fit inside the box, to be made into divisions in which you can keep a stock of nails, screws, and other items for your work. This must

be a strong box, and well made. To put the sides and ends together well, and to give it the greatest strength, carpenters generally dove-tail their edges; *i.e.* the edges are cut so that projections of wedge-like form fit into hollows reversed in shape. This method we will fully describe in a later chapter; in our present stage of work it is a little too difficult.

Unless you have some good wood by you, we should advise you to get some new $\frac{3}{4}$ inch stuff for it. We have now such a tool-box that was made some twenty-five years ago, and it seems to be as strong and not at all aged by the number of years it has been in constant use.

First cut off the lengths for sides and ends, which must be 9 inches wide. Smooth them with the plane, then put the two sides together; test them with a square, and see that they are in every way the same size. In planing up the ends be careful how you do it, for if you are too rough with this operation the wood may split, for you will be planing across the grain; for this work the plane must be very sharp. The next thing to be taken in hand is the bottom of the box. As your wood is only 9 inches wide, this is evidently not wide enough; you must therefore cut off two pieces the length of your box, and one piece must be cut down so that when one piece is joined to the other, you get a board 14 inches wide, after planing and trimming. The second piece must therefore be rather more than 5 inches wide. The pieces for ends and sides should be 10 inches wide when trimmed. To join these pieces securely, their edges must be planed so that they perfectly fit, which can be seen when they are made

to slide one over the other, and leave no space whatever between them. Having done this, you must make some glue ready for joining them. If you have no glue-pot, you must get half a pound of glue; break it up and put it into a jar; put a little cold water in it; then stand it in an outer vessel nearly full of water; and the water in the outer vessel must be made to boil and kept boiling for some time till all the glue is melted, and it comes to a nice even consistency somewhere about that of thin treacle.

Then take a small, flat, stiff-haired brush, which you can buy for a penny, and put some glue along the edge of one of the pieces to be glued. Be careful and spread the glue evenly, and do not smear it beyond the part that needs it. Now slide the edge of the other piece along it, and take care that it is flush with it; put it away to dry, and see that nothing shifts it during the time—it requires to get perfectly dry. When dry you will find the whole slab of wood as strong as if it had originally been in one piece. Now square it up and it will be ready for the sides, and its size should now be 18 inches by 14 inches. Get some good $1\frac{1}{2}$ inch nails; tack the sides lightly together; see that they are square by putting the "square" into each corner; see also that the sides stand perpendicularly to the bottom, to which they are to be tacked lightly. Having satisfied yourself on this point, take a brad-awl of suitable size; keep it upright when boring the holes, so that there is no fear of the nail coming through the wood. Next nail the whole together, and you will have the shell of a box. The next thing is the lid. The pieces for the ends and sides must be of the same

thickness as that of the box itself. The top may be $\frac{1}{2}$ inch stuff. Proceed in the same way as with box itself, first joining the pieces together for the top, then putting them together with sides and ends. To be economical with time, the pieces for the top and bottom can be glued at the same time, and they can be glued so that the joint comes across instead of lengthwise of the box, if it suits your purpose and material better. When the lid is made it should exactly fit the box; this must be tested before going further.

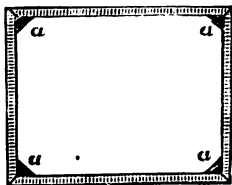

FIG. 7.—Supports for the tray.

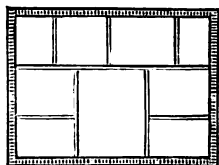

FIG. 8.—Plan of tray, with divisions.

Having succeeded thus far, the next thing will be to get a pair of strong, $1\frac{1}{2}$ inch brass or iron hinges, and at the same time get a suitable lock and key. For the hinges, portions of wood must be removed, so that the plate which is fixed to the box is flush with the edge. Fix on the place in which it is to be sunk; then mark it round with a brad-awl; then cut it carefully out with a sharp chisel. Do not cut down deeper than the thickness of the plate, and so fix the hinge that lid and box are flush with each other when the lid is closed. This will require a little neat fixing, but it is not difficult; it only requires care. Similar portions must be removed

from the edge of the lid as from the box. Before finally fixing on the lid it will be better to make the tray. Cut and smooth up four pieces $\frac{1}{2}$ inches long, which shall be the same height, and fit into each corner of the box, that these may be a support for the tray. Having ascertained that they fit well, glue them into their places. Do not leave them as square blocks, but triangular pieces, as in Fig. 7, and fit a piece of $\frac{1}{2}$ inch board so that it can be made into the bottom of the tray. Then cut and plane up pieces for the sides and end of the tray. Make it deep enough to come flush with the edge of the box. Nail it together carefully with 1 inch



FIG. 9.—Gouge.

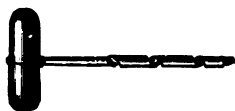

FIG. 10.—Gimlet.

brads. Then make any divisions in the tray to suit your taste or convenience; of course they need not all be the same size, and $\frac{3}{8}$ inch stuff will be thick enough for the inside partitions of this tray. We found our tray conveniently divided, as shown in Fig. 8. Now cut two notches inside each end of the tray in which the fingers can be placed; these will be convenient for lifting it out. These notches will require another tool called a gouge, to do them neatly. The gouge is a curved chisel, as shown in Fig. 9; this is made of various sizes like the ordinary chisel. See now that your tray can be easily taken out and put into the box.

Now remove the tray and have a try at putting

on the lock. Mark out its place near the centre of the front portion of the box; cut carefully away with gouge and chisel only such portions as are needed to imbed the lock into the wood. Hold it in its place, and put a hole through the front by means of a brad-awl, to find the spot where the barrel of the key must go in; then enlarge this by means of a gimlet, such as is shown in Fig. 10. Then a trifle lower down bore a second hole which will admit the wards of the key; then connect the two by cutting the wood away with a chisel; or if you have not one small enough, try to do so with a penknife. This will form rather a rough keyhole, but with a small rat-tailed file it can be smoothed up; then put into it the eye which you will have bought with the lock. Now screw the lock into its place. See that it does not hinder the tray from being easily moved out or in. If the lock projects a little inwards, a portion of the front of the tray can be easily removed by the chisel. Now put your tray in, and screw into its place the "shoot" of the lock, the plate of which will have to be let into the under edge of the lid. Now shut the box, try the lock, see that the lid fits close all round, take a punch and hammer and knock the heads of the nails a little distance below the surface of the wood, then fill the small holes up with putty, level with the surface. Let them dry, and they will become as hard as the wood itself.

You can yourself make the putty you require by mixing whiting and linseed-oil, mixing it up by means of a thin knife, so that no lump is allowed in the mass. After the putty is dry, smooth all down and rub the box over with sand or glass-paper;

and make up your mind as to whether your work has been done creditably or not.

We think now it will be an improvement if you stain it with the umber mixture we mentioned in our last chapter. Do not put it on thick, but let it get well rubbed into the wood, and when thoroughly dry, put on a pair of black strong iron handles. Let them be exactly opposite to each other, and do not leave any portion of the screw-heads above the handle-plates, or your hands are likely to be cut when grasping them. If your box is now properly finished, you have a creditable piece of work, as shown in Fig. 11, and a good receptacle for most of your tools. Let box and tools be kept in a dry place, and keep everything ready for

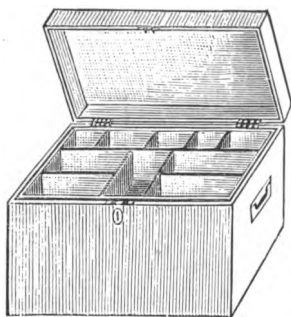

FIG. 11.—The box complete.

use. Your tools, such as chisels and plane-irons and other tools, will frequently require sharpening, for it always answers the purpose to keep them with a good edge.

For plane-irons and chisels the first process must be done on a grindstone. You all know this machine. It consists of a large circular slab of rough stone, turning on an axle worked by a handle, or more frequently now by a treadle, to which the axle is attached by an iron rod. You will probably get access to some carpenter's shop where such a

stone is in use, because you are not likely to have one of your own. In the first instance you had better have your tools sharpened up for you while you look on and see them done. You will then find that tools are never sharpened on a dry stone—this is bad for tool and stone. A trough of water is attached to the frame holding the stone, and it dips about an inch of its edge in the water as it is turned.

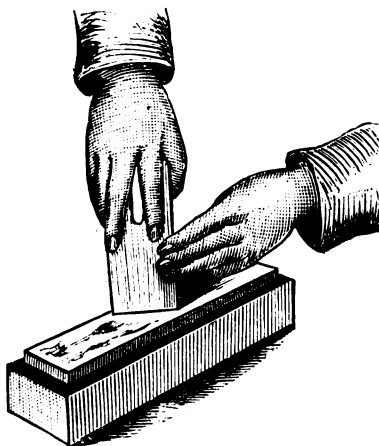

FIG. 12.—Sharpening a Plane-iron.

Notice how the edge of the tool is held on the stone—the stone runs towards you, and towards the edge of the tool, and the tool is not kept to the middle of the stone, but it is gently moved about, so the whole face of the stone is in use.

Again notice how you have to hold the plane-iron or chisel (Fig. 12), so that the bevel of the edge is not too thick or too thin, and that it is ground till a raw edge is obtained. Then for the fine edge you

must use the oilstone. There are several kinds of oilstone employed for setting edged tools; the best and the greatest favourite with our carpenters is the Charnley forest stone, which is found in Leicestershire. The Canada oilstone is also a good stone, and costs somewhat less than the Charnley stone. The stone is generally set in a block of hard wood (Fig. 13), and fitted with a cover to keep grit off, and to prevent any substances sticking in with the oil and drying in it. Small conical tins of oil are generally kept for use with these oilstones. A little petroleum is used with the oil.

You may not at first find it quite so easy as you think to put a nice fine smooth edge on a plane-iron or chisel; it is quite a matter of practice. Hold the iron and the hand grasping it at such an angle that the cutting edge is kept flat to the stone, and do not bear too hard on it. You can test the edge from time to time, before considering it finished.

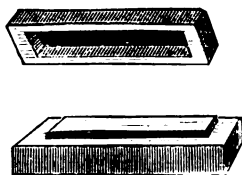

FIG. 13.—Oilstone, box and cover.

TO MAKE A PAIR OF STILTS.

Boys are often fond of stilt-walking as well as carpentering. It may not therefore be out of place to give a ready means of making a pair of stilts. English boys go in for this as a matter of amusement, and not as a matter of necessity. In some countries,

however, it becomes a matter of necessity that children should be taught to walk on stilts. The ground is sandy, and streams have to be forded, and to manage stilts skilfully is a necessary qualification to get about from place to place. We should think it

rather curious to have to mount the roof of our house, or even the roof of a stable to get on to stilts, but the inhabitants of the "Landes of Gascony" do this frequently in the morning, and do not quit the stilts till night.

The most daring piece of stilt-walking is probably that of the Yankee who some years ago crossed the Rapids of Niagara by this method of walking.

A pair of stilts for learning on is easily made. Select a pair of uprights of whatever length you require, strong enough to bear your weight, and as light as is consistent with strength. Plane them up with the

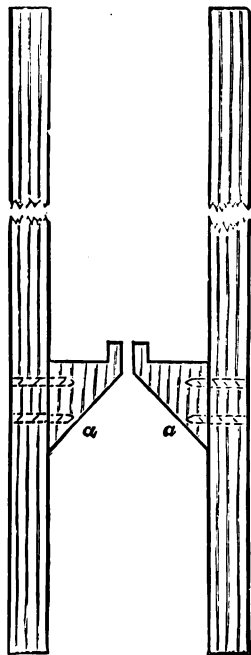

FIG. 14.—Stilts, showing foot plates and uprights.

trying-plane, then you must fix on the places for the foot-pieces. For a beginner these must not be more than 12 or 14 inches above ground, and the upright must be long enough for you to have a good handhold. When you get more expert the

foot-pieces can be placed higher up, and at last perhaps so high up that you can venture to leave your hands free, and only need the end to be strapped firmly to the leg, as far as the thigh in the first instance; after "the practice that makes perfect" only perhaps as far as the knee.

The foot-pieces must be made of stout tough wood, cut somewhat in the shape of those in Fig. 14. Smooth them up by planing, then get some strong screws, and put them on, in the manner shown in Fig. 14, *a*. In boring the holes be careful not to split the wood, or it will be so weakened as perhaps to be useless. Some prefer a loose piece of leather strap nailed across the foot-piece something like the top of a stirrup, but this we leave to you to do as you like about.

Many useful and ornamental articles can be made by carrying out the simple rules we have given in this chapter, such as sets of shelves for books or natural history specimens, frames for drawers, and even drawers themselves. The articles herein mentioned are however better made when you can make dove-tail and other joints which we intend to describe in a later chapter.

We urge again that although this work is done as recreation, it is no reason why it should not be well done. Your hand and eye will both be the better trained by careful than by careless work. Work nicely finished off, no matter how simple its character, is always creditable, and is worth looking at, while careless work never can be looked upon with pleasure.

CHAPTER III.

HOW TO MAKE A SET OF SHELVES FOR BOOKS OR OTHER OBJECTS.

FIRST, we think it better to give instruction for a definite object; we will therefore take a very simple set of book-shelves, three feet wide, and with three shelves.

The first thing is to get your wood. This you can prepare for yourself, or you can buy it already prepared, by paying a trifle extra per foot. If you have not a good set of planes, or if you have not acquired sufficient skill to plane a nice even surface large enough for shelves, it is better to buy the wood already prepared. Do not, however, let the ease with which wood can be got, put you off from acquiring the skill of preparing it yourself.

For the shelves in question, you want four lengths of $\frac{3}{4}$ inch thick, 6 inches wide. This cut off and planed will cost you 1s. For the uprights you want two pieces, each, two feet long; these will cost you 4d. Make sure that the edges of the shelves are quite square. Test them as we have before directed. Now fix on the distance that you wish between the

shelves. The ends will allow 8 inches between the bottom one and the second shelf, and $7\frac{1}{2}$ inches and 6 inches respectively between the second and the third, and the fourth length will make the top. If however you wish to cut a curve at the top and bottom of the ends, as in Fig. 15, *a*, you must arrange the distances between the shelves accordingly, or leave one shelf out. This, however, is a matter of detail best left to yourself, the method of

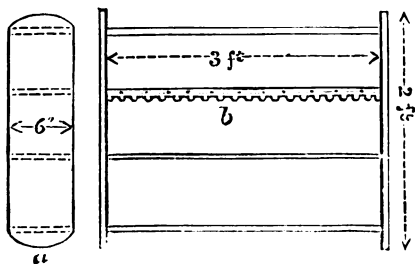

FIG. 15.—Set of Shelves.

putting the shelves together being the subject of our directions.

The putting together of the shelves is one that must be determined by the skill you have already acquired in carpentry. Having fixed on the places for the shelves by marking the inside ends with a pencil, if you can hollow out channels into which the ends of the shelves will slide, so much the better; if not, they can either be nailed by long French nails being driven through the end pieces, or little slips of wood may be nailed on the inside, to which the shelves may be fastened.

Let us give directions first for those who desire to

have the shelves fitted into the ends. Shape the ends as in Fig. 15, then pencil the position for each shelf as shown at Fig. 15, *a*, leaving about a quarter of an inch from the front edge. Be careful of your marking, for the exact thickness of the shelf must be allowed for. Now with a hand-saw or tenon-saw, Fig. 18, cut along the dotted lines to about a quarter of an inch in depth. With a gouge next cut the front curve for the front edge of the shelf. Now with a chisel remove the wood between the cuts. Do this carefully, so that all the wood is fairly cut and not torn away. Repeat this operation till you have a groove for each shelf, then serve the opposite side in the same way. You will have to fasten the wood firmly down to your bench while sawing these grooves, for if the wood shifts the edges of the grooves will not be cut straight. Having completed the grooves in both sides rub them smooth with sandpaper, then slip the shelves into their places. See that they fit well. Next prepare some glue to fasten the shelves permanently in their places. Then put some of the liquid glue on to the edge of each shelf, and push it permanently into the groove prepared for it. When all the shelves are so fixed, put the whole set back downwards on to the bench, fixing it so all the shelves are square with the ends. In this position allow it to remain till the glue is hard and dry. The set of shelves may then be removed without any fear of getting them wrung out of their proper position.

The shelves must now be stained. This can be done either by mixing umber and linseed oil as we recommended in the last chapter for the box, or

you can buy stain of any tint you wish, already prepared. The stain as bought will always admit of being made thinner by the addition of linseed oil. Put the stain on with an ordinary painter's brush or flannel. When the stain is quite dry it must be varnished, but before this can be done it must have a coat of size. This size you can buy at an oilman's. A pennyworth is enough. Mix it with some water, and let it dissolve by the fire; then put it on in the same way as you have already done with the stain. When quite dry put on a coat of clear varnish; this you can also get at the oilman's. When this is thoroughly dry, your shelves should look exceedingly well, and fit for any room in the house. The staining and varnishing, if properly done, makes them look to be made of a superior kind of wood to ordinary deal, of which they are really made.

To fix them to the wall get four brass "lugs," and screw them at the back of the shelves, by which means they can be nailed to the wall. You may prefer to support the shelves on brackets; a pair of handsome ones may be had for 3*d.* To give a still more finished appearance to the shelves, buy four lengths of leather, prepared for the edges of the shelves, and nail strips along each shelf, by the ordinary brass or ornamental brass nails. Then the front shows somewhat after the manner of these in Fig. 15, *b.* The total cost of material for completing the set of shelves according to our directions is only 3*s.* 6*d.*, and they will be as useful and ornamental as many sets that would cost a guinea if bought ready made.

If you have not acquired sufficient skill for cutting

the grooves for the shelves, you can get over the difficulty by cutting $\frac{1}{4}$ inch slips of wood long enough to come across the ends of the shelves, on which they can rest. Cut the slips very neatly, quite square, and put them on with glue and fine nails or screws, so that when the shelves rest upon them they are capable of supporting all the weight the shelf is intended to bear. Having placed the strips on each side quite opposite to each other, put the shelves in their places according to the directions already given. Finish the shelves off by mounting and varnishing, as in the instructions given for Fig. 15. Having succeeded, you will be delighted with them, and so will your friends.

You are now in a position to make a cupboard and book-shelves combined. The wood for this purpose must be somewhat heavier or stouter, because it is to be larger. Supposing you wish to buy your wood planed, it will cost a little more, *i. e.* a penny per foot more.

Now suppose we want a set of shelves, which shall do for three rows of books and a cupboard below, 18 inches deep.

We must have two upright side-pieces, 1 inch thick, 4 feet 6 inches long, and 9 inches wide. These must be planed on both sides. See that they are perfectly square at the ends, or they will not stand upright. Next you must have two pieces for the top and bottom. They must be planed on both sides, and of the same thickness as the sides, and let them be 3 feet 3 inches long. Now put them together, so that when screwed up they look like a wide frame. We recommend screws

here, because the pieces must be not only tight but very firm.

Now make the division for the shelves. These may be somewhat lighter than the outside pieces. Put the bottom one 18 inches from the lower end of the case. The method of fixing these shelves must be determined by the instructions we gave for the last, the making of which is fully given at the beginning of this chapter; the lower shelf however should be screwed if not grooved into the sides. Place the second shelf 10 inches above the lower, and divide the remaining distance to the top into two equal parts, and fix the third shelf. We recommend this to be backed with wood lining $\frac{1}{2}$ inch thick; it gives completeness to it, and adds to its "substantialness"—we will call it.

Before doing any more, see that the whole is firm and square; next nail on the boarding for the back, the inner side of which must have been planed. Now nail on a moulded architrave, which you can buy at 1*d.* per foot, around the top edge, front, and sides, and do the same for the lower.

Now for the cupboard you require a pair of doors. These perhaps you had better buy if you require panelled doors, or if you are content with ledge doors, you can make them yourself. If you buy them, give the size accurately, dividing the lower cupboard portion into two equal parts, the doors to close in the middle. These will cost you 1*s.* 6*d.* You can add to the appearance of the doors by putting a narrow moulding—which you can buy very cheaply—all round the inner edge of the panels. You must be careful and cut the corners very accurately

—mitreing this is called—so that they fit exactly. Before putting on these doors, you must nail along the bottom of the cupboard, and the under edge of the lower shelf, a rail close to which the doors will shut when they are fixed. See that they fit nicely and flush with the edges of top and bottom. Having well tried the doors, and made sure that they will fit well, and swing open properly, fix the hinges to the doors, then the doors to the case. Iron hinges will cost you 2*d.* per pair, brass hinges somewhat more, according to the quality you get. Be sure in any case they are strong, and well able to carry the doors you have to hang.

On the inner side of the left hand door fix two bolts; one that will slip into the upper ledge and one into the lower. Fix them so that when the door is bolted it is quite flush with the front: into the other door fix a lock—get a good lock—it pays best. After cutting the hollow into which the lock is to be fixed, the depth of the hollow must be so regulated that when the lock is fastened the bolt lies flush with the inner side of the bolted door, and when in that condition we call “locked” does not rattle or shake about. A hole must be bored for the pin of the lock to come through the door, and this will enable you to tell where to make the key-hole, which you must make very neatly. You can do this with a chisel if you have no “key-hole” saw, and finish it off with a file as before recommended. Into the key-hole put a brass eyelet, and before fixing the lock, put it into its place, and see that it fits properly and locks and unlocks easily. Now fix it finally with suitable screws. On the outside of the key-

hole, fix a brass "scutcheon"—it adds to the appearance. Now nail an edge of moulding on the right-hand door so that it overlaps the left door; this gives a more finished appearance to the whole. Now we think all the wood work is done, putty up all holes above nail-heads, rub it down with glass-paper, get the surface nice and smooth, and look the whole carefully through to see if any points can be improved; do not leave it without positively satisfying yourself on this point. Next call your parents or some friend to go over all the work with a critical eye, and any improvements suggested either in construction or neatness do not fail to carry out.

The whole work will now be ready for staining. A dark stain is best. Buy the quantity required; dilute it to a reasonable thickness, put it on according to instructions already given—staining it inside as well as outside; let it dry thoroughly. See that there are no places in which the stain lies thicker than in others; satisfied on this point and that it is thoroughly dry, treat the outside with two coats of size, prepared as we have already mentioned. When dry, give it a coat of clear varnish; if when this dries it seems that a second coat would improve it, give it a second. Let it dry in a room where no dust is flying about, and if you have carried out our instructions fully, you are now the possessor of a really substantial book-case, of a most respectable appearance, suitable as a piece of furniture for sitting-room or study, and its whole cost for material and fittings less than ten shillings. We give a sketch in Fig 16, of the case we made on exactly the same conditions as we have described at length.

Having succeeded so well with the book-case, we thought an addition in the form of a glass case would be not only most useful for holding bric-a-brac or specimens of minerals, shells, or other objects of natural history; but it would be ornamental besides. We made one of the following dimensions and description. This shows how one successful result evolves the efforts for another.

We determined that the glass case should merely

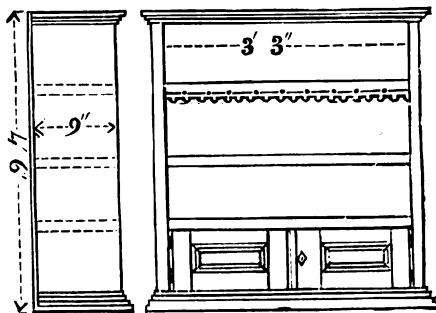

FIG. 18.

stand on the top of the book-shelves, and be quite independent of the former as regards construction.

The shelves being 3 feet 6 inches wide, we made the case 3 inches less in width, and 1 inch less in depth, the whole being made of lighter wood—*i. e.* the wood not so thick, but of $\frac{1}{2}$ inch stuff. For this purpose we had two lengths of wood, 3 feet 3 inches long for top and bottom, and two ends, 2 feet 6 inches long, the whole being 9 inches deep. The frame must be put together with screws; if not dove-tailed, this is the next best method of doing it; then it must be backed with $\frac{1}{2}$ inch lining as re-

commended for the book-shelves. This makes the whole very firm and rigid. The shelving must be to suit the purpose for which you require the case, but each shelf can be made of $\frac{1}{2}$ inch material.

Then come the glass doors, the frames of which you had better buy, as probably your skill has not yet reached the stage that will enable you to make them for yourself. Those of the pattern given in sketch, Fig. 17, cost 3s. They are open, light, and pretty, and you can secure something of a similar

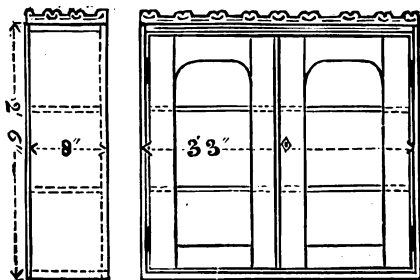

FIG. 17.

kind or pattern for the same price. In hanging these doors we should recommend brass hinges; be exceedingly careful to hang them properly, so that they swing true, and close securely. Then comes the fitting of a lock as described in the former case. It must be done equally neat, and if possible a little more so.

Having fitted the shelves, and left no ugly nail-holes, smooth up the wood with glass-paper, then perform the staining and varnishing by the method already given. Now there is the glazing. For this purpose you want two panes of glass carefully cut

to the size of the grooves inside your panels. Take the measures of the panes to a glazier, and get him to cut you two panes of the exact size required. If good clear glass, these will cost you about 1s. 3d. Buy a pennyworth of putty—or if you prefer making it yourself, as we mentioned in Chap. I., by grinding up whiting with linseed-oil;—the whiting must be fine and very dry. Knead the whiting and the oil together into a stiff paste, then lay it aside for some hours. Before using it work up the putty again till it becomes quite soft and smooth to the touch. Putty can be kept for any length of time in a glazed earthen pan, and covered with a wet cloth.

If you have no proper putty-knife, such as you see the glaziers use, you can use a broad-bladed pocket-knife, or a short table-knife. Put your pane of glass flat into the rebate of the frame, so that it fits flush everywhere along the front edge; now put on a layer of putty, with a knife pressing it well round the edge all the way, covering the glass to the breadth of one-third of an inch, and sloping off till it comes to the inner edge of the frame. Then smooth off all round so that no irregularities or lumps stick up in the putty. Deal with the second pane of glass in the same way. Then let them not be touched till the putty gets hard and dry; the glass will then be firmly fixed, and no shaking will shift it from its position. We have recommended you to have the glass cut for you in this case, and in all cases we think this best; for to cut glass well and accurately requires a diamond. Substitutes for the diamond do not last long, and only experience will enable any one to cut glass well.

When the putty is quite hard, it may be stained like the case, or dusted over with a little umber or ochre.

The instructions given in this chapter may be applied to many other articles "useful and handy," the designs and sizes of which must be regulated by circumstances. So that we hope we have put you into the way of making corner-cupboards—cupboards to fill recesses in a room, and other purposes where such things are useful, and where the same method of working out a plan is carried on as is here given. We have not added designs for other objects, because you can each readily do this yourselves if you know exactly what you want.

CHAPTER IV.

MAKING OF SEVERAL FORMS OF JOINT.

THE successful making of joints requires great care and accuracy in the use of tools, and it requires patience. We hope therefore you will not be content always with putting together the various articles we have been describing with nails and screws, but so fit together the wood that fewer nails and screws will be needed.

The best way to start on this work is to have some special wood for the purpose, and go through the making of the various joints in the order of their difficulty. You must not be satisfied with your work till you get something exceedingly good; every joint must be so made that the wood is not weakened in the least.

The first thing for success in joint-making is to get some nice soft even-grained wood, from $1\frac{1}{2}$ to $2\frac{1}{2}$ inches square. The tools required are the square, carpenter's pencil, with fine marking edge—*i. e.* sharpened so that a fine line can be drawn close to the edge of a ruler or square—a tenon or back-saw. One from 10 to 12 inches long will probably suit

you best; it consists of a saw with thin blade and fine teeth, and is strengthened at the back with a bar of iron or brass, into a groove at the edge of the bar the blade is fixed, as shown in Fig. 18.

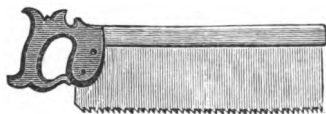

FIG. 18.—Tenon or Back-saw.

The first joint we shall ask you to try your skill upon is an easy and very useful one, but frequently badly and carelessly made. It is called the half-lap or corner joint.

Cut off a piece of wood that has been nicely squared up, and of sufficient length to make a good joint in the centre of the piece. Place one piece on the bench, bringing the end of a second piece across it, as in Fig. 19. Hold it firmly in this position while

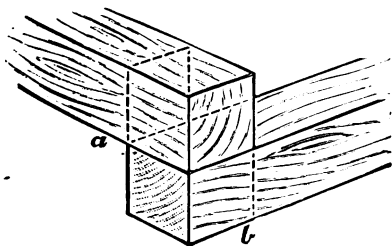

FIG. 19.—Marking.

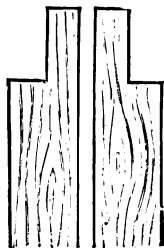

FIG. 19 a.—Sawing.

you mark, either with the pencil or with the scriber—a fine brad-awl will do—the exact breadth of *a* across *b*. Let this be carefully done—in fact, let none of the work be done slovenly. As you go along,

see a reason for everything you are advised to do, and remember that accuracy and neatness are the great points to be aimed at.

Now mark on each piece the depth of the cut required, so that when they are lapped together they form a piece of exactly the same thickness as a single piece. Now you must place one of the pieces flat on the bench, and saw across the line drawn. Hold the saw firmly, and keep it parallel to the

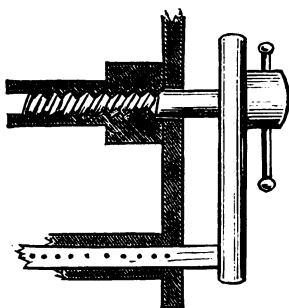

FIG. 20.—Bench-screw.

upper surface of the wood; continue the cut down to the line marked on it—*i. e.* half the thickness of the wood.

Now treat piece No. 2 exactly in the same manner. The pieces now each in turn should be stood on end, that the “cheek” piece in each case may be re-

moved. This is best done by grasping it tightly in a bench-vice, or to the bench by the bench-screw, Fig. 20; then saw downwards, holding the saw very firmly, and cutting parallel to the edge of the wood. If this is carefully cut with a fine-edged saw there will be very little to be removed by the chisel. Sometimes such an operation as this is performed with a panel-saw. When the process is complete, each piece should appear as shown in Fig. 19 *a*; then fit them as shown in Fig. 21, and see that the edges fit exactly. The joint can then be permanently made by glueing them together, or by making a pair

of holes at opposite corners of the joint, then cutting two wooden pegs with your chisel, sufficiently strong to hold them together, and drive them into the sets

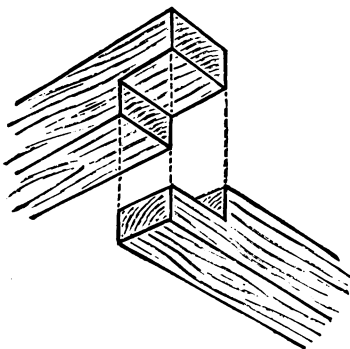

FIG. 21.—Fitting.

of holes. If you keep this as a specimen joint, the peg method is the best, because you can then separate the pieces to examine at any time you think well.

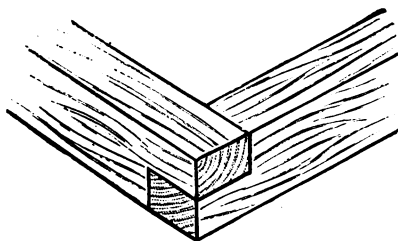

FIG. 22.—Finished.

If you decide to permanently fix the joint, take care that your glue is of even consistency, and evenly spread over the wood so that no unevenness is caused from varied thicknesses of it. Smear the glue on

one piece only. When finished it should appear as in Fig. 22.

If you have succeeded in getting a good specimen of the half-lap joint, you can go on to the next; if

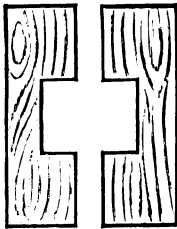

FIG. 23.—Sawing.

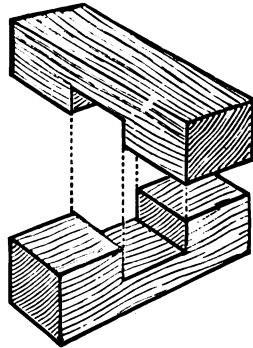

FIG. 24.—Fitting.

not, try another and still another till you get a creditable piece of work.

For a second joint try another form of halving joint—one that is often employed for joining beams

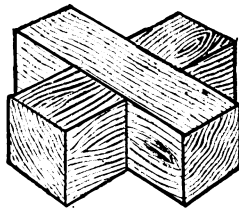

FIG. 25.—Finished.

that have to bear loads, and for this reason is sometimes called the "bearing-joint."

First, mark off the width of the cut, then saw it to a depth extending to half the thickness of the

material; then remove the portions from each piece, in this case with a chisel, the widest you have; but keep to your line and cut it as smoothly as if removed with one chisel-cut. Then each piece should appear as in Fig. 23, and the notches in each case should be of exactly the same size, so that when they are fitted, as in Fig. 24, they may fit quite close, although each may be easily removed from the other. As a finished joint we show this in Fig. 25,

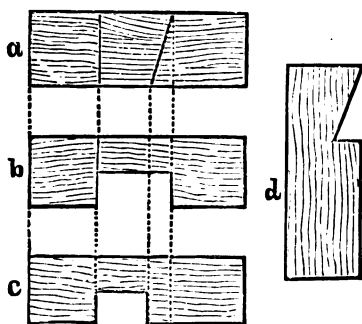

FIG. 26.—Marking and Sawing.

where the pieces can be either glued or pegged together as mentioned for Fig. 22.

The next form of halving joint is one in which a tusk or tenon is cut so as to fit accurately into a notch in the under half. The notch is sometimes called the "Tredgold" notch, from the name of the inventor. Sometimes it is called the "Bald-faced joint." In marking we have shown each piece separately in Fig. 26. Be very accurate in marking as to the face and depth of the notch, to half the thickness of wood. In Fig. 26, *a* shows the side section, *b* the top, *c* the bottom, and *d* the bald face.

In Fig. 27 we have the pieces ready for fitting, and in Fig. 28 the joint fixed and finished.

In the next joint we have another form of halving

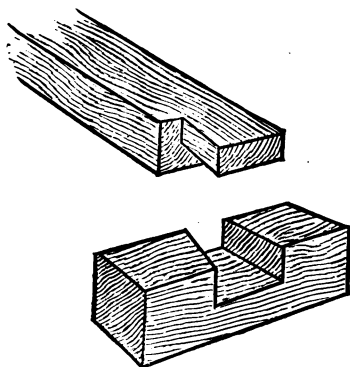

FIG. 27.—Fitting.

tenon-joint. You must be exceedingly careful with this; it differs from the former joint by both sides of the tenon being of a wedge-like form. The

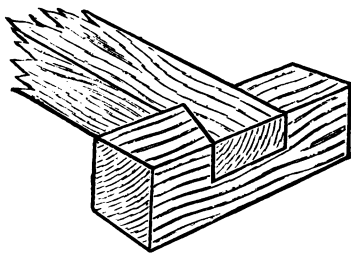

FIG. 28.—Finished.

method of marking and sawing are similar to those in the last joint. In Fig. 29, *a* shows the side piece, *b* the top, *c* the bottom, *d* the upper face

of the tenon, and *e* the side face of the tenon. In Fig. 30 we have the two parts of the joint ready for fitting, and in Fig. 31 the finished joint.

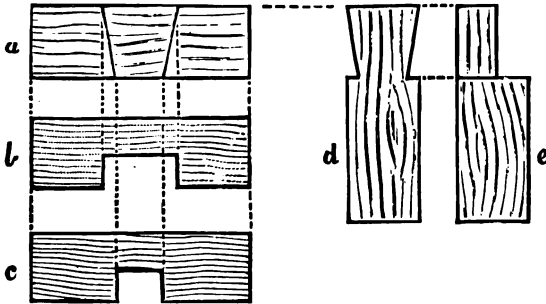

FIG. 29.—Marking and Sawing.

These four joints form an excellent exercise, and will, as we mentioned before, require all your patience and care to bring out with a good workman's ac-

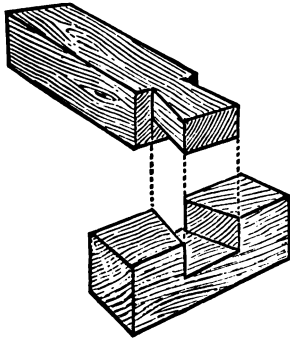

FIG. 30.—Fitting.

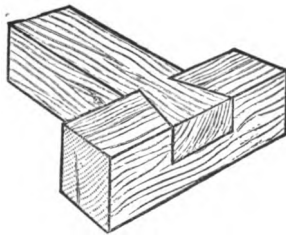

FIG. 31.—Finished.

curacy; but do not get discouraged, nor give it up till you have fully mastered every one.

The next form of joint that we want you to try

your skill at is given in Fig. 32, *a* and *b*. In marking this joint out before cutting, bring the two ends of the wood together flat on the bench, divide the thickness of each into three equal parts, mark



FIG. 32.—Marking and Sawing.

round the end of each piece, then place *a* on its end and cut out the groove, then *b*, removing the two outside portions, leaving the “tongue.” You will then have the two portions ready for fitting, as in Fig. 33, where the tongue and groove are

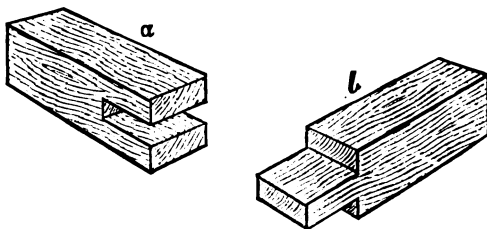

FIG. 33.—Fitting.

shown as cut, so that when they are fitted a perfect joint, as in Fig. 34, is the result. You see at once the importance of accurate marking and accurate cutting, so that when fitted it may fit tightly, without the least inclination to “looseness.” This joint

may be permanently fitted with glue, or with pegs, as we have before mentioned.

A joint such as this is useful in making a door-frame, or any frame where a beam has to rest firmly on upright posts. In sawing the ends it is best to

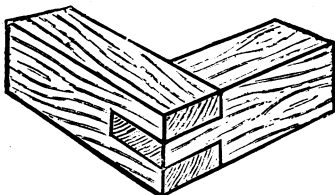

FIG. 34.—Finished.

fix the block in a bench-screw, end upwards, so that you have plenty of freedom in using the saw. In the next joint we have one that differs altogether from any of the previous ones. One piece is so tongued that it has to be fixed into the other. It



FIG. 35.

is called the tenon and mortise joint. Before beginning it, look well at the Figs. 35, 36, and 37, where each stage of the process is shown separately. In marking out the portions to be cut away, bring the end of one piece to the centre of the side of the

D

other piece like the letter T. See that the end of one piece is perfectly flat, so that the side of the other is everywhere in contact with it. Now draw two lines across the T piece in continuation of the

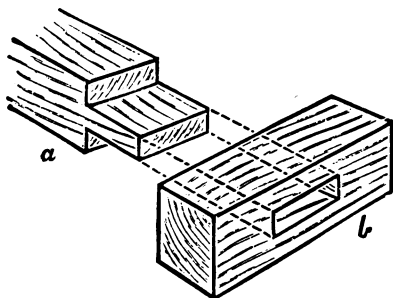

FIG. 36.

sides of the piece in which the tongue is to be cut. Now mark the tongue end across with two lines, dividing it into three equal parts. Do the same

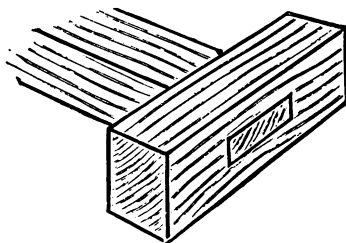

FIG. 37.

with the side of the T piece towards you, then you will have the place marked *b*, which is to receive the tongue of piece marked *a*. Remove the portions of *a* according to the method already given, by

standing it on end in a vice, or hold it with the bench-screw, and remove the portions by the tenon-saw. To get the hole through piece *b*, you must have a mortise-chisel and mallet, as shown in Fig. 38. The accuracy of the fitting will depend on the care with which you cut the mortise. First, hold your chisel, which may have a blade an inch in width, in your left hand; hold it vertically, the flat side towards you, cut the portion all round, keeping the edge of the chisel well within the line in case of its slipping. Give a smart blow with the

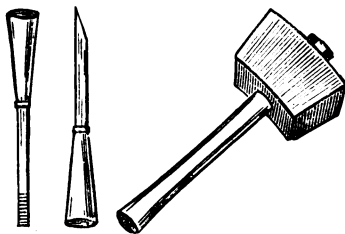

FIG. 38.--Mortise, Chisel, and Mallet.

mallet; the chisel will be driven into the wood from $\frac{1}{3}$ inch to $\frac{1}{2}$ inch at each blow. Do this from both sides, if you have to cut the wood through; if not, having gone round, dig the wood out to the depth of the cut made; then if required make a deeper cut, and repeat the operation of clearing out the wood. Hold the chisel firmly, keep it to the line, and keep a good edge on the chisel, and you will succeed. You may have to clear out some little irregularities, and smooth it up, but keep the edges sharp, and the sides at right angles to one another; this you can test with the square.

Now try the pieces, as in Fig. 36; if the tenon and mortise are both well cut they should fit as in Fig. 37. This is the most troublesome joint you have had to fit yet; but to do it well will fully repay all the trouble, care, and patience expended in trying. It is a particularly useful joint; for beams and supports fitted together with such joints are remarkably firm and strong. In doing the double tenon and mortise joint (Fig. 39, *a*, *b*), the same instructions must be adhered to. In marking out, the space must be divided into five equal portions



FIG. 39.

instead of three; in sawing it is more troublesome to keep the shoulders at the end of the tenons quite square. This, however, you will manage if you are accurate in your marking and measuring. In putting the two mortises in *b*, keep them quite parallel, and do not split the wood. You are not likely to split it if you have a good sharp chisel, and hold it vertically with a very firm grasp. Fig. 40 shows the pieces tenoned and mortised, and ready for fitting, as in Fig. 41. If you complete this joint well, you will have done a remarkably good piece of work. There is one other joint that

is exceedingly useful when a beam needs to be lengthened, and therefore we will ask you to try your skill on it. Divide the thickness of each

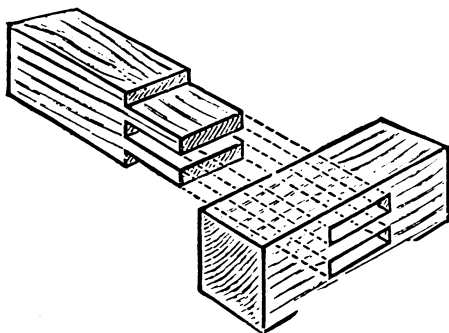

FIG. 40.

scantling into three equal parts. Mark with pencil or scribe, as in *a*, Fig. 42, with a line inclined inwards, not more than one-third of the whole thick-

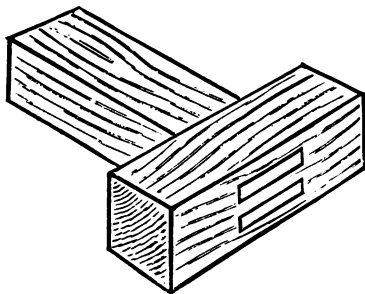

FIG. 41.

ness of the material, then a line inclined towards the centre about half as long again as the breadth of the wood. At the end of this a line about the length of one-third the thickness of the wood in

the direction shown; the next for the downward cut as shown in the figure. Now mark a second piece, *b*, with these lines reversed, then cut with a tenon-saw along the lines so marked, and you will have the two pieces as shown in the Fig. 42.

Now bring the sections together, and if you now drive a square pin, *c*, through the opening between the two pieces, you will see how strong the joined beam is. The joint may be permanently fixed by glue, and stronger still by a screw-bolt put through

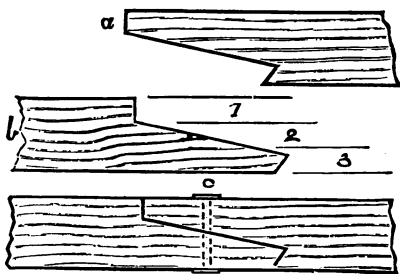

FIG. 42.

at *c*, to keep the parts from slipping. If you are careful to use only well-seasoned wood for all these joints there will be no shrinking, and therefore no loose joints, however long you may keep them. Such a series of joints kept by you form a sort of reference series, which will help you on when you are in doubt as to what joint is the most suitable for certain objects.

For shelves, boxes, drawers, square joints; and whenever neat work has to be done, to be able to put in a dove-tailed joint is very important. It is difficult at first to manage it, but when once ac-

complished, you will find it easier each time you have one to do; and it gives your work such neatness and solidity that we are sure you will introduce it into all your best work. In Fig. 43, *a* and *b* show how the marking and the sawing must be done. Try it first with wood from $\frac{3}{4}$ inch to 1 inch thick. You see it has to be so arranged

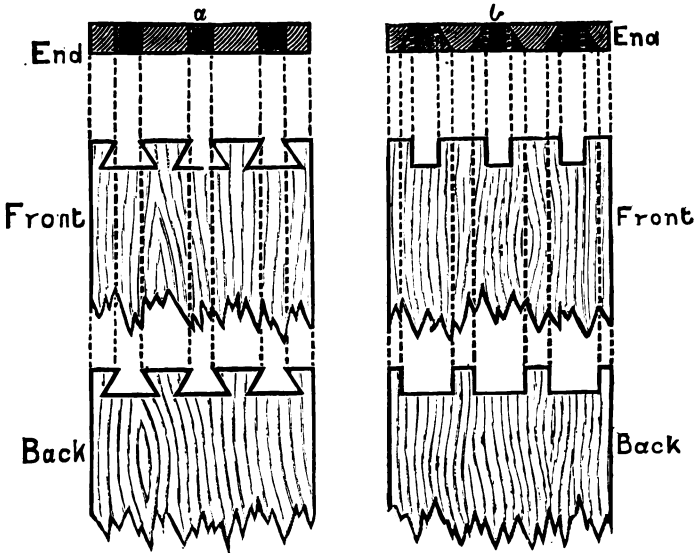

FIG. 43.

that the tongues or dove-tailed pieces at the end of one board must fit into sockets at the end of another board. First, with a pencil or scribe, draw along the ends of the boards to form the joint a line parallel to the edge, and an inch from it. Then mark out between the edge and the line the number and size of the dove-tail ends, as in front marked

a in Fig. 43; then do the same for *b*. Next, cut very carefully with a tenon-saw the slits for each tail-piece; then with a mortise-chisel cut along

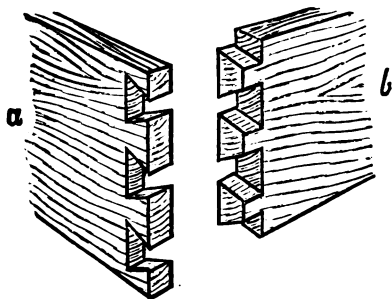

FIG. 44.

the gauge-line, and you will have the tongues as shown at front, *a*. On turning it round you will have them as at back, *a*, and the end into

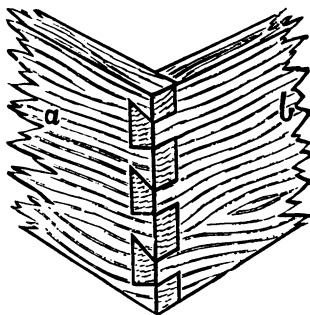

FIG. 45.

which this fits is represented in its various stages at *b*, Fig. 43. Fig. 44 shows *a* and *b* cut and smoothed up ready to fit together, as in Fig. 45; the ends will probably stand from $\frac{1}{8}$ to $\frac{1}{4}$ of an inch

above the general level of the sides; these must be neatly cut off with the tenon-saw. If you have performed this work accurately, the pieces will fit without any open spaces, and will be exactly at right angles to each other. Having acquired skill to make a good dove-tailed joint, you will have gained one of the most difficult steps of working in wood.

Work very steadily and very carefully at these various joints, and do not be satisfied till you have mastered them all. We do not say work at them continuously, but do something at them every time you go to your workshop, till you have acquired skill sufficient to do them readily and accurately. Call in friends who have good eyes for accuracy and neatness, and get their kind criticism on all you do.

In our next chapter we will proceed with a few heavier structures, which you can work at out of doors.

CHAPTER V.

HOW TO DO OUTSIDE WOODWORK.

WE will first suppose that you have a garden. The edging of the garden-beds is frequently a matter that has to be decided on. Tiles are heavy, brittle, and expensive; box-edging always requires clipping to keep neat, but a good wooden border put down carefully looks well, and lasts for years. This is one of the things you can do. Get some lengths of wood; if you have to buy them for the purpose, they will cost $\frac{1}{2}d.$ per foot, in lengths of 12 feet, width 6 inches, and 1 inch thick.

If you have to make them out of lengths from egg-boxes, you have nothing to do but cut them off in the lengths required; the width is determined by the stuff as it comes to your hand. In order to increase the length of time such wood will last, it may be charred. Some persons, to prevent the early decay of the wood when put into ground, tar its surface. This we do not advise if you want to paint it afterwards; if you do not, you can tar each length of wood before it is put into the ground—it is a sure preservative against early decay. If you determine

to do this, be careful, and only put the tar where it is required; you can probably borrow tar-brush and bucket where you get the tar. After tarring, the wood must get thoroughly dry before being used. In the other plan, the wood may be lightly smeared with petroleum; then set fire to it; the flame will quickly go out. It requires careful management. Do not perform operations near to any objects that will readily catch fire. This will slightly char the wood, so that it will be as well preserved when put

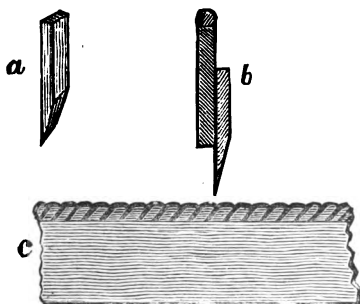

FIG. 46.—Garden edging.

into the ground as if it had been tarred. The other advantage is, the wood can be painted afterwards. While the wood is being got ready to put down, make some stakes of 2 inch stuff, and about 8 inches long. They must be shaved off so as to have one thin end, as in Fig. 46, *a*; this is to allow it to be driven into the ground easily. Having prepared sufficient so as to have one for about every 6 feet, take a line attached to a stake, and put it in the ground at the starting-point. Stretch it out along the line you want to put in your edging; draw it tight, and put in the

stake at the other end. Now with a garden spade, make a slight hollow trench all along the line. Put in the lengths of wood; make them secure by driving in the prepared stakes at proper distances; to give strength and stability to the wood, nail them together by some 2 inch nails. In driving in the nails you must either have some one hold a stone or brick at the back of the stake, or hold one there yourself with your foot, or each blow instead of knocking in the nail will knock out the stake. Having done this to the extent needed, get a coarse hempen rope, and nail all along the upper edge of the wood. When complete you can paint it a terracotta red, or you can paint it green. If properly done it makes one of the neatest and most durable garden-edges we know of. In Fig. 46, *b* and *c*, we show the section and elevation of the edging.

TO MAKE A SWING.

You may like to add a swing to your garden amusements. To put one up is rather heavy work, but with the help of a companion you may be able to manage it without a great outlay, and it will give a good amount of honest work to both of you.

First, you must have the uprights, then the cross-piece from which to suspend the swing, then hooks and rings, then the seat and ropes for the swing.

For the uprights, the best way is to go to a timber-yard, and select two lengths 10 or 12 feet of squared timber, or ends of scaffold-poles from 4 inches to 6 inches across. You may sometimes meet with such pieces cheap, but you must have good

sound stuff, such as will bear a good strain. Then you must have a "jamb" for each of the uprights to be sunk into to make for it a foot, and two struts for each upright. Fit them together, as shown in Fig. 47, *a*, making use of any suitable joint among those given in the last chapter. In Fig. 47, *a* shows how each foot must be fitted. The uprights must not be

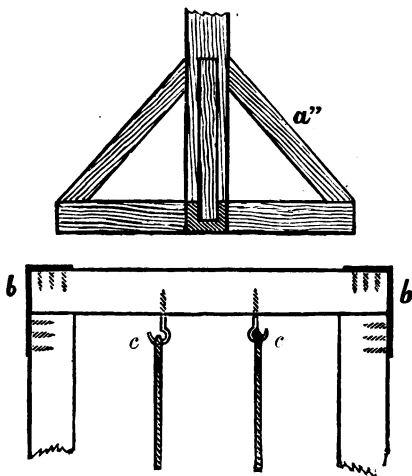

FIG. 47.—The Swing.

cut in any way so as to be weakened. The foot had better be about 3 feet long and 6 inches wide, with the bottom end of the upright let in, as shown in Fig. 48, with the struts let into the foot, and long enough to grasp the upright 3 feet above the foot. This must be put together with 3 inch nails. Bore the holes with a gimlet before putting them in, so there is no fear of splitting the wood. They must be sunk into the ground to the depth of 3 feet or

more in the case of a 12 foot length; tar them before putting them in; take care and fix them upright. Let the soil round these be well rammed in, so that they stand very firmly with a distance of about 3 feet 6 inches between each. The cross-piece at the top had better be fitted with a pair of strong hooks

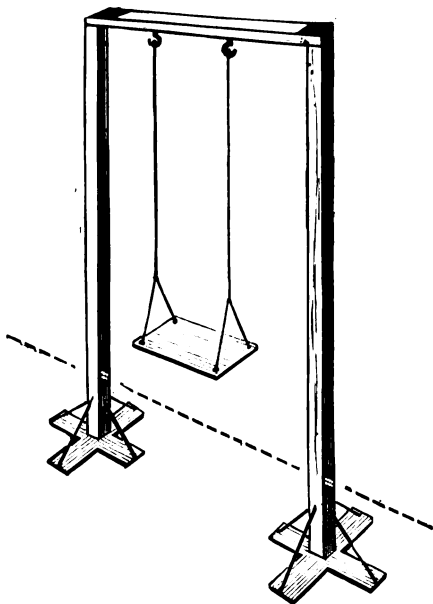

FIG. 48.

at a distance of 14 inches apart; measure the distance so that the swing hangs exactly in the centre of the beam. The hooks can either be screwed in, or they can pass through the wood and be fixed into a nut on the other side; whichever you can manage strongest and best. In putting the cross-piece into position, you can use the halving joint, Fig. 19, or

cut nothing away, but put the ends across the uprights, and secure them by an angle of sheet-iron (*b*, Fig. 47), which a blacksmith will make for you for a few pence, and which will bind round the cross-piece and uprights; nailed at the face and back; and will make the whole very firm and secure, and very strong. Then to improve appearances it will be better to give it two coats of paint, and while this is drying you can make the swing. Get a good board of hard wood, 14 inches by 8 inches; plane it up so that the upper side is quite smooth. At each end on the under side screw a cross-piece to keep it from warping or splitting.

Get a carpenter to put through the corners, not too near the edge, four holes for the rope to pass through. We say "get a carpenter," because these holes will have to be made with a brace and bit—a tool which we have not mentioned, or which will not probably be among the set you possess.

Now you want the rope. Get a good stout piece, long enough to suspend the seat about 2 feet from the ground. Arrange the rope as shown in Fig. 47, *c*. When the ends are spliced let them be bound over with some good waxed cord, so that there is no fear of slipping. In the upper end two grooved rings must be bound into the rope, so that by these the swing is suspended on the hooks. Under such an arrangement there will be little friction, and the durability is almost never ending. The complete swing is represented in Fig. 48.

A serviceable swing may be made with somewhat less outlay, perhaps, by getting four fairly straight bits of rough tree branches and letting them into

the ground with a strong iron bar held firmly in the two forks at the top. In this bar the two hooks must be fixed to suspend the swing from, as shown in former diagram. Be sure the whole structure is secure and strong; there are more ways of securing this than we can possibly mention in our general instructions. Frequently swings are fixed to the projecting arm of a growing tree, in which case it is very easily and cheaply contrived.

TO BUILD A SUMMER-HOUSE WITH TABLE AND SEATS.

A rustic summer-house is a structure we have frequently been asked about. How is it to be done? How shall we set about it?—and the like questions. Suppose we now give a few particulars that will help you to contrive such a shelter. First, pick the most suitable spot you may have, a corner which affords a nice situation, but do not select a spot where the drippings, and those likely to be heavy ones in rainy weather, will fall on to the roof of your house.

The frame-work of the house can either be made with squared wood or rustic; the latter gives a better appearance to a garden structure. If you can easily secure the wood it will well repay you. This is a larger piece of work than we have dealt with before, so that we must ask you to keep well to our general instructions.

If you cannot get any good strong rustic posts for uprights, get some quartering 3 inches square for a "lean-to" house, the back of which may come close

to a wall, so that the wall may form the actual back of the house. Having fixed on the size, mark out with a line your ground-plan. Get the uprights sufficiently long, so that they be sunk a foot into the ground. Let them be quite vertical, and so sunk that above ground the front stand at the same height; and the two back ones at the same height, but six inches lower than these forming the front of the house. The end is shown in Fig. 49, *a*. Mark off the

FIG. 49.

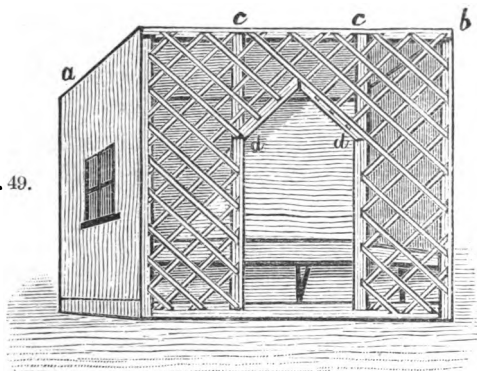

angle at which the uprights must be cut, for the top side piece to be nailed to, then nail it securely on the uprights at each end. For the front and back top rail, cut the ends, using the halving joint, Fig. 21. Put it into position, as Fig 49, *b*. Bore two good holes, and drive in 3-inch nails. It would be as well to char or tar the ends before putting them into the ground, as we directed for the swing.

Now you must have a frame-work for the lower part, to which the door-frame can be fixed, and to which the floor-boards can be laid. This had better be of 3-inch quartering, halved into the uprights at

front, back, and two ends. This will complete the outside and heavier framework.

The next thing, make up your mind as to the kind of doorway you would like. If you can make it with light crooked wood to give it a rustic appearance, so much the better; if not, take two lengths of 3-inch quartering ripped down the centre. Plane up the sawn side. Set a doorway 2 feet wide in the centre of the front of the house. Set these uprights into the threshold-piece to the depth of about an inch, and cut away the same in the upper part of the frame as in Fig. 49, *c*, taking great care that both pieces are upright. Secure them by some good nails, but bore holes first so that none of the wood gets split. Next determine the height of the doorway, and put on two pieces of the same material, halved 3-inch quartering; cut off lengths so that they form posts, as in Fig. 49, *d*. The sides and back can be filled in with thin boards of any description; those most easily obtained by you. Then there is the roof, which must be laid on rafters; the number of the latter required depends upon the length of the summer-house.

Then it can be boarded, and afterwards covered with felt to make it water-tight; or sheet-zinc; or even Willesden paper, which is light, water-tight, and durable. In fact if this substance is employed, no wood is required for the roof; the same remark applies to sheet-zinc. A piece of zinc must also be used all along the back lower edge of the roof, if it comes near to a wall, to form a sort of "gutter" to drain off the water; if free from the wall, a ridge lapped over and turned downwards is all that will be necessary. The front will look nicely if filled in with trellis-

work, as in Fig. 49; this may be done with ordinary plasterer's laths, or light slips of wood. In arranging this trellis-work, be careful and let it be quite uniform. Creeping plants may be afterwards trained to cover any part of the outside of the summer-house. The outside may be stained and varnished, or painted according to taste and the character of the surroundings. If made in rustic wood, painting it will of course be out of character with the structure. If you require a very level floor you can pave it with tiles, cover it with gravel well rammed and rolled; with shingly stones levelled and spread over with a layer of cement; or the floor may be boarded.

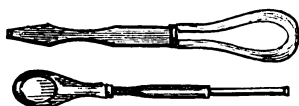

FIG. 50.—Screw-drivers.

Now you want seats and a table. A permanent seat can be supplied by an inch board, 8 inches to 10 inches wide, supported on end-pieces of the same thickness, and cut off a suitable height and nailed to the back ends of the summer-house, so that it runs the whole length. The number of intermediate supports must depend on its length. The table is the last item we need describe. The size of course we leave to you. In your choice you must be guided by exactly what you want, and if made movable it may be used generally for out-door purposes.

Take some $\frac{3}{4}$ -inch boards; cut them off each to the required length. Suppose the breadth is to be 3 feet, and made with four 9-inch boards, plane up

the edges with your jack-plane, and see that the edges when brought together fit quite close. Cut off three lengths of wood $2\frac{1}{2}$ inches wide and $\frac{3}{4}$ inch thick and 3 feet long for rails, one for each end and one for the centre; to these screw down securely the boards you have prepared with their edges close together. They will be the more secure if glue is spread along the edges before screwing them down. You should have two screw-drivers at least; one for

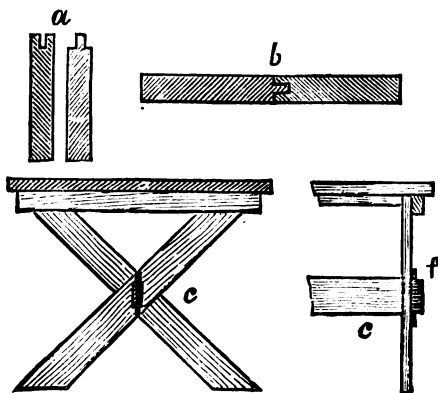

FIG. 51.—Summer-house Table.

heavy work, such as this we are now describing, and one smaller, as shown in Fig. 50. If you have the skill, the boards forming the top may be tongued and grooved instead of being brought together with the edges flush. This process we show in Fig. 51, *a*—the pieces before being put together; *b*, after they are glued together. For the support of the table, you want some red deal, cut in lengths of about 3 feet, and from 4 inches to 6 inches wide and $1\frac{1}{2}$ inches thick, to be fixed into one another where they cross,

as in Fig. 51, *c*. You must make a good joint, or the firmness will be lessened. Next, screw the legs on inside the rail at the table-top with good $2\frac{1}{2}$ -inch screws; and to give greater firmness still, a rail, Fig. 51, *c*, must be made and fixed as shown, held in position outside by a stout wooden pin, *f*. This will make a strong substantial table, such a one as many of our backwoodsmen brothers would be glad of in their log-huts, and such as you may be able to knock up if ever so fixed yourself.

Stools or forms may be made in the same style; but of all the simple seats to make, the three-legged stool is the easiest to accomplish. Take a slab of wood, round, square, or oblong—round is certainly best—in thickness it may be from $1\frac{1}{2}$ to 2 inches thick. Bore three holes at equal distances from each other, and about $1\frac{1}{2}$ inches from the edge; bore them not straight through, but sloping towards the centre. Into these holes drive some stout pieces of wood, as far as they will go; cut them off at the top flush with the seat; and from the direction of the holes the feet will project outwards beyond the seat; cut them off each the same length, and see that it stands firmly. Next cut a slit by means of a chisel into the top part of each foot, and drive in a wedge. This will firmly fasten the feet, and prevent their becoming loose when the wood gets thoroughly dry, should not that precaution have been taken at the first. For a square or oblong seat, four feet will do better than three, and if the seat is high, the legs must be strengthened by a ledge, which may be a half-inch rod let into holes bored into the legs and held firmly by glue.

A rough kind of chair may be made easily, of a seat or slab of wood, supported in a frame formed of four legs; where the legs on one side extend upwards to form the back, the legs and the back being strengthened with rails. The instructions already given, will, we think, enable you with exertion of a little ingenuity to make one, if you are so inclined.



FIG. 51 a.

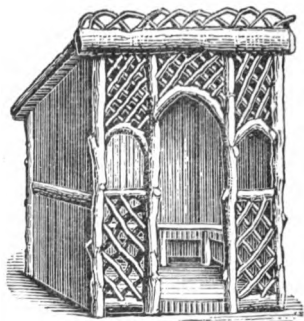

FIG. 51 b.

Designs for Rustic Summer-houses. For these we are indebted to Messrs. F. Rosher & Co.

CHAPTER VI.

OUTDOOR BUILDINGS AND STRUCTURES.

IN giving instructions in wood-work, the objects upon which you can exercise your skill and ingenuity seem to increase rather than decrease. We must therefore make this a chapter of general instructions rather than confine it to one or two objects.

In our last chapter we described the method of making a "lean-to" summer-house, but all spots are not suitable for such a structure. It seems therefore desirable to describe another form, and while so describing it, ask you to remember that in making the frame-work, the same mode of proceeding will do for a shed or a wooden house of any description.

In making the frame-work, the uprights can always be sunk in the ground, the holes being well rammed with bits of brick, stone, or other material; or a frame-work may be made so that it can be taken down and removed easily, the uprights being fixed to a wooden foundation instead of being let into the ground. The foundation-frames often rest

on a course of bricks sunk just below the surface, and are best made by cutting off the lengths of wood and joining them with the half-lap joint (Fig. 19). This is a simple joint, but often badly made. Remember there are three surfaces to be made for close contact; there is not only the overlapping portions, but the end of each lap; these, accurately fitted, is a type of good workmanship.

Do all the cutting across the grain with a tenon-

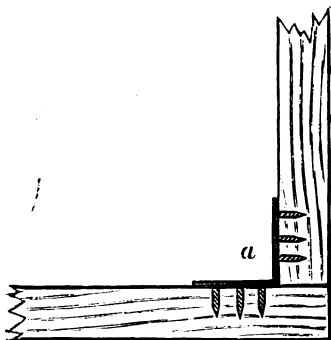

FIG. 52.—Spars joined by "angle" iron.

saw (Fig. 18), and do not go a fraction beyond half the thickness of the wood. As these pieces when joined together will be on the ground, and subject to damp, it will not do to use glue, but they can be joined together by wooden pegs called "dowels," put in perfectly dry. Let the dowels be cut $\frac{1}{8}$ inch shorter than is needed for the united thickness of the wood, and dried before the fire for an hour or so before putting them in so that they may get their maximum shrinkage.

The frame-work may be square, oblong, hexagonal,

or octagonal—the two latter are favourite shapes for summer-houses standing in snug corners. The uprights are put at each corner, and may be secured by angle irons, as in Fig. 52, *a*, if you do not use the halving joint; the upper part of the frame-work being made according to the directions given in the last chapter.

If in the case of a summer-house you want a

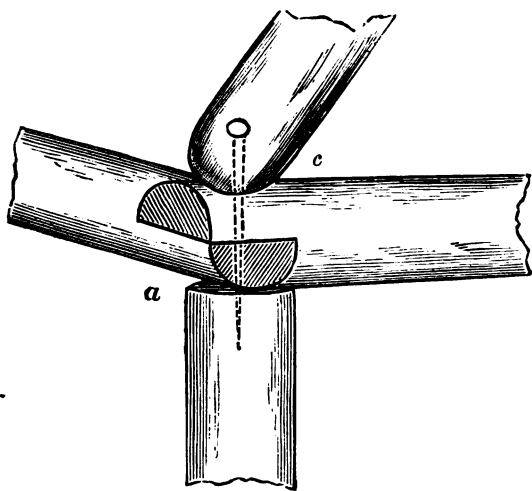

FIG. 53.

pinnacle roof, you form it with $1\frac{1}{2}$ to 2 inch stuff, according to the size of the house; the upper end of each spar must be carefully cut so that they meet together as one piece. Such a house may be covered in with thatch, heather, or a plain wooden roof, or Willesden paper, and if you want to give a rustic appearance to it, and have only light wood for the purpose, split the wood down and nail it with the

flat side next the wood-work. The whole may be then stained and varnished according to our former directions. You will thus have a structure that is durable and strong, and one that can be removed from one place to another without any great amount of trouble.

For a summer-house built with unplanned wood,

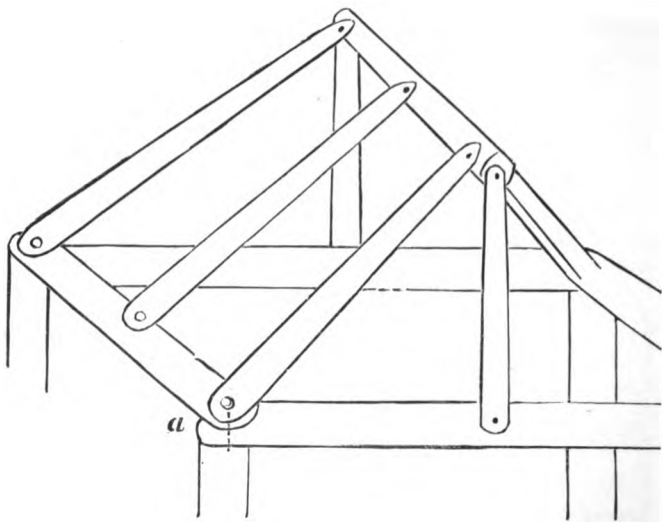

FIG. 54.

select wood that has been cut down in the winter with the bark on—suitable branches can be selected from the common fir, the silver fir, and spruce. For the uprights you must select good straight poles, and almost 4 to 5 inches in diameter. For the smaller work you can use crooked oak branches, or branches from the apple-tree. Inside work may be done with hazel, and sticks from the maple.

Supposing you want a house of such dimensions as the following—8 feet long by 4 feet wide, and 6 feet high to the eaves, the collar or end posts must be set into the ground at least 2 feet, having the bark stripped off this portion and well tarred to preserve them. The cross-pieces at the top are halved and joined to the top of the collar-posts, as shown at Fig. 53. This is done after the tops of the corner-posts are cut flat. At the top and bottom inside the house, pieces are nailed to corner-posts, to which the

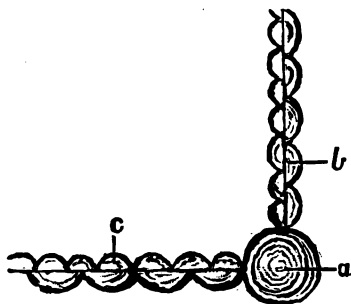

FIG. 55.—Showing plan of corner of Rustic-house.
a. corner post; *b.* split wood for outside; *c.* split wood of thinner wood for inside.

wood forming the sides and ends of the house are to be nailed. Saw the ends of the rafters as shown at *c*, and fasten the whole together at each corner by large nail-spikes. The frame-work of the roof should be as shown in Fig. 54. The walls of the house are formed by split poles, as shown at Fig. 55. These want to be ripped by the circular saw if you can have them so done; the cost will not be much. The inside may be done in the same way to half its height, and the upper half to the eaves with

smaller wood, nailed diagonally. This gives it a nice appearance. To roof it in—thatch may be employed if you like to try your hand at this method of roofing—it is quite in character with such a rustic

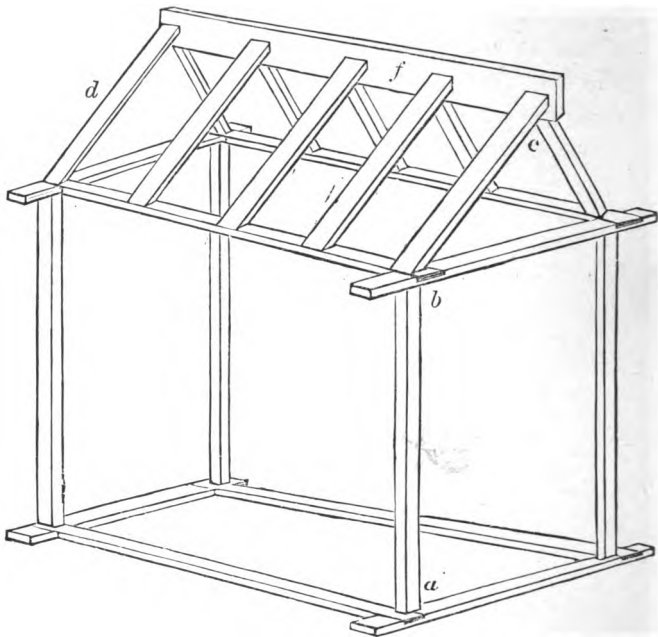

FIG. 56.—Frame-work of Out-house.

structure. The rafters are crossed and connected by rough rods nailed at about 5 inches from each other.

For thatching purposes, heather or furze, fastened by small twig buckles, is best. Lacking this you must do it with straw—of which wheat-straw is the best—which will, it is said, last for twenty years if well done. We are afraid we can give no very good

directions for thatching; but in districts where it is likely you will get good material for rustic work, there it is likely you will be able to get instructions from a thatcher, who is kept on a farm for this class of work; for all stacks are covered in with thatch. In thriving agricultural districts prizes are frequently given for the best and neatest thatching, and a man capable of doing this work well will only be too pleased to render assistance to an amateur.

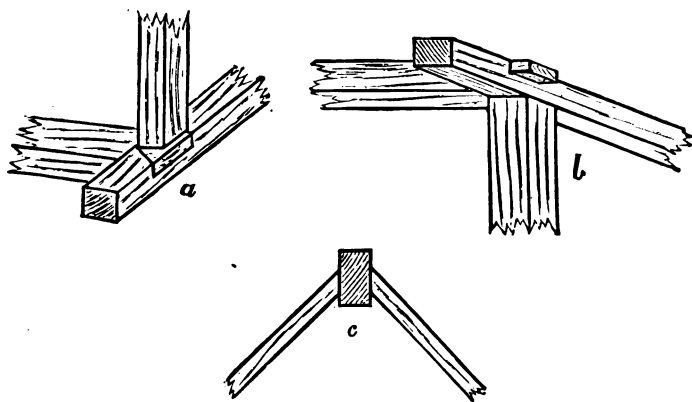

FIG. 57.—Joints employed in Out-house.

With ordinary trouble and a good use of the tools we have described, you can make several articles useful for out-door purposes, such as a tool-shed, hen-house, hen-coops, hutches, kennels, bee-hives, flower-stands, put up ordinary fences, and make plain doors and gates.

For an ordinary house or shed we will give you a few general directions, which, with those already given, will assist you to carry out successfully any work of this kind. The wood required is 3-inch

quartering for the ground-frame and uprights, while $2\frac{1}{2}$ inch will answer exceedingly well for the rafters.

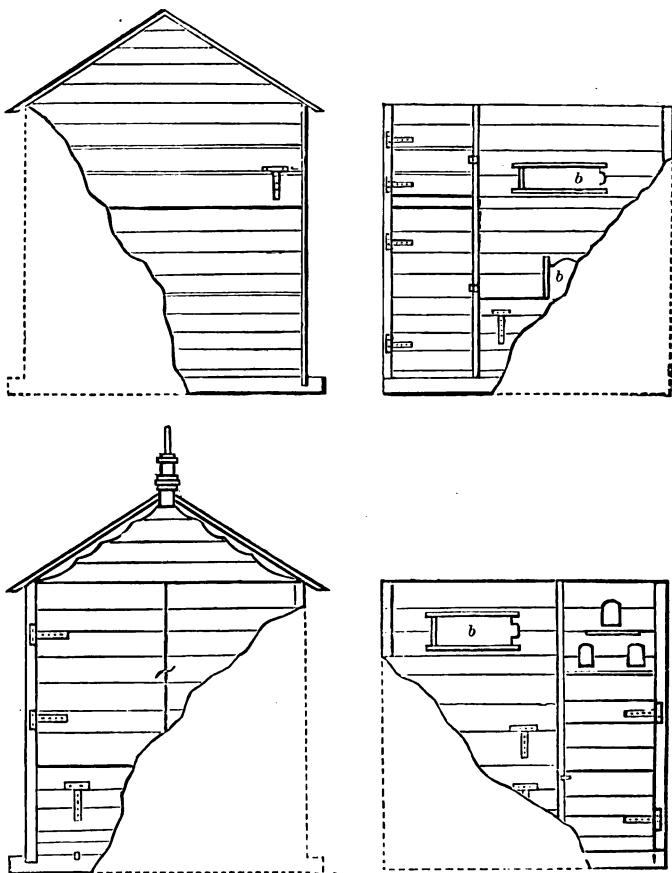

FIG. 58.—To show arrangement of Nest-boxes and Slip-doors.

The skeleton frame-work we sketch in Fig. 56, while the joints employed in putting them together are

given respectively in Fig. 57 at *a*, *b*, *c*. These you will observe are simply applications of those given in Chap. IV. The rafters *d*, in this case, are nailed to a narrow plank *f*, which acts as a sort of key-board, for if securely nailed the weight of the roof itself will keep it in position.

For roofing purposes we have already said enough. If, however, you make a fowl-house, nothing is so good for the roof as zinc. In such houses it is

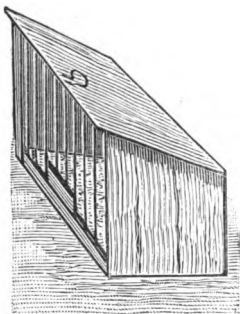

FIG. 59.—Hutch.

frequently required to ventilate them, and to make boxes and drawers inside, which require to be got at, by slip doors, as at *b* in Fig. 58, where the door opens to various parts of the interior, and for this purpose are fixed vertically and horizontally, carried out somewhat as the plan. The nest-boxes are suspended or placed on shelves in the house, and are shown in Fig. 58. Such a house must also be closely boarded to keep out both cold and damp.

The size of your fowl-house must regulate the kind of structure you put up. You may buy large boxes or tea-chests, which, with little alteration, will

help you without the elaborate structure we have described.

For making hutches, a large box will frequently suffice. Alter one side into a sloping surface for a roof. The front may be arranged with wooden bars, a portion fitted in a wooden frame to act as door, as in Fig. 59, or it may have a front of wire-netting.

Wire-netting may also be used for enclosing the fowls' run, which should extend as far from the

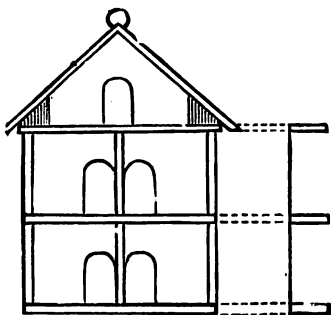

FIG. 60.—Pigeon House.

fowl-house as your space will allow; the less confined your fowls are the better they will prosper.

A Pigeon-loft is also easily made out of a box. Give it a pitch roof, as in Fig. 60, and it may be nailed to a wall attached to your fowl-house or mounted on a pole. A house for five pairs of pigeons may be made of a box 2 feet long and 1 foot 8 inches wide and 12 inches deep. Let the box be stood on an end, and the divisions in it made as shown in Fig. 60. Then fit a front of $\frac{1}{2}$ inch or $\frac{3}{4}$ inch stuff, cutting each so that a stage of 3 inches wide is left in front of each.

A Hen-coop is made of a ground frame of 2 inch stuff, and rail 1 inch by $\frac{3}{4}$ inch, enclose it as shown in Fig. 61. Let a little sliding-frame be

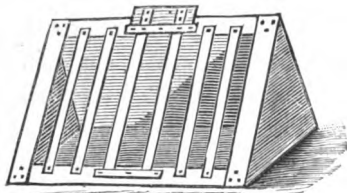

FIG. 61.—Hen-coop.

attached to one side, that can be raised so that the bird can be allowed to get out and in without lifting the whole thing off the ground. An improved form is shown, made like a rabbit-hutch, in Fig. 59.

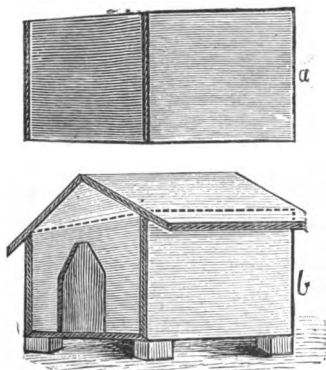

FIG. 62.—Dog Kennel.

A Dog-kennel can be made out of a box, unless you want a very large one. Suppose you require one 2 feet long, 1 foot 6 inches wide, and 2 feet high; a box of this size is frequently to be bought

cheap at a tradesman's—Fig. 62, *a*. At one end cut out the entrance through which the dog can pass easily. Then trace above it the lines showing the pitch of the roof, and cut the ends into shape. A strip or two may be required to be taken off the sides; if so, they will come in for roofing; which when complete must be painted; green or black is best. Then put it on to four square blocks, so that it does not stand close to the ground—Fig. 62, *b*. The inside does not require painting, but may be kept sweet and clean by a coat of lime frequently.

TO MAKE A CARPENTER'S STOOL.

You will, for heavy work and for sawing wood, often require a substantial support for your work.

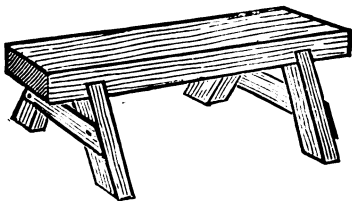

FIG. 63.—Carpenter's Stool.

This you will have if you make yourself a carpenter's stool, or even a pair of them. In Fig. 63 we give a sketch of it, so that with the instructions we have already given, you will find no difficulty. Make the top of $2\frac{1}{2}$ inch stuff, and about 3 feet long by 6 inches wide. The feet may be made of 3 inch quartering. The rail for binding the feet of 1 inch stuff by $2\frac{1}{2}$ inches wide.

TO MAKE A SET OF STEPS.

In Fig. 64 we show such a set as we propose that you should make. The sides may be 3 feet or 6 feet in length, and about 5 inches wide, and 1 inch thick. The bottom ends must be so cut that when standing it is in a slanting position. The four steps shown at *a* are $5\frac{1}{2}$ inches wide, so that when fixed the front projects $\frac{1}{2}$ inch from the side, and each is 1 inch

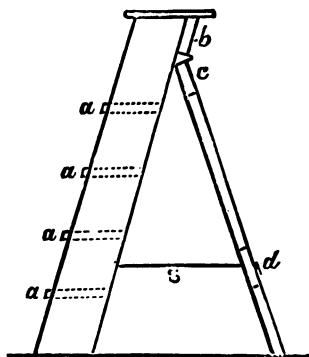

FIG. 64.--Set of Steps.

thick. The top step is 12 inches wide, the next below 13 inches, and so on for each step, so that the lower end of the steps spread out, and by this means stands firmer. The distance between each step should be from 7 inches to 9 inches, and each must be fixed to the sides by a groove, as shown at *a*, or by mortise and tenon; in either case they must be very secure. The top step of all forms a sort of stage; into it the sides should be mortised, or let into a groove. The latter arrangement, however, tends to

weaken it, therefore the other is the better way. This step is wider than the others, and projects all round about 1 inch. When this portion is complete, screw on a flat piece of board across the top, as at *b*. To this attach a pair of strong flap-hinges. Then make a light frame of 1 inch stuff, consisting of two upright pieces 2 inches wide, and two cross-pieces; one at the top, *c*, and the second about a foot from the bottom, *d*, mortised into the uprights, and held fast by glue. Then let it be screwed to the under flap of the hinges, and be cut off the same length as the steps side. A cord, *s*, is attached to the steps and frame to determine the distance to which they can stand apart, and give firmness to the whole.

TO MAKE A SHORT LADDER.

Get a tapering pole 10 or 12 feet in length; bore holes through it at intervals of 8 inches or 9 inches, about $\frac{7}{8}$ inch in diameter. Now let the pole be ripped down the centre, and prepare as many spokes as you have holes, taking care that the lowest shall be the longest, and that each one above should be a trifle shorter. Let each be fitted quite tight, and at the bottom and top be very secure; and if the ladder is longer than 12 feet, an iron rod put under the top and bottom stave, projecting through each side and secured by a nut, gives extra strength and security to it.

TO MAKE A DOOR.

Doors are of two kinds—ledged and panelled. The former is less difficult to make than the latter; in

fact it requires more skill to make the latter kind of door than you would well acquire, so we will give directions for making a ledged door. Every door must have a frame, which consists of two side-pieces called the "jamb" (*a*, Fig. 65), and a lintel, *b*, which is generally halved into the jambs, and a sill, *c*,

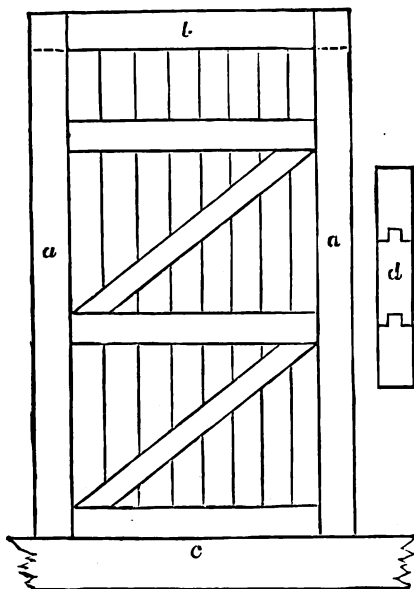

FIG. 65.

into which the lintels are generally mortised. The simplest kind of ledged door consists of boards, the edges of which come flush together, and are secured to the rail either by screws or nails. A better door would have the boards grooved and tongued, as in Fig. 65, *d*, and then secured to the ledges, which sometimes have diagonal braces added to give greater

strength. The hinges, both the size and kind, must be determined by the weight and the size of door.

TO MAKE FENCING.

An easy method of making a light fence is by open lattice-work nailed to rails supported on posts at intervals, the length of which must be determined by the height and weight of the fence. The posts must be sunk into the ground. This portion should be thicker, and need not be planed up as carefully as

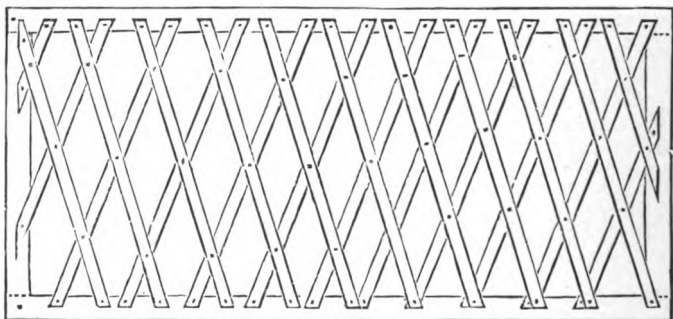

FIG. 66.

the part that is above ground. The lattice or open portion should be done with smooth laths, as shown in Fig. 66. Take care that the posts are upright, and that the earth is well rammed round the sunken portion.

A very neat and substantial fence may be made by strips of cleft oak, one strip of which laps over another. These palings require substantial posts into which rails are tenoned. To these rails the palings are fixed, while a board runs along the bottom giving a finish and strength to the whole. The open paling is another favourite method of

fencing. It consists of rails tenoned into posts, to which neatly cut and planed palings are nailed at regular intervals, as shown in Fig. 67. A gate can be made to suit any style of fencing. First make a strong frame, which must be mortised together, and strengthened by a diagonal rail. The post to which the gate has to be hung must be equally strong, and the latch and hinges must be strong enough to carry

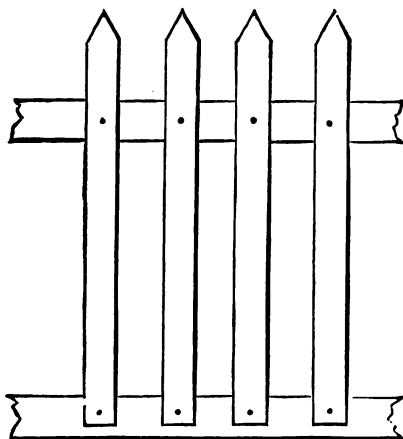

FIG. 67.

the gate, but plain or ornamental as a matter of taste. If the gate is very heavy, the post to which it is hung must have a foot similar to that attached to the upright for the swing; for the post must be upright, or no gate will swing well.

Following the directions we have given for making the various items, we think you will have gained sufficient skill in handicraft to accomplish most things you will be called on as an amateur to do, and

at the same time have gained a good knowledge of the use of tools, which can afterwards be extended should you put yourself under a good teacher, or even become an apprentice to some handicraft business.

In regard to the prices of wood used in making the various articles mentioned, we have quoted it as received from a deal-yard, where you can get it of any description, and in any length, width, or thickness, and rough or planed.

You, into whose hands this book may fall, will have different methods of supplying yourselves with wood. Much good wood, except for the heaviest posts and uprights, may frequently be bought up in the form of disused packing-frames, and boxes of various descriptions. Take care in every case to remove every nail or screw that would prevent you from using a plane or cutting tools about them, and do not buy wood planed if you can do the planing and smoothing for yourself. We have given no very special directions about nails or screws. These you had better select from a good ironmonger's, where you can see every kind you are likely to want, and where you can have any directions you need for using them. In buying locks and hinges, the prices given includes the necessary screws.

The various stains or varnishes we have mentioned are kept by most oilmen. If, however, you like to make them for yourself, you can do so. We think that our directions in one of the early chapters are clear enough to enable you to do so.

In our next chapter we shall give directions for making things of lighter structure, in the form of ornamental work and model-making.



CHAPTER VII.

INDOOR WORK.

IN this chapter we propose to give a few directions for making smaller objects, including models. Such work is better adapted for winter evenings, when you can sit indoors and work, and at the same time not be shut out of the family circle; but while you are working, can even appreciate some one reading an interesting tale which you would likely find yourself well able to follow.

In the first place, we will introduce another kind of joint which you may find particularly useful in making up small boxes. As to the kind of wood for small work, you must select that according to the objects you intend to make. You will find cigar-boxes very useful. You can take them to pieces, rub them down, and smooth them, and they will be easy working and take a good polish afterwards.

Now for the joint we spoke of. It is a tongued and grooved joint, as shown in Fig. 68. Here the end pieces are rebated as shown at *a*, and the front and back pieces grooved as at *b*. When such joints are made and well set, the glue hard and dry,

the corners may be rounded off as shown in the figure.

Now as we have, in small work especially, frequently to talk about glueing, let us see how it is best done. You all know that joints and sections are glued together to strengthen them and hold them piece to piece. This is best accomplished by putting on a layer of glue of the least possible thickness, and when the joints have the glue neatly smeared on them, and the parts to be joined

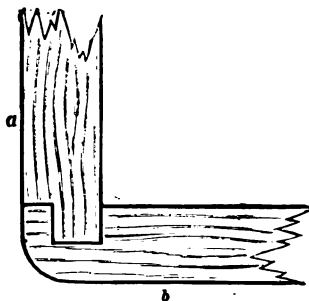

FIG. 68.—Tongued and grooved joint for small work.

squeezed hard together in a screw-press or vice,—if the work admits of it,—all the glue squeezed out should be carefully wiped away. Glue should be put on quite hot, and in cold weather the joint to which it is applied should be warmed, if it can be done without warping the stuff. It is said that the best kind of glue-brush can be made from a piece of rattan cane deprived of its outer crust, then dipped into boiling water and well hammered out to separate the fibres; it is certainly durable and cheap, and its stiffness enables you to apply the glue very effectively.

In making models in thin wood, either in deal or in the cedar wood of the cigar-boxes we have mentioned, you must first draw out your model to size, then you must cut out the various parts of it in thick

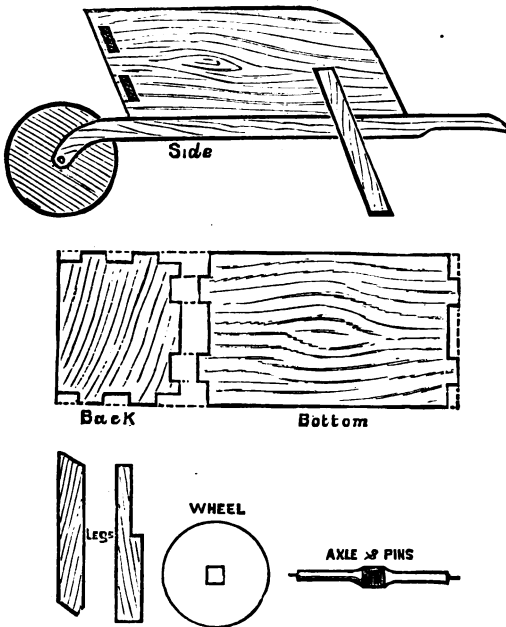

FIG. 69.—Wheelbarrow.

brown paper or cardboard, and from this trace the pattern on the wood to be cut.

Let us take one instance. Suppose you want to make a model of a wheelbarrow for a toy or an ornament. Sketch it first as in Fig. 69, then cut a piece of paper the size and shape of the edges, either with or without handles, which we will call piece 1.

Then these must be joined to the back and front. You must be careful that these pieces are cut so that they exactly fit. Then a piece for the bottom of the barrow, then the two pieces for the feet, which should be thicker at the bottom than at the top, where they are to clasp the sides tightly, so that the body of the barrow rests in the projection of the lower piece. Then you have the wheel and axle. Take care to cut the wheel quite round, and a square hole in its centre through which the axle is to pass; bevel off the edges of the axle with a spokeshave (Fig. 70) so that it may look light and yet be strong enough to be in character with the rest of the structure.



FIG. 70.—Spokeshave.

In cutting thin wood, which we have supposed here not to be more than $\frac{1}{8}$ or $\frac{1}{16}$ inch in thickness, you must be very careful not to split it; it must therefore be cut with a fine sharp saw or with a penknife. If you cut the sides with a saw, hold the two pieces together in a vice screwed on to the end of your bench or table, then you can cut the two together. You will then be sure of them being the same size.

The vice will be a great help to you in addition to the bench-screw we mentioned on page 42, because you get a secure grip with it in positions where a bench-screw is not practicable. In Fig. 71 we show such a vice. When you have to put into it soft wood such as you will require for use in model-making, you must put two slips of lead, slips of wood,

or layers of pasteboard between the chaps of the vice, or when you screw up the wood tightly the roughened faces of the jaws will leave an impression on the wood. If you wish to increase your tools still further, get a wooden vice with jaws 6 inches wide; this is very useful for holding light work when firmness is required.

Now to go back to the wheelbarrow. You have all the pieces ready to put together; try them, and satisfy yourself that they will fit well. Carefully

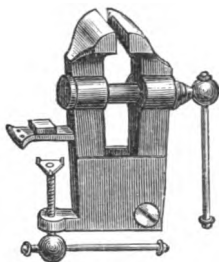

FIG. 71.—Bench-vice.

prepare some thin glue, and put on to each part, and put it together. Fix it in your bench-screw in such a manner that it does not shift till it is quite dry. Then put on the legs and the wheel. The wheel had better be fixed with two stout brass pins for the axle. You can ornament the model in any way to suit your taste by a few brass tacks, or you can polish or varnish the woodwork. We need not go through in detail any other such model, for you proceed in a similar way in producing any of them. They require care and neatness, and you will soon be pleased with the results of your application. You will gain quickness

in your work, and a more masterly manner in handling your tools.

A glance at the windows of a good toy-shop will suggest many things that you can make in the model line. There is the "mail cart," which is so frequently used now instead of the perambulator. You can make a model of it. The body of the cart will give you a good exercise in light work, where you have open work instead of plain sides. Cut staves of an even size of $\frac{1}{8}$ inch stuff, put them together neatly with glue or brass pins, fix them to the bottom, put in cross-pieces on which to support the seats, which will also answer the purpose of strengthening your cart. As to the wheels, you can either buy a pair of a suitable size, make them of one solid piece as in the barrow-wheel, or patiently work at a hub and spokes, cutting out the sections neatly, first laying down on paper the sizes of each, and cutting your wood according to pattern. A strip of thin iron will form the tyre of the wheel, or if india-rubber be preferred, take an ordinary elastic ring of the proper size.

You have now in these directions got the key to the construction of many amusing and interesting toys. There is nothing children like better than a cart, or something they can load up and drag about from place to place. You can fit up a small cart or waggon for the little loads your small brothers and sisters like to make up "for fun," or you can make a conveyance on two or four wheels, large enough and strong enough to carry any of them about the garden, or along the smooth pavement of the street. We will not say you can make anything that would

carry them comfortably along the rough road, for that would require the use of springs—this is beyond us at the present. An ordinary strong box screwed on to an iron axle, to which a pair of perambulator wheels may be fitted, will make a very

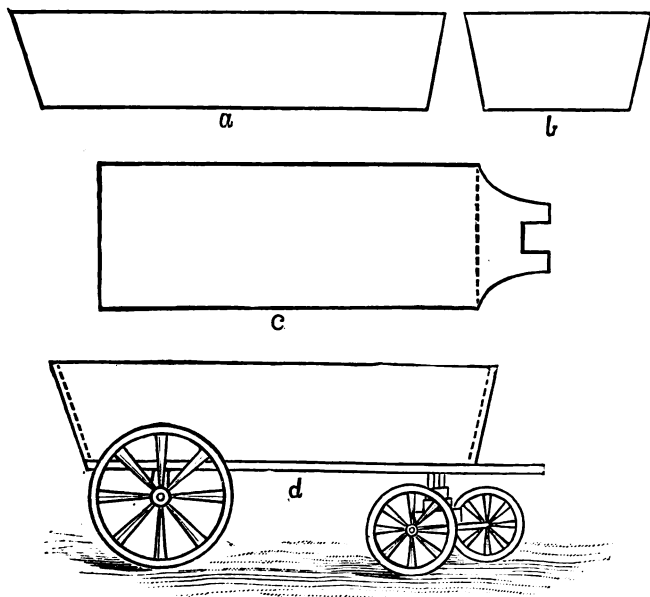

FIG. 72.—Parts of model waggon.

respectable cart, which may be painted or varnished, padded or cushioned, according to taste or requirements. To this you can fix a pair of strong shafts of plain or shaped wood; tough wood should be used, for if of plain deal they are liable to split or snap with a sudden twist.

A small waggon can be made out of a box, or you

can cut some pieces of wood to the size you require. Shape them much in the same way as directed for the wheel-barrow, nail them together with small brads, and then join to a bottom-piece. Then cut four wheels, which can either be put on the ends of wooden axles, or a screw may pass through the centre of each, and they can be fastened directly to the body of the waggon.

To make it still more elaborate, as in Fig. 72, you can make the front axle movable about a centre, and with smaller wheels, so that when the vehicle is turned round, these wheels run under it. The level between the larger and smaller wheels is here compensated for by the front axle being made thicker than the fixed one at the back. It may be fixed to the waggon by a screw, the smooth part of which forms the shaft on which the axle is to turn, the screw part being fixed into the bottom of the vehicle. A handle may be fixed for drawing it along, or a pin may be put into the V-shaped piece in front for that purpose. This will be a strong serviceable toy of which many youngsters would be very glad.

Many other strong and durable toys made on the same principles will suggest themselves to our readers.

A doll's house is a good thing to set up. The outside is made in the ordinary box fashion; the furniture for the inside requires some ingenuity and care, but there is nothing difficult in making the small articles of furniture like tables, chairs, couches, beds, and cupboards. You can select your models from the penny toys of chairs, tables, and such articles which are quite suitable for this purpose.

All these items can be made in the wood from cigar-boxes, as we mentioned, or in deal about the same thickness. Most of the parts can be cut with a penknife, and put together with carefully made glue.

BUILDING BRICKS.

Another very interesting set of toys you can make for the younger members of your family, is a set of building bricks and blocks. For this purpose, plane up several lengths of wood, $\frac{1}{2}$ inch by $\frac{3}{4}$ inch, and cut them off in lengths of 2 inches. Cut off any number you please, from 200 to 400. These are for whole bricks. Then cut off about 100 of 1 inch long. These are for half bricks. Then you want some smooth pieces of the same thickness to form the foundation of your building; and to bridge over windows and doors, cut about 30 or 40 pieces, some 4 inches, others 6 inches and 8 inches respectively; some triangular pieces for the gable-ends of the house; and some long, lighter pieces, according to the length of the house to be built, for rafters. The roof can either be made with card cut out in the imitation of slates, or light pieces of wood, to the under upper edge of each a tiny block must be glued, so as to give it support on the rafters. The lower ridge must first be laid, then the second, and so on; the top ridge must be made of V-shaped pieces, the angle of which is to be placed uppermost. Doors and windows can be made, and fixed in small frames to be put in the proper places in the brick-work. The doors can be made in panels, or can be of a plain piece of wood on which the panels are merely lined out. The windows can be made of glass

squares, over which cardboard sashes are pasted, or the frames can be made in wood, and the squares of glass inserted. All these points of detail can be carried out according to the taste and the time you have at your disposal.

From our own experience a set of building bricks has formed one of the most lasting and instructive toys in use.

Blocks may be cut to build arches, bridges, and ornamental buildings, to any design or size.

When completed, make a box that will just contain all the pieces belonging to one set.

TO MAKE A READING-DESK OR MUSIC-STAND.

For this purpose you require some strips of wood about 1 inch wide, and $\frac{1}{8}$ of an inch in thickness. These you can cut for yourself by ripping up some thicker wood into $\frac{1}{4}$ inch thicknesses, and of the required width; this extra thickness must be allowed for planing to be done afterwards. Plane them up carefully. Now put them together so that they form a frame consisting of three uprights and three cross-pieces, as in Fig. 73. Take a chisel and take off the corners; rub them well down with glass-paper, so that their surfaces may be nicely smooth. To put them together, place them on a table or a flat surface, and measure off the distances they must be from each other. Carefully bore holes big enough for nine $\frac{1}{2}$ inch screws, with which they must be fastened together. Into the central bar two screws must be put at each joint if you require it to be rigid; only one screw if you require it to shut down into a small space.

Now there must be a rest for the book, which must be screwed to the under edge of the frame. Let this be a trifle thicker than those you have used

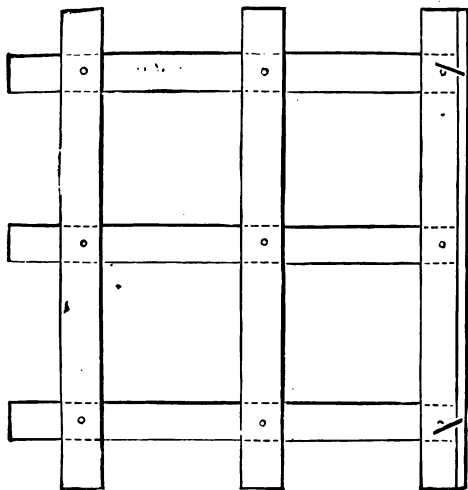
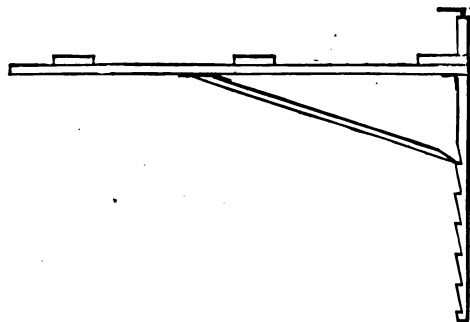

FIG. 73.

for the frame of the desk. Next screw it on from the back at right angles to the frame by putting three screws—one in the centre, and one nearly at

each end. Round the ends off. Now you must prepare a piece to act as a foot at the back. You will require for this a small brass hinge; one lap to be screwed to the leg, the other to the frame. With the chisel, bevel off the lower end, so that the whole foot stands level with the stand. You can buy two hooks or fingers for the outer edge, to keep open books, or to hold papers put on it, and the whole thing will be the better for staining, varnishing, and polishing. By a simple contrivance it may be made to fix on the stand.

For these smaller things you must use a fine saw, sharp chisels, and do not use brad-awls and gimlets too big for the screw-hole, or the screws will fit loosely, and all your work will be loose and rickety. Finish off your work nicely; get the surface very smooth before you polish or varnish it.

BOX FOR WINDOW GARDENING.

Zinc troughs make the most durable boxes for the cultivation of plants in window gardening, but flowers are frequently cultivated in boxes made of wood, and to make one of these we now give directions. Take the length and breadth of the window-sill to which you require to adapt your box. Give it a depth of from 6 to 8 inches. Take $\frac{3}{4}$ inch stuff; there is no occasion to plane the wood that is to go inside, but the outside is better for planing. Nail the pieces together to form your box; then the front and ends can be covered with ornamented tiles or with rustic work, or with a pattern stencilled in various shades of oak-stain,

which can be afterwards varnished. To cover it with rustic work you require some dried branches about 1 inch in diameter for the outer work, and less than that for the inner work. Several designs may be adopted, but that shown in Fig. 74 is by no means a bad one, and is easily carried out.

First divide the front of the box into five equal portions; find the centres of each of these, then split carefully the branches to be nailed on, having previously cut them off into proper lengths, using the thicker ones for the outsides. Nail them on as shown in Fig. 74, then nail some narrower lengths in the same way inside, and then another row of



FIG. 74.—Rustic front to window-box.

still smaller. Then for filling in these spaces, split a number of branches and nail them within the diamond-shaped space, each piece upright, close together side by side. The design, if nicely carried out, is very neat and effective, and the front of the box will thus have three panels, in the centre of which a fir apple or rough knot can be placed. Then the whole can be varnished. We have supposed in this case that the bark has not been removed from the branches used. Such a box may also be fitted on rustic legs and used as a flower-stand for indoor purposes. In either case the box may be covered with "virgin cork," in the absence of branches of wood, and may be made equally effective.

In using the wood also, the design can be varied in many ways from that we have given, and be equally ornamental. A rustic pedestal for flower-pots may be made suitable for any niche or corner, constructed on the principle we have suggested. "Oak-wrongs," as they are called, can frequently be bought of gardeners, and may be ingeniously worked up together to form not only a very substantial but very ornamental piece of work. In the case of oak it is better to clear off the bark before making up. Cork has been largely used of late for ornamental rustic work, and it is very effective if tastefully employed, for arches, ferneries, and ornamental gardening. It can be nicely blended in with rockery, and can be used outside as well as inside a greenhouse.

An additional ornament to a fernery or a greenhouse rockery is a miniature fountain. This can easily be managed by bringing a pipe—small compo-tubing will do—from a cistern, which may be a tub or zinc-lined box, in the absence of the proper galvanized cistern. This must be situated somewhat higher than the jet forming the fountain is supposed to play. For you can see this is only an application of the principle that "all liquids maintain their level." If therefore your cistern is 8 feet above the floor of your greenhouse, the fountain issuing from it will tend to rise to the same height. It will not, however, reach quite the same height, but be somewhat lower, owing to the pressure of the air the jet of water will meet with in its struggle to rise. The smoother the pipe through which the water has to flow the higher will the water rise. On the

same principle a fountain may be contrived in a room. The cistern may be outside, and the tube from it brought in, under or between the floors. The basin into which it plays must have a waste-pipe, so that when a certain level is reached, the rest of the water may run away. A little ingenuity on your part will provide all these things successfully.

A miniature waterfall may be contrived on the same principles; but instead of a jet, the water must flow into a shallow trough, which can be made of some strips of slate or glass cemented together. The edge over which the water has to flow must not be quite so deep as the other. Of course a waste-pipe must be provided to carry off the superfluous water, and a channel for the water must be made of some waterproof material, so that the water does not get about everywhere. Fountain jets and devices can be bought at many plumbers, or jets can be made in glass, as mentioned in our chapter where glass-blowing comes in.

In this chapter we have given instructions relative to many things, but we think not too many, and in those we have given are suggestions for many more. We do not purpose going into directions for lathe-work; it would lead us into a wider field than this book aims at, and there are many books which give full directions for this class of work. A few hours spent in a workshop with an instructor will soon give you an insight into turning, which is a very fascinating and beautiful work; and if you have any desire to be a good amateur workman, you will get all the practice you can at the "turning machine."

CHAPTER VIII.

INDOOR WORK (*continued*).

VERY neat, pretty, and artistic work may be done by making plain, simple objects, and working on them a pattern by means of stain in various tints, and afterwards varnishing or polishing the objects.

A PEN-TRAY.

Take a thin slip of wood, from 8 to 10 inches long, and about one-fourth as wide; plane it up as smooth as you can. Now put a slip of wood round the edge

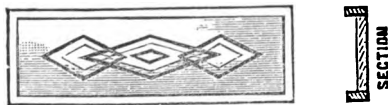

FIG. 75.—Pen-tray.

for a rim, about $\frac{1}{8}$ of an inch wide, and of the same depth. Round off the upper rim. We just remind you this may be put on with glue, or fastened by a few brads coming through from the under side. Smooth down the whole, and rub with fine glass-paper. In the centre put such a device as given in Fig. 75. This is done by cutting the pattern out

in a sheet of stiff brown paper or cardboard—the pattern being the portion removed—then rubbing through the pattern the brown stain we have already introduced. Lift off the the pattern carefully, and allow the stain to dry. Then varnish it. The pattern, if used carefully, will do for several other objects where the same device is required. This means of reproducing patterns, which are called stencillings, is a very useful one, and, as you will see, admits of a very wide application. You can buy patterns for larger work cut in zinc.

Instead of using the stain, you can substitute Aspinall's enamel; several colours are useful for this purpose.

A PAPER-KNIFE.

Take for this a nice slip of cedar wood, or white pine, suppose we say 9 inches long and 1



FIG. 76.—Paper-knife.

inch wide, about the thickness of the wood in the cigar-boxes mentioned—in fact a slip taken from the lid of one will do for the purpose. Divide the length into three parts—one-third for the handle, two-thirds for the blade. Mark it off as shown in Fig. 76. Work down the blade to a sharp edge on both sides, also at the point, leaving the centre of the blade as thick as the handle. Now with stain produce a little pattern on both sides of the handle in the manner recommended. Allow it to dry, then varnish or polish it.

A BOOK-SLIDE.

Cut two ends from pieces of $\frac{3}{8}$ inch stuff, about 5 inches wide and 6 inches high. Trace on one of the pieces the shape you intend these ends to have. Suppose it is like that in Fig. 77. Then place the two pieces exactly over each other, and screw them into the vice, and saw round the figure drawn. For this purpose you require a frame-saw, one we have not previously mentioned; its construction, however, explains itself, being merely a fine saw

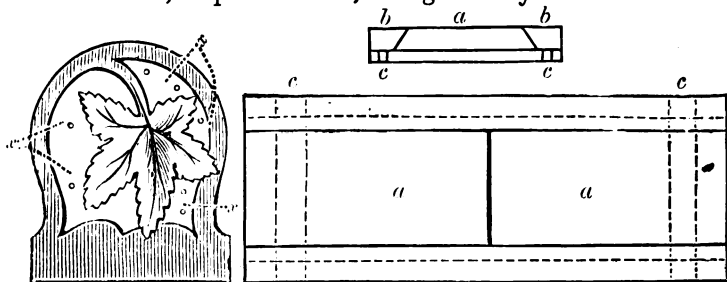

FIG. 77.—Parts of Book-slide.

blade stretched in a wooden frame. With a large gimlet bore two holes, marked x in Fig. 77, and a third or a fourth between them till it is large enough to admit the blade of the frame-saw. Repeat this process and cut the shape of the leaf. Smooth the outer edge up with a file, rounding off so that the knife-edge is on the inner side, then rub down well with glass-paper. Work up this design of a leaf by filling in the pattern with dark stain. If you use ivy leaves, trace in the veins afterwards with camel's-hair pencil, using a darker stain. Then let the whole get quite dry.

Now the slide part has to be made: this is by no means difficult. Take a piece of wood, $\frac{1}{2}$ an inch thick, 14 inches long, and $3\frac{1}{2}$ inches wide. Mark a straight line, $\frac{1}{4}$ of an inch from the edge, all along each side; then with a plane slant off the edge, from the drawn line to the outer edge, then endwise the slab will appear as in section *a*, Fig. 77. Now take two slips an inch wide, and of the same thickness; bevel off the inner edge of each, so that when turned over, each edge of the slip fits the face of the feathered edge of piece *a*. Lay them in the position shown in *b*, Fig. 77; and if they require thinning or smoothing, do it now with the smoothing-plane. Now fit two cross-pieces with short screws to the outer slips, so that the inner piece will slip easily between them, but not loosely. Having fixed this carefully, saw the inner slip into two equal lengths. Cut them carefully so that very little smoothing is afterwards needed; then across the inner ends screw two short pieces, to prevent them from being drawn out at the ends. These we show at *c*, Fig. 77. At the outer ends put two similar pieces, so that the whole is blocked up to the same level. Having finished the slide, get a pair of small brass hinges for each end, and screw them on to the inner lower edge of the slide itself. Polish or varnish it, and you have a strong book-slide, to carry fifteen or twenty books, and no mean ornament to your library-table.

STANDS FOR FLOWER-POTS.

A very simple yet useful stand may be formed from slips of wood $\frac{1}{4}$ inch thick, from 6 to 8

inches long, and $2\frac{1}{2}$ to 3 inches wide, mounted on blocks at each end, as in Fig. 78. The blocks must be nailed. Glue is not serviceable for this purpose, because they are liable to get damp, then the glue would give way.

TO MAKE TRAYS.

For this purpose you must be careful in selecting your wood. It should be as wide as the required tray without joining. Plane it up very smooth, and put a rim round made by slips of wood standing about $\frac{1}{4}$ inch above the surface. A device may ornament

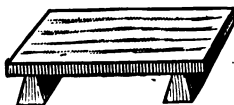

FIG. 78.—Flower-pot Stand.

the centre, and smaller ones at the corners if you think fit. These devices can be patterned as we have already mentioned, in stains of various shades or left plain for somebody else to exercise their artistic tastes upon, in various colours.

TO MAKE BRACKETS.

Corner brackets are variously made. Some are merely pieces of wood cut as a shelf to fit a corner, with or without more support than nails driven into the wall, or lugs screwed to the shelf, and nails driven through the holes prepared, into the wall; or they may be made very ornamental and tasteful, according to the skill and patience of the workman. Suppose we want a plain bracket. Take a piece of

$\frac{1}{2}$ inch white pine; cut two sides at right angles; let the sides be from 6 inches to 8 inches deep according to size you require. This must be regulated by the corner you have to fill, or the object you have to put on the bracket. Now describe a part of a circle in the wood, by opening the compasses on a rule to as many inches as you want the depth of your bracket to be. Carpenter's compasses are best for this sort of thing; they differing by being heavier and stronger than those you use for your geometrical drawing. They also have a tongue fixed to one leg,

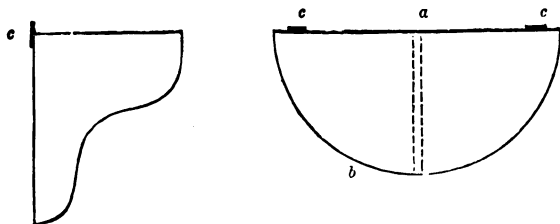

FIG. 79.—Sides and top of Bracket.

which passes through a slit in the other, and a screw, so that a given distance can be taken and kept secure for any length of time. Of course you can do without them, for you can draw your figure out on a sheet of paper, cutting it to size and shape, from which you can afterwards mark out the wood. Now draw out the upright piece for the central support, as in *a*, Fig. 79, where the various portions are shown. The support can be fixed to the shelf (*b*) by screws or brads; or if the shelf is large and heavy, by French nails. You can stain and varnish; or before doing so, put a pattern on both

sides of the upright and under part of the shelf, according to the instructions already given.

Sometimes brackets are made with two upright pieces, to go flush with the wall and the shelf at the top. In this case you must cut two pieces instead of one; both can be cut together by being held in a

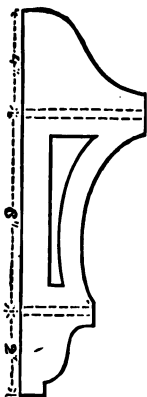

FIG. 80.—Open Bracket for two shelves.

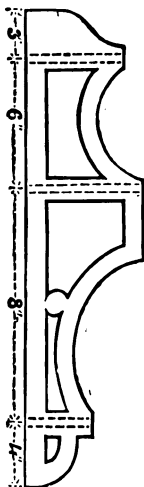

FIG. 81.—Open Bracket for three shelves.

vice, as we have already mentioned. The methods of hanging the brackets to the wall is generally done by screwing small iron or brass plates called "lugs," *c*, to the upper part, and through holes in these nails are driven to hold them to the wall.

Sometimes it is desired to have a bracket of more than one shelf. We give a design for one of two shelves, and of one for three. The designs for such things are numerous, so that we need only give one

of each to show the principle on which they are made. With your skill in drawing and planning, and the knowledge you have now gained of manual work, you can design and fit up according to your own taste as many as you require. An ornamental bracket is a nice object for a present, if you wish to make one, or a pair for this purpose. Put your very best work into it. Only give presents of your very best.

In Fig. 80 we have supposed that the uprights should be of open work; they look lighter, and give you an opportunity of designing something light and strong. You must never allow your design to interfere with strength. In Fig. 80 you have a bracket with two shelves, and Fig. 81 with three shelves, and each with two uprights in open work, which should be made from slabs of wood about $\frac{1}{2}$ an inch thick; and if of deal they can be stained and varnished in imitation of any hard wood. These patterns admit of being made into sets of hanging-shelves as well as corner brackets. In both these, if made to go flat to the wall, a looking-glass may form the back between the two lower shelves.

HANGING-SHELVES.

With plain or ornamental sides, you see how easy it is to make a set of shallow shelves suitable for holding geological specimens, or shells, or samples of bric-a-brac. The strength in each case must correspond to the weight it is expected to support.

Light shelves of this description are frequently

made to stand on the top of cabinets, and for this purpose they should be made a little ornamental; the sides being wider below, and also the shelves. From what we have already said, we think you can design and make a set to suit almost any purpose.

ARTISTIC TREATMENT OF WOODWORK.

In the method of ornamenting wood-work already given, you have durability with simplicity. With a little skill and care, another method can be adopted, and will help you to ornament brackets, panels, picture-frames, and the covers of blotting-books, which may be made in thin slabs of wood having the edges rounded off.

To take a pattern from a fern-leaf, first cover the wood with the stain made according to the directions already given, then press the fern-leaf carefully down upon it, the face of the leaf downwards; work it down close with the fingers so that every part of the leaf comes in contact. After a minute or so, carefully lift off the leaf; you will then have the full impression of the leaf, with its principal veins. The veins, being the hollow of the leaf, will not touch the wood, consequently all the stain will be left there. Should the pattern require any touching up afterwards, that is easily managed. If carried out properly, this is an effective way of performing "nature's printing." After the stain is quite dry it can be varnished, and then there will be no fear of smudging the pattern. Very pretty arrangements and designs can be carried out by this method, for any pattern cut out in paper or cardboard can be treated as the

fern-leaf; also any design and floral devices, and almost as effectively as if the leaves themselves were actually photographed.

The other method that is equally durable is to trace any design in pencil, then with one colour or more, it can be traced on the wood. Suitable boxes of colours are sold for this purpose at a cheap rate. Many of the free-hand drawing copies that are in use in our schools just now, offer good examples for this kind of work.

WOOD CARVING.

Every boy has done a bit of wood carving, but probably it has been with his knife. He never pays a visit to a strange place but he must cut his initials into a tree, or a door, or post; and our public school desks bear evidence of a good deal of industry in this respect. With a good knife you can do very much, but you cannot do all, though we sometimes see specimens of wonderful work done with a "pen-knife only." If, however, you can get more suitable tools to help you, you are quite justified in doing so. You will be able to do your work quicker and better. We do not give a list of all the tools wanted for carrying out this work very successfully, for you may probably have to be content with less than "a set."

You must, however, have one or two narrow chisels, and one or two gouges of different sizes. Take the advice of somebody who knows about tools, when you are buying, because although use is the best test of quality, an experienced worker has more judgment of a good and suitable tool than you will

yourself have. Carving tools if too long are awkward to handle, yet if you have them too short you cannot get a nice graceful curve. Again, they should have no bends or uneven thickness in their shafts, or when they get a smart blow from a mallet, they are likely to snap off; the edge too of a badly tempered tool will snap off if it comes across the grain of a piece of hard wood. A person of experience is a good judge of the temper of steel by its colour. By use of the tools you will soon get to understand both their qualities and merits.

In addition to chisels you must have a mallet, for although the blow of the hand is frequently enough for the chisel, yet for deeper cuts a mallet is required.

Now for a few remarks about the wood. All woods for carving should be dry, but not too old, or it will be brittle; it should also be free from knots; and do not take sap-wood. Pear-wood is a nice soft wood to work in, also lime; these woods may afterwards be stained to look like a hard wood. Walnut and plane are good, but for large surfaces nothing is so good as oak. If you have any very delicate design to carry out, boxwood, ebony, or some closely grained wood must be used. Take some simple pattern for your first work—the handle of a paper-knife, or the end of a book-slide, such as described in the earlier part of this chapter. Select your design, or make one for yourself. Suppose you take the end of the book-slide, take such a pattern as that in Fig. 82, in which you have a leaf. Vine or ivy, whichever you think best. You can get a natural leaf, or twine two together; place them on a sheet of paper, trace the outline by running a pencil round the leaves, then

fill them in with veins. Now get the end of book-slide cut out; rub its upper surface with whiting or chalk. Then take a piece of white paper large enough to cover it; rub one side with charcoal; place this next the chalked side. Then place over it the design you wish to carve, and with a sharp point such as a long French nail, or skewer, trace the outline, bearing hard on it as you go along. When completed lift off your design and black paper, and you will find the outline on the chalked surface of the wood. Now

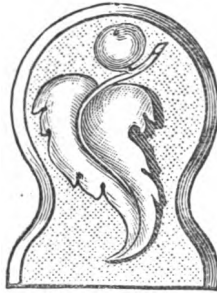

FIG. 82.

with a soft dark pencil outline it again; your drawing on the wood will then remain as a guide for you. We have frequently visited classes where the most beautiful carving was being done, yet the pupils were not able to draw. The difficulty was overcome by the teacher supplying the designs already done on paper.

Designs are sold bound up in books, and what is called "carbon paper" for transferring the designs is also sold with them. The method, however, we have mentioned answers quite well. To take mouldings or any special shapes, you had better cut them

in cardboard; then trace them out on the wood. Now fix the wood on which you have drawn the pattern on the bench ready for working. Then take a chisel of suitable size; hold it upright and very firmly in your left hand, and strike the head of the handle with your right hand; or if the cut is to be deep, use a mallet. Go round the whole design like that, till you get the outline; then with a gouge or chisel, take out the wood between the edges of the leaf and rim of the outer border down to one sunken level. Then with a small chisel take off the outer rim, reducing the wood to same level. Then with a larger gouge round off the edges of the outer rim. Then commence on the leaves, beginning at the thickest part of the central vein, lifting out the deeper parts, rounding them up to the more raised parts. Then take the smaller sections of the leaves, beginning at the deeper part of the veins that branch off from the central vein, scooping out the hollow parts with small gouges. Keep the natural leaf in front of you, and imitate it as nearly as you can.

Alter the direction of your tool, and the manner of working; cut away only small parts at a time, till by patience and work you bring out not only the right shape in outline, but in surface. Trace a diaper pattern on the end of the bookslide, this you may find easier to carve than Fig. 82. Then try the handle of a paper-knife—such an one as we mentioned at the beginning of the chapter. Work round the rim of the handle first, then raise a boss in the centre, with two small ones above and below; the roughened groundwork (as in Fig. 83) may be produced with a broken bradawl.

Suppose you have an oak panel, or end of book-slide (Fig. 84), you proceed much in the same way. Secure your pattern, transfer it, then make your outline by cutting round the pattern to the depth of about $\frac{1}{16}$ th of an inch, then "blocking out"—*i. e.* taking away all the superfluous wood, then finishing the details of work step by step. You may find some



FIG. 83.—Handle of
Paper-knife.



FIG. 84.—Carved end of
Book-slide.

assistance from the file before using glass-paper to take off some of the more prominent edges.

You may easily find some suitable designs for brackets, tops of boxes, panels for cupboards, and frames for small pictures and looking-glasses.

In doing a frame from a solid piece of wood you must be careful in your selection of wood. Place it flat on the bench, and mark the outside and inside dimensions. Then proceed to cut it out; cut the outside first. To cut away the inside, you must bore a hole large enough to get the saw in, and then

take out the wood, not quite close to the inside line, but leave a little margin for any trimming off. We append one or two designs for such frames (Figs. 85, 86); in regard to the carving, do not cut it down more than about $\frac{1}{8}$ th of an inch. It will be a great help, if you are interested in this class of work, to study a few good specimens, which you are sure to see in some good furniture shops of the present day; the more elaborate of course you can see in museums. If any of you have a chance, go to South



FIG. 85.—Design for carved Frame.

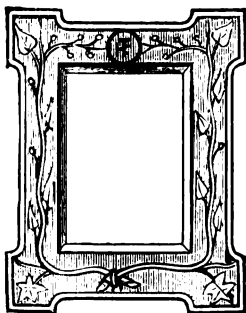

FIG. 86.—Design for carved Frame.

Kensington Museum; you will see some of the very finest specimens.

You will have to keep a very good edge on your tools for carving work. This will require some care. It is only the thicker edge of the tool that can be taken off with the grindstone; this you should use with water on it, so that the tool does not get hot. The finer edges are obtained by rubbing them on slips of oilstone, which will gradually rub down and fit the inner edges of the tools. You commence with

the coarser kind, and finish with the finer. Last of all, strop the edges on a strip of buff leather saturated with tallow, and a preparation from tin, called "crocus powder." The oil preferred is ordinary machine oil mixed with petroleum.

INLAID PATTERNS.

You can manage the inlaying of simple geometrical patterns, and find it even easier than carving. First,

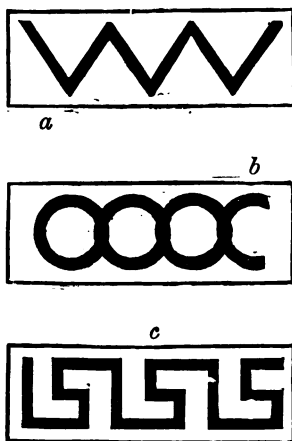

FIG. 87.—Simple inlaid patterns, *a*, *b*, *c*.

the patterns must be cut out into a hollow, not more however than from $\frac{1}{16}$ th to $\frac{1}{8}$ th of an inch. Cut it out holding the chisel upright in your left hand, then use force with the right hand. Having cut out the pattern, clear away the wood, and keep the hollow a uniform level. Then cut strips of darker wood, of the exact width, to fill up these hollows. Put

them in, using very thin glue for the purpose, and when quite dry rub down smooth with glass-paper. This kind of work is suitable for trays, small tables, tops of bracket-shelves, and ornamental objects. You can derive hints from a few designs we give in Fig. 87, *a*, *b*, *c*. A pretty effect is produced by using wood of two or three tints, if you take care to blend them nicely. For other designs and uses we leave to suggest themselves to you. Woods used for carving or inlaid work is sometimes better for being dyed or stained; but with oak and some of the hard woods this is not required, nor is it necessary to varnish either; rubbed up quite smooth, and good rubbing in of linseed-oil is the best thing for it. Ebony, black walnut, and red cedar are good woods for inlaying.

FRETWORK.

This is a very pretty and useful kind of ornamental work, and it is frequently combined with carving, as in the bracket Fig. 88. The tools for fretwork specially are not many, nor are they expensive. Cedar, mahogany, and white holly are good woods for this work; they all saw easily. Wood can be bought specially prepared for fret-cutting, made up of different layers glued together, the grain of each layer going in a different direction to prevent splitting. Having got your wood, the next thing is the design, which must be according to the object you have in hand. This class of work admits of a large and very varied application. It can be used for panels, sides and backs of brackets, reading- and music-desks, rims round the upper or lower edges

of shelves, cabinets, frames for photographs and small pictures, and rims for card-trays and other ornaments.

Draw a design of your work on thin paper; paste it on to the wood, or transfer it by the method we mentioned in the directions for carving. The various holes must be bored or drilled—the latter is preferable—through which you can pass the saw. Next put the wood into a clamp that will hold it steady while it is being cut. There is a great variety of fretwork

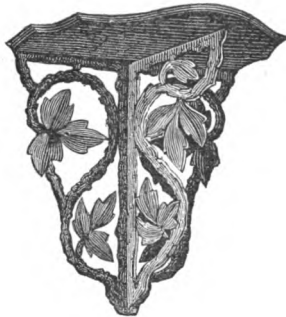

FIG. 88.—Carved Fretwork Bracket.

saws, so that we must leave you to select according to the money you have at your disposal, for sets can be had at 1s. 6d., while some go up to £5 or £6. We will, however, suppose that you are working with an ordinary saw, having a metal bow something like the letter P, the saw stretching across the bowed end of the letter. You unscrew one end of the saw, pass it through the hole bored for it, screw it up again, then commence sawing. Hold it to your pattern, make short gentle strokes, keep it at right angles to your wood, then you will get your work clean and

accurate, and very little cleaning up will afterwards be required. Having got through one portion, the saw must be again unscrewed, taken out, put into another part of the work, screwed up, and so on till the whole is completed. Never use a design that omits to leave strong enough portions between its parts to hold the whole together. Where a large panel has to be cut, it frequently must be done in parts; then comes the difficulty of putting it together accurately. This is best done by putting the whole together on a duplicate of the original pattern. In putting a frame round it, see that no parts get shifted. In fitting up a bracket on fretwork supports, it will be better to use wood of not less than $\frac{1}{4}$ inch in thickness.

In fitting frames to hold fretwork together, you will have to use the mitre-box and board, as recommended in picture-frame making. In putting them together with glue, do not be too impatient to move them, for till the joints get perfectly dry they are easily misplaced, and will give more trouble to replace than they did to put together for the first time.

In all the work given in this chapter, your success depends very much on your taking pains, and this can only be done by your being patient. This especially applies to your carving. Do not scoop out too large pieces of wood at one time, but get your design into form very gradually, and you will be repaid for all your patience.

CHAPTER IX.

HOW TO MAKE PICTURE-FRAMES.

THIS is a lighter kind of work, but requires great care and neatness in cutting your wood, so that the corners of the frame fit well; and you must have some practice at this on ordinary plain wood before you cut up any good mouldings.

Mouldings of all the best patterns can be bought cheaply at so much per foot; and the kind of moulding you get must be determined by the kind of picture you are going to frame.

Frame-making is interesting work, and we are sure you will like it, and to make a good frame is a very creditable piece of work.

No more tools are necessary than those you have already. You must, however, make a mitre-box or board, and a "shooting"-board, for only by use of these will you get your frames square at the corners.

The mitre-box or board is simply an arrangement for guiding the saw, so that you can accurately cut off a piece of wood at an angle of 45° , and when two such pieces are brought together they make

an angle of 90° , a right or square angle. Take a small picture-frame for a guide. You will see the pieces forming the corners are each cut at 45° ; this is called "mitring," and when the two sides are brought together and joined, it is said to be "mitred."

The mitre-box consists of a shallow trough, having parallel sides, as in Fig. 89, in which *a* shows the plan and *c* the end, made of stout planking, 1 inch or $1\frac{1}{2}$ inches thick, about 15 inches long, 6 inches wide, and 3 inches deep. Next draw a line across the two top edges of the sides, making an angle of 45° with the side of the box; continue the line down

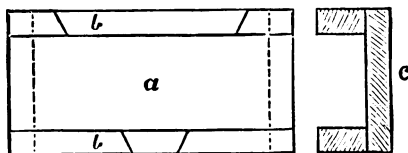

FIG. 89.—Plan of Mitre-box.

a. Flat board; *b.* sides with cuts at angle of 45° ;
c. end plan of mitre-box.

the sides, then make a clean cut with a tenon-saw across the box down the two sides as far as the bottom of the box. Make two such cuts as these facing both ends of the box; this saves the trouble of moving round the box during its use.

A mitre-board is made by taking a stout board about 15 inches long, and 8 or 9 inches wide, nailing a strong piece along the first edge, projecting downwards about $1\frac{1}{2}$ inches to 2 inches, to hold it flush with the edge of your table or work-bench. Then along the further edge nail a slab of wood about 2 inches thick, so that it occupies the position of *b*

in Fig. 90, where a represents the slab in which the saw-cuts $b\ b$ are made, and c one of the supports, and d represents the end of the same. Through this make saw-cuts, right- and left-handed, at an angle of 45° , and extending into the slab at the foot. Now in using either of these, the box or the board, you see if you hold firmly a piece of wood close to one side or the other while the end is being sawn, when cut the end will have an angle of 45° ; and if this is cut in the left-handed cut, its end will exactly fit a piece cut in the right-handed slit. Now try it. Take two slips of wood, smoothed up, and cut the

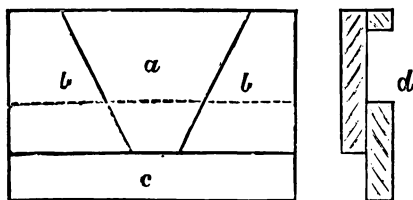

FIG. 90.—Mitre-board in plan and section.

ends by using the mitre-board or box; bring a left-handed end to a right-handed piece, and if you have made your cuts carefully, they will come end to end, and thus form a right angle. Test it by drawing a right angle on a sheet of paper, and put down your pieces end to end, and see if they are right.

Now make the shooting-board—*i. e.* one to be used with no more formidable a weapon than a shooting-plane, or your jack-plane. This is easier managed than the mitre-box.

You must have two flat pieces of wood—they should be hard wood—about 18 inches long; one of 12 inches

and the other of 6 inches wide. The edge of the larger slab must be screwed on to the narrower piece, and about 2 inches over its edge. Let them be so screwed that their edges are parallel. Now under the edge of the wider slab, a second piece of wood of the same thickness as the narrower, but from $1\frac{1}{2}$ to 2 inches wide, must be screwed, so that this edge is blocked up to the level of the other.

Fig. 91 shows a plan of this shooting-board with the method of using the plane.

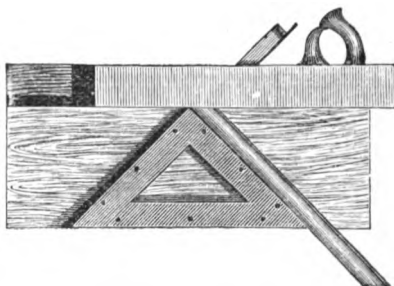

FIG. 91.—Shooting-board.

Now two other stout pieces of hard wood, about $1\frac{1}{2}$ inches wide and 1 inch thick, are to be carefully planed up, and nailed, or better screwed, to the upper slab, so that they make an angle of 90° , and come up flush with the edge of the board, while on the slip the shooting-plane is to travel. When in use, the slip of wood or moulding to be mitred is to be held tightly to one of the guide-pieces forming the sides of the angle, and the plane "shot" along the edge. The end will then be smoothed off accurately to 45° . It is similar to the mitre-board

in its construction, except that the triangle is screwed to the upper surface, as shown in the figure.

Planing the mitre off true and smooth is called "shooting." The jack-plane, and not the smoothing-plane, will suit you best for this work, as in Fig. 91. You must hold it firmly, so that by no means the edge of the guide-piece is cut.

Having got these two appliances, try and use them by following out the directions we now give, which will apply to an ordinary plain wooden frame, as an experiment; and if you succeed well with this, then you can get a supply of moulding for better work. Take a lath of ordinary wood, long enough to make a frame 9 inches by 7 inches, say $\frac{3}{4}$ inch wide and $\frac{1}{2}$ inch thick. First cut off two lengths, $9\frac{1}{8}$ inches long, and two lengths $7\frac{1}{8}$ inches long; these are for the four sides, and the $\frac{1}{8}$ inch over is for material that will probably be taken up in fitting the corners. Take each piece separately, in the mitre-box or on the mitre-board, and cut the ends at the angle of 45° ; although cut with a fine saw, the ends will be rather rough. They must next, therefore, be operated on at the mitreing board, that the ends may be "shot." The plane must be very sharp for this operation to avoid splitting or tearing the wood. If you have succeeded in these operations, you will find the ends to fit exceedingly well; try them by laying them in their proper positions on the bench or table. Test the angles, and do not attempt to go any further unless they give you four right angles. If you have to go through the process again, or even a third time, do so, rather than be content

with bad work. You know the old adage, "practice makes perfect."

Having succeeded thus far, the pieces must be put together. For this purpose be very careful to have your glue clear and thin. While this is preparing, fix one of the long lengths into your vice, covering over the jaws some thick cardboard, or a slab of wood, so that the frame is not marked. Now in your left hand hold one of the short pieces; bring the edge in contact with that to which it is to be glued. You can best do this by having the inner edge of the long side away from you in the vice. When the ends are in contact, bore a hole with a small bradawl, through the angle of the short end into the end of that in the vice. Place an inch brad in the end of the short piece ready for striking into position; now smear over one end a thin layer of glue, and bring the ends together, tapping the brad till it is driven home. Do this carefully, so that the ends come together exactly in the required position. You will now have an L piece; lift it carefully out of the vice, and lay it aside to dry. Join together the other two pieces in the same way, and let that joint dry. Then join together the two L pieces, and you will have the frame, the corners of which should be right angles. It is better to fit one L piece in the vice while fitting the other to it. Let the glue be quite hot, and perform the operation as quickly as possible.

Another plan sometimes adopted for joining up frames, is to have four corner-blocks made, which you can do for yourselves, by taking some 2-inch pieces, of 4 inches long, joining them by the half-lap joint,

taking care that each piece forms a right angle. With four such pieces as these, you can, after putting glue on to the ends of the frame, squeeze them together by means of the blocks, binding them with twine, and tightening these by thrusting pieces of wood between the string and the frame, and keeping the whole in this condition till quite dry. You may perhaps find this a simpler method, and we believe that sets of blocks can be bought for the purpose, such as shown in Fig. 92, as can also the mitre-box

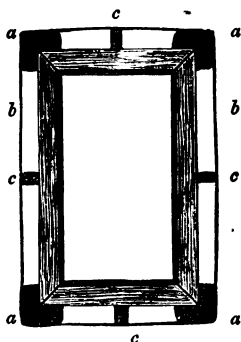

FIG. 92.—Blocks for Picture-frame fixing.
a. Blocks; *b.* string; *c.* tightening wedges.

and “shooting”-board, if you prefer buying them to making them for yourselves. We will suppose now you have succeeded with the plain frame, for which we gave instructions, you will now like to try your skill at a regular frame. The mouldings sold are of different widths as well as of different material. You have the gilt, oak, walnut, and maple among the commonest. Just at this time, the oak, with a narrow gilt moulding, is the favourite.

Suppose you are going to cut off some for your

frame. You must first mark it off, remembering that "right" size is the inner measurement of the frame, and the rebate size is the size of the part into which the glass fits. You will do well to refer to Fig. 93. Take the length, $\frac{1}{8}$ inch more than is needed, for the reason we have already mentioned. Cut it off in the mitre-box; take care you hold it tightly. That will give you your first mitre, which we will suppose you cut in the left-handed slit. Now

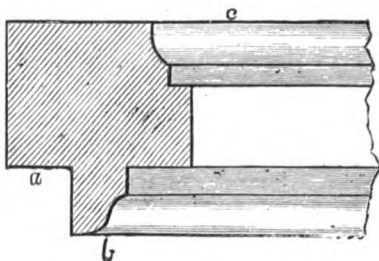

FIG. 93.—Moulding used for Frame.

a. is called the rebate; *b.* the sight edge; *c.* the back or outside edge.

cut the next in the right-handed slit, and proceed step by step as has been already described.

Remember, accuracy is only secured by care.

Having completed the frame, the next thing is to get a glass. Be careful and select a clear piece, and have it cut slightly smaller than the rebate size, so that you have no trouble fitting it in. Polish it well on both sides, so that no stain or grease is on the surface; then if the picture is mounted on card, put it next the glass. We suppose the mounting has been done to leave an effective margin, that it has been properly cleaned, and has been set out to advantage; this requires a little care and skill. If

the picture is on canvas it must be stretched on a frame. To make such a frame, take some $\frac{1}{2}$ inch stuff, soft wood, about 2 inches wide; make a frame, the outside of which should fit the inside of your picture-frame. Use the half-lap joint for the corners of such a frame, and put them together with screws. To mount the canvas, lay it flat on its face, and then put the frame over it, turn back the edges of the canvas and tack them with small black tacks all round, stretching it evenly as you go along. It is better to begin with the two ends of the canvas. If the picture is on paper it is also better for being mounted on a frame. In this case lay it flat on the table, face downwards, slightly damp the back, and let it have a little time; then turn the edges back; cut the corners so that no puckering arises from overlapping. Then glue the edges of the frame, to which press the edges of the paper, rubbing them back with a piece of something smooth, like a pencil or a paper-knife. In drying, the picture will contract and fit the frame tightly. When dry, put it into the outer frame. Before finally fixing it, turn it round to have a look, and satisfy yourself that it is put in to the best advantage; then cover with a sheet of paper, and put in the back. This must be made with thin wood, sold for the purpose. Cut the slips off the proper length, and let them come close together side by side. Hold them in position by knocking in a few brads at intervals. When fully filled in, it will not be dust-proof. To secure this you must paste strips of brown paper over the part where the portions of the back come together, and also round the inner edge of the frame; or better

still, cover the whole back with a sheet of good brown paper.

When dry, put in the screw-rings at the two sides of the back if the picture must hang slanting from the wall, or at the top if it is to hang flat to the wall.

If you have succeeded well, you will be glad to try your skill again at picture-framing.

In making the Oxford cross frame, you had better examine how it is cut and put together before starting on your work, and you will be able to manage it without further directions from us. Notice also how the edges are bevelled off, to give them a lighter appearance.

We have seen some very pretty frames made in the same fashion as the Oxford, but broader, and decorated with patterns of leaves, put on as directed for the ornamenting of wood-work in our last chapter. They are very strong, durable, and wear well. We have one before us at this time; it is fifteen years old, and looks as well as when first made.

So much depends on taste, that you may design several modes of decorating frames that do not suggest themselves to us.

HOW TO BIND BOOKS AND MUSIC.

We are not going to make bookbinders of you; but it is useful to be able to put magazine numbers together, and music; and we think a few plain directions are not out of place in this book, and also that most of our amateur workers will be glad of these directions.

First, we will take a bundle of music. Say you have twenty pieces; you want them to form one volume. You must remember that it is important that a music-book should when open lay flat, so that in your sewing, the threads must be so arranged that nothing hinders their opening out easily and lying flat on the table or desk. We have some volumes now in use that we bound together more than twenty years ago, and they have been in constant use, and are still in a very fair condition. First mend all the sheets that are torn, using thin white paper and paste; if any notes of music have to be covered use transparent tracing-paper. Clean every piece with indiarubber, and carefully smooth out all the leaves.

Treat each piece in the same way; then place them in the order in which you wish to bind them.

Now get two stout boards, somewhat larger than your numbers to be bound—two drawing-boards will do, for they want to be nicely flat, without any tendency to warping. Get some wide strong tape; cut off three pieces, each about 6 inches long. The numbers have to be sewn to these pieces. The best way to do it is to tack the pieces of tape to the lower board, at such distances that when one piece is in the centre, the others are tacked so that they will be about 2 inches from top and bottom.

Such an arrangement we show in Fig. 94, where the board is shown at *a*; the tapes 1, 2, 3, and the numbers sewn in at *b*; and *c*, the upper board when all the sewing is done. This can be weighted, and thus the papers will be pressed close together. The sewing is done by strong gray thread stitched

through the middle of each number to hold them all together; then carry it outside, round the tape, into the number, out at the second tape; in again; and so with the third tape. Draw them up tightly, but not so as to crumple any part of the paper, beginning at the lowest number. Having stitched the first as directed, place carefully the next above it. Carry the thread through it, and round each of the tapes in the same manner, and so on till you have stitched together the twenty you require for one volume. Then cover over them the second board,

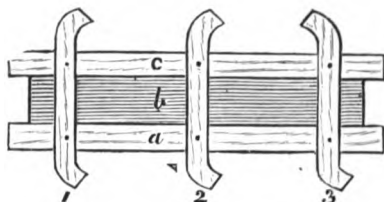

FIG. 94.—Bookbinding.

a. Lower board; *b.* pieces to be bound; *c.* the upper board.

bringing it up flush with the back edges and the lowest board. Bring them all up, nice and level, then put some weights on the upper board, then the backs can be dealt with almost like a solid. Now get ready some nice thin glue; a strip of calico, just long enough to come an inch beyond the paper; get the ends of the paper free. Now put on a good coating of glue, not thick, but so that the whole back is covered—thread, tapes, and paper; then put on the strip of calico, so that it comes a little beyond the top and bottom; rub the calico well down so that it gets hold of every part of it. Now turn the projecting pieces of calico back, so that they are flush

with top and bottom; there will be enough glue oozed through to hold these parts down. Leave this to dry. You will then have the numbers all bound together and attached to a piece of calico, with a good margin on both sides; by these the book is attached to the covers. When dry take it from between the boards, put in a fly-sheet at the back and front of the book; let this be double, then you will have one loose and one to paste down inside the cover. Before going further you want the edges cut off level. This is a matter you cannot manage for yourself, for you have not a press, nor the proper knife.¹ You can, however, have it done for a few pence at a bookbinder's. For covers get two pieces of pasteboard if you want stiff covers; brown paper or cloth if you require limp covers. Cut the covers the proper size. Be sure and have them square at the corners; then smear some glue over the ends of the tapes and margin of calico, after having neatly folded them down inside. Then put on the covers; they will be firmly held all along the edge. Now let them dry. You must next provide a back of cloth or leather, which must not only cover the back, but about an inch on both covers. This must be stretched over the back, and pasted down on the pasteboard covers. Cut it somewhat of the shape of Fig. 95, *d*; the parts *e, e* are to be turned back and glued together to form the top and bottom of the back. A piece of the same

¹ Since writing the above we have seen small but complete sets of tools for amateur book-binding, so that any one having such a set could perform the process here mentioned for himself.

material is then cut and pasted over the corners of the covers. When these are quite dry, put some marble paper on the outsides of the covers, leaving an inch margin on both sides at the back, and cut off at angle to show the leather at the corners (Fig. 95, *f*). Fold it carefully over, and smooth it down inside the cover. When all this is done, paste down to the cover the outside fly-sheet; this hides all the odd pieces that have been turned down. Be careful to

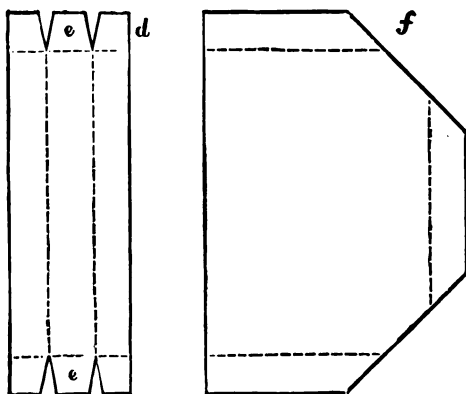

FIG. 95.

leave no odd bits of paste about inside, or that will be awkward. Now put it between the boards, and weight it so that it dries under pressure; and if you have carefully carried out our instructions, you will have a very respectable specimen of bookbinding. A piece of bookbinding can be carried on with other work, because of the intervals that it has to be left for drying; for it is always better to have it thoroughly dry between each of the stages.

If you want the name or any lettering put on the back, it is better to get a bookbinder to do it for you, because it requires so many special items that you will not have at hand. These instructions will also apply to the making of a scrap-book for drawings, or gleanings from newspapers. Select your paper, fold it, sew it together, and bind it as we have directed.

In making a portfolio for drawings, select first your boards for the covers, the thickness of which is determined by the size required, and you can select millboard of all thicknesses. First cut these exactly the same size, place them parallel side by side, then with a stout piece of calico put them together, regulating the distance between them to the width of back required. It is better to double the calico in this case, so that it hangs firmly to both the insides as well as the outsides of the covers. Now cover the back piece with leather or cloth, also the corners of the boards. You must now punch or bore holes for the strings, which may be of wide tape or stout ribbon; draw them through the holes, and paste the inside ends flat down to the covers. Then cover the outsides with paper or cloth. When this is done and dry, paste a sheet of paper inside each cover—this should be a stout tinted paper—and your portfolio will be finished.

Covers for loose numbers of magazines or weekly journals can be made in this way, and they are especially useful to any one who is fond of keeping his papers neat and methodical. You will not find much trouble in getting cloth, leather, or other material for the purposes described in this book-

binding section; a bookbinder or stationer will be able to supply you. If we have not been sufficiently clear on some points, we must ask you to look at a half-bound volume, and you will see how the parts are put together; and the stitching in a sewn pamphlet will explain how each separate number is attached to the tapes which are to hold the whole together.

CHAPTER X.

HOW TO MAKE MODELS.

WITH some of you who take this book in hand, model-making may be a very favourite kind of work.

For this purpose you will be glad to press into service, wood, cork, cardboard, wire; in fact, all kinds of material. To make your models more useful, they should be made to scale as far as possible. Fix on some standard, which of course need not be the same for all your models, or even a series of models. A model of a plain building is easily made in wood or cardboard. First make a drawing of each part of your building to scale, then transfer the same to a sheet of cardboard; and perhaps if the building is not very complicated it may be all cut in one piece; and then by folding it along certain lines you may form it up into a representation of the building. In order to get the cardboard to fold accurately, take a straight ruler, and draw a pen-knife along the lines which you require to fold, cutting the card half through. If the building is very large, and you require it on a large scale, the better way is to do it in thin wood or thick paste-board. In that case you must cut off each piece,

and not be content with folding. Then put the parts together with glue, taking great care only to put glue where it is needed. Supposing you have the keep of a castle to represent, the battlements can either be drawn and shaded with sepia or umber, or they may be done by glueing together various thicknesses of wood to represent the stone-work.

Windows and doors can be filled in with glass, wood, or iron wire gratings. For producing effectiveness in such a model, so much depends on the skill and inventiveness of the maker. Try and get the thing as real-looking as you can. You can get a fair representation of stone-work by coating the card with thin glue, and before it dries, sprinkle some fine sand on it through a piece of fine muslin, stretched over the barrel part of a large pill-box. We give this size, because you must not have a large quantity to use at one time, or it is likely to go in patches. After you have got a surface of rough sand, you can colour it, so that some parts are darker than others, taking from it the sameness of surface.

Some of you will be able to imitate ruins by colouring carefully; of course in a ruin you must not have anything look prim and stiff, or the appearance of a ruin is gone. There is still another very good covering for a model that is intended to imitate stonework—*i. e.* cork. Get some ordinary bottle corks, cut them into very thin slips, by means of a very sharp pen-knife, and then into the shape of the front of a block of stone. Spread some glue over the surface of the card, and put the slips of shaped cork into their places; and if the whole is properly carried out, it will be very effective.

A model of a stone bridge is a very pretty object, and not at all difficult to manage. First cut the two sides, showing the arches; leave some small pieces of card at the bottom of the arches that can be turned under as feet; glue these to a thin slip of wood, so that the arches are exactly opposite to each other, and at a sufficient distance to represent a roadway. Then put in the tops of the arches by bending cardboard into the proper form. Before fixing it permanently it can be blocked out and painted like stone-work; or the slices of cork can be put on. In this case do not put them quite close together when flat, for remember they have to be bent into an arch. This requires a little skill to manage. Having completed the archway, set about the roadway. This can be done with slips of card glued on the underside of the arch of the bridge. You can cut some figures of men or boys, horses and carts, and put them on the roadway. Such figures can be cut in cork or cardboard, and a cardboard model of a boat with a man in it, going under the bridge. Streak the wood-work forming the bed of the river with some white paint, and cover it with a slip of thin glass to represent the stream; incline the banks with crumpled brown paper, glued and sprinkled with red gravel.

Models of some of our large engineering structures can be made, and afford instruction as well as good tests of skill.

Suppose we take a simple one to begin with, say a model of Plymouth Breakwater. Look up the particulars as to length, breadth at low water, and height, breadth across the top, and breadth at the

surface of low water. You will find it easy to make this out of a piece of solid wood, planed up and bevelled; it can afterwards be painted and the blocks of stone lined in. The lighthouse at one end can be made in cork or wood. Mount it on a board, and paint the board to represent the sea.

Now for the model of a lighthouse. The best for this purpose is perhaps Eddystone. Get particulars

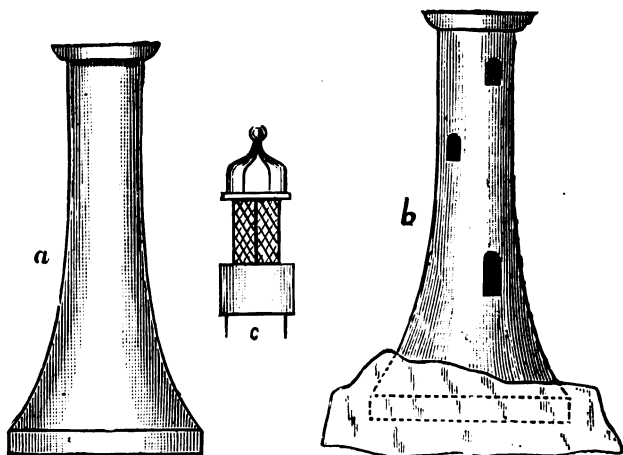

FIG. 96.—Model of Lighthouse.

a. Turned block for shaft; *b.* shaft mounted on rock;
c. lantern of Lighthouse.

of its dimensions from some book on the subject, and get the model of the tower turned for you at some lathe; it will come out like the outline in Fig. 96, *a*. From a drawing, mark out all the doors and windows, giving the relative sizes to each, and also their proper positions. Then with chisel and gouge cut them down not more than $\frac{1}{16}$ th of an inch. Next fit the lantern; do this from a drawing. The roof

of this had better be turned in a lathe. Then cut very neatly the uprights to connect it with the lower part of the lantern. Let each be fixed into its place with glue. When the whole is dry, proceed to glaze it; have the glass cut so that the panes exactly fit, then fix them either with glue or putty. Next get some stout wire, and fasten a rail to run round the gallery at the top of the tower at the base of the lantern. You can work this very neatly with a pair of pliers. Fit each stem of wire into the wood-work by boring holes first with a bradawl. Make the holes somewhat smaller than the wire, and keep them at even distances from each other. With some stouter wire fix up the support for the fog-bell. You can make a small model of the bell in cardboard, or you can get a small metallic bell, which will suit better still. The lantern need not be permanently fixed to the tower; it may be an advantage to have it movable. This you can manage by fixing two pieces of wire in the lower part of the lantern as pins, and boring two holes in the shaft to receive them, as Fig. 96, *c*.

Now you want to construct an imitation rock on which to stand the lighthouse. Glue a rough block of wood to the bottom of the tower, making this as thick as you intend the height of the rock. Then mix some plaster of Paris and sand into a thick paste. Let it stand to get rather stiff, then take a knife and put the cement round the lower part of the wood. Let it stand up in rough block-like pieces, but smoothe it down near to the edge of the shaft, so that it appears as if the shaft is mortised into the rock, as it actually is in the real structure, as in Fig. 96, *b*.

The whole when dry can be coloured to give it the appearance true to the actual building; or it can be covered with fine sand, as we mentioned earlier in the chapter. The windows and doors can be coloured in imitation of those in the building. This makes a very effective model if properly built, and we think you can manage that from a descriptive drawing if you follow out our directions. We made a model of Smeaton's Lighthouse some twenty years ago, on the plan we have described, and it is now in as good a condition as ever. We also made a second model, putting round it the bands of red and white paint, which dis-

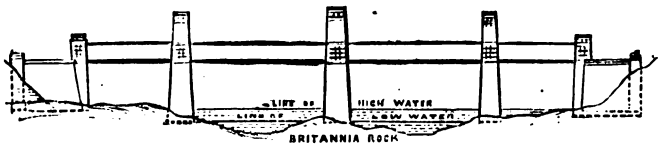

FIG. 97.—Elevation of Bridge.

tinguished the old lighthouse for a good many years before it was taken down. This model we gave to a Fishermen's Institute, and it formed the first of an excellent set of models which has now grown into quite a museum. Many have this year had an excellent opportunity of seeing a good model of the Eddystone Lighthouse at the Naval Exhibition. Towers, monuments, pillars, and objects of interest of this kind can be made up in the same manner as we have described for the lighthouse. A model of a lighthouse takes a good time to finish properly, but it will repay the labour; it is "something attempted, something done," that will give pleasure to others as well as to yourself.

Models of some of our great bridges are interesting for study and building. The Forth Bridge is too elaborate for any description in a book like this; but we think we can give sufficient directions for you to manage the Menai Tubular Bridge.

Get a drawing of this bridge. You of course know

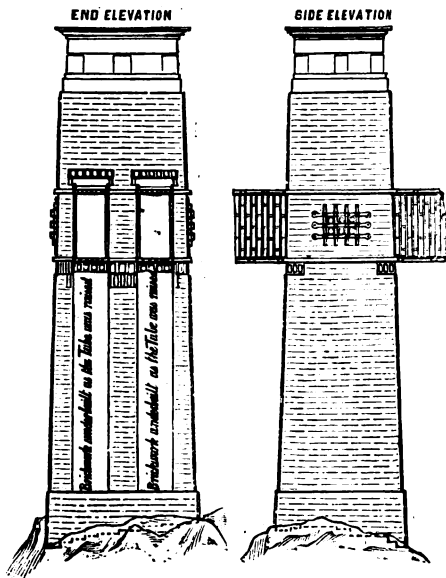

FIG. 98.—Britannia Tower.

that it was built by Robert Stephenson, and was considered one of the wonders of the age; but it has since been eclipsed by the bridge over the St. Lawrence, also built by Stephenson; and to head the list of wonders in bridge-building is the Forth Bridge; and perhaps in the not very remote future, there will be the Channel Bridge, spanning the Straits of Dover.

It would be too intricate to get all the engineering details into your model of the Menai Bridge; but you will be fully repaid by making a model, giving with some degree of exactness, the general appearance of the bridge. Look at its general outline. You

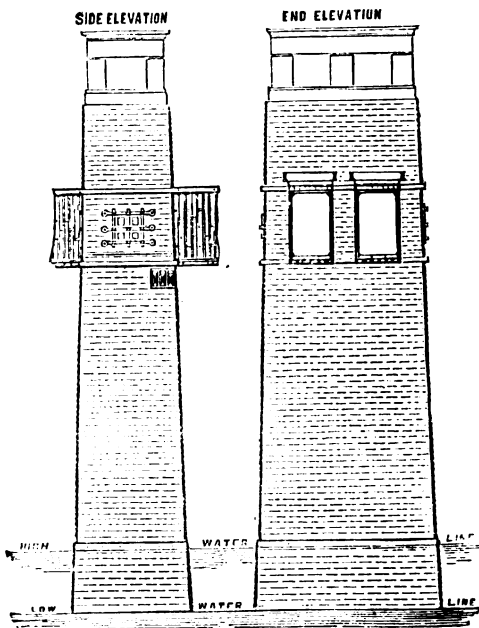

FIG. 98 a.—Land Tower.

see it consists of a pair of iron tubes, through which the trains run, supported by three enormous towers, and at each end by a land abutment. You can get a full description of the bridge in books on engineering, and in separate treatises for 6*d.* or 1*s.* each. The whole length of the bridge from end to end is 1832 feet 8 inches; the height of the central, called

the Britannia, Tower, is 214 feet above the rock in the mid-channel of the Straits; and the land towers, which are after the same pattern as the central, are 202 feet 3 inches, and the tubes for the train-way are 103 feet 9 inches above average high-water mark, or about 125 feet from the bottom of the central tower.

Suppose you decide on making your model 40 inches long. This will represent $\frac{1}{50}$ of an inch to the foot. In taking therefore your working dimen-

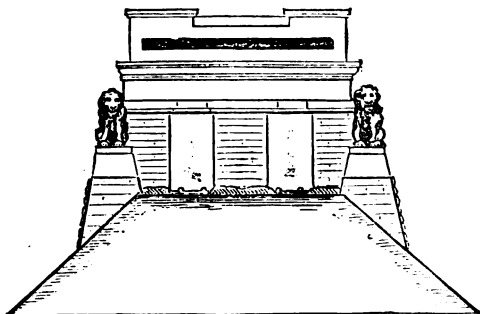

FIG. 98 *b*.—Abutment Tower.

sions from a book, take the number of feet as inches, and divide by 50. This will give you the height of central tower from the surface of rock, as the dimensions of the drawing we give, which we have worked out to scale. The exact length of your model will then be $36\frac{1}{2}$ inches for the bridge, and the height of the central tower $4\frac{1}{2}$ inches, if the base of the model represents low-water mark.

It will be best to use cardboard for this model. Draw out the sides of the central tower exactly the size and shape of those we give in Fig. 98 *a*, which

shows the side and part of the tube projecting on either side. By the measures appended to this, cut the two ends of the tower, which contain the openings through which the tubes are to pass. Before glueing the parts of the tower, mark it out and slightly tint it to represent blocks of stone, as in the lower part of drawing. Also give the architectural character to the tops of the towers as shown in Fig. 97. Then proceed with two end towers, the dimensions of which we give in Fig. 98 *a*, for both ends and sides. Fit them after blocking them out, and colouring as directed for the central tower. Then take in hand the abutment ends, each of which, you notice, is ornamented with a lion. These you must cut out in cardboard. The dimensions for the abutments are given in Fig. 98 *b*. Now the next thing to construct is the tubes, which you must make of strips of cardboard; the pieces for the depth being $\frac{6}{10}$ of an inch wide, and for the width $\frac{3}{8}$ of an inch. You will require four lengths of tube for the central spans of $9\frac{1}{2}$ inches long; that will allow for the portion of tube to be built into each of the towers, and also four lengths of tube for the end spans. In putting these strips together in the form of rectangular tubes, keep the sides parallel, and remember what they have to represent. They are the tubes in which the rails are laid for the trains to pass through them; one set being for the up line, and one set for the down line. The outsides of these can be coloured to give them the appearance of iron—a light slate colour, for instance. Having completed all the parts in detail, you must now put them together. First get a piece of board 4 inches wide, and about

We propose, therefore, to take such light metal work that can be done without brazing, drilling, or riveting—and which can be done as much as possible with your carpentering tools. The first class of work we propose shall be made of light strips of iron, which can be bent into various curves and scroll forms, to be turned into brackets, candlesticks, screens, lamp-suspenders, and flower-baskets. For this purpose you require some strips of sheet-iron. The thickness selected must be regulated by the purpose for which you require it. You can get it

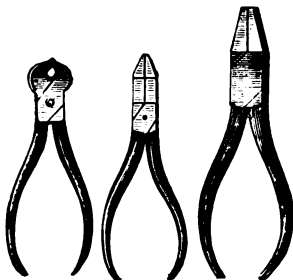

FIG. 107.—Cutting Pliers.

of a thickness of a thin or stout ribbon, and width from $\frac{1}{8}$ inch to $\frac{1}{2}$ inch. For suspended objects the thinner iron can be used, for these strips are immensely strong; for standing objects, where rigidity is wanted, you must use the thicker kind, and sometimes a rod of iron twisted up with it for the sake of support. Then you require some skill as a designer. Draw a few samples of simple objects to begin with, such as a scroll, a candlestick, a suspended flower-basket, a bracket, a frame for a match-box, or for any other object you have a wish to

produce. Get a look at some work done in the same material; that will help you to multiply designs, as well as to see how the work is put together.

For this work you need cutting pliers, bending pliers, and nipping pliers specially adapted to binding parts of your work together with the iron ribbon. Reference to Fig. 107, which give you the usual forms of cutting pliers, will help you in the selection of these tools. The first is a strong pair with

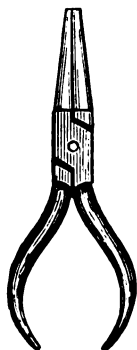

FIG. 108.—Round-nosed Pliers.



FIG. 109.

“square noses,” as the gripping ends are called. This is for your first and heavier work. The second is for cutting only—better adapted for trimming the ends of your strips after you have cut them off. The third is for lighter work, either bending or cutting. As we mentioned, it is not positively necessary that you should have all three pairs, but do so if possible. In Fig. 108 we give you the form of the round-nosed pliers, which you will find of the greatest service in bending your iron strips into

curves, especially the smaller curves. The third form of tool, which we give in Fig. 109, is especially for nipping the parts together. The noses of these pliers are flat at the ends, and enable you to grip the parts together with considerable force. This you will find especially necessary when putting together the various parts with the flat ribbon, to which we shall have occasion presently to refer.

With these tools at hand, and a vice such as we recommended for carpentry and picture-frame making, and an iron block for an anvil, you can with advantage start on your work. Before making any object you must get accustomed to turn various lengths into scrolls and elegant forms. This is best attained by drawing a scroll on a slip of paper, such as is shown in Fig. 110. Then with your rounded pliers, run your strip of iron ribbon into the shape of the scroll designed. Take care to avoid any sharp bends. It is advisable to make your drawing of the same size as that required for the object; you then have an opportunity of applying the iron scroll to the drawing, and it thus acts as both a guide and a corrective. When you are able to turn out some respectable scrolls, you will find yourselves able to combine them into the objects we have named, some of which we will describe, with the method of putting together. This work will give you a very wide field in which to exercise your ingenuity. The variety of patterns seems almost endless. You may get some ideas from fretwork designs.

Suppose you wish to make a bracket. That seems as easy and straightforward a piece of work as you can possibly have. Cut off your iron, bend it into

a good shape by first drawing your scroll on a piece of paper and bending your iron to it—the drawing acting as your gauge. Now turn up a second scroll just like the first. These are to be made into a pair of skeleton brackets of the form shown in Fig. 111. Here a piece of stouter iron band than you have used for your scrolls is bent into a right angle. You want two of these, one for each scroll. To do this you must cut off the two strips of iron. Scratch each piece across the centre, and place this scratched line on the edge of your anvil, then hammer



FIG. 110.—Simple Scroll.

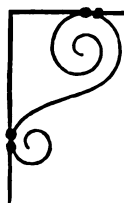

FIG. 111.—Single iron bracket.

it into a bend. Do this gradually. To be sure that you get the right angle, gauge each piece to a right angle drawn on paper, or to your drawing square. Now the pieces you have cut must be joined together at the parts marked in Fig. 111.

There are two methods of putting together your iron work. You see that every portion must be put together quite flat, and so tight that it is not possible for any of the parts to get easily “wriggled” out of their places. In fact it must be put together so that the whole is nearly as rigid as if it were a single piece.

One method is by binding together the parts with

very thin iron wire, so carefully, with the threads as close together and as tight as if you were binding the handle of a cricket bat. The fine wire such as is sold for twisting up "flower button-holes" will do. It is easily worked, and can be readily fastened off.

The second plan is to make a clasp of the same metal as that in which you are working. This you can do by cutting off a piece long enough to clasp once round the pieces to be held together, and only once round—none to overlap.

You will be able to make the clasp by the help

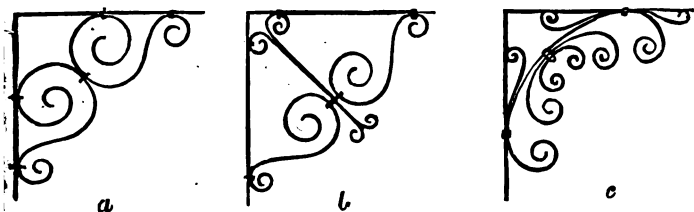

FIG. 112.—Light iron brackets.

of your hammer and the pliers in Fig. 109. Get the clasp to fit so well that there is no looseness or slipping to be feared.

Select one of these plans, and put together your brackets as shown in Fig. 111.

You can next try the more elaborate brackets in Fig. 112, *a*, *b*, *c*. In Fig. 113, *a* and *b*, a central stay, which is ornamental and gives extra strength to the pieces employed, consists of a piece which has been twisted in the centre or towards one end. This process is easily accomplished by screwing one end tightly in the vice, gripping the opposite end in your flat-nosed pliers, and then gently but firmly

twisting it. You will find the thin iron strap yield readily to such pressure as you will be able to apply by this method.

These brackets are exceedingly useful for supporting shelves. They are strong, easily fixed, and are ornamental, according to the art and design put into them.

Having succeeded thus far you may aim at making something requiring a different method of working, as well as a new channel for your ingenuity.

Suppose you decide on making a candlestick—a

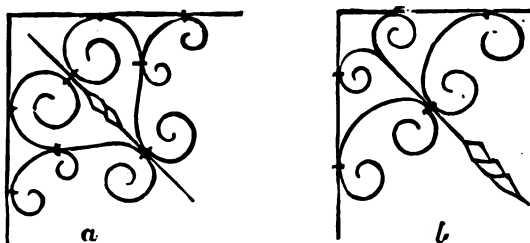

FIG. 113.—Light iron ornamental brackets.

pair, perhaps, if you succeed well. Draw your design first, if it is to be like that given in Fig. 114. Cut three strips of iron ribbon; they are to be of the same length; bend each into a scroll of the form of *a*, Fig. 114. They must be the same in size and shape. Then get an earthen end to hold the candle. This must be supported on two rings; one at the upper end immediately under the rim, and one at the lower end. To these rings the bent portions must be bound by the upper ends, to the rings. Place them so these uprights stand at equal dis-

tances from each other, held by two other rings at convenient distances down the stem.

We repeat that the binding and twisting must be

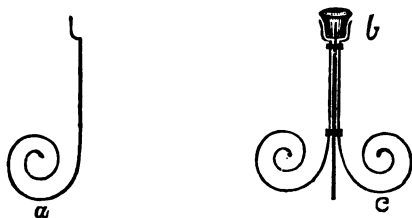

FIG. 114.—Design for Candlestick.

a. Each part for the uprights; *b.* the earthen socket;
c. the complete candlestick,

done with the pliers, so that there is no tendency for them to undo and loosen the work. The candlesticks just described can have a triangular foot of

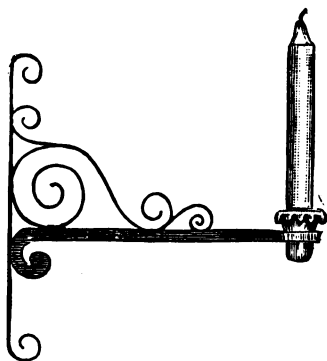

FIG. 115.

thin polished wood, if you like to give that amount of labour to them; it will not make them heavier, but it will make them stronger. Wires drawn over the branches of the scroll through the wood will

hold each part well and safely, and give stability to the whole.

In Fig. 114, and several others that follow, where most of the designs stand on three feet, or consist of three branches, the third side is presented edge-wise, so as not to obstruct a fair view of the other two, so that our readers will be able to easily catch the design.

An ornamental bracket for the support of a candle may be made somewhat of the fashion given in Fig. 115. In this figure the horizontal support is made of rather stouter iron. The exact design you can decide on for yourselves.

TO MAKE A SUPPORT FOR A FLOWER-POT OR A FLOWER-STAND.

Design three or four uprights, or make a copy of Fig. 116. Bind the upper part to rings the shape of any flower-vase you wish to form the top of your ornament; then as the stem of this must be stronger than that of the candlesticks, you must bind the ribbon upright to a small iron rod. If you have three sets of scrolls, you must get a smith to beat you a round iron rod into a triangular rod. This rod may be made long enough to reach to the same level as the scroll-work forming the feet, for it will give the stand additional strength. The spaces between this and the outside feet can be filled in with elegant little scrolls, which will add ornament and finish to the whole.

In Fig. 117 we give a design which is more ornamental, but which we think will not be more

troublesome to make than the last described. There are somewhat more details in it, but when these are worked out separately, we think you will be able to put the various parts together. The sketch we give is from an actual piece of work made under the supervision of an art metal worker. The triangular pieces, bent with the broad edges outwards give strength and stability to the whole, and you

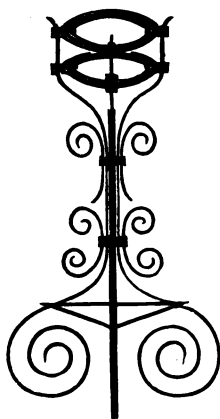

FIG. 116.—Design for Flower-stand.

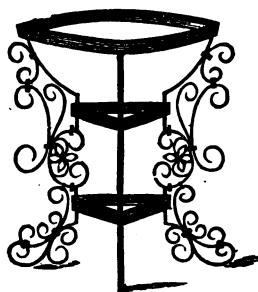

FIG. 117.—Ornamental design for a Flower-stand.

may find it advisable to make them of wider strips of iron.

Lamps for suspension may be made by cutting squares of glass of any tint, size, or shape. Fit a frame top and bottom, and at each corner carry up a strip of scroll-work, or a plain strip, as shown in Fig. 118; from each corner of which carry up a length of scroll-work, or some short pieces well fastened together, so as to form a strong chain.

With stouter iron for the frame work, much larger and stronger objects may be made. We have seen elaborate stands containing a methylated spirit-lamp and a branching hook above, on which a kettle has been hanging, forming a neat and useful ornament. With a frame of $\frac{1}{4}$ inch iron, a useful fire-screen can be made, and such iron may also form the backbone

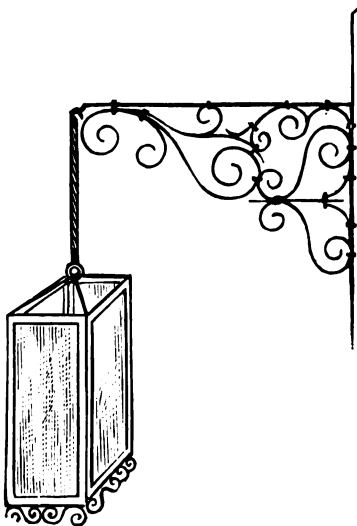

FIG. 118.—Suspended Hall-lamp.

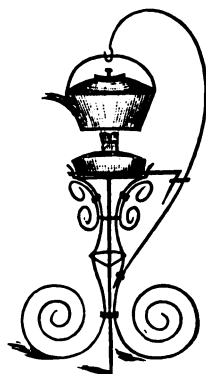

FIG. 119.—Kettle- and Lamp-stand.

of brackets. This iron can be twisted and worked cold. If you take a square bar, and put it into the vice, screw it up very tightly, so that the vice-chaps take the faces of the bar quite flat, you may by means of a square-faced wrench twist the iron into a screw-like form. This makes it look lighter than it would if it were wrought on a square bar

throughout its whole length. Now supposing you want to make a bracket. Take a piece of iron $\frac{1}{4}$ inch square, bend it to a right angle, then turn up some scrolls, and fill in the angle, as in Fig. 120. Two other sets of scrolls on either side sometimes add to its ornamental qualities.

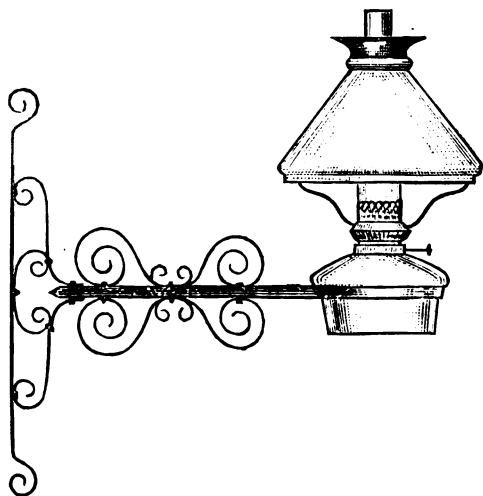

FIG. 120.—Bracket-support for Lamp.

Candelabra of two, three, or four branches may be worked out. Brackets and bookshelves can also be arranged, by means of wood-work shelves screwed on to ornamental scroll supports.

These ornaments can be blacked, covered with enamel paint, gilt, or bronze, to suit the taste of any persons, or to match any other suite of ornaments, or they may be left plain.

TO MAKE A FIRE-SCREEN.

Make a frame of any size you decide on, of the stouter iron; turn up a set of scrolls for the feet,

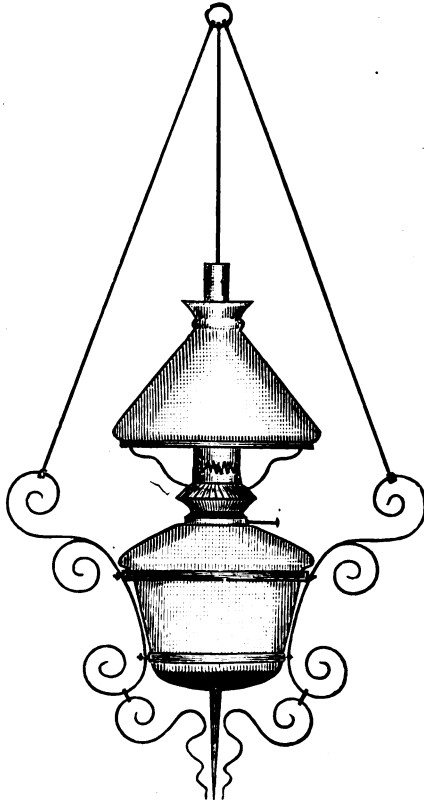

FIG. 121.—Suspension for Lamp.

as in Fig. 122—two sets for each end—then fill in the frame with a scroll design, or a design of angular

geometrical patterns, and fill in the spaces with coloured glass, or plain glass covered with thin coloured paper.

This iron-work of strips looks exceedingly well, if relieved by strips of copper—*e.g.* in any of the designs already mentioned, where the upright portions are of iron, the cross-bands may be of copper. Copper for this purpose may be bought at the ornamental iron-workers, as well as the iron strips, and the wire for binding them together. Such work as this may be worked up into very elaborate

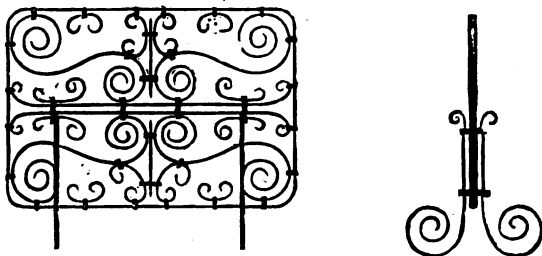

FIG. 122.—Design for Fire-screen in light iron-work.

designs; they only require patience and care, and they will reward you for the time you spend on them.

In Figs. 119, 120, 121 we give three specimens of work which you will be able to accomplish by following the directions already given. You may, however, find an advantage in judiciously combining the lighter with the heavier iron in these examples.

For heavier work than we have mentioned you would require a forge, when you could beat out and soften the iron, in order to work it into shape; also

to bore it and rivet it. Some beautiful work of this class has been done by amateurs; but it is rather outside our province to deal with it. If, however, your fancy prompts you to a desire for this kind of elaborate iron-work, several workshops are open to you, where you can get both instruction and practice. Iron-work is both elegant and durable. Some splendid specimens are still in existence of thirteenth century work, where the various parts are all put together by straps of the same material as that in which the work is executed, without even a rivet or a brazen joint.

REPOUSSÉ WORK.

This is a metal work, of quite another kind; and instead of working with strips of metal, and that metal iron, you work by embossing your design in metal, which is generally sheet-brass, sometimes sheet-copper.

First, you make your design in ink on paper; then procure a sheet of soft brass, known as "French metal." Paste your design flat on to the brass. Now your object is to produce this same design in relief on the thin metal. For this purpose you require not only a soft bed on which to work the metal, but the tools to do the embossing. These tools are called chasers, which are short iron punches, used with a flat-faced hammer. The block upon which the brass is laid is of pitch, something of the consistency of shoemaker's wax. A layer of this is placed on a block of wood; then the sheet of metal, on which the figure is then traced with the steel

point; then the design is punched into relief; the most prominent parts having to be punched into highest relief. Remember, while you are working at this, the finished design will be the reverse of its appearance to you. Having thoroughly traced the design, and the details, the block is laid on a sand-bag, and this placed on the bench, so that blows are deadened, and the tapping does not make the noise it otherwise would. In the first attempt, take a piece of brass, and indent a continuous straight line; then a simple design of straight lines, in which the

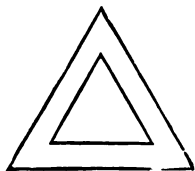

FIG. 123.—Exercise in straight lines.

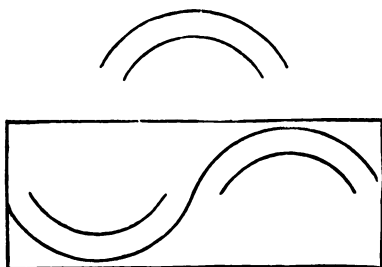

FIG. 124.—Exercise in curves and straight lines.

relief is small, like Fig. 123. Next take a few simple curves, as in Fig. 124. Practise these straight lines and curves till you can do them fairly well, then start on something more elaborate. Suppose you take a piece for a shallow tray—a pin-tray say,—cut the metal into shape and size; if you have not the shears for this you can have it done for you where you buy the brass. For this you should pay about 1s. 3d. per pound. Let the design be a simple one, some geometrical pattern, as in Fig. 125. Make the design on paper; paste it on the sheet of metal.

Then with your tracer and hammer, do the ring at the edge; then the inner ring; then deepen the broad indented line for the design; or if you wish the design sunk, and surface generally raised, you must punch all the other part up. In the punches, you have some for broad surfaces, others for fine

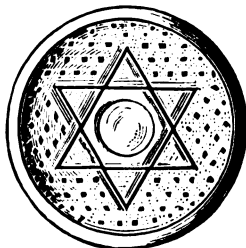

FIG. 125.—Simple design for a Pin-tray.

lines; you must select that best suited for your purpose. The punches are sold in boxes, each containing a set of nine; the shape of the punching surfaces are shown in Fig. 126. The space between the design requires to be punched regularly all over to give it a roughened appearance; this must be

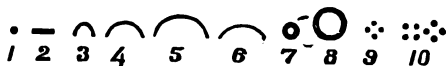

FIG. 126.—Embossing end of punches.

done from the right side at finishing. Sometimes it is necessary to see how the work is progressing, therefore the pitch has to be removed. This is done by the flame of the blow-lamp, which melts the pitch so that it can readily be removed. In the simple designs this is not so much needed; but in

the more elaborate this frequently has to be done. Try three or four simple designs first.

In your next stage take a design where the relief is not all the same depth; such as a leaf (Fig. 127), or a flower and leaf, and then follow this with a wreath of leaves, which may be worked in the centre, or round the border. First, in each case, with the tracer get the full outline, then the curves of the leaves, then get a rounded channel from the various veins of the leaves, then deepest of all between these and the mid-ribs. This is best accomplished by taking



FIG. 127.—Simple design for a tray with embossed leaf.

nature for your guide. Get a series of well-developed leaves, to lie before you on a sheet of white paper. Place these in an easy natural position, not flattened or cramped at all; then do your best to imitate them in your metal, having the right side up for the delicate chasing and finishing. You will find this requires about the same patience as wood-carving.

In the cases where we have supposed the metal is to be made into trays, turn up the edges after the designs are finished. Take care that they are turned up at the same angle all round. This can be managed by hammering the edge to a piece of wood.

The hammer for this purpose has a broad, smooth face, so there is no fear of irregularly marking the metal if carefully worked. You can next take a design in fruit and leaves, in which the fruit will require the highest relief, as Fig. 128, and the surface at the same time requires to be nicely rounded, so that the tools must be used very carefully indeed to produce this effect. Then a stage higher you can take the head of an animal. Throw the most prominent parts in the greatest relief; be careful about the eyes and mouth, and the various markings of the face, all of



FIG. 128.—Exercise in fruit and leaves.

which go to make up expression. Then you can go on to portraits and figures, according to their difficulty and your own proficiency. Books of suggestive designs for this class of work are sold for the purpose of guiding amateurs in the selection of subjects. From the smaller you can go to larger pieces of work, according to taste and ability. You may experience another difficulty, for it sometimes happens that from continual punching and tapping the metal becomes brittle; this you can tell as your work progresses. Should it do so, it must be annealed. This is accomplished by putting the brass in a clear

coal fire till it becomes red-hot; then take it out and allow it to cool gradually. If your work is long and tedious, this, however, may have to be repeated.

WIRE-WORKING.

Various designs may be worked out in wire. You can for this purpose use copper, phosphor-bronze, and galvanized iron wire. Among the most orna-

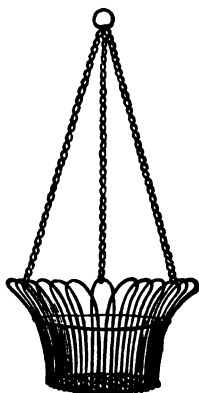

FIG. 129.—Wire Basket.

mental objects, perhaps, are hanging flower-baskets. First cut a length of wire; form it into a bottom ring. Next cut off a number of pieces of equal length; bend them into a long, narrow horse-shoe shape; loop the bottom ends round the lower ring of wire. Turn the ends well round the lower ring. When this is done, take another length of wire and lace it in and out, keeping the upper parts of the wire at equal distances from each other. Bend the upper edge outwards into a graceful curve. Then

lace the bottom with strands of wire, crossing each other in the lozenge shape. To suspend, arrange three simple strands of wire, or three chains, at equal distances from the upper ring, and fasten them into a common ring at the top, as in Fig. 129.

You may find it useful in making cages for keeping pets, to use wire for the fronts of such cages. They are readily made by boring holes in the opposite sides of a frame, and drawing the wires through; the size or thickness of the wire depending on the size of the frame. Turn the ends down to prevent them from drawing out. Do not use copper wires where animals are in question; they will, however, do for ornamental work. In using galvanized iron wire, there is no positive necessity to paint it, but it preserves it better, and frequently makes it more ornamental. Enamel paints are well suited for this kind of work.

METHODS OF SOLDERING.

Without some hints on soldering, this chapter would not be complete. It is a very useful qualification for boys; if they aim at being "handy boys," they will most likely become "handy men."

Suppose in the first case a saucepan or a kettle leaks, it has to be sent to the tinman's, or ironmonger's; and the job being so insignificant and trifling, is laid aside for others of more importance, yet it is wanted at home, and the delay in its return causes a lot of worry and annoyance. The next case that occurs, you try and cure it yourself.

Tools for soldering should always be kept at hand. A cheap set, with a bit of solder, can be bought for sixpence.

The saucepan must first of all be well scoured with a strong solution of soda and water; this removes all grease, then scrape the hole quite clean. If the hole is only a small one, a little drop of solder will perhaps be sufficient. This you can put on after moistening the spot with what the trade call "killed spirits." This substance is made by dropping strips of zinc into hydrochloric acid, diluted with equal parts of water, till no more zinc is dissolved. This substance acts as a flux. Now heat the soldering-iron in a clear fire (see that it is clear); then rub it on a piece of sal-ammoniac, or some powdered resin, then on to the solder. Apply this to the small hole in the saucepan; it will soon cool and harden. If, however, the hole is too large for this, the best way is to put a piece of tin over it. Well clean all round the hole by scraping, then moisten it all round with killed spirits, and spread on the solder according to the plan already mentioned. Cover it over with a little powdered resin; melt the solder by the soldering-iron heated up afresh, then put on the patch of clean tin. Press it into close contact; the solder will harden. If a very large hole occurs, it will be better to put in a new bottom altogether. This is easily accomplished by cutting out a piece of block-tin, and turning up the edge. Well clean the parts to be joined, and proceed as already directed.

Compo-tubing, such as is used in gas-pipes, may be joined by simply covering the parts with a little powdered resin, and cutting a strip of thin soft

solder, and putting on to the resin. The soldering-iron in this case must not be used too hot.

But suppose a water-pipe bursts, as it does sometimes in sharp, frosty weather. You must cut the portion of pipe containing the hole completely out; this you can do with an old saw, cutting the edges off quite square. Then a piece of new pipe must be taken, and the lower piece of old pipe opened out to receive the lower end of the new piece. This you can do by driving in a peg with a mallet—plumbers use boxwood turnpins for the purpose. Now open the upper end of the new piece in the same manner for the lower end of the old pipe to go into. Next take your knife and scrape quite clean the surfaces to be joined. Put the pipes together; this will leave a circular hollow around each pipe. Into these sprinkle some powdered resin, then pour in some melted solder, and pass round the edges the point of the heated iron. Do this till you are sure the solder and lead are melted together. A neat outer joint requires much experience to make, so we must leave that to a professional plumber. We have given you enough directions to secure the joint, and avoid the annoyance of having to wait for plumbers, who are all busy at "pipe-bursting time."

In your practical science work it often happens that you want to join together flat surfaces of copper-band, and join up copper wires; and as we have frequently required to make platinum electrodes, these must have our consideration next. As the platinum electrode is the simplest, we will take that first. If you require a pair, let them be cut off the same size from strips of platinum foil.

Now take a short length of platinum wire for each, and with a metal pin make two holes through the foil in a line where the joint has to be made. Pass the wire through these holes. Hold this part in a blow-pipe flame till it is white hot, then put it quickly on an iron plate, and give it a smart blow with the hammer. Have all things ready for this, so that the blow is struck before the metal has had time to cool. A weld between the wire and the foil will then have been formed. This is more effective and lasting than any soldering.

In soldering copper surfaces, either sheet or wire, let them be thoroughly clean. The flux used is sal-ammoniac and powdered resin. Many mix the powders together, and apply them at the same time. Some recommend a piece of cane split up into filaments, for brushing in a strong solution of sal-ammoniac, and then sprinkling in the resin. We think, however, you will prefer the former plan.

The next thing is to get the soldering-iron the right temperature—for if not hot enough to melt the solder, it must be put into the fire again; and if too hot, the tinned surface on its face will be burned off, and the solder will not stick. Should this be the case, you must re-tin the soldering-iron, then you proceed as we have directed already. The sheets of copper and the wires must be held together till the solder is hard enough to hold them of itself. If you require to loosen any parts soldered together, it is better to do so by a lamp-flame; you can get the parts heated to a higher temperature by that means than by the iron.

To re-tin the soldering iron, you must heat the

copper bit in a clear fire, nearly to red-heat; put it in a vice, edge upwards, and file it to a clean metallic surface. Then rub it over with a piece of sal-ammoniac, and drop on a small bit of solder, or rub on it a bar of solder. The surface of the soldering-iron will then be covered again with tin, and will be ready for use.

With these methods, which are the only ones you are likely to require, we will conclude our chapter on metal-work.

Many books on the separate departments of metal-work are in existence, and which are exceedingly useful in giving you hints for work. Best of all, if you wish to get a better practical knowledge of the subject, join a good workshop. Many workshops in connection with our technical schools are now open, giving excellent chances to amateurs and others.

CHAPTER XII.

HOW TO MAKE SIMPLE APPARATUS FOR CHEMICAL EXPERIMENTS.

MOST of our readers have learnt something of science at school, or at the evening classes in connection with their school or recreative classes.

Chemistry is the science generally taken first, because, as a subject, it is most important, and the ordinary experiments are performed with apparatus and material much less costly than that required for many other branches of science.

Having seen the experiments in class, most pupils, if they take any real interest in their work, are anxious to repeat the experiments themselves. And this is very desirable; for the performance of an experiment is a much better way of getting to understand the subject than merely seeing the experiment performed.

A little patient ingenuity will enable you to acquire a fair stock of apparatus for the repetition of ordinary experiments. Test-tubes, flasks, and 1lb. of glass-tubing of various sizes, a few good soft corks, a small set of cork-borers, a triangular file, a small

rat-tailed file, are the first requirements. You must have access to, and the use of, a gas-burner or a good spirit-lamp, and a ninepenny Black's blow-pipe. Working in glass forms also a nice change of occupation from carpentering—the manipulation is so different—the toughness of the wood forming a very strong contrast to the brittleness of the glass.

We always find a pupil gets on so much better with his work if he repeats the class experiments himself, and much better still if he makes his own apparatus. He is more interested in his work, it

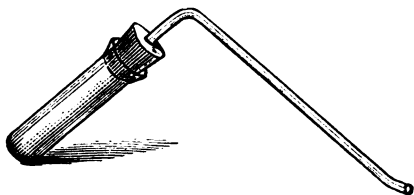

FIG. 130.—Apparatus for preparing oxygen gas.

widens his knowledge, and gives him a thoroughness that he would not otherwise be able to acquire. Above all things, it makes him practical.

We feel sure that after learning to make the simple things mentioned in this chapter, he will go on to the more difficult contrivances which we dare not even hint at here.

As the subject, oxygen, is generally the first gas dealt with, we will describe a simple apparatus for making it. The apparatus for making gases that are only given off by heat, must be made of thinner glass than that for gases which are given off at the ordinary temperature of the air.

We will suppose you want a small apparatus for making a little oxygen. Take a test tube $\frac{3}{4}$ inch by 6 inches—the best way is to buy a few tubes of various sizes from $\frac{1}{2}$ inch \times 4 inches up to $\frac{3}{4}$ inch \times 6 inches; these will be the most useful sizes. Select a good soft cork to fit the tube. You can soften the cork by squeezing it; this is generally done by the ordinary cork-squeezer, but very likely you will not have one. You must therefore wrap up the cork in a piece of paper and roll it on the floor, under the foot, regulating the pressure on it as may be required. Having fitted your cork to the tube, the next thing is to fix a delivery-tube. This you must select before boring the cork. Choose



FIG. 131.—Set of Cork-borers.

the borer somewhat smaller than the tube. The borer is a brass tube with sharp cutting edges, as shown in Fig. 131, which should be carefully kept, so that the cutting part does not get turned up by coming into rough contact with your file, or by falling on a hard floor, for the edge is soft, and only adapted to cut such soft substances as cork. Cork-borers are sold in sets (Fig. 131). To bore the cork, put a stout wire through the hole at the upper end of the barrel of the borer; hold the cork firmly in the left hand, pressing it down on a board, or hold it flush with the edge of the board. Begin with the smaller end of the cork. Hold the borer at right angles to the top of the cork; then

N

with a slight pressure turn it into the cork, till you find it through the other end. Draw out the borer, and with the wire push out the core from inside of the tube and put it away—the borer may then be smeared over with a little petroleum to keep it bright. Now just moisten the end of the glass-tube selected for the delivery-tube, and put one end into the cork by holding the tube lightly between the thumb and the finger of the right hand, and the cork in the left, twisting the tube and pressing it at the same time. It should fit very tightly.

The next process is to bend the tube to give it "two elbows." The best way to do this is to hold it in a flat flame, the first portion being near to the cork—it will form a handle for you—the tube must be twisted round, and moved right and left so that several inches of the tube get heated. Let it get hottest at the portion you want to make the bend. When red-hot remove it from the flame, and bend it to the angle required; bend it gently, so that it may not have a sharp bend, or it may break. Do not let it cool suddenly, but hold it at some distance above the flame for a short time, and do not wipe off the soot with which it will be covered for some time—not till it is quite cold. By this means it gets "annealed." The other end—"the delivery-end"—must be heated in the same way, and bent slightly upwards.

It is better to cut off the tube to the proper length before fitting it. A good length is about 12 inches from the cork. Take the tube at this point lightly between the fingers, hold it firmly down on a board, and give a deep scratch with a sharp

triangular file. With a small tube, this one scratch will be enough. Now hold the tube tightly, bring the thumbs close up to the scratch, with the scratch upwards; break the tube by sharply snapping it downwards. If the tube is too thick for this, scratch the tube half round, or even more, and then break it off. The broken end will be sharp, and must be held in a gas-flame till it is red-hot, then the sharp edges will become round. If you have finished your apparatus properly, it will have the appearance of Fig. 130. Sometimes, even with the best corks, the fit between the cork and the tube is not the most

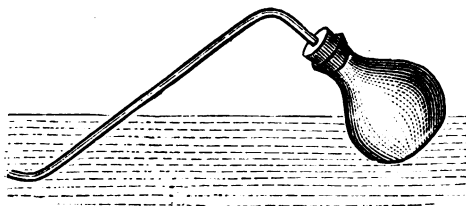

FIG. 132.

perfect. If not perfect the gas, when given off, will escape; this may be prevented if a little pipe-clay be moistened and spread round the cork, and pushed well down to the edge of the tube. Keep a block of pipe-clay for similar use in other apparatus; it is much better than paste or dough.

When you have put in your mixture, from which you intend getting the gas, do not heat your tube intensely at one spot at first, but move it through the flame so that it gets generally and gradually warmed. Care in this respect will save you a good deal of disappointment, and much destruction in gas-tubes and flasks.

If you want such a gas as oxygen on a larger scale, select an ordinary Florence flask, and fit it in the same way as we have directed for the tube, and you will have such an apparatus as shown in Fig. 132. Select a flask in which the glass is of even thickness, and not a knotted or flattened flask. Some gases are given off at high temperatures from liquid mixtures, and require a safety-tube to the

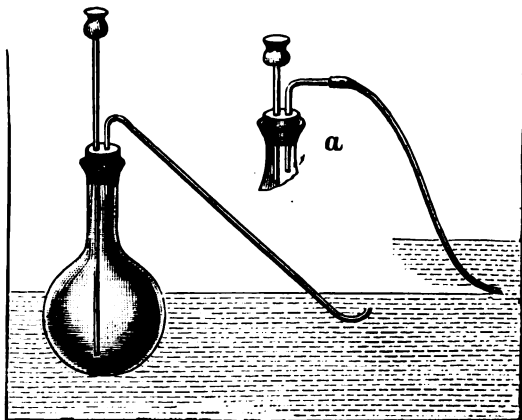

FIG. 133.—Apparatus for hydrogen or carbonic acid gas.
a. The india-rubber delivery-tube.

flasks employed. The flasks for this purpose have generally larger necks, because they require larger corks, through which two holes can easily be bored. In boring these take care that they are parallel, for it looks very badly to have one tube aslant to the other. The outer end of the safety-tube is generally supplied with a funnel. This you can manage for yourself. Hold the end of the tube in a gas-flame after it has been well warmed for some two inches

of its length. While in this position keep it revolving between the hands. When the glass gets red-hot and soft, whirl it round a little faster; the softened glass will take the form of a funnel. When you have opened it out as much as you need, it must cool very gradually. In doing this, do not allow it to come in contact with any cool object, but hold it for some time in the heated air arising from your lamp. By this means it will become annealed; then it will not be liable to be broken with the differences of temperature to which such a tube must necessarily be subject when in use. If properly fitted, such a flask, when ready for use, is like that in Fig. 133. The funnel tube here shown is sometimes called a "thistle-tube."

When the delivery-tube is long, it is likely to be broken. This danger may be averted by having it in two pieces, and joined by a length of india-rubber tubing. Cut off the tube you require for this purpose, a convenient length, with the file, according to the directions already given; then take about an inch and a half of small indiarubber tubing, of such a size that when slipped on to the tube it makes a tight fit. The ends can be fastened, if necessary, by being tied tightly with some pieces of twine, or fine copper wire; the latter undoubtedly holds best, because you can get a tight twist, and can also twist the ends up together as shown in Fig. 133, *a*. It is, however, better to have tubing fit without being tied.

For the making of hydrogen, carbonic acid, and such gases that require no heat, it is best to fit up a wide-mouthed bottle or flask, as in Fig. 133. Get a good cork—or if you prefer it, buy a caoutchouc

stopper through which two suitable holes are bored, and fit it up with similar tubes to those described in our last arrangement; then you will have such a piece of apparatus as is shown in Fig. 133. Bottles fitted in this manner will answer all the purposes for which Woulffe's bottles are recommended, and are of course very much cheaper.

We will now ask you to fit up a wash-bottle. Get an ordinary bottle with a fairly wide mouth; fit to it a good cork. Having selected your tubes, bore the

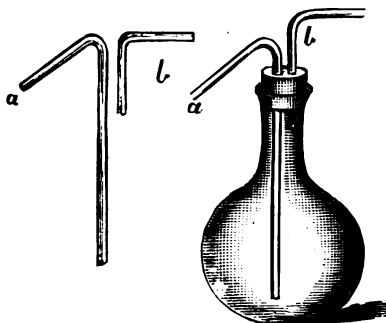

FIG. 134.

holes the right size. Bend tube *b*, Fig. 134, at right angles; take care in bending it that the tube does not get contracted. This you can avoid by heating a good length of the tube in a flat gas-flame, but remove it from the flame before you bend it, as we have before mentioned; but being important it is worth repeating. For tube *a*, you must have one long enough to reach the bottom of the bottle, and at the other end get a graceful bend; before bending it, you had better form the "jet" end. This you must do by softening the glass-tube in the gas-flame, then

drawing it out to the fineness needed. Let it cool. Then break off the end; heat the tip in the flame to take off the rough edges, and you have a jet as in the "tip" of Fig. 136. Now fit these bent tubes into the cork, and you have such a bottle as shown in Fig. 134. A flat-bottomed flask is sometimes employed for making a wash-bottle. The outside portions of the corks in all these arrangements are improved in appearance by the use of a little "philosopher's" paint, as it is called. This is made by dissolving some good sealing-wax in methylated spirits. Dilute it down to a convenient consistency, and put on smoothly with a camel's-hair brush. Do not use the apparatus till this paint gets quite hard, for if fingered too soon it takes impressions of the skin of the fingers, and also takes the gloss off it. In about two or three days it will be quite hard enough to handle if you do not put it on too thickly. Next fit up a bottle for making hydrogen sulphide. Get a white or green glass bottle, as was mentioned for ordinary hydrogen—a pickle-bottle will do. A good cork must be fitted to it and the funnel and delivery-tubes, and a second bottle must be provided as a wash-bottle, which should be somewhat smaller than the generating-bottle. Instead of the delivery-tube being fitted to the bottle in which the materials are put for making the gas, it must be put into the wash-bottle. The wash-bottle must be fitted as shown in Fig. 135. The corks in both bottles must be exceedingly well fitted, and the tubes must exactly fit the holes. Notice that in the wash-bottle the tubes from the supply-bottle must reach nearly to the bottom of the jar. The whole ready for use is shown in Fig. 135.

Now contrive a jet for burning hydrogen from the bottle, Fig. 133, by removing the delivery-tube, and fitting to it a tube bent twice at right angles, as shown in Fig. 136. Draw out the jet at the end of the tube as already directed. As soda glass gives a yellow tinge to hydrogen flame, it is better for having the tip of platinum; this you can do by bending a small piece of platinum foil and putting it into the glass-tube when the end is soft. When

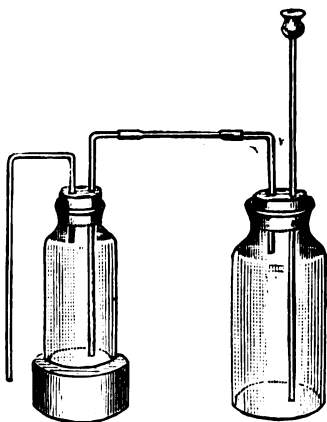

FIG. 135.



FIG. 136.

it cools, the platinum tip will be fixed tightly. A straight jet about 6 inches long attached to the end of a length of indiarubber tubing is sometimes even more convenient than that we have described.

In the next place we will show how you may fit up in series U tubes. First get a good soft cork for each tube; see that they fit well. Then bore each cork to fit the "quill" tubing you must use for the connections. Heat the tubes and bend them carefully,

keeping the bends all in the same plane, or they will look badly when put together. We show such an arrangement in Fig. 137; attach cords at *a*, *b*, by which the whole arrangement can be suspended on a stand or frame made for the purpose.

The frame referred to you can make for yourselves. Take a flat piece of board about 6 inches wide. Plane it up nice and smooth; bevel off the upper edge. Then cut off two pieces for uprights, about 10 inches long and $\frac{1}{2}$ inch square; let these into the base-board. Then across the top fix a horizontal piece of the same thickness. Clean it up and stain

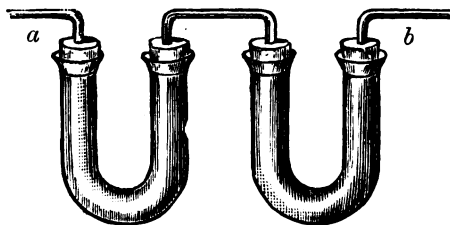

FIG. 137.—Set of U tubes.

it; or it may be left plain, for it is equally useful either way.

Put in some tacks or hooks in the top piece at the points in which you wish to suspend the apparatus.

A few square blocks are useful for raising above the level of the table, or blocking up any items of apparatus. They can be made in sets 4 or 5 inches square, and of thicknesses varying from $\frac{1}{4}$ inch to 4 inches thick.

One or two other items of apparatus may be mentioned here, and an easy method of making them.

The first we will give is how to blow a bulb at

the end of a tube. First, one end of the tube must be closed. If the tube be a small one, this is easily done by holding one end in the gas-flame till it is melted; it will then run together and close the end. If the tube is of large bore, it must be closed by softening a part near to the end so that it can be drawn out, and then twisted while it is soft, and thus closed.

Having succeeded in closing the tube, heat the closed end, rotating it by twisting it between the hands all the time. When the tube is quite soft, put the open end to the mouth, remove the other from

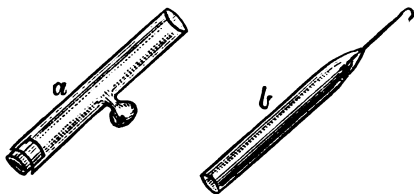

FIG. 138.

the flame, and then blow gently down the tube till a bulb of the required size is formed. Do not allow it to cool too quickly. This is assisted by allowing the bulb to remain some time in the smoky part of the flame.

A piece of glass-tubing of large bore may be joined to a piece of smaller bore, by drawing in a small length of the larger to the size of the smaller; then melt both ends, bringing them together when quite soft.

Sometimes a hole is needed in the side of a glass tube. This requires care. If the tube be a small one, it is best done after closing the ends by melting

them together. When closed and the ends are cold, bring a small blow-pipe flame on to the part of the tube at which the hole is required. The air within the closed tube will get very hot and endeavour to get out of the tube, and will do so by forcing a hole through the softest and hottest part of the tube. When cool, trim off the edge of the hole with a file. If the tube is larger it can be closed at one end with a good cork. Play upon the point at which the hole is required with the blow-pipe flame till the glass is soft. Then blow hard down the tube; a bulb will be formed at the heated spot. When cool, take off the bulb by means of the file, clean down the edges, and you will have what you require. The process is shown at Fig. 138, *a*.

A platinum wire may be fitted into glass readily, because the glass and the metal expand very nearly at the same rate, so that the platinum does not get loose. For getting the coloured flame when testing salts it is useful to have a platinum wire fitted into a stem of glass, which may be a tube or a solid piece. Soften the end into which the wire is to be fixed; press the wire in while the glass is soft. Then hold in the blow-pipe flame so that the glass may close well round the wire, and let it cool slowly. You will have such a contrivance as shown in Fig. 138, *b*.

By practice you will be able to form very many more appliances than we have given here, and make for yourself several pieces of apparatus sketched in your book on Chemistry. But all require care and patience. The skill with which you will be able to manipulate glass will increase very much by practice; and we are sure that the few hours'

practice in making even the little fittings and arrangements we have pointed out will give you great satisfaction, and, we hope, encouragement.

Good and successful glass-blowing such as is required for complicated pieces of apparatus is rarely acquired by the amateur, unless he gives an immense amount of time to it.

CHAPTER XIII.

HOW TO COPY A MEDAL OR A CAST.

WE often see medals and casts of rare and interesting objects, copies of which we like to have by us. To obtain these is not an expensive process; it only requires patience and care. We propose therefore to give such plain directions as will enable any of our readers to make such copies for themselves.

We will take first an instance of a medal, showing perhaps the head of one of the Cæsars, or a medal struck to commemorate some great event.

First, you must decide in what material you would like to have your cast. This must, in a measure, depend on the delicacy of the work you have in hand, and whether the impression is in high relief or not.

The most delicate impressions are obtained in wax, gutta-percha, and sulphur, any of which substances can be used for making moulds. Suppose you have a medal in copper which you require to copy. You must first of all smear the face of the medal with a little sweet-oil,—olive oil. You can put this on with the tip of a feather, and then rub it well over with a piece of cotton-wool, so that the oil goes into

every crevice, and none collects anywhere. Now surround the medal with a slip of cardboard about $\frac{1}{2}$ inch wide, by putting the medal flat on a board, and wrapping the slip of cardboard closely round it; and while holding it tightly, drop a piece of melted sealing-wax between two portions of the card that overlap, for the slip of card must be more than long enough to go once round. You will now have the medal tightly surrounded by a card, that will receive any fluid substance that may be poured into it. We will now take some fine plaster of Paris, which you can buy at a stone-mason's, or at an Italian's, whose business it is to make "images." Get the finest plaster, and some that has been freshly prepared. It is sold by the pound and costs very little, but the cost varies slightly according to the fancy of the seller. Now for making the mixture of plaster. For this purpose you want a smooth, medium-sized wooden spoon, a small basin, and a jug of clean water. To avoid making a mess, either put a board, or spread a piece of brown paper on the table. Now put a little water into the basin, and put in a small quantity of the plaster; as much as you think you will require for the work prepared. The plaster will sink to the bottom. Pour off the superfluous water, and mix the plaster well; it will have the consistency of cream. Now put in a little of this mixture on to your medal; and with a small stiff brush, holding the brush upright, get the plaster well into all hollows of the medal; then pour in the rest to the depth of about $\frac{3}{8}$ of an inch. Lift the whole thing, taking care not to slip off the cardboard, and jerk it sharply on to the board once or twice, to set free any air-bubbles that

may be entangled with the plaster; and then allow it to stand without disturbing it for ten or fifteen minutes. You will find by this time the upper surface will be hard, so that you may remove the cardboard. If the plaster is not fully "set," do not lift it off the medal for a few minutes. Freshly made plaster sets quickly, while the older it is the more time it takes to set. The plaster not used may be washed out or thrown away, for it cannot be used a second time. Be sure not to use an iron spoon for mixing the plaster; the cleanest and best is a spoon made of hard wood, and let it be kept for that purpose only.

Having made your mould successfully, you have of course the exact reverse impression of the medal.

To be able to take a plaster cast from a plaster mould, requires that the latter should be prepared so there is no chance of the two hanging together when one is cast into the other. To be sure of this the mould must be well oiled; oil boiled and put on it, so that the mould is almost soaked with it. It must not, however, be allowed to lie on it, so that it fills up any part of the impression. A mould so prepared gets hard, and may be kept for a long time, and if carefully used, a large number of castings may be taken from it. Having prepared the mould, proceed with operations as directed for taking the mould itself. Surround with slip of cardboard; mix your plaster and proceed exactly in the same way.

If you are taking a mould from a plaster copy of a medal or a medallion, where you cannot be allowed to oil the original on account of disfiguring

it, you can take a mould in sulphur by the following process.

Place the original plaster medal in a saucer of water, so that the water does not come above half-way up the thickness of the medal. The plaster will absorb the water, and the face of the medal must be watched. Immediately it gets a shiny surface it must be removed so that no water percolates through it and collects on the upper surface. While this is being done, have some roll sulphur slowly melting by the fire; it must melt very slowly or it will not get into a thin fluid, or keep a nice yellow colour.

When this is ready, and you have surrounded the medal to be copied by the slip of cardboard as usual, pour the sulphur on to the face of the medal. Be careful that no air-bubbles are allowed to collect between the sulphur and the plaster. This is not likely if you have the sulphur in the condition of a nice thin liquid, and rap it once or twice rather sharply on the table. Cover it to about the depth of a $\frac{1}{4}$ inch, then let it stand and cool; it will then get solid. Then lift it off the medal, and if you have successfully carried out our instructions you will have a sharp reverse impression of the original. To save your sulphur mould from the chance of being broken, it is well to back it up with a $\frac{1}{2}$ inch thickness of plaster of Paris, prepared and put on as we have already described.

To take a casting from the sulphur mould, oil its face very carefully,—taking care that none of the crevices and hollows escape this oiling,—which can be done by a piece of cotton-wool. Then surround it with the slip of cardboard, mix the plaster, and go

through the same process which we have already described. We have taken scores of impressions by this process.

From copper, bronze, or other metals, gutta-percha moulds may be taken. They are durable, elastic, and easily managed. The gutta-percha must be boiled; then it is so soft that it can be moulded into any shape, and can be pressed and worked on to the face of a medal so as to secure the minutest impression; but it must be allowed to get quite cold and hard before it is removed.

For low relief and medals of delicate tracery, wax or paraffin is a good substance to take impressions in.

Ordinary white wax, or paraffin—the ends of candles will do—must be melted carefully, and must be kept very clean, and when melted the process to be followed is exactly the same as that for the sulphur process. Remember that wax is very slow in cooling.

To take copies of solid objects, like the cast of a head, or of an animal, or a vase, the mould must be taken in pieces, so that when tied together the inside mould is an exact counterpart of the object. This requires a little more skill than that for taking the flat medal, but undoubtedly some of our readers will have ingenuity and perseverance enough to attempt it. If you wish to go in for it, we should advise you to call in at an image-maker's, and he will always show you such a mould, and at once you will be able to see how the parts are cast and held together better than any such short description as our space will allow us to give.

If you wish for a polish on the surface of your medals, you can secure it by the following method.

Get some good white curd soap; cut it into fine shavings with a clean sharp knife; then make it into a strong solution. Immerse the face of the medal or whatever is to be polished in it several times, but let it dry between each dip. It will then take a good polish on being rubbed briskly and lightly by means of a piece of cotton-wool. It will also have the smoothness and whiteness of marble. If you wish to paint them you can do so; or you can bronze them by covering them with a thin coat of gold size, then sprinkle them over with bronze powder, which you can get of any colourman. Bas-reliefs can be cast in the manner we have described, and may be put together so as to form pedestals for ornaments. Brackets may also be made in plaster, taking castings from real fruit and leaves. In taking a cast of fruit or solid object, it must be partially buried in fine white sand just sufficiently moistened to hold it together; then a frame of card-board can be put round the projecting part, and a cast taken. When the plaster is set, the portion of the fruit that was buried can be cast in the same manner, well oiling the edge of the mould first taken, so that the second portion may easily separate from it.

To take the most durable copies of medals is however to take electrotypes of them. This is done by quite a different process; but it is so interesting as well as useful that we will describe it here. This brings us into the subject of electricity, which most of our readers in these days will know sufficiently about so as to be able to understand the following simple instructions.

The process is called electrotyping, and it depends on the decomposition of a substance called sulphate of copper.

A very simple apparatus for copying medals you can make for yourselves. It is shown in Fig. 139. It consists of a lamp-glass (*a*), the lower end of which is covered with a piece of bladder (*b*), which must be tied so securely that when the vessel is filled with a liquid it does not run out. This may be replaced by

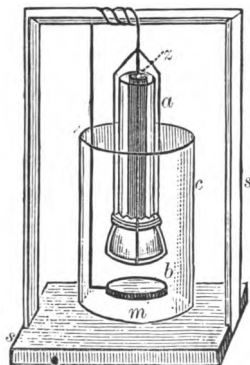

FIG. 139.—Simple arrangement for Electrotyping.

a porous pot, such as is used in a Daniell's battery if you prefer it, and it is better. The outer vessel can be a jar or a basin (*c*), or any vessel that will allow you to carry out the following arrangements. The stand (*s*), as shown, can be made of two upright pieces of wood and a cross-piece at the top. Now you must have a strong solution of sulphate of copper, sold under the name of blue vitriol or blue-stone. This you put into the outer vessel. The inner vessel must have a solution of sulphuric acid and

water, about twelve parts of the latter to one of the former. In this a zinc rod (*z*), covered with quick-silver, must be fastened either by solder, binding-screw, or by a tight twist to a length of copper wire. This may be wound round the cross-piece at the top so it acts as a support, and then turned downwards, as shown in Fig. 139, and then again at right angles, to which the mould of the medal (*m*) is fastened. The mould can be taken in gutta-percha or wax, but the face must be covered with a thin layer of blacklead, and the wire carrying it must also be in touch with it, so as to form a continuous conductor. The hollow of the mould must have its face towards the bottom of the inner vessel. To set the whole going, the zinc rod is immersed in acid and water, the wire forming a good connection with it and the mould which is immersed in the solution of sulphate of copper. An electric action will be set up, and copper thrown down from the sulphate of copper solution. In the course of about forty-eight hours sufficient copper will be deposited in the mould as to admit of its being taken off. This copper will be pure, and having been thrown down in tiny particles, it will give an exact counterpart of the mould into which it is deposited. The copper solution must be kept up at the same strength, or it will be better to tie a few crystals into a muslin bag and hang them inside the basin. Then as fast as the copper is taken out of the solution by deposition, so fast will it be taken up from the bag of crystals.

In this case the electricity passes through the liquid from the zinc to the mould, decomposing the copper sulphate, and depositing the copper.

This is such a delicate method of taking an impression, that even a photograph can be copied. It is also very useful for taking copper-plate engravings. In another chapter we will give you instructions for making a more complete apparatus for this purpose.

CHAPTER XIV.

HOW TO MAKE SOME USEFUL ELECTRICAL APPLIANCES.

WE have selected this branch of experimental science because it is very popular. Useful and various objects for experiments are easily made.

First of all you must have a battery. Batteries are so cheap to buy, that we do not give any long description of the various forms in use, but will confine ourselves to one form, which is easily made at home. If you want a Grove's battery, or a Bunsen for powerful heating purposes, try and get one second-hand; and Leclanché's or a bi-chromate battery for ringing electric bells or for telephone purposes can be obtained very cheaply indeed. To thoroughly understand the working of an electric battery, it is better that you should make one. We will therefore give the method of making a Daniell's cell, that is easily and cheaply made at home; and in a similar way so can the Bunsen. We will therefore describe these two forms.

First, the Daniell's. It is a constant battery of very simple form, and for electrotyping and electroplating

purposes it is very useful; also for magnetic experiments. You know what we mean by the term "constant." It is a battery that keeps up a current of the same strength for a very long time. For this purpose we must have two different metals, two different liquids, and two different vessels to contain the liquids, and into which we can immerse the metals.

For the outer vessel take a jam-jar; a pint jar is a convenient size. Then obtain a thin sheet of copper long enough to coil round the inside of the jar, and as wide as the jar is deep. Then as the coil should slip inside the jar loosely, cut a strip of the copper about $\frac{7}{8}$ inch wide along the end, leaving about $\frac{1}{2}$ inch at the top, so that the strip may be turned back, forming a handle by which the copper cylinder can be lifted out, also for a metallic connection to which others may be made. Now get a porous cylinder about $1\frac{1}{2}$ or 2 inches across, for the inner cell. A substitute for this cell may be made of two or three layers of thick brown paper rolled round a ruler or thick cylinder of wood, and tied tightly round a large cork, for the lower end. Only in this case the cylinder will be hardly strong enough to support itself after a short time, so that the porous earthen cylinder will be best, and it will only cost a few pence. Fig. 140 shows the general form of the Daniell's cell. The metal for the porous cylinder must be of zinc, and may be in the form of a rod, or thin sheet zinc rolled. Both surfaces must be amalgamated. To do this in the case of a rod is easy. Immerse it for a short time in sulphuric acid and water till the surface becomes rough, which it will do in the course of a

few minutes. Then take it out and rub on it some quicksilver. The surface will then be bright, wearing the lustre of the latter metal. A piece of flannel or tow, or even a soft cork, will do for rubbing on the quicksilver. To charge this cell, the outer one must have a strong solution of sulphate of copper, with a little sulphuric acid added; and the inner cell is to be charged with a solution made by adding ten measures of water to one measure of sulphuric acid. With three, four, or five of such cells you will get a fairly powerful battery. Make a wooden tray to con-

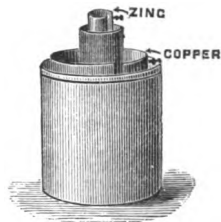

FIG. 140.—Daniell's Cell.

tain them, and to join them into series. Let the copper of one cell be joined to the zinc of another. For other particulars refer to an elementary book on Electricity. If you have not studied electricity before, it will be the more needful for you to do so, for it is important that you should know exactly what you are doing.

For the Bunsen battery the pots are much the same as for the Daniell. You must have an outer glazed vessel, and a porous inner vessel. For the inner vessel you must get a block of graphite somewhat larger than the height of your porous jar. These you must buy; ask for "battery carbons,"

and you will be supplied with what you require. For the outer cell you want zinc cylinders. It is better to buy these than make them yourself. The best are made in rolled zinc, and are sold at so much per pound. Get fairly thick zincs. Then amalgamate them as directed for the zinc in the Daniell cell. You will also require binding-screws to fit both the carbons and the zincs. These grasp the plate with one screw, and the heads of the screws take the wires to carry the electrical effect to the various apparatus to which it is applied.

Bunsen's battery is made in different forms, but the pot form you can understand from Fig. 140. With six or eight cells you will be able to get powerful effects; even a small electric arc light.

TO MAKE A GALVANOMETER.

To detect what is called an electric current from a cell, you must have a galvanometer, a simple form of which we will now give you directions for making.

First plane up a piece of wood 4 inches square and $\frac{3}{4}$ inch thick; mahogany will be best for this. Now cut a circular piece of writing-paper or cardboard 3 inches in diameter. Take a pair of compasses with a pen at one leg, and describe a circle in ink just within the edge of the card, and an inner circle about $\frac{1}{4}$ inch from it. Carefully divide the circle into four quarters, and these quarters into nine equal parts, and each two sections into ten equal parts or degrees, marked °, as shown in Fig. 141. Now make a small hole in the centre of the wood square, and cut off a small needle, long enough to stand point

upwards, $\frac{1}{2}$ inch above the board. Make the needle fast by sealing-wax, and let it be perfectly upright. Fasten the divided circular card flat to the board with marked side upwards, and the 0 (zero) point towards

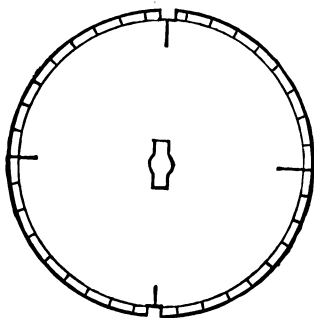

FIG. 141.—Circular Card for Galvanometer.

the central point of one of its sides. This you had better secure by drawing two lines at right angles across the board, dividing the wooden stand into four equal squares, and let the pin pass through the centre

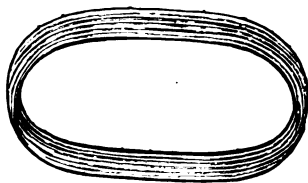

FIG. 142.—Insulated Coil for Galvanometer.

of the card. Both the centres of the wood and card will then coincide. Now take a few feet of cotton-covered copper wire, and make them into a flattened coil, as shown in Fig. 142, leaving the two ends free. Keep the coils together, either by binding them neatly

with some silk thread, or by glueing a piece of pink tape round it. Then fix it to the board in a straight line across it, so that one end points to the 0 (zero) on the card, and the other to its exact opposite point. Bore two holes on each side of the coil, and draw through them another loop of wire which will hold the coil upright but firmly to the board. Arrange it so that as many strands of wire are one side as on the other of the upright needle. Now draw the ends

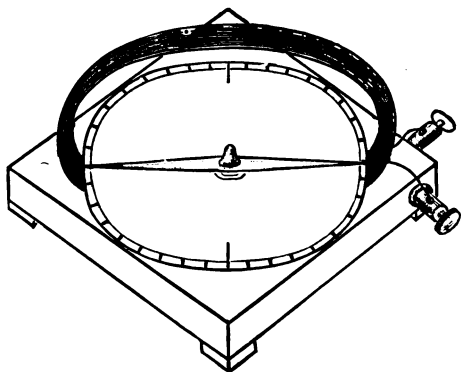

FIG. 143.—Galvanometer complete.

of the coil, and fasten one down to one corner and one to another by means of a binding-screw, taking care that the screw grasps a portion of wire from which you have scraped the cotton. Now you must have a small magnetic needle to swing within the coil, and your galvanometer is complete, as in Fig. 143.

You can make this magnetic needle for yourself, if you like to take a small piece of watch-spring; soften it by heating it in the fire; then hammer it out flat; cut it off and shape it. Indent a hollow in

its centre by a round pointed nail and hammer. Then harden it again by heating to about dull redness, and plunge it into cold water; magnetize it by drawing it several times across the poles of a strong magnet, taking care that you do this always in the same direction.

TO MAKE AN ELECTRO-MAGNET.

You know what an electro-magnet is? It is a piece of iron that becomes a magnet only when it

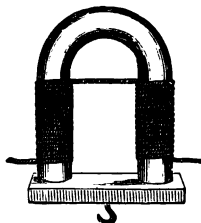

FIG. 144.—Electro magnet and keeper.

has what is called an electric current passing through an insulated wire surrounding it. As soon as the current is taken off, it is merely iron again, without any magnetic properties.

Get a rod of iron $\frac{1}{2}$ inch in thickness, and between 8 and 9 inches long. Heat the centre of rod to redness. Then by means of a hammer, beat it into the form of a horse-shoe, as in Fig. 144. If you cannot get to an anvil, you can work it on a block of iron, holding one end in a pair of tongs or pincers. If you cannot do it neatly, get it done for you. A smith will do it for a few pence; and if you stand and look on while he does it, you will get a lesson into the

bargain, and be the better able to try your skill on a second piece of iron. When the iron is quite cold—let it cool gradually—put it into a vice, and smooth off the ends with a file; use rather a coarse one at first, then a finer one, so that the ends are quite smooth. Then take about six yards of fairly thick covered copper wire—as thick as ordinary bell-wire—and wind it neatly round the legs of the magnet, keeping the wire always in the same direction, and the coils close together, as in Fig. 144, and tight to the rod. If you want a still stronger magnet, put a second coil over the first, keeping it in the same direction.

Twist the ends of the two wires on each leg together. To make it look neat, and to cement the layers of wire together, cover it over with a thick layer of philosopher's paint, mentioned in Chap. XII. The bare iron may be covered with the same, or with some enamel paint of another colour. The battery-wires are attached to the ends of the coil on the iron, and you will find you have a strong magnet by using two or three of your battery-cells. Refer to your Science book for a good series of experiments to try with this magnet.

HOW TO SOLDER TOGETHER WIRES AND FLAT METALLIC SURFACES.

We refer you to Chap. XI. The electro-magnet will be better for having a pair of binding-screws soldered on the ends of the wire; and the galvanometer will look neater if the wires from the coil which surrounds the needle passes directly through

the stand, and are soldered to the ends of a pair of binding-screws which pass through the board. Four little square blocks of wood glued at the under corners of the galvanometer-stand will give firmness, and also improve its appearance.

TO MAKE A KEEPER TO THE ELECTRO-MAGNET.

Get a piece of flat iron cut off long enough to extend just beyond the poles of your magnet. File it up so that the surface next the magnet is quite smooth and flat. Get a screw-hole drilled into the under side, and then put a hook into it, as in Fig. 144.

ELECTROTYPING.

Now you have a battery, you have a better chance of doing larger specimens of medals than in the apparatus described in the last chapter. Your battery and typing vessels are distinct. For small objects a jam-pot will do; for larger you get more room by making a rectangular box, which if lined and made water-tight will do very well. This can be done by painting the inside with philosopher's paint, taking care to put a large quantity of it along the joints, so there is no opening for the liquid to get out; or it may be lined with thin sheets of gutta-percha. Fill your trough with a strong solution of sulphate of copper. Pour in a small quantity of sulphuric acid, and tie up a few crystals of sulphate of copper in a muslin bag, and hang in the upper part of the trough just below the surface of the

liquid; or better still, put at one end a perforated shelf of a thick piece of gutta-percha, and put the crystals on this. Prepare your mould as directed in last chapter, with gutta-percha; attach a copper wire to the back of it. Do not forget to breathe on the face of the mould; then brush it over with some blacklead, not thickly. Bend the wire so that it comes just to the front at the top of the medal, so that it may touch the blacklead. Put it into the trough of solution. Opposite to the mould, but not touching it, put a plate of copper. This must be attached to a copper wire, and joined to the copper end of the battery, and the wire from the mould to the zinc end of the battery. If you are using one cell, leave it for two days; if you use two or three, somewhat less time will do, unless you require a very thick deposit. Before taking off the mould, remove the conducting-wire, and then lift it off by means of a thin penknife. The electrotype may afterwards be heated in a clear fire to redness, and then allowed to cool gradually; this will make it tough and workable. When cool, plunge it into a cold mixture of sulphuric acid and water. After being so immersed for a few minutes, take it out and rinse thoroughly in water; then dry it. You can then turn it up, and mount it in any way you desire. The back can be filled to give it solidity. This you can do by taking a stiff brush and rubbing the back over with a strong solution of ammonia chloride; then sprinkle over a little powdered resin. Then apply the blow-pipe to the solder; it will soon melt and run over the surface. If you wish for a full backing, pour into this some molten lead. Before mounting, polish up the face

of the medal with rotten stone and oil, and finish with rouge put on with a soft brush or the tip of the finger.

TO DO SILVER-PLATING.

We do not give you this on the score of cheapness for large articles, but plating on a small scale is a good experiment in electrolysis, which follows well on electrotyping.

You use the same battery for this experiment, and take a suitable trough for the immersion of the object to be plated. Of course the materials are somewhat more expensive; moreover they are poisonous; therefore keep them safely under your own care. Suppose you have a chain you wish to coat with silver. The substances required for the silvering bath are nitrate of silver and cyanide of potassium. Take a portion of each; dissolve them separately in distilled water, then mix them; when some of the silver will be precipitated, add some more cyanide of potassium, and the silver will be re-dissolved. Keep on adding the cyanide till nearly all the silver is re-dissolved, then stop. Let the solution stand till it gets clear, then pour it into a deep plate or glass vessel. Put in the chain to be coated, having previously attached a shilling to a piece of platinum wire and then to the copper end of the Daniell's battery. To the zinc end join another piece of platinum wire, and attach it to one end of the chain; drop them both into the basin containing the silver bath, but do not let them touch. The chain will soon be covered with silver, and when you

think it has sufficient, take it out, dry it, and polish with sifted whiting. If you intend to try your skill on larger objects, they must be immersed in a suitable bath, and suspended in front of a silver plate attached to the copper end of the battery. A series of articles can be done at the same time by suspending them from a metallic rod, which must be in connection with the zinc end of the battery. Fig. 145 shows a suitable arrangement of trough and battery for electro-plating small things.

All objects must be well cleansed before they are immersed in the silver bath. This is done by putting

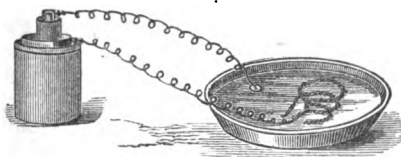

FIG. 145.—Battery and cell for electro-plating.

them in a hot solution of soda, to take off all possible grease. Then they must be brushed with pumice-stone, or bath brick very finely powdered; and last of all, they must be well rinsed in clean water.

TO MAKE A NEEDLE TELEGRAPH.

A needle telegraph is merely a galvanometer with the needles vertically arranged, and a key to reverse the electric current. You have already found out with your galvanometer that with a current of electricity—we use the words of your Science book here—going in one direction the needle moves from left to right; if the wires are reversed, the needle moves

from right to left. Instead of moving the wires, the key reverses the current. Now for the simplest way of making such an arrangement. Take the side of a cigar-box, smooth it, and see that the sides are parallel. Cut one into the shape of a small Gothic arch, as in Fig. 146. Take a piece of wood a trifle wider than the side of the box, and 6 inches long; hollow out a groove exactly large enough for it to

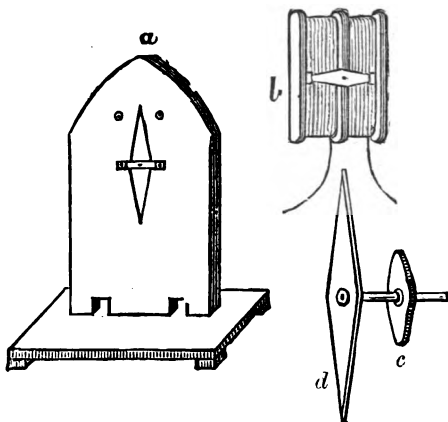

FIG. 146.—Separate parts for Needle Telegraph.
a. Dial and base; *b.* coil; *c.* needle for inside of coil;
d. pointer to swing on the face of the dial.

stand on end, as shown in Fig. 146, *a*. Put a square block at each corner; fix them with glue, and glue in the upright piece. While this is drying, make the coil of wire as in the galvanometer, but make it of thinner wire, winding it on a cardboard frame. Leave several inches of wire free at each end of the coil. This bobbin we show at *b*, Fig. 146. Then fix the coil on the back of the dial, as we will

now call the upright piece. Now prepare a magnetic needle to swing within the coil, as in the galvanometer. This time, however, you must drill a hole through the centre, which you can do when it is hot and soft, and fasten it to a wire passing through it. This you can do with a little sealing-wax; put it on neatly. The wire must be long enough to pass through the dial in front and the coil behind. Bore a hole in the dial exactly opposite to one in a slip of wood that is to be fastened at the back of the coil. In these holes put a short length of fine glass tubing, so that the axis of the needle can

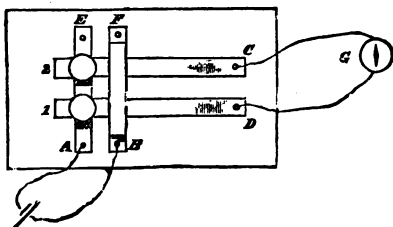

FIG. 147.—Plan of keys for reverse current.

vibrate with as little friction as possible. Fasten a stop of some kind on the wire carrying the needle, so that it does not easily slip out. To the end of the wire coming through the face of the dial, a pointer, cut in the shape of the needle, must be fixed, so that when the needle in the coil moves, the front one moves with it, and with similar movements—this is the pointer. Above the centre of the needle in front put in two stops, either of wire or wood, so that the needle can only vibrate through a limited arc, as shown in Fig. 146. Before going any further, see that the needle in the coil moves freely, and that

key-board by screws passing through *B* and *F*. A second strip of brass must be screwed flat to the board along *A*, *E*, in front and parallel to *B*, *F*. Attach some wooden or ivory knobs on the springs, immediately over the strip *A*, *E*. These are for pressing down the spring into contact with *A*, *E*. When released they fly back to *B*, *F*. Now look carefully through the whole arrangement, and see you have got your key-board properly laid out, the brass strips and springs properly fitted. At the ends *C*, *D* of the springs, fasten two binding-screws; do the same at *A*, *B*. Now bring the wires down from the galvanometer, and attach them to the screws, *C*, *D*, and put the wires from the battery on at *A*, *B*. By pressing down one key you will find the battery current will make the needle turn in one direction; by pressing down the other, the needle will turn in the opposite direction. If you have followed out our instructions you will have an instrument that will enable you to go through the telegraphic alphabet. The signals for each letter should be marked carefully on a sheet of writing-paper or cardboard, and pasted on the dial-board at the back of the needle. With a pair of such instruments you can send messages from one room to another, or from house to house; but your friend who has to receive the message must be able to read the signs the needle makes. You must remember that when your needle turns to the right or left, the needle of the second instrument will do the same if you have joined up the wires correctly. Fig. 148 shows how the battery is to be joined to the instrument—the needle of the instrument being marked "*a*." Now for the scientific working of the

models we must refer you to your book on Electricity. This will also give you a copy of the dial, with directions as to how many motions a needle must

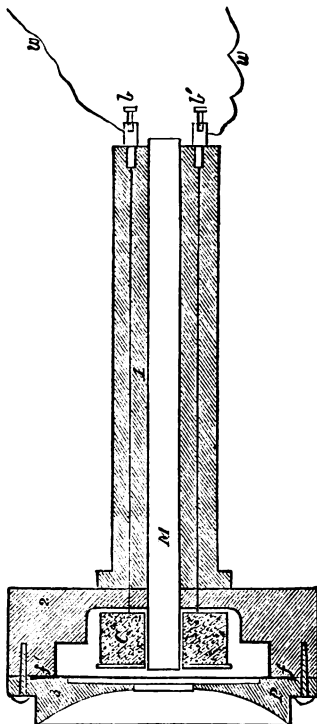

FIG. 149.—Section of the Telephone.

m. The magnet; *c.* the bobbins of wire; *f.* the thin plate held by mouthpiece; *b.* binding-screws attached to line wires.

make to right or left for the formation of a letter. You will find two Daniell's cells enough for a pair of instruments of this kind.

If you think it worth while to make a double-

needle instrument, it simply means the mounting of two galvanometers on one board, the other arrangements being the same. In this matter also your science book will help you. Learn from it the theory thoroughly, then the practical will become so much easier and more interesting.

THE TELEPHONE.

You must have a pair of telephones if you require to do anything at all with them. They do not present so many difficulties as the telegraph.

Each requires a magnet—these you had better buy. Get two bar-magnets, each about 4 inches long, which will cost you from 1s. to 1s. 6d. To test the strength of the magnets, see that one is capable of sustaining the other, when the marked end of one is presented to the unmarked end of the other. Now you want two wooden cases for the magnets. The best way will be to cut two lengths off a good straight broom-handle. Cut them off at first a trifle longer than the magnets themselves; then split them very carefully down the centre with a chisel. Next cut a channel along the centre of each of the halves, so that when the pieces are put together again they fit closely, and there is room for the magnets to slip backwards and forwards, not too loosely, but just comfortably.

Now glue together the pieces, and you will have two hollow cylinders through which the magnets can pass. Now you want a small bobbin to fit closely the end of the magnets. This you can make for yourself out of stout cardboard; or you can buy two

of the small pulleys used by the Venetian blind-maker. Wind each with about half an ounce of silk-covered wire, No. 36. This number refers to size, so that if you ask for this at an electrician's, he will know what to give you. Moreover, if you tell him for what you require it, he will also supply you with bobbins and magnets as well. You must next have a wider cylinder for the mouthpiece of your telephone. It must be hollowed out, so that it will contain the bobbin. You can sometimes get wooden tooth-powder boxes that will suit for this purpose. If not, take a short length of a thick window-pole; and after hollowing it out, like the inside of a box, you can fit it, as shown in Fig. 149. Wind the wire on the bobbins; leave the two ends of each free. Then in front of the box fix a piece of very thin sheet-iron; that used by photographers for ferrotypes is best. Keep it quite smooth, and cut off a portion large enough to cover the mouth-piece. Now put on the lid, after cutting out a circular portion in the top of the lid about the size of a sixpence. Then put it on so that it holds the iron plate in position. Push up the magnet to about $\frac{1}{8}$ of an inch from the plate; fasten it there either by plugging it, or by putting a short screw in at the side so it grasps the magnet and holds it firmly. Now bore two small holes at the back of the box, through which bring the ends of the wires from the inside coil. Attach the wires to two binding-screws, the stems of which can be screwed into the box. Cut off the cylinder which holds the magnets to about $\frac{1}{4}$ inch longer than the magnets themselves. Fill up the holes with plugs of cork.

Cut them off neatly, then screw or glue on the lid, keeping the centre opening in front, so that the edge of the opening nearly touches the ferrotype disc. At an electrician's you can get all the parts ready to put together for telephone-making. You may prefer this plan; it makes the method of providing the cylinders easy, and at the same time ensures perhaps a neater pair of instruments than you can make without this aid. Read up from your book the whole science of this instrument; then you will not be likely to make any mistakes in its construction.

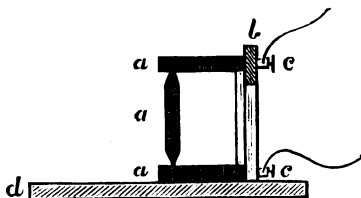

FIG. 150.—A Simple Microphone.

a. Carbon blocks and pencil; *b.* upright support; *c.* battery screws; *d.* base of instrument.

In Fig. 149 we show the various parts of this instrument. To increase the loudness of the sound a microphone is frequently introduced with the telephone. It is so easily made that we will here give directions for doing so. At the electrician's, secure two blocks of carbon, such as is used for batteries; about a cubic inch of each. Bore two holes through them, and secure at the same time two binding-screws with long stems. Have a small pencil of charcoal, such as is used for electric lighting. Cut off about 4 inches; point both ends of this by rubbing down with a file as you would in sharpening a lead

pencil. In two sides of the blocks make hollows by boring with a rat-tailed file, so that the pencil-piece can rest lightly in these hollows, and be supported by the blocks. Screw the blocks to a board, at such a distance that the pencil is supported, as in Fig. 150; the telephone may be used with it by joining the battery wire from a telephone to one of the screws *c*, and from the screw *c* join a wire to the second telephone screw. Then the microphone, telephone, and battery will all be in the "same circuit."

By reading carefully descriptions of scientific instruments from your books, you may be able from the instructions we have given in this chapter to make several others, and in the statical electricity department still more.

We only need name the gold-leaf electroscope, the electrophorus, various conductors and insulators, carrier ball, pith-ball electroscope, and other arrangements which are so well described in various text-books on electricity, that we need give no detailed description of them. Having gained some proficiency in these, you may at last be able to manage to make a Wimshurst and other forms of electrical machines.

GLOSSARY

EXPLAINING THE TERMS USED IN THE TEXT.

architrave—an ornamental top moulding.

bevel, a—an oblique or rounded edge.

bevel, to—to take off the right-angled edge.

brads—small sharp nails, without heads, sometimes called "sprigs."

buckling—a sharp bend, that cannot be taken out, and where the bend repeats itself when the saw is used.

carpenter's square—a square set at right angles. (See page 11.)

dove-tail—a joint shaped regularly, so that the mortise and tenon are of inverted wedge shape. (See page 55.) The projecting part is called the tenon or pin, the sunken portion the socket or mortise.

dove-tail saw—a saw with a short broad blade strengthened at the back, used for cutting tenons, and such like.

dowels—wooden pins used in joining.

eyelet—a small metallic shape to sink into a wooden hollow of same shape, as a keyhole.

face-planing—to plane smoothly a broad surface of wood.

halving—to cut two pieces of wood to half their thickness, so that when they make a joint the two together are no thicker than one piece. This is sometimes called "housing."

jamb—the upright sides of door-frames.

keyhole saw—sometimes called the compass saw; it has a very narrow blade, and from 10 to 12 teeth per inch. It is used for cutting small holes like keyholes.

lugs—brass or iron plates attached to objects, and used for suspension flat to a wall.

mitreing—making a joint with two pieces of wood, each end of which is cut at an angle of 45°.

mortice, or mortise—a socket shaped to receive a tongue or tenon of wood.

mortised—a joint made by a mortice.

moulding—a uniform edge of regular shape made with a plane whose iron edge contains the pattern.

quartering—any length of wood with square ends measuring from 2" x 2" up to 6" x 6".

- rebate*—a hollow or sunken rectangular edge to a piece of wood, like the inner edge of a panel or picture-frame. (See page 129.)
- rebate plane*—a narrow plane for cutting rebates; in this tool the plane-iron is as broad as the sole.
- scantling*—a term applied to timber of given breadth and thickness.
- scraper*—a piece of thin steel usually with a straight edge, but it may have a curved edge. It is used to take down roughnesses of wood at finishing off, and should be used along and not across the fibres.
- scriber*—a marking-point of tapering steel something like a bradawl, to mark fine lines on work, to set measures.
- shooting*—To plane the end of a piece of wood by means of the shooting-board.
- stencilling*—to transfer a pattern by means of a plate in which the pattern is already cut, so that in repeating it, it is an exact copy of the first. The plates in which the patterns are cut are called stencil-plates.
- tenon*—(see dove-tail).
- tenon-saw*—(see page 41).
- trying-plane*—the longest and most useful plane in use. It is employed for smoothing large surfaces, for long edges, and for "shooting."

INDEX OF ILLUSTRATIONS.

FIG.	PAGE
1. Hand-saw	10
2. Paring-chisel	10
3. Carpenter's Square	11
4. Jack-plane	13
5. Smoothing-plane	14
6. Marking-Gauge	14
7. Supports for the tray of tool-box	20
8. Plan of tray, with divisions	20
9. Gouge	21
10. Gimlet	21
11. The tool-box complete	23
12. How to sharpen a Plane-iron	24
13. Oilstone, box and cover	25
14. Stilts, showing foot-plates and uprights	26
15. Set of shelves, side and front	29
16. Book-shelves with cupboard	36
17. Glass case to stand on shelves	37
18. Tenon or Back-saw	41
19. Marking half-lap or corner-joint	41
19a. Sawing " "	41
20. Bench-screw	42
21. Fitting half-lap joint	43
22. Finished " "	43
23. Sawn portions of Bearing-joint	44
24. Fitting Bearing-joint	44
25. Finished " "	44
26. Marking and sawing "Bald-faced" joint, with "Tred- gold" notch	45
27. Fitting "Bald-faced" joint	46
28. Finished " "	46
29. Marking and sawing "halving tenon-joint"	47
30. Fitting "halving tenon-joint"	47
31. Finished " "	47
32. Marking and grooving tongue-joint	48
33. Fitting tongue-joint	48
34. Finished " "	49

FIG.	PAGE
35. Tenon and mortise joint	49
36. " " parts ready for fitting	50
37. " " fitted	50
38. Mortise chisel and mallet	51
39. Double tenon and mortise joint	52
40. " " ready for fitting	53
41. " " finished	53
42. Joint for lengthening beam, called "scarfing joint"	54
43. Dove-tailed joint	55
44. " " made ready for fitting	56
45. " " fitted	56
46. Garden edging	59
47. Parts of swing	61
48. Swing complete	62
49. Lean-to summer-house	65
50. Screw-drivers	67
51. Summer-house table (parts)	68
51 α , δ . Designs for Rustic Summer-house	70
52. Spars joined by "angle-iron"	72
53. Rustic summer-house corner joined with half-lap joint and long nail	73
54. Frame of roof for rustic house	74
55. Plan of corner of rustic house	75
56. Frame-work of Out-house	76
57. Joints employed in building Out-house	77
58. To show arrangement of nest-boxes and slip-doors for poultry houses	78
59. Hutch for rabbits or coop for chickens	79
60. Pigeon house	80
61. Hen-coop	81
62. Dog kennel	81
63. Carpenter's stool	82
64. Set of steps	83
65. Ledged door	85
66. Trellis work for fencing	86
67. Palings—wood	87
68. Tongued and grooved joint for small work	90
69. Wheelbarrow, parts, for model	91
70. Spokeshave	92
71. Bench-vice	93
72. Parts of model waggon	95
73. Music-stand—frame and stand	99
74. Rustic front to window-box	101
75. Pen-tray, with stencilled pattern	104
76. Paper-knife	105
77. Parts of book-slide	106
78. Flower-pot stand	108
79. Sides and top of bracket	109
80. Open bracket for two shelves	110
81. Open bracket for three shelves	110
82. End for book-slide	115
83. Handle of paper-knife (carved)	117

FIG.	PAGE
84. Carved end of book-slide	117
85. Design for carved frame	118
86. " " " "	118
87. Simple inlaid patterns	119
88. Carved fretwork bracket	121
89. Plan of mitre-box	124
90. Mitre-board in plan and section	125
91. Shooting-board and trying plane	126
92. Blocks for picture-frame fixing	129
93. Moulding used for picture-frames	130
94. Bookbinding	134
95. " " back and cover	136
96. Model of lighthouse	142
97. Elevation of the Tubular bridge	144
98. Britannia Tower	145
98 <i>a</i> . Land Tower	146
98 <i>b</i> . Abutment Tower	147
99. Hull of yacht	151
100. Side elevation	151
101. Rudder	153
102. Stocks for yacht	154
103. How topmast is fitted to mainmast	155
104. Main-boom	157
105. Dead-eyes	158
105 <i>a</i> . Block for running-rigging	158
106. Diagram of cutter yacht	160
107. Cutting pliers	167
108. Round-nosed pliers	168
109. Nipping pliers	168
110. Simple scroll	170
111. Single iron bracket	170
112. Light iron brackets	171
113. Light iron ornamental brackets	172
114. Design for candlestick	173
115. Design for candle bracket	173
116. Design for flower-stand	175
117. Ornamental flower-stand	175
118. Suspended hall lamp	176
119. Kettle and lamp-stand	176
120. Bracket support for lamp	177
121. Suspension for lamp	178
122. Design for fire-screen in light iron work	179
123. Repoussé work—exercise in straight lines	181
124. Exercise in curves and straight lines	181
125. Simple design for a pin-tray	182
126. Embossing ends of punches	182
127. Simple design for tray with embossed leaf	183
128. Exercise in fruit and leaves	184
129. Wire basket	185
130. Apparatus for preparing oxygen gas	192
131. Set of cork-borers	193
132. Florence flask and tube	195

FIG.	PAGE
133. Apparatus for hydrogen or carbonic acid gas ...	196
134. Wash-bottle	198
135. Apparatus for making hydrogen sulphide ...	200
136. Jet for hydrogen flame	200
137. Set of U tubes, fitted	201
138. Glass tubes, and platinum wire	202
139. Simple arrangement for electrotyping ...	211
140. Daniell's cell	216
141. Circular card for galvanometer	218
142. Insulated coil for galvanometer	218
143. Galvanometer complete	219
144. Electro-magnet and keeper	220
145. Battery and cell for electro-plating	225
146. Separate parts for needle telegraph	226
147. Plan of keys for reversing current	227
148. Key-board connected with battery and coil to show how the needle is moved	228
149. Section of the telephone	230
150. Simple microphone	233

In the drawings for our illustrations we must acknowledge the great help we derived from Messrs. Cassell's *Sports and Pastimes*, and Messrs. Spon's *Mechanic's Own Book*.



PUBLICATIONS

OF THE

Society for Promoting Christian Knowledge.



	<i>s.</i>	<i>d.</i>
A LITTLE CAPTIVE MAID. With Three page Illustrations. Crown 8vo. <i>Cloth boards</i>	1	6
A NEW BEGINNING. By HELEN SHIPTON, author of "Christopher," etc. With numerous Illustrations. Crown 8vo. <i>Cloth boards</i>	2	0
A PROMISING BOY. By ANNETTE LYSTER. With Three page Illustrations. Crown 8vo. <i>Cloth boards</i>	2	6
ABBOTSNID. By C. E. M., author of "Adam Gorlake's Will," "The Valley Mill," etc. With Four page Illustrations. Crown 8vo. <i>Cloth boards</i>	3	0
ADVENTUROUS VOYAGE OF THE "POLLY," and other Yarns, By the late S. W. SADLER, R.N. With Four page Illus- trations. Crown 8vo. <i>Cloth boards</i>	3	0
ALL IS LOST SAVE HONOUR. A Story of To-day. By CATHERINE M. PHILLIMORE. With Three page Illus- trations. Crown 8vo. <i>Cloth boards</i>	1	6
▲		[Crown 8vo.

PUBLICATIONS OF THE SOCIETY.

ALONE AMONG THE ZULUS. By a PLAIN WOMAN, The Narrative of a Journey through the Zulu Country. With Four page Illustrations. Crown 8vo.	<i>Cloth boards</i>	1	6
AN INNOCENT. By S. M. SITWELL. With Three page Illustrations. Crown 8vo.	<i>Cloth boards</i>	1	6
AN IDLE FARTHING. By ESMÉ STUART. With Three page Illustrations. Crown 8vo.	<i>Cloth boards</i>	2	6
ANDREW GARTH'S APPRENTICES. By F. SCARLETT POTTER. With Three page Illustrations. Crown 8vo.	<i>Cloth boards</i>	1	6
BARON'S HEAD (THE). By FRANCES VYVIAN. With Three page Illustrations. Crown 8vo.	<i>Cloth boards</i>	2	6
BEHIND THE CLOUDS. A Story of Village Life. By GRACE HAMILTON. With Three page Illustrations. Crown 8vo.	<i>Cloth boards</i>	1	6
BELFRY OF ST. JUDE (THE). A Story. By ESMÉ STUART, author of "Mimi." With Three page Illustrations. Crown 8vo.	<i>Cloth boards</i>	2	6
BERNARD HAMILTON, CURATE OF STOWE. By MARY E. SHIPLEY. With Four page Illustrations. Crown 8vo.	<i>Cloth boards</i>	3	6
BROTHERHOOD; or, In the Way of Temptation. With Three page Illustrations. Crown 8vo.	<i>Cloth boards</i>	2	0
CHRYSSIE'S HERO. By ANNETTE LYSTER, author of "Fan's Silken String." With Three page Illustrations. Crown 8vo.	<i>Cloth boards</i>	2	6
CICELY'S MISTAKE. The Story of a Lost Treasure. By A. EUBULE EVANS. With Three page Illustrations. Crown 8vo.	<i>Cloth boards</i>	2	0
CROWN AND SCEPTRE. A West Country Story. By G. MANVILLE FENN. With Five page Illustrations. Crown 8vo.	<i>Cloth boards</i>	5	0
CRUISE OF THE "DAINTY" (THE); or, Rovings in the Pacific. By the late W. H. G. KINGSTON. With Three page Illustrations. Crown 8vo.	<i>Cloth boards</i>	1	6

PUBLICATIONS OF THE SOCIETY.

3

2. 2.

BODO; AN UGLY LITTLE BOY; or, Handsome is that Handsome does. By E. EVERETT GREEN. With Three page Illustrations. Crown 8vo.....*Cloth boards* 2 6

ENGEL THE FEARLESS. By ELIZABETH H. MITCHELL. With Four page Illustrations. Crown 8vo.....*Cloth boards* 3 6

FIRE-FLIES AND MOSQUITOES. By F. FRANKFORT MOORE. With Four page Illustrations. Crown 8vo.....*Cloth boards* 3 6

FORTUNES OF HASSAN (THE). Being the strange story of a Turkish Refugee, as told by himself. By the author of "Our Valley," "Rosebuds." With Three page Illustrations. Crown 8vo.*Cloth boards* 2 6

GIL THE GUNNER; or, The Youngest Officer in the East. By G. MANVILLE FENN. With Five page Illustrations. Crown 8vo.*Cloth boards* 5 0

GREAT CAPTAIN (THE). An Eventful Chapter in Spanish History. By ULICK R. BURKE, M.A. With Two page Illustrations. Crown 8vo.*Cloth boards* 2 0

HASSELAERS (THE): a Tale of Courage and Endurance. By E. E. COOPER. With Three page Illustrations. Crown 8vo.....*Cloth boards* 1 6

INVASION OF IVYLANDS (THE). By ANNETTE LYSTER, author of "Fan's Silken String." With Three page Illustrations. Crown 8vo.....*Cloth boards* 1 6

KING'S WARRANT (THE). A Tale of Old and New France. By A. H. ENGELBACH. With Three page Illustrations. Crown 8vo.*Cloth boards* 2 6

LETTICE. By Mrs. MOLESWORTH, author of "Carrots." With Three page Illustrations. Crown 8vo.*Cloth boards* 2 0

LITTLE BROWN GIRL (THE). A Story for children. By ESMÉ STUART, author of "Mimi," etc. With Three page Illustrations. Crown 8vo.....*Cloth boards* 2 6

MASS' GEORGE; or, A Boy's Adventures in the Old Savannahs. By G. MANVILLE FENN. With Five page Illustrations. Crown 8vo.....*Cloth boards* 5 0

- LATE OF THE "LILY" (THE);** or, Notes from Harry Musgrave's Log Book. By the late W. H. G. KINGSTON. With Three page Illustrations. Crown 8vo... *Cloth boards* 1 6
- MIKE.** A Tale of the Great Irish Famine. By the Rev. E. N. HOARE, M.A., author of "Between the Locks." With Three page Illustrations. Crown 8vo. ... *Cloth boards* 1 6
- MIMI.** A Story of Peasant Life in Normandy. By ESMÉ STUART, author of "The Little Brown Girl." With Three page Illustrations. Crown 8vo. *Cloth boards* 2 6
- MRS. DOBBS' DULL BOY.** By ANNETTE LYSTER, author of "Northwind and Sunshine," etc. With Three page Illustrations. Crown 8vo. *Cloth boards* 2 6
- MY LONELY LASSIE.** By ANNETTE LYSTER, author of "Mrs. Dobbs' Dull Boy." With Three page Illustrations. Crown 8vo. *Cloth boards* 2 6
- PERCY TREVOR'S TRAINING.** By the Rev. E. N. HOARE, M.A., author of "Two Voyages," etc. With Three page Illustrations. Crown 8vo. *Cloth boards* 2 6
- PHILIP VANDELEUR'S VICTORY.** By C. H. EDEN, author of "Australia's Heroes," "The Fifth Continent," etc. With Three page Illustrations. Crown 8vo. ... *Cloth boards* 2 6
- PILLARS OF SUCCESS (THE).** By CRONA TEMPLE, author of "Griffinhoof," etc. With Three page Illustrations. Crown 8vo. *Cloth boards* 2 6
- RICK BALTON'S RECONCILIATION.** By the Rev. E. N. HOARE. With Four page Illustrations. Crown 8vo. *Cloth bds.* 3 6
- ROUND MY TABLE.** By H. L. CHILDE-PEMBERTON, author of "The Topmost Bough," etc. With Three page Illustrations. Crown 8vo. *Cloth boards* 1 6
- SAILING AND SEALING.** A Tale of the North Pacific. By F. FRANKFORT MOORE. With Four page Illustrations. Crown 8vo. *Cloth boards* 3 6
- SETTLERS (THE):** A Tale of Virginia. By the late W. H. G. KINGSTON. With several Illustrations. Crown 8vo. *Cloth boards* 2 6

PUBLICATIONS OF THE SOCIETY. 5

SLAVER OF ZANZIBAR (THE). By F. FRANKFORT MOORE. With Four page Illustrations. Crown 8vo. <i>Cloth boards</i>	s. d. 3 0
SLAVERS AND CRUISERS. A Tale of the West Coast. By the late S. W. SADLER, R.N. With Four page Illustrations. Crown 8vo..... <i>Cloth boards</i>	3 6
STORIES FROM ITALIAN HISTORY. By the late B. MONTGOMERIE RANKING. With Two page Illustrations. Crown 8vo..... <i>Cloth boards</i>	1 6
STEPMOTHER'S WILL (THE); or, a Tale of Two Brothers. By A. EUBULE-EVANS, author of "Reclaimed." With numerous Illustrations. Crown 8vo. <i>Cloth boards</i>	2 6
SWEET WILLIAM. By Mrs. THOMAS ERSKINE. With Three page Illustrations. Crown 8vo..... <i>Cloth boards</i>	1 6
THROUGH THE ROUGH WIND. A Story of the Collieries. By CRONA TEMPLE, author of "Etta's Fairies," etc. With Three page Illustrations. Crown 8vo..... <i>Cloth boards</i>	1 6
TIM YARDLEY'S YEAR. A Book for Country Boys. By F. SCARLETT POTTER. With Three page Illustrations. Crown 8vo. <i>Cloth boards</i>	1 6
TO THE WEST. By G. MANVILLE FENN. With Five page Illustrations. Crown 8vo..... <i>Cloth boards</i>	5 0
TWO SHIPMATES (THE). By the late W. H. G. KINGSTON, author of "Ned Garth." With Three page Illustrations. Crown 8vo..... <i>Cloth boards</i>	1 6
UNA CRICHTON. By the author of "Our Valley," etc. With Four page Illustrations. Crown 8vo. <i>Cloth boards</i>	3 6
UNSETTLED FOR LIFE; or, What shall I be? By the Rev. HARRY JONES, M.A. Crown 8vo. <i>Cloth boards</i>	2 6
WILL'S VOYAGES. By F. FRANKFORT MOORE, author of "The Fate of the <i>Black Swan</i> ." With Four page Illustrations. Crown 8vo..... <i>Cloth boards</i>	3 6

THE PEOPLE'S LIBRARY.

Crown 8vo, Cloth boards, One Shilling each.

A CHAPTER OF SCIENCE; or, What is a Law of Nature? Six Lectures to Working Men. By Professor J. STUART, M.P.

[A series of lectures in which the meaning of a "Law of Nature" is explained, and the great principles of science sketched out in a simple and lucid manner. For thoughtful workmen.]

A SIX MONTHS' FRIEND. By HELEN SHIPTON, author of "Christopher." With several Illustrations.

[A story exhibiting the influence of religion upon rugged natures.]

BIOGRAPHIES OF WORKING MEN. By GRANT ALLEN, B.A.

[Meant to encourage industry, temperance, and perseverance by the examples furnished by the lives of successful working men.]

FACTORS IN LIFE. Three Lectures on Health, Food, Education. By Professor SEELEY.

[A work that cannot fail to enlighten the reader on points of supreme temporal importance.]

HOPS AND HOP-PICKERS. By the Rev. J. Y. STRATTON. With several Woodcuts.

[An interesting account of hops and of life among the hop-pickers.]

HOUSEHOLD HEALTH. By Sir B. W. RICHARDSON, M.D., F.R.S. A Sequel to "The Guild of Good Life."

[Deals with sanitary matters from the standpoint of the home.]

LIFE AND WORK AMONG THE NAVVIES. By the Rev. D. W. BARRETT, M.A., Vicar of Nassington. With several Illustrations.

[This work furnishes an interesting and accurate account of navy life.]

THE BRITISH CITIZEN: His Rights and Privileges. A short history. By the late J. THOROLD ROGERS.

[Traces the development of the liberties of the British citizen. For general circulation.]

THE COTTAGE NEXT DOOR. By HELEN SHIPTON. With several Woodcuts.

[A story of the education of two rough natures through strife and suffering.]

THE GUILD OF GOOD LIFE: A Narrative of Domestic Health and Economy. By Sir BENJAMIN W. RICHARDSON, M.D., F.R.S.

[Meant to draw the attention of the people to the importance of a knowledge of the laws of health, and the principles of domestic economy.]

THRIFT AND INDEPENDENCE: A Word for Working Men. By the Rev. W. LEWERY BLACKLEY, M.A.

[Shows the necessity and advantage of thrift. For general circulation.]

THE PENNY LIBRARY OF FICTION.

Each Story is complete in itself, and consists of 32 pages, demy 8vo, double columns ; with pictorial wrapper, price 1d.

By G. MANVILLE FENN.
IN MARINE ARMOUR.
IN MID-AIR.
LORD JOHN,
STAUNCH.

HIS OLD CHUM'S SON.
THE MUTINY OF THE
"HELEN GRAY."

By S. BARING GOULD.
FIFTEEN POUNDS.
GOLDEN FEATHER.
THE TWO JOHN BRENTS.

By B. L. FARJEON.
THREE TIMES TRIED.
THE DEATH TRANCE.

By G. A. HENTY.
THE PLAGUE SHIP.
THE RANCHE IN THE
VALLEY.

By L. B. WALFORD.
THE JERRY BUILDER.
THE LITTLE ELEVENPENCE
HALFPENNY.
THE LAST STRAW.

By C. PHILLIPPS-WOLLEY.
MY SOLDIER KEEPER.

By J. MACLAREN COBBAN.
BY TELEGRAPH.

By the author of "Victa Victrix."
SLIPPING AWAY.

By HELEN SHIPTON.
SAVED BY THE SKIN OF
HIS TEETH.

By Mrs. HENRY CLARKE, M.A.
SAVED FROM HIMSELF.

By Mrs. NEWMAN
BROUGHT TO LIGHT.

By Mrs. J. H. RIDDELL.
FOR DICK'S SAKE.

By KATHARINE S. MACQUOID.
GONE.

By JESSIE M. E. SAXBY.
"CONSTABLE A1."

By F. M. HOLMES.
THE SILENT SHIP.

By R. M. BALLANTYNE.
REUBEN'S LUCK.

A TERRIBLE INHERITANCE.
THE SOLE TRUSTEE.
A LIVING APPARITION.

PUBLICATIONS BY THE LATE MRS. EWING.

- SNAPDRAGONS: A Tale of Christmas Eve, and OLD FATHER CHRISTMAS.** Illustrated by GORDON BROWNE. Small 4to. *Paper boards* 1 0
- BROTHERS OF PITY, and other Tales of Beasts and Men.** Crown 8vo. With numerous Illustrations *Cloth boards* 2 6
- DADDY DARWIN'S DOVECOT: A Country Tale.** With numerous Illustrations by the late R. CALDECOTT. Small 4to. *Paper boards* 1 0
- DANDELION CLOCKS, and other Tales.** With Illustrations by GORDON BROWNE and other artists. 4to. *Paper boards* 1 0
- JACKANAPES.** With seventeen Illustrations by the late R. CALDECOTT. Small 4to. *Cloth boards* 1 0
- LOB LIE-BY-THE FIRE; or, The Luck of Lingborough.** Illustrated by the late RANDOLPH CALDECOTT. Small 4to. *Paper boards* 1 0
- OLD-FASHIONED FAIRY TALES.** Fcap. 4to. With numerous Woodcuts *Cloth boards* 3 6
- MARY'S MEADOW.** With Illustrations by GORDON BROWNE. Small 4to. *Paper boards* 1 0
- THE PEACE EGG, AND A CHRISTMAS MUMMING PLAY.** Illustrated by GORDON BROWNE. 4to. *Paper boards* 1 0
- THE STORY OF A SHORT LIFE.** With Illustrations by GORDON BROWNE. Small 4to. *Paper boards* 1 0
- VERSE-BOOKS FOR CHILDREN.** Illustrated by ANDRÉ. Printed in Colours. Small 4to. *Ornamental paper boards, in 3 vols.* *Each* 3 0
- LIBRARY EDITION of "JACKANAPES," "DADDY DARWIN'S DOVECOT," and "LOB LIE-BY-THE-FIRE."** In one volume. Small 4to. *Cloth boards* 5 0
- JULIANA HORATIA EWING AND HER BOOKS.** By HORATIA K. F. GATTY. With a Portrait by GEORGE REID, R.S.A. Illustrated by facsimiles from Mrs. EWING'S Sketches, and a Cover designed by the late RANDOLPH CALDECOTT. Small 4to. *Paper boards* 1 0

LONDON: NORTHUMBERLAND AVENUE, W.C.;
43, QUEEN VICTORIA STREET, E.C.

11



