

TABLE OF CONTENTS

	para.	page
CHAPTER 1. DESCRIPTION, AUTOMATIC PISTOL CAL.		
.45, M1911 AND M1911A1	1-2	3
CHAPTER 2. MECHANICAL TRAINING, PISTOL		
Section I. Disassembly and Assembly	3-8	9
II. Functioning	9	16
III. Loading, Firing, and Unloading	10-13	21
IV. Malfunctions, Stoppages, and Immediate Action	14-24	22
V. Accessories		30
VI. Ammunition	25-30	30
CHAPTER 3. MANUAL OF ARMS FOR THE PISTOL	31-33	34
CHAPTER 4. MARKSMANSHIP TRAINING, PISTOL		
Section I. General	34-36	36
II. Preparatory Marksmanship Training	37-41	36
Supplement "A", Suggested Firing Courses		40
CHAPTER 5. INSPECTION, DETAIL DISASSEMBLY, REPAIR AND REPLACEMENT, PISTOLS		
Section I. Inspection Prior to Disassembly	42-45	49
II. Detail Disassembly	46-47	58
III. Inspection After Complete Disassembly.	48	70
IV. Repair and Replacement	49-51	75
V. Reassembly	52-54	76
VI. Effects and Probable Causes of Accidents and Malfunctions	55	81
Supplement "B" Tools, Gauges and Fixtures (Pistols M1911 and M1911A1).	56-57	86

PART ONE — AUTOMATIC PISTOLS
CHAPTER ONE — DESCRIPTION
SECTION 1
GENERAL CHARACTERISTICS-
AUTOMATIC PISTOL CAL. 45, M1911 AND M1911A1

1. DESCRIPTION.

a. The Automatic Pistols, Cal. .45, M1911 and M1911A1, are recoil-operated, magazine-fed, self-loading hand weapons (figs. 1, 2, and 3). The gas generated from a cartridge fired in either pistol is utilized to extract and eject the empty cartridge case, cock the hammer, and force the slide to the rearmost position, thereby compressing the recoil spring. The action of the recoil spring forces the slide forward. This feeds a live cartridge from the magazine into the chamber leaving the weapon ready to fire again.

b. The M1911A1 Pistol is a modification of the M1911 Pistol, (figs. 2 and 4) but its operation is exactly the same and the differences do not affect the maintenance. In the model M1911A1 the differences are:

(1) The tang of the grip safety is extended to provide better protection for the hand.

(2) A clearance cut is made on the receiver for the trigger finger.

(3) The face of the trigger is cut back and knurled.

(4) The mainspring housing is raised in the form of a curve to fit the palm of the hand and is knurled.

(5) The top of the front sight is widened, rear notch widened .

c. The pistol is designed to fire **CARTRIDGE**, ball, Cal. .45, M1911. The magazine holds seven cartridges. The upper cartridge is stripped from the magazine and forced into the chamber by the forward motion of the slide. The pistol fires once at each squeeze of the trigger. When the last cartridge in the magazine has been fired, the slide remains open. The magazine catch is then depressed and the magazine is forced out by the magazine spring. The rate of fire is limited only by the ability of the operator to insert magazines and to squeeze the trigger .

2. GENERAL DATA.

a. Characteristics.

Barrel.

Caliber of bore	0.45 in.
Number of grooves	6 in.
Twist in rifling, uniform L. H., (one turn)	16 in.
Length of barrel	5.03 in.



Figure 1 — Right Side of Pistol M1911A1

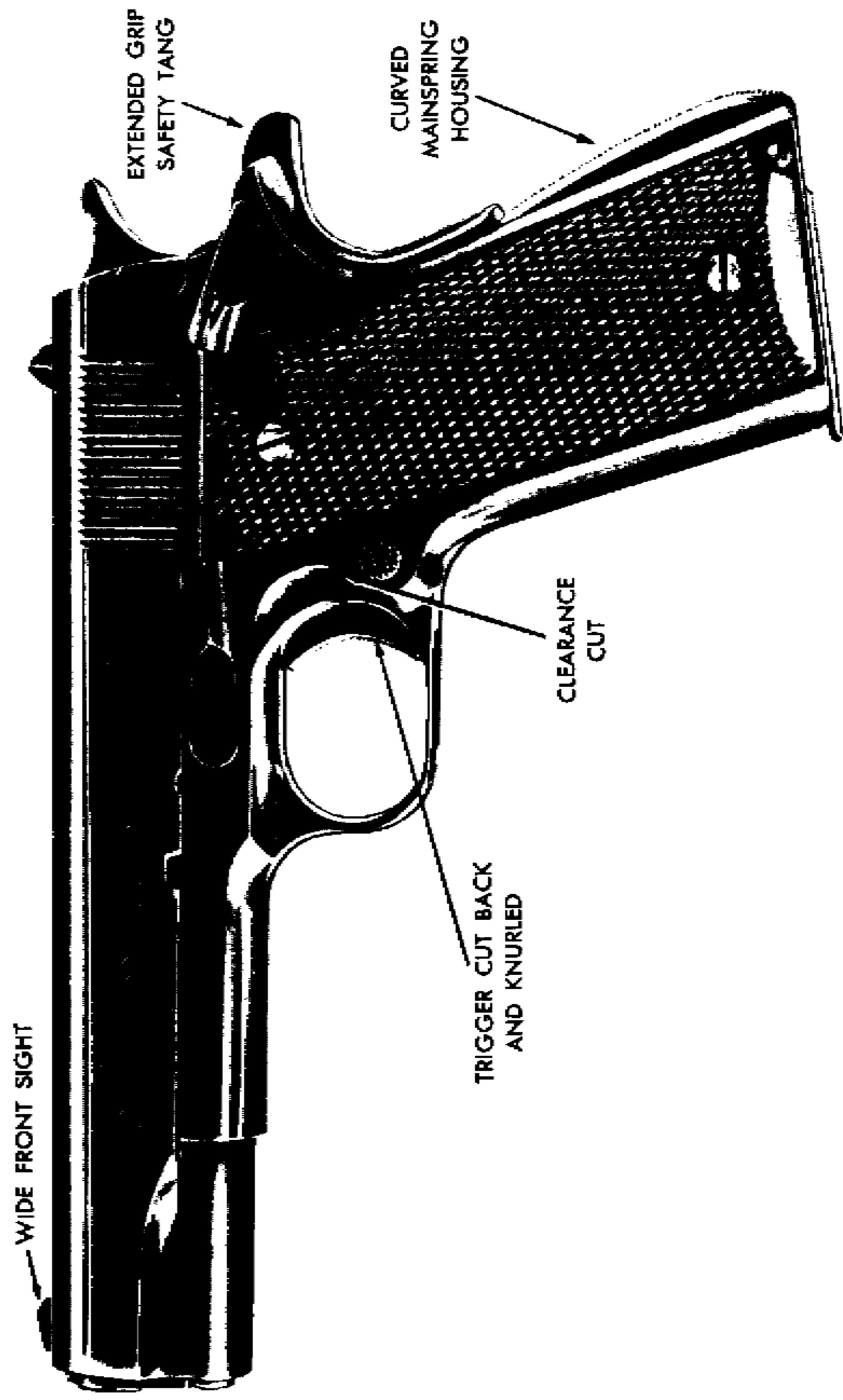

Figure 2 — Left Side of Pistol M1911A1 Showing Exterior Difference Between It and M1911

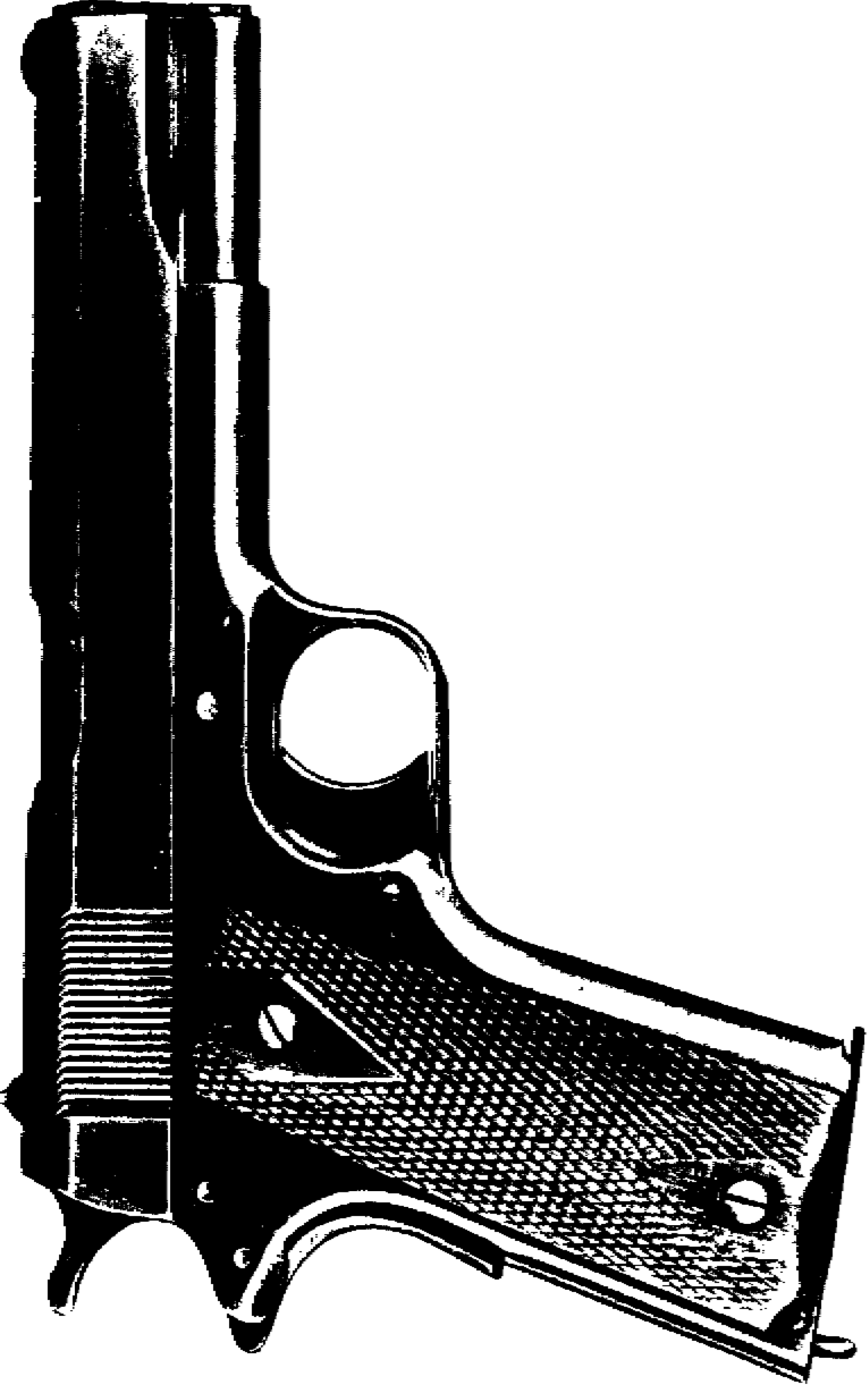

Figure 3 — Right Side of Pistol M1911

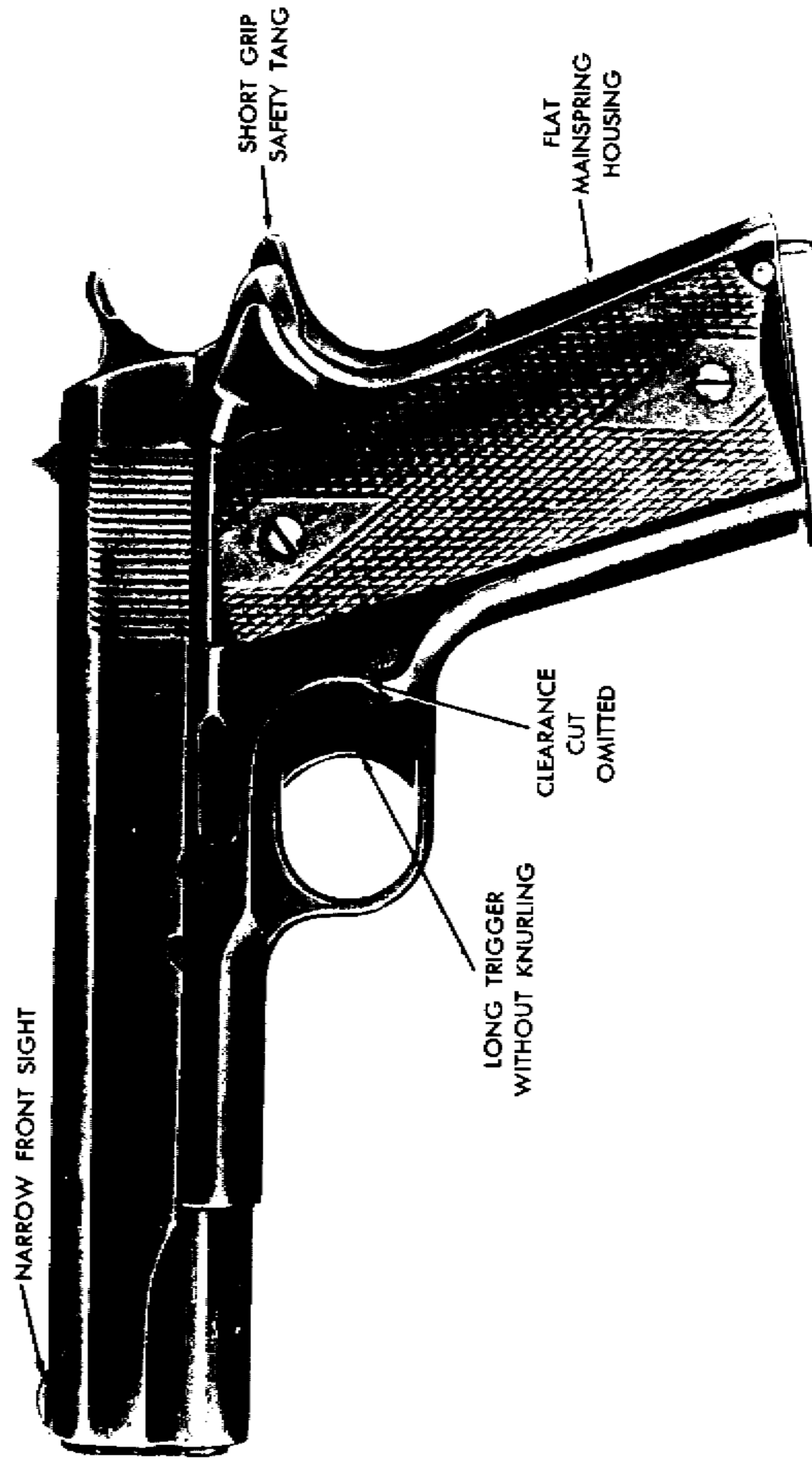

Figure 4 — Left Side of Pistol M1911 Showing Exterior Differences Between It and M1911A1

CHAPTER 2 MECHANICAL TRAINING

Section I. DISASSEMBLY AND ASSEMBLY

3. General

To insure that the pistol will function correctly, it is necessary to disassemble it to inspect and clean the parts. This chapter explains general disassembly, detailed disassembly of the three main groups, assembly, functioning, care and cleaning, stoppages, and immediate action. It is a guide for mechanical training and outlines the procedures to be followed.

4. Nomenclature

The names of the parts of the pistol are learned during practice in disassembly and assembly. As each part is removed and replaced, the nomenclature is repeated until known. Generally, the parts are named for their functions. For example, the *trigger guard* guards the trigger, the *extractor* extracts the cartridge case from the chamber, and the *ejector* ejects the cartridge case from the pistol.

5. Guides to Follow in Disassembly and Assembly

These guides should be followed when the pistol is being disassembled and assembled.

a. Follow the step-by-step explanation in disassembling the pistol.

b. If it is necessary to apply force, do it carefully so that none of the parts become damaged.

c. As the weapon is disassembled, lay out the parts in the order of their removal. Disassembly mats (GTA 9-617) are excellent aids during this phase of training. This procedure helps in assembly of the weapon, which is done in the reverse order of disassembly.

6. General Disassembly

General disassembly is the disassembly necessary for normal care and cleaning. General disassembly consists of the removal of the parts shown in figure 10.

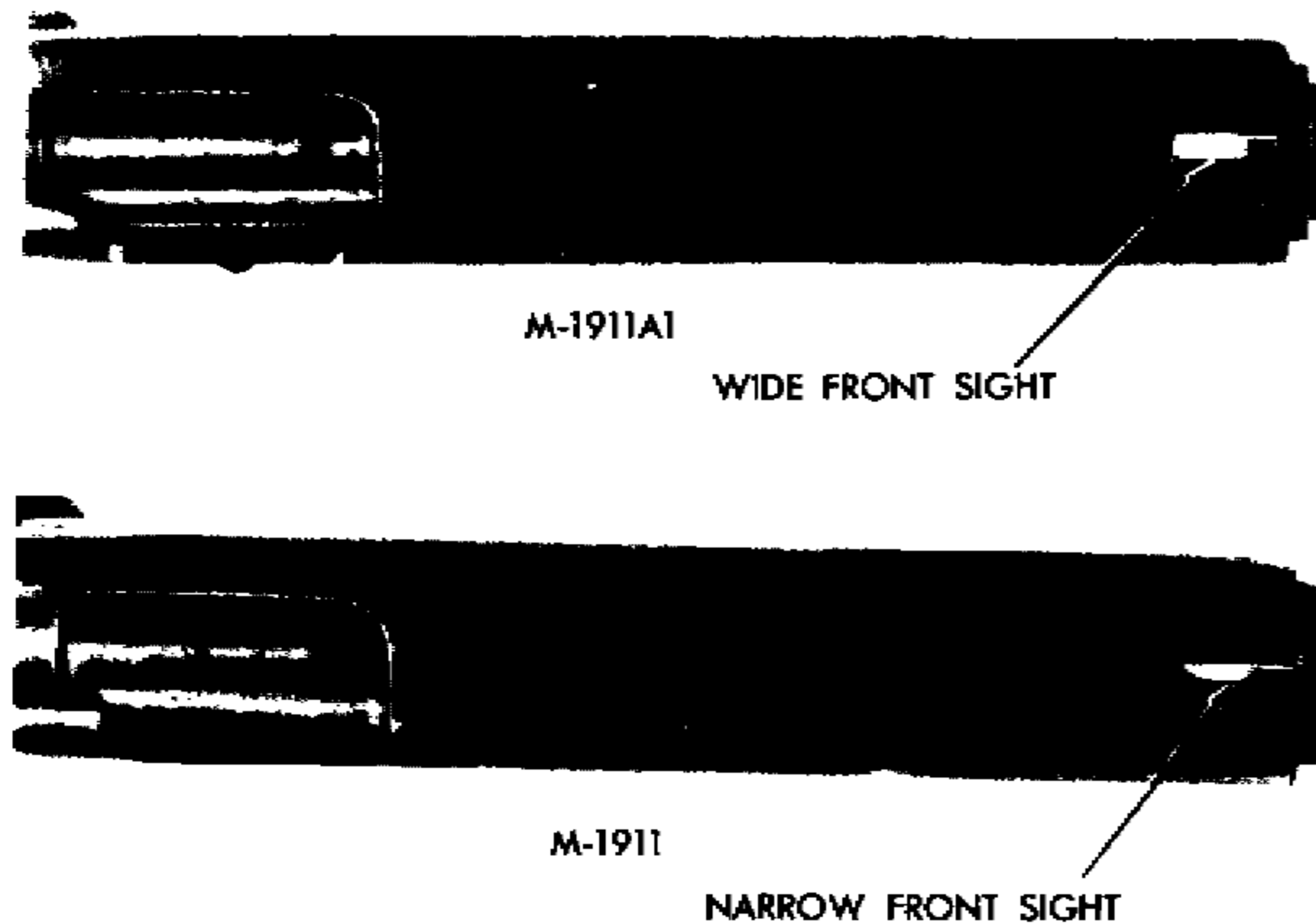

Figure 5 — Top of Pistols M1911A1 and M1911 Showing Difference in Width of Sights

Pistol.	
Over-all length of pistol.....	8.593 in.
Height of front sight above axis of bore.....	0.5597 in.
Weights.	
Weight of pistol with magazine	2.437 lb
Weight of loaded magazine, with 7 rounds approximate.	0.481 lb
Weight of empty magazine	0.156 lb
Trigger pull.	
Pistols, new or repaired.....	5½ to 6½ lb
Pistols, in hands of troops.....	5 to 6½ lb
Miscellaneous.	
Chamber pressure (maximum).....	17,000 pounds per square inch
Muzzle velocity (maximum).....	830 feet per second
Maximum range.....	1500 meters
Maximum effective range.....	50 meters
Sight radius.....	6.481 inches

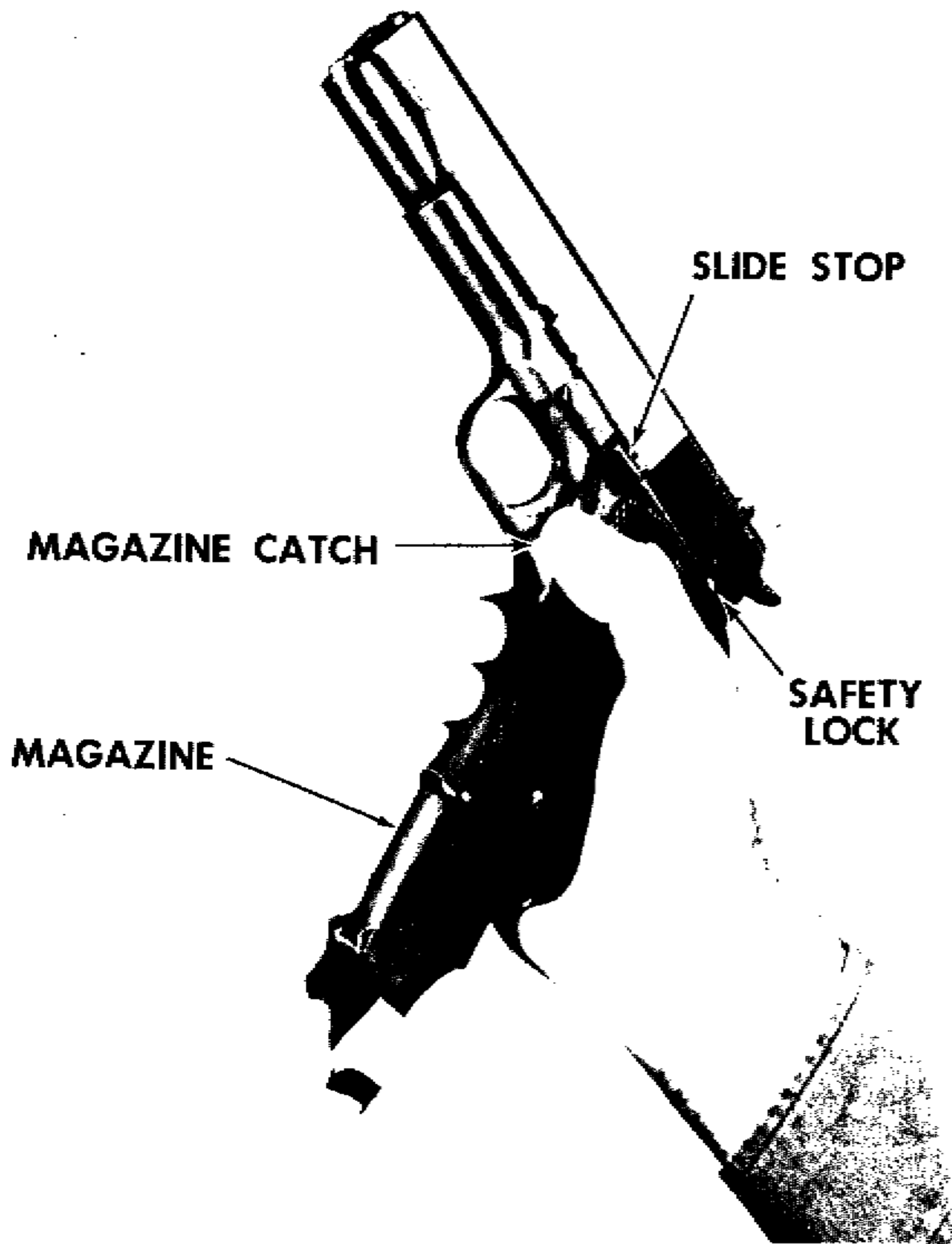

Figure 6. Press the magazine catch and remove the magazine. Pull the slide to the rear and inspect the chamber to see that the weapon is clear. Press down on the slide stop and allow slide to move forward. Press the safety lock upward to the SAFE position.

7. Procedure for General Disassembly

Procedure for general disassembly is shown in figures 6 through 12

8. Procedure for General Assembly

Replace parts in reverse order of disassembly.

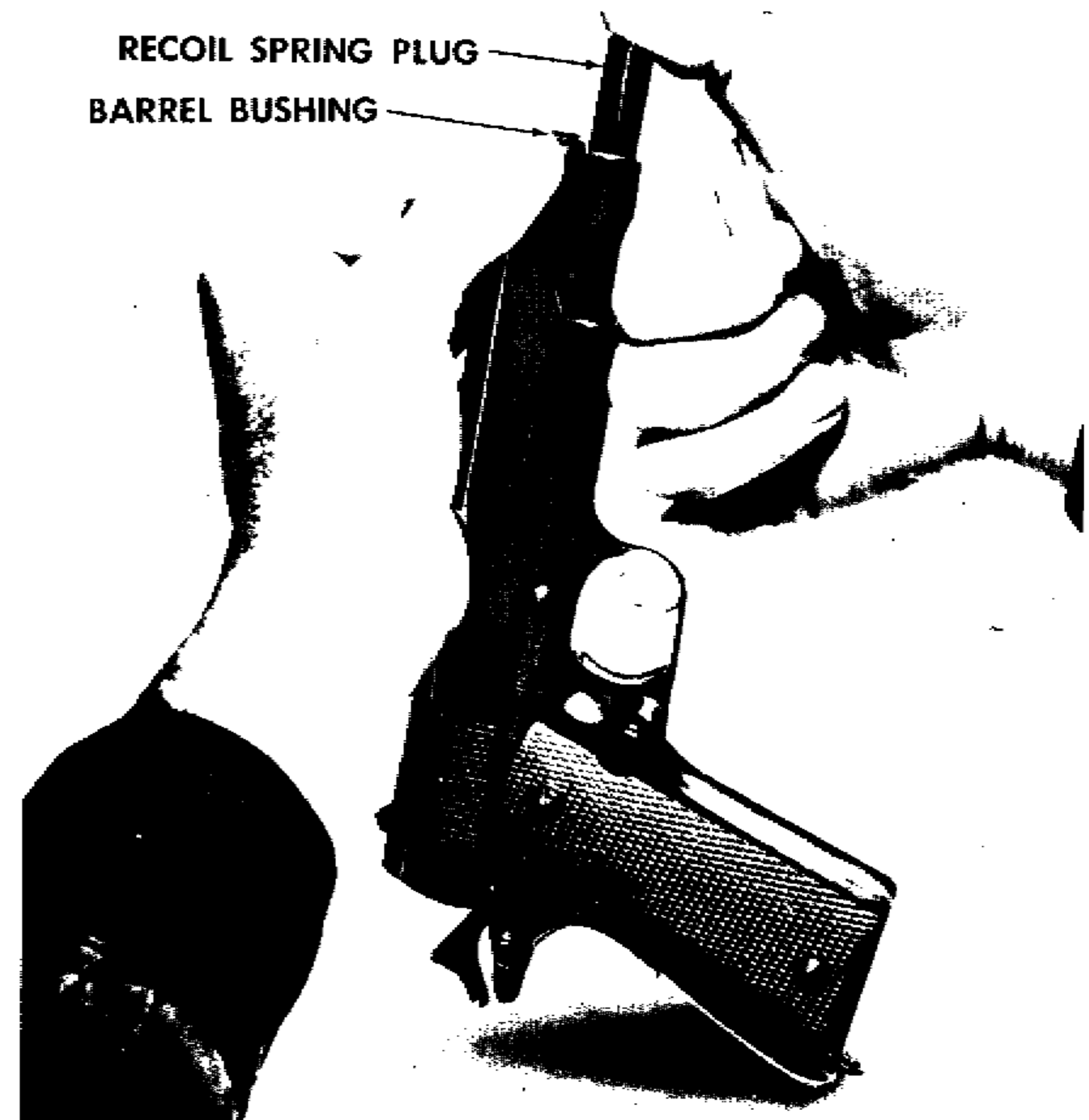

Figure 7. Press down on the recoil spring plug and turn the barrel bushing $\frac{1}{4}$ turn clockwise. Allow the recoil spring to expand slowly, under control, to prevent injury or loss of the part. Turn the recoil spring plug counterclockwise and remove it from the recoil spring.

a. *Barrel.* Push the barrel link forward on the barrel and replace the barrel, chamber end first, in the slide (fig 12.).

b. *Barrel Bushing.* Place the barrel bushing on the muzzle end of the barrel, push it into the slide, and turn it clockwise (fig.11).

c. *Recoil Spring and Recoil Spring Guide.* Insert the recoil spring guide into the tightest end of the recoil spring. Replace these parts in the slide (fig.10.). Be sure that the concave cut on the recoil spring guide collar is properly seated on the barrel. Push the barrel, recoil spring, and recoil spring guide fully forward in the slide, insuring that the barrel link is positioned



Figure 8. Press the safety lock downward to the FIRE position. Push the slide to the rear until the disassembly notch is aligned with the rear projection on the slide stop. Press the protruding end of the slide stop pin with the right forefinger and pull out the slide stop.

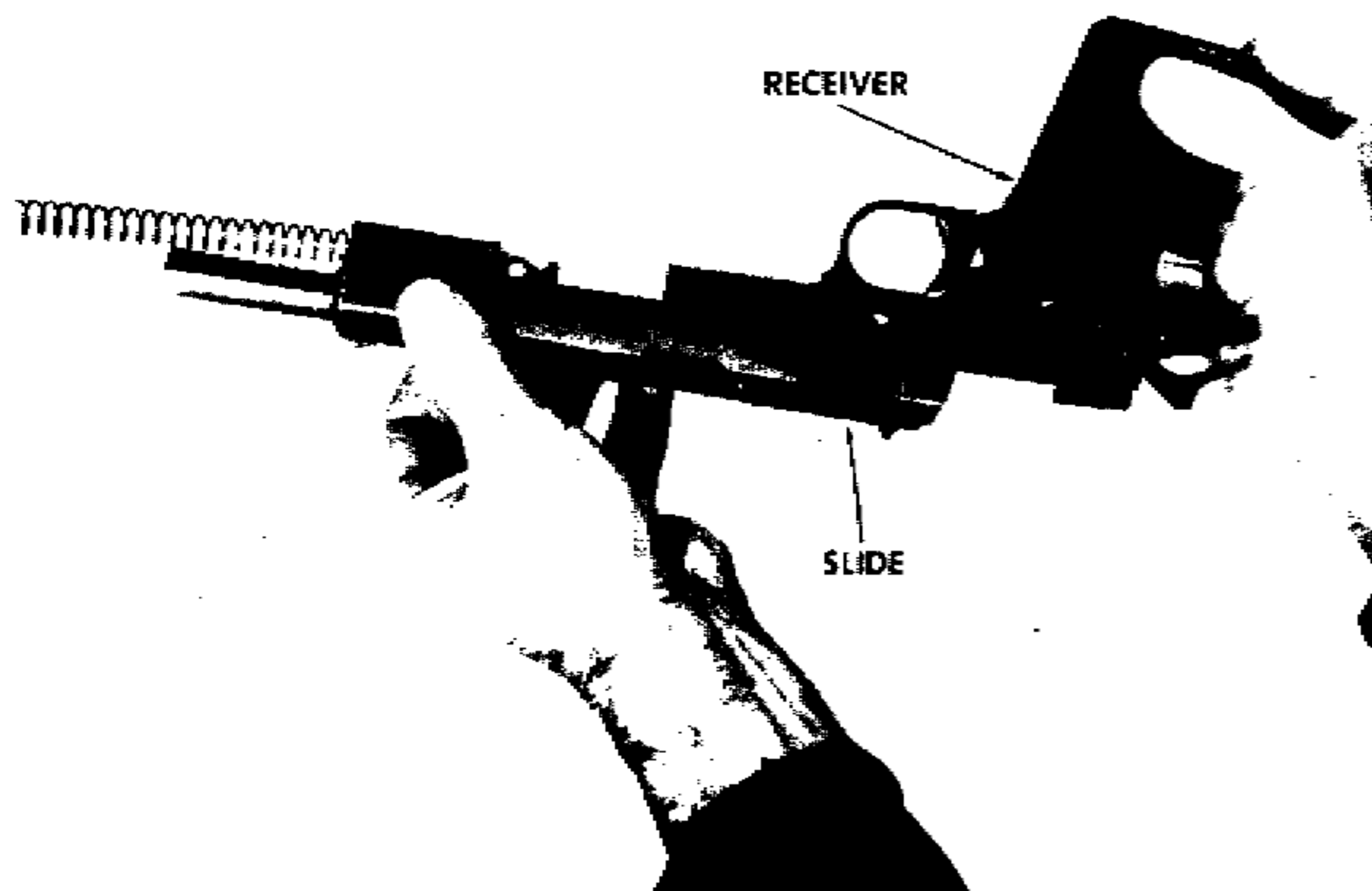

Figure 9. Pull the receiver rearward to separate it from the slide.

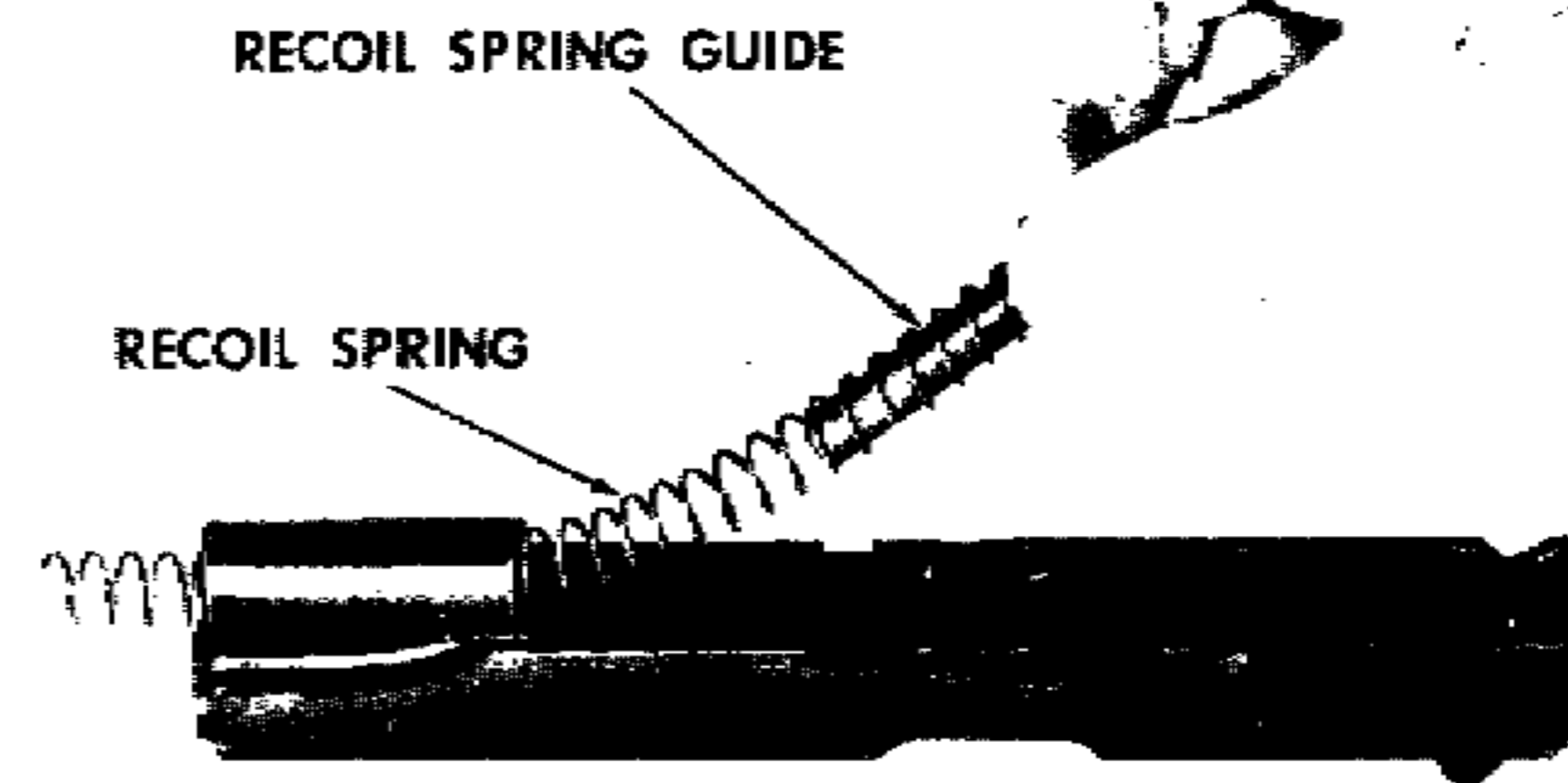

Figure 10. Remove the recoil spring guide and recoil spring. Separate the two parts with a twisting action.

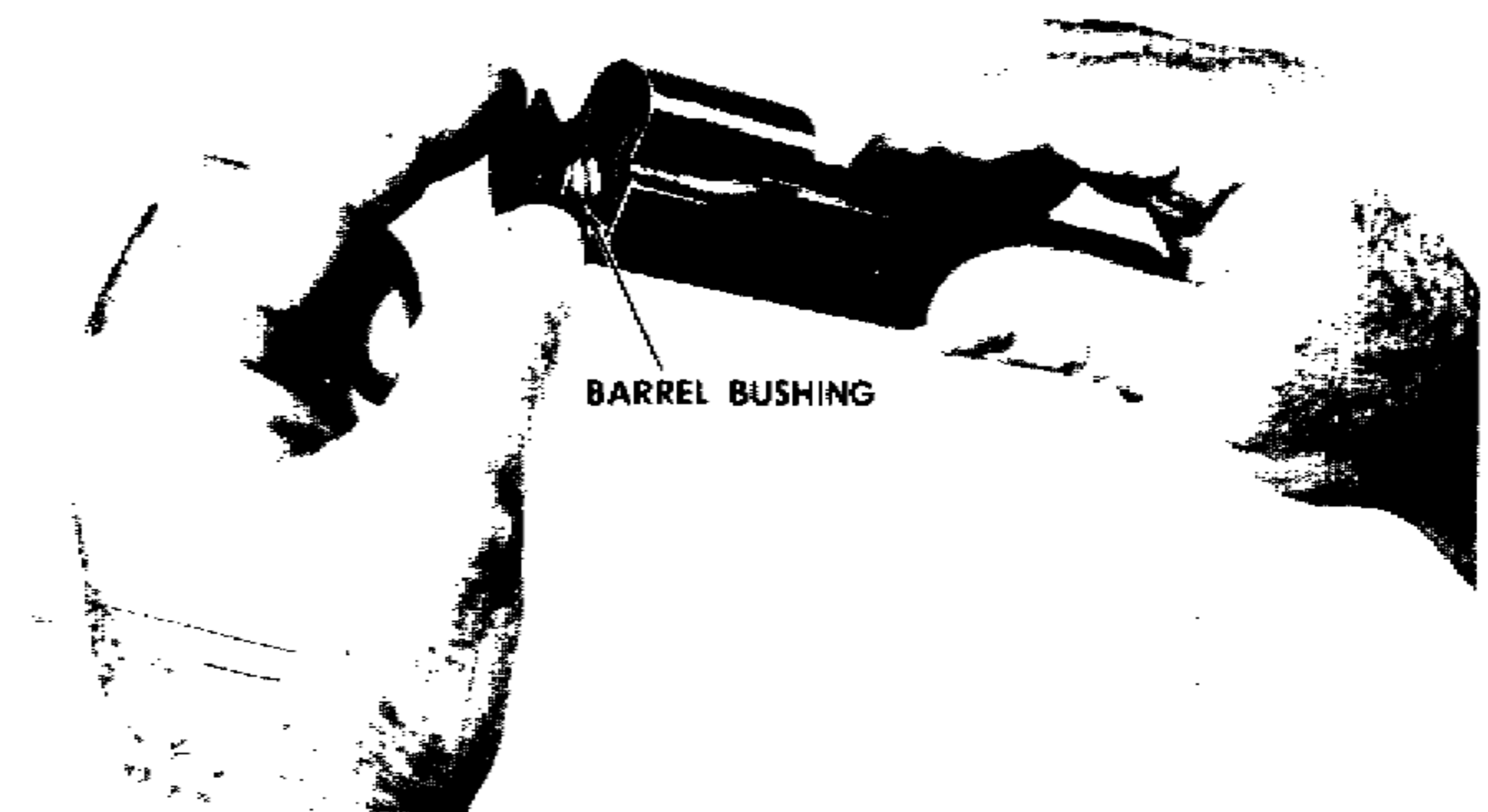

Figure 11. Remove the barrel bushing by turning it counterclockwise and pulling it from the slide.

forward and rests against the hole in the recoil spring guide (fig. 9).

d. *Assembling the Receiver Group to the Slide Group.* Hold the slide with the sights down in the palm of one hand. Invert the receiver (the safety lock must be in the FIRE position) and engage the guide rails of the receiver in the grooves of the slide (fig. 9). Push the receiver all the way forward on the slide with a quick motion.

e. *Slide Stop.* Hold the pistol as shown in figure 8. Look through the slide stop pin hole in the receiver for alinement of this hole with the hole in the barrel link. If the holes are not alined, move the muzzle end of the barrel forward or rearward to aline them. Insert the slide stop pin into the holes. Move the slide forward until the disassembly notch is over the square hole in the left side of the receiver (fig. 8). Press the slide stop up and in to fully seat it. In some cases, a drift may be required to depress the slide stop plunger in order to fully seat the slide stop.

f. *Recoil Spring Plug.* Push the slide fully forward on the receiver and press the safety lock upward to the SAFE position. Place the recoil spring plug on the recoil spring. Turn the recoil spring plug clockwise to lock the plug to the recoil spring. Holding the pistol as shown in figure 7, insert the recoil spring and push downward on the recoil spring plug, compressing the spring until the plug is inside the slide. Turn the barrel bushing counterclockwise to lock the recoil spring plug in place. Press the safety lock downward to the FIRE position and squeeze the trigger.

g. *Magazine.* Insert the magazine into the magazine recess of the pistol until it is fully seated and held by the magazine catch (fig. 6). This completes general assembly.

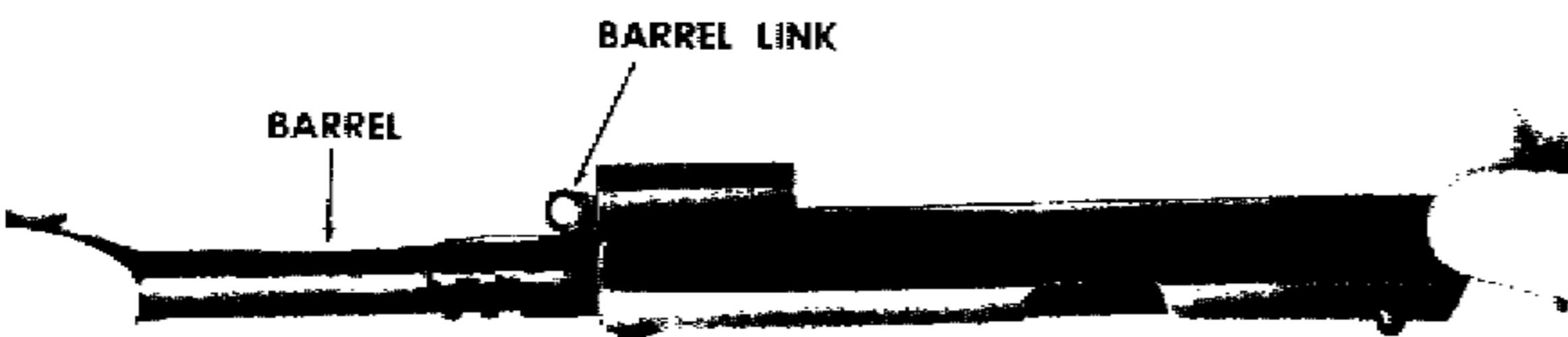

Figure 12. Push the barrel link forward and remove the barrel from the front end of the slide. This completes general disassembly.

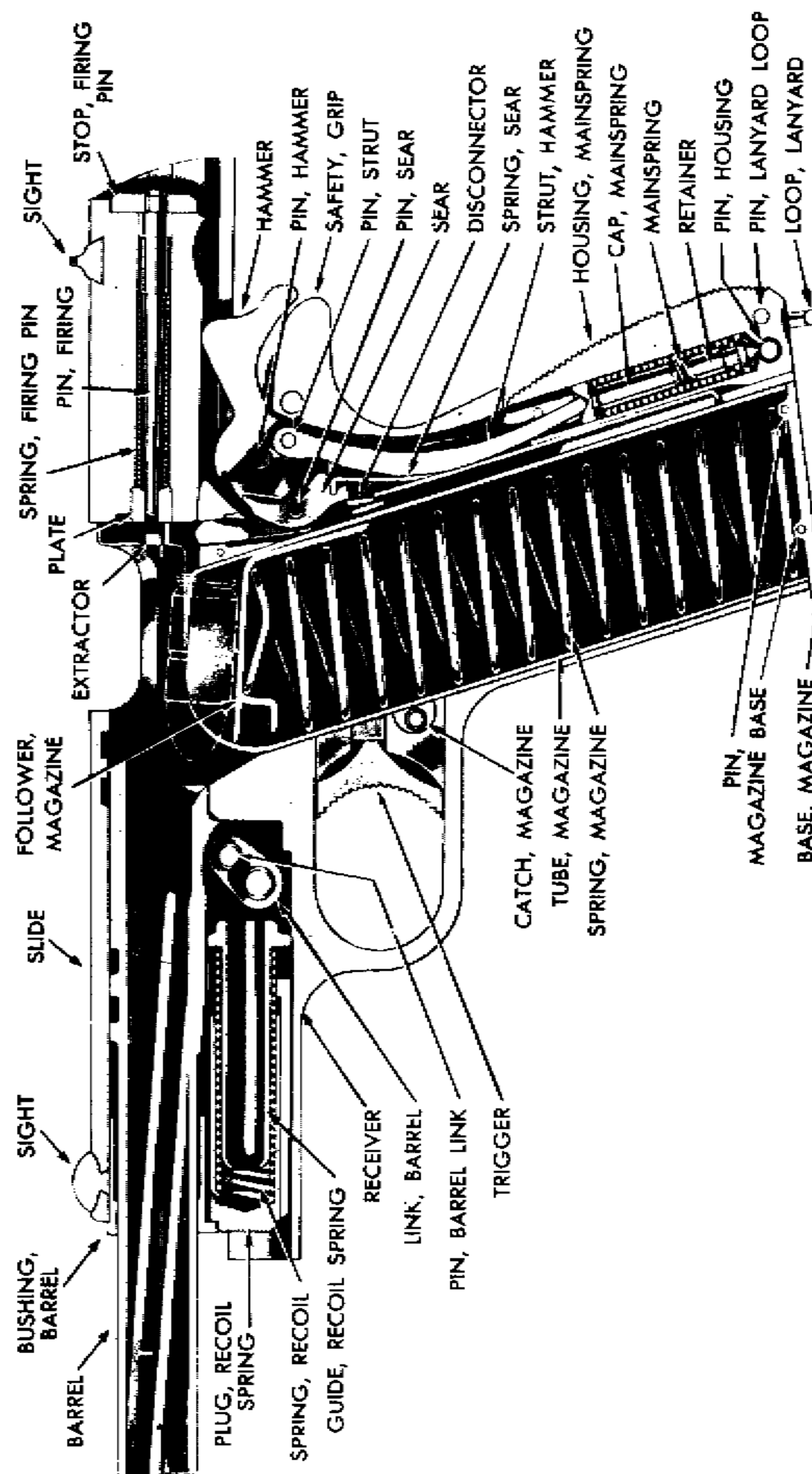

Figure 13. - Sectional View of Pistol M1911A1

Section II
FUNCTIONING

9. FUNCTIONING.

a. In loading, the charged magazine is inserted in the receiver (fig.14) and the slide is drawn once to the rear. This movement cocks the hammer and compresses the recoil spring (fig.15). The magazine follower then raises the upper cartridge into the path of the slide (fig.16). When the slide is released, it is forced forward by the recoil spring and carries the first cartridge into the chamber of the barrel. As the slide approaches its forward position, it encounters the rear extension of the barrel and forces the barrel forward. The rear end of the barrel then swings upward on the barrel link as on a pivot. When the slide and barrel reach their forward position, they are positively locked together by the locking ribs on the barrel and slide. Their joint forward movement is arrested by the barrel lug encountering the pin on the slide stop. The pistol is then ready for firing (fig. 17).

b. If it is desired to fire more than the magazine limit of seven cartridges at one loading, an additional cartridge is inserted by hand into the chamber of the barrel prior to inserting a loaded magazine. This is

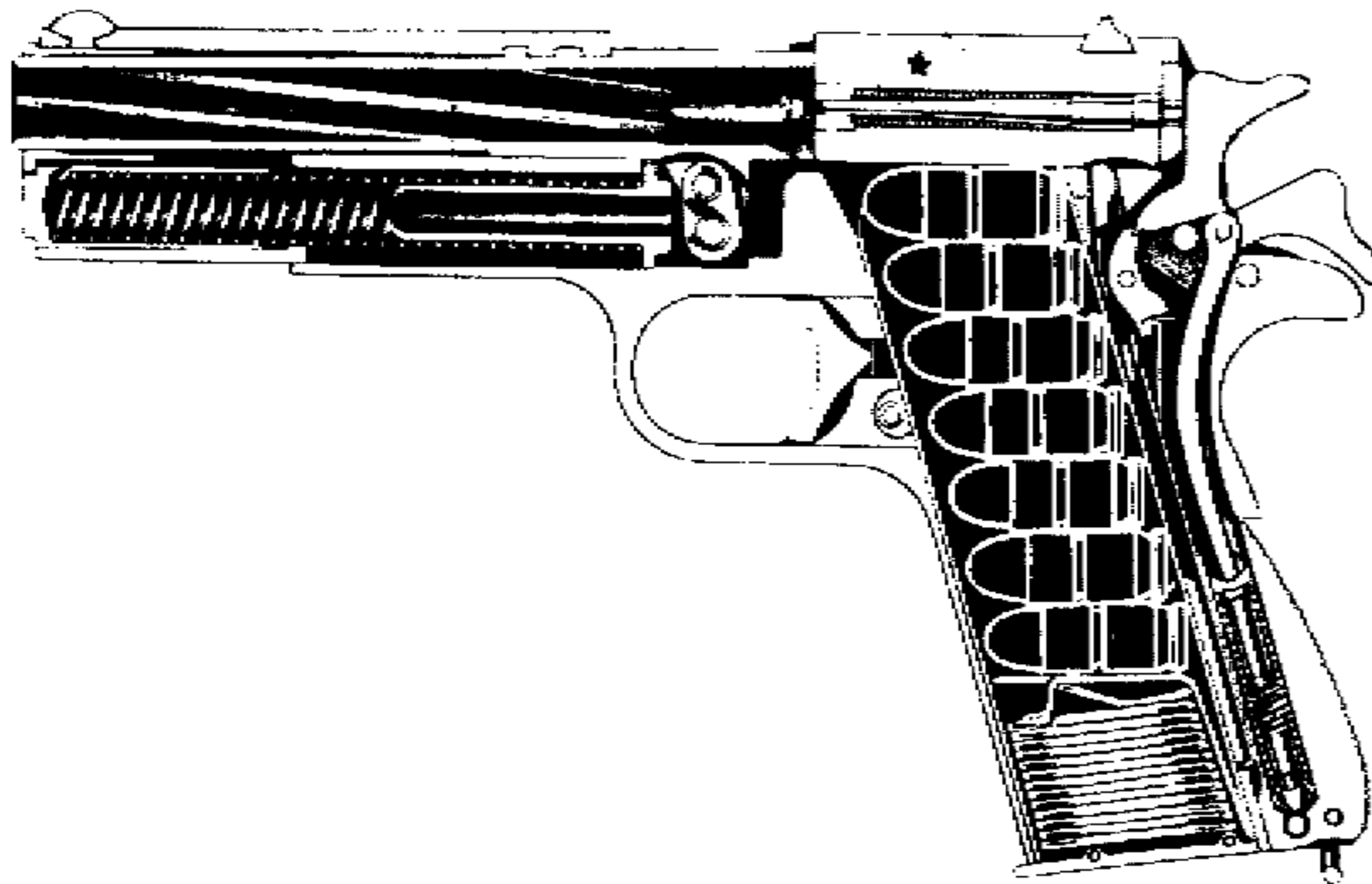

Figure 14. — Sectional View of Pistol M1911A1, Slide Forward, Magazine Loaded, Chamber Empty, Hammer Down

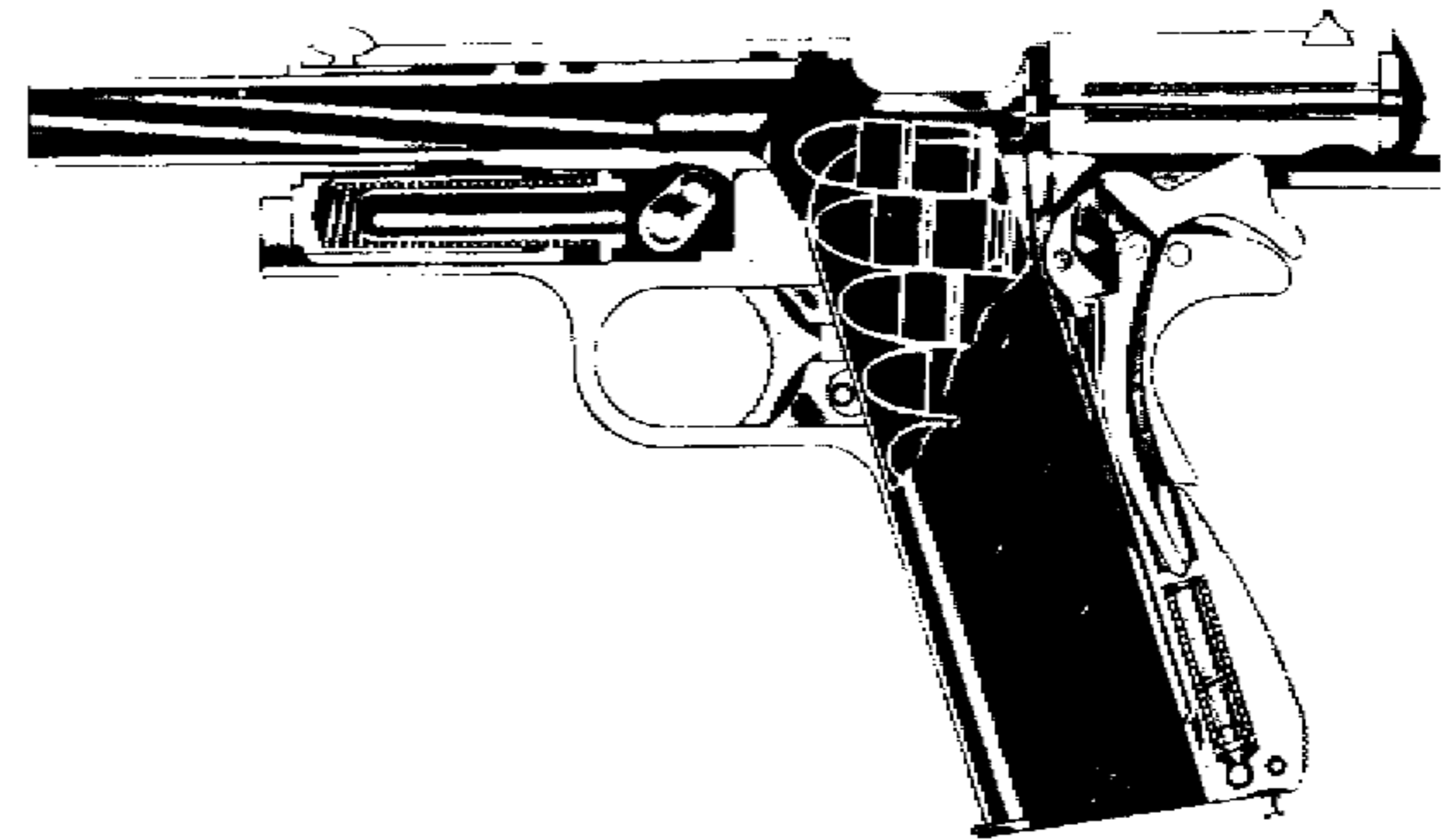

Figure 15.— Sectional View of Pistol M1911A1, Slide Back, Hammer Back, Magazine Full (Enclosed)

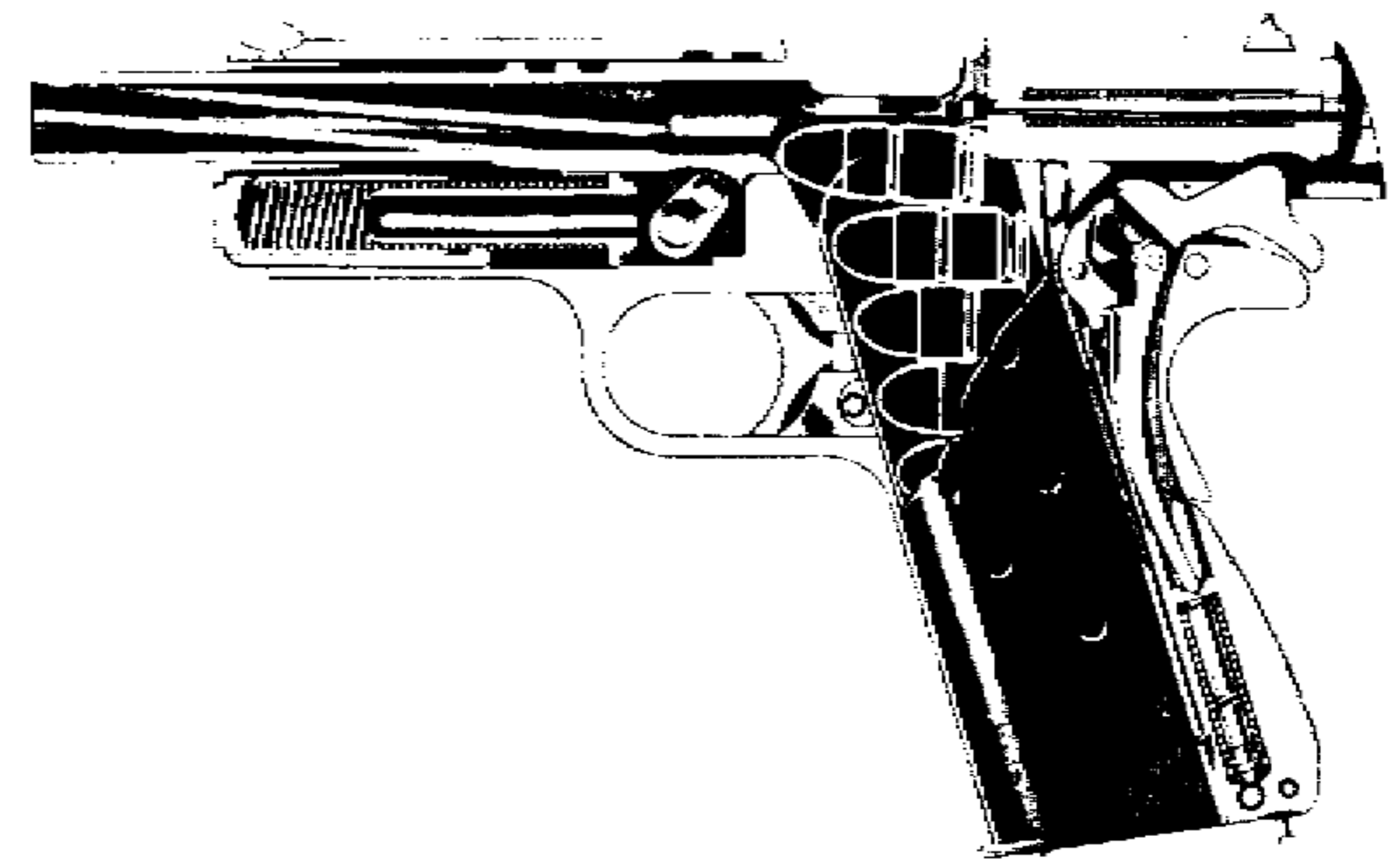

Figure 16. - Sectional View of Pistol M1911A1, Slide Partly Forward, Cartridge Entering Chamber, Hammer Back

accomplished by drawing back the slide, inserting the cartridge, allowing the slide to close, then locking the slide and the cocked hammer by pressing the safety lock upward. The slide and hammer are thus positively locked and the pistol may be carried safely at full cock. It is only necessary to press down the safety lock to make the pistol ready to fire.

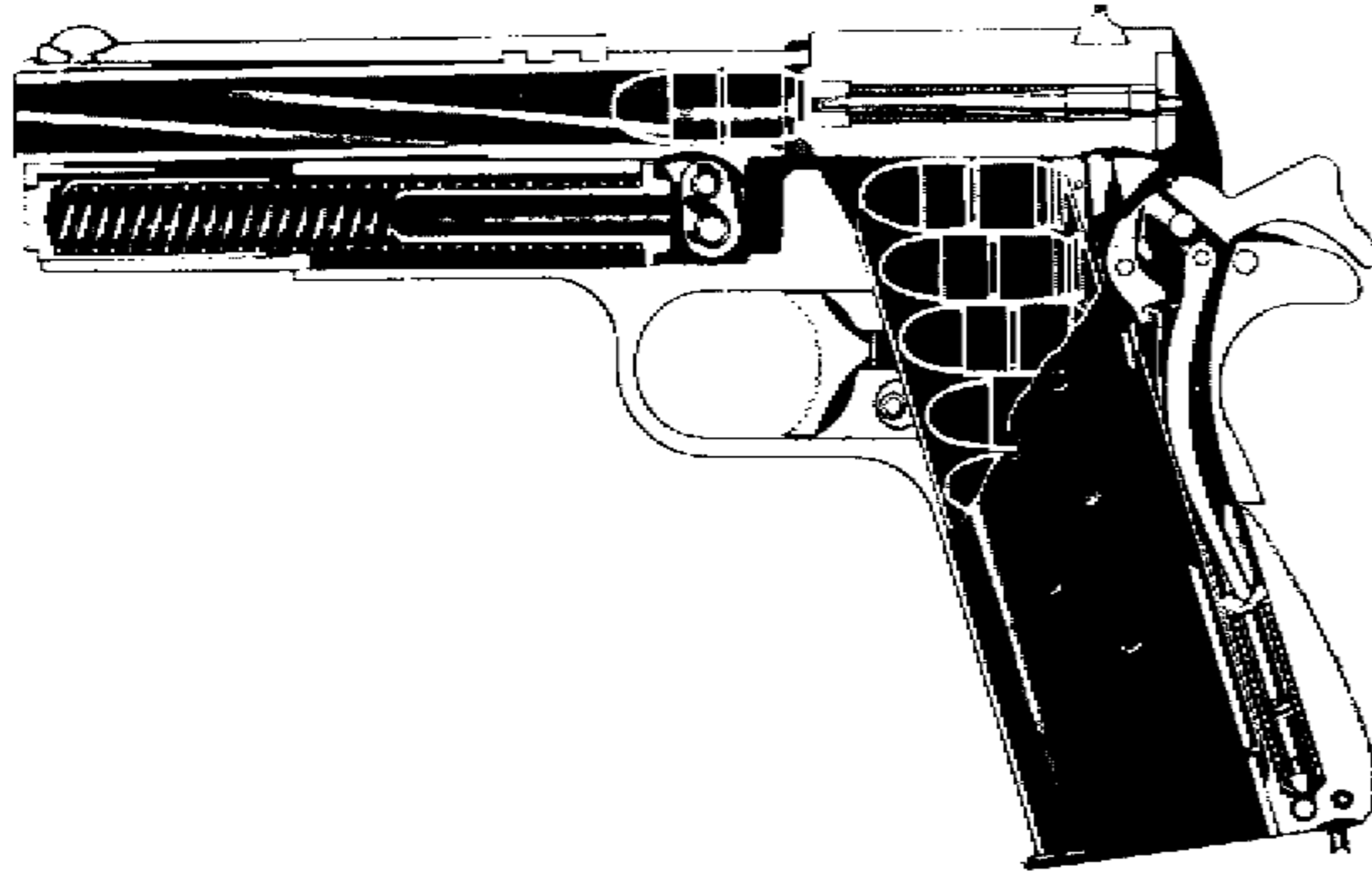

Figure 17.— **Sectional View of Pistol M1911A1, Slide Closed, Cartridge in Chamber, Hammer Back**

c. When the hammer is cocked, the hammer strut moves downward compressing the mainspring. The sear under the action of the long leaf of the sear spring engages its nose or tip in the notch on the hammer, holding it in the cocked position.

d. In order that the pistol may be fired, the following conditions must exist:

(1) The grip safety must be pressed in permitting the trigger to move.

(2) The slide must be in its forward position, properly interlocked with the barrel, so that the disconnecter is well in the recess on the underside of the slide, under action of the center leaf of the sear spring. In this position, it transmits any motion of the trigger to the disconnecter and sear.

(3) The safety lock must be down, in the unlocked position, so that the sear will be unblocked and free to release the hammer. The slide will then be free to move back.

e. Squeezing the trigger disengages the sear from the sear notch, releasing the hammer and letting it strike the firing pin. The blow overcomes the inertia of the pin and causes it to move forward. The forward end of the pin then strikes the primer of the cartridge, causing it to fire (fig. 18).

NOTE: The primer of the cartridge is the cap inserted in the center

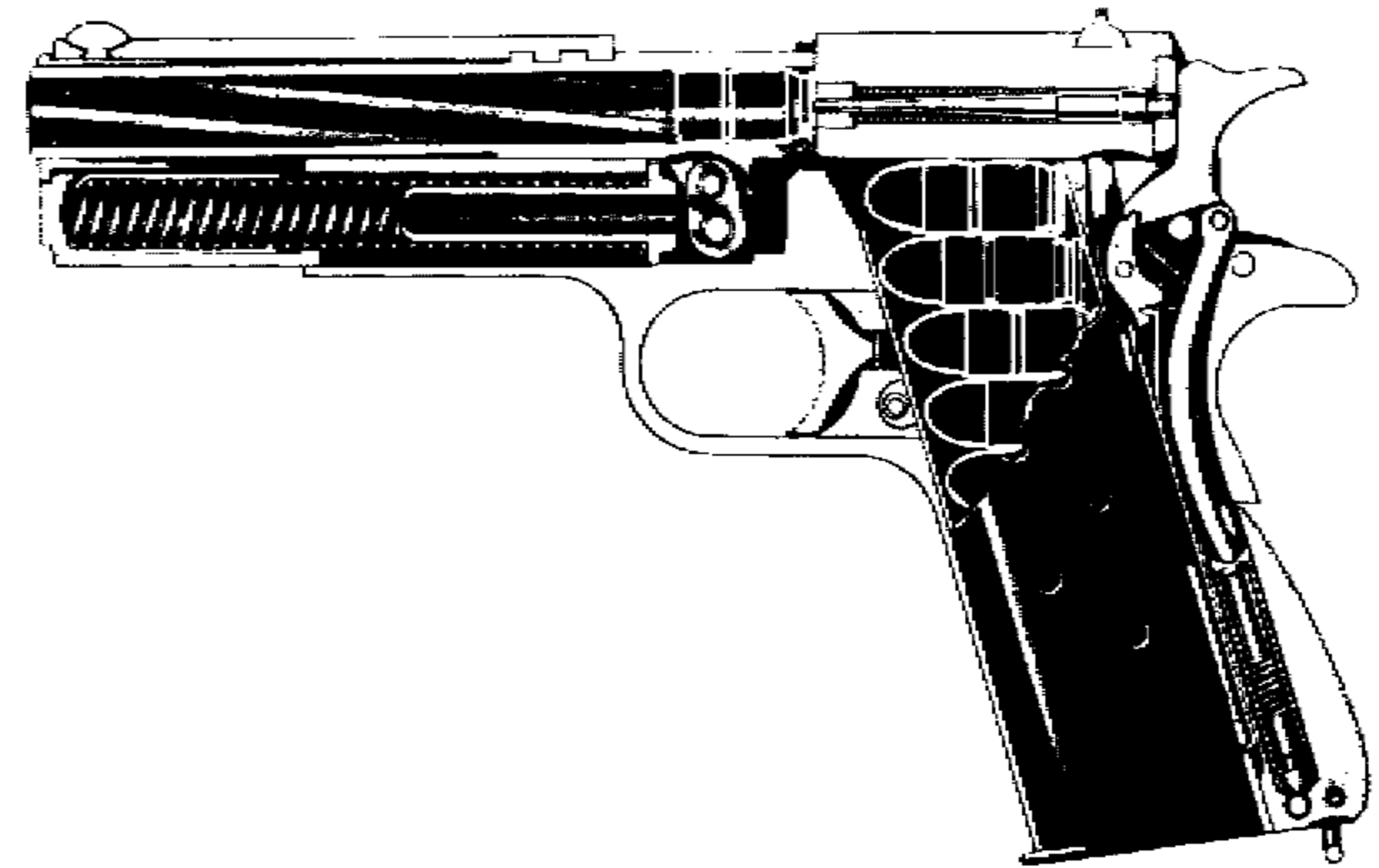

Figure 18.— **Sectional View of Pistol M1911A1, Hammer Down, Firing Pin Striking Cartridge**

of the head of the cartridge case. It contains the detonating charge which is ignited by the impact of the firing pin. Detonation of this charge then ignites the propelling powder charge contained in the cartridge case.

f. The pressure of the gases generated in the barrel by the explosion of the powder in the cartridge is exerted in a forward direction against the bullet, driving it through the bore. Pressure is also exerted in a rearward direction against the face of the slide, driving it and the barrel backward together. The slide travels the full distance while the barrel moves about $\frac{1}{8}$ inch. The downward swing movement of the barrel disengages it from the corresponding grooves in the slide. The barrel is then stopped in its lowest position. The slide continues to move to the rear, opening the breech, cocking the hammer, extracting and ejecting the empty shell, and compressing the recoil spring until the slide reaches its rearmost position (fig. 19). The return movement of the slide under the pressure of the recoil spring catches the cartridge, forcing it forward. The lips on the magazine, as well as the loading ramp on the rear end of the barrel, guide the cartridge into the chamber.

g. The weight, and consequently the inertia of the slide and the barrel, is so much greater than the weight and inertia of the bullet that the latter is driven from the muzzle before the slide and barrel have recoiled to the point where the barrel commences its unlocking movement. Thus, the opening of the breech of the barrel is delayed until

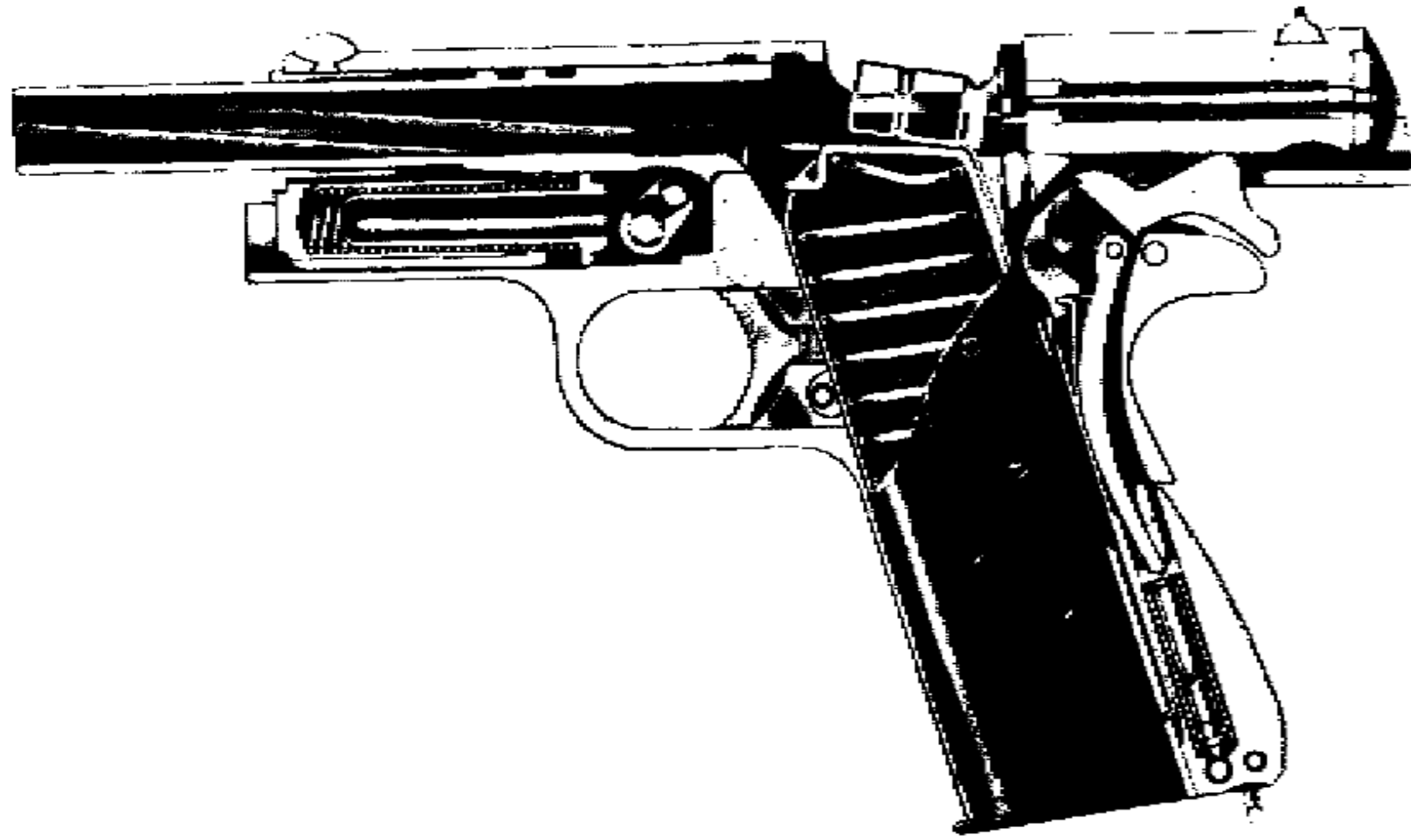

Figure 19. — Sectional View of Pistol M1911A1, Slide Back, Cartridge Being Ejected, Hammer Back, Magazine Empty

after the bullet has left the muzzle and the escape of any of the powder gases to the rear is practically prevented. This factor of safety is further increased by the tension of the recoil spring and mainspring, both of which oppose the rearward movement of the slide.

h. The comparatively great weight of the slide of the pistol not only prevents premature opening of the breech, but also assures operation of the pistol. This is because the heavy slide attains a sufficient momentum to enable it to complete the rearward movement, allowing the cartridge to be forced into position by the magazine follower under pressure of the magazine spring.

i. When the magazine has been emptied, the pawl-shaped slide stop is raised into the front recess on the lower left side of the slide by the magazine follower under the action of the magazine spring. This locks the slide in the opened position and serves as an indicator to remind the operator that the empty magazine must be replaced by a loaded one. Pressure upon the magazine catch quickly releases the empty magazine from the receiver, thus permitting the insertion of a loaded magazine.

j. To release the slide from the open position, it is only necessary to press upon the thumb piece of the slide stop. The slide will then go forward to its closed position carrying a cartridge from the magazine into the barrel and the pistol is ready to fire again.

10. Operational Tests Before Firing

Warning: Before making the following tests inspect to insure that the magazine is removed and the chamber is empty.

a. Safety Lock. Cock the hammer and press the safety lock up into the SAFE position. Grasp the stock so that the grip safety is depressed and squeeze the trigger three or four times. If the hammer falls, the safety lock is not safe and must be replaced.

b. Grip Safety. Cock the hammer and, being careful not to depress the grip safety, point the pistol down, and squeeze the trigger three or four times. If the hammer falls, the grip safety or sear spring must be replaced.

c. Half Cock Notch. Pull the hammer rearward until the sear engages the *half cock* notch and squeeze the trigger. If the hammer falls, the hammer or sear must be replaced. Pull the hammer rearward nearly to the *full cock* notch and let it fall. It should fall only to the *half cock* notch.

d. Disconnect. Cock the hammer and push the slide $\frac{1}{4}$ inch to the rear; hold the slide in that position and squeeze the trigger. Let the slide go forward, maintaining the pressure on the trigger. If the hammer falls, the disconnect is worn and must be replaced. Pull the slide all the way to the rear, squeeze the trigger and release the slide; the hammer should not fall. Release the pressure on the trigger, squeeze it, and the hammer should fall. The disconnect prevents the release of the hammer until the slide and barrel are fully forward and locked. If the hammer falls upon release of the slide, the disconnect should be replaced.

11. Load

Draw the pistol from the holster and hold it at the position of *raise pistol*. Insert a magazine loaded with from one to seven rounds of ammunition. Grasp the slide with the left hand, thumb on the right side of slide as shown in figure 20. Pull the slide fully to the rear, release, and press the safety lock up to the SAFE position with the left forefinger.

12. Fire

To fire the pistol, press the safety lock down to the FIRE position with the left thumb to prevent disturbing the firing grip



Figure 20. Position of hands at load.

of the right hand. Obtain the correct sight alinement and sight picture and squeeze the trigger. To fire successive shots, the trigger must be released and squeezed again. When the last cartridge from the magazine has been fired, the slide remains to the rear.

13. Unload

To unload, come to the position of *raise pistol*. Press the magazine catch and remove the magazine. If the slide is in the forward position, pull the slide to the rear and push the slide stop up. Inspect the chamber to insure that the pistol is clear. Press the slide stop down, allowing the slide to go forward. Remaining at *raise pistol*, squeeze the trigger; then holster the weapon.

Section IV. MALFUNCTIONS, STOPPAGES, AND IMMEDIATE ACTION

14. General

The pistol is a mechanical device and, as parts become worn, broken, dirty, or dry, stoppages may occur during firing. Sufficient knowledge of malfunctions, stoppages, and immediate action is

required to find and correct malfunctions or stoppages in a minimum of time.

15. Malfunctions

A malfunction is a failure of the weapon to function satisfactorily. Malfunctions are classified as defects in the weapon that normally do not cause a break in the cycle of operation. These may be discovered when the operational tests are being performed (par. 10). The following are some malfunctions and their causes:

- a. The grip safety does not block the trigger; a faulty sear spring.
- b. The slide does not remain to the rear after the last round is fired; a worn or broken magazine follower step, slide stop, or a weak or broken magazine spring.

16. Stoppages

a. A stoppage is any unintentional interruption in the cycle of operation. If the pistol stops firing through no fault of the firer, or an attempt to fire is made and the weapon does not fire, then a stoppage has occurred.

b. Stoppages are classified in accordance with the eight steps in the cycle of operation. Stoppages are usually the result of worn parts or improper care of the weapon. A knowledge of functioning enables the soldier to classify and correct stoppages. The following are the main classifications of stoppages and their causes:

- (1) *Failure to feed*. The top cartridge in the magazine is not properly positioned behind the barrel and in the path of the slide. Caused by—
 - (a) Dirty or dented magazine.
 - (b) Weak or broken magazine spring.
 - (c) Worn or broken magazine catch.
 - (d) Improper assembly (magazine spring backwards).
 - (e) Bent magazine follower.
- (2) *Failure to chamber*. The top cartridge from the magazine is not fully seated in the chamber. Caused by—
 - (a) Dirty chamber.
 - (b) Dented cartridge case.
 - (c) Weak recoil spring.
 - (d) Obstruction in the chamber.
 - (e) Lack of lubrication.

- (f) Extractor applying too much pressure on the right side of the cartridge.*
- (3) *Failure to lock.* The barrel locking ribs do not interlock with the locking recesses in the slide. Caused by—
- Lack of lubrication of operating parts.
 - Burred or dirty barrel locking ribs or locking recesses.
 - Weak recoil spring.
 - Broken barrel link.
 - Extractor applying too much pressure on the right side of the cartridge.*
- (4) *Failure to fire.* The hammer falls but the primer of the cartridge is not ignited. Caused by—
- Faulty ammunition.
 - Broken firing pin.
 - Bent or broken hammer strut.
 - Weak mainspring.
- (5) *Failure to unlock.* The barrel locking ribs do not disengage from the locking recesses in the slide. Caused by—
- Broken barrel link.
 - Broken barrel link pin.
 - Broken barrel lugs.
- (6) *Failure to extract.* The cartridge case is not removed from the chamber. Caused by—
- Broken or worn extractor.
 - Dirty or pitted chamber.
- (7) *Failure to eject.* The cartridge case is not ejected from the pistol. Caused by—
- Faulty extractor (does not position the cartridge case for ejection).
 - Broken ejector.
- (8) *Failure to cock.* The hammer does not return to the cocked position. Caused by—
- Worn *full cock* notch on the hammer.
 - Worn sear.
 - Defective sear spring.
 - Worn or broken disconnecter.

*The extractor groove in steel cased ammunition is shorter than that of brass cases. The extractor was designed for use with brass cases. When firing with steel cased ammunition, the extractor, in many instances, will not fully seat in the extractor groove. This will create friction during the forward movement of the slide, particularly with tight fitted weapons. Modification of the extractor is permitted only by Ordnance personnel, or specially trained Armorers.

17. Immediate Action

a. Immediate action is the prompt action taken by the firer to reduce a stoppage. The procedure for applying immediate action should become instinctive for the soldier armed with the pistol. If a stoppage occurs, immediate action is applied automatically in an effort to reduce the stoppage without attempting to discover the cause at that time.

b. In the event the slide is fully forward, the hammer falls, and the pistol fails to fire, apply immediate action as follows:

- Manually cock the hammer without opening the chamber and make one additional attempt to fire. If the pistol still fails to fire, wait 10 seconds, and then come to the position of *raise pistol*. Grasp the slide with the thumb and first finger of the left hand, keeping the thumb on the right side of the slide. Pull the slide rearward rapidly, to its full extent. Rotate the pistol to the right allowing the unfired round to drop out, release the slide and allow it to return to the forward position, chambering a new cartridge.

Caution: Keep the weapon pointed downrange during this operation.

- Aim and attempt to fire.

c. In the event the slide is not fully forward, remove the trigger finger from the trigger guard and with the non-firing hand attempt to push the slide fully forward. If the slide will not move forward, proceed as follows:

- Bring the weapon to *raise pistol*.
- Remove the magazine.
- Grasp the slide with the left hand as in *inspection arms*, pull the slide to the rear, and lock it with the slide stop.
- Inspect the chamber. Remove any obstructions.
- Insert another loaded magazine into the pistol.
- Release the slide.
- Aim and attempt to fire.

d. If the weapon does not fire after application of immediate action as outlined above, a detailed inspection should be made to determine the cause of the stoppage.

e. To obviate danger from *hangfire*, wait 10 seconds after a misfire, then clear the weapon quickly. In the event weapon cannot be cleared quickly and the barrel is hot, *danger of cook-off exists*. Keep round locked in chamber, point weapon in a safe direction (for personnel and property), and allow weapon to cool before removing misfired round.

18. Cleaning Materials, Lubricants, and Rust Preventives

a. Cleaning Materials.

- (1) Cleaning compound, solvent (rifle bore cleaner), is used to clean the bore and the face of the slide after firing. It dissolves corrosive primer salts and removes powder ash and carbon. This cleaner has preservative properties and provides temporary protection against rust.

Caution: Rifle bore cleaner is usable at temperatures of minus 20° Fahrenheit and higher. Do not mix water with rifle bore cleaner. This destroys its preservative qualities and impairs its value as a cleaner.

- (2) Hot soapy water may be used to clean the bore when rifle bore cleaner is not available. One-quarter pound of soap dissolved in one gallon of water makes a desirable cleaning solution. After using the solution, dry the barrel thoroughly and apply a light coat of oil.
- (3) Volatile mineral spirits, paint thinner, and dry-cleaning solvent are noncorrosive solvents used for removing oil, grease, or light rust-preventive compounds from weapons. Apply these cleaning agents with a rag to large parts, and use it as a bath for small parts.

Caution: These solvents are highly flammable. Do not smoke when using them. Continuous contact with them will dry the skin and may cause irritation.

- (4) Decontaminating agents are used under special conditions to remove chemical agents
- (5) The swab, small arms cleaning, is a good grade of unbleached, single-base, napped flannel cotton. Swabs are in the form of cut patches, 2½ inches square, and are used for the cleaning of bores of small arms.
- (6) Rags, wiping, cotton, are soft and absorbent cloth, usually composed of light clothing rags, free from dust, alkali, and corrosive agents. Rags are used to clean small arms and other items of equipment.

b. Lubricants.

- (1) Lubricating oil, general purpose, PL medium, is a highly

refined, nonhardening mineral oil containing a rust inhibiting additive. It forms a relatively heavy film that resists direct action of salt spray. This makes it useful for coating all parts of a weapon before amphibious operations. It should be used in preference to lubricating oil, general purpose, PL special, only when the weapon is exposed to salt water, high humidity, or high temperatures. This oil should not be used in temperatures below freezing.

- (2) Lubricating oil, general purpose, PL special, is a thin oil used for lubricating at below freezing temperatures, and for providing temporary protection against rust. When this oil is used, moving parts of weapons must be inspected frequently to make sure that they have an adequate film of lubricant.
- (3) Engine oil, SAE 10, may be used when preservative lubricating oils cannot be obtained. In cold weather, any heavy oil will cause sluggish operation, and may prevent the pistol from functioning properly. Engine oil does not contain the rust-preventive properties of lubricating, preservative oils. When engine oil is used, the pistol must be inspected, cleaned, and oiled frequently.

19. Daily Preventive Maintenance

a. Damp air and sweaty hands are great promoters of rust. Pistols should be cleaned and protected with oil after every drill or handling. The pistol should be inspected each day and cleaned if necessary.

b. To clean the pistol, rub it with a rag lightly saturated with oil, and then rub with a dry rag. Clean the bore with a swab saturated with oil, then with a dry swab. Dust out all crevices with a small, clean brush.

c. To protect the pistol after it has been cleaned, cover all the surfaces, including the bore and chamber, with a light coat of lubricating, preservative oil.

d. After cleaning and oiling the pistol, place it in the pistol rack. The use of canvas or similar covers is prohibited, since they collect moisture, which rusts the metal.

20. Care and Cleaning Before Firing

Before the pistol is fired, the bore and chamber and exterior parts of the receiver of the pistol should be cleaned and dried. The guide rails on the receiver and the grooves on the slide should be lubricated with oil. A light coat of oil should be placed on all

other interior metal parts except those that come into contact with ammunition. Excess oil should be removed from the grips and the grip area of the receiver to aid the firer in gripping the weapon.

21. Care and Cleaning After Firing

The pistol must be cleaned as soon as practicable on the day of firing and daily for the next three days, or longer if necessary, in the following manner:

- a. Disassemble the pistol.
- b. Clean all parts with a rag lightly saturated with oil. Dry all parts and apply a light coat of oil.
- c. Clean the bore and chamber as follows:
 - (1) Wet a swab with rifle bore cleaner and run it back and forth through the bore several times.
 - (2) Attach the pistol bore brush to the cleaning rod and run it through the bore and chamber several times.
 - (3) Run dry swabs through the bore and chamber until they are clean.
 - (4) Inspect the bore for cleanliness. If it is not free of all residue, repeat the cleaning process.
 - (5) When the chamber and bore are clean, coat them with rifle bore cleaner and leave overnight.
 - (6) Assemble the pistol.
 - (7) Perform the test for correct assembly
 - (8) Apply a light coat of oil to the exterior surfaces of the pistol.
 - (9) After the third daily cleaning, if the bore and chamber are clean, remove the rifle bore cleaner and replace with a light coat of lubricating, preservative oil.

22. Care and Cleaning Under Unusual Climatic Conditions

a. Cold Weather.

- (1) In temperatures below freezing, it is necessary that the moving parts of the weapon be kept free from moisture. Excess oil on working parts will solidify and cause sluggish operation or complete failure.
- (2) Before cleaning, allow the weapon to attain room temperature. Perform detailed disassembly and clean with dry-cleaning solvent or mineral spirits before use in temperatures below 0° F. Working surfaces that show signs of wear may be lubricated by rubbing lightly with a rag that has been wet with oil, lubricating, general purpose, PL special.

b. Hot Weather.

- (1) In tropical climates where temperature and humidity are high, or where salt air is present, and during rainy seasons the weapon should be inspected daily and kept lightly oiled. It should be disassembled daily and all parts dried and oiled.
- (2) In hot, dry climates where sand and dust may get into the mechanism and bore, all lubricants should be removed from the pistol, and it should be disassembled daily for thorough cleaning. It should be wiped clean as often as required.

23. Care and Cleaning After a CBR Attack

a. *Before Attack.* If a chemical, biological, or radiological (CBR) attack is anticipated, the following action is taken: Apply oil to all outer metal surfaces of the pistol. Do not apply oil to the ammunition. If the pistol is not to be used, cover the weapon, accessories, and ammunition with protective coverings and place them under natural cover. Ammunition should be kept in original containers as long as possible before anticipated use.

b. *After Attack.* After a CBR attack, determine by means of detectors whether or not the equipment is contaminated. A complete suit of protective clothing, including protective gloves and a gas mask, must be worn during decontamination. If the contamination is too great, it may be necessary to discard the equipment. Detailed information on decontamination is contained in FM 21-40 and TM 3-220.

24. Cleaning Pistols Received From Storage

Pistols removed from storage are coated with lubricating oil, general purpose, preservative, medium, or corrosion-preventive compound, class 2, (medium film). Weapons received from ordnance storage are usually coated with corrosion-preventive compound. Use mineral spirits or paint thinner to remove the compound or oil. Failure to thoroughly clean all the parts may cause a stoppage at below normal temperatures, since the corrosion-preventive compound will congeal during cold weather. After using mineral spirits or paint thinner, dry all parts with a dry cloth, and apply a thin film of appropriate lubricating oil.

Section V. ACCESSORIES

The names or general characteristics of many of the accessories required for the pistol indicate their use and application. They consist of the hip holster, shoulder holster, and pistol cleaning kit. The pistol kit contains wire bore brushes, cleaning rods, pistol screwdrivers, an oiler, and a small brass can in which a set of repair parts is carried.

Section VI. AMMUNITION

25. General

a. The soldier armed with the pistol must be familiar with the types of ammunition for use in the pistol, ways of identifying each type of ammunition, and how to care for, handle, and use it.

b. A pistol cartridge is a complete assembly consisting of all the components necessary to fire the weapon once; that is, the cartridge case, bullet, propellant powder, and primer.

26. Classification of Ammunition

The contents of original boxes or containers can be identified by markings on the box. These markings indicate the number of cartridges in the container, the caliber, the type, the code symbol, and the lot number. The types, uses and means of identification of ammunition for use in the pistol are:

a. Cartridge, Caliber .45, Ball, M1911, is for use against personnel and light materiel targets. The ball bullet consists of a metal jacket surrounding a lead alloy core. The bullet tip is unpainted.

b. Cartridge, Caliber .45, Blank, M9, is used to simulate fire and for salutes. This cartridge can be fired single shot only in the pistol. It can be identified by the absence of a bullet and by its tapered mouth.

c. Cartridge, Caliber .45, Dummy, M1921, is used for training personnel in the operation of loading and unloading the pistol, and for testing weapons. It is used also in marksmanship training by being mixed with live ammunition during instruction practice firing. This cartridge can be identified by the empty primer pocket and two holes in the cartridge case.

d. Cartridge, Caliber .45, Tracer, M26, is used for observation of fire. Secondary uses are for incendiary effect and for signaling.

The bullet consists of three parts: a copper-plated steel, or guiding metal-clad, steel jacket; a slug of lead hardened with anti-mony; and a tracer mixture in the rear portion of the jacket. For identification the bullet is painted red for a distance of approximately $\frac{3}{16}$ of an inch from the tip.

27. Ammunition Lot Number

At time of manufacture, ammunition is assigned a lot number that is marked on all packing containers and is entered on all records pertaining to that ammunition. It must be included in all reports on the condition and functioning of the ammunition and in all reports of accident in which the ammunition is involved. Therefore, it is important to retain the lot number with the cartridges after they are removed from their original containers. If cartridges cannot be identified by ammunition lot number, they are automatically placed in grade 3. Grade 3 ammunition is unserviceable; it will not be fired, but will be turned in to the issuing ordnance officer.

28. Care, Handling, and Preservation of Ammunition

a. Small arms ammunition is generally safe to handle. However, do not allow ammunition boxes to become broken or damaged. Repair broken boxes immediately. Transfer all original markings to the new parts of the box.

b. Do not open ammunition boxes until the ammunition is to be used. Ammunition removed from airtight containers, particularly in damp climates, is likely to corrode, thereby becoming unserviceable.

c. Use care when opening wooden ammunition boxes, which can be continued in use as long as they are serviceable.

d. Protect ammunition from mud, sand, dirt, and water. If it appears wet or dirty, wipe clean with a dry cloth immediately. Wipe off light corrosion as soon as it is discovered. Cartridges with a heavy coat of corrosion must be turned in to the issuing ordnance officer.

e. Do not oil or polish cartridges.

f. Do not expose ammunition to the direct rays of the sun for any length of time. If the powder is heated, excessive pressure will be developed when the weapon is fired. This condition will affect accuracy and the operation of the weapon.

g. Do not attempt to fire cartridges that have dents, scratches, loose bullets, or corroded cases. If the cartridge is defective, turn it in. Do not throw away or attempt to destroy defective ammunition.

h. Do not strike the primer of a cartridge; it may ignite and cause injury.

28A Storage of Ammunition

a. Small arms ammunition is not an explosive hazard; however, under poor storage conditions it may become a fire hazard.

b. Small arms ammunition should be stored away from all sources of extreme heat.

c. Whenever practicable, small arms ammunition should be stored under cover. If necessary to leave ammunition in the open, it should be raised on dunnage at least six inches from ground. It should be covered with a double thickness of tarpaulin or suitable canvas. The cover should be placed so that it gives maximum protection, yet allows free circulation of air. Suitable trenches should be dug to prevent water from flowing under the ammunition.

29. Precautions in Firing Ammunition

The precautions concerning the firing and handling of ammunition in the field prescribed in AR 385-63 and TM 9-1990 must be observed. Precautions particularly applicable to small arms ammunition include the following:

a. No small arms ammunition will be fired until it has been positively identified by ammunition lot number and grade.

b. Before firing, the firer must be sure that the bore of the pistol is free from any foreign matter. Firing a pistol with any obstruction in the bore will result in damage to the weapon and possible injury to the firer.

30. Hangfire

a. A hangfire is a delay in the functioning of a propelling charge or explosive train at the time of firing. The amount of the delay is unpredictable but in most cases will be from a fraction of a second to several seconds. Thus, a hangfire cannot be distinguished immediately from a misfire and therein lies the principal danger—that of assuming that a failure of the weapon to fire immediately is a misfire when in fact it proves to be a hangfire. For this reason, the time interval of 10 seconds should be observed before the slide is opened after a failure to fire.

Caution: During the prescribed time interval keep the pistol pointed toward the target.

b. If the slide is fully forward and the pistol fails to fire, recock the hammer without opening the chamber, and make one

additional attempt to fire. If the pistol still fails to fire wait 10 seconds before pulling the slide to the rear to remove the cartridge from the chamber.

c. When a hangfire occurs in any lot, use of the ammunition in that lot should be withdrawn and replaced by serviceable ammunition.

CHAPTER 3

MANUAL OF ARMS FOR THE PISTOL

31. General

- a. Pistol movements are not executed in cadence.
- b. During the manual of arms for the rifle, personnel armed with the pistol remain at attention except when the command INSPECTION ARMS or PRESENT ARMS is given.
- c. When PRESENT ARMS is given, the HAND SALUTE is executed.

32. Inspection Arms

At the command INSPECTION ARMS, execute the following movements in sequence. (These movements may be executed separately in response to the appropriate command.)

a. *Raise Pistol.* At the command RAISE PISTOL, unbutton the snap fastener of the shoulder holster with the right hand and grasp the receiver with the back of the hand facing outward. Draw the pistol from the holster. Bring the elbow in to the side and hold the forearm at an angle from the vertical, so that the hand is as high as, and approximately 6 inches in front of, the right shoulder. Hold the receiver with the thumb and last three fingers and extend the forefinger outside and along the trigger guard. Point the muzzle outward and up at an angle approximately 30 degrees from the vertical. If wearing a hip holster, at the command RAISE PISTOL, unbutton the flap, draw the pistol from the hip holster, and assume the position of *raise pistol*.

b. *Withdraw Magazine.* At the command WITHDRAW MAGAZINE, without lowering the right hand, turn the pistol slightly to the right and press the magazine catch with the right thumb. With the left hand, remove the magazine and place it between your belt and outer garment on the left side, with open end down and front to the right.

c. *Open Chamber.* At the command OPEN CHAMBER, without lowering the right hand, grasp the slide with the left thumb and first two fingers so that the thumb is on the left side of the slide and pointing down. Keeping the muzzle elevated, shift

the grip of your right hand, so that the right thumb engages the slide stop; push the slide fully to the rear and engage the slide stop in the slide stop recess with the right thumb. Resume the position of *raise pistol*, with the slide to the rear. Take the magazine out of the belt and hold it in the open hand at the height of the belt, with the open end of the magazine to the front and the front of the magazine to the left. If the inspecting officer takes the pistol for inspection, lower the right hand smartly to your side as in the position of *attention*. When the inspector is ready to return the pistol, raise the right hand to the *raise pistol* position.

d. *Close Chamber.* After the pistol has been inspected, or at the command of CLOSE CHAMBER or PORT ARMS, press the slide stop down with the right thumb and let the slide go forward. Pull the trigger and remain at *raise pistol*.

e. *Insert Magazine.* At the command of INSERT MAGAZINE, without lowering the right hand, turn the barrel slightly to the right. Grasp the magazine with the first two fingers and thumb of the left hand, insert it into the pistol, press the magazine upward until it is engaged by the magazine catch, and resume the position of *raise pistol*.

33. Return Pistol

a. Execute this movement on the command RETURN PISTOL or on the command ORDER (RIGHT SHOULDER) ARMS after INSPECTION ARMS and PORT ARMS have been given.

b. Upon the command of execution, lower the pistol to the shoulder holster, raise the snap fastener of the holster with your right thumb, insert the muzzle of the pistol into the holster, and thrust it home. Button the snap fastener of the holster with the right hand. When wearing a hip holster, at the command RETURN PISTOL, return the pistol to the holster, directly from the position of *raise pistol*.

CHAPTER 4

MARKSMANSHIP TRAINING

Section I. GENERAL

34. Introduction

The primary use of the pistol is to engage an enemy at close range with quick, accurate fire. Accurate shooting is the result of knowing and correctly applying the important elements of marksmanship.

35. Fundamentals of Marksmanship

The important elements of marksmanship are—

- a. Aiming (sight alinement and sight picture).
- b. Positions (grip of the pistol and body positions).
- c. Trigger squeeze.

36. Phases of Training

a. Marksmanship training is divided into two phases—

- (1) Preparatory marksmanship training.
- (2) Range firing.

b. Each of the two phases may be divided into separate instructional steps. All marksmanship training must be progressive.

Section II. PREPARATORY MARKSMANSHIP TRAINING

37. General

a. A thorough course in preparatory marksmanship training must precede any range firing. This training must be given to all soldiers expected to fire the pistol on the range, including those who have previously qualified with the weapon. The soldier should develop correct shooting habits before range firing. The purpose of preparatory marksmanship training is to establish and correct shooting habits.

b. Preparatory marksmanship training is divided into seven steps which should be taught in the following order:

- (1) Aiming.
- (2) Positions.

- (3) Trigger squeeze.
- (4) Slow fire.
- (5) Rapid fire.
- (6) Quick fire.
- (7) Examination.

38. Coaching

a. Throughout preparatory marksmanship training, the coach-and-pupil method of training should be used. The ultimate proficiency of a pupil depends to a great extent on how well his coach performs his coaching duties. The coach assists the firer by—

- (1) Correcting any errors made.
- (2) Insuring that he takes proper firing positions.
- (3) Insuring that he observes all safety precautions.

b. Duties of the coach during instruction practice and record firing are—

- (1) Check to see that the—
 - (a) Pistol is cleared.
 - (b) Ammunition is clean.
 - (c) Sights are blackened.
 - (d) Magazines are clean and operational.
- (2) Observe the firer to see that he—
 - (a) Takes the correct firing position.
 - (b) Loads the pistol properly and only on command.
 - (c) Takes up the trigger slack correctly.
 - (d) Squeezes the trigger correctly. The coach cannot tell by watching the trigger finger whether the shooter squeezes or jerks the trigger. The coach must observe the firer for signs that indicate that the firer is anticipating the recoil of the weapon. These signs are general nervousness, fluttering of the eyelids, small muscular spasms around the mouth, nose, and eyes. The most obvious indication of faulty trigger squeeze is the location of the strike of the bullet in relation to the center of the target. It is the coach's duty to observe the firer during the firing and look for these indications and correct them.
 - (e) Calls the shot each time he fires. (Except for quick fire and rapid fire.)
 - (f) Holds his breath correctly.
 - (g) Lowers his pistol and rests his arm when he does not fire a round within 8 or 9 seconds.

(3) If a firer is tense and nervous, have him breathe deeply several times to relax.

(4) After each table of fire is completed, inspect the pistol to make sure it is clear. Score the target and record the results.

c. During record firing, coaching is not permitted. No person may render or attempt to render the firer any assistance while he is taking his position or after he has taken his position at the firing point. Each firer must observe the location of his hits and assist the coach in scoring. The coach will manipulate the targets during rapid fire and quick fire exercises. He will also insure that the magazines are loaded with the correct amount of ammunition for each firing table.

39. Aiming

a. Sight alinement or aiming is placing the front and rear sights of the pistol into correct alinement with the eye. For correct sight alinement, the firer must center the front sight in the rear sight and raise or lower the top of the front sight, so that it is level with the top of the rear sight (fig. 21).

b. A sight picture is the pattern of the pistol sights in relation to the target as seen by the firer when he aims the pistol. A correct sight picture consists of correct sight alinement with the bull's-eye centered above and appearing to touch the top of the front sight (fig. 21). When aiming, the eye cannot focus on three objects (rear sight, front sight, bull's-eye) at different ranges. Therefore, the last focus of the eye is always on the front sight. The front and rear sights will be seen clear and sharp while the bull's-eye will appear to be a bit hazy. With correct sight alinement, the strike of the bullet will be in the bull's-eye even if the sight picture is partially off the center but still touches the bull's-eye. Since it is impossible to hold the weapon perfectly still, the shooter must understand that he must apply trigger squeeze

and maintain correct sight alinement while the weapon is moving in and around the bull's-eye. This movement of the weapon is referred to as "wobble area." The shooter must trust this wobble area or movement and make an effort to keep the wobble or movement of the weapon to a minimum.

c. Correct sight alinement is essential for accuracy, particularly with the pistol because of the short sight radius. For example, if a $\frac{1}{10}$ -inch error is made in alining the front sight in the rear sight, the bullet will miss the point of aim by approximately 15 inches at 25 meters of range. The $\frac{1}{10}$ -inch error in sight alinement

magnifies itself as the range increases; at 25 meters it is magnified 150 times.

d. If the firer does not call his shot correctly in range firing, he is not concentrating on sight alinement; consequently, he does not know what his sight picture is as he fires. To call the shot is to state where the bullet should strike the target according to the sight picture at the instant the weapon fires: e.g. "high," "a little low," "to the left," "to the right," or "bull's-eye." Another specific method of calling the shot is the clock system: e.g., 9 o'clock or 2 o'clock.

e. It is important to emphasize that holding the breath properly is necessary to good marksmanship. Emphasis upon this point is required because many men hold their breath improperly or not at all. The breath should be held while the firer is aiming and squeezing the trigger. While the procedure is simple, it requires explanation, demonstration, and supervised practice. To hold the breath properly, the firer inhales an ordinary breath, lets a little out, and holds the rest by closing the throat.

40. Positions

a. *General.* To assume the proper position for firing, it is necessary to know the correct position of the body with relation

(Continued Page 41)

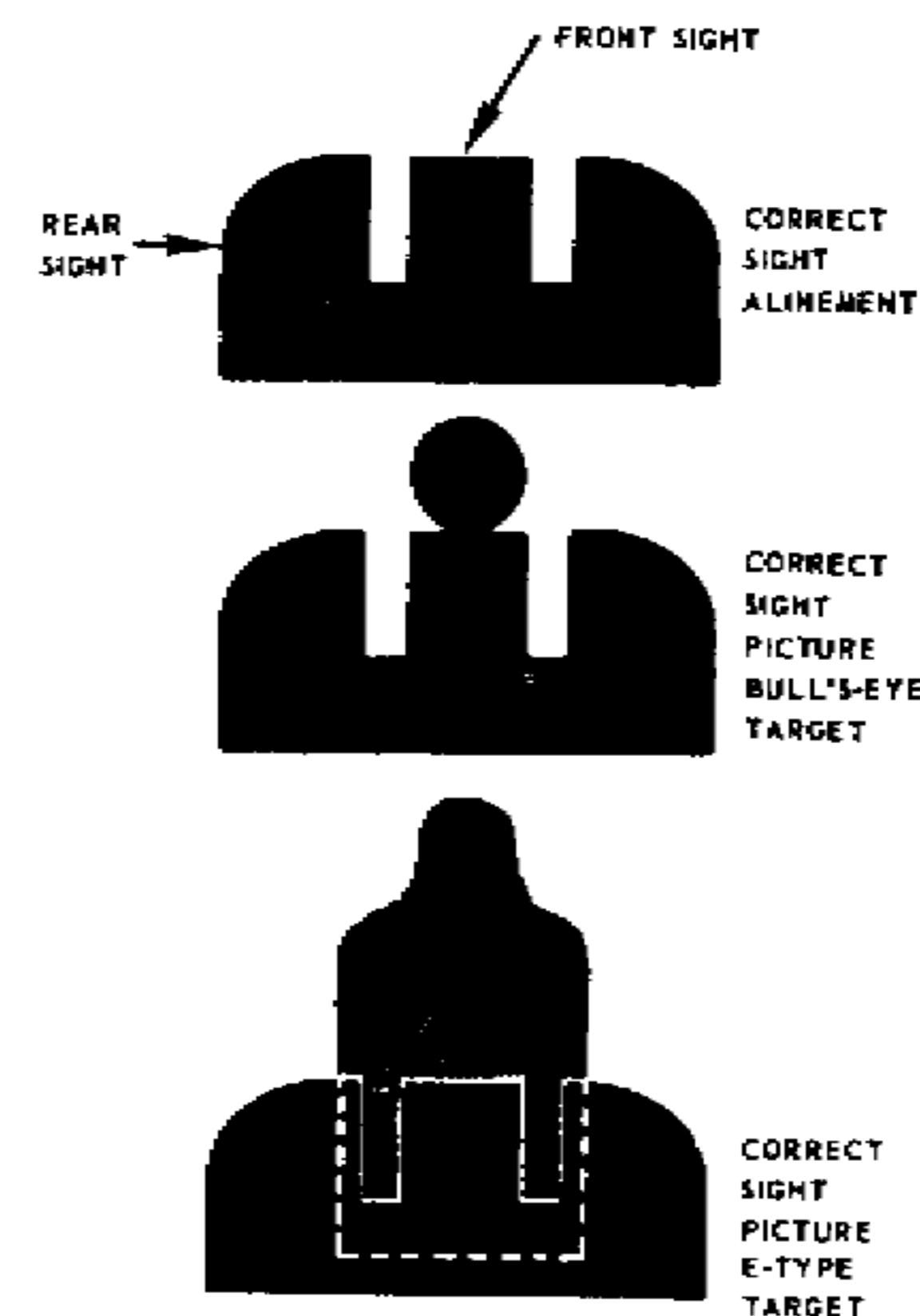

Figure 21. Correct sight alinement and sight picture.

Instruction Practice Firing Course

The following tables prescribe the instruction practice to be fired from the standing, prone, kneeling, and crouch positions. The E target and the 25-yard (standard American) pistol target are used in the practice firing.

Table I. Slow Fire (25-yard standard American pistol target)

Range (meters)	Position	Time	Shots
15	Standing	None (10 min in record firing)	10
25	Standing	None (10 min in record firing)	10

Table II. Rapid Fire (E target, bobbing (3))

Range (meters)	Position	Time	Shots
25	Prone	12 seconds	5
25	Kneeling	12 seconds	5

Table III. Quick Fire (E target, bobbing (3))

Range (meters)	Position	Time	Shots
25	Standing to prone	15 seconds	4
15	Standing to kneeling	15 seconds	4
10	Crouch	6 seconds	2

Record Firing Course

- a. Tables I, II, and III used in instruction practice firing are fired for record in numerical order.
- b. Coaching is not permitted during record firing.
- c. Qualification scores, of a total possible score of 400, are as follows:

Expert	350
Sharpshooter	330
Marksman	300

to the target and how to grip the pistol correctly. The qualification course is fired from the standing, kneeling, crouch, and prone positions. The appropriate positions outlined and illustrated in this paragraph or similar positions

may be used. The one-hand grip is used for firing from the standing position. The two-hand grip is used for firing from the prone and kneeling positions.

b. *One-Hand Grip.* The most important feature of the grip is uniformity. For tight shot groups, the grip must be the same each time a shot is fired.

- (1) To obtain the correct grip, pick up the pistol and place it in the firing hand until the grip safety is pressed into the Y formed between the thumb and forefinger of the firing hand. The hand should be as high as possible on the receiver without having the flesh squeezed between the hammer and the grip safety.
- (2) Grip the receiver firmly with the hand and fingers. It is important to maintain the same degree of firmness throughout the firing, because a change in the firmness and position of the grip will change the location of the shot group on the target. A tight grip will cause the strike of the bullet to be low on the target, and a loose grip will cause the shot to hit high on the target. Therefore, a firm grip throughout the course of fire is essential. To obtain a firm grip, the pistol is placed into the Y formed by the thumb and forefinger with the main spring housing resting firmly in the palm of the hand. The lower three fingers are then wrapped around the grip with the index finger resting comfortably under the trigger guard. The thumb is held up and along the left side of the pistol with enough pressure to steady the pistol and to equalize any pressure being exerted on the right side of the pistol by the palm and forefinger.
- (3) Place the trigger finger inside the trigger guard so that the finger will engage the front surface of the trigger (fig. 23). The position of the trigger finger on the trigger will differ among firers; however, the closer to the second joint of the finger to the point of contact with the trigger, the more leverage you can apply to the trigger. Care should be exercised so that the trigger finger does not touch either side of the receiver. Many shooters use the first joint or tip of the finger. This area will afford more sensitivity but less leverage. With the heavy

trigger pull (5 to 6½ lb.) on the service pistol, advantage is gained by using the best leverage and control of the trigger. Each shooter should experiment with the placement of the trigger finger to ascertain which position of the trigger finger gives the best control. The pressure of the trigger finger is straight to the rear, with increasing pressure to cause the weapon to fire.

c. Two-Hand Grip. The two-hand grip is used for firing from the prone or kneeling position. It allows the firer to support the one-hand grip thereby attaining more accuracy. The two-hand grip is obtained as follows: Grip the pistol as prescribed in *b* above; then firmly close the fingers and thumb of the free hand over the firing hand in a manner that will provide maximum support (fig. 22).

d. Standing Position. To assume the standing position, the firer faces his target, then faces slightly more than 45 degrees left or right. The feet are spread 12 to 18 inches apart, and the weight of the body is balanced equally on both feet. The legs are straight without stiffness and the hips level. The stance is adjusted so that his firing arm points naturally at the target (fig. 23). After he assumes this position, the firer picks up the pistol with his free hand and takes the one-hand grip as prescribed in *b* above. When the proper grip is taken, the muscles of the arm are firm without being rigid. The pistol slide is a direct prolongation of the firing



Figure 22. The two-hand grip.



Figure 23. Standing position.

arm, and the wrist is locked so that the weapon cannot search up or down. The elbow is straight and locked. The only pivot during recoil is that of the shoulder joint. After recoil, when the firer is in the correct position, the pistol arm will return to approximate alinement with the target. Due to differences of body conformation of individuals the standing position may vary slightly, but regardless of body conformation, the position assumed should be

relaxed and comfortable. The pistol, held in the firing position, should point naturally and without undue effort at the center of the target. Unless the body, the pistol, and the target are in correct alignment, the firer will be tense while aiming and firing each shot. Muscular tension, in turn, causes trembling, excessive fatigue, and movement of sights in the target area. If this occurs, the entire body must be moved by shifting the feet until the pistol, held in the firing position, points toward the center of the target. The position of the body in the standing position is the same for firing the revolver.

e. Prone Position. The prone position is used by the soldier to obtain maximum stability when firing at 25-meter targets and at longer ranges. This position will be used often in combat as it makes a firer a smaller target and makes for maximum accuracy. To assume the prone position, the firer drops to his knees and falls forward, breaking his fall with his free hand. He lies flat on the ground with legs apart, heels down. The head and body are on a line with the target. The arms are extended with the pistol held in the two-hand grip (fig. 24).

Caution: The arms must be extended far enough to prevent the slide from striking the firer in the face during recoil. This precaution also applies in the kneeling position.

f. Kneeling Position. The kneeling position is used to obtain increased accuracy, in rapid fire, at longer ranges. To assume the kneeling position, the firer kneels on the right knee and rests his left upper arm on the raised left knee (which is pointed toward



Figure 24. The prone position; two-hand grip.

the target), with the elbow projecting beyond the knee to give support. The weight of the body is distributed on the calf of the right leg and heel of the right foot. The receiver of the pistol, held in the one-hand grip, is then seated on the palm of the left hand and the two-hand grip is used (fig. 25). Men who shoot left-handed will reverse the position.

g. Crouch Position, Point Fire. The crouch position is used when surprise targets are engaged at close range. The body is in a forward crouch (boxer's stance) with the knees bent slightly and trunk bent forward from the hips. The feet are placed naturally in a position that will allow another step toward the target. At all times, the body should be maintained in a balanced position, facilitating rapid movement in any direction. The pistol is



Figure 25. Kneeling position; two-hand grip.

extended straight toward the target, and the wrist and elbow of the firing arm are locked

h. Pistol Ready Position. In the pistol ready position, the pistol is held in the one-hand grip. The upper arm is held close to the body, and the forearm is in a horizontal position. The pistol is pointed toward the target area as the firer moves forward.

41. Trigger Squeeze

a. General. Poor shooting is generally caused by the aim being disturbed before the bullet leaves the barrel of the pistol. This is usually the result of the firer jerking the trigger or flinching. The trigger does not have to be jerked violently to spoil the aim; even a slight off-center pressure of the trigger finger on the trigger is enough to cause the pistol to move and disturb the firer's sight alinement. Flinching is a subconscious reflex caused by the firer's anticipating the recoil of the weapon. Jerking is an effort by the firer to fire the pistol at the precise time the sights aline with the target. Flinching and jerking will cause the strike of the bullet to hit the lower left section of the target for a right-hand shooter. Heeling is caused by a firer's tightening the large muscle in the heel of the hand to keep from jerking the trigger. A firer who has had difficulty with jerking the trigger will attempt to correct the fault by tightening the bottom of the hand, which results in a heeled shot. Heeling will cause the strike of the bullet to hit on the top right section of the target. The firer can correct all these shooting errors by understanding and applying correct trigger squeeze. Correctly applied trigger squeeze imparts no unnecessary movement to the pistol. Improper trigger squeeze will cause more misses on the target than any other single step of preparatory marksmanship training.

b. Definition of Trigger Squeeze. Trigger squeeze may be defined as the independent movement of the trigger finger applying a uniformly increasing pressure on the trigger, straight to

the rear, without disturbing the sight alinement until the pistol fires. The trigger slack, or free play, is taken up first and the squeeze is continued steadily until the hammer falls. If the trigger is squeezed properly, the firer will not know when the hammer will fall; thus, he will not know when to flinch or heel. To apply correct trigger squeeze, the trigger finger may contact the trigger anywhere from the tip to the second joint, depending on the length of the trigger finger. If pressure from the trigger finger is applied to the right side of the trigger or pistol, the strike of the bullet will be to the left. This is due to the normal hinge action of the fingers. When the fingers of the right are closed, as in gripping, they hinge or pivot to the left, thereby applying pressure to the left. (With the left hand, this action is to the right.) The firer must exercise care in the squeeze of the trigger, so as not to apply pressure left or right but straight to the rear. The method of trigger squeeze used by the firer will determine his marksmanship ability as follows:

- (1) The man who has learned to apply pressure on the trigger only when the sights are in alinement with the target, who holds the pressure if the muzzle swerves, and continues to add pressure when the sights are again in line with the target is an *excellent shot*.
- (2) The man who holds the sights of the pistol as nearly on the target as possible and continues to squeeze the trigger with a uniformly increasing pressure until the pistol fires, is a *good shot*.
- (3) The man who tries to "catch his target" as his sight alinement moves past the target, and fires the pistol at that instant, is a very *bad shot*.

c. Calling Shot. To call the shot is to state where the bullet should strike the target according to the sight picture at the instant the pistol fires; for example: "high," "a little low," "to the left," "to the right," or "bull's-eye." Another specific method of calling the shot is the clock system; for example: a 9 ring hit at 8 o'clock, and 8 ring hit at 3 o'clock. Another good method of calling a shot is to provide the shooters with a target center. (Placed beside him on the firing line) and as soon as the shot is fired the shooter is required to place a finger on the target face or center at the point where he expected the round to hit on the target. This method eliminates guessing and computation on the part of the shooter, and the immediate action of placing the finger on the target face will give a more accurate call. If the soldier does not call his shots correctly in range firing, he is not properly concentrating on sight alinement and trigger squeeze, and con-

sequently does not know what his sight picture is as the weapon fires.

CHAPTER FIVE — INSPECTION, DETAIL DISASSEMBLY, REPAIR AND REPLACEMENT

Section I

INSPECTION PRIOR TO DISASSEMBLY

42. GENERAL.

Inspections prior to disassembly include a careful visual inspection of the assembled pistol, trigger pull tests, and four safety tests.

CAUTION: *When a pistol is received for repairs, make certain that the chamber is unloaded. It is possible that a cartridge has become jammed so that the pistol is in a dangerous condition when received. Proceed with caution when removing the damaged cartridge. It should be removed by inserting a cleaning rod into the muzzle and pushing the cartridge out.*

43. VISUAL INSPECTION.

a. The pistol is inspected as a unit to note its general appearance, the action of the slide, and the smoothness of operation. The alinement of sights is also verified. Examination is made for split stocks and missing stock screws.

44. TRIGGER PULL TESTS.

a. Trigger pull tests are made to determine the number of pounds pull required to move the trigger causing the hammer to fall. To make the test, the hammer is cocked and the grip safety depressed. Two weights and a piece of wire are required to make the tests. The wire should be looped at one end so that it will hook over the trigger without contacting the side of the pistol. Its lower end should be arranged to hold the necessary weights. The pistol is held in the hand in a vertical position, the thumb depressing the grip safety. With the lighter weight attached to the lower end, the wire is then hooked over the trigger; the lower end with the weight resting on the bench or floor. The pistol is then lifted carefully. This weight should not cause the hammer to fall. It is then replaced by the heavier weight which should cause the hammer to fall. If the lighter weight causes the hammer to fall, the trigger pull is below the specified limit. If the heavier weight does not cause it to fall, the pull is too heavy. In either case, correction of trigger pull must be made (par. 51b).

45. SAFETY TESTS.

a. The following safety tests should be performed on each pistol prior to disassembly:

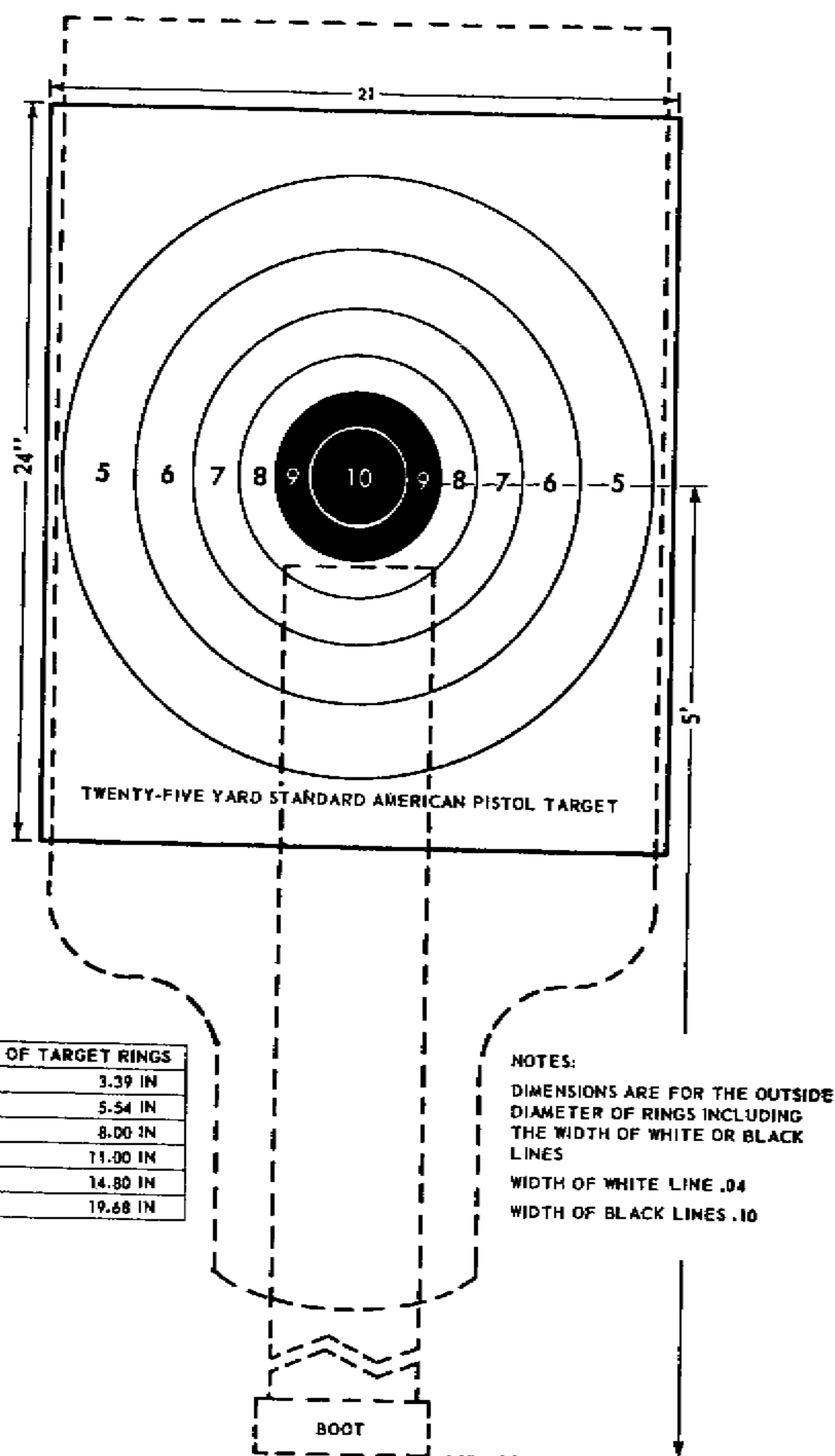

Figure 26. Standard American 25-yard pistol target mounted on E target.



Figure 27. — Pistol M1911A1, Hammer Back, Safety Lock Upward in Safety Position, Hand Grasping Stock So Grip Safety Is Depressed, Finger Squeezing Trigger

(1) SAFETY LOCK TEST (fig. 27). With the pistol unloaded, cock the hammer and press the safety lock upward into the safe position. Grasp the stock so that the grip safety is depressed and squeeze the trigger



Figure 28. — Pistol M1911A1, Hammer Cocked, Grip Safety Not Depressed, Finger Squeezing Trigger



Figure 29. — Pistol M1911A1, Hammer at Half-Cock Notch, Finger Squeezing Trigger



Figure 30. — Pistol M1911A1, Hammer Back Nearly to Full Cock, Thumb Slipping Off Hammer

tightly three or four times. If the hammer falls, the safety lock is not safe and must be repaired.

(2) GRIP SAFETY TEST (fig. 28). With the pistol unloaded, cock the hammer, and without depressing the grip safety, point the pistol



Figure 31. — Pistol M1911A1, Hammer Cocked, Slide Partly Back, Finger Squeezing Trigger

downward and squeeze the trigger three or four times. If the hammer falls or the grip safety is depressed by its own weight, the grip safety is not safe and must be repaired.

(3) **HALF-COCK TEST** (fig. 29.). With the pistol unloaded, draw back the hammer until the sear engages the half-cock notch. Then squeeze the trigger. If the hammer falls, the hammer or sear must be replaced or repaired. Draw the hammer back nearly to full cock and then let it slip (fig. 30). It should fall only to half cock, otherwise it should be replaced.

(4) **DISCONNECTOR TEST** (fig. 31). With the pistol unloaded, cock the hammer. Shove the slide $\frac{1}{4}$ inch to the rear, and holding it in that position, squeeze the trigger. Let the slide go forward, maintaining the pressure on the trigger. If the hammer falls, the disconnecter is worn on top and must be replaced. Pull the slide all the way to the rear and engage the slide stop. Squeeze the trigger and at the same time release the slide. The hammer should not fall. If it does the disconnecter is faulty (fig. 32.). Now release the pressure on the trigger and then squeeze it. The hammer should then fall. If it does not check the sear spring for weakness, and if not weak, then the disconnecter is faulty. The disconnecter normally prevents the release of the hammer unless the slide and barrel are in the forward position, safely interlocked. This also prevents the firing of more than one shot at each squeeze of the trigger.



Figure 32. — Pistol M1911A1, Slide Fully Back, Slide Stop Engaged, Finger Squeezing Trigger, Thumb Releasing Slide, Hammer Back

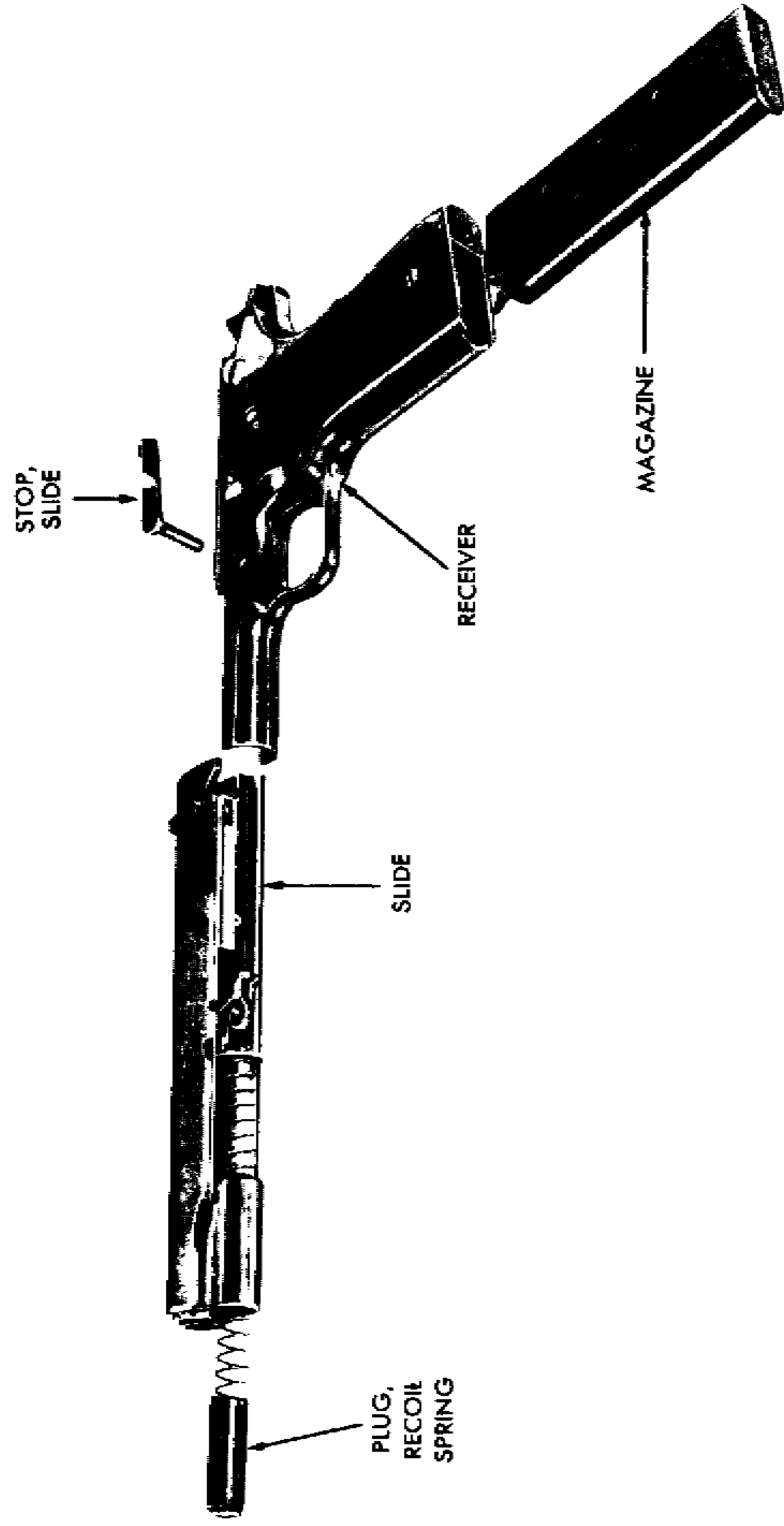

Figure 33. — Subassemblies of Pistol M1911A1 — Exploded View

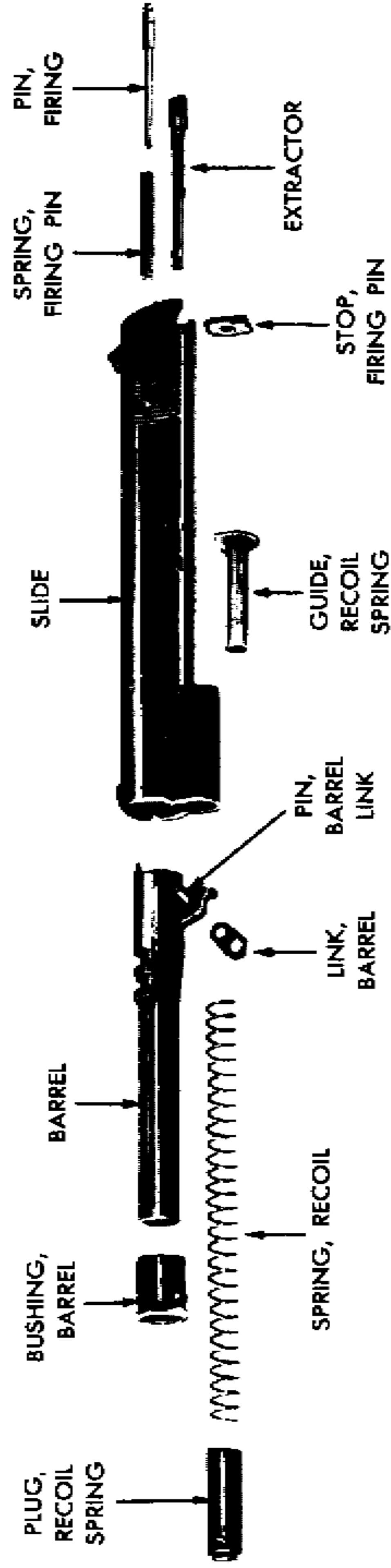

Figure 34. — Slide Group of Pistol M1911A1 — Exploded View

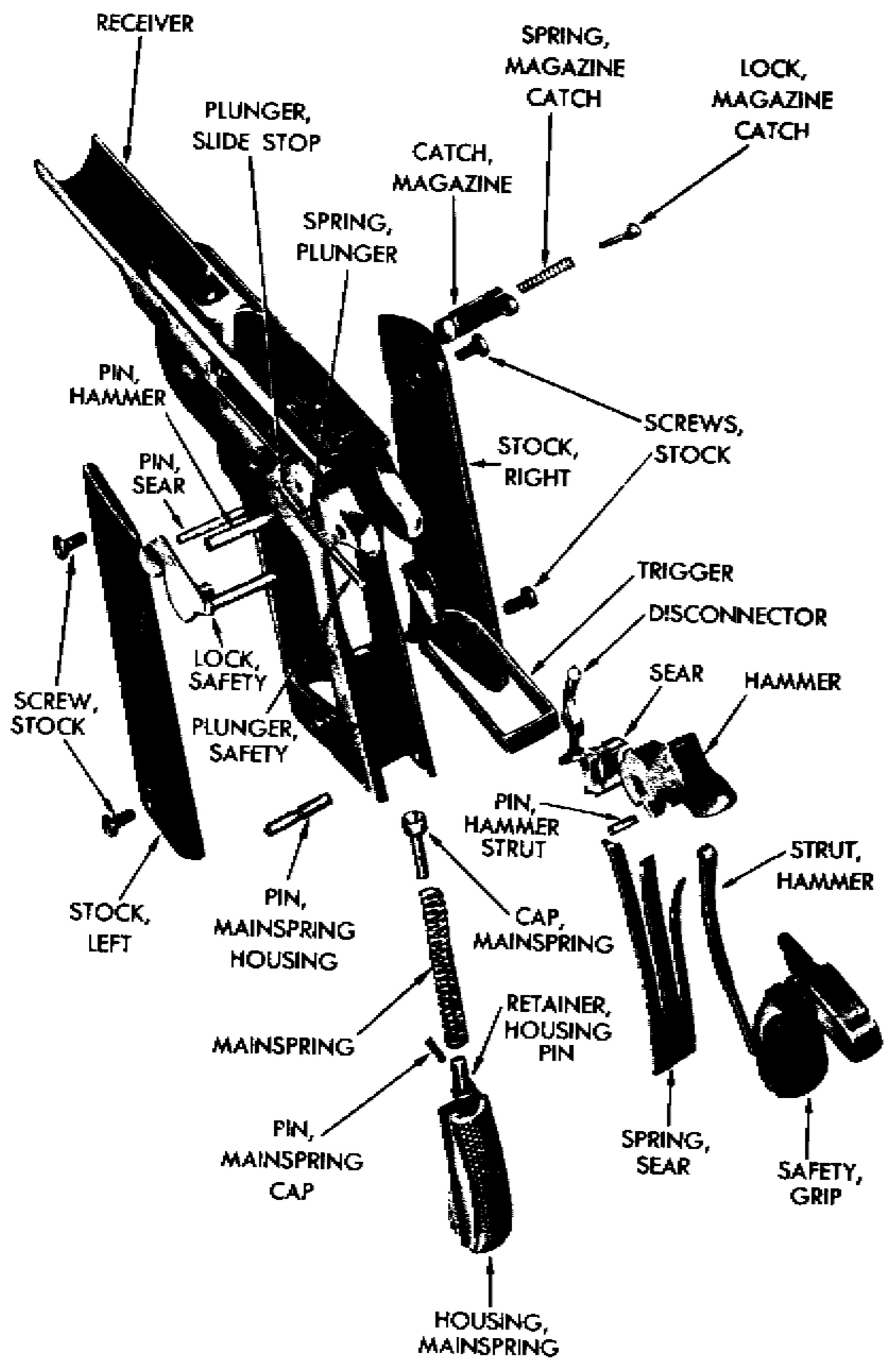

Figure 35. — Receiver Group of Pistol M1911A1 — Exploded View

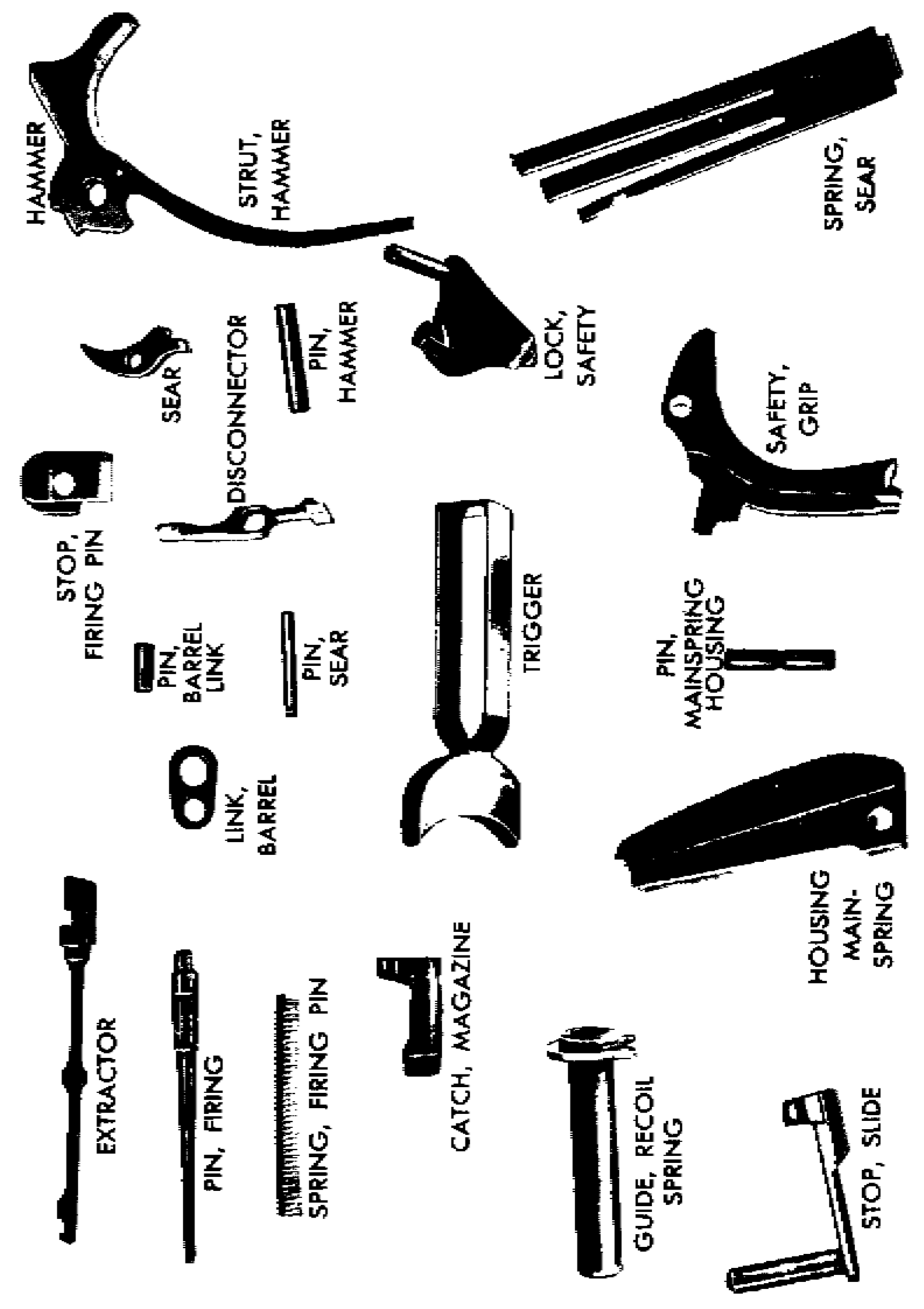

Figure 36. — Group of Smaller Parts of Pistol M1911A1

Section II.
DETAIL
DISASSEMBLY

46. DISASSEMBLY OF PISTOL.

a. To disassemble the pistol, proceed as follows:

(1) Remove the magazine by pressing the magazine catch. Press the recoil spring plug inward and turn the barrel bushing clockwise until the recoil spring plug and the end of the recoil spring protrude from their seat (fig. 37). This releases the tension of the recoil spring. The finger and thumb should be kept over the recoil spring plug so that it will not jump away and be lost or strike the operator.

(2) Draw the slide rearward until the middle notch of the slide stands above the projection on the thumb piece of the slide stop (fig. 38). Now press gently against the end of the pin of the slide stop which protrudes from the right side of the receiver above the trigger guard.



Figure 37. — Removing Recoil Spring Plug from Pistol M1911A1

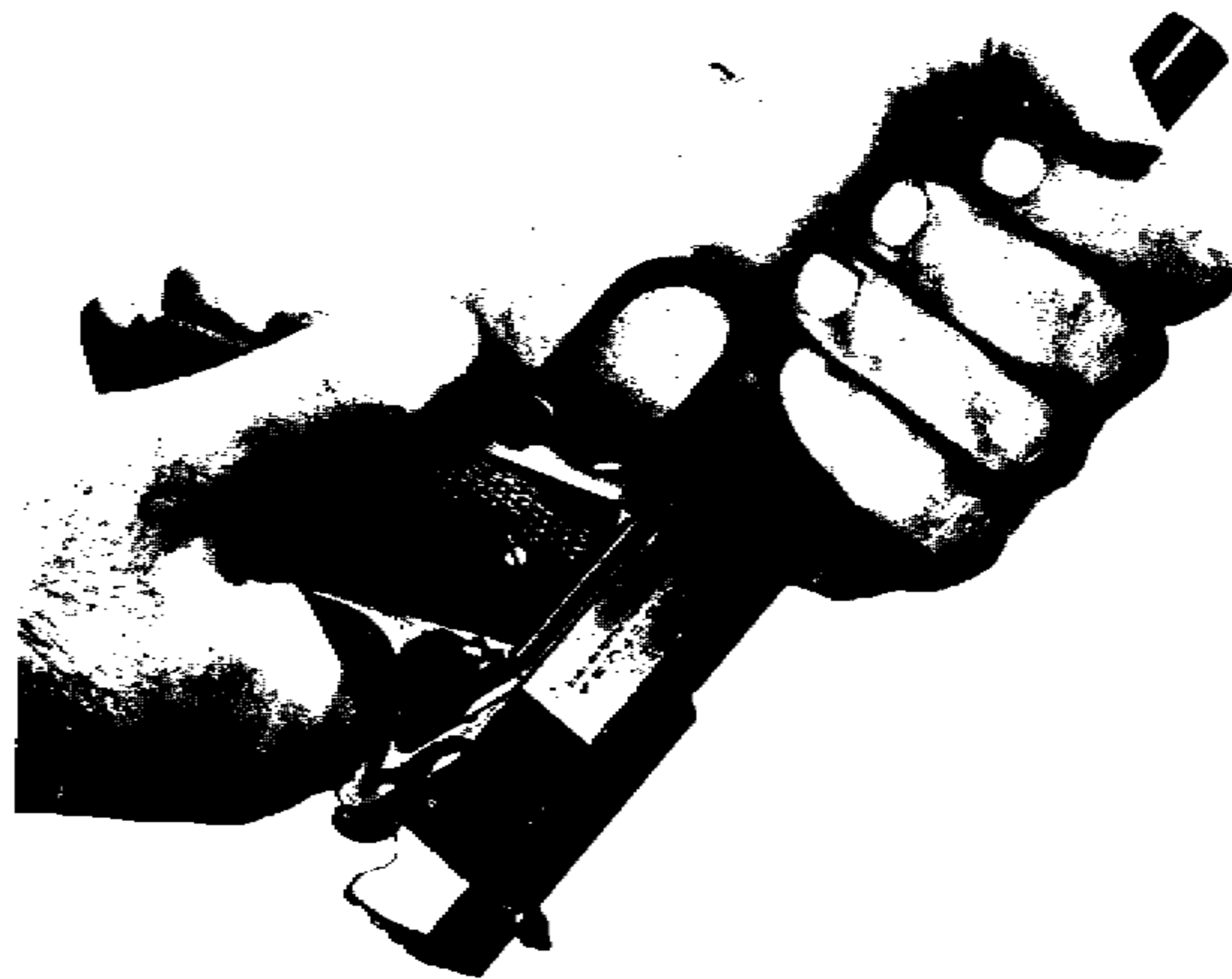

Figure 38. — Lining Up Slide Stop of Pistol M1911A1

Push the slide stop from the right side and pull it out from the left side (fig. 39). This releases the barrel link, allowing the barrel with the link and the slide assembly to be drawn forward, together, from the receiver.

(3) Withdraw the recoil spring plug from the recoil spring by twisting counterclockwise slightly. Then pull out the spring and spring guide from the rear of the slide.

(4) Next, turn the barrel bushing counterclockwise until it may be drawn forward from the slide (fig. 40). This releases the barrel, which with the barrel link, may be drawn forward from the slide. By pushing out the barrel link pin, the barrel link is released from the barrel.

(5) Press the rear end of the firing pin forward with a small punch until it clears the firing pin stop. The stop can then be drawn downward from its seat in the slide. The firing pin and firing spring are then removed from the rear of the slide. The finger and thumb should be kept over the spring so it will not jump away. The extractor is pried out to the rear with a punch or screwdriver. This completes the disassembly of the slide.



Figure 39. — Removing Slide Stop Pin from Pistol M1911A1

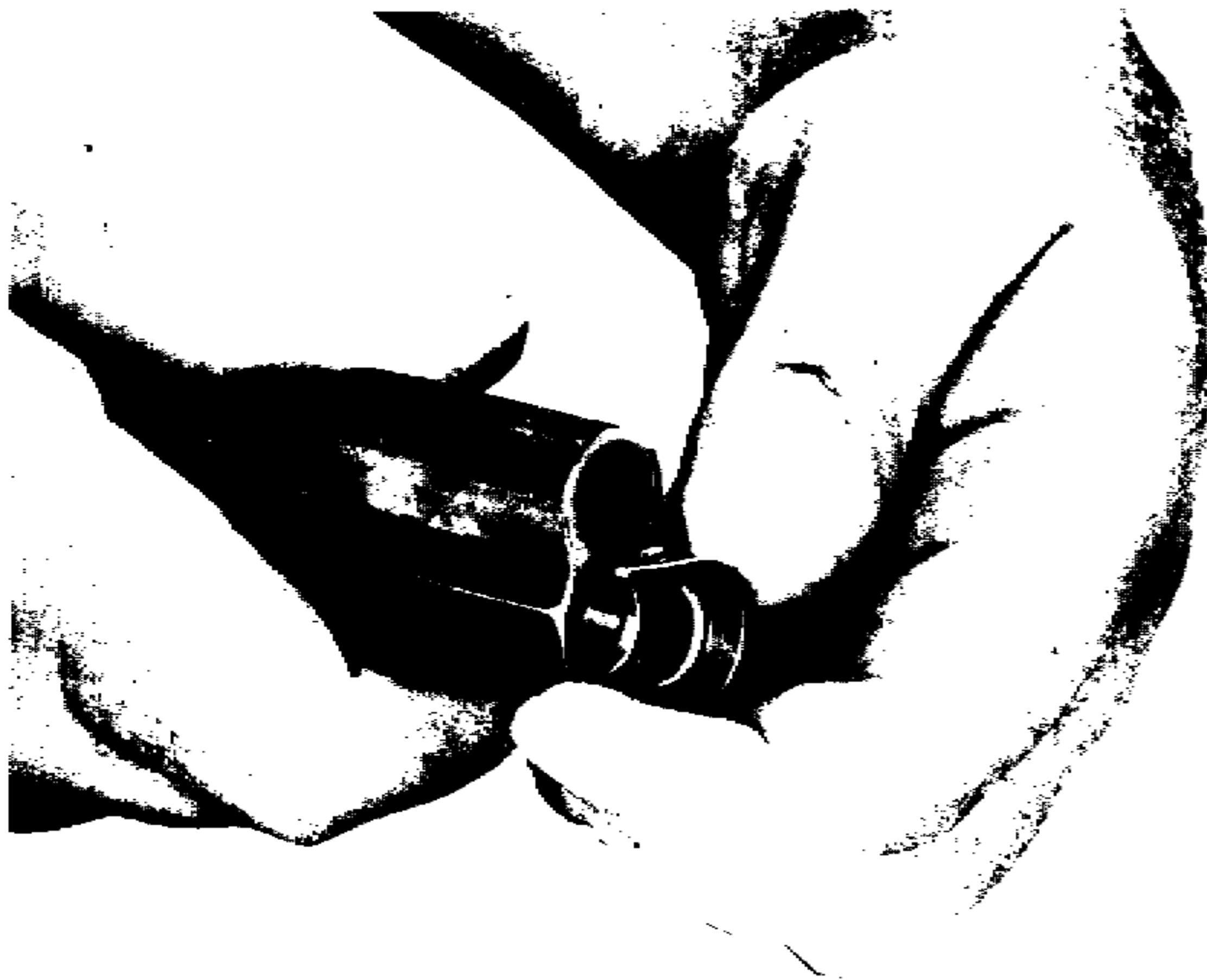

Figure 40. — Removing Barrel Bushing from Pistol M1911A1



Figure 41. — Removing Safety Lock from Pistol M1911A1

(6) The safety lock (thumb safety) is readily withdrawn from the receiver by cocking the hammer, placing the lock midway between the upper and lower positions (fig. 41.), and pushing from the right on the pin part.

(7) After removing the hammer pin from the left side of the receiver, lower and remove the cocked hammer with the hammer strut.

CAUTION: Retard the hammer with the thumb to avoid breaking it.

(8) Push or drive the mainspring housing pin from the right side of the receiver by placing a punch on the recessed end of the pin. This allows the mainspring housing to be withdrawn downward and the grip safety rearward from the handle. The sear spring may then be removed. By pushing out the sear pin from the right to the left side of the receiver, the sear and disconnecter are released. To remove the mainspring, mainspring cap, and housing pin retainer from the mainspring housing, mount the housing in a vise having protected jaws, compress the mainspring by placing a punch on the mainspring cap, and push out the mainspring cap pin with a small drift.

b. **Old Style Magazine Catch Lock.** Special care should be used when removing the magazine catch from the receiver. Its checkered left end must be pressed inward flush with the receiver. Its right end



Figure 42.— Disassembling Old Design Magazine Catch from Pistol M1911

will then project so far from the right side of the receiver that it may be rotated counterclockwise one-half turn (fig. 42.). This movement will release the magazine catch lock from its seat in the receiver, when the catch, the catch lock, and the spring may be removed. Note that the magazine catch pin is removed by pushing and rotating it as indicated above. It is not a screw.

e. New Style Magazine Catch Lock. With the improved design of magazine catch lock, the operation of dismounting the magazine catch is simplified. Press the magazine catch inward and turn the magazine catch lock a quarter turn counterclockwise by means of a screwdriver (fig. 49). The magazine catch with its contents can then be removed. The improved design will be recognized from the fact that the head of the magazine catch lock is slotted.

- (1) The trigger can now be removed rearward from the receiver.
- (2) The long arm of a screwdriver can be used to push out all the pins except the mainspring cap pin, the lanyard loop pin, and the ejector pin. For these pins, a drift of proper size must be used.
- (3) The slide stop plunger, the safety lock plunger, and the plunger spring may be pushed to the rear, out of the plunger tube.



Figure 43. Hold the hammer, squeeze the trigger, and ease the hammer forward. Using the safety lock as a drift, press out the mainspring housing pin.



Figure 44. To remove the grip safety, slide the mainspring housing down about 1/2 inch and lift out the grip safety. Remove the mainspring housing by sliding it from the receiver. Disassemble the mainspring housing only when necessary for cleaning.

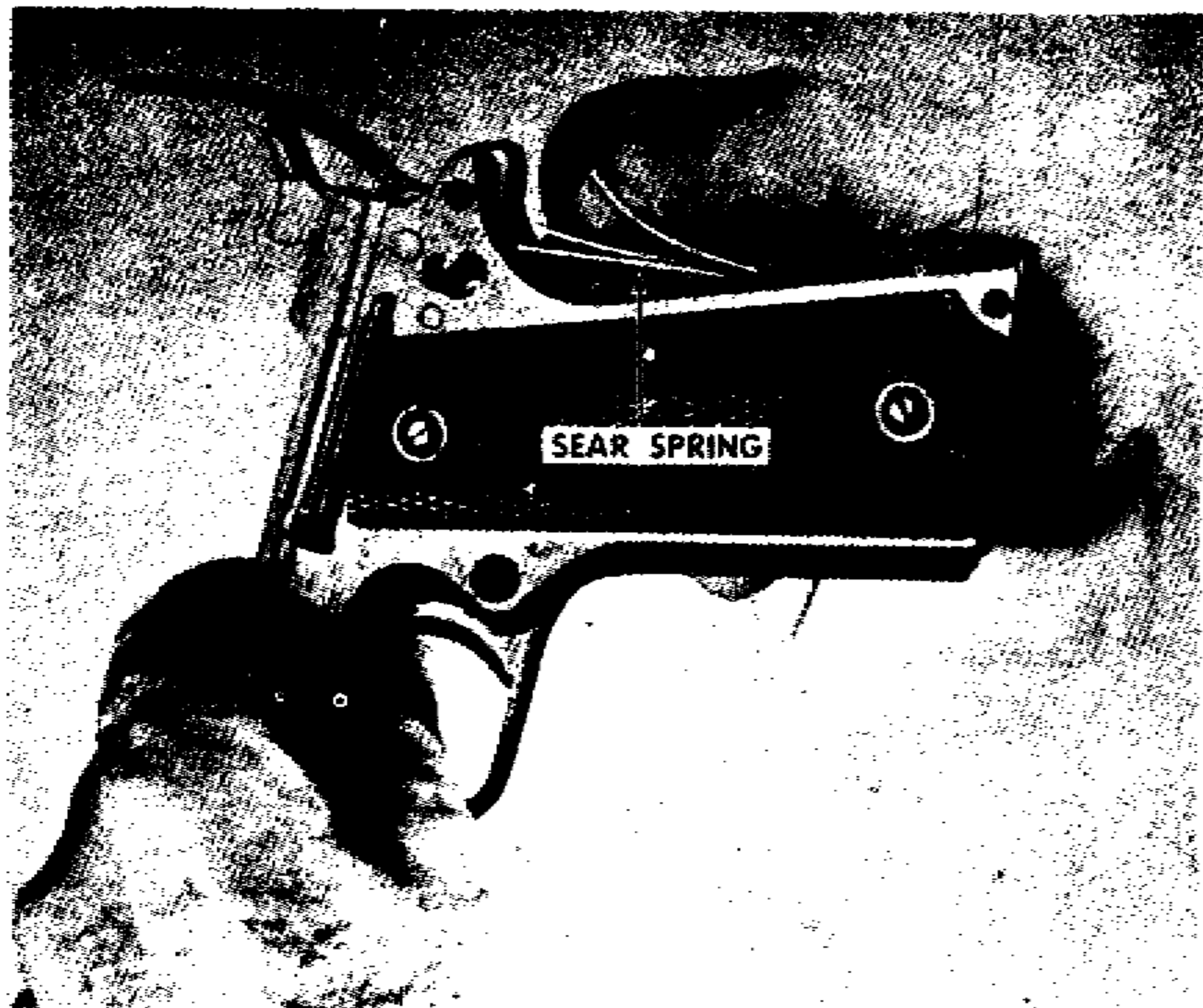

Figure 45. Lift out the sear spring.

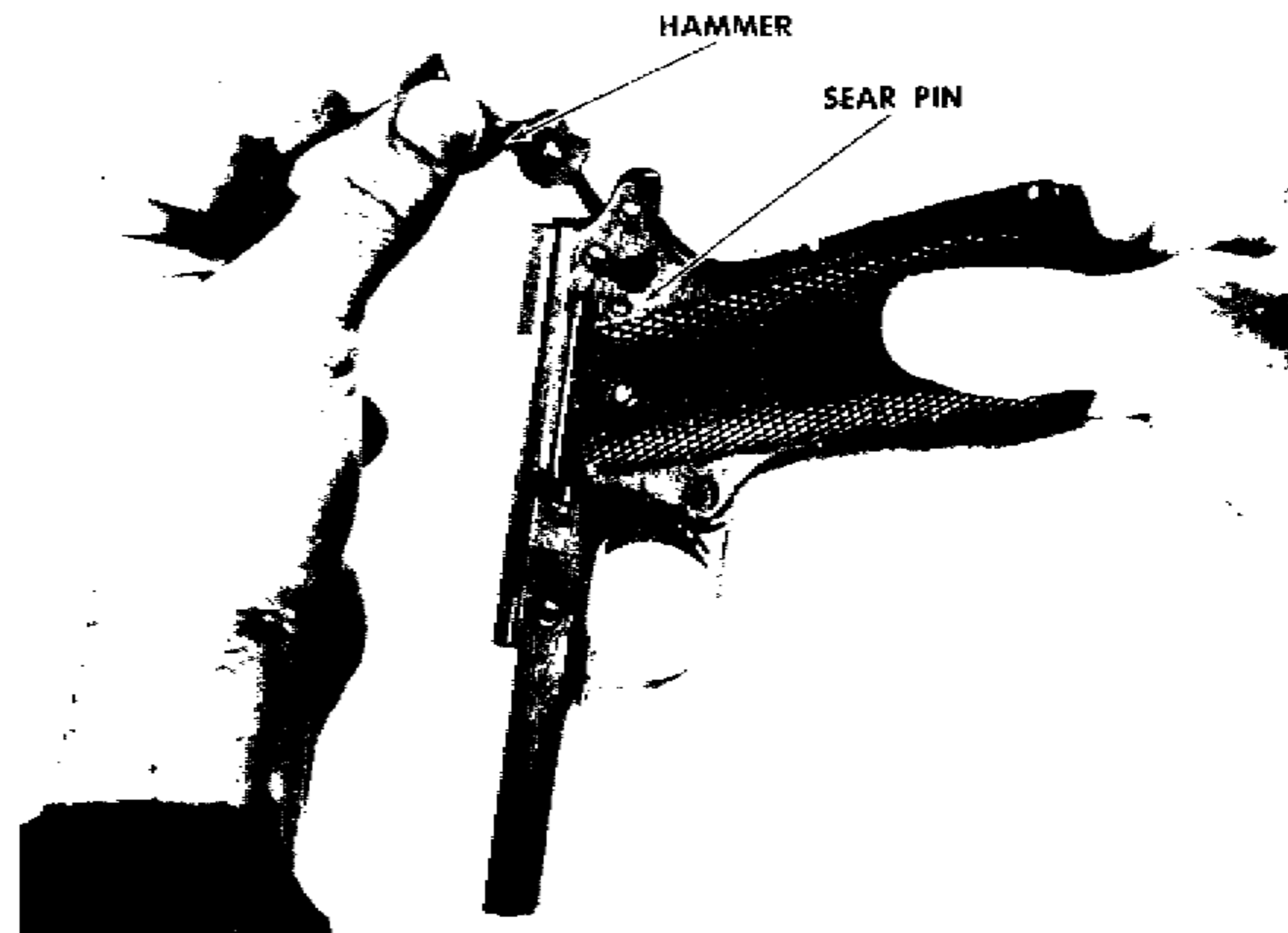

Figure 47. Lift the hammer from the receiver. Drift out the hammer strut pin and separate the parts. (Caution: If the hammer strut pin is peened in place, do not remove it.) Remove the sear pin from the left side of receiver. Elevate the front end of the receiver and allow the sear and disconnecter to drop into the hand.



Figure 46. Remove the hammer pin from the left side of the receiver.



Figure 48. Withdraw the safety lock plunger, slide stop plunger, and plunger spring. Remove the stock screws and stocks from the receiver.

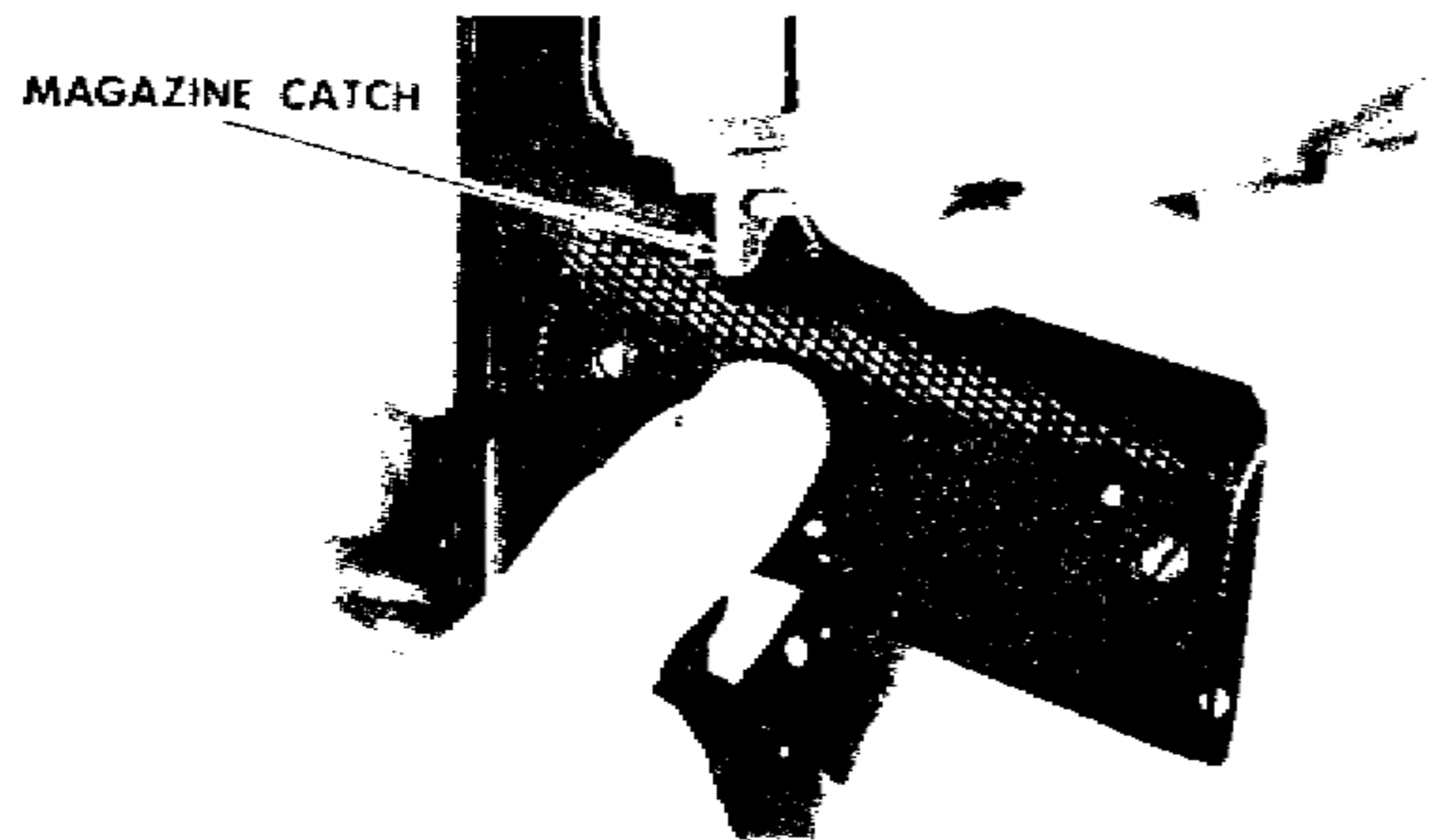

Figure 49. Press the magazine catch in until it is flush with the left side of the receiver. Using the short leaf of the sear spring as a screwdriver, turn the lock $\frac{1}{4}$ turn counterclockwise. The lock should turn easily. If it does not check to see that the magazine catch is flush with the left side of the receiver. Force should not be used to turn the lock. Lift out the magazine catch. (Caution: Do not use the long leaf of the sear spring as a screwdriver.) To disassemble the magazine catch, turn the lock clockwise and separate the parts. Remove the trigger by elevating the front end of the receiver.

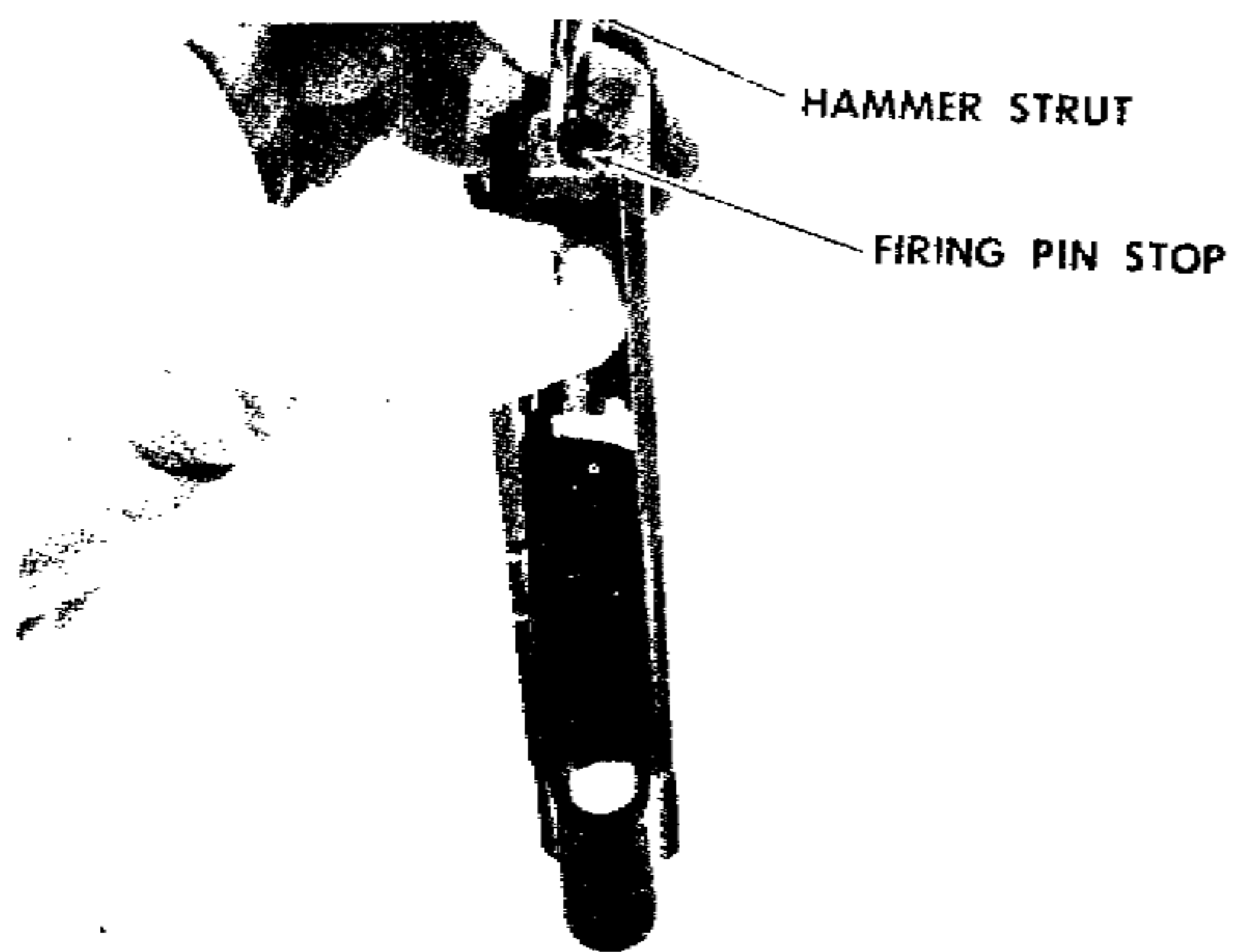
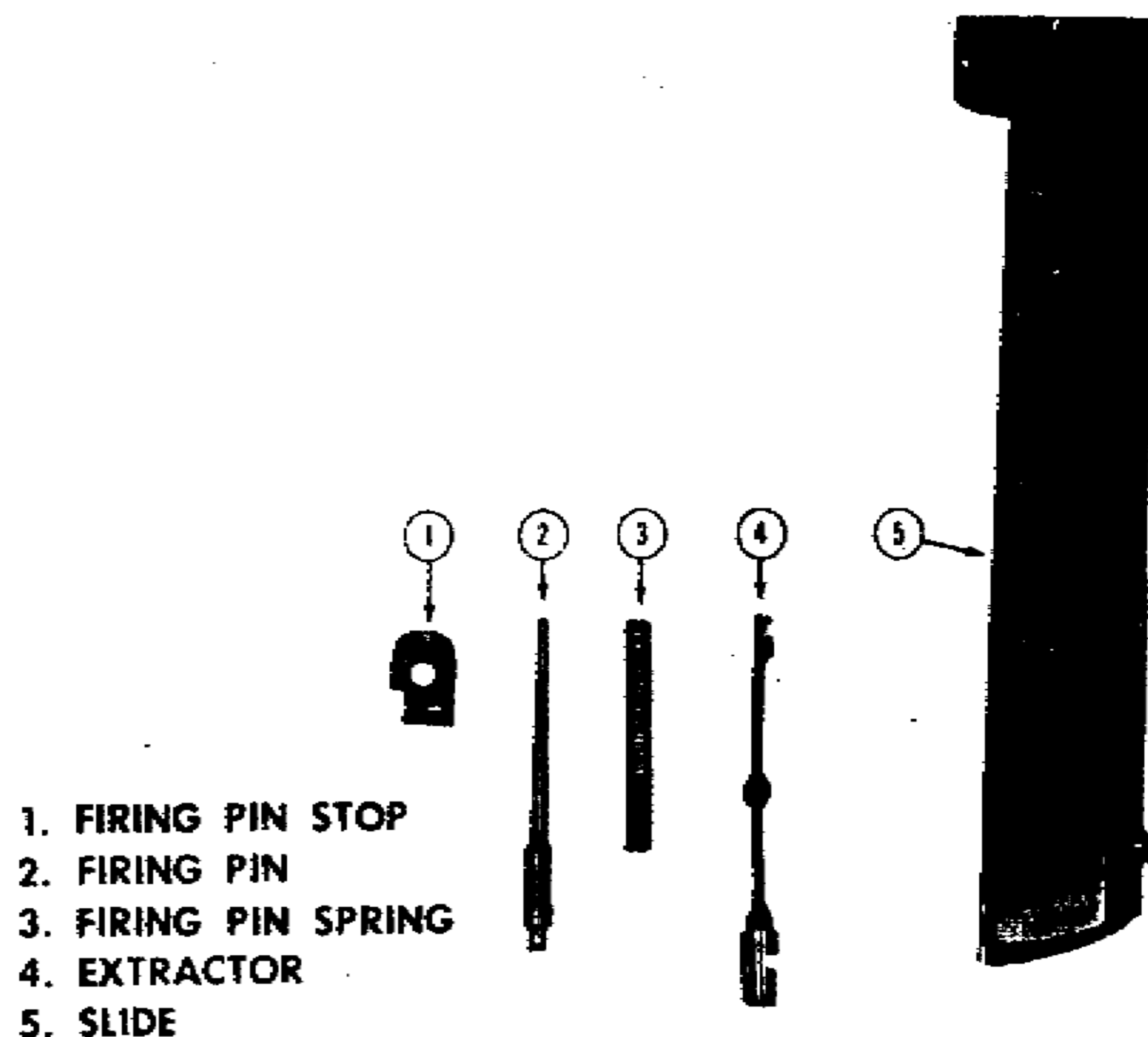

Figure 50. Using the hammer strut as a drift, press in on the firing pin and remove the firing pin stop. Remove the firing pin and firing pin spring. Separate the two parts.



Figure 51. With the hammer strut, pry out and remove the extractor.



1. FIRING PIN STOP
2. FIRING PIN
3. FIRING PIN SPRING
4. EXTRACTOR
5. SLIDE

Figure 52. Parts of the slide in order of detailed disassembly.



- | | | |
|--------------------------------|------------------------------|---|
| 1. SAFETY LOCK | 9. HAMMER | 17. TRIGGER |
| 2. MAINSPRING HOUSING PIN | 10. HAMMER STRUT PIN | 18. SAFETY LOCK PLUNGER, SLIDE STOP PLUNGER, AND SPRING |
| 3. GRIP SAFETY | 11. HAMMER STRUT | 19. STOCK SCREW |
| 4. MAINSPRING HOUSING | 12. SEAR PIN | 20. STOCK |
| 5. MAINSPRING CAP RETAINER PIN | 13. DISCONNECTOR | 21. EJECTOR |
| 6. MAINSPRING | 14. SEAR | 22. RECEIVER |
| 7. SEAR SPRING | 15. MAGAZINE CATCH | |
| 8. HAMMER PIN | 16. MAGAZINE LOCK AND SPRING | |

Figure 53. Parts of the receiver group in order of detailed disassembly.



Figure 55. — Disassembling New Design Magazine Catch from Pistol M1911A1

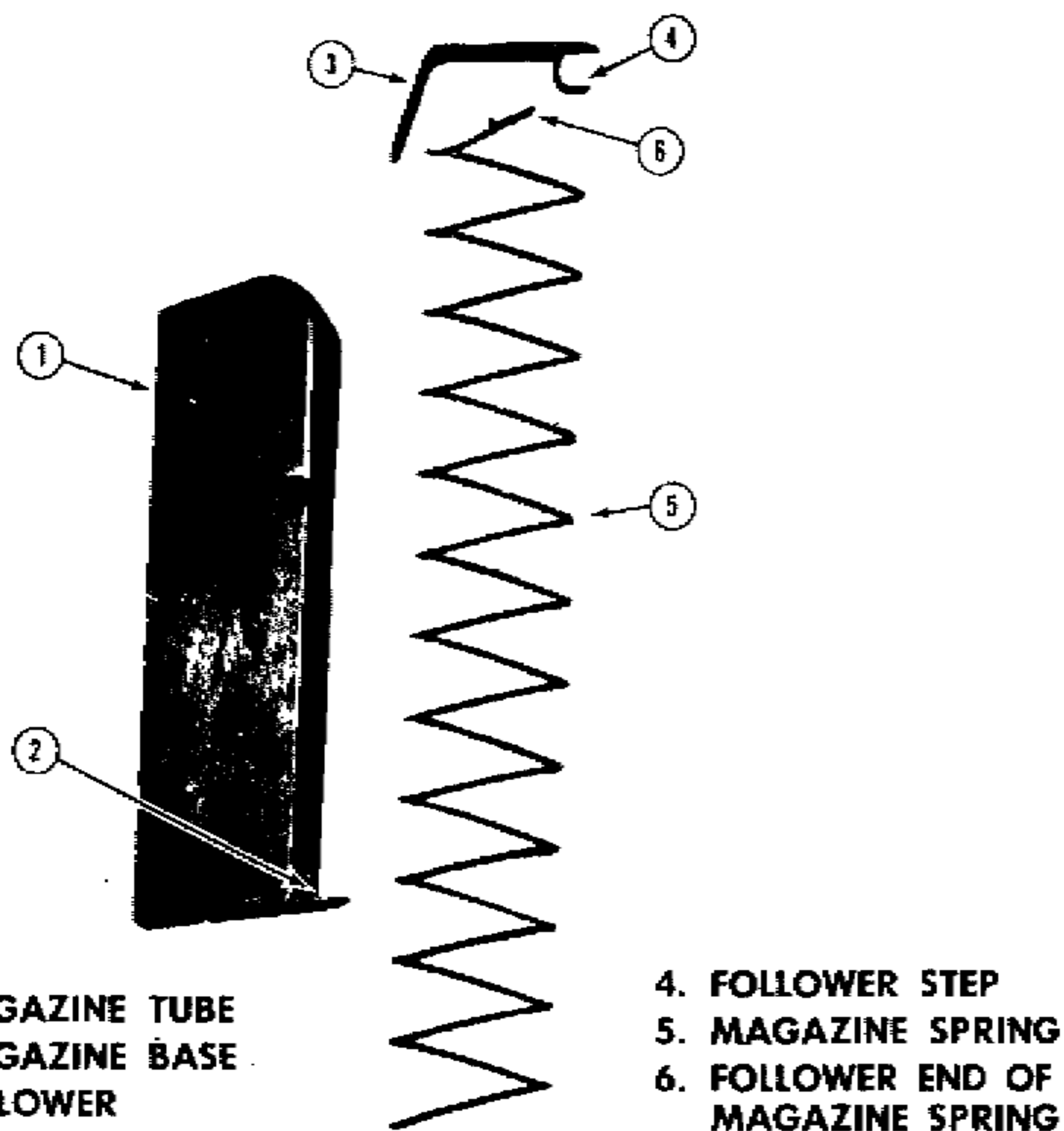

- | | |
|------------------|------------------------------------|
| 1. MAGAZINE TUBE | 4. FOLLOWER STEP |
| 2. MAGAZINE BASE | 5. MAGAZINE SPRING |
| 3. FOLLOWER | 6. FOLLOWER END OF MAGAZINE SPRING |

Figure 54. The magazine assembly shown in detailed disassembly.

47. DISASSEMBLY OF MAGAZINE.

a. Ordinarily the magazine should not be disassembled except for cleaning or to replace the magazine follower or the magazine spring. When it is required, proceed as follows:

(1) Push the magazine follower downward about $\frac{1}{4}$ inch. This compresses the magazine spring. Hold the magazine spring by inserting the end of a drift through one of the small holes in the side of the magazine and then slide out the magazine follower. Hold the hand over the end of the magazine before removing the drift from the hole in order to prevent the magazine spring from jumping out of the magazine. (The floor of the magazine may also be removed by knocking out the two floor plate pins, but this is done only in making emergency repairs.)

Section III.

INSPECTION AFTER COMPLETE DISASSEMBLY

48. CAUSES OF MALFUNCTIONING.

a. Important causes of malfunctioning of the parts of the pistol are as follows:

(1) MAJOR MOVING PARTS.

Part	Condition to be Checked
Barrel bushing, (fig. 56.)	Burs.
Recoil spring	Tension.
Mainspring housing	Burs and tension of mainspring.
Sear spring	Tension and broken leaves.
Sear	Worn nose or tip and breakage and wear of lugs.
Hammer, (fig. 57.)	Worn sear notches and broken hammer strut.

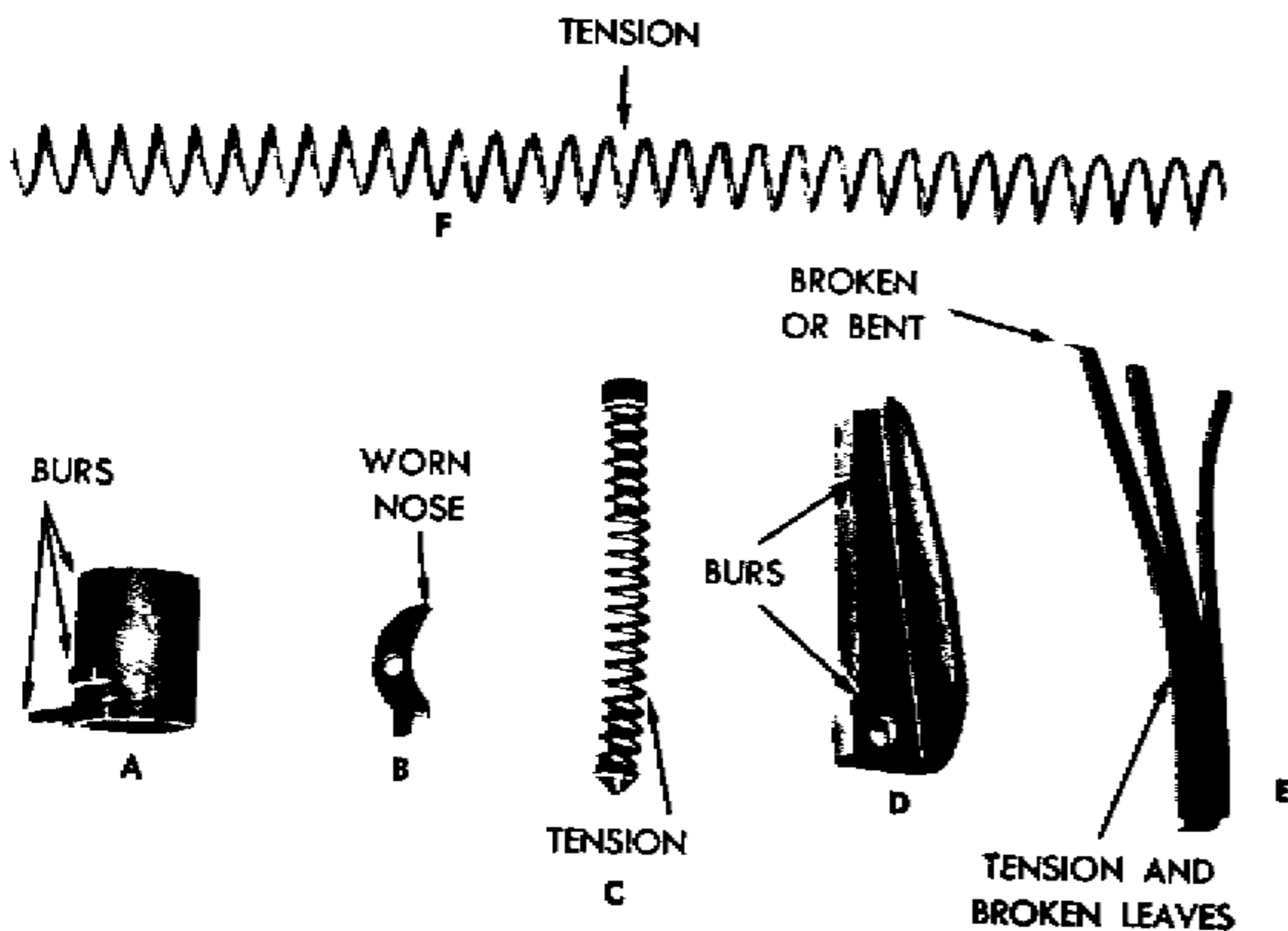

Figure 56. — Showing Points to Be Inspected On:
 a. Barrel bushing; b. Sear; c. Mainspring; d. Mainspring housing;
 e. Sear spring; f. Recoil spring

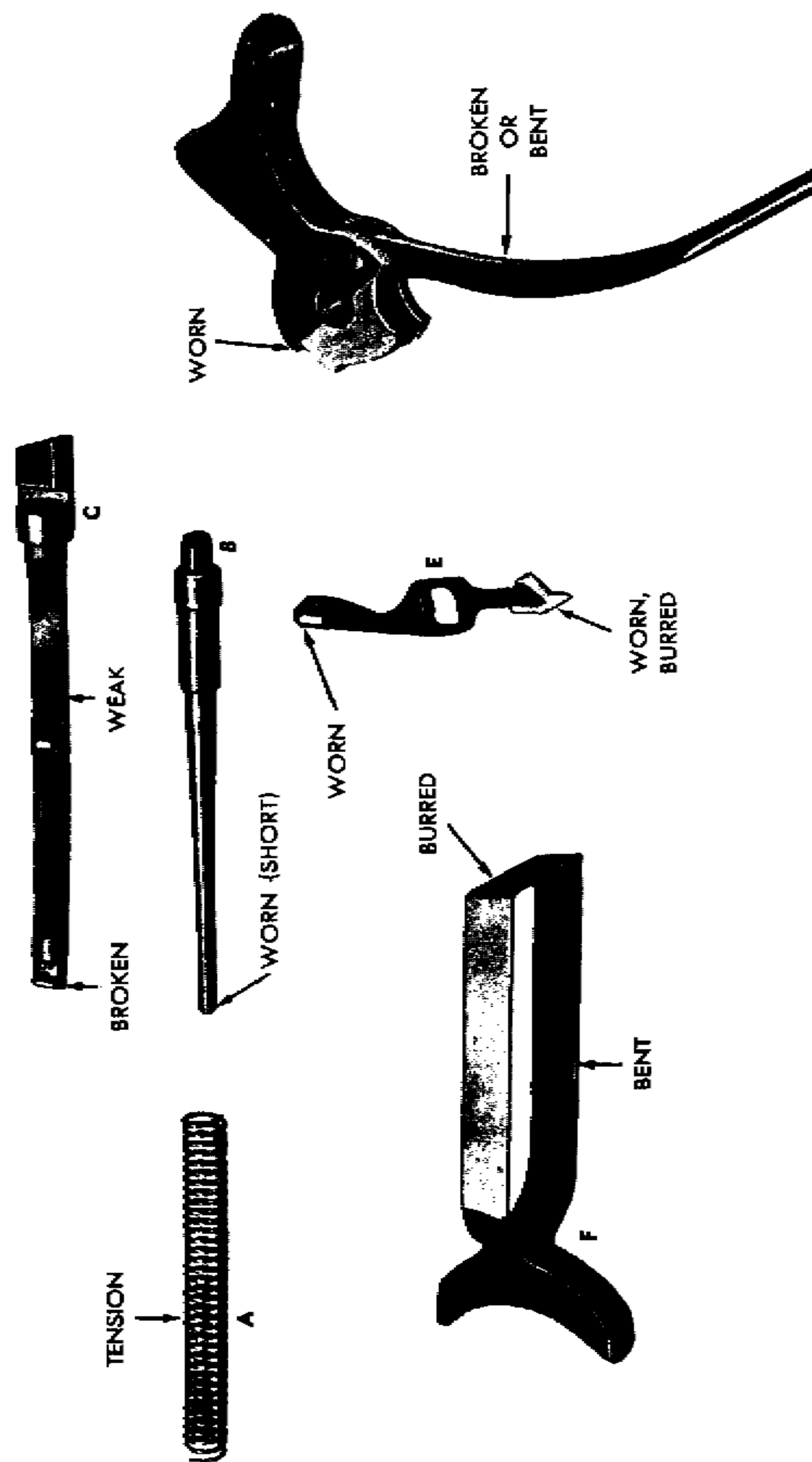

Figure 57. — Showing Points to Be Inspected On:
 a. Firing pin spring; b. Firing pin; c. Extractor; d. Hammer; e. Disconnector; f. Trigger

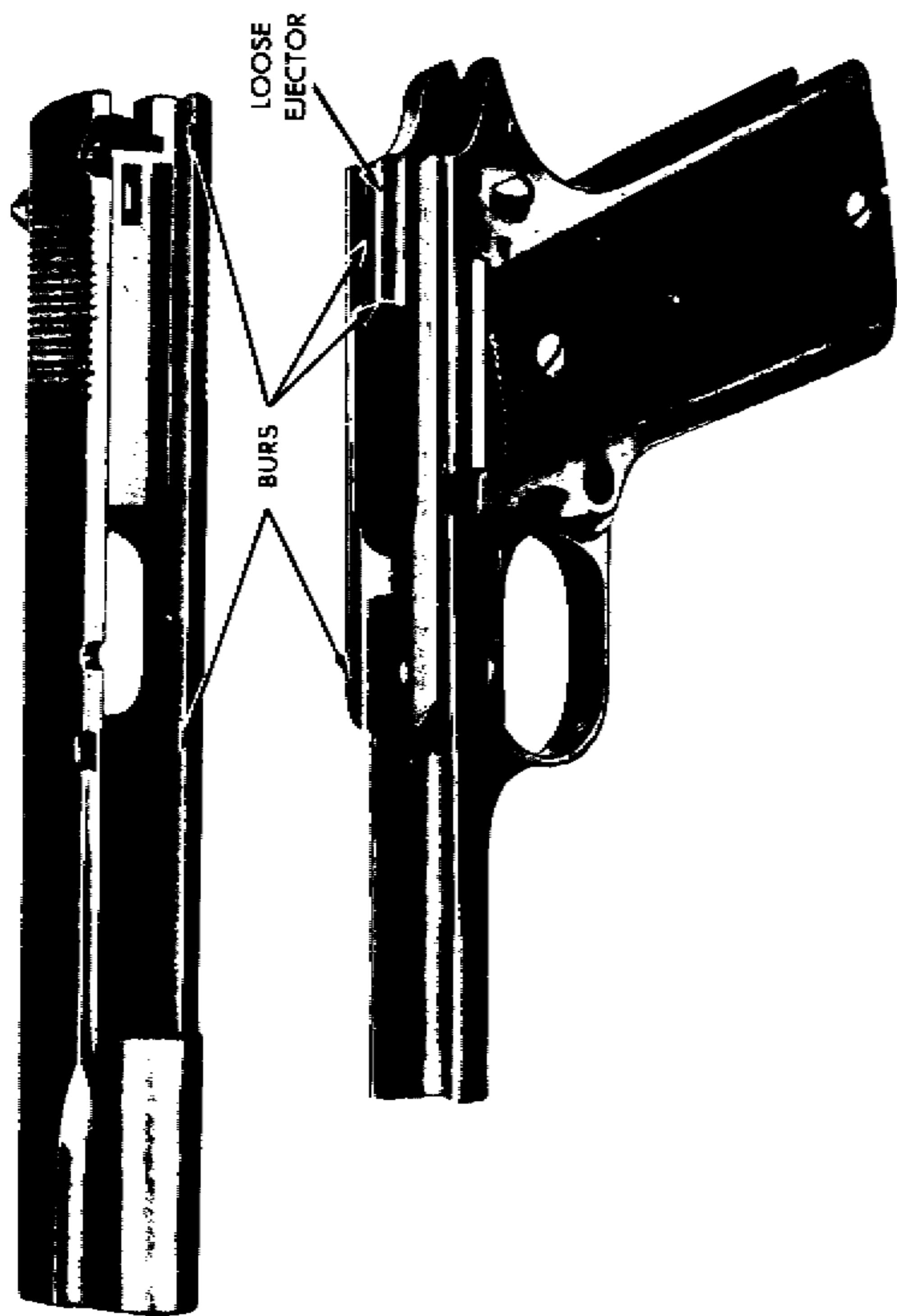

Figure 58. — Slide and Receiver of Pistol M1911A1 Showing Points to Be Inspected

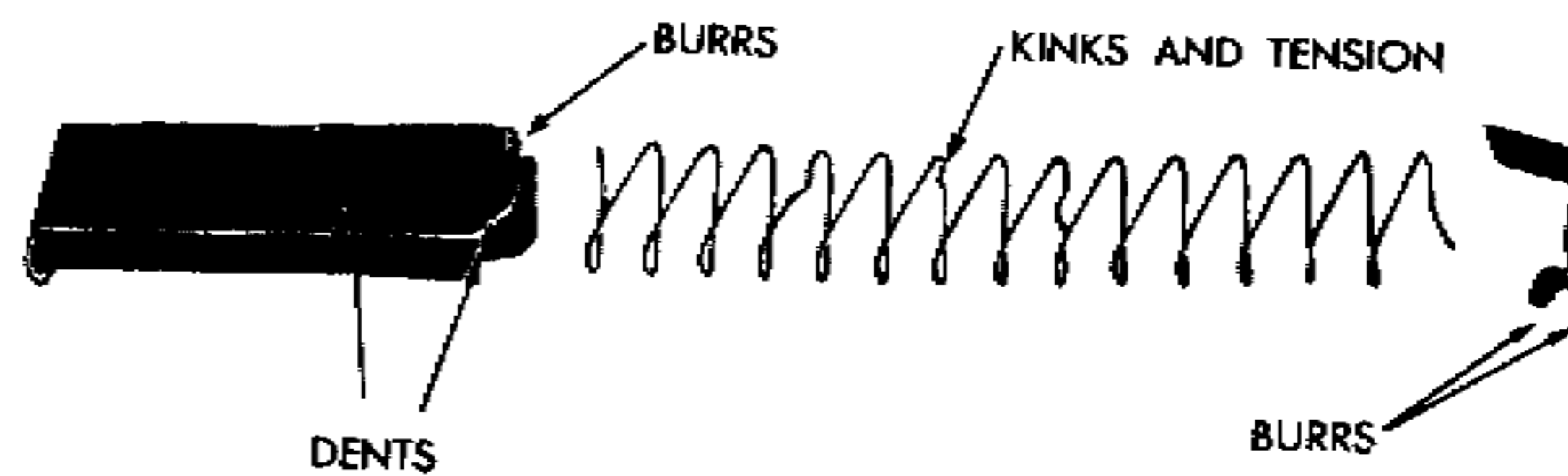

Figure 59. — Magazine of Pistol M1911A1 — Exploded View Showing Points to Be Inspected

Part	Condition to be Checked
Disconnecter	Burs or wear.
Trigger	Burs or bending.
Firing pin	Short length or wear.
Firing pin spring	Tension.
Extractor	Broken or weak claw.
Receiver (fig. 58.)	Burs, loose ejector, and defacement of markings.
Slide	Burs on recoil guideways and locking recesses, and front and rear sight.

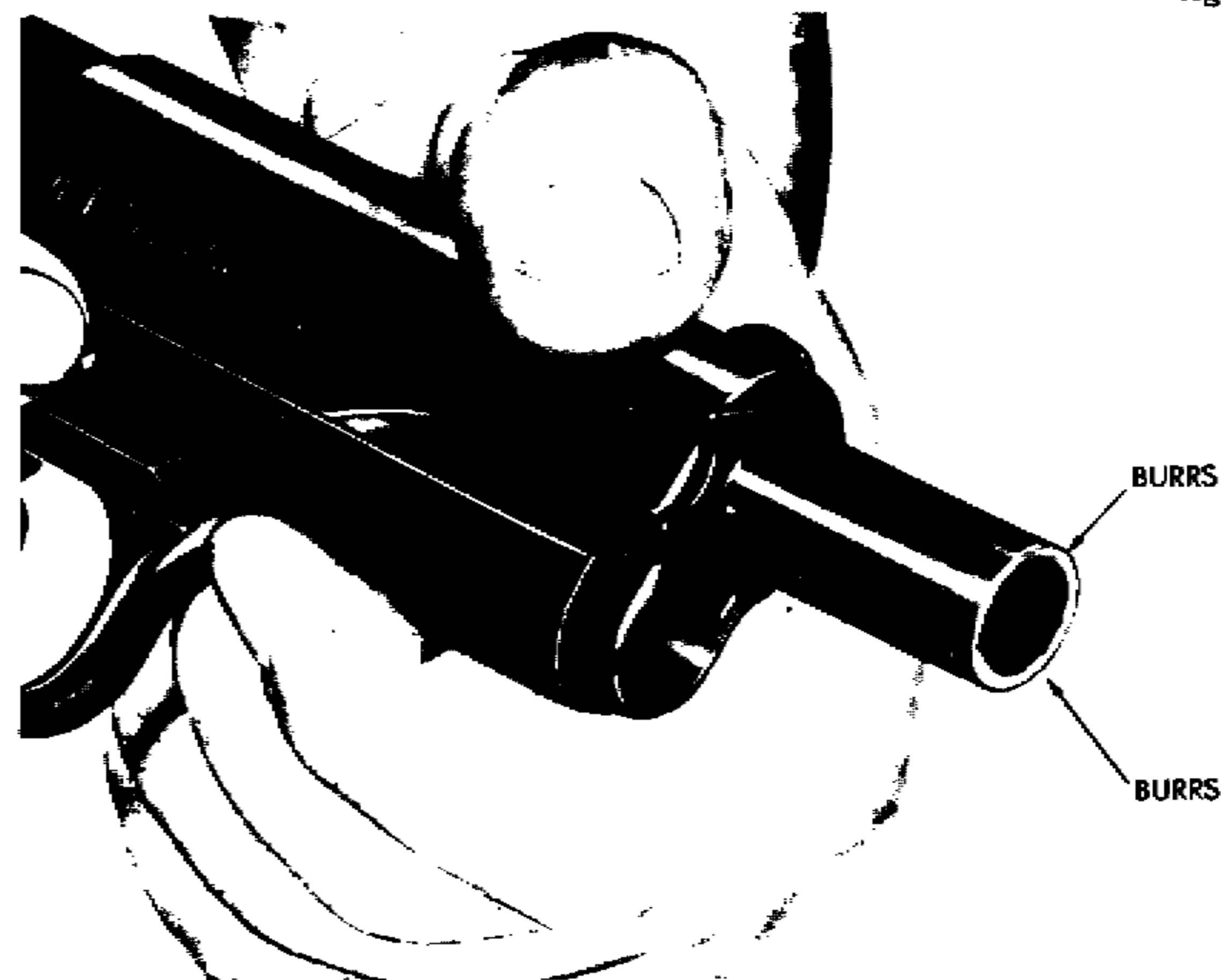

Figure 60. — Exterior of Muzzle End of Barrel of Pistol M1911A1 Showing Points to Be Inspected

REPAIRS AND REPLACEMENTS

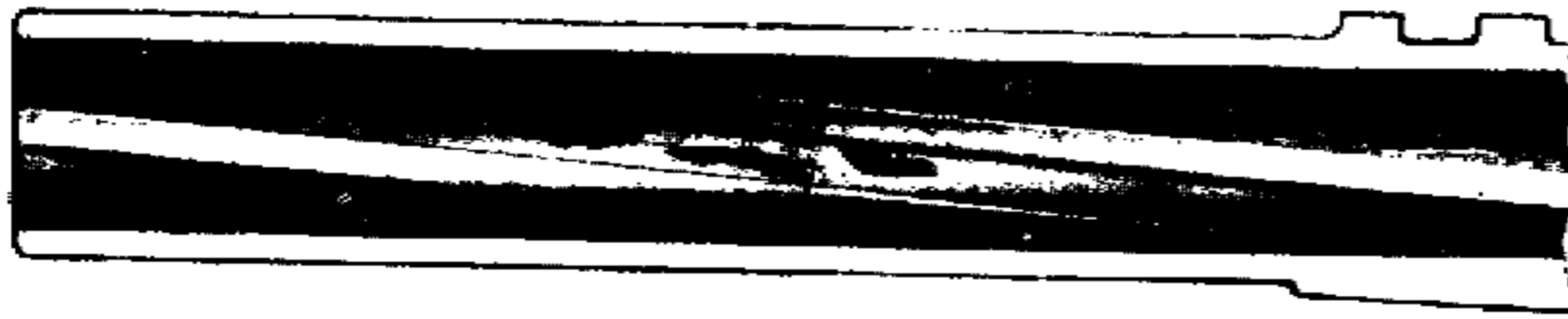

Figure 61. — Interior of Barrel of Pistol M1911A1 Showing Slight Pitting (But Free from Bulges) and Sharp Lands

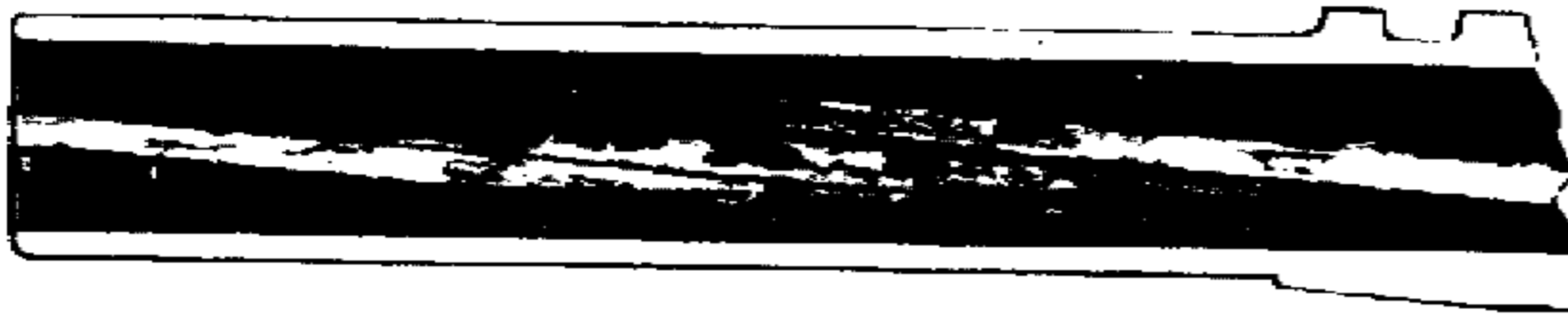
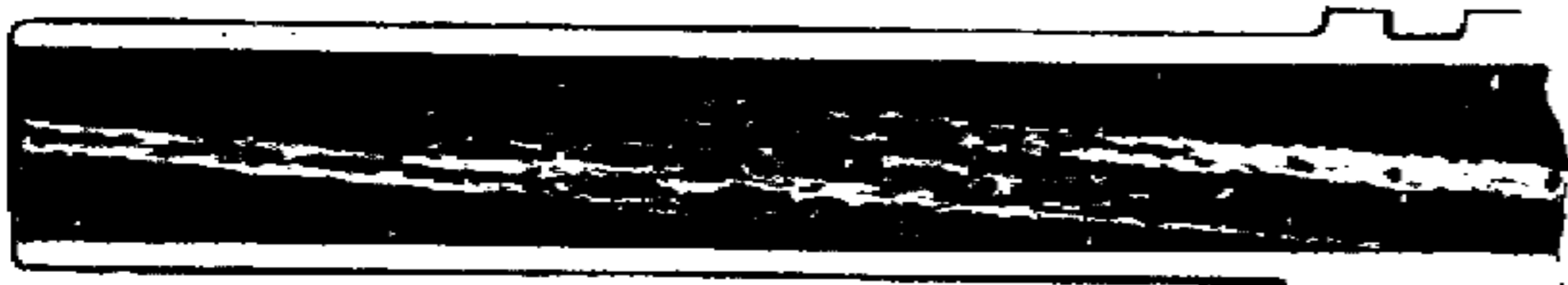

Figure 62. — Interior of Barrel of Pistol M1911A1 Showing Pitting and Dull Lands



If the lands are pitted and have lost their sharpness, the barrel will be inaccurate and should be replaced. This is due to neglect.

Figure 63. — Interior of Barrel of Pistol M1911A1 Showing Pitting, Worn Lands, and Burs on Interior of Muzzle

(2) **MAGAZINE.**

The magazine as a unit
(fig. 59.)

Burs and dents.

Magazine spring

Kinks and tension.

Magazine follower

Burs and bending.

(3) **BARREL.** Inspection of the barrel, causes for rejection, and method of examination are as follows:

(a) Burs on the exterior rim of the muzzle should be stoned off. If on the interior, the barrel should be rejected (fig. 60).

(b) If the barrel is free from pits and bulges and the lands are sharp and distinct, the barrel is serviceable (fig. 61).

(c) If the barrel is pitted, but free from bulges and has sharp lands, it is still serviceable and will be sufficiently accurate. However, this implies that the barrel has not been given proper care and should be so reported (fig. 62).

49. GENERAL.

a. Since all parts of the pistol are standardized as to their dimensions, repairs to a large degree consist of making the necessary replacement of worn, bent, or broken parts. In some cases, parts can be bent back or otherwise returned to their proper shape with satisfactory results. This applies to the leaves of the sear spring, the trigger, and the hammer strut. A worn sear notch in the hammer may be corrected by stoning or filing. Dents in the magazine usually may be removed and the lips returned to original shape by bending. Burs on the muzzle of the pistol should be stoned off :

50. REPLACEMENT OF PARTS.

a. Where parts or assemblies are broken or worn so as to render them unserviceable, they must be replaced from stock. Often only parts of the assembly will be worn or broken and others can be salvaged. However, should it take more time to remove serviceable parts than they are worth, the entire assembly should be scrapped. In quantity overhauling of pistols, the parts of each should be kept separate for ease in determining to which pistol they belong.

51. REPAIRS.

a. Burs on cams and on other smooth surfaces should be removed to make the part serviceable. A very fine file is used, and care is taken to remove as small an amount of metal as possible. Where roughened surfaces are present on moving parts, an oil stone should be used.

b. **Correction of Trigger Pull.** Pistols received from the field usually have a trigger pull varying over a slightly wider range than new or repaired pistols (par. 2 a for trigger-pull data). Too heavy or too light pull may be corrected by stoning the mating surfaces of the sear and hammer until they meet squarely. Do not stone off the notch in the hammer at an angle as this may decrease the safety of the pistol. The trigger pull also may be varied up to approximately ½ pound by bending the leaf of the sear spring slightly. The mainspring may require replacement if the pull remains too light after making these corrections. All pistols should be tested for trigger pull, as outlined in paragraph 44 after making repairs, and before they are again placed in storage or service.

Section V

REASSEMBLY

52. REASSEMBLY OF MAGAZINE.

a. To reassemble the magazine, proceed as follows: Use a blunt-ended tool to compress the magazine spring into the magazine about $\frac{1}{4}$ inch below the top to permit inserting the end of a drift through one of the small holes in the side of the magazine. The spring should be held below the slot where the magazine follower enters and leaves the magazine. Then insert the magazine follower and withdraw the drift.

53. REASSEMBLY OF PISTOL.

a. Assemble the slide stop plunger, the safety lock plunger, and the plunger spring forward into the plunger tube.

b. Install the ejector pin, the lanyard loop pin, and the hammer strut.

c. Push the trigger forward into position through the receiver.

d. To replace the improved design of magazine catch, insert the catch and turn it one-quarter turn to the right with a screwdriver. To replace the old type magazine catch, carefully insert it in the receiver, press inward and turn it clockwise one-half turn.

e. To replace the mainspring, mainspring cap and housing pin retainer in the mainspring housing, insert the retainer, the mainspring and cap in the housing, compress the spring with a punch, and insert the small cap pin. Do not insert in receiver, see operation h.

f. To reassemble the disconnecter and sear, first place the cylindrical part of the disconnecter in its hole in the receiver with the flat face or lower part of the disconnecter resting against the yoke of the trigger (fig. 64). Then place the sear (lugs downward) so that it straddles the disconnecter. By squeezing the trigger slightly, the three parts will snap into alinement. Next, insert the sear pin from the right side so that it passes through both the disconnecter and the sear.

g. Replace the hammer in the uncocked position and insert the hammer pin from the left side of the receiver.

h. To replace the sear spring (the sear, disconnecter and hammer being in place and hammer down) locate its lower end in the cut in



Figure 64. — Reassembling Sear and Disconnecter on Pistol M1911A1



Figure 65. — Replacing Sear Spring on Pistol M1911A1



Figure 66. — Pressing Safety Lock Plunger Home on Pistol M1911A1, to Allow Seating of Safety Lock: Hammer Cocked

the receiver with the end of the long leaf resting on the sear (fig. 65). Now insert the mainspring housing until its lower end projects below the frame about $\frac{1}{8}$ inch. Next, put the grip safety into position, cock the hammer and replace the safety lock.

i. To assemble the safety lock to the receiver, use a screwdriver to press the safety lock plunger home (fig 66.). This allows the seating of the safety lock. Now release the cocked hammer. (Be sure the strut enters the recess in the cap in the housing.)

j. To reassemble the slide, first insert the firing pin spring, firing pin, and extractor into the rear end of the slide. Push the firing pin forward until it clears the firing pin stop position and insert the firing pin stop. Be sure the extractor is aligned to allow the firing pin stop to enter its recess. Note that the rounded top edge matches the curve on the surface in the slide.

k. To reassemble the barrel into the slide, push the barrel link into position in the barrel and insert the barrel link pin. Now insert the barrel in the slide from the forward end. Insert the barrel bushing in



Figure 67. — Replacing Slide and Barrel on Receiver, Barrel Link Tilted Forward and Link Pin In Place On Pistol M1911A1

the slide and turn counterclockwise until locked. Place the recoil spring in position.

l. Now hold the slide upside down with the barrel outward and push the barrel and guide forward as far as possible. Turn the receiver group upside down and assemble it to the slide in that position (fig. 67). Make sure that the barrel link is tilted forward as far as possible when assembling the receiver to the slide. Push the receiver forward as far as possible.

m. Turn the pistol right side up, and making sure that the hole in the barrel link is lined up with the hole in the receiver, insert the pin end of the slide stop from the left side of the pistol. Move the slide forward until the projection on the slide stop is opposite the middle notch of the slide. Press the slide stop inward and upward into position (fig. 68). Allow the slide to move to its foremost position.

n. Cock the hammer and engage the safety lock. Place the recoil spring plug over the end of the recoil spring and push the spring and



Figure 68.— Reassembling Slide Stop Pin After Replacing Slide On Pistol M1911A1

plug into position. Turn the barrel bushing until its lips are alined around the plug and release the pressure on the plug.

a. Insert the magazine by pushing smoothly yet firmly into position until it is engaged by the magazine catch.

54. Test for Correct Assembly

To test the pistol for correct assembly, pull the slide fully to the rear and release it by pushing down on the slide stop; the hammer should remain cocked. Hold the pistol in a normal grasp to depress the grip safety and squeeze the trigger. The hammer should fall.



RA PD 23962

Figure 69. Damage caused by firing with bullet lodged in bore, cal..45 automatic pistol M1911.

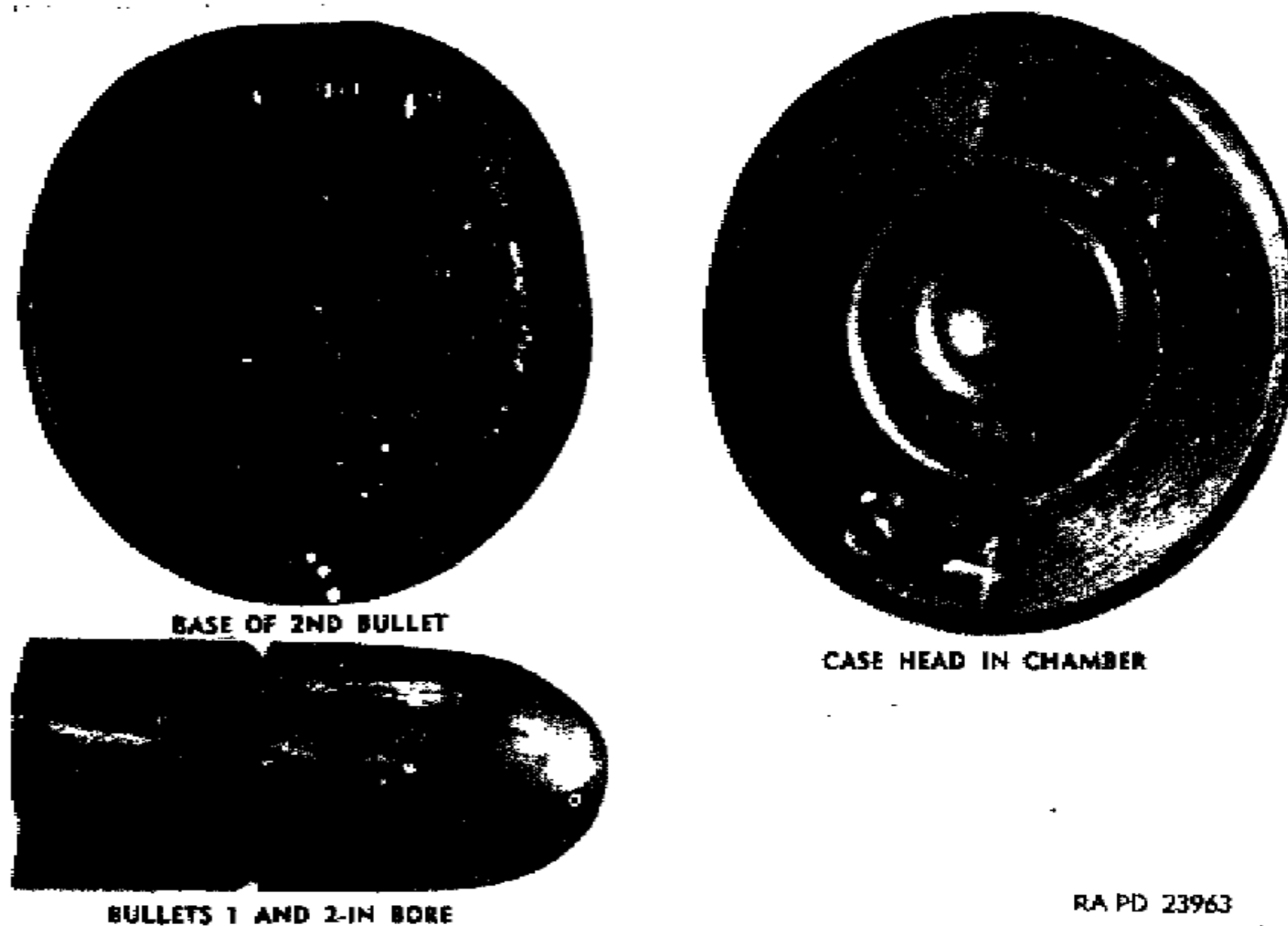

RA PD 23963

Figure 69 a Ammunition damaged by bore obstruction in cal..45 automatic pistol M1911.

Section VI. EFFECTS AND PROBABLE CAUSES OF ACCIDENTS AND MALFUNCTIONS

55. Typical Cases

a. Worn and Defective Parts.

(1) Malfunctions are often caused by the following:

- (a) Burs, dents, kinks, and bending of magazine parts and loss of tension in the springs.
- (b) Excessive wear and looseness of moving parts.
- (c) Pits, bulges, rust, burs, and uneven and indistinct lands in the barrel

(2)

Figure 72 shows damage to the breech end of another pistol after the metal had become fatigued by long usage. Note the coarse structure of the metal at the break.

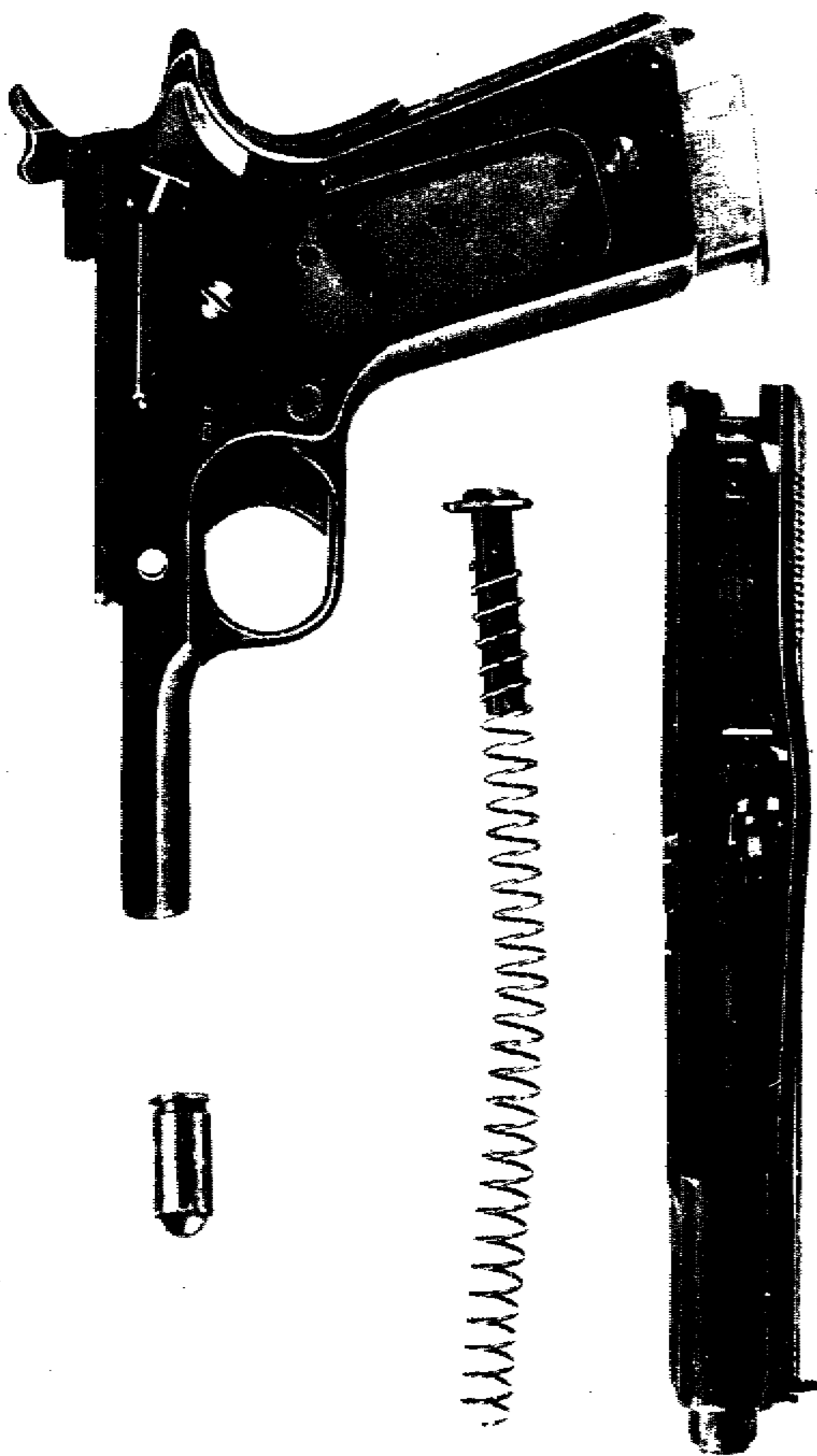

RA PD 23961

Figure 70. Damage caused by firing with grease in chamber and bore, cal..45 automatic pistol M1911.

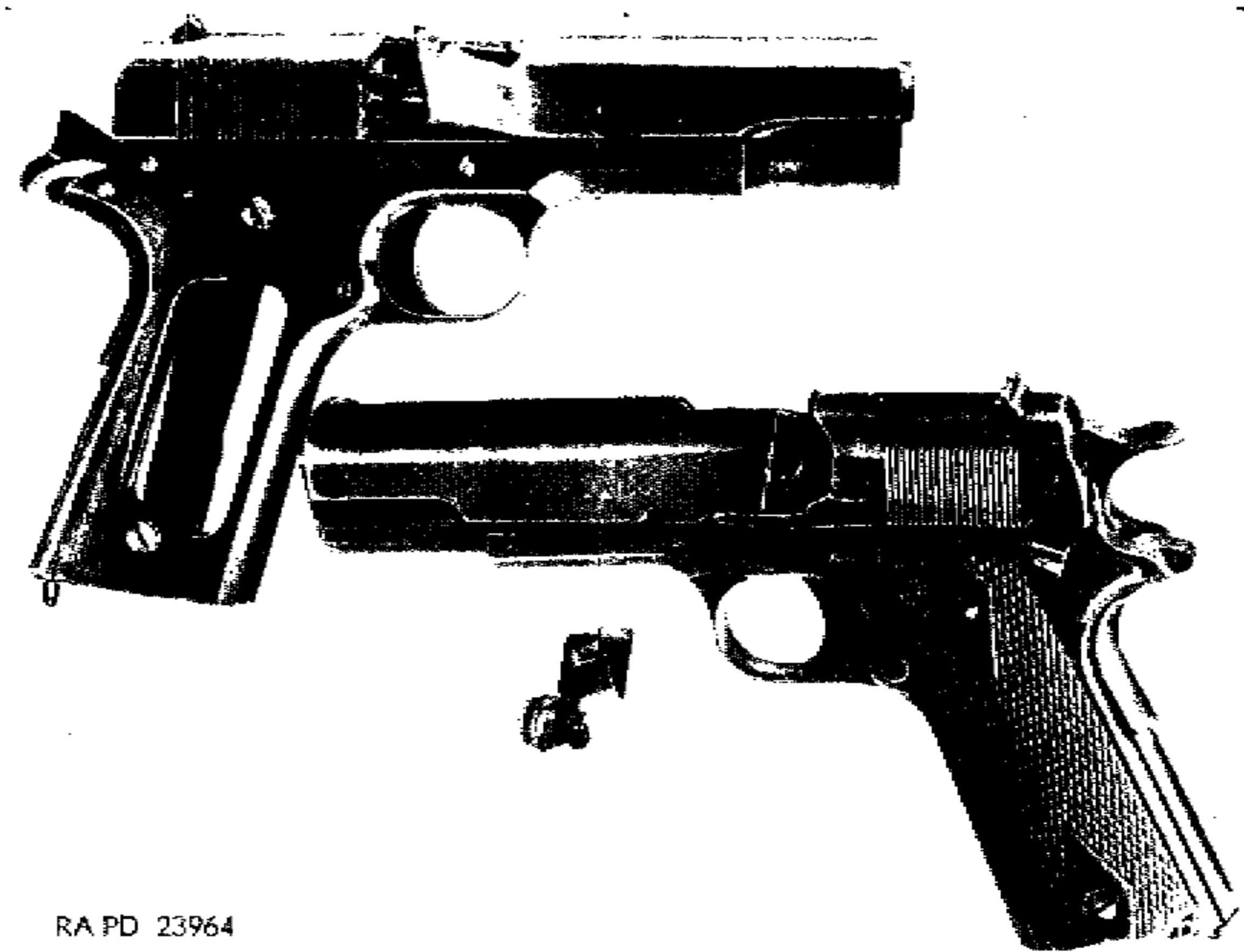

RA PD 23964

Figure 71. Damage from firing round with double charge of powder, cal..45 automatic pistol M1911.

b. Bore Obstruction.

- (1) Figure 70 shows a pistol in which a normal round was fired with grease in the chamber and breech end of the bore. The chamber pressure that developed was sufficient to rupture the head of the cartridge case, releasing the powder gases into the action. Note the bulged slide and the damaged top round from the magazine.
- (2) Figure 69 pictures the damage caused by firing a normal round with a bullet in the bore. A bullet may lodge in the bore when fired from a cartridge containing damp powder, and some of the powder grains will be unburned. Figure 69a shows darkened, unburned powder grains adhering to the base of the lodged bullet. Observe the long split in the barrel and the two bullets recovered from the bore.
- (3) The powder charge in the cal.45 pistol cartridge sometimes creates insufficient power to expel the bullet from the barrel. The lodged bullet will obstruct the passage of the next round and blow up the barrel.



RA PD 23966

Figure 72. Damage to breech end of barrel caused by fatigue of metal, cal..45 automatic pistol M1911.

SERVICEABILITY CHART---PISTOL, CAL. .45, M1911 AND 1911A1			
ITEM	IN THE HANDS OF TROOPS	TO ACCOMPANY TROOPS OVERSEAS	TO BE PLACED IN STORAGE FOR REISSUE
FINISH	Exposed surfaces should be dull enough to prevent glare	Intact enough to prevent glare	Approximate new finish
BORE	Fitting less than the width of land or groove and less than 3/8" long is acceptable	Fine uniform rifling, but with sharp lands, is acceptable	A few fine pits, but with sharp lands, are acceptable
TRIGGER PULL	Min. 5 lb Max. 6 1/2 lb	Min. 5 1/2 lb Max. 6 1/2 lb	Min. 5 1/2 lb Max. 6 1/2 lb

SUPPLEMENT "B" TOOLS, GAUGES AND FIXTURES
(PISTOLS M1911 & M1911A1)

123. Requisitionable Tools and Gauges

a. GAUGES. (1) There are no gauges requisitionable for use by field maintenance units.

(2) The gauges listed below are for base maintenance shop use, and are requisitionable from SNL B-20.

Gauge, snap, nonadjustable, not-go, .150 inch (barrel link pin), 41-G-339-150, A7319912

Used to check the diameter of the barrel link pin.

Gauge, snap, nonadjustable, not-go, .197 inch (slide stop pin), 41-G-339-160, A7319913

Used to check the diameter of the slide stop pin.

Gauge, snap, adjustable limit, not-go, .694 inch (barrel bushing), 41-G-336-400, A7319914

Used to check the outside diameter of the barrel bushing.

Gauge, plug, not-go, double purpose (barrel bushing), .582 and .587 inch (out-of-roundness), 41-G-254-393, A7319915

Used to check the inside diameter of the barrel bushing.

Gauge, plug, not-go, diameter .704 inch (barrel bushing seat), 41-G-254-391, A7319916

Used to check the inside diameter of the barrel bushing seat.

b. TOOLS. There is only one tool issued for the overhaul and repair of the cal. .45 automatic pistol M1911 and M1911A1. This tool is requisitionable from SNL B-6 for organizational field and base maintenance units.

Screwdriver, pistol, length over-all $3\frac{1}{8}$ inches, 41-S-1062-60, C64149

Used to disassemble and assemble the pistol.

124. Nonrequisitionable Tools, Weights, and Fixtures

Listed below are nonrequisitionable weights for checking the trigger pull on the cal. .45 automatic pistol M1911 and M1911A1, and nonrequisitionable tools for repair of parts. The weights alone are applicable to organizational; field, and base maintenance; the balance of these tools are intended for base maintenance use only.

Weights, trigger pull

Used to check the trigger pull.

Tool, staking, plunger tube

Used for staking the slide stop and safety plunger tube in the receiver.

Fixture, riveting, front sight

Used to rivet the front sight in place on the slide.

Tool, swaging, slide stop notch

Used to decrease the size of an over-size or excessively worn slide stop notch in the receiver.

Tool, staking, bushing

Used for staking the stock screw bushings in the receiver.

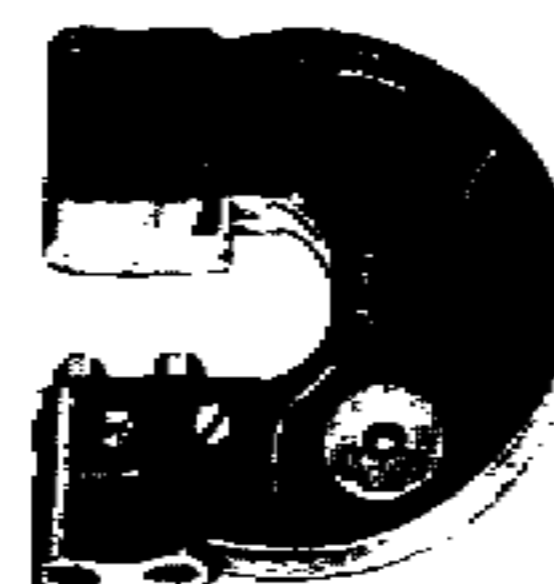

GAGE, SNAP, ADJUSTABLE
NOT-GO .694
41-G-336-400



GAGE, PLUG, NOT-GO
41-G-254-393



GAGE, PLUG, NOT-GO .704
41-G-254-391



GAGE, SNAP, NOT-GO .197
41-G-339-160



GAGE, SNAP, NOT-GO
.150 41-G-339-150

Figure 149. Gauges for parts inspection.

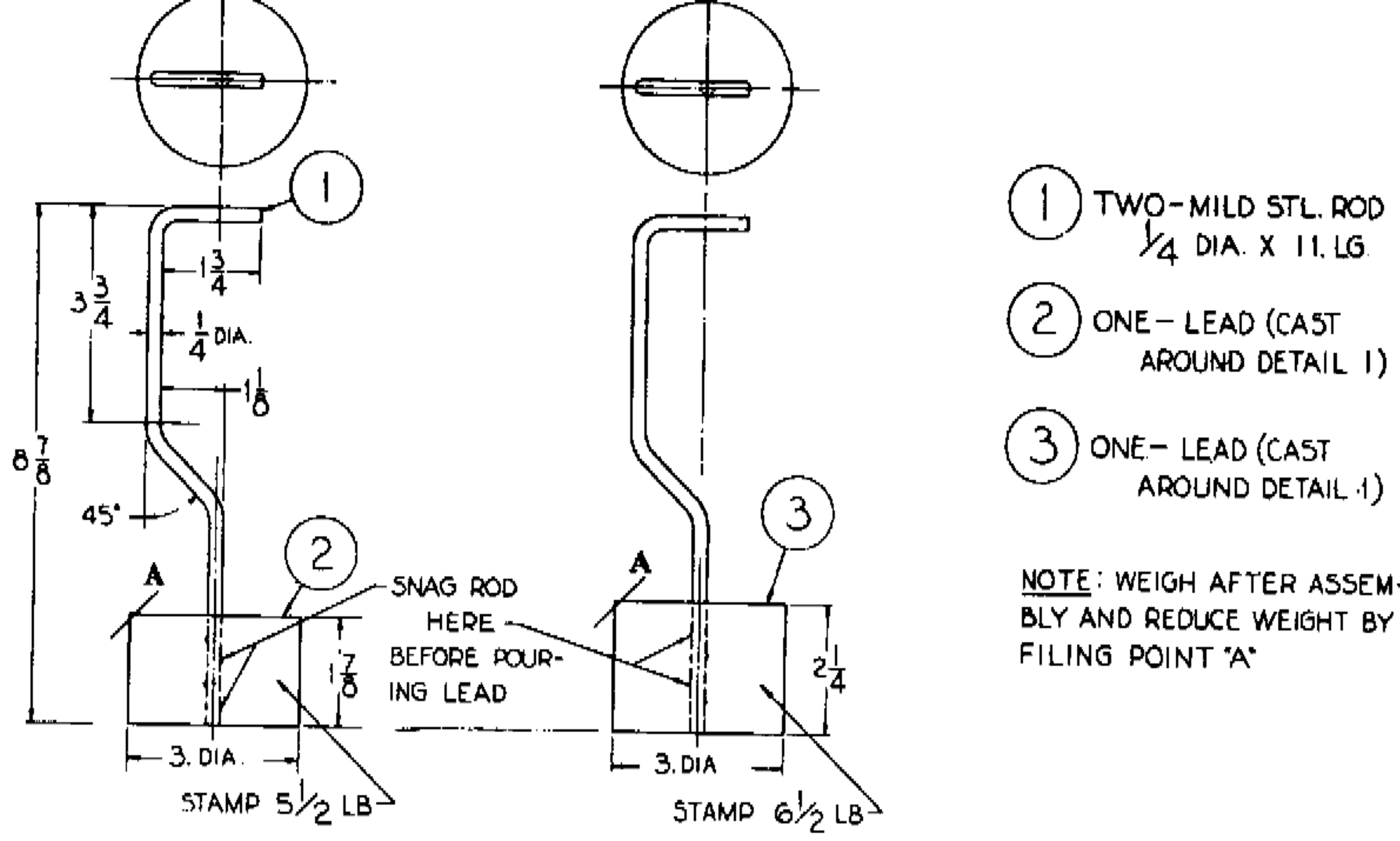

Figure 150. Trigger pull weights.

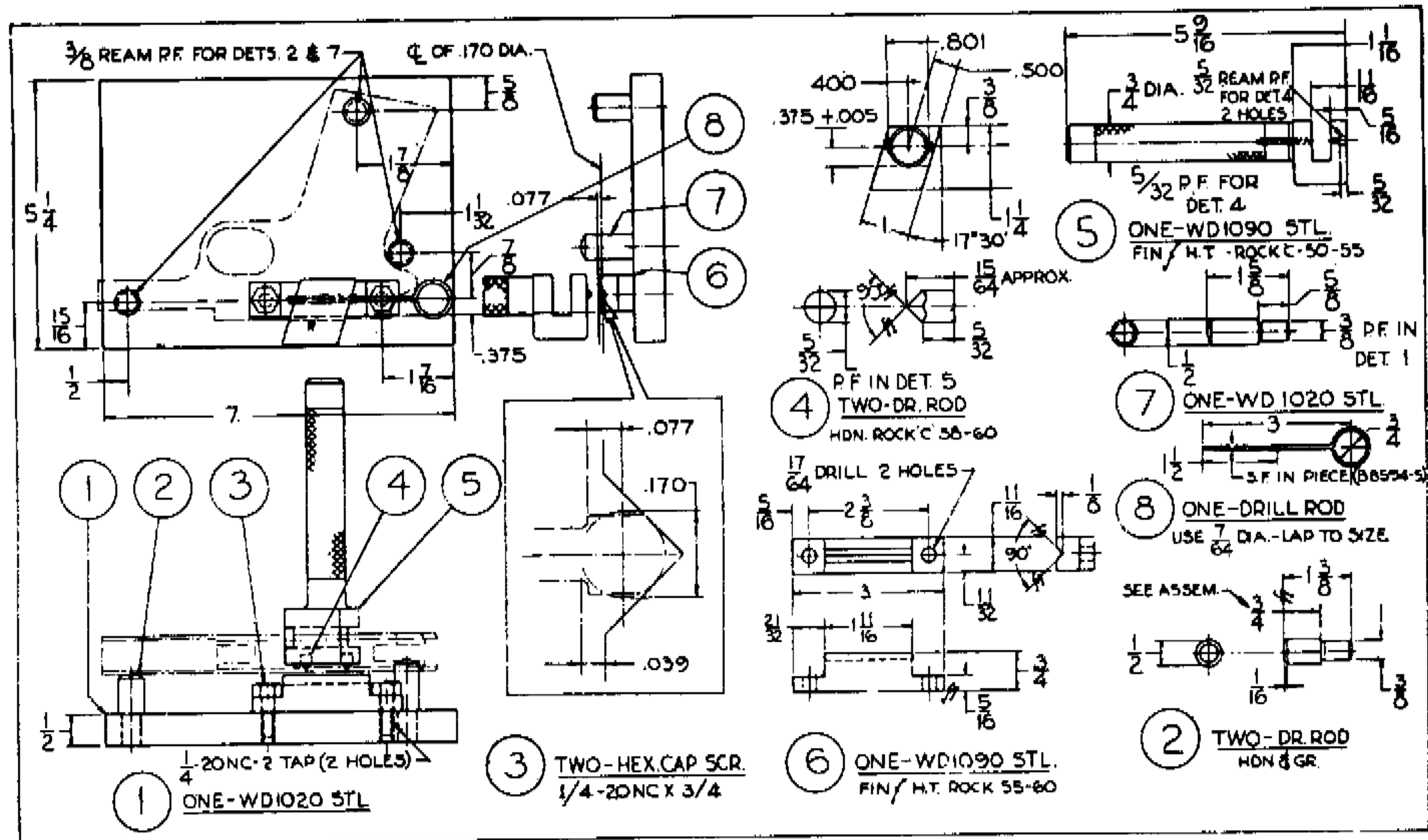

Figure 151. Tool for staking slide stop and plunger tube in receiver.

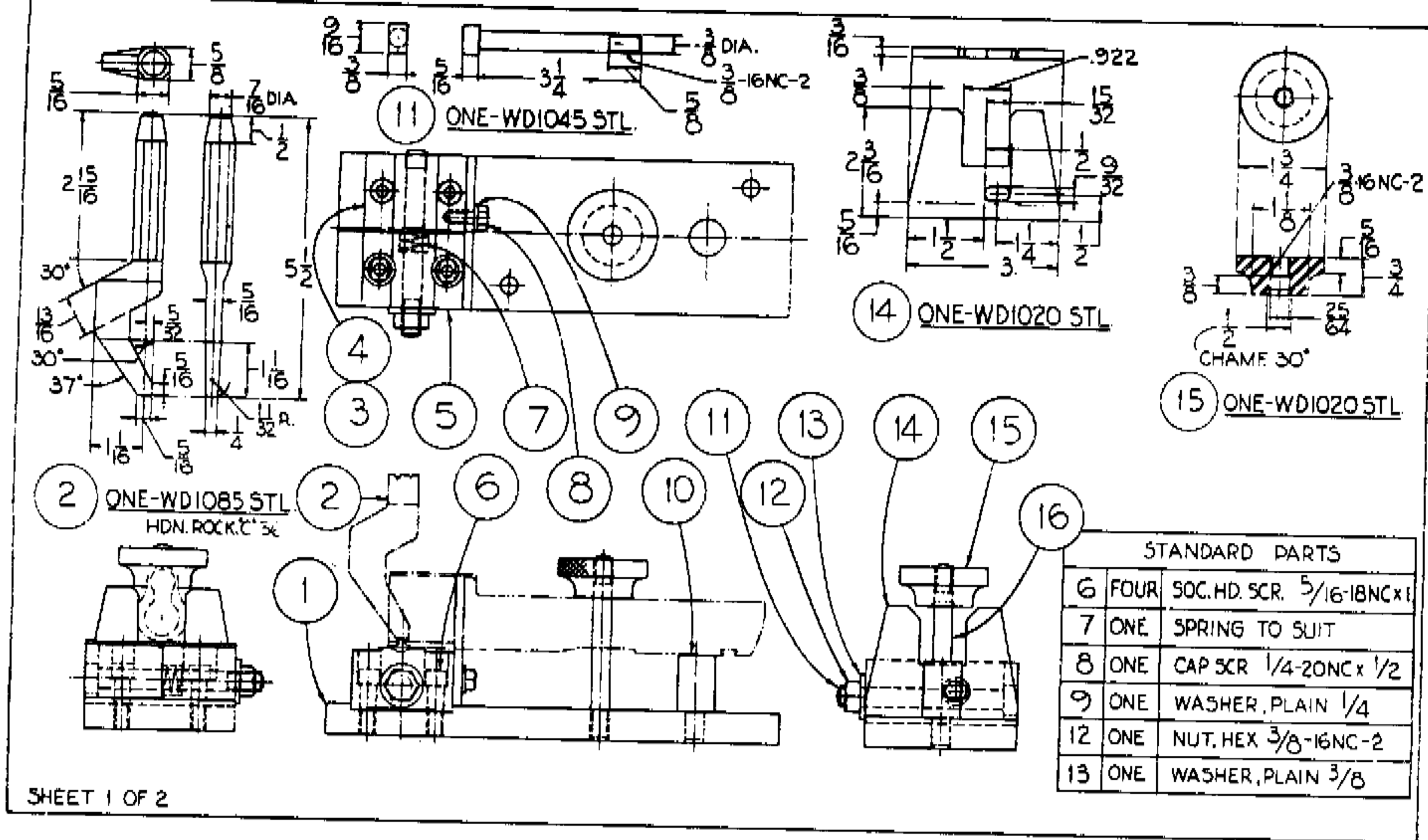

Figure 152. Fixture for riveting front sight.

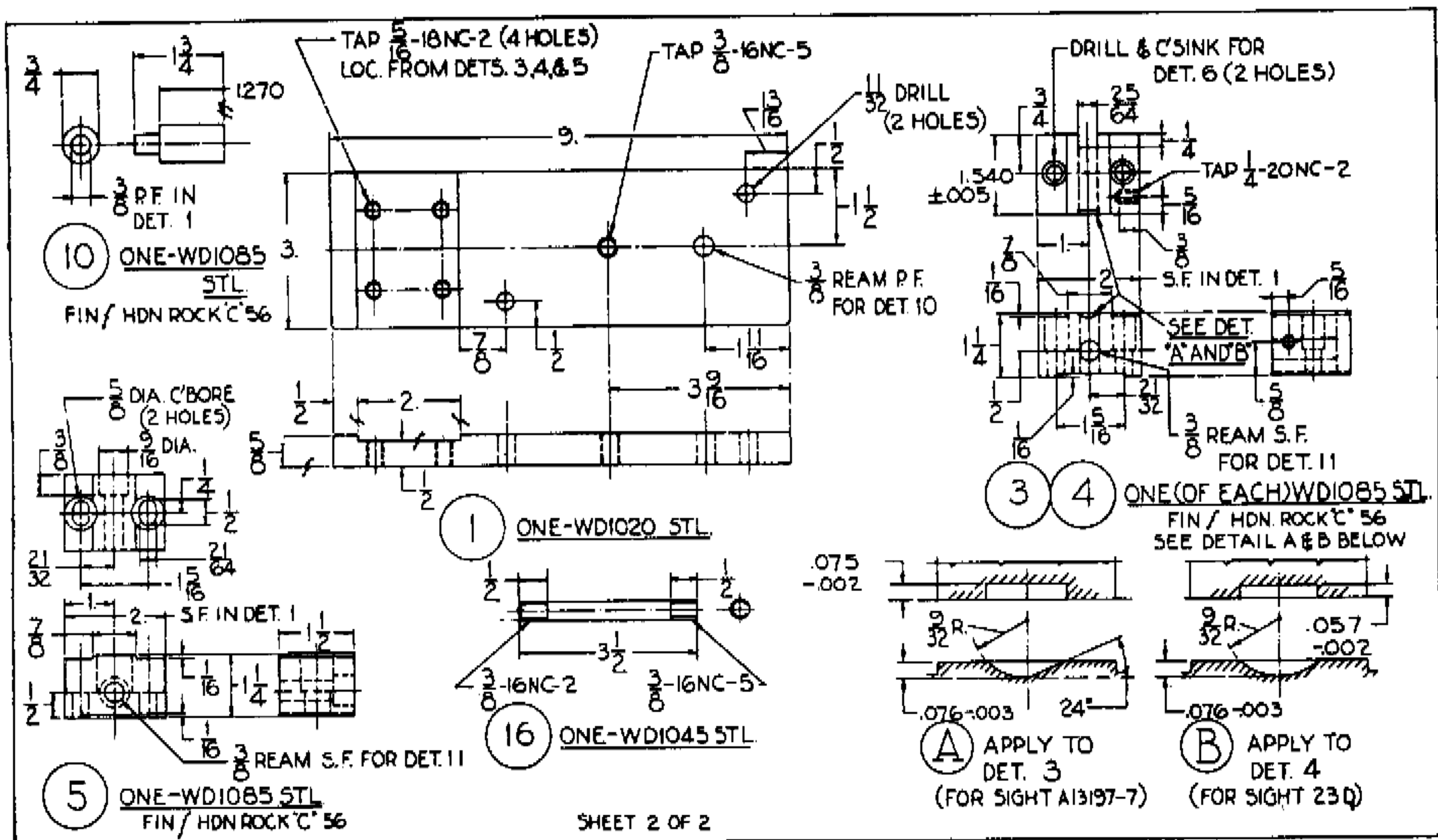

Figure 152-Continued.

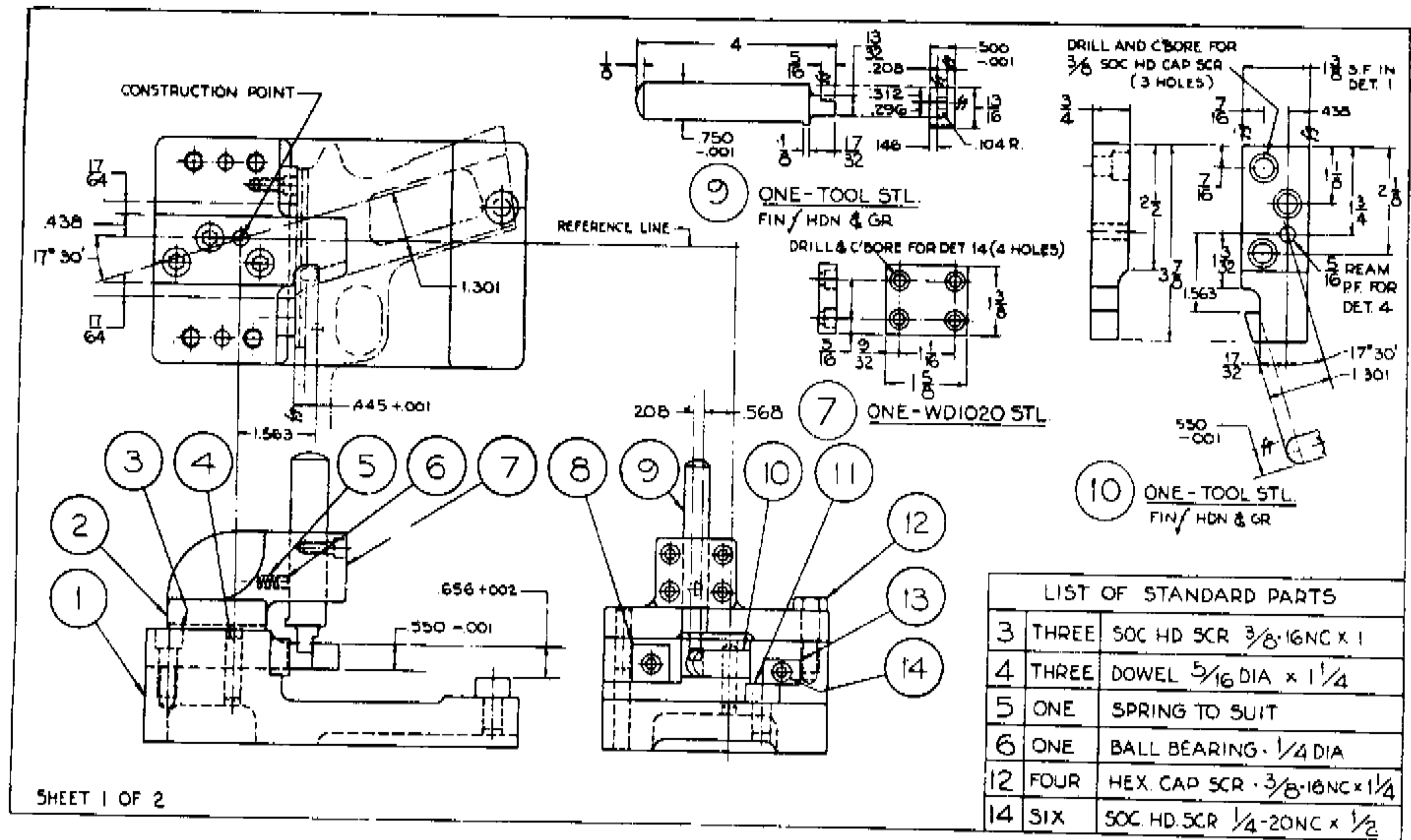

Figure 153. Tool for swaging slide stop notch.

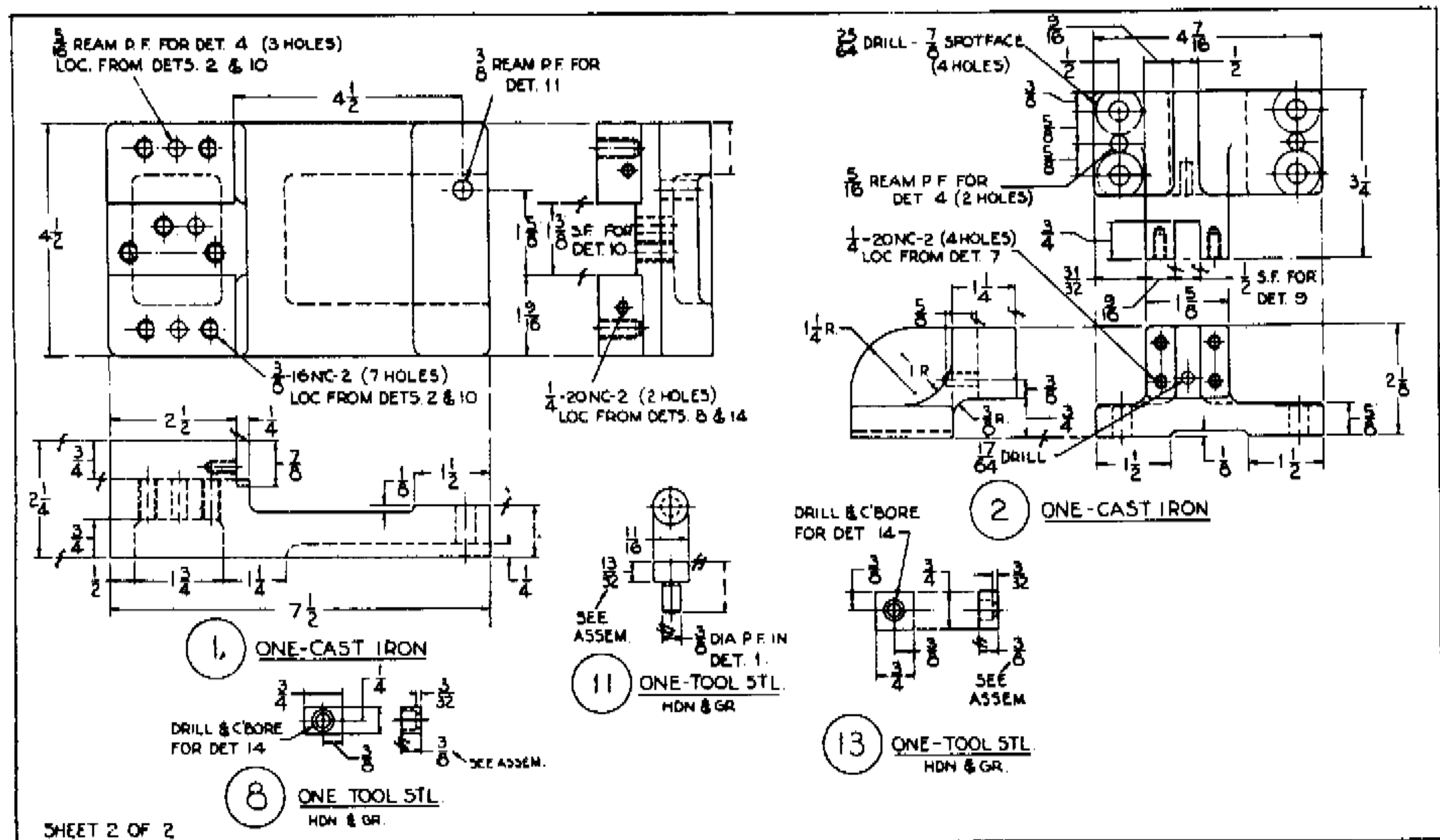

Figure 153.-Continued.

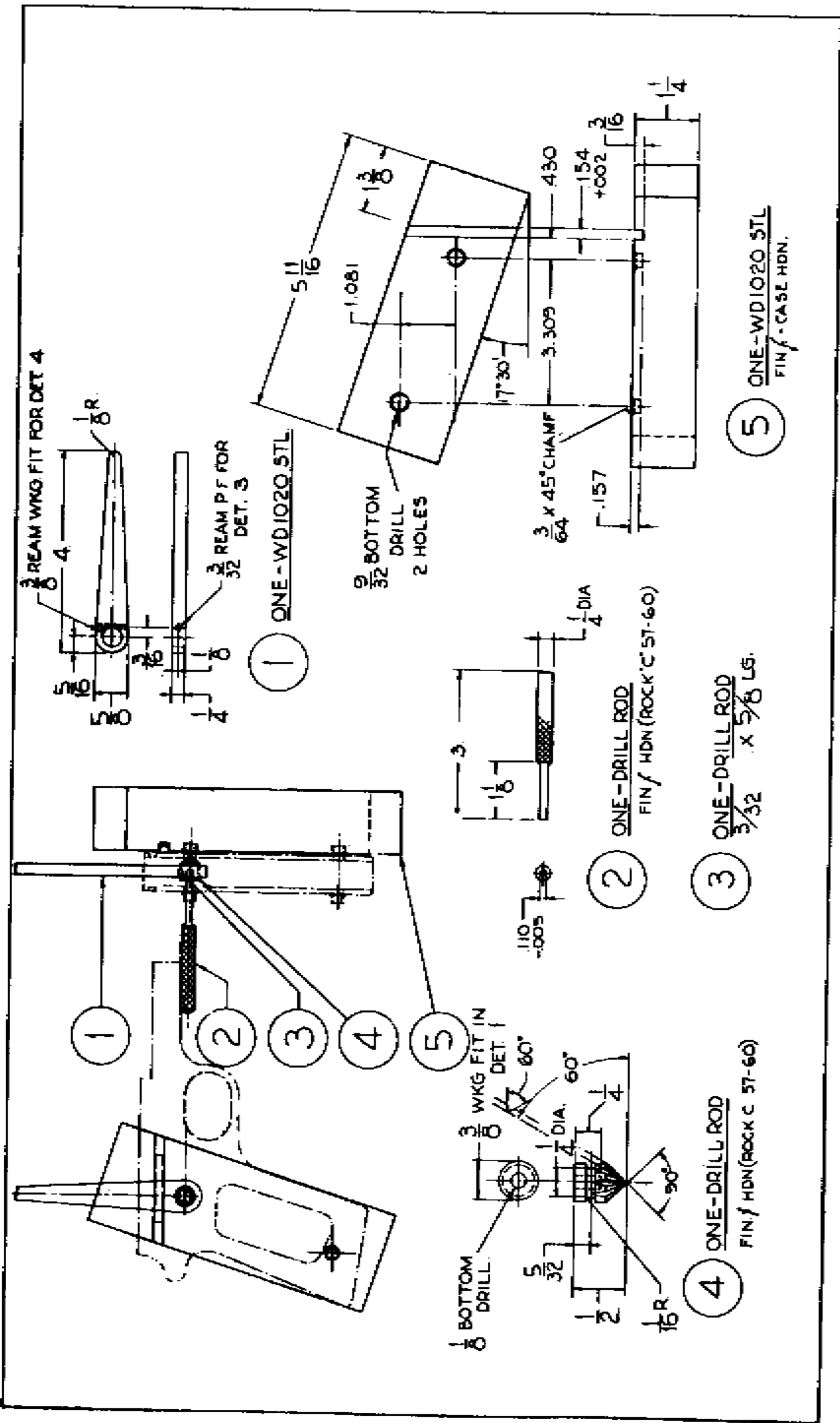

Figure 174. Tool for staking stock screw bushing.

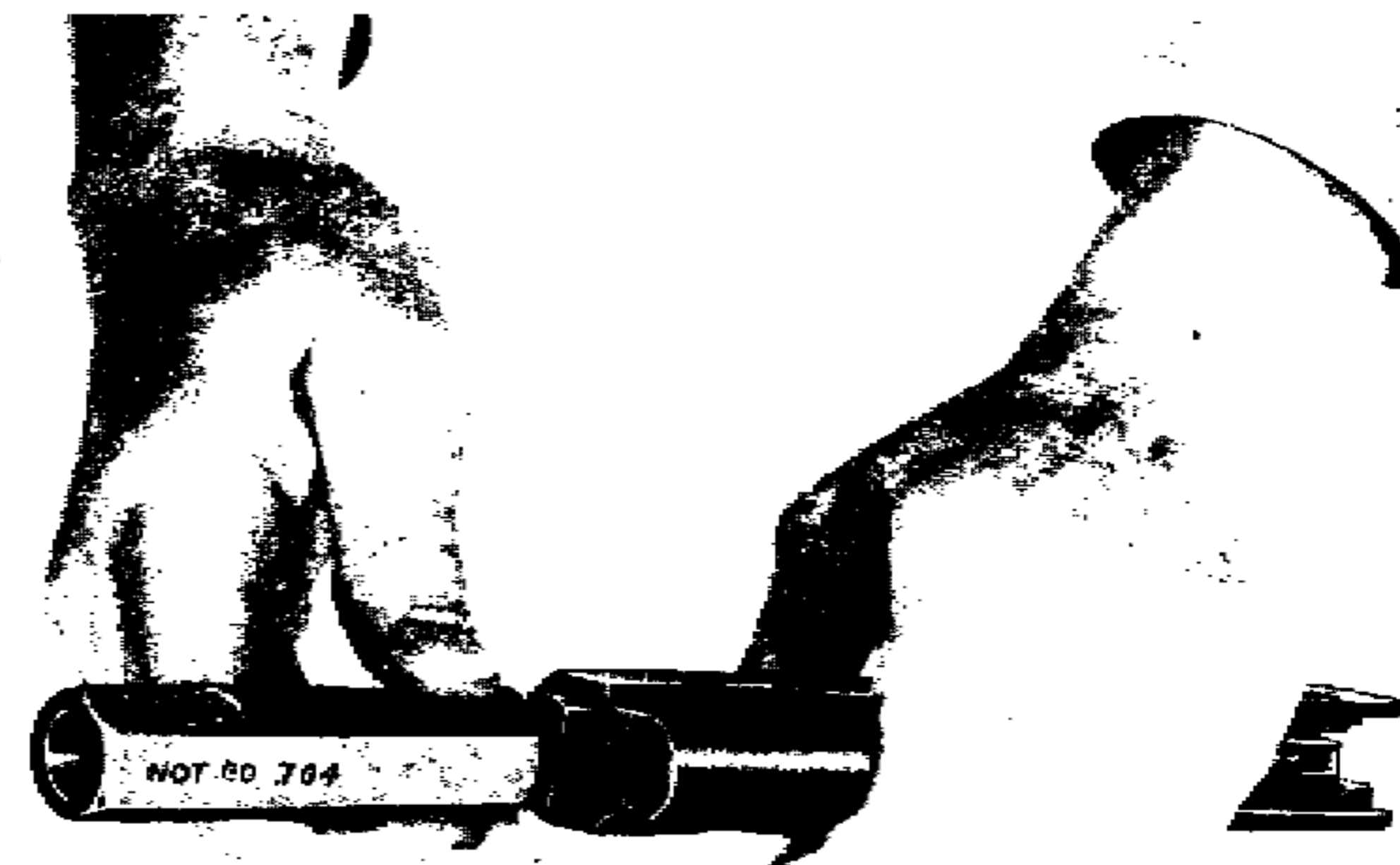

Figure 175. Checking barrel bushing seat.

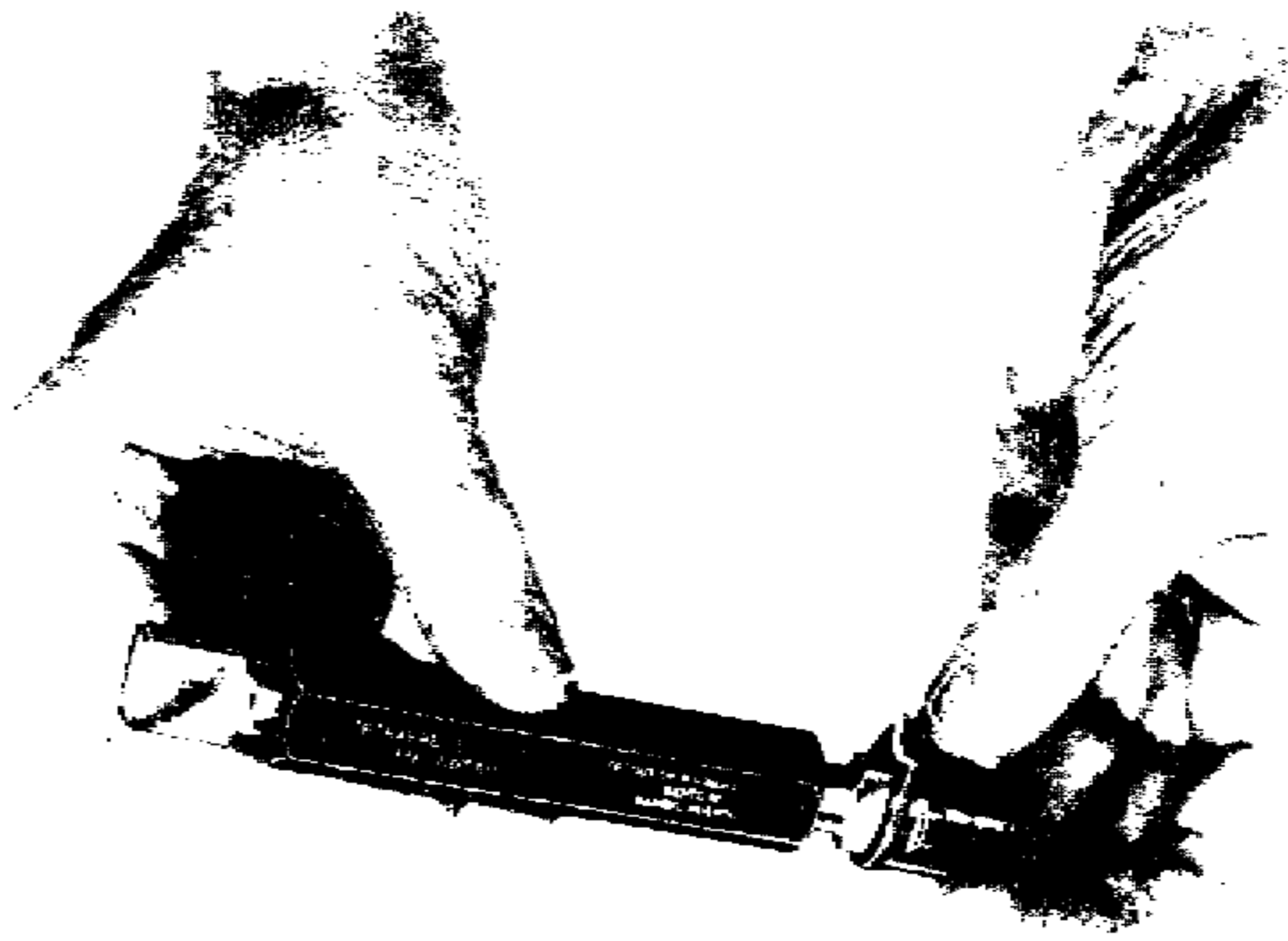

Figure 176. Checking inside diameter of barrel bushing.

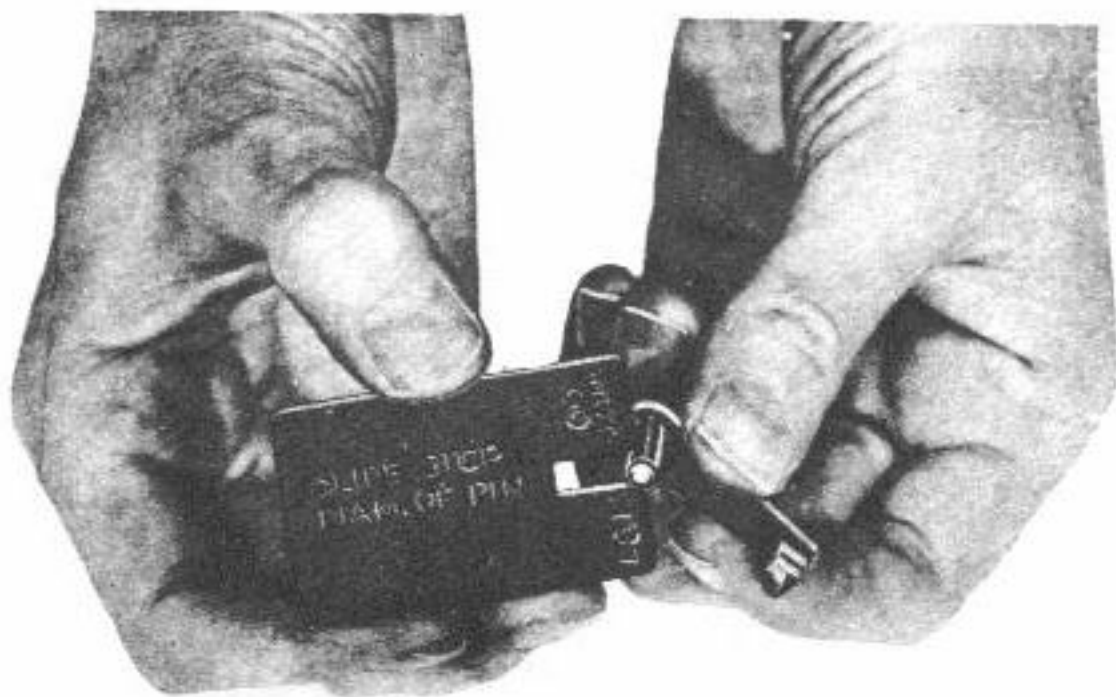

Figure 157. Checking slide stop pin.

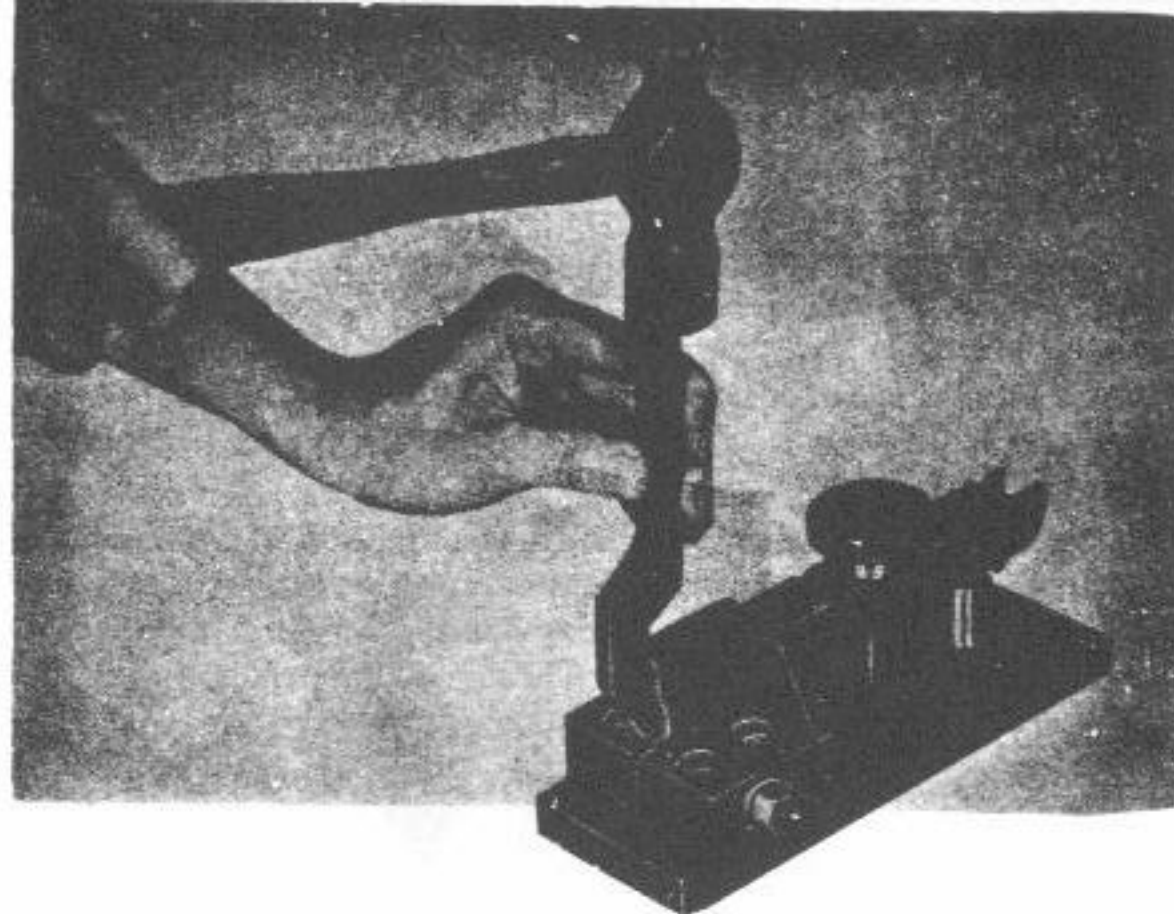

Figure 159. Riveting front sight on slide.

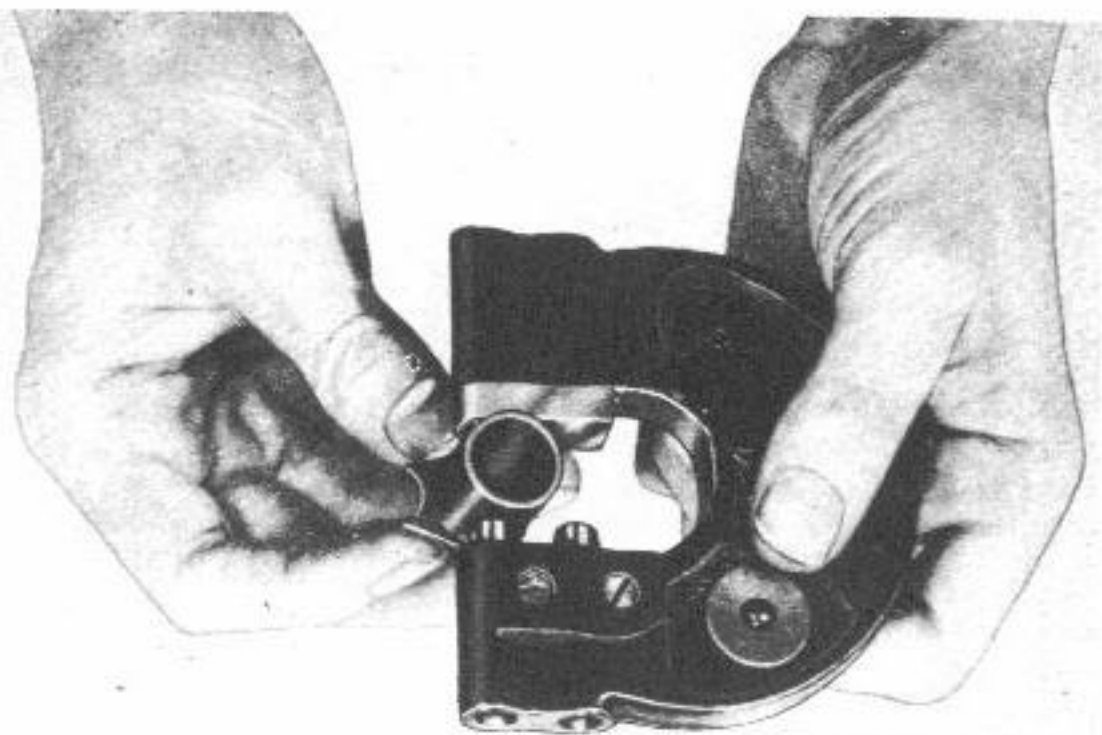

Figure 158. Checking outside diameter of barrel bushing.

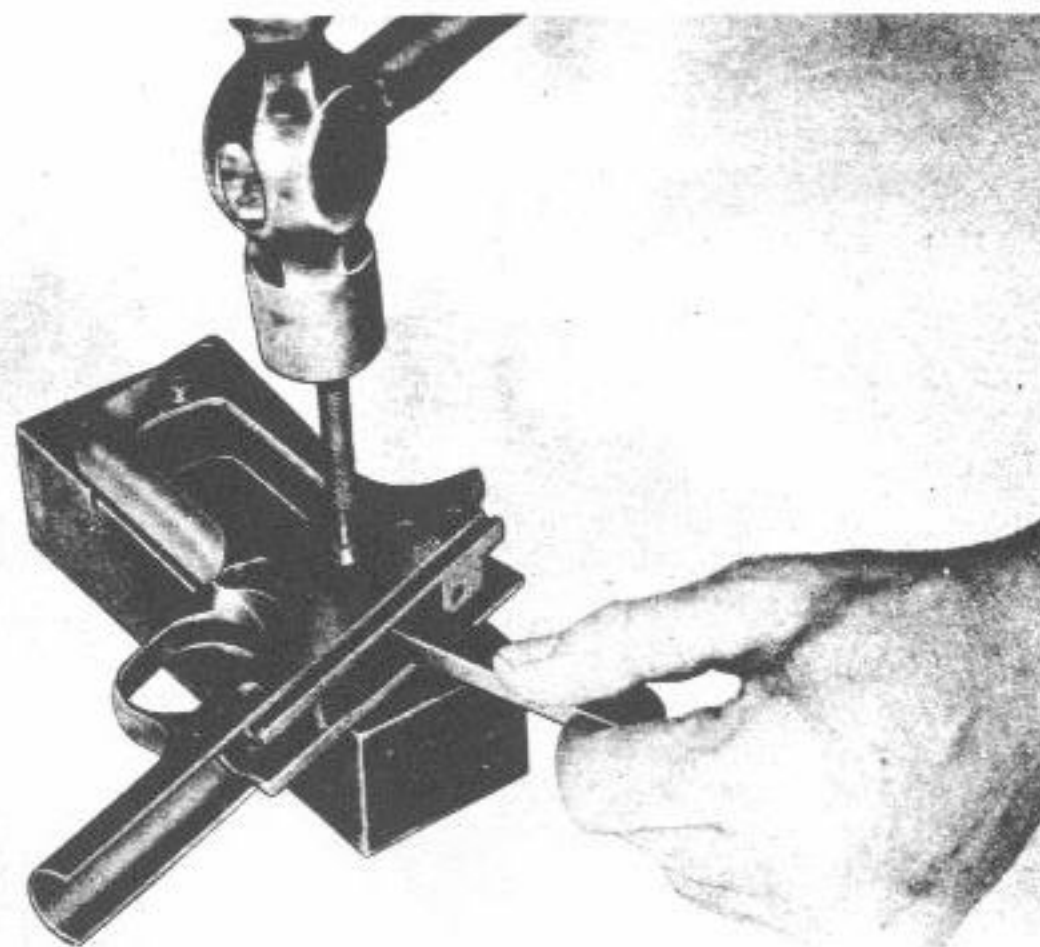
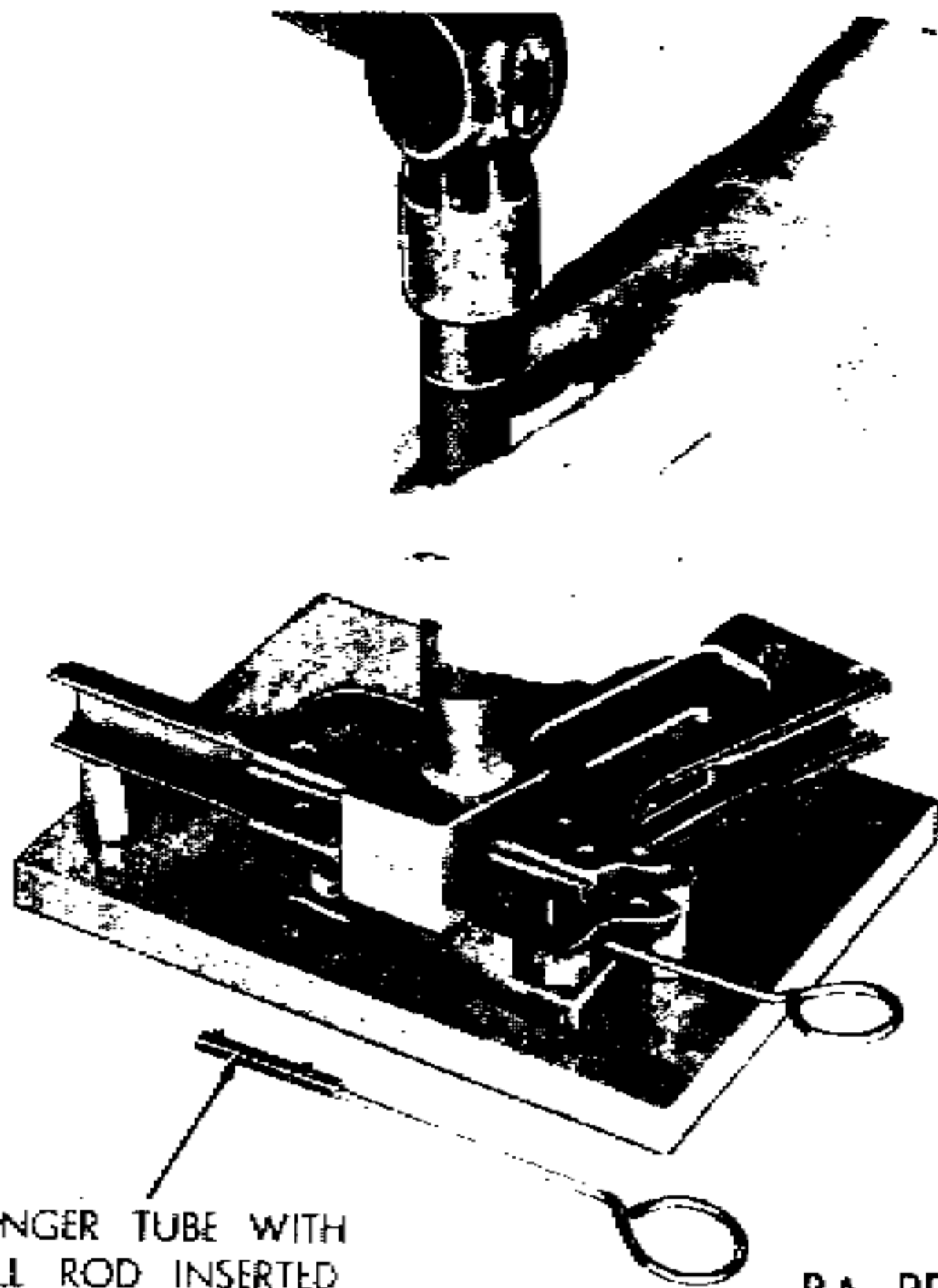

Figure 160 Staking stock screw bushings.



PLUNGER TUBE WITH
DRILL ROD INSERTED

RA PD 91794

Figure 161. Staking slide stop plunger tube.

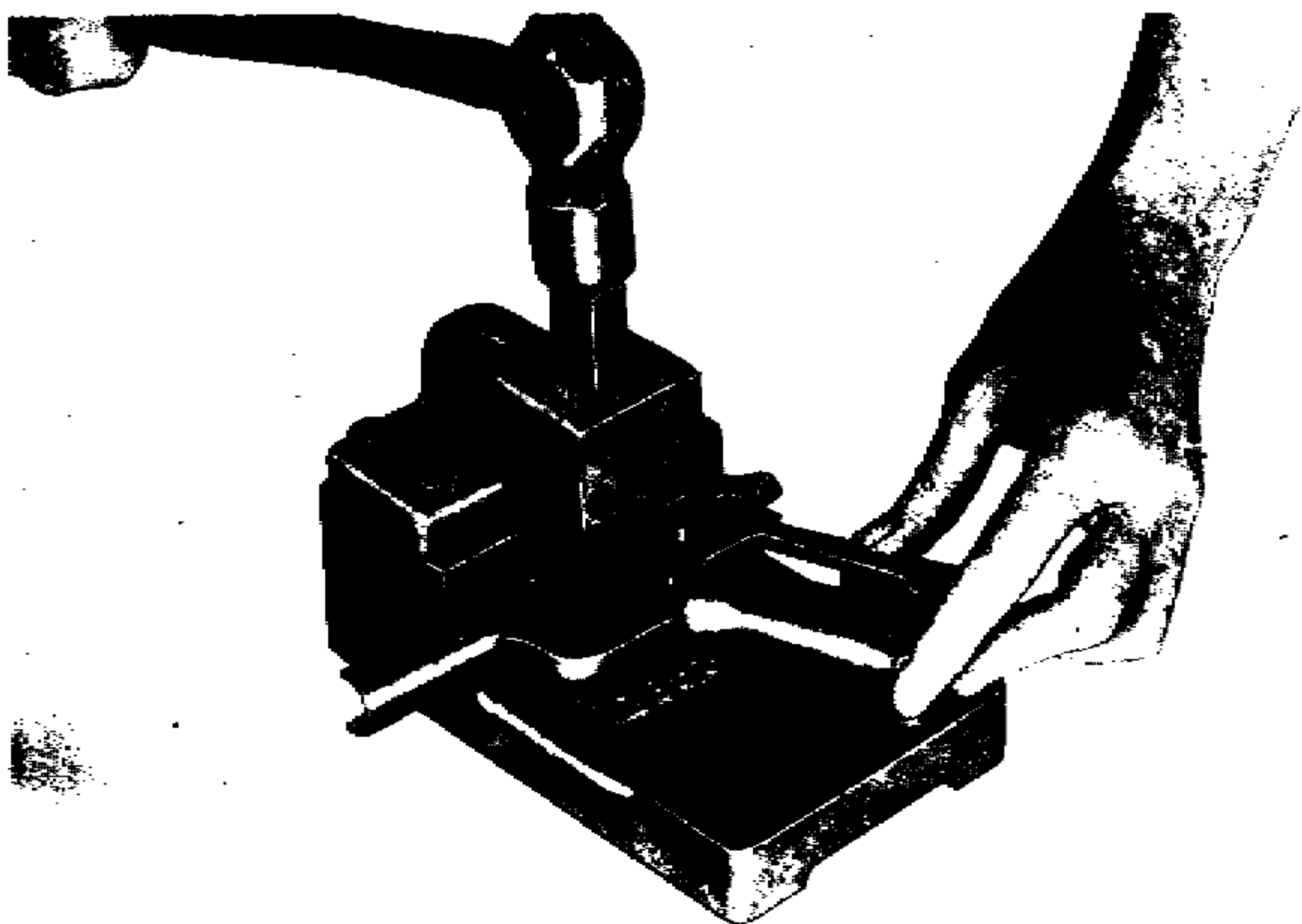

Figure 162. Swaging slide stop notch.