

CAST IRON:

A RECORD OF ORIGINAL RESEARCH.

BY

WILLIAM J. KEEP,

Member American Society of Mechanical Engineers, and of its Committee on Standard Tests and Methods of Testing Materials; Member American Institute of Mining Engineers; Member Iron and Steel Institute; Member International Association for Testing Materials; Fellow American Association for the Advancement of Science; Honorary Member Rensselaer Society of Engineers, etc.. etc.

FIRST EDITION.

FIRST THOUSAND.

NEW YORK:
JOHN WILEY & SONS.
LONDON: CHAPMAN & HALL, LIMITED.

1902.

KF 2453



Copyright, 1902,
BY
WILLIAM J. KEEP.

PREFACE.

THIS volume has been prepared in response to many requests that the author's researches might be presented in a convenient form.

In May, 1885, the author discovered that there was a relation between shrinkage and the composition of a foundry mixture, but not until the publication of Professor Turner's discovery that the condition of carbon depended upon the proportion of silicon it discovered that shrinkage varied inversely as silicon. Since that date the author, by his method of tests, has endeavored to discover the influence of the chemical elements in cast iron, and the results were recorded in the Transactions of the American Institute of Mining Engineers prior to 1894.

In 1894 it became evident that the physical qualities of cast iron were not understood. Professor Turner on page 232 of his "Metallurgy of Iron and Steel" (1895) says regarding shrinkage: "The subject has since been carefully investigated by W. J. Keep of Detroit, whose experiments embody the whole of the trustworthy data available."

The author, as member of the Testing Committee of the American Society of Mechanical Engineers, made extensive experiments to determine the physical properties of cast iron, the results of which are recorded in the Transactions of that society. These were such a surprise that the committee was requested to prove the author's conclusions by tensile tests. Fortunately five series of Dr. Richard Moldenke's extensive tensile and compres-

sive tests were completed before this volume was prepared, and have been used to meet this request.

This volume contains the results of this whole line of research.

Decided opinions are advanced regarding the best methods for a founder to obtain the best results; and that he may be able to use the shrinkage test at once the whole subject is summarized on page v.

WILLIAM J. KEEP.

DETROIT, MICH.

MECHANICAL ANALYSIS TO REGULATE A FOUNDRY MIXTURE.

FOR shop routine read pages 182 and 183.

Measure the shrinkage of a $\frac{1}{2}$ -in. test-bar from your iron mixture, when you consider it satisfactory, and use it for *your standard*.

For stove-plate and small castings it will be .115 to .140; for ordinary machinery castings .150 to .160.

If the shrinkage is greater than your standard, use more soft iron (increase silicon).

If it is less, use more scrap or cheap iron.

The strength of a $\frac{1}{2}$ -in. test-bar should be above 400 lbs.

With high shrinkage and high strength of a $\frac{1}{2}$ -in. test-bar, heavy castings will be strong, but castings $\frac{1}{8}$ in. thick may be brittle.

With low shrinkage and high strength of a $\frac{1}{2}$ -in. test-bar, large castings will be weak and thin castings will be strong.

With uniform shrinkage, an increase in the strength of a $\frac{1}{2}$ -in. test-bar will increase the strength of all castings proportionately.

For ordinary foundry work, and for all irons that will run gray in a $\frac{1}{2}$ -in. test-bar, that size gives better results than any other.

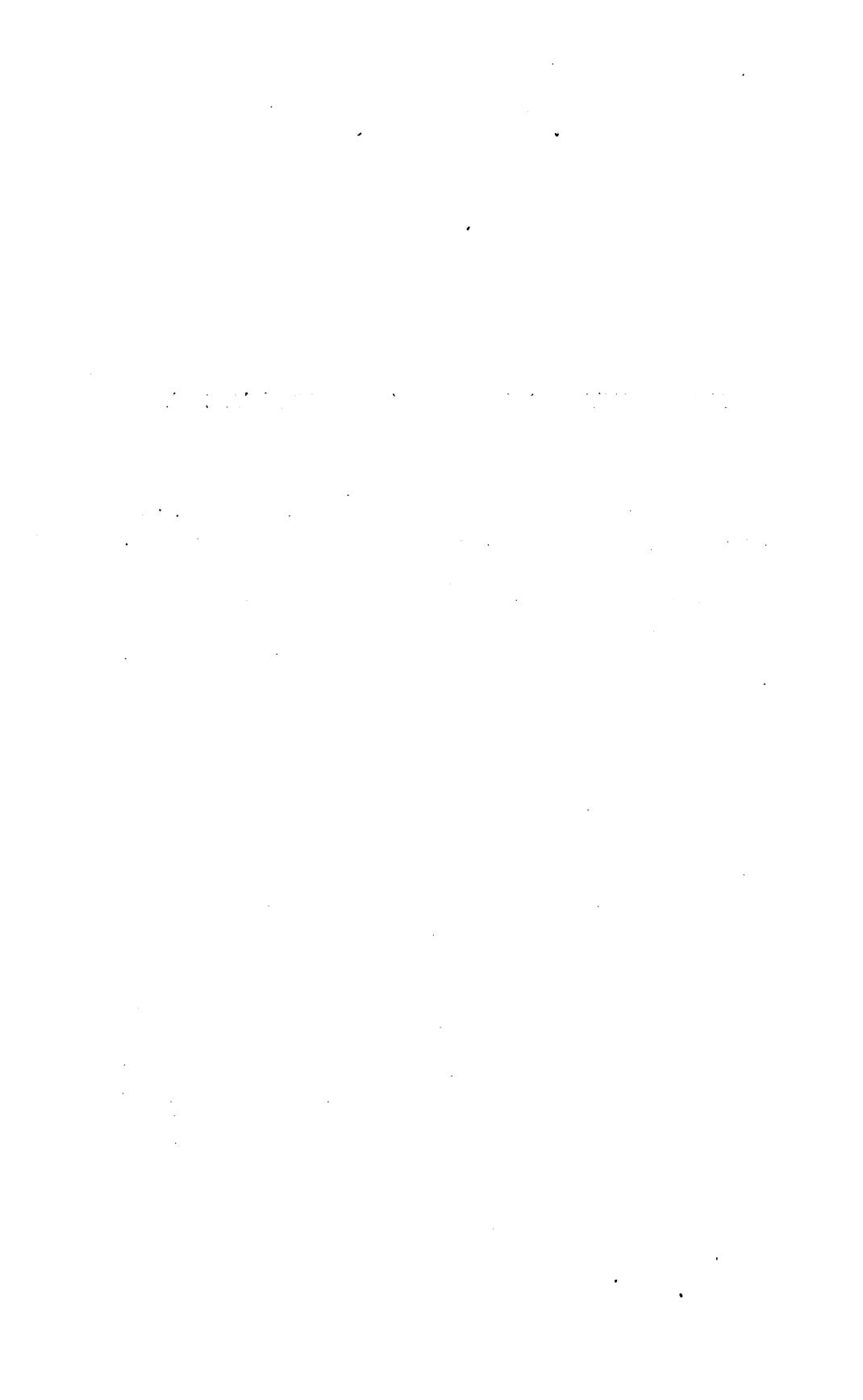

ACKNOWLEDGMENTS.

PROFESSOR THOMAS TURNER, formerly Lecturer on Metallurgy at Mason College, Birmingham, and now Director of Technical Instruction for Staffordshire County, England, described the action of silicon in cast iron in 1885.* The author adopted the method of Professor Turner in his work (Method 4), p. 14.

In 1894, as a member of the Committee on Testing, of the American Society of Mechanical Engineers, the author made nineteen series of tests, using three tons of "Iroquois" and three tons of "Hinkle" pig iron. The first twelve series were molded and cast by the Detroit Stove Works, and series 13 to 15 by the Michigan Stove Company. The other four were made by C. G. Bretting & Co., Ashland, Wis., light machinery iron; Bement, Miles & Co., Philadelphia, heavy machinery; A. Whitney & Sons, Philadelphia, carwheel iron; and Michigan Malleable Iron Co., white iron (air-furnace).

The strength tests of these nineteen separate series were made by Professor R. C. Carpenter, Sibley College, Cornell University, and by Professor C. H. Benjamin of Case School of Applied Sciences, Cleveland, Ohio. These records are given in Chapter XIII. The shrinkages are given in Chapter VII.

The complete analysis of each size of these test-bars was made by Messrs. Dickman and Mackenzie, "The Rookery," Chicago. The carbons are given in Chapter XIII, and the other records are given in the chapters on Silicon, Phosphorus, Sulphur, and Manganese.

* Journ. Chem. Soc., 1885, pp. 577, 902.

Mr. H. S. Fleming and Mr. Edward Orton, Jr., did nearly all of the analytical work prior to 1894.

Dr. C. F. Mabery, Professor of Chemistry at Case School, made the determinations of Chapter XXIII.

Messrs. Cary and Moore and Mr. George H. Ellis of Chicago and several others made many determinations.

Dr. R. Moldenke, as chairman of the Committee on Testing of the American Foundrymen's Association, procured thirteen series of test-bars from as many founders, and made nearly all tests himself. A portion are given of the results of the first five series in Chapter XIII. Mr. Gus. C. Henning, as secretary of the Testing Committee of A. S. M. E., aided largely in preparing results of the work done.

The dates at which the author published the results of his investigations are as follows:

Description of Apparatus and Methods; Journal U. S. Association of Charcoal Iron Workers, 1887 (the editor suggested the name "Keep's Test"); also in the Journal of South Staffordshire (Eng.) Institute of Iron and Steel Managers, 1888. Ferrosilicon and the Economy of Its Use; Silicon in Cast Iron; Trans. American Institute of Mining Engineers, vol. XVII., 1888; Phosphorus; Aluminum in Cast Iron; Aluminum in Wrought Iron; Aluminum in Steel; Aluminum and Other Metals Compared; *ibid.*, vol. XVIII., 1889. Aluminized Iron and Steel; Journal of the Iron and Steel Institute (London), vol. I., 1890. Manganese; Trans. A. I. M. E., vol. XX., 1891. Sulphur; *ibid.*, vol. XXIII., 1893. Shrinkage ("Relative Tests, etc."); Report of Committee on Tests; Transverse Strength; Keep's Cooling Curves; Trans. American Society of Mechanical Engineers, vol. XVI., 1895. Strength; *ibid.*, vol. XVII., 1896. Impact; *ibid.*, vol. XIX., 1898, and vol. XXI., 1900. Hardness; *ibid.*, vol. XXII., 1901.

The author proposed the name "Mechanical Analysis" in a discussion before the Foundrymen's Association, Philadelphia, in 1894.

CONTENTS.

CHAPTER I.

DEFINITIONS.

Chemical Test, Physical Test, Direct Physical Test, Relative Tests, 1. Transverse Test, Tensile Test, Compression or Crushing Test, Iron, 2. Wrought Iron, Ingot Iron, Steel, Cast Iron, 3. Lime, Fuel, 4. Mechanics, Stress, Strain, Fracture, Deflection, 5. The Spring-line, Set, Elasticity, The Measure of Elasticity or Elastic Deflection, Rigidity or Stiffness, Perfect Rigidity, No Rigidity, The Diagram of Rigidity, The Measure of Rigidity, 6. Strength, Ultimate or Maximum Breaking Strength, Dead Load, Measure of Usefulness, Chill, Grain, 7.

CHAPTER II.

GRAPHIC RECORDS.

Average Prices of No. 1 Foundry Pig Iron at Philadelphia for Forty Years, 8. Specific Gravities, 10.

CHAPTER III.

METHODS OF INVESTIGATION.

Description of Materials used, 11. Test-bars, Preparing for a Test, 12. Cupola Iron (Methods 1 to 3), 13. Crucible Tests (Methods 4 to 14), 14.

CHAPTER IV.

CRYSTALLIZATION OF CAST IRON.

Form of Crystals, 19. Can Cast Iron Expand at the Instant of Solidification? Does each Crystal Expand as it Forms? 20. Shrink-holes or

Spongy Spots, 21. General Arrangement of Crystals and Lines of Weakness, 22. Cooling Strains, 24.

CHAPTER V.

CARBON IN CAST IRON.

Description of Carbon, 25. Carbon in Cast Iron, 25. Origin of Carbon in Cast Iron, 26. Quantity of Carbon in Cast Iron, 27. Saturation of Carbon, 27. Condition of Carbon in Cast Iron, 27. Diffusion of Carbon in Cast Iron, 28. Bulk of Carbon in Cast Iron, 28. Carbon and Chill, 29. Carbon and Hardness, 29. Carbon and Fusibility, 29. Fluidity, 29. Influence of Different Percentages of Carbon, 30. Arbitrary Values of Inch-pounds for Impact Tests, 32. Annealing Ordinary Gray Iron Castings, 33. Influence of Remelting on Carbon, 33.

CHAPTER VI.

SILICON IN CAST IRON.

Silicon, 34. Silicon in Cast Iron, 34. Silicon added to White Iron changes it to Gray Iron, 36. Silicon added to Gray Iron Low in Silicon will make it more Gray, 36. It is the Influence of Silicon, not the Percentage, that Produces the Results, 37. The Influence of Silicon is Indirect, acting through Carbon, 38. By changing Silicon in an Iron Mixture we can Control the State of Carbon and the Chill, 41. Diffusion of Silicon in Cast Iron, 41. Analysis of Silicons of A. S. M. E. Tests, 42. Loss of Silicon in Remelting, 42. Silicon and Hardness, 44. Silicon and Chill, 44. Silicon and Fluidity, 44. Silicon and the Surface of a Casting, 45. The Relation of Carbon to Silicon in Pig Iron, 45.

CHAPTER VII.

SHRINKAGE OF CAST IRON.

One Size of Test-bar must be Used when the Influence of Variations in Chemical Composition is being Observed, 46. In the Examination of the Variation in Shrinkage caused by a Variation in Size of Test-bar, Iron of Unvarying Composition should be put into all the Sizes of Test-bars, 46. Carbon and Shrinkage, 46. Silicon Reduces Shrinkage by Changing Combined Carbon into Graphite, 47. Shrinkages of Test-bars of A. S. M. E. and of A. F. A. Tests, 48. Shrinkage Decreases as Silicon Increases, 48. Variation in Shrinkage indicates the Variation in Silicon, 49. Shrinkage Decreases as the Size of a Casting Increases, 49.

CHAPTER VIII.

**KEEP'S COOLING CURVES. A STUDY OF MOLECULAR CHANGES IN METALS
DUE TO VARYING TEMPERATURES.**

Autographic Record of Shrinkage, 50. Shrinkage Curves, 51. Yokes for Chilling and Fixing the Length of Test-bars, 51. Curves from Cast Iron, 53. First, Second, and Third Expansion, 54. Solidifying of Cast Iron, 54. Hard and Soft Cast Iron, 55. Silicon is a Softener and Lessener of Shrinkage, 56. Phosphorus, Sulphur, and Manganese in Cast Iron, 58. Size of Casting and Expansion, 58. Effect of Hot or Dull Iron on Shrinkage, 59. Temperatures at which the Three Expansions Take Place, 61. When does Carbon Combine when Heated towards Fusion? 62. Floating of Solid Iron on the Surface of Fluid Iron while it is Melting, 63. Curves from Heated Rolled Steel, 63. Relation of these Expansions to the Critical Points of Iron and Steel, 65.

CHAPTER IX.

PHOSPHORUS IN CAST IRON.

Phosphorus, Red and White, Sp. Gr., Phosphide of Iron, 66. Fusibility of Phosphorus Iron, Cold-shortness, 66. Tests to find Influence of Phosphorus, 67. Phosphorus and Blow-holes, 72. Additional Tests, 72. Analysis of Phosphorus, A. S. M. E. Tests, 76. Influence of Remelting on Phosphorus, 77. Influence of Phosphorus upon the Grain of Cast Iron, 77. Phosphorus and Carbon, 78. Phosphorus and Shrinkage, 79. Influence of Phosphorus on the Strength of Cast Iron, 80. Influence of Phosphorus upon the Chill of Cast Iron, 80. Phosphorus and Hardness, 80. Phosphorus and Fluidity, 81. General Remarks, 81.

CHAPTER X.

SULPHUR IN CAST IRON.

Sulphur, 82. Sulphur in Cast Iron is considered Injurious, 82. Various Experiments, 83. Brimstone added to Gray Cast Iron, 86. Influence of Iron Cooling in Ladle, 88. Iron Sulphide added to Gray Iron, 90. Iron Sulphide added to White Iron, 91. Smith and Weston's Experiments, 93. Influence of Remelting on Sulphur, 96. Analysis of Sulphur, A. S. M. E. Tests, 97. Iron Pyrites in Limestone-flux makes Iron Hard, 98.

CHAPTER XI.

MANGANESE IN CAST IRON.

Ferromanganese, 99. Influence of Silicon when added to Spiegeleisen, 100. Tests with Manganese, 101. Manganese and Carbon, 102. Swedish Manganese Irons, 103. Manganese and Shrinkage, 104. Manganese and Strength, 104. Manganese and Chill, 104. Analysis of Manganese, in A. S. M. E. Tests, 105. Manganese and Hardness, 105. Influence of Remelting on Manganese, 106.

CHAPTER XII.

SEGREGATION.

Segregation of Swedish Pig Iron, 108. Remarkable Examples, 109. Segregations in Test-bars, 112. Ordinary Commercial Impurities a Benefit, 113. Chill as Explained by Segregation, 114.

CHAPTER XIII.

STRENGTH OF CAST IRON.

Records of Tests for Committee, A. S. M. E., 115. Records of Tests of Committee, A. F. A., 115. Average Maximum Dead Load (Transverse) for Nominal Size of Test-bars, A. S. M. E. Tests, 116. Transverse Strength of Test-bars, A. F. A., 117. Analysis of Test-bars, A. F. A. Tests, 119. Strength generally Increases with each Increase of Silicon (up to 3%), 119. The Lower the Silicon the Weaker the Small Castings and the Stronger the Large Castings, and the Higher the Silicon (up to 3%) the Stronger the Small Castings and the Weaker the Large Castings, 120. The Strength of a $\frac{1}{2}$ -in. \square Section of each Test-bar Decreases as the Size of the Casting Increases, 120. The Strength of a $\frac{1}{2}$ -in. \square Section of each Test-bar Decreases more rapidly with each Increase in Size in Small Sizes of Test-bars than in Large Sizes, 121. Decrease in Strength due to each Increase in Size of a Casting is greater and more rapid with each Increase of Silicon, 121. The Centre of a Casting has a Coarser Grain and is Weaker than the Surface of a Casting, 122. Removing the Surface of a Test-bar or Casting Diminishes its Strength per Unit of Cross-section, 122. Casting Test-bars in Horizontal Molds gives Stronger Castings and more Uniform in Size than in Vertical Molds, 123. The Variation to be provided for in Ordinary Castings is at least 50%, 124. The Variation in Strength is due to the Naturally Uneven Structure of Cast Iron, and not in any great degree to Varying Temperature of Iron entering a Mold,

or to Varying Chemical Constitution, or to the Character of the Mold, 125. The Strength of any Size of Casting cannot be Calculated, by any Mathematical Formula, from Data obtained from Testing a Test-bar of another Size, 125. Tensile Strength of A. F. A. Test-bars, 126. Compression Tests, 128. Stronger Castings are made in Green-sand than in Dry-sand molds, 128. Square Test-bars are Stronger than Round Test-bars with Equal Areas of Cross-section, 128. Test-bars 2" \times 1" \times 36" Cast Flat and Tested Flat, and also on Edge, 130. Methods for Producing the Strongest Castings, 131. Total Carbon, 132. Combined Carbon, 133. Combined Carbon Weakens Cast Iron, 134. Combined Carbon may Decrease as Castings are Larger, but the Strength always Decreases. This Decrease of Combined Carbon and of Strength is Caused by the Slow Cooling, and the Decrease of Combined Carbon has Nothing to do with the Decrease in Strength, 134. Mr. A. L. Colby's Tests of Machine and Sand Cast Pig, 136. Graphitic Carbon, 138. Annealed Castings, 139.

CHAPTER XIV.

IMPACT.

The Test-bars, 140. The Recording Apparatus, 140. Dead-load Records, 140. Dead-load Diagrams, 141. Impact Testing Machine with a Swinging Hammer, 142. Diagrams from Test-bars which are not Perfectly Elastic, 145. Impact Diagrams made with a Hammer having a Direct Drop, 149. Impact Tests, 152. Influence of Shock on Cast Iron, 152. Influence of Shock on Strength, 153. Cause of Increased Strength of Tumbled Test-bars, 154.

CHAPTER XV.

GRAPHIC METHOD FOR CLOSELY APPROXIMATING THE PERCENTAGE OF SILICON, THE SHRINKAGE, AND STRENGTH OF ANY OTHER SIZE OF CASTING THAN THE ONE TESTED.

Shrinkage, 155. Keep's Shrinkage Chart, 156. Classes of Castings, 159. Keep's Strength Chart, 160. To Find the Strength of a Section $\frac{1}{2}$ " square by 12 ins. long of a Large Test-bar from Fig. 82, 162. To Find the Actual Strength of the Test-bar of the Required Cross-section, 162.

CHAPTER XVI.

HARDNESS OR WORKABILITY OF METALS.

Professor Turner's Definition of Hardness, 164. Diagrams of Hardness, 165. Drillings for Chemical Analysis, 165. Hardness and Chemical

Composition, 166. Hardness Tests, A. S. M. E. and A. F. A. Tests, 166. Hardness, Strength, and Chemical Analysis of Various Irons, 167.

CHAPTER XVII.

MECHANICAL ANALYSIS OR CHEMICAL ANALYSIS FOR REGULATING FOUNDRY IRON.

Mechanical Analysis, 168. Chemical and Mechanical Analysis, 168. Advantages of Mechanical Analysis, 169. Chemical Analysis, 170. Drawbacks to Chemical Analysis, 171.

CHAPTER XVIII.

CHEMICAL ANALYSIS WILL NOT ACCOUNT FOR ALL PHYSICAL PROPERTIES OF CAST IRON.

Influence of Iron standing in a Ladle, 173. Influence of Temperature of Cupola, 175. Influence of Dry and Green Ladles, 175. The Influence of Wet and Dry Molds, 175. Silicon is more Effectual as found in some Irons than in others, 176. Tests and Analyses of Various Irons, 177. Cupola Irons Chemically Alike, Physical Unlike, 178.

CHAPTER XIX.

TEST-BARS.

Test-bars $\frac{1}{2}$ " and 1" \square , 2" \times 1", 2", 3", and 4" \square , 179. Advantages and Disadvantages of 1" \square Bars as a Test of Strength, 180. Variation in Size of Test-bars due to Poor Molding, 180.

CHAPTER XX.

KEEP'S TEST APPARATUS.

For Mechanical Analysis, 182. Test-bar Patterns $\frac{1}{2}$ " $\square \times$ 12", 182. Flask for Molding Test-bars, 182. Measuring Shrinkage and Chill, 183. Taper Scale, 183. Keep's Dead-load Testing Machine No. 10, 183. Test-bar Patterns 1" $\square \times$ 24", 184. Keep's Dead-load Testing Machine No. 40, 184. Advantages, 184. Keep's Hardness Testing Machine, 186. Keep's Wet Grinder for $\frac{3}{8}$ " Drills, 187. Keep's Impact Testing Machine No. 2, 189. Recorder, 189. Professor Thomas Turner's Hardness-test Machine, 190. Keep's Cooling-curve Machine, 190. Test-bar Patterns with Yokes, 190. Record Paper, 191.

CHAPTER XXI.

PIG IRONS AND SILICON IRONS.

Ferrosilicon, Flaky Silvery, Nos. 1, 2, and 3 Silvery, 192. Tennessee Coal, Iron & R. R. Co., Various Irons, Tests, and Analyses, 195. Southern Silvery, Nos. 1 and 2 Soft, 196. Nos. 1, 2, 3, and 4 Foundry, 198. Gray Forge, Mottled and White, 201. Weakness of Silicon Irons, 201. History of the Use of Silicon Iron, 201.

CHAPTER XXII.

TESTING SMALL SAMPLES OF PIG IRON.

Crucible Furnace, 203. A Small Cupola, 203.

CHAPTER XXIII.

ALUMINUM IN CAST IRON.

Analysis and Tests of Aluminum Mixtures, F^LM and White Test-bars, 205. Influence of Aluminum on the Grain of Cast Iron, 207. Aluminum in Steel Castings, 210. Aluminum in Wrought-iron Castings, 210.

CHAPTER XXIV.

INFLUENCE OF VARIOUS METALS IN CAST IRON.

Nickel, Copper, Zinc, Tin, Lead, 212. Chromium in Cast Iron, 213.



CAST IRON.

CHAPTER I.

DEFINITIONS.

A Test consists in subjecting a material to conditions that disclose its true character. As applied to cast iron the chemical composition and the physical quantities are to be disclosed.

Chemical Test.—This determines the percentage of pure iron and of all other elements which are present.

Physical Test.—The subjection of cast iron to conditions which shall disclose its physical characteristics, which are: appearance of grain, shrinkage, depth of chill, hardness, strength, change of shape while under stress, set.

Changes in chemical composition and peculiarities of treatment influence the physical character of cast iron, and the only way to determine this influence is by physical tests.

Direct Physical Test.—This is breaking a casting which is an exact duplicate of the one whose strength is desired.

The only time when a direct test would be preferable would be when all castings made in any given foundry were exactly alike and did not vary in section in any of their parts.

Relative Tests are such as are applicable to every case. For such a test any size of test-piece might be selected; but the same must be used afterwards; and having made one test-record, every other record by the same method is so much greater or less than

the original, which is regarded as standard. There is a direct relation between such test-results and the composition of the iron, the size of casting, and the shape.

It would be well to fix upon a given size of test-piece, which should be used by all, and a definite routine in producing it should be prescribed so as to prevent variations in conditions as much as possible. The only variable would then be composition. Such test-results would in regular foundry practice indicate changes due to variations in composition.

The records from bars of the same dimensions and the same composition are the only ones that can be averaged or compared directly with each other. Test-records of bars $2'' \times 1''$, whether tested flat or on edge, can be compared with each other, but cannot be compared with bars 2 ins. square, even if made from the same iron, because the latter cooled more slowly and have a looser grain, and are therefore proportionately weaker.

Transverse Test.—As cast iron is commonly used to resist cross-breaking and because of the ease with which it can be made, this test is the most frequently used.

Tensile Test.—We do not wish to use cast iron for a tensile member in any case, unless in a steam-engine cylinder, therefore the tensile strength of cast iron is not of very much importance. If it were important it would be a difficult thing to determine it accurately, because it is difficult to hold the specimens in a tensile machine so that they can be broken fairly and truly.

Impact Test.—This strikes a blow and records the behavior of the test-piece. The stress exerted by impact cannot be expressed in pounds avoirdupois, but in inch-pounds, which is the weight of the hammer in pounds avoirdupois multiplied by the height of fall in inches.

Compression or Crushing Test.—When applied to cubes or short cylinders the stress required to crush cast iron is so great that this test is not often used.

Iron.—Pure iron is never found in nature. The purest iron that has been made had a specific gravity above 7.84, some say

8.00. It is of silvery lustre, is more tough but softer than ordinary commercial wrought iron.

The purest iron of commerce is often nearly as malleable as copper, has considerable hardness and lustre, and its fracture is of a bluish-white or bluish-gray color. Its specific gravity is about 7.75. The temperature required for fusion is greater in proportion as the iron is pure.

The most valuable property of commercially pure iron is its power of becoming soft and pasty before fusion, which allows of its being welded or squeezed into various shapes.

Wrought Iron is the name given to iron which is manufactured without complete fusion. It is made up of fibres interspersed with more or less slag, which has been partially squeezed, forged, or rolled out. It is therefore not only chemically impure, but it has impurities mechanically intermixed.

Ingot Iron, being manufactured by fusion, is practically free from slag. Ingot iron is also called mild or machinery steel, but cannot take temper. After wrought iron has been melted, the slag should have separated from the metal and the product should not materially differ from ingot iron, if the slag was the only difference to begin with.

Steel.—Excepting the name machinery or low-carbon steel sometimes given to ingot iron, iron with a small percentage of carbon, in such a state as to take a temper, is called tool-steel. The carbon is imparted to it in various ways and the special method of manufacture gives to the steel a special name, as cement, blister, crucible, cast steel, etc.

Cast Iron, as ordinarily understood, is iron which contains all the carbon that it could absorb during its reduction in the blast-furnace, and it cannot be welded or forged, nor can it take temper. It also contains other impurities which were originally in the ores or taken from the fuel used in its production. Cast iron fuses at about 2075° F. for white and 2230° F. for gray.

Cast iron is not a simple metal, nor is it an alloy, but it is an aggregation of compounds combined chemically and mechanically.

Any change in the proportion of the compounds and of the elements of which it is composed, in the conditions attending its production in the blast-furnace, in remelting, or in its solidification, changes its character so much that it becomes a material of different qualities.

Cast iron is a comprehensive term covering any iron with carbon too high to be classed with steel, and in the different furnace-yards it is separated into more than twenty different grades, on account of the differences in the appearance of its exterior surface or of its fracture, and when sold by its chemical composition each run of iron may be different from any other on account of unequal diffusion of the elements.

Lime.—Carbonate of lime is obtained by burning limestone. By using limestone in the cupola the iron is freed from slag, and the cupola is cleared from cinder when large quantities of iron are melted at one time.

The surface of American pig iron is covered with sand, and the gates and old castings that are returned to the cupola often contain much sand. Lime and silica (sand) are both infusible, but together, with a little alumina, form a fusible fluid slag. About one part of caustic lime to two of silica, and about one tenth as much alumina as lime is the best proportion; or from 20 to 40 lbs. of limestone to each ton of iron charged in the cupola.

Lime added to the cupola seems to improve the quality of the iron, perhaps by taking care of a part of the sulphur in the fuel, and it unites with the ash of the fuel and carries it out of the cupola.

Fuel.—Iron is melted in the cupola with anthracite coal or with coke. It is considered that $1\frac{1}{2}$ tons of coke equal $1\frac{3}{4}$ tons of coal, but it is only the large pieces of coal that reach the melting-point that add to the heat. Small fragments are an injury. Coal breaks up by heat and the small particles are lost. Considerable coke can be recovered from the dump, while no coal is saved. It is not, therefore, the heat-units that decide the economy, but it is largely dependent on these physical characteristics.

The value of a fuel from a chemical standpoint depends upon the percentage of carbon. The more carbon and the less ash the more heat, but about 10% of ash is necessary to give the coke strength. The very best anthracite may have 89% carbon and 6% ash, but the best in actual use will be nearer 88% carbon and 10% ash and the average not over 83% carbon. Coke will rarely give better averages than 84% to 87% carbon and 11% to 13% ash.

The sulphur in coke is nearly all in combination with iron that was originally in the coal. If any sulphur is in a form that can be volatilized it will be likely to escape before it reaches the point where the iron melts. The most of the remainder would be likely to join the cinder. It would be difficult for any large quantity to be taken up by gray cast iron, especially after the cupola has been thoroughly heated.

Although anthracite coal does not contain as much sulphur as coke, yet it is in a form (pyrites) to be more readily taken up by iron.

Mechanics is that science which treats of the action of forces on bodies.

Stress is the name applied to a force which acts on a body. Its intensity is usually expressed in pounds avoirdupois.

Strain is the effect of stress on a body, that is, its alteration of volume and figure.

Fracture occurs when the strain is so great as to separate a solid body into parts.

Fig. 1 is an autographic diagram from a test-bar to which the stress is applied transversely at the centre of the test-bar supported at the ends. A pencil attached to the centre of the test-bar bears against a paper which is moved to the right in proportion as stress is applied.

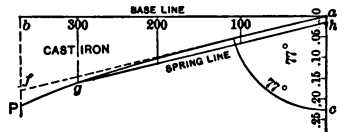

FIG. 1.

Deflection of a test-bar broken transversely is the distance in inches that the centre of the test-bar moves when the stress is

applied, and represents the strain measured on ac , due to the stress as measured on ab .

The Spring-line is the record of stresses and strains of a perfectly elastic test-bar. For materials like cast iron, which are not perfectly elastic in their original condition, the spring-line is slightly curved. A spring-line can be formed by removing the load and then gradually applying it a second time as hg . By drawing a line from a , parallel to hg , a spring-line af is formed.

Set.—When a stress is removed the centre of the test-bar will to some extent recover its original position. The amount ah that it comes short of complete recovery is the set. The distance between the lines af and ag shows set.

Elasticity is the property by virtue of which a body tends to regain its original volume or shape after it has been distorted. Elasticity is perfect or imperfect according as volume or shape is wholly or partially regained.

The Measure of Elasticity or Elastic Deflection is the distance in one hundredths of an inch that the centre of a test-bar moves towards regaining its original position on the base-line when the stress is removed. The distance between ab and af , Fig. 1, is the measure of elasticity.

Rigidity or Stiffness is the ability of a material to withstand stress and to retain its original form.

Perfect Rigidity would require no change of form with any stress that could be applied.

No Rigidity would cause the form of a material to change without limit on the application of stress.

The Diagram of Rigidity will be a line starting from the zero-point, and will lie between the lines ab and ac , and is the same as the spring-line af .

The Measure of Rigidity which I have proposed is the angle that the line or diagram of rigidity makes with ac . To apply this measure all dimensions of the diagram must be the same as those used here, i.e. 100 lbs. on ab , and $\frac{20}{100}$ of an inch on ac ; both measure 1 inch.

Strength is the ability of a material to resist rupture.

Ultimate or Maximum Breaking Strength is the greatest stress which a piece of material will resist. It is the number of pounds avoirdupois of stress that a material resists when rupture takes place.

Dead Load is stress applied so gradually as not to produce shock, and is measured in pounds avoirdupois. Each increment is added to that already applied so slowly that each molecule of the material tested shall have time to adjust itself to the stress. When the stress is so great that some of the individual molecules are separated from others, the test-bar would ultimately break if time were given even if no greater stress were applied.

After the question of ultimate strength is decided, ability to withstand stress without taking set is the measure of usefulness for materials as ordinarily used. To be fit for most structural purposes, a material should be able to bear, without change of form, the stress to which it is subjected. To do this, it must be either perfectly rigid or perfectly elastic. In any construction, if any part remains out of shape after stress is removed, such distortion will either throw too much stress on some other part and thus imperil the structure, or (in such a case as that of an instrumental application, for example, of an engineer's transit) will throw all parts out of adjustment.

In making a compression test the stress should be observed the instant that the material begins to take set, and in a tensile test at the instant that the material begins to flow.

Chill is the depth, in inches, of the peculiar white grain, caused by the iron running against an iron chilling surface.

Grain is the granular appearance of a fracture.

CHAPTER II.

GRAPHIC RECORDS.

THE graphic method conveys to the eye at a glance by means of a pictorial representation the general and local relationship of the different parts of a record with very little mental effort, and leaves the mind free to make comparisons or draw conclusions which it would be very difficult to do while endeavoring to remember the relative values of exact figures.

As an illustration: The average prices of No. 1 foundry pig iron for forty years is given by both methods in Table I and Fig. 2.

TABLE I.

AVERAGE PRICES NO. 1 FOUNDRY PIG IRON AT PHILADELPHIA
FOR FORTY YEARS.

The average price from 1860 to 1899, was \$25.95 per ton.	
Highest price touched Aug., 1864, \$73.62 per ton.	
Lowest " " July, 1898, 11.25 "	
Average price for ten years, 1860 to 1869, was \$37.84 per ton.	
Highest, Aug., 1864, \$73.62. Average 1864, \$59.25 per ton.	
Lowest, Oct., 1861, 18.62. Average 1861, 20.25 "	
Average price for ten years, 1870 to 1879, was \$29.60 per ton.	
Highest, Sept., 1872, \$53.87. Average 1872, \$48.88 per ton.	
Lowest, Nov., 1878, 16.50. Average 1878, 17.63. "	
Average price for ten years, 1880 to 1889, was \$21.58 per ton.	
Highest, Feb., 1880, \$41.00. Average 1880, \$28.50 per ton.	
Lowest, May, 1889, 17.00. Average 1889, 17.75 "	
Average price for nine years, 1890 to 1898, was \$14.30 per ton.	
Highest, Jan., 1890, \$19.90. Average 1890, \$18.40 per ton.	
Lowest, July, 1898, 11.25. Average 1898, 11.66 "	
Average price for the year 1899 was \$19.36 per ton.	
Highest, Dec., 1899, \$25.00 per ton.	
Lowest, Jan., 1899, 12.12 "	
Oct., 1900, price \$16.00 per ton.	

In Fig. 2 the general tendency of price is down. The average decrease each decade is uniform.

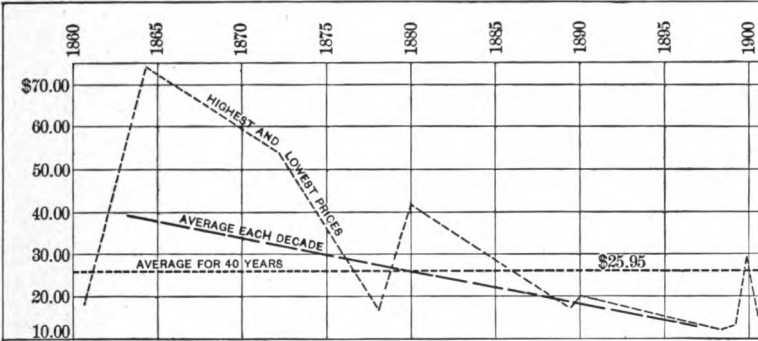

FIG. 2.

Any number of records can be placed on this same chart, as the cost of fuel and the cost of labor, a different kind of line being used for each so as to more easily distinguish each record.

Relative values are often represented graphically by the length of lines, or by differences in areas; for example: the volumes of the substances of Table II are inversely as their specific gravity.

TABLE II.

	Gold.	Lead.	Silver.	Copper.	Brass.	Wr'ght Iron.	Tin.	Cast Iron.	Zinc.	Alumi- num.
Sp. gr.	19.26	11.45	10.50	8.87	8.33	7.84	7.29	7.18	7.00	2.72

Fig. 3 shows the relative volume of a given weight of each metal by the area of a surface, each heavier metal is laid upon the lighter ones. Fig. 4 shows the same thing by the length of a line. In this case each volume is supposed to extend from the base-line upward.

Table III gives the analysis of a No. 3 foundry pig iron, also the specific gravity and the bulk of each element. In Fig. 5 is shown graphically, by the parallelogram on the left, 100% of pure

iron, on the right, 93.68% of pure iron, and above this is added the bulk of each element that the pig iron contains. Though the

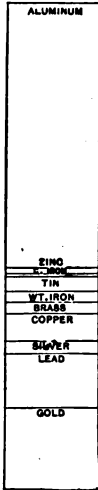

FIG. 3.

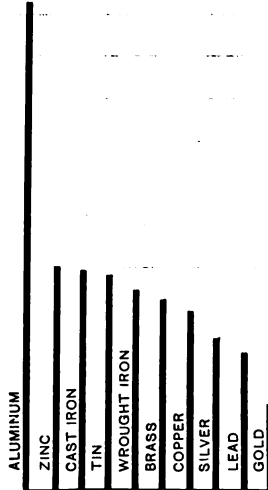

FIG. 4.

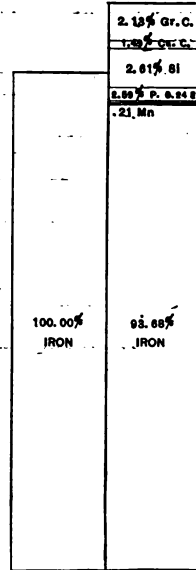

FIG. 5.

right and left parallelogram each contains the same weight, yet on account of the bulk of the elements, that on the right representing cast iron is much larger.

TABLE III.

	Gr. C.	Cd. C.	Si.	P.	S.	Mn.	Iron.
Specific gravity.....	2.25	3.00	2.49	2.14	2.05	8.00	7.84
Percentage.....	2.13	.61	2.61	.70	.06	.21	93.68
Bulk.....	7.45	1.49	8.12	2.59	.24	.21	93.68

CHAPTER III.

METHODS OF INVESTIGATION.

THIS chapter will describe details of experiment, to avoid repetition of the description each time that a test is mentioned. The value of an experiment depends largely upon a detailed description of each step.

Description of Materials Used.—The composition of each was determined by analysis.

F^LM. Gray Pig Iron.—I procured in 1885 one ton of this iron, made with charcoal at Laxa Iron Works (Lt.), Carlsdal, near Korfors, Sweden; chemical composition: TC. 3.55, GC. 3.22, CC. 0.33, Si. 1.249, P. 0.084, S. 0.040, Mn. 0.187. The iron was in small pieces of about 4 lbs. (see Fig. 49, page 109), and was a perfectly even gray and remarkably uniform. It never runs white in a $\frac{1}{2}$ -inch square bar, and is exceedingly sensitive under any treatment.

“Gaylord” White Pig Iron.—I procured half a ton of white charcoal pig as near like F^LM. as a white iron was likely to be. It contained TC. 2.53, GC. 0.49, CC. 2.12, Si. 0.18, P. 0.26, S. 0.03, Mn. 0.09.

Iroquois Furnace Company of Chicago sent me three tons of No. 3 “Iroquois” Mall. Bessemer coke pig iron, of clear uniform gray fracture, very strong and tough in the pig. The furnace analysis was: TC. 4.07, GC. 3.15, CC. 0.92, P. 0.23, Si. 0.88, S. 0.035, Mn. 0.50. Dickman & Mackenzie’s analysis: TC.

4.05, GC. 3.20, CdC. 0.87, Si. 0.98, P. 0.225, S. 0.035, Mn. 0.49.

The Ashland Iron and Steel Company of Ashland, Wis., also sent me three tons of "Hinkle" charcoal pig iron. Furnace analysis: TC. 3.507, GC. 2.69, CC. 0.817, P. 0.13, Si. 1.09, S. 0.015, Mn. 0.72. D. & M. analysis: TC. 3.50, GC. 2.73, CC. 0.87, Si. 1.03, P. 0.129, S. 0.012, Mn. 0.70.

As I took drillings from twenty-five pigs of both "Iroquois" and "Hinkle" after receiving them, and did not let Messrs. Dickman & Mackenzie know the furnace analysis, the closeness of results is remarkable. To find loss in remelting consult analysis of test-bars, Series 1 and 7, pp. 42 and 43; XXVI, p. 76; XXXIX, p. 97; XLVI, p. 105; LXI, p. 132; LXII, p. 133, and LXIV, p. 138; also see LXIII, p. 136.

"Pencost" *High-silicon Iron*.—I procured one ton with TC. 2.79, GC. 2.04, CdC. 0.75, Si. 11.00, P. 0.487, S. 0.015, Mn. 0.670; also 200 lbs. each with Si. 4.37, 6.54, 8.08, 9.42, 10.34,* 11.34, and 12.08%.*

I had also 100 lbs. each of irons with Si. 1.97, 3.57, 3.64, 4.05, 4.66, 5.15, 5.66, 6.82, 6.86, and 6.99. Also 100 lbs. each of imported ferro-silicons: Si. 9.87, 10.45, 11.99, and 16.27. For phosphorus, sulphur, and manganese irons used in experiments see chapter on these materials.

Test-bars.—In all early experiments I cast together one bar $\frac{1}{2}$ " \square \times 12" long and one bar $\frac{1}{10}$ " \times 1" \times 12". In some cases I made six pairs and in others four to get an average.

Preparing for a Test.—I calculated the exact composition of each casting and the amount of each item which was to enter into it. The items for one cast were weighed, and tied in separate bundles, and all these put in a single bundle, to which was tied a tag, containing the list of items, which tag was afterwards to be tied to the test-bars.

* For analysis see Table XIV.

CUPOLA IRON.

(Method No. 1.) Separate heats in a small cupola are very satisfactory. When this cannot be done the following are quite satisfactory.

(Method No. 2.) As many ladles as there are to be mixtures, of a size to hold about 15 lbs. when two thirds full, are lined as usual. These ladles are marked on the outside with chalk, 1, 2, 3, etc., the same as the bundles to be put into them. One flask containing a square and a flat bar, and two or three flasks containing only square bars, are numbered No. 1, No. 1-2, No. 1-3, etc., all to be filled from ladle No. 1.

Another set of flasks for the iron from the second ladle is numbered No. 2, No. 2-2, No. 2-3, etc., and so on for as many separate compositions as are to be made. These several groups of flasks are located near the cupola. The ladles are dried and heated by having melted iron poured in them and then poured out, and immediately afterwards the contents of each bundle is placed in the ladle which has the corresponding number marked on it. This addition should be heated if possible before it is put in the ladle. Enough iron has just been caught by other men in a large ladle from the cupola to fill the small ladles with as near 15 lbs. as can be estimated. Each small ladle is held by a molder who knows the set of flasks he is to fill, and each one pours his set of flasks, beginning with flask No. 1. One ladle and set of flasks has no addition and is for comparison to show the influence of the additions placed in the other ladles. As much scrap iron is added to the first and other ladles as is necessary to make the total amount to be melted by the fluid iron in each ladle the same. This is to make the cooling influence the same in each, and to give the same temperature to the metal in each mold. The additions are sometimes cemented to the bottom of the ladle, and sometimes are powdered and made a part of the lining. In such case the ladle cannot be dried with hot iron as

advised above, and the one used for comparison must have an ordinary lining treated the same as the others.

It is necessary to weigh the whole bars, gates, etc., of each cast to calculate the percentage of each element in the casting, because the iron caught in the ladles will not weigh exactly 15 lbs. as figured in making up the mixture.

(Method No. 3.) When additions of pure metal of a fusible nature are to be made, make four sets of three flasks each, and place them conveniently for pouring. Twenty-eight pounds of iron, as near as possible, is caught from the cupola and the set of test-bars marked 1 and having no addition is poured. Then with a pair of tongs stir in the first addition and pour the second set of flasks. Stir in the next addition and pour the third set. Stir in the last addition and pour the fourth set. The remaining iron can be weighed to see what correction of percentages is needed on account of the iron in the ladle not weighing exactly 28 lbs., or each cast not weighing 7 lbs.

CRUCIBLE TESTS.

(Method No. 4.) After preparing the bundles of addition, which in this case contain the pig iron which is to form the bulk of the mixture, we place the first bundle in a crucible and when melted pour the set of flasks. A separate heat is required for each bundle.

In this case the product is exactly as calculated unless some element volatilized or escaped in other ways. If there is danger of this, the pig iron may be melted first and the addition fed to the pot while in the fire, or the pot can be withdrawn and the addition made and then returned until all is fluid.

A separate cast of the pig iron alone must be made for comparison.

(Method No. 5.) It is not possible to prevent some variation of carbon and silicon. A series for comparison may be made like

Method No. 4, without any element addition, and add enough fine iron wire to make the carbon in each cast the same as in each cast of the original series. The influence of the carbon dilution is thus determined to compare with the former series. Subtracting the test-records of the latter from the former gives the influence due to the variation of the element under consideration.

(Method No. 6.) To show the exact influence of the dilution of carbon alone in each heat proceed as in Method No. 5 and along with the wire add enough ferro-silicon to keep the silicon uniform.

(Method No. 7.) When the additions are very volatile or very readily oxidized the following method may be pursued: Melt the required amount of iron in a crucible. Cut from an inch-and-a-half pine plank a round cover for the crucible; in the centre of this bore a two-inch hole. Take a stick two inches in diameter, fit, and split one end and wedge it in the hole of the cover. In the lower end of this stick bore an inch-and-a-quarter hole to hold the addition, and fit to it a square plug three quarters of an inch long. When the cover is on the crucible the lower end of the stick should reach to within one half inch of the bottom. Drive a heavy nail in the top of the cover near one edge. When the pig iron is melted place in the hole of the wooden stick the material to be added and drive in the square plug. Seize the nail in the cover with a long-handled tongs and while the crucible containing the fluid iron is still in the furnace place the cover on the crucible, which forces the end of the stick containing the addition to the bottom of the melted iron. The iron can enter the hole and the addition can melt and run out at the four sides of the square plug and boil up through the melted iron. A piece of fire-brick as a weight should be put on the cover, which in charring will form a seal to the top of the crucible.

The objection to this is the presence of oxygen in the hole of the stick and in the wood. To find what influence this exerts, make a comparison heat with the hole empty.

(Method No. 8.) We may entirely fill the crucible with the

metal to which the additions are to be made, melt it, and pour one set of test-bars for comparison. Break off and clean the gates and return them to the crucible, then return this to the furnace. Before beginning, however, calculate the weight of each set of test-bars, and how many sets can be made from the metal and the additions; calculate how much of the addition will be necessary to give the correct percentage to the second cast. Then when the gates are put back, calculate the addition for the next cast, and so on, until only 5 lbs. will be left. Tie each of these additions in a bundle with a tag containing a record of percentages in the casting so that all there is to do after beginning the work is to clean gates and return them to the crucible along with the required bundle. In this way casts can be made as fast as moulds can be prepared. The percentages of the castings are sure to be very nearly as estimated. By weighing what is left, if it is more or less than calculated, a correction may be made for the percentage in each cast.

(Method No. 9.) When we have not enough material to trust the last method, especially when we have a pig iron containing the highest percentage of the element under consideration, the following is satisfactory:

Find a pig iron having substantially the same composition except the smallest possible percentage of the element under examination. Knowing the percentage which we wish each intermediate member of the series to contain, and knowing how much we have of the material containing the highest percentage of the element, weigh out in bundles the amount of the pig iron necessary to dilute the element to the desired percentage for each heat. Having done this, melt all the material which contains the high percentage of the element, and cast a set of test-bars. Return the gates and add the portion of the pig iron by which the percentages of the element is to be diluted for the next heat, and make all fluid and pour another set of bars. Proceed in this way until we have the series complete. A last cast will be made from the iron having the low percentage.

(Method No. 10.) If we have a very small amount of material containing the highest percentage of the element, melt this and cast a set of bars. Test this first set of bars and return all of the bars and gates to the crucible except one half of a single bar. Dilute by additions as in Method No. 9, and make another cast, test it, and so on.

(Method No. 11.) Begin with the crucible full of pig iron and cast a set of test-bars for comparison. Arrange to return the gates each time with the addition which contains the element under consideration, and a new portion of the original pig iron. This addition of pig iron each time allows each heat to be as large as is desirable, and the series of heats can be continued during the day. They can be resumed another day, but more variation will probably be found between the two heats that unite the day's work than between any of the others for the reason that we end with a very poor fire but a very hot furnace, and begin next day with opposite conditions.

The weight of what is left will tell how near the weight of each heat has come to that calculated, and correction is made to get the correct percentages.

(Method No. 12.) To find what the variation of carbon and silicon will be in Method No. 11, run through a complete series, returning gates and adding pig iron each time a set of test-bars is cast, but with no addition of any element. The influence due to the variation for each number of a series can be found by this last method. I call this last *remelt series*, as it is almost identical with ordinary foundry cupola practice.

(Method No. 13.) It often occurs that the element is combined with pure iron only, as for example, sulphide or phosphide of iron. In such case the addition of pure iron along with the element dilutes the carbon and silicon, in addition to that due to the continued heat.

To find the influence of this dilution, run through a series as in Method No. 12 and to each cast add of fine iron wire the same weight as the pure iron added with the element. A comparison

of this series with the *remelt series* shows the changes due to the dilution of carbon and silicon and the additions of pure iron. By subtracting the results of the tests of this series from those of the series when the varying element was added will give the influence of the element.

To prevent oxidation of the wire when put in the crucible the bundle of wire should be dipped into a strong solution of silicate of soda and dried. The wire, or any element, had better be added when the contents of the crucible is fluid, and while in the furnace.

(Method No. 14.) This is exactly like Method No. 3, only 28 lbs. of F^LM, is melted in a crucible.

CHAPTER IV.

CRYSTALLIZATION OF CAST IRON.

IRON which has been poured into a mold, in solidifying becomes a mass of crystals more or less irregular, both in shape and size, but the form towards which they tend is that of a regular octahedron, an eight-sided figure, each side of which is an equilateral triangle. It is formed by two pyramids with their square bases together.



FIG. 6.—Aggregations of Octahedral Crystals of Cast Iron.

The crystals are too small to examine closely, but we may get an idea of the form and arrangement of single crystals by an examination of aggregations of crystals, as in Fig. 6, which is actual size.

Crystals begin to form against a cooling surface and interlock with each other, holding between themselves minute flakes of graphite. That the free carbon is in irregular flakes is proved from the nature of graphite, and because flakes of graphite may be picked out of a casting.

In a perfect crystal of iron all the axes, that is, the lines joining the opposite angles, are of equal length and at right angles to each other, but very few crystals are perfect, for they are more or less tangled with, or pressed out of shape by, those next to them.

Can cast iron expand at the instant of solidification? There is no such instant. Each crystal becomes solid while other parts are fluid, and it is not until such crystals are numerous enough to form a rigid shell that the casting can shrink or expand.

Does each crystal expand as it forms? When cast iron enters a mold a thin skin of solid iron is instantly formed by the cooling action of the sides of the mold. This is proven by breaking a casting which is still fluid; the central portion will run out. (Fig. 6 was procured in this way.) A shell having once formed, the heat of the metal can never melt it again, though, at first, it has no rigidity. New crystals form on the interior of this skin very rapidly, and, as the mold would prevent any expansion outward, if there was any expansion of individual crystals, it would be inward, which would lessen the holding capacity of the interior. The fluid interior is contained in a rigid shell of the same metal at very nearly the same temperature as the melted portion.

If a hole is broken through the upper surface of a partially solid casting, the currents of the molten metal can be seen, but no metal ever exudes. On the contrary, if the casting is of any considerable size, the fluid will sink. This proves that the fluid metal does not expand as it loses heat, and it also proves that each crystal does not expand, at least not so fast as to overcome the general shrinkage from loss of heat.

One thing which led to the opinion that cast iron expanded as it solidified was that a piece of dry, cold cast iron thrown into a ladle of molten iron would float, and the inference was that the specific gravity was greater for molten than solid cast iron. Mr. Robert Mallet found, however, by two independent methods,

that the specific gravity of melted iron was 6.650, while that of the same cold iron was 7.170. He thought that the probable reason for the cold iron floating was the fact that its surface could not be easily wetted by the liquid iron, also that a thin layer of steam and expanded air may have been held between the surfaces of the solid and fluid metals. On page 63 of Chapter VIII the true explanation of the phenomenon is given for the first time. Another phenomenon which led to the mistaken idea that liquid iron was more dense than crystallized iron, was that when molten iron is caught in a foundry ladle a circulatory movement immediately commences, the iron against the sides of the ladle rising to the top, flowing to the center, and then dropping to the bottom, flowing across the bottom to the sides, and so on. This led to the belief that it was the cooling of the iron at the sides which caused it to rise. The true reason for the motion is that the hot iron against the side lining drives out the moisture that remains, and also causes gas to be evolved from the material of the lining. It is this steam and the streams of gas which give the upward motion to the iron. That this is the true cause is proved by the fact that when the ladle is refilled, the metal will not move at all, or if so, it will be in the opposite direction.

Fig. 10 is a casting of a mill-roll cast on end, the fluid metal being fed from the bottom. The sides cool first and the upper portion of the casting solidifies next.

As the upper central portion becomes solid the crystals pull away from each other towards the sides, forming along the central axis a loose spongy casting. As these cavities form, the metal will flow in from the top as long as it is fluid, causing the upper part to sink; but as soon as all above is solid, cavities may form, although too small to be visible.

The iron having entered from the bottom, the last part to become solid is the lower part of the roll, and at this point there will not be enough metal to fill the space when cold, and the crystals pull away toward the surfaces until a large shrink-hole α is the result,

This partly explains why a large casting does not shrink as much as a small one. In both large and small castings a rigid shell forms at once. In the small casting there are no cavities and all crystals are small and lie close together. The larger the casting the more cavities, and the larger the crystals and the more loosely they join each other. This also explains why a large casting is not proportionally as strong as a small one. It is customary to carry the upper part or head of the casting high enough to cause a considerable ferrostatic pressure in the mold, and then with a wrought-iron rod churn the center of the casting so as to prevent the upper part from becoming solid, and to allow the fluid iron to enter all cavities throughout the interior of the casting. If a channel can be kept open to the lower part of the casting, and fresh molten metal is fed to the top, the casting will be practically solid. The extra head is afterwards removed.

Robert Mallet, in his work on Ordnance, gives an admirable description of the method of crystallization of cast iron. Some thirty years ago the author added to Mr. Mallet's description his own experience, substantially as follows:

The crystals assemble or group themselves in lines parallel to the direction in which the heat leaves the metal. This direction is always perpendicular to the cooling surface.

As heat leaves all surfaces of a casting, each surface will have its lines of assemblage of crystals perpendicular to it. Fig. 7 has four sides and four systems of crystallization at right angles to each other, which meet in lines connecting the corners of the casting. In meeting, each line of crystals tends to pull away from the other. Some run past the line into the opposite system and do not form a homogeneous casting.

These lines are lines of weakness, and the casting will bear less stress without fracture at these points with more metal than at any others with less. Fig. 8 shows a flat casting in which is another line of weakness connecting the diagonals.

Fig. 9 shows another arrangement of perpendicular systems of crystallization. The angle at a being a re-entrant angle, the

perpendicular lines continue past the angle and form a line of weakness from the angle to the center of the casting where it meets the lines of weakness from the opposite corner and from the parallel sides.

If stress is exerted in the direction of the arrows, the casting

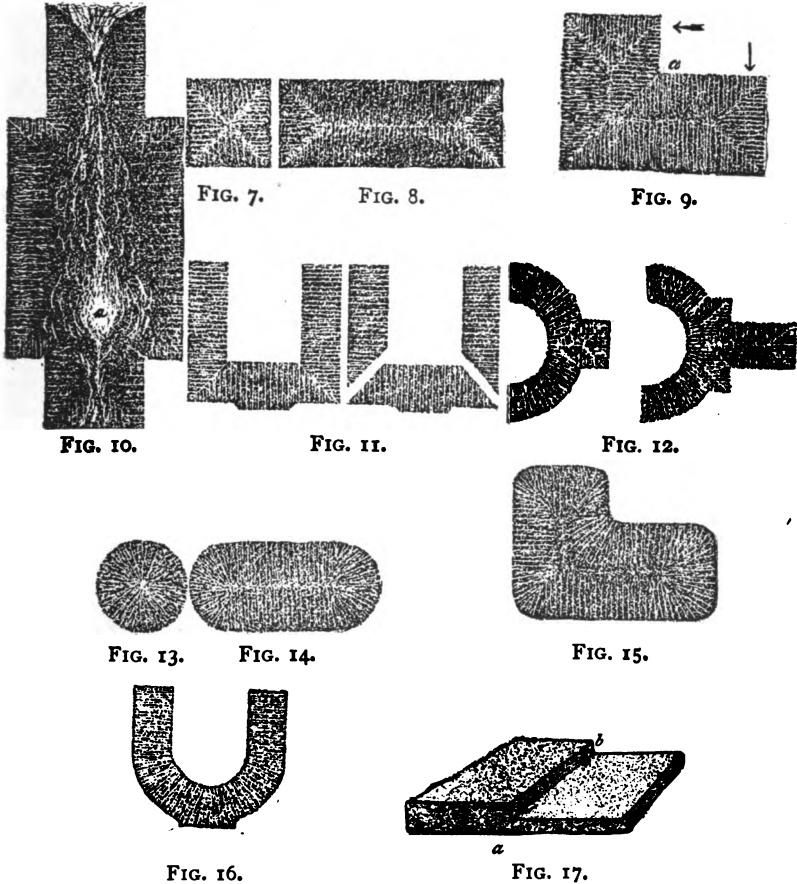

will crack from the inner corner through the outer corner, following the weak line, although there is more metal in this part of the casting.

Mr. Mallet refers to a case where the lower end of the cylinder of a hydraulic press, Fig. 11, was driven out by the pressure

of water, and that instead of breaking when there was least metal, it gave way nearly on the lines of weakness. He also gives a drawing, Fig. 12, of the breech of a cast-iron cannon, and another of a section of a trunnion showing weak lines. The gun will burst at one of these weak lines.

Let us now look for a means of remedy for Figs. 7 and 8. Fig. 13 is a section of a round casting of cast iron, and Fig. 14 a flat casting with the edges rounded.

The lines of crystallization are still perpendicular to the cooling surface, but there are less lines of weakness, the change being gradual. Fig. 15 is the same figure as Fig. 9, but all angles are rounded, and all lines of weakness are prevented.

If the hydraulic cylinder of Fig. 11 had been round as in Fig. 16, the cylinder would not have given way and less metal would have been used. In the construction of all castings all angles should be avoided, and all curves should be made as large as possible.

Molten cast iron should be poured as cold as it can be and fill the mold, especially in large castings, to allow of as little decrease of volume as possible.

In the case of the same iron poured in a casting that has both heavy and light portions, Fig. 17, the light portion cools first and shrinks most, while the heavy part cools last and shrinks least. This causes a tension all along the line *ab*, each particle in the thick part trying to break away from the thin part. This may not cause fracture, for the thin part will probably buckle. If the corner at *ab* had been made a large round, the change in cooling would have been more gradual.

This explains the cracking of the arms of pulleys where they join the rim, either in the mold or after being taken out.

Flanges or thickening on any part of a casting act in the same way. A runner often keeps one part of a casting hot while that around it has become solid. The cooling of the runner will afterwards often pull away and crack the casting.

CHAPTER V.

CARBON IN CAST IRON.

CARBON is found in nature in various forms. The purest form of carbon is the diamond with a specific gravity of 3.33 to 3.55. Soot from flame, as lamp-black, ivory-black, etc., is amorphous carbon. Graphite is nearly pure carbon, sp. gr. 2.15 to 2.35. The greater part of anthracite and bituminous coal and of charcoal is carbon. Iron has great affinity for carbon, and if commercially pure iron is placed in contact with carbon while at a high heat, it will absorb it and become steel.

With heat carbon unites with oxygen and forms carbonic acid gas. In this state the carbon is invisible, but, as it cannot be made to take a gaseous form, the carbon in carbonic acid is probably still a solid hid by the oxygen. This is indicated by the fact that the carbon can be made to separate in the form of soot. The coloring power of carbon is very great. In the blackest smoke there is not more than one grain weight of solid carbon in a single cubic foot, and this one grain would color black one gallon of water. The carbon in iron is derived from the fuel with which the iron was smelted, and the carbon from wood-charcoal, from coke, from soft coal or anthracite coal, each gives a different color and quality to the iron.

Carbon in Cast Iron.—Carbon is the most important element in cast iron. Without it iron could not be melted readily and made into castings. The percentage of total carbon determines the melting-point of the iron. Without carbon the degree of hardness and strength needed for various uses could not be given

to pure iron. Carbon is present in ordinary cast iron in larger proportion than any other constituent. The only practical method of obtaining iron from iron ore is in the blast-furnace, and by this process carbon is necessarily absorbed by the iron.

Origin of Carbon.—Iron ore is an oxide of iron. In the blast-furnace oxygen is removed and the remaining iron is melted. The process consists of charging into the furnace fuel and ore which descend together. At the lower end of the furnace hot air is blown in, which burns the fuel near the point where it enters, producing carbonic acid, which, ascending through the hot fuel higher up, becomes carbonic oxide by taking the extra carbon from the fuel.

This carbonic oxide takes the oxygen from the ore, thus again becoming carbonic acid. After the ore is relieved of its oxygen it is iron in the form of a sponge exposing a very large surface to the action of gases. As it passes downward toward the hottest part of the furnace, through the portion where the gas is carbonic oxide and carbonic acid, the iron sponge absorbs carbon from the gas. The amount that will be absorbed is inversely as the speed at which the ore descends. The greater the heat, the more carbon will be absorbed. For an iron to be high in carbon the furnace must be hot and the iron sponge must remain in contact with the gases a sufficient length of time. The sponge does not absorb carbon by being in contact with fuel, but by contact with the gas produced by the combustion of fuel. The more surface, the greater the contact; therefore iron made from dense, hard ore in large lumps will not contain as much carbon as when the same ore is broken very fine or when a more open ore is used. After the sponge reaches a point where the heat is sufficient to melt it there will be no increase of carbon.

The iron that runs out of the furnace has absorbed as much carbon as was possible under the existing conditions in the furnace.

Iron is at such a high temperature in the furnace that it is often able to hold more carbon in combination than it can when

the temperature is lowered. As soon, therefore, as it leaves the furnace the surface of the flowing metal is covered with floating graphite ("kish"). More or less will rise on the surface of the pigs. After the pig becomes solid the carbon which separates is caught as graphite between the grains and gives the fracture its gray color. From the time the sponge iron was melted in the furnace until the pig is cold there is a constant loss of carbon. A cupola can never heat iron much above its melting-point, and it can therefore never absorb more carbon than it already has; and as a general thing it cannot reabsorb quite all of the graphite that has lodged among its own crystals. In the cupola the iron is not in a finely divided state when compared with the sponge iron of the furnace.

In the cupola the melted drops are not in contact with the fuel or carbonic acid gas to any great extent and never in contact with carbonic oxide gas, and the passage into the hearth is very rapid.

Quantity of Carbon Present.—This is due to the character of the ore and to other conditions, and is from about 2% to 4.25%. If by any means the iron has absorbed in the furnace more carbon than it can hold after it becomes solid, the excess will separate the same as soot separates from a clear flame.

Saturation of Carbon.—By saturation is generally understood the largest percentage that it is possible for any iron to hold when solid. For charcoal-iron it may be 4%, while for coke and anthracite-irons carbon does not generally exceed 3.50% or 3.75%. Iron made in a cold furnace or with all the ore that the fuel can possibly take care of will contain much less carbon than if made under contrary conditions.

Condition of Carbon in Cast Iron.—When cast iron is melted all of its carbon is supposed to be combined with or dissolved in the iron. It is supposed that if it were in any other form it would rise on account of its lightness and float on the surface. When the iron is solidified its carbon will remain in the combined state unless some influence is present to change it. If any such influ-

ence should change the carbon and the influence is removed, the carbon will resume the combined state. The combined is the natural form for carbon to assume which has been absorbed by pig iron; therefore, owing to the conditions present in the furnace, if the iron has not absorbed more carbon than it can hold when cold, it will be white pig iron.

If the casting contains more carbon than it can hold, the darkest casting will be that which contains most carbon to begin with; and secondly, that casting will be darkest which is cooled most slowly. The larger the mass, under ordinary conditions, the slower the cooling; therefore large castings are darker than small castings from the same iron.

Diffusion of Carbon in Cast Iron.—Probably a variation of .05% is as near as can be expected in the different parts of a single casting, and the extremes of variation will be 0% to .12%.

By a very interesting series of experiments described in Chapter VIII on Keep's "Cooling Curves," it is shown that graphite was not formed until after the casting had become solid, and the graphitic scales exude into the spaces between the crystals. After this takes place the casting must consist of a network or sponge more or less crystalline, with the spaces filled with closely packed graphite. The network must be a lower carbide of iron than the fluid iron.

Bulk of the Carbon in Cast Iron.—It is evident that the more carbon the less will be the weight of a casting of a given size. Castings containing a large percentage of graphite are coarse-grained, and the coarse crystals have large spaces between them, which causes the casting to be larger.

A cubic foot of pure iron weighs 489 lbs., with sp. gr. about 7.84.

A cubic foot of white cast iron weighs 474 lbs., with sp. gr. about 7.60.

A cubic foot of mottled iron weighs 458 lbs., with sp. gr. about 7.35.

A cubic foot of light gray iron weighs 450 lbs., with sp. gr. about 7.20.

A cubic foot of dark gray iron weighs 425 lbs., with sp. gr. about 6.80.

Thus in iron with 3% of carbon the carbon forms about 12% of the entire bulk, and in pig iron containing 4% the carbon forms about 15% of the bulk (see Fig. 5).

Carbon and Chill.—Iron with its carbon combined is white. Slow cooling of any carbonized iron causes some carbon to take the graphite form. If the metal is cooled so suddenly that the carbon cannot have time to become graphite, the casting will be white. This sudden cooling is accomplished by making a portion of the mold out of iron, which, as the fluid iron runs against it, will suddenly draw the heat from the metal. The white portion of the casting is chilled.

Carbon and Hardness.—The purest iron of commerce has a hardness of about 40 (Turner's test). I melted a sample which had in the casting 0.29 of carbon and had a hardness of 44. Ingot-iron test-bars with carbon 0.39 had a hardness of 45.

Carbon and Fusibility.—Truran says "fusibility is directly dependent on the proportion of the volumes of the respective ingredients forming the pig iron." Pure iron cannot be melted by ordinary furnace heat. Steel containing from 0.25% to 1.50% of carbon can be melted with difficulty. The cast iron which contains the most carbon melts the most readily. At a bright red heat the graphite changes into combined carbon and the iron at once melts, beginning at the outside of the pig. Thus pure iron and graphite, neither of which can be melted alone, at a high heat form a fusible alloy. Any dilution of carbon makes the iron harder to melt. At each remelting of cast iron the metal became more infusible. In the series Table IV when carbon reached 2.25 it was very difficult to fill the molds.

Fluidity.—Carbon is the principal agent for imparting fluidity. The presence of carbon, by lowering the temperature of fusion, increases the fluidity of cast iron.

Gray iron is more fluid than white iron, but requires a much higher temperature for fusion. White iron, slightly cooled, is thickly liquid and passes through a pasty stage between the solid and fluid states which does not allow gases to escape freely, which partly accounts for the blow-holes in white-iron castings. As soon as the graphite in gray cast iron becomes combined the iron melts and becomes very fluid in proportion as the percentage of graphite was great or small.

The author has made a number of experiments to show the influence of different percentages of carbon, but in nearly all of them the physical quality was also influenced by variations of some other elements or by other conditions.

Carbon may be lowered by repeated remeltings. In ordinary foundry practice some of the metal melted each day is returned to the cupola the next, and is remelted with the pig iron.

On pp. 67 and 68, Fig. 29 and Table XVII are derived from remelts of Gaylord white pig iron, and Fig. 32 and Table XX from remelts of F^LM (Method 12). The fluidity grew less as carbon decreased. The decrease in strength shown in the tests of white iron was largely due to the blow-holes.

A very small quantity of graphite will prevent blow-holes, and it need not be sufficient to make the casting gray.

Another method by which the carbon may be lowered in test-bars is to introduce into the melted cast iron wrought or steel scrap. This adds strength so long as the carbon is not so much reduced as to make unsound castings. The following tests illustrate this. Page 71 (Fig. 33 and Table XXI) is that of F^LM remelted (Method 13) with additions of iron wire to cause successive dilutions of the carbon.

Fig. 30 and Table XVIII are "Gaylord" white pig iron with iron wire (p. 67).

In the series thus far considered not only has carbon varied, but silicon also. In fact, the cause of blow-holes was not wholly due to a lack of carbon, but to too low silicon. In the series Fig. 18 and Table IV (Method 6) silicon is kept uniform and the

carbon is therefore the only variable. The lessening of carbon turns the iron white, and bars 564 and 568 would not run full.

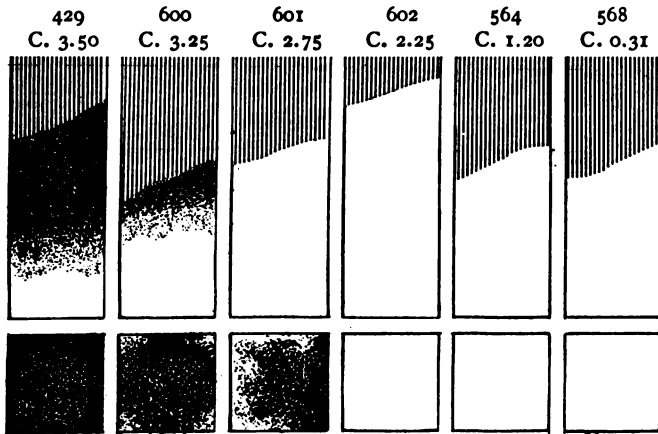

FIG. 18.—Dilution of Carbon.

TABLE IV.

Test No.	Mixture.	Strength.		Dead-load Deflection.	Shrinkage.		Chill.
		Dead Load.	Impact.		Square Bar.	Flat Bar.	
429	F ^{LM} 3.50 per cent carbon ...	335	330	.23	.166	.200	.60
600	" 3.25 " ..	460	356	.20	.174	.226	.60
601	" 2.75 " ..	53219	.197	2.00
602	" 2.25 " ..	673	525	.19	.256	.261	all.

In England in 1846 Sterling took out a patent for toughened cast iron. Many reports were made of the strength of this mixture of cast iron and wrought iron. He says that the wrought iron must be less than the cast iron, and that the exact percentage depends upon the quality of cast iron to begin with. With 100 parts of cast iron, 10 parts of wrought increased the strength 2%; 20 parts of wrought increased the strength 32%; 30 parts, 60%; but 40 parts only 33%. The maximum result was therefore produced with about 30% of wrought scrap.*

* Thomas Turner, Journal Soc. of Chemical Industry, May 29, 1886.

Table V is introduced in this place to show how the results under the column "Impact" of Table IV and of other tables to be introduced were obtained.

TABLE V.

Inches Fall of 25-lb. Hammer.	Inch-pounds Developed.	Arbitrary Value for each Blow in lbs. Avoirdupois.	Inches Fall of 25-lb. Hammer.	Inch-pounds Developed.	Arbitrary Value for each Blow in lbs. Avoirdupois.
.12	3.12	16.94	3.12	78.12	423.53
.25	6.25	33.88	3.25	81.25	440.47
.37	9.37	50.82	3.37	84.37	457.41
.50	12.55	67.76	3.50	87.55	474.35
.62	15.63	84.70	3.62	90.63	491.29
.75	18.70	101.65	3.75	93.70	508.24
.87	21.87	118.59	3.87	96.87	525.18
1.00	25.00	135.53	4.00	100.00	542.12
1.12	28.15	151.46	4.12	103.12	559.06
1.25	31.25	169.41	4.25	106.25	576.00
1.37	34.38	186.35	4.37	109.37	592.94
1.50	37.41	203.29	4.50	112.55	609.88
1.62	40.61	220.23	4.62	115.63	626.82
1.75	43.72	237.18	4.75	118.70	643.77
1.87	46.87	254.12	4.87	121.87	660.71
2.00	50.00	271.06	5.00	125.00	677.65
2.12	53.13	288.00	5.12	128.12	694.59
2.25	56.25	304.94	5.25	131.25	711.53
2.37	59.37	321.88	5.37	134.37	728.47
2.50	62.55	338.82	4.50	137.55	745.41
2.62	65.63	355.76	5.62	140.63	762.35
2.75	68.70	372.71	5.75	143.70	779.30
2.87	71.87	389.65	5.87	146.87	796.24
3.00	75.00	406.59	6.00	150.00	813.18

Table V shows the number of inch-pounds developed by each blow. Also gives an arbitrary value to each blow in pounds avoirdupois, to allow comparison and tabulating with records from Keep's dead-load machine.

The value for an inch-pound was obtained by testing a good sample of Swedish gray pig iron which broke in the dead-load machine with 288 pounds and by impact with a 2½-inch fall. The table was constructed from this data.

Table VI shows the influence of annealing ordinary gray cast iron.

The test-bars were all measured for shrinkage, then one of each pair was tested, while the companion bars were packed in wood shavings and heated to a white heat in 12 hours and then cooled in another 12 hours. The only chemical change is in graphite and combined carbon.

The iron is more than 30% softer, has lost one-half of its chill,

33% of its shrinkage, and its deflection is increased nearly 50%. The hardness in this table is obtained by the Keep machine, Fig. 96, page 187.

This does not prove, however, that the same proportions of graphite and combined carbon in the original mixture would produce castings with these physical properties.

Probably the carbons in the annealed castings have peculiarities which the chemist did not determine.

TABLE VI.

	Shrinkage.		Chill.	St'gth	Def.	Hardness.		Analysis by Dickman and Mackenzie.						
	$\frac{1}{4}'' \square$	$\frac{1}{4}'' \times \frac{10}{16}''$				$\frac{1}{4}'' \square$	Dead Load.	One End $\frac{1}{4}'' \square$	Other End $\frac{1}{4}'' \square$	T.C.	C.C.	C.C.	Si.	P.
No. 1 bar not annealed.....	.155	.169	.14	435	.28	30.8°	28.5°	3.77	3.32	.45	1.78	.505	.041	.568
No. 3 bar not annealed.155	.173	.14	415	.27	31.0	29.0							
Average.....	.155	.171	.14	425	.27 ²	30°							
No. 2 bar not annealed.	1.57	.167	.14											
No. 4 bar not annealed.....	.155	.169	.14											
Average.156	.168	.14											
No. 2 bar annealed	.096	.069	.06	400	.36	19°	19°	3.77	3.68	.05	1.78	.510	.043	.568
No. 4 " "	.096	.070	.08	400	.34	19°	19°							
Average090	.069 ²	.07	400	.35	19°							

Analysis of Carbons of A. S. M. E. Tests.—For Total Carbon, see Table LXI, p. 132; Combined Carbon, LXII, p. 133; Graphitic Carbon, LXIV, p. 138. To show the influence of remelting on Carbon, see analysis of the original irons on pages 11 and 12, also see Table LXIII, p. 136.

CHAPTER VI.

SILICON IN CAST IRON.

Silicon.—This metalloid is reduced from its oxide, silica, of which quartz is an example. Silica is contained in all the iron ores, and in the ash of all fuel; therefore more or less silicon is always found in cast iron. Metallic silicon is said to be of a dark iron-gray color, and has such an affinity for oxygen that it must be kept away from air. The specific gravity of silicon is 2.49. It alloys with iron in all proportions up to 10%, and by special treatment to 20% or 30%.

Silicon can be present to a certain per cent in iron that is otherwise comparatively pure and still leave it malleable, such metal being called silicon steel. The presence of silicon is necessary if cast iron is to be used for ordinary casting purposes. According to Truran, silicon, being as bulky as carbon, should increase the fusibility of cast iron.

Silicon in Cast Iron.—During the year 1885 Professor Turner published the results of his researches showing that additions of silicon to a specially made white iron would change it to gray, and that by varying the silicon the softness and grayness could be controlled at will. This discovery was of such practical importance to founders that the question was raised whether the influence of silicon would be the same in ordinary pig iron made in a blast-furnace. To determine this question, during the years 1886 to 1888 the author made a large number of series of tests using Professor Turner's methods. Only a few series are given.

The following irons (Table VII) were used to determine the

influence of silicon in cast iron in the first six series of tests. Professor Turner's white and silicon irons are inserted for comparison.

TABLE VII.

IRONS USED IN TESTS.

Test No.	Kind of Iron.	T.C	G.C.	C.C.	Si.	P.	S.	Mn.	How made.	
										Dead Load.
		Str'n.	Def.	Str'n.	Def.	$\frac{1}{2}'' \square$	$\frac{1}{10}'' \times \frac{1}{1}''$			
376	White (Gaylord),	2.98	0.95	2.03	0.186	0.26	0.03	0.09	Blast furnace	
	" (Turner),	1.98	0.38	1.60	0.190	0.32	0.05	0.14	Cementation	
441	Gray (F.L.M.)	3.55	3.22	0.33	1.249	0.084	0.04	0.187	Blast furnace	
	Silicon iron (Turner),	1.81	1.12	0.69	0.80	0.210	0.04	1.950	" "	
396	" " (imported)				10.27					
397	" " (Pencost),				4.37				Blast furnace	
401	" " " "	1.99	1.92	0.07	10.34	0.45		0.52	" "	

Test No.	Kind of Iron.	Dead Load.		Impact.		Shrinkage.		Chill.	Fluidity.	Hardness.
		Str'n.	Def.	Str'n.	Def.	$\frac{1}{2}'' \square$	$\frac{1}{10}'' \times \frac{1}{1}''$			
376	White (Gaylord),	379	.14	237	.16	.248	.246	all	5.60	100
	" (Turner),	337							72
441	Gray (F.L.M.)	362	.27	339	.29	.168	.186	.40	4.50	74
	Silicon iron (Turner)	157							57
396	" " (imported)	144	.08	68	.06	.309	.293	.12	6.62	
397	" " (Pencost),	478	.25	425	.27	.139	.146	.10		64
401	" " " "	231	.12	125	.11	.199	.201			132

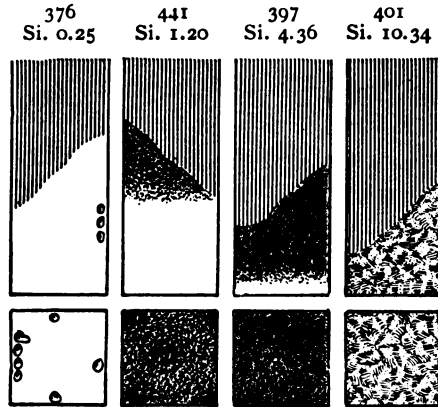

FIG. 19.

The fractures of four of these irons are shown in Fig. 19 (Method 4). Table VIII shows the percentages of silicon, the hardness, and the calculated transverse strength of a $\frac{1}{2}'' \square$ test-bar of the original series by Professor Turner.

TABLE VIII.

TURNER'S TESTS.

Silicon in test bars.....	0.19	0.45	0.96	1.37	1.06	2.51	2.96	3.92	4.74	7.33	9.80
Calculated dead-load transverse strength of test bars $\frac{1}{8}'' \square \times 12''$ long.....	337	410	421	437	431	442	356	318	293	188	157
Hardness (Turner's test)	72	52	42	...	22	22	22	27	32	42	57

Silicon added to white iron changes it to gray iron.

The upper series, Table IX (Method 11), using Gaylord white pig iron 376 and the 16% ferrosilicon 396 shows this. The fractures are shown in Fig. 20.

TABLE IX.

	No. Test.	Calculated Si.	Dead Load.		Impact Strength	Shrinkage.		Chill.	Turner's Hardness.
			Strength	Def.		$\frac{1}{8}'' \square$	$\frac{1}{16}'' \times 1''$		
White iron + silicon	376	0.25	379	.14	237	.248	.246	White	108
	193	0.40	406	.13	216	.259	.257	98
	194	0.73	452	.13	271	.256	.258	96
	195	1.25	468	.16	314	.232	.251	.90	93
	196	1.71	412	.20	322	.18765	91
	197	2.22	445	.21	374	.200	.232	.90	76
	198	2.90	420	.19	348	.160	.230	.80	65
	200	3.24	422	.22	374	.149	.201	.35	61
	201	3.59	436	.23	373	.147	.204	.25	54
	202	3.84	430	.20	433	.150	.213	.45	52
F ^L M gray iron + silicon	184	1.25	420	.32	458	.17220	
	185	1.50	348	.25	381	.167	.182	.35	
	186	2.00	332	.23	305	.160	.167	.27	
	187	2.50	356	.20	330	.156	.164	.10	
	188	3.00	362	.30	382	.142	.162	.07	
	189	3.50	343	.25	322	.140	.158	.15	
	190	4.00	378	.29	330	.137	.158	.17	
	191	4.50	424	.28	389	.146	.165	.15	

Silicon added to gray iron low in silicon will make it more gray.

The lower series, Table IX (Method 11), with F^LM gray iron and the 16% FeSi, proves this. The fractures of this series are shown by 184 to 191 of Fig. 20.

It is evident that while additions of silicon change combined

carbon into graphite, yet a given percentage of silicon does not always produce a given physical quality.

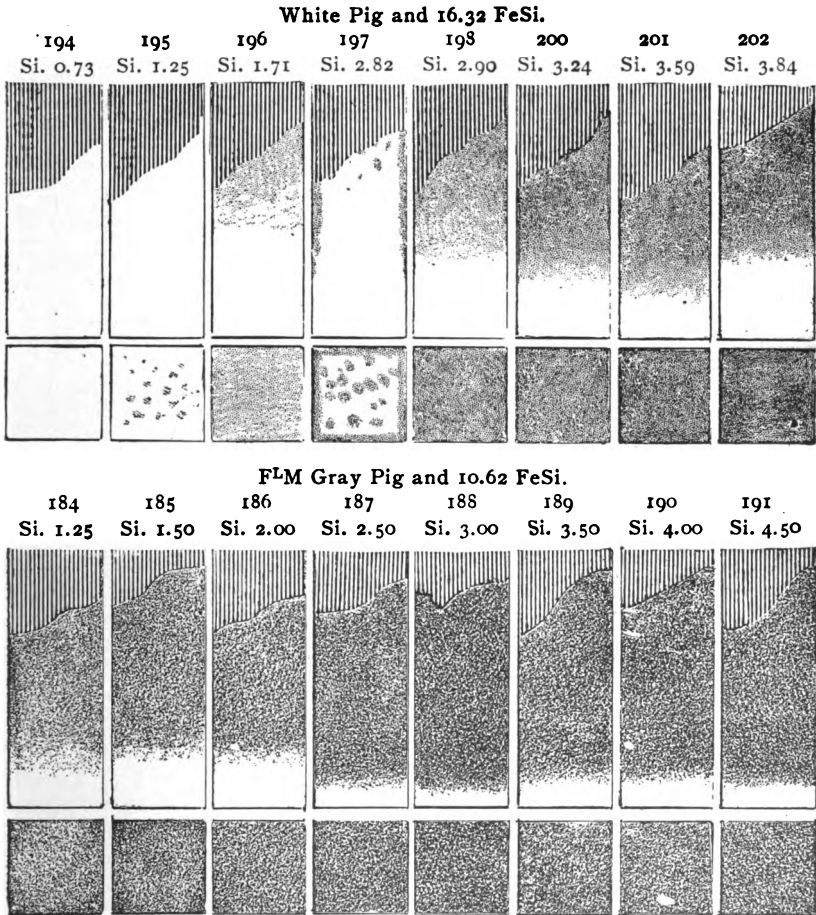

FIG. 20.

It is the influence of silicon, not the percentage, that produces the physical quality, as is shown more clearly by Table X and Fig. 21 (Method 4).

Fig. 19 shows the appearance of grain of the irons used to make the mixtures, and Table VII the chemical composition.

Examine in Fig. 21 the fractures of the bars of each series

containing 1.50% silicon, or the bars of each containing 2%, or those with 2.50% or 3.00%: though the silicon is the same in each, the influence of silicon in each bar containing the same percentage depends upon the total carbon and its condition in the original irons, and upon other unknown conditions. To more fully illustrate this see Fig. 22 and Table XI (Method 4). The

TABLE X.

Mixture.	No. Test.	Calculated Percentage Silicon.	Dead Load		Impact.		Shrinkage.		Hardness.	Chill	Actual per cent Silicon.
			Str'n	Def.	Str'n	Def.	Sq. Bar.	Thin Bar.			
White + Silicon.											
376+401	344	1½ per cent silicon.....	466	.14	299	.15	.227	.243	84	All	1.48
	345	2 " " ".....	486	.21	356	.21	.169	.339	60	1.25	1.92
	346	2½ " " ".....	416	.19	362	.21	.163	.220	57	.60	2.42
	347	3 " " ".....	421	.23	451	.27	.155	.167	55	.22	2.8
White + Silicon.											
376+397	340	1½ per cent silicon.....	501	.19	486	.27	.179	.243	65	1.25	1.49
	341	2 " " ".....	464	.22	390	.20	.161	.217	57	.60	1.97
	342	2½ " " ".....	498	.27	466	.29	.156	.161	56	.20	2.55
	343	3 " " ".....	452	.25	390	.22	.147	.160	53	.18	2.95
F ^L M + Silicon.											
441+397	348	1½ per cent silicon.....	362	.23	345	.25	.162	.175	58	.40	1.50
	349	2 " " ".....	363	.23	334	.22	.156	.158	45	.22	2.01
	350	2½ " " ".....	380	.28	350	.28	.143	.149	42	.10	2.42
	351	3 " " ".....	370	.26	385	.27	.134	.153	28	.08	2.86
F ^L M + Silicon.											
441+401	352	1½ per cent silicon.....	365	.23	373	.29	.163	.181	54	.40	1.53
	353	2 " " ".....	348	.23	228	.23	.161	.162	50	.20	2.11
	354	2½ " " ".....	318	.24	277	.24	.141	.149	39	.07	2.41
	355	3 " " ".....	348	.30	401	.32	.148	.148	42	.03	2.86

same F^LM (441) was used for the bulk of each mixture. The silicon of each mixture was 2.50%. The 1.25 silicon added in each case was obtained by using a different silicon iron, the silicon of which are given in the table.

The influence of silicon is indirect, acting through the carbon which the iron contains.

Silicon lowers the saturation point of carbon, that is, an addi-

tion of silicon to iron containing combined carbon expels carbon in graphitic form, which is caught between the grains of the iron, giving it a grayer color.

The influence of silicon is modified by the various conditions

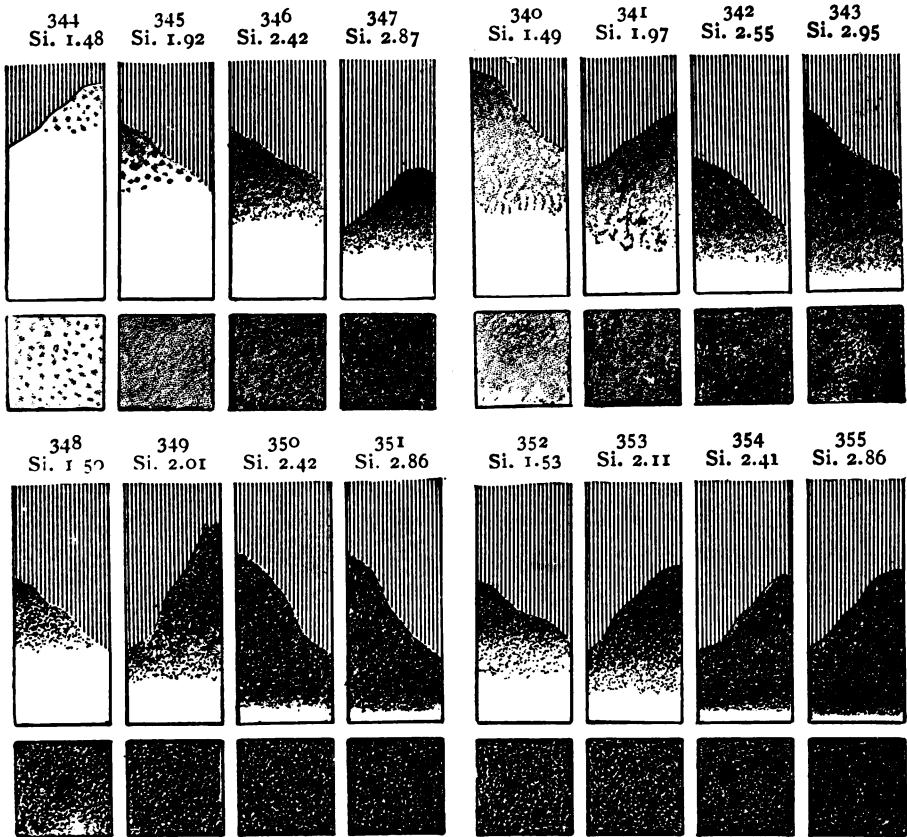

FIG. 21.

attending remelting and cooling of the iron. The more total carbon or the less combined carbon in the iron the less silicon will be required to produce a given effect.

Less silicon acting a long time, as in slow cooling of large castings, or more silicon acting in a short time, as in rapid cooling of small castings, will produce similar effects.

CAST IRON.

TABLE XI.

2.5 PER CENT SILICON IN EACH TEST-BAR.

Silicon Irons used in Mixture with F.L.M.			No. Test.	Dead Load.		Impact.		Shrinkage.		Chill.	Fluidity.	Hardness.
No. Test.	Name.	Per cent of Si.		Str.	Def.	Str.	Def.	$\frac{1}{2}'' \square$	$\frac{1}{16}'' \times 1''$			
36	Wellston.....	5.66	447	384 .26	362 .26	.146	.155	.08	4.12	.58		
397	Pencost.....	4.36	350	380 .28	350 .26	.143	.149	.10	10.00	.52		
403	"	12.08	448	375 .20	322 .24	.144	.208	.35	8.37	.60		
140	Dayton.....	4.35	449	375 .26	333 .26	.145	.158	.04	12.00	.64		
214	Govan.....	9.85	450	367 .28	384 .30	.147	.159	.04	7.03	.48		
398	Pencost.....	6.76	451	357 .23	345 .27	.141	.155	.08	.07	.48		
213	Foreign.....	11.99	452	349 .22	277 .22	.138	.182	.35	8.62	.40		
221	"	10.62	453	342 .21	311 .24	.140	.171	.23	11.00	.40		
35	Wellston.....	6.99	454	341 .29	293 .29	.148	.157	.13	10.62	.58		
39	"	5.15	455	337 .28	339 .27	.150	.157	.05	11.50	.80		
396	Foreign.....	16.32	456	327 .20	282 .23	.140	.164	.23	7.84	.48		
401	Pencost.....	10.34	354	318 .24	277 .23	.141	.149	.08	9.25	.48		

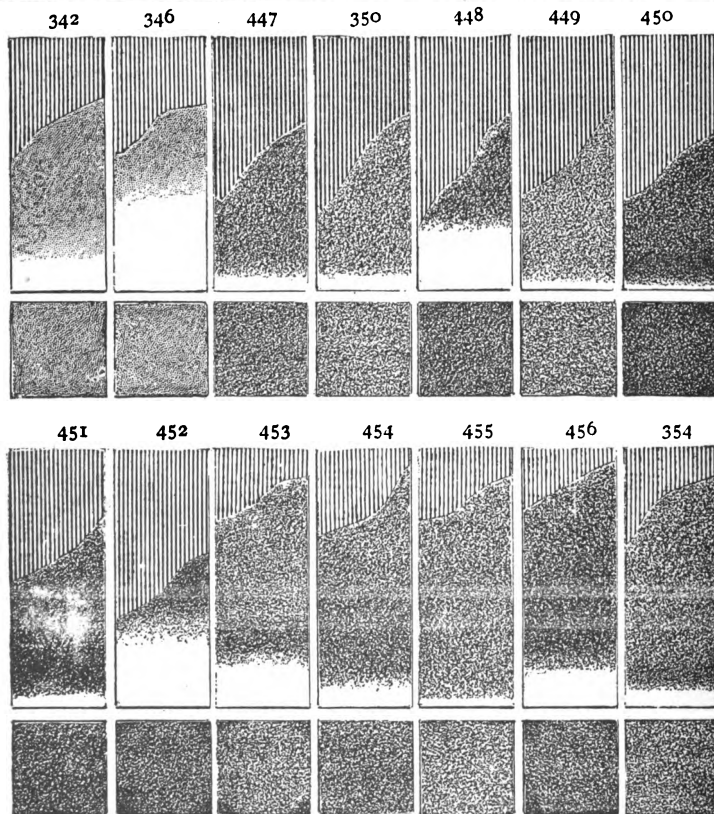

FIG. 22.—Silicon 2.5% in each.

It is the influence of silicon upon the physical quality in a casting that is of value to a founder.

By changing silicon in an iron mixture we can control the state of carbon and also the chill. Silicon, acting through carbon, is therefore the controlling element in cast iron.

White iron contains less than 1% of silicon.

No. 3 Foundry should contain about 1.50% of silicon.

" 2	"	"	"	"	2.25%	"	"
" 1	"	"	"	"	2.50%	"	"
" 2	Soft	"	"	"	3.00%	"	"
" 1	"	"	"	"	3.25%	"	"
Silvery iron	"	"	"	"	4 to 6%	"	"

High-priced silicon iron contains from 6% to 10%.

By mixing these irons we can get any desired percentage of silicon in the casting.

Diffusion of Silicon in Cast Iron.—Table XII gives the silicon of nineteen series of tests made by the author for the American Society of Mechanical Engineers. It has been supposed that if the product of a blast-furnace could be caught in a mixing-ladle before it was run into the pig bed, an iron could be produced which would make castings of homogeneous chemical composition. If in Table XII (Method 1) we subtract the smallest record in a series from each other record, the remainders will show the excess of silicon in each test-bar poured from one ladle from iron which was supposed to contain the same percentage of silicon. Series 19 was from iron taken from a 1200-lb. mixing-ladle, and the mixture was made up of pig irons of very nearly uniform composition, and the average silicon in all test-bars was .77%. The variation was .19 with an average of .09%.

Series 18 was made of pig irons of nearly uniform composition and good scrap mixed in a 1200-lb. ladle. The average silicon in the test-bars was 2.96, with variation .42 and an average of .24%.

Series 15 is an example of the practice of imparting silicon by a low silicon silvery iron. The iron was melted at the rate of

eleven tons an hour, and was caught as fast as it was melted, and no effort was made to obtain even diffusion. The variations of .26 and average of .22 show that as perfect diffusion may be obtained without as with the mixing-ladle. Series 2 to 6 are made from the same pig as series 1, with increasing additions of an 11% ferrosilicon. The diffusion of silicon is very irregular, but the average variations increase as the silicon increases, showing, in connection with the other series, that the diffusion is less complete as silicon increases in quantity.

TABLE XII.

A. S. M. E. TESTS.

	Series.	Per cent Nominal Silicon.	Per Cent of Silicon.						Si. Av.
			½"□	1"□	1" × 2"	2"□	3"□	4"□	
Iroquois.....	1	1.00	.83	.79	.78	.82	.72	.88	.81
	2	1.50	1.09	1.14	1.70	1.33	1.10	.88	1.20
	3	2.00	1.73	1.73	1.70	1.50	2.17	2.50	1.88
	4	2.50	2.13	1.69	1.60	1.80	2.17	2.07	2.01
	5	3.00	2.42	2.65	2.40	3.36	3.67	4.67	3.19
	6	3.50	2.74	2.69	2.70	2.62	4.30	3.22	3.04
Hinkle... ..	7	1.00	.91	.93	.86	.90	.85	1.12	.93
	8	1.50	1.16	1.29	1.10	1.22	1.25	1.03	1.17
	9	2.00	.93	1.40	1.05	1.00	2.15	3.50	1.67
	10	2.50	2.84	2.55	2.70	2.00	1.75	1.57	2.23
	11	3.00	2.56	2.75	2.97	2.49	2.64	2.84	2.71
	12	3.50	2.77	3.75	3.41	2.91	2.89	2.95	3.05
Southern.....	14	2.70	2.80	2.81	2.79	2.94	2.81	2.81
	13	3.13	3.22	3.17	3.19	3.20	3.15	3.18
	15	3.29	3.50	3.52	3.48	3.75	3.42	3.51
C.G. Bretting & Co.	16	1.90	1.86	1.68	1.61	1.83	1.70	1.76
Mich Mall. Iron Co.	178167	.86	1.24	.92
Bement, Miles & Co.	18	2.29	2.09	2.24	1.82	2.06	1.88	2.05
A. Whitney & Sons	1987	.72	.78	.81	.68	.73	.76

Loss of Silicon in Remelting.—An analysis of drillings from three pigs of Iroquois iron by Mr. C. D. Chamberlain gave .88%, and an analysis of drillings from twenty-five pigs of the same lot of iron by Messrs. Dickman and Mackenzie gave 98% silicon. The analysis of each of the six sizes of test-bars of

series I showed a variation of silicon between .72 and .83, or the same variation as the two analyses of the pig iron. The average silicon in the six castings was .80%, showing the loss during the remelting of .08% to .18% of silicon, and indicates that there is a loss of as much as 10% of the silicon in the iron during remelting in a cupola. See also Table LXIII, p. 136.

There could not have been a more careful mixture of iron to produce given percentages of silicon than in the series I to 6, and a slight excess of silicon was added (Method 1), for it was expected that there would be a loss in remelting. The calculated and average silicons, by analysis, are shown in the upper part of Table XIII.

TABLE XIII.
LOSS OF SILICON IN MELTING IROQUOIS PIG IRON.

No. Series.		1	2	3	4	5	6
CUPOLA.	Calculated Si.....	1.00	1.50	2.00	2.50	3.00	3.50
	Si by Analysis.....	.80	1.21	1.88	2.01	3.19	3.04
CRUCIBLE.	Calculated Si.....	1.00	1.50	2.00	2.50	3.00	3.50
	Si by Analysis.....	1.23	1.64	2.04	2.25	3.10	3.49

To show how impossible it is to produce an exact percentage of silicon in castings, even by an analysis of pig iron, the lower part of Table XIII gives the calculated and exact silicons in six crucible heats of the same mixtures of iron. The Iroquois pig iron from the analysis was supposed to contain .88% of silicon. The additional silicon to make even percentages was obtained by additions of 11% ferrosilicon (no excess was added to make up for loss). The variations in silicon, as shown by the analysis of Mr. E. E. Mains in Table XIII (crucible), indicates that there must have been an unequal diffusion of silicon in the material used.

These examples seem to prove that it is only possible to

obtain an approximation of the silicon in a pile of pig iron, and that it is much less possible to obtain the percentage of silicon in a pile of scrap, and that, having obtained an approximation by analysis, the loss of silicon during remelting, and the uneven diffusion of silicon in the casting, make it possible to obtain, by an analysis of the original materials, only an approximation of the percentage of silicon in the casting.

An analysis of the casting itself gives the only reliable information, and this is only an approximation from the uneven diffusion of silicon.

Silicon and Hardness.—All records of hardness (except those in the chapter on Hardness) are given in terms of grams placed on a diamond to cause it to make a scratch on a polished surface with Professor Turner's machine. Silicon is a softener when added to hard cast iron.

✓ From 2% to 3.50% of silicon will change into graphite all of the combined carbon that can be changed. This change, we know from experience, generally reduces hardness. The iron that remains is softer, because iron of itself is soft and was hardened by the carbon that was combined with it. The more the combined carbon is changed into graphite the softer the remaining iron.

Probably silicon itself, however small the quantity present, hardens cast iron; but the decrease of hardness from the change of the combined carbon to graphite is so much more rapid that the total effect is to decrease hardness, until the silicon reaches from 2% to 3%, which is as much as is required in practical foundry work.

Silicon and Chill.—Silicon removes the chilling tendency of an iron. This influence of silicon is greatly modified by the state and quantity of carbon in the iron used.

Silicon and Fluidity.—While the records are only an indication of the fluidity of each cast due to the heat of that cast, yet when silicon is mixed with irons previously low in silicon the fluidity is increased.

Silicon and the Surface of a Casting.—One of the most useful influences of silicon is the color and freedom from sand that it imparts to the surface of a casting. The liberation of graphite at the surface interposes between the hot iron and the sand mold a layer of graphite, which in thin castings prevents the sand from burning on. In heavy castings the graphite is deposited under the scale and causes it to peel off and leave a smooth surface.

✓ **The Relation of Carbon to Silicon in Pig Iron.**—In Table XIV, with silicon at from 2% to 2½% or even 3%, the maximum percentage of carbon may be present. Above this point silicon replaces carbon. At one end of the series, a very low silicon and low carbon, with about 2½% silicon we have the highest carbon, and at the other extreme of the series we find the highest silicon and no carbon.

TABLE XIV.
RELATION SILICON TO CARBON.

	Gaylord White Pig.	FLM Swedish Pig.	Norway No. 1 Foundry.	Calumet No. 1 Foundry.	Star Silvery Iron.	Globe Silvery Iron.	Govan Ferro Silicon.	Pencost Ferro Silicon.	Pencost Ferro Silicon.	Ferro Silicon bought of Geisenheimer.	Ferro Silicon made by Prof. E. Riley.
Si.....	0.18	1.25	2.03	3.15	4.39	5.89	9.10	10.34	12.08	16.27	20.00
T. C.....	2.53	3.55	3.75	3.56	3.44	3.15	2.58	1.99	1.58	.75	.00
G. C.....	.49	3.22	3.12	2.46	3.40	2.85	.90	1.92	1.52		
C. C.....	2.12	.33	.63	1.10	.04	.30	1.68	.07	.06		
P.....	.26	.08	1.65	1.06	1.42	1.16	.09	.45	.48	.01	
S.....	.03	.04	.01	.02	tr	.02	.03	tr	tr	.01	
Mn.....	.09	.18	.87	1.35	1.00	2.20	.57	.76	.60	

CHAPTER VII.

SHRINKAGE OF CAST IRON.

THE general understanding is that the shrinkage of a casting is the difference in length (or any other linear dimension) between the casting and the pattern from which it was made, or rather between it and the mold in which it was cast.

It has generally been understood that the shrinkage of cast iron is one-eighth of an inch per foot. The pattern-maker, in taking measurements for the different dimensions of the pattern, uses a "shrink-rule," which is one-eighth inch longer than the standard foot-rule which is used to measure the casting.

In the investigation of shrinkage it must be understood that *one size of test-bar must be used when the influence of variations in chemical composition is being observed.*

Any one size of test-bar could be used as a measure of shrinkage, but the author has adopted a test-bar $\frac{1}{2}$ " \square \times 12" long because it is convenient to make and handle, is more sensitive to any change in composition of the iron mixture, and shows a wider range of shrinkage than any other size.

In the examination of the variation in shrinkage caused by a variation in size of test-bar, iron of unvarying composition should be put into all the sizes of test-bars.

Carbon and Shrinkage.—When iron becomes crystalline it will occupy more space than before it became so. Carbon causes iron to become crystalline, therefore it reduces shrinkage. Pure iron shrinks about .300 of an inch per foot. Iron in melting expands for each degree of heat that has entered it. It is poured into the mold at this high temperature, therefore in cooling it must shrink as much as it has been expanded.

Iron containing carbon melts at a lower temperature than pure iron, and consequently shows less shrinkage.

“Dayton” white iron had a shrinkage of .221”.
 “ mottled “ “ “ “ “ .179”.
 “ close gray “ “ “ “ “ .167”.
 “ dark “ “ “ “ “ .145”.

✓ *Silicon reduces shrinkage by changing combined carbon into graphite.* Its direct influence is overcome, and its influence as a reducer of shrinkage is seen, through its action on carbon. See Tables IX to XIV.

Anything that decreases silicon increases shrinkage. Fortunately any increase of shrinkage produced by any chemical element in cast iron can be largely overcome by increasing silicon.

In June, 1894, from the data then at hand, the author prepared the following proposition:

“To produce a given uniform grain and a sound casting, and with one-eighth of an inch shrinkage to the foot, the silicon must vary with each variation in the size of the casting. And such a variation in silicon will cause a variation in the shrinkage of a half-inch test-bar.”

Table XV shows the shrinkage of a $\frac{1}{2}$ -in. test-bar that will indicate the correct amount of silicon for each size of casting to produce a shrinkage of $\frac{1}{8}$ in. per foot according to this proposition.

TABLE XV.

AN APPROXIMATE KEY FOR REGULATING FOUNDRY MIXTURES.

Size of the Casting.	Silicon required in the Casting.	Shrinkage of the Casting.	Shrinkage of a $\frac{1}{2}$ " □ Test Bar from the same Ladle.
$\frac{1}{2}$ -inch square	3.25 per cent	.125 ins. per foot	.125 ins. per foot
1- " "	2.75 " "	.125 " " "	.135 " " "
2- " "	2.25 " "	.125 " " "	.145 " " "
3- " "	1.75 " "	.125 " " "	.155 " " "
4- " "	1.25 " "	.125 " " "	.165 " " "

The author had just been made a member of the A. S. M. E. committee on Standard Tests and Methods of Testing Materials, and he agreed to make a series of tests with these sizes of test-bars sufficient to prove the proposition.

Table XVI gives the shrinkage records.

TABLE XVI.

SHRINKAGE OF THE I9 SERIES OF A. S. M. E. TESTS.

Kind of Iron	Average Per cent Silicon.	No. of Series.	Test Bars $\frac{1}{4}$ " □	1" □	2" x 1" □	2" □	3" □	4" □
"Iroquois" with silicon added by Pencost ferro silicon.	0.80	1	.183	.160	.148	.131	.116	.102
	1.21	2	.172	.150	.138	.125	.110	.106
	1.88	3	.166	.145	.130	.109	.069	.035
	2.01	4	.162	.143	.123	.099	.066	.128
	3.19	5	.157	.105	.094	.075	.067	.057
	3.04	6	.169	.130	.086	.077	.085	.033
"Hinkle" and Pencost.	0.93	7	.176	.149	.144	.139	.115	.072
	1.17	8	.160	.145	.126	.122	.093	.092
	1.67	9	.156	.141	.134	.128	.083	.036
	2.23	10	.154	.124	.092	.094	.075	.067
	2.71	11	.157	.102	.090	.062	.053	.023
	3.50	12	.144	.098	.092	.068	.043	.023
Mich. Stove Co.....	2.82	14	.148	.098	.083	.072	.063	.035
Do.	3.18	13	.130	.095	.091	.079	.072	.052
Do.	3.50	15	.123	.094	.096	.091	.078	.032
Car-wheel iron.....	0.77	19	.238	.153	.142	.144	.126	.115
Light machinery....	1.76	16	.171	.151	.143	.129	.100	.069
Heavy machinery...	2.06	18	.161	.139	.120	.091	.067	.042
Air furnace for mal-leable	0.89	17	.248	.247	.221	.201	.157	.144

SHRINKAGE OF SERIES D AND E OF A. F. A. TESTS.

Series.	Shrinkage Dry Sand Bars.	Per cent Silicon.	Test Bars $\frac{1}{4}$ " □	1" □	1 $\frac{1}{2}$ " □	2" □	2 $\frac{1}{2}$ " □	3" □	3 $\frac{1}{2}$ " □	4" □
D	Dry sand	.085	.280	.270	.220	.160	.140	.140	.130	.110
E	Dry sand	0.72	.230	.180	.170	.160	.150	.140	.130	.110

Shrinkage decreases as silicon increases. Looking at any vertical column, in Table XVI, the greatest shrinkage accom-

panies the least silicon, and *vice versa*. In the year 1885 the author discovered *that the variation of shrinkage indicated the variation in the influence of silicon*, in the presence of all other elements in the iron, and under all local conditions attending melting; and in 1887 the editor of the *Journal of the United States Association of Charcoal-iron Workers* suggested the name of "Keep's Test" for this mechanical analysis of cast iron.

The founder must be made to realize that it is not the *percentage* of what is in his iron that is of use to him, but that it is the *influence* exerted by that which is in the cast iron that affects the physical quality.

Table XVI shows that *shrinkage decreases as the size of a casting increases* when each is poured from the same iron. Look at any horizontal row of figures. The smallest test-bar has the greatest shrinkage and the largest test-bar has the least shrinkage, because the slower cooling of large bars produces a coarser grain.

For the influence of other elements on shrinkage see the chapters on those elements.

CHAPTER VIII.

KEEP'S COOLING CURVES—A STUDY OF MOLECULAR CHANGES IN METALS DUE TO VARYING TEMPERATURE.

Autographic Record of Shrinkage.—Fig. 101 is a cut of the machine by which the records in this investigation were made. A mold was made of a test-bar 1 in. \square by 26 ins. long. In the front of the flask, near the ends of this mold, recesses were cut to allow the ends of the mold to be reached. The top of each end of the mold was covered with a piece of tin having a $\frac{1}{4}$ -in. round hole through it, the two holes being $24\frac{1}{2}$ ins. apart. The autographic machine was attached to the mold in each recess by a $\frac{1}{2}$ -in. round pin which projected upwards to form a bearing for the arms which were to transmit the motion of the test-bar. The inner end of each arm was 2 ins. long, and the outer end was 20 ins. long. Through the inner end of the arms was a $\frac{1}{4}$ -in. hole corresponding with the hole in the tin cover of the mold. Through each of these was passed a $\frac{1}{4}$ -in. steel pin. The inner end of this pin projected downwards through the mold. This pin was located at the front edge of the mold, so that the first skin formed embraced it. The outer ends of the arms multiplied any motion of the ends of test-bar ten times. The right-hand arm moved a slide which carried a recording-pencil, and the left-hand arm moved a slide upon which was located a cylinder which contained the ruled record paper, and also carried a clock which allowed the cylinder to turn once each hour. The paper was ruled in 1-in. squares, each divided into twentieths. The cylinder had a circumference of 12 ins., which made each inch measured cir-

cumferentially on drum equal to five minutes of time. As one arm moved the pencil and the other moved the slide which carried the cylinder and clock in an opposite direction, the record was the sum of the motions of the two ends of the test-bar, and as this was 2 ft. long, to find the motion of the test-bar per foot of length the record must be divided by 20. If the record shows a motion of the pencil to be half an inch, or ten of the small divisions, the motion of each end of the bar would be $\frac{1}{2}$ of one division, or $\frac{25}{1000}$.

The frame of the machine was of wood, to prevent expansion, and the apparatus with the test-bar was entirely self-contained.

Shrinkage Curves.—Since metals expand as they receive heat, and shrink in proportion as they lose heat, the record of such simple shrinkage should be a curve showing these proportions. Fig. 23 shows such curves from the most common metals. A shrinkage takes place while the metal is still fluid which causes the metal in the gate to sink, yet the pins in the end of the test-bar will not move until the casting is solid, and such shrinkage in the fluid metal cannot alter the size of the casting. The curves show the length of time it took each metal to become solid. Block tin remained fluid 11 minutes, while lead was fluid only $2\frac{1}{2}$ minutes. As soon as the 1-in. \square bar becomes solid the shrinkage of the test-bar begins.

Yokes for Chilling and Fixing the Length of Test-bars.—Holes to receive the pins of the machine were drilled in each end of a yoke, and a test-bar 1 in. \square was cast, its ends running against the ends of the yoke. Curve *ab* on Fig. 23 shows the motion of the ends of the yoke. The bar connecting the ends of the yoke is 1 in. \square , or the same size as the test-bar, and there is 1 in. of sand between them, but the diagram shows that the yoke expanded at once when the iron filled the mold. Curve No. 2 is from a 1-in. \square test-bar, cast with its ends against the yoke, the pins in this case being in the test-bar. The ends of the test-bar did not move for one minute, so that the chilling against the yoke ends was instantaneous, for the yoke expanded away from the bar at once, and never came in contact with it

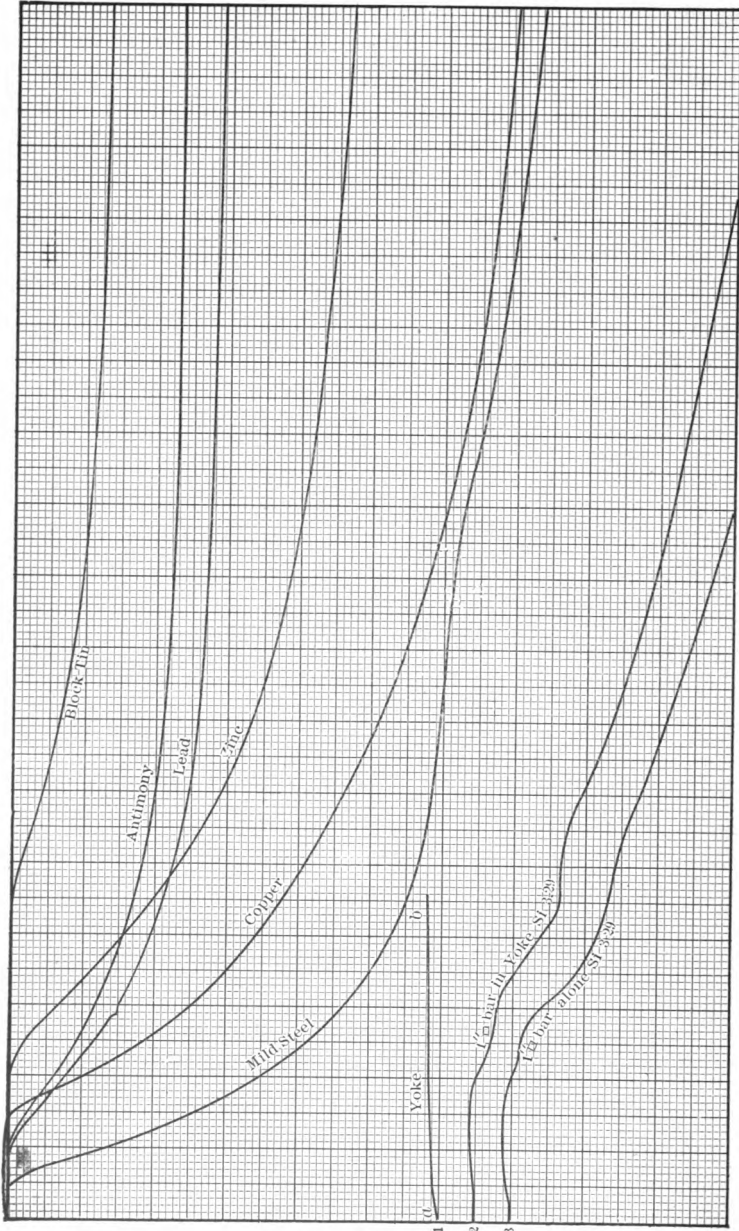

FIG. 23.

again. Curve No. 3 is from the same iron mixture, from a bar cast in sand without a yoke. The curves show the variation in No. 2 on account of the cooling action of the yoke. All of the test-bars, made for the A. S. M. E. Committee on Methods of Testing, were made in yokes, and all bars were shaken out of the molds at once. In all the bars larger than 1 in. \square the expansion of a yoke would be much greater than for a bar 1 in. \square , for the reason that the bar connecting the heads of the yoke was always 1 in. \square and 1 in. from the test-bar, and the larger test-bars would, therefore, heat it more quickly and to a greater extent. The $\frac{1}{2}$ -in. test-bars were cast in a yoke with a $\frac{1}{2}$ -in. \square bar connecting the yoke-heads, but in each case the $\frac{1}{2}$ -in. test-bar shrinks away at once (see Curve No. 18, Fig. 26), and could never touch the yoke after the instant that mold was filled.

Curves from Cast Iron.—These vary in shape with change in chemical and physical composition. Iron with silicon quite high makes the most attractive curve, and Curve No. 11, Fig. 24, is therefore taken as an example. The silicon was 3.85%,

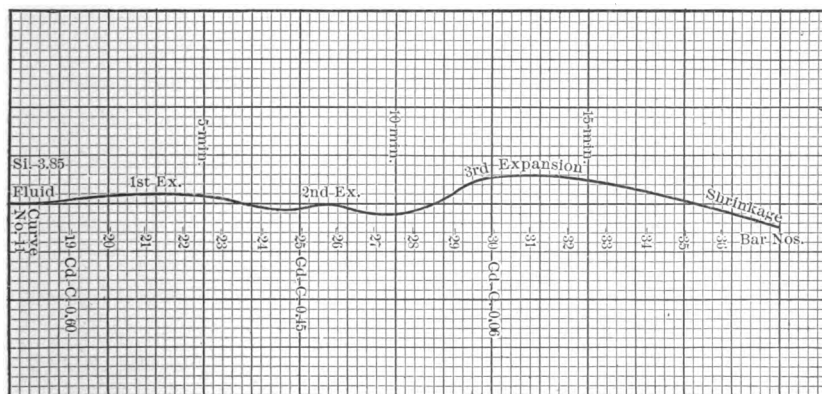

FIG. 24.

P 1.00, S 0.10, Mn 0.50. The carbon is about 3.10, which is low. This is a mixture which gives excellent results for thin castings which are very strong and soft. The lower the carbon the higher must be the silicon to produce soft castings. The

curve shows that the casting remained fluid for 1 minute, during which time the ends of the bar remained stationary. When the whole of the test-bar had become solid it expanded for 16 minutes. The expansion began $1\frac{1}{2}$ minutes after the mold was filled, increased until $3\frac{1}{2}$ minutes, then decreased until 7 minutes. This is named the *1st Expansion*. The expansion then increased until 8 minutes, and decreased again until 10 minutes. This is called the *2d Expansion*. A very great expansion then takes place, reaching its maximum between $12\frac{1}{2}$ and 14 minutes, and decreasing until 16 minutes, or a little later. This is the *3d Expansion*. When these expansions are completed the regular shrinkage curve from the loss of heat is formed, the same as in the simple metals.

This shrinkage had been acting from the beginning, for the metal had been parting with its heat all the time, but the expansions were great enough to overcome all this shrinkage during the first 16 minutes. Another proof of this is that the shrinkage curve of all 1-in. \square cast-iron bars takes substantially the same direction after the 3d Expansion is completed. This is beautifully shown in Curve No. 35 of Fig. 28, where the dotted line shows the location of the shrinkage curve if no expansion had occurred.

Solidifying of Cast Iron.—To get an explanation of Curve No. 11, eighteen test-bars 1 in. \square and 1 ft. long were poured at the same time as the 2-ft. test-bar from which the diagram was taken. As the bars were made in a snap flask, there was nothing around the bar but sand. The first bar was numbered 19. At the end of 1 minute the iron in the gate was still fluid. At $1\frac{1}{2}$ minutes the sand was cut away and the bar taken out, but it broke by its own weight, though it *was not fluid*. One-half of this bar was dropped into a barrel of ice-water and the other half was allowed to cool in the air. At the end of each minute thereafter the sand was cut away from a bar, which was broken, and half of it dropped into the ice-water. From the fact that the cooling of a 1-in. \square bar in water cannot be instantaneous, and that anything short of that would allow a change in crystalliza-

tion, the quenched bars give only a faint idea of the condition of the iron at the time it was taken from the mold.

Each bar was a little stronger than the preceding one, and as soon as it could not be broken with a pair of pincers alone, one-half of the bar was placed in a hole in a heavy block of iron, when a wrench of the pincers would break it. Then a light blow of a hammer, and toward the end quite a sharp blow from a 5-lb. hammer was needed.

Curve No. 11, Fig. 24, was then divided according to the times of breaking the 18 bars, to see which belonged to the different parts of the curve. Previous to making the bars described, and while Curve No. 13 (Fig. 25) was being made, a similar number of bars numbered from 1 to 18 had been cast, cooled, and broken.

Hard or Soft Cast Iron.—An examination of the fracture of these two series of quenched bars shows a great change in the crystalline structure before and after the 3d Expansion, but these fractures do not at all show what the iron really was, because quenching cannot entirely prevent the crystals assuming their natural form. The whole change from melted iron to a soft gray crystalline casting, shown by Curve No. 11, can take place in a thin casting in less than a minute (see Curve No. 17, Fig. 26). If a non-chilling iron, like that from which the Curve No. 11 is made, is poured against a chill, only a very thin portion will be chilled, and behind this, toward the molten mass, will be formed a dense black soft grain, probably at the same instant with the chilled portion. This instantaneous passage of cast iron through all of the stages of crystallization, from fluidity through the 3d Expansion, makes it impossible to fix the iron at any instant. To get an approximate idea of the state of the iron, the bars numbered 19, 25, and 30 were selected for analysis; No. 19 before the iron was solid, No. 25 during the 2d Expansion, and No. 30 just as the 3d Expansion had reached its maximum. The combined carbon in bar No. 19 was 0.60, in bar No. 25, 0.45, and in bar No. 30 it was 0.06. From the location of the

curves, bars 26, 27, and 28 were probably as hard and contained as much combined carbon as No. 25. As bar No. 28 probably contained 0.40 combined carbon, and as bar No. 30 contained only 0.06 combined carbon, which is the same percentage as was contained by the portion of the bars which were allowed to cool in the air, it appears that the change of combined carbon into graphite takes place in less than 1 minute in a casting 1 in. \square cooled in its own mold, and that this is the time when hard iron changes to soft iron. After the 3d Expansion no further change in the crystalline structure took place, and the shrinkage curve was that ordinarily made by the loss of heat. The bars Nos. 19 and 25 were so hard that they could not be touched with a drill, and it was very difficult to break off enough for analysis. It would seem that the bars were much harder than could be accounted for by the 0.60% of combined carbon, while bar No. 30 was very soft. The final arrangement of crystals took place during the 3d Expansion, and at that time the iron became soft. Calling an iron by the number of its curve, No. 11 was intensely hard for the first 10 minutes and became soft during the 3d Expansion. In Nos. 12 and 13 the 3d Expansion was almost lacking and the iron was left in its hard state. The facts were that the castings made from the mixture of No. 11 were all soft, while those made from Nos. 12 and 13 were difficult to drill. Much depends upon the character of the original irons. No. 10 would almost scratch glass, but Nos. 6, 7, 8, and 9, made from pig iron only, and melted in a crucible, though the 3d Expansion is not great, were soft. An investigation may show that the 1st Expansion, being so large, had a softening influence, or that the entire absence of the 2d Expansion may account for it.

Silicon is a Softener and a Lessener of Shrinkage.—Curve No. 4, Fig. 25, shows an immense 3d Expansion, and the iron is so soft and open as to be very weak, and the silicon is 3.49%. Curve No. 5 is one of iron containing 3.10% of silicon. The 3d Expansion is not as great, and the iron is not quite as soft, as in No. 4. Each lessening of silicon lessens the 3d Expansion,

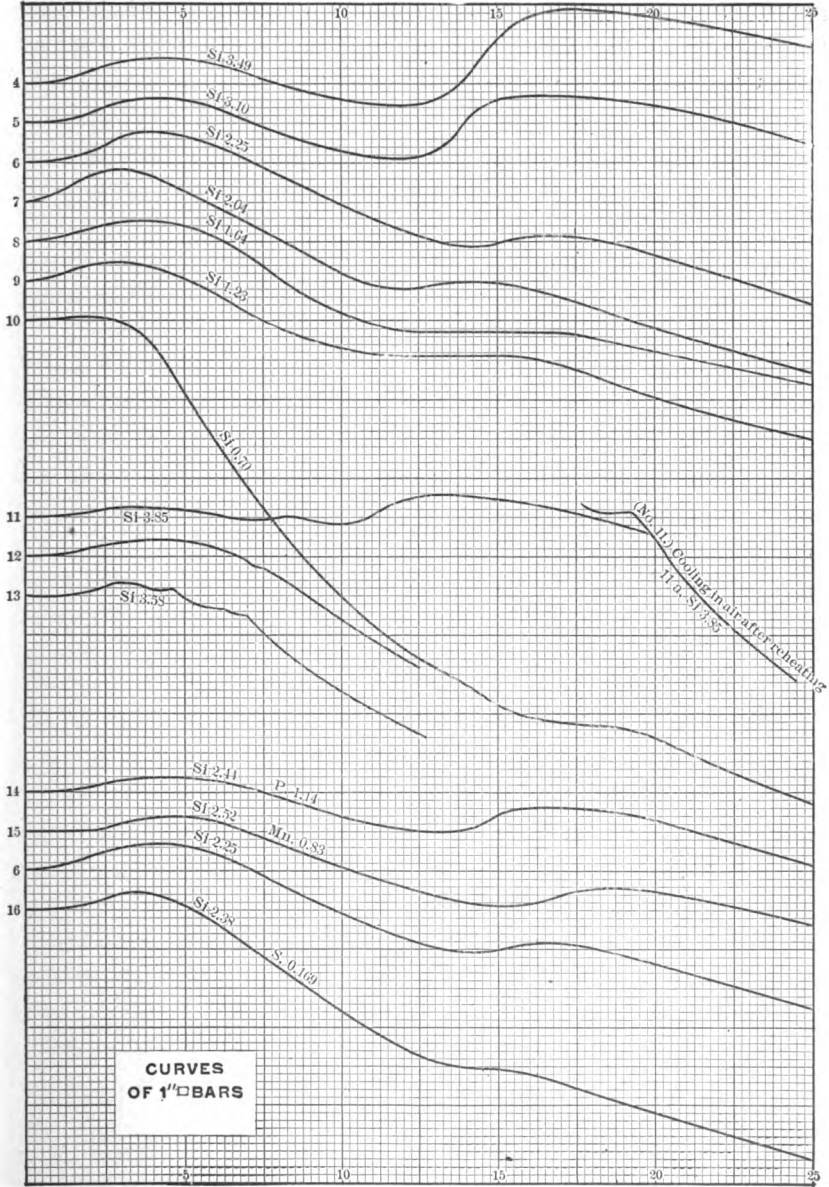

FIG. 25.

and the iron is harder each time. The silicon of No. 11 is higher than that of No. 4, being 3.85%, but No. 11 is from a regular cupola mixture of close-grained low-carbon irons, and 40% of the mixture is the sprues made the previous day, and the latter have been melted over each day. In irons producing curves Nos. 4 to 9, and 14, 15, and 16, the total carbon was nearly 4.00, and all are open-grain pig iron, and melted without scrap in a crucible. In Nos. 11, 12, and 13 the carbon was about 3.10%, phosphorus was 1.00%, and sulphur 0.10%, while in the crucible irons Nos. 4 to 9 P was only 0.20 and S 0.04.

In the practical application of cooling curves to foundry work the mold can be made in 20 minutes, and as soon as the iron is running the bar can be poured. It takes 15 minutes to find the 3d Expansion. It is at once apparent whether the mixture needs more or less silicon, and the charges of iron can be changed at once if necessary.

Phosphorus, Sulphur, and Manganese in Cast Iron.—In Curve No. 14 (Fig. 25) phosphorus is 1.14% and the silicon is 2.44%. The 1st Expansion continued longer than in Curve No. 6, the 3d Expansion was greater, and the casting, therefore, is softer. The final shrinkage begins higher up or from a greater initial expansion, and the total shrinkage is therefore less than in No. 6. In Curve No. 15 manganese was increased to 0.83%, while the silicon is substantially the same as in No. 6, which was about 2.50. The iron was hotter, and for this reason it remained fluid for 2 minutes. The 1st Expansion was of shorter duration. A 2d Expansion is almost apparent, and the 3d Expansion occurred later, and was greater than in No. 6, therefore the iron was no harder. In Curve No. 16 the sulphur was 0.169%. This has greatly lessened the duration of the 1st Expansion, and has both shortened and reduced the 3d Expansion, and has therefore caused the iron to be harder than that of No. 6.

Size of Casting, and Expansion.—Figs. 24 and 26 show Curves Nos. 17, 18, 11, 19, 20, 21, and 22, from test-bars $\frac{1}{8}$ " \times 1", $\frac{1}{2}$ " \square , 1" \square , 1" \times 2", 2" \square , 3" \square , and 4" \square , which are

the sizes that were made for the Committee's strength tests. In No. 17 the casting became solid in 20 seconds, with a very slight 1st Expansion, and the 3d Expansion probably occurred in $1\frac{1}{4}$ minutes. In No. 18 the 1st Expansion began as soon as the bar was poured, and the curve shows the 2d and 3d Expansions. In No. 19 the thickness of the bar was the same as in No. 11, but the width was twice as great, and the ratio of cooling was slower, and therefore all three expansions are retarded. In Nos. 20 and 21 the size of the bar was so great that it was not congealed in the center for some time after pouring, and the early beginning of the 1st Expansion must have been on account of the pins of the test-bar being located on the edge of the mold. As soon as the shell became rigid enough it expanded, the same as any solid casting, and the slowness of cooling prolonged the period of each expansion. The rate of cooling causes the location of the expansion curves to be formed either earlier or later.

Effect of Hot or Dull Iron on Shrinkage.—Fig. 27 gives four examples of hot- and cold-poured test-bars. The apparatus was arranged to make two curves at one time, and the test-bars were half as long as those already examined. The enlargement of the diagrams showing shrinkage in this chart is therefore only ten times, but the time measure is the same as before.

In each of the four examples presented, iron was caught in a ladle and emptied out several times in succession so as to heat it very hot, and then 35 lbs. of iron was caught and a bar 1 ft. long and 1 in. \square was poured immediately. The ladle was then allowed to stand until a shell had formed on the top of the remaining iron. A hole was broken through this shell, and the iron under it poured into another test-bar of the same size. This iron was as dull as would fill the mold, and to insure a full test-bar the gates had been cut nearly as large as the mould for the bar. The iron put into the first mold was white-hot and flowed like water. The last was red and sluggish. The hot bar, No. 26, became solid in a little more than a minute, when the

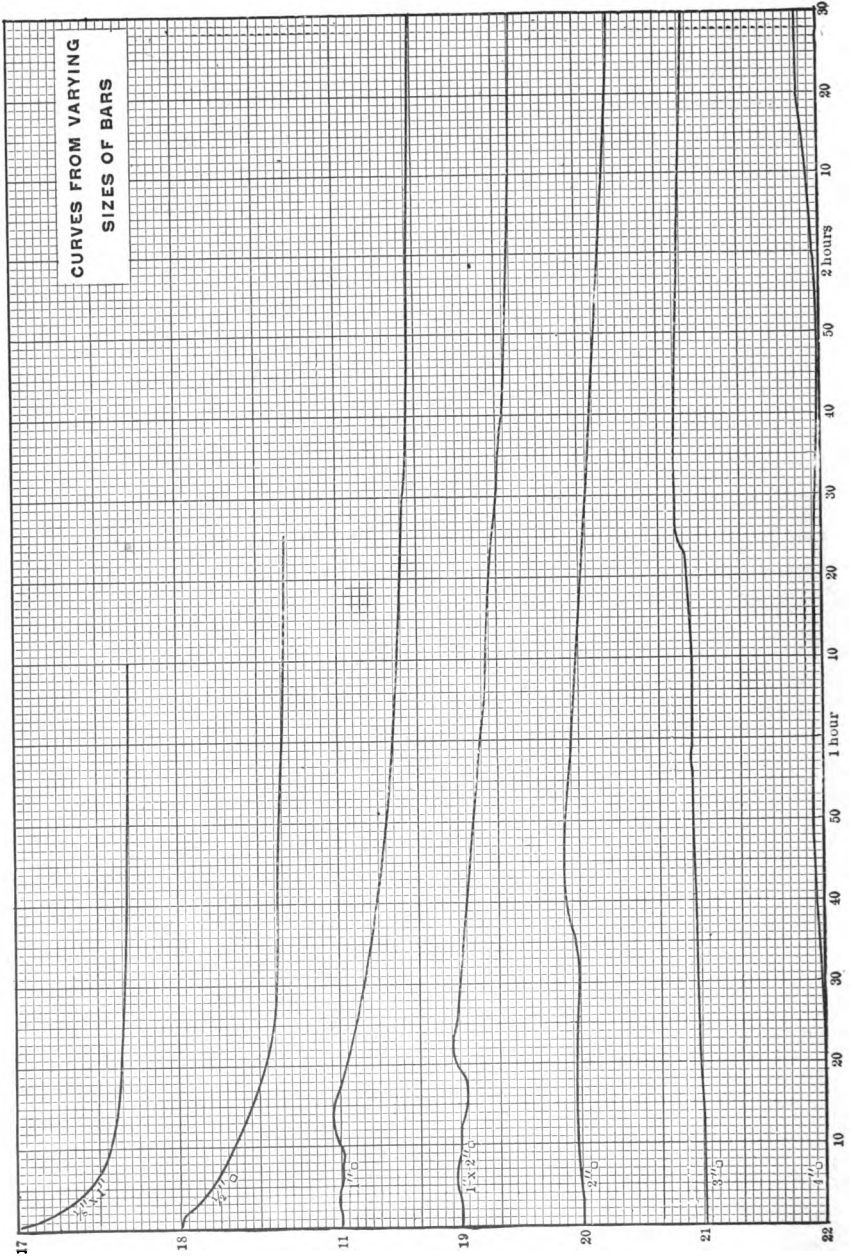

FIG. 26.

expansion began. The 2d Expansion had begun when the dull bar was poured, yet the dull bar went through the expansions so much more rapidly that the temperature that produced the 3d Expansion was reached in both the hot- and dull-poured bars at nearly the same time. The final shrinkage of the two did not vary much, though the hot bars shrank a little the most. The dull-poured bar went through the changes more rapidly, because it entered a cold mold, and was nearer the temperature at which the 3d Expansion would occur, to begin with.

Temperatures at which the Three Expansions Take Place.

The diagrams show that each expansion occurs at a definite temperature. In Fig. 27 the hot-poured bars had a greater amount of heat to impart to the mold than the cold-poured bars,

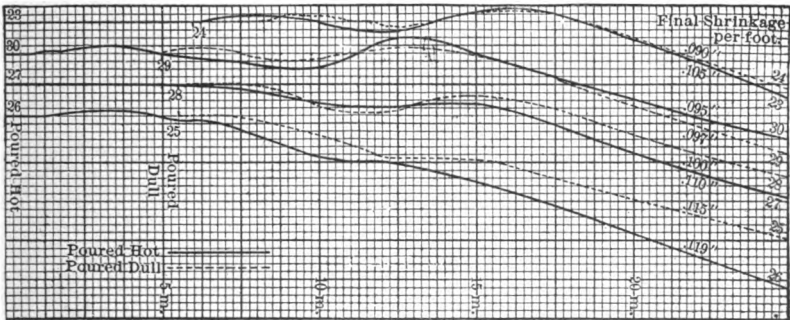

FIG. 27.

and the temperatures necessary for the formation of the curves were reached after a longer interval of time. The No. 10 bar in Fig. 25 was poured very hot, and the 3d Expansion occurs after a greater interval of time. Nos. 7 and 9 were dull, and the 3d Expansion occurs earlier than in the others.

If the rate of cooling is slower it will take a longer time to reach the temperature at which each expansion takes place. For example, in No. 11, Fig. 26, the 3d Expansion took place in 12 minutes; in No. 19 it was 20 minutes; in No. 20 it was 40 minutes; in No. 21 it was 85 minutes; and in No. 22 it was 140

minutes, which corresponds with the rates of cooling. It is important to prove that each expansion occurs at a definite temperature, and it would be a great satisfaction to know the exact degree of heat. The cast-iron test-bar, as shown by the 18 bars that were broken, was at quite a red heat at the 3d Expansion. It may be found that a change in chemical composition may hasten or retard the formation of the curves, irrespective of temperature. For example, in the curves of iron and steel, Fig. 28, the bars had just a reddish tinge in the sunlight, while the expansion was taking place, and were a dull red, if shaded; and this curve must correspond with the 3d Expansion in cast iron, which takes place at a bright-red heat.

When does Carbon Combine when Heated towards Fusion?

The cast-iron test-bar from which Curve No. 11 was taken was heated as much as it was thought it would stand without breaking, and was placed at a bright-red heat on the pins of the machine. The result was a curve, 11*a*, Fig. 25. As this bar was cooled in the open air the change was very rapid, and the proportions of the diagram are different from the original. The diagram begins just before the 3d Expansion. This shows that the crystalline structure which produced the 3d Expansion had been changed, during the latter part of the heating, to the structure which preceded the 3d Expansion. At that time most of the carbon was combined, and the iron was extremely hard. This experiment shows that in melting graphitic cast iron the graphite changes to combined carbon when the temperature of the 3d Expansion is reached, instead of at the temperature of fusion. Unlike white cast iron, the iron is in an expanded state from the 3d Expansion to the point of fusion; i.e., the atoms are not as close together. In white iron, with the carbon combined in the cold casting, there is no change in the crystalline structure during the heating, and the iron does not reach the expansion which causes it to fuse until just before fusion. Gray cast iron reaches its greatest expansion much sooner than white iron, with the result that it melts from the outside of the casting,

and does not become plastic to the extent that white cast iron does.

The bar which produced Curve No. 11 was again heated, to determine if a lower point on the curve could be reached, but it fell apart in handling. Practically, the 3d Expansion is all that can be reached by reheating. It was found that the bar was too long to go in the machine after the second reheating, showing that two heatings above the 3d Expansion had increased the size of the crystals the same as ordinary annealing. The temperature for annealing should, therefore, be that of the 3d Expansion.

To illustrate the expanded condition of cast iron of the quality of No. 11, two of the gates from the 18 bars that were broken were cleaned, and one of them was polished. Two ladles of melted iron from the same heat were placed on the floor; one of the 14-ounce gates was placed in each. They were plunged into the fluid metal at first to cause the melted iron to come in contact with the surface. Both gates (about 1 in. round \times 4 ins. long) lay on top of the melted metal until they were melted, about one-fourth being above the surface. This took 2 minutes. The fact that gray cast iron just before fusion is more expanded than when cold or when fluid explains the phenomenon of the floating of gray iron on the surface of fluid iron while it is melting. Drop a piece of cold iron into molten iron. At first it sinks, then rises and floats with about one-half its bulk above the surface until it is all melted.

This seems to the author the first correct explanation for this phenomenon.

Curves from Heated Rolled Steel (Fig. 28).—The first bar treated was a bar of merchant iron 1 in. \square by 26 ins. long, with the holes for the pins $23\frac{3}{4}$ ins. apart. The expansion was so great that when white-hot it was $24\frac{1}{4}$ ins. long. As these bars were cooled in the open air the shrinkage was very rapid. The curve of No. 31 changed slightly after 1 minute, but it would need other tests to show whether the metal became at all crystalline. The next tested was a bar 1 in. \square of Jessops tool-steel, Curve

No. 32. This was then heated again, to see if it would become more coarsely crystalline, Curve No. 33. The expansion (which is the 3d) at the first heating was blended into the curve of shrinkage, and was of shorter duration than that of the second heating, showing that it became more coarsely crystalline by reheating past the 3d Expansion. This was on account of its

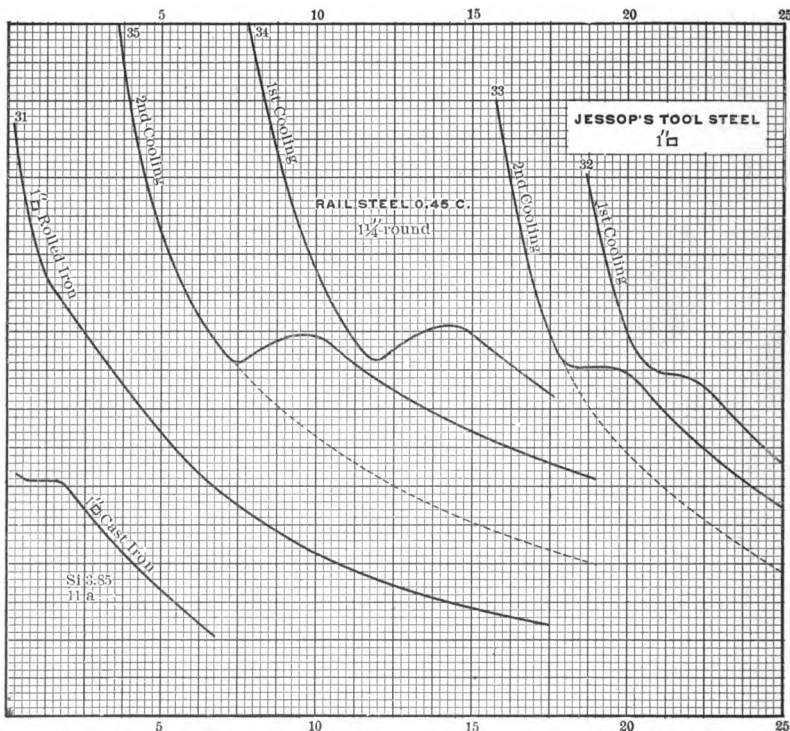

FIG. 28.

high carbon. (The pins of the machine, which were of Stubbs steel, became enlarged by repeated heatings.) The next tested was a bar of $1\frac{1}{4}$ -in. \circ mild steel, with carbon 0.45%, which was expected to behave more like No. 31. The expansion curve, 34, was so great, however, that while the 2-ft. bar was shrinking at the rate of $\frac{1.85}{1000}$ in. in 4 minutes, the 3d Expansion overcame this shrinkage and carried the pencil backwards $\frac{1.0}{1000}$ of an inch.

The second heating gave Curve No. 35. These curves show that the shrinkage is going on at the same time with the expansion, for the direction of the shrinkage curve after the expansion is the same as it would have been if no expansion had taken place, as shown in each case by the dotted line. The total shrinkage of any iron or steel is therefore decreased by the amount of the expansion.

At the second heating of the 0.45 C. steel, when the expansion began, the color in sunlight was dark, with a faint red tinge; by shading it from the light the side of the bar away from the light was red. When the expansion was over, the bar on the side away from the light was a dull red. The foreman said that if the steel was red-short it would break if forged at such a color as existed during the expansion. This remark, and the difference between the expansions of Jessops high-carbon steel and the 0.45% carbon mild steel, suggest the possibility of determining this property in such metal by the use of these expansion curves.

In the practical application of these cooling curves any bar of iron can have two $\frac{1}{4}$ -in. holes drilled, $23\frac{1}{2}$ ins. apart, in 10 minutes; it can be heated in 10 minutes, and the record is made in 5 minutes.

Relation of these Expansions to the Critical Points of Iron and Steel.—This cannot be ascertained until the temperature at which each expansion takes place is determined. If these expansions should occur at the temperatures 850° , 750° , and 650° C., which correspond to the critical points Ar. 3, Ar. 2, and Ar. 1, these expansions are caused by a change in the length of the test-bar; in other words, it is purely a physical change and not at all *caused* by any increase in temperature. If the expansion was caused by a rise in temperature, then, in diagram No. 11, during the 3d Expansion the temperature must have been higher than when the iron was melted, which idea is absurd.

The expansion curves are caused by a rearrangement of crystals, and is purely a physical process.

CHAPTER IX.

PHOSPHORUS IN CAST IRON.

PHOSPHORUS is reduced from phosphoric acid, which is found in all fuel and in iron ores. Phosphorus is produced in two forms, the ordinary white variety, with specific gravity 1.82, and red phosphorus, with a specific gravity of 2.14. The latter is produced by heating the first variety, and will unite with pure iron to form iron phosphide. The author could not make ordinary white stick phosphorus exert any influence when introduced into cast iron (Method 7). By melting wrought-iron drillings with red phosphorus Mr. H. S. Fleming produced in his laboratory 10 lbs. of phosphide of iron which contained 10.22% of phosphorus.

Metallic phosphorus is said to have a specific gravity of 2.34. If Truran's opinion is correct, the bulk of phosphorus being greater than carbon should make iron more fusible. Ten per cent iron phosphide melts as easily as cast iron. Very small percentages of phosphorus alloyed with commercially pure iron are said to make it brittle when cold, but not when hot, and for this reason such brittleness is called cold-shortness. This term cannot be correctly applied to cast iron. As iron has an affinity for phosphorus, it is found in all cast iron.

In the Journal of the Iron and Steel Institute, No. 1, for 1886, Professor Turner says: "What is badly wanted at the present moment is a series of experiments in which various proportions of phosphorus should be added to a specimen of cast iron in which all other constituents should be kept as nearly as possible constant."

With the 10.22% phosphide were made two series of test-bars. The first with Gaylord white iron, Table XIX and Fig. 31, and the second with F^LM gray iron, Table XXII and Fig. 34 (Method II).

376	377	378	379	380	381
G. C. 1.62	G. C. 2.14	G. C. 1.53	G. C. 1.83	G. C. 1.57	G. C. 1.44
C. C. 1.51	C. C. .83	C. C. 1.59	C. C. 1.59	C. C. —	C. C. 1.08
Si. .25	Si. .23	Si. .20	Si. .20	Si. .15	Si. .12
P. .26	P. .26	P. .26	P. .26	P. .26	P. .26

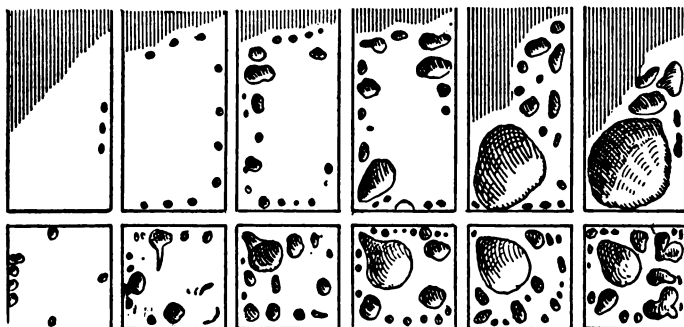

FIG. 29.—White Iron (Remelts). Runners remelted with new iron. Carbons in all, and Si. in 376 and 381, and P. of 376 from actual analysis. Other percentages are estimated.

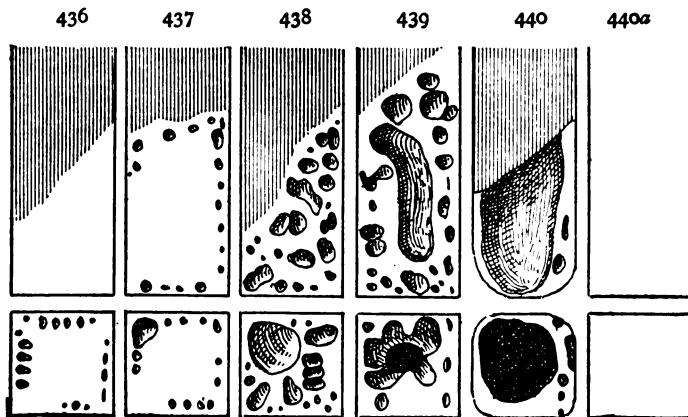

FIG. 30.—Steel Wire added to White Iron, remelted as in Fig. 29, and all elements diluted as in Fig. 31. Analysis of 436 same as 376. To 440 was added one per cent of aluminum, which made 440a, a solid casting.

TABLE XVII.

WHITE IRON REMELTED.

Test No.	Mixture.	Phos. Added.	Strength.		Dead Load Def.	Shrinkage.		Chill.
			Dead Load.	Impact.		$\frac{1}{2}$ sq. in.	$1 \times \frac{1}{16}$ in.	
376	White iron alone.	none	379	237	.14	248	246	all white.
377	"	"	334	178	.13	253	
378	"	"	201	101	.09	250	242	
379	"	"	199	101	.09	243	238	
380	"	"	179	85	.08	241	235	
381	"	"	175	68	.08	240	

TABLE XVIII.

WHITE IRON + STEEL WIRE.

Test No.	Mixture.	Phos. Added.	Strength.		Dead Load Def.	Shrinkage.		Chill.
			Dead Load.	Impact.		$\frac{1}{2}$ sq. in.	$1 \times \frac{1}{16}$ in.	
436	White iron and wire.	none	382	280	.13	.250	all white.
437	"	"	262	119	.10	.250	.237	
438	"	"	198	101	.10	.246	.236	
439	"	"	201	119	.09	.239	
440	"	"	*	*	*	.232	
538	"	"	†	†	†	†	†	

* Very sluggish.

† Would not run at all.

TABLE XIX.

WHITE IRON + PHOSPHORUS.

Test No.	Mixture.	Phos. Added.	Strength.		Dead Load Def.	Shrinkage.		Chill.
			Dead Load.	Impact.		$\frac{1}{2}$ sq. in.	$1 \times \frac{1}{16}$ in.	
412	White iron & phos. of ir.	0.03	344	196	.11	.252	all white.
413	"	0.05	200	94	.08	.236	.225	
414	"	0.10	214	122	.09	.221	.207	
415	"	1.50	237	85	.09	.206	.200	
416	"	2.00	136	68	.06	.197	
416 $\frac{1}{2}$	"	2.50	120	51	.06	.193	

TABLE XX.

F^LM REMELTED.

Test No.	Mixture.	Phos. Added.	Strength.		Dead Load Def.	Shrinkage.		Chill.
			Dead Load.	Impact.		↓ sq. in.	1 × $\frac{1}{16}$ in.	
382	F ^L M alone.	none	404	220	.20	.176	.243	1.00
383	"	"	400	230	.20	.180	.238	1.00
384	"	"	405	239	.25	.179	.229	0.90
385	"	"	399	365	.22	.183	.244	1.25
386	"	"	420	331	.22	.186	.248	1.75
387	"	"	479	340	.23	.208	.250	white

TABLE XXI.

F^LM + STEEL WIRE.

Test No.	Mixture.	Phos. Added.	Strength.		Dead Load Def.	Shrinkage.		Chill.
			Dead Load.	Impact.		↓ sq. in.	1 × $\frac{1}{16}$ in.	
441	F ^L M and wire.	none	362	339	.27	.168	.186	.40
442	"	"	409	404	.23	.175	.216	.70
443	"	"	444	272	.19	.203	.225	2.00
444	"	"	493	330	.15	.239	.258	white
445	"	"	533	437	.16	.258	.264	"
446	"	"	549	526	.17	.258	.263	"

TABLE XXII.

GRAY F^LM + PHOSPHORUS.

Test No.	Mixture.	Phos. Added.	Strength.		Dead Load Def.	Shrinkage.		Chill.
			Dead Load.	Impact.		↓ sq. in.	1 × $\frac{1}{16}$ in.	
417	F ^L M + phos. of iron.	0.08	409	491	.29	.174	.187	.25
418	"	0.50	461	458	.25	.166	.184	.55
419	"	1.00	382	280	.15	.168	.187	.85
420	"	1.50	384	220	.14	.178	.191	.90
421	"	2.00	276	137	.09	.192	.190	white
422	"	2.50	223	101	.08	.192	.186	"

CAST IRON.

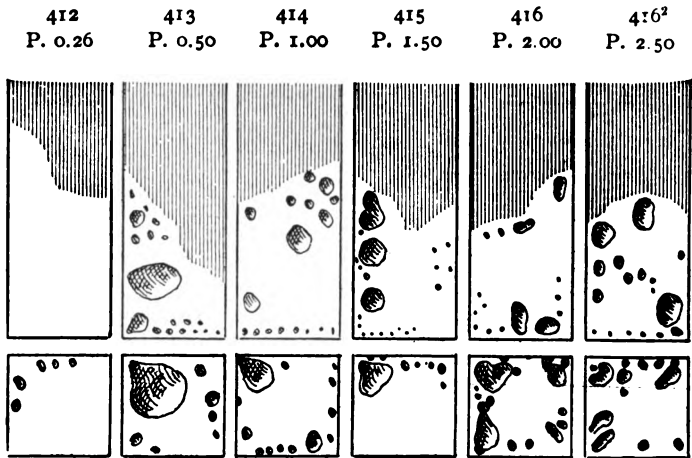

FIG. 31.—10.2% Iron Phosphide was added to White Iron, which diluted all elements same as Fig. 30, except P. The analysis of 412 was T. C. 3.00, Si. 0.25, P. 0.26. All other percentages are estimated.

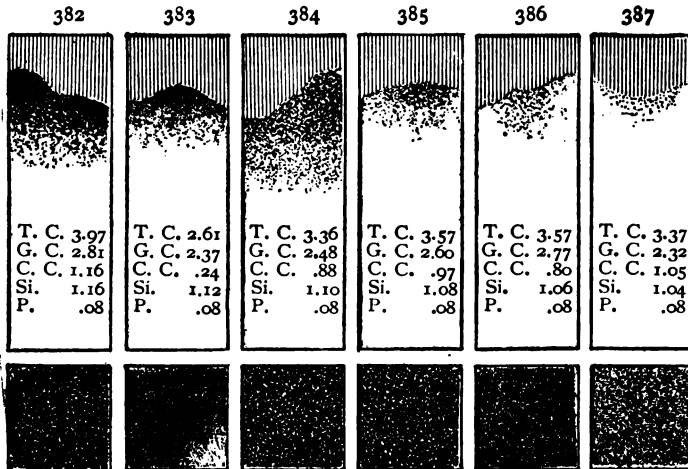

FIG. 32.—FLM Gray Iron (Remelts). Runners returned with new FLM. The carbons of all with Si. and P. of 382 are by actual analysis. All other percentages are estimated.

NOTE.—The shading of the cross-fractures of all figures in this chapter should be carried to the boundary of each square.

The following questions presented themselves: First, what effect would this manipulation of returning sprues to be remelted and the long-continued heat exert on the test-bars? Second, as

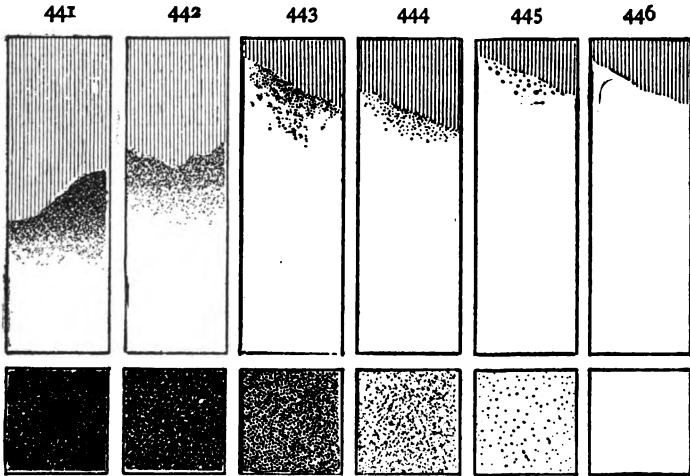

FIG. 33.—Wire added to FLM to dilute all elements as in Fig. 34. The percentages of 441 by analysis were T. C. 3.55, Si. 1.20, P. 0.08. All other elements were diluted as in Fig. 34.

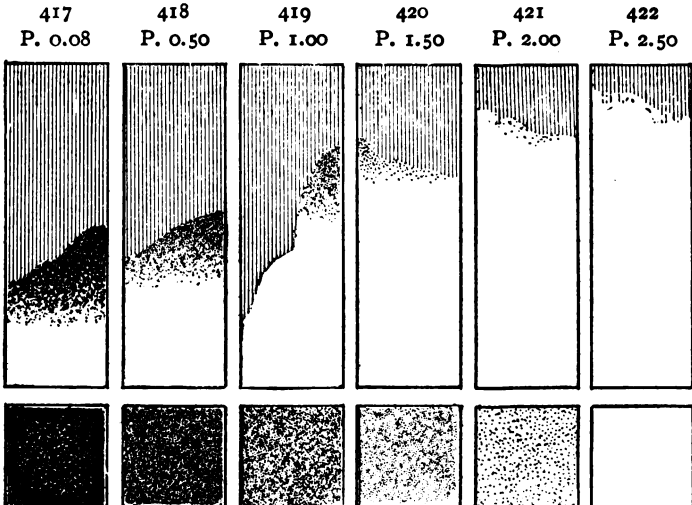

FIG. 34.—10.22% Iron Phosphide was added to FLM, which diluted all elements, same as last, except P. By analysis 417 was T. C. 3.55, Si. 1.30. All others estimated.

the phosphide consists of 90% pure iron, what would be the effect due to the introduction of this iron without the phosphorus ?

To find the influence of the manipulation a series of test-bars was made of the pig iron alone (Method 12), Table XVII, Fig. 29, and Table XX, Fig. 32.

To find the influence of the iron of the phosphide there were made series Table XVIII, Fig. 30, and Table XXI, Fig. 33. Figs. 29 and 32 show that by the remelting of the sprues that were returned silicon was decreased at each cast, and that the increased size of blow-holes was due to this cause.

Figs. 30 and 33 show that the iron additions (from the phosphide) further decreased the silicon, which still farther increased the number and size of blow-holes. While in Figs. 29 and 32 the carbons remained substantially uniform, Figs. 30 and 33, in which wire was added, decreased in both carbon and silicon. In 440 the iron became so sluggish that the author could not carry the series farther.

In the phosphide series, Figs. 31 and 34, which are exactly like the series Figs. 30 and 33 except that the phosphorus contents steadily increase, the blow-holes do not increase and are less in number even than in Figs. 29 and 32. This proves that phosphorus lessens the tendency to form blow-holes, because the iron remains fluid longer.

For a further proof of this some samples of "Durham" white pig iron were received which had been made for the basic steel process. One had P. 3.57 (white), Si. 0.06; another (white)

TABLE XXIII.
WHITE + DURHAM PIG IRON.

Test No.	Mixture.	Calculated % Phos.	Strength.		Dead-load Def.	Shrinkage.		Chill.
			Dead Load.	Impact.		$\frac{1}{4}''$ □	$\frac{1}{16}'' \times \frac{1}{16}''$	
376	White alone.....	0.25	379	237	.14	.248	.246	} All white
484	White + Durham.....	0.50	314	153	.10	.237	.224	
483	Do.	1.50	296	169	.09	.211	.205	
482	Do.	2.50	257	101	.08	.195	.193	
481	Do.	3.50	205	101	.06	.188	.184	
481 $\frac{1}{2}$	Durham alone.....	3.57	17505	.182	.182	

P. 3.52, Si. 0.32. A test-bar was made from the sample with only 0.06 silicon and 3.57 phosphorus and got a perfectly solid casting. Each number of the Durham series, Table XXIII (Method 10), was perfectly solid, but white, and would have made a picture like the one next to 440. If it had not been for the phosphorus, the low silicon of the Durham series would have caused the castings to be very porous.

During the summer of 1888 a man at Moxahala Furnace dug up in an old stock-yard two samples with 4.71% of phosphorus and 3.45% of silicon. About the same time the author procured a 2-lb. sample of gray Hamden charcoal-iron made in 1854. Professor Locke's analysis of this sample from Vol. V. of the Ohio Geol. Report gave: Gr. 1.80, Cd. C. 0.50, P. 4.22, Si. 1.93.

The author procured 1 ton of pig made from Hamden ore (6.90% phosphoric acid) with P. 4.59, Si. 3.16.

From Hamden iron, with F^LM, was made the Hamden series, Table XXIV, Fig. 35 (Method 4).

TABLE XXIV.

FLM + HAMDEN 4.59 P.

Test No.	Mixture.	Phos. Added.	Strength.		Dead-load Def.	Shrinkage.		Chill.
			Dead Load.	Impact.		1/2" □	1" × 1/16"	
479	FLM + Hamden.....	.25	361	441	.32	.154	.155	.07
457	Do.50	372	336	.22	.142	.156	.07
458	Do.	1.00	362	300	.18	.137	.154	.12
459	Do.	1.50	349	271	.17	.137	.150	.15
460	Do.	2.00	347	231	.16	.144	.152	.15
461	Do.	2.50	313	219	.15	.143	.153	
462	Do.	3.00	264	198	.13	.144	.153	.15
463	Do.	3.50	280	169	.13	.145	.155	
464	Do.	4.00	260	130	.11	.147	.161	.15
465	Do.	4.50	212	113	.10	.141	.155	.15
480	Hamden alone.....	4.59	194	101	.10	.142	.163	
467	Moxahala alone.....	4.71	174	101	.09	.146	.156	.15

CAST IRON.

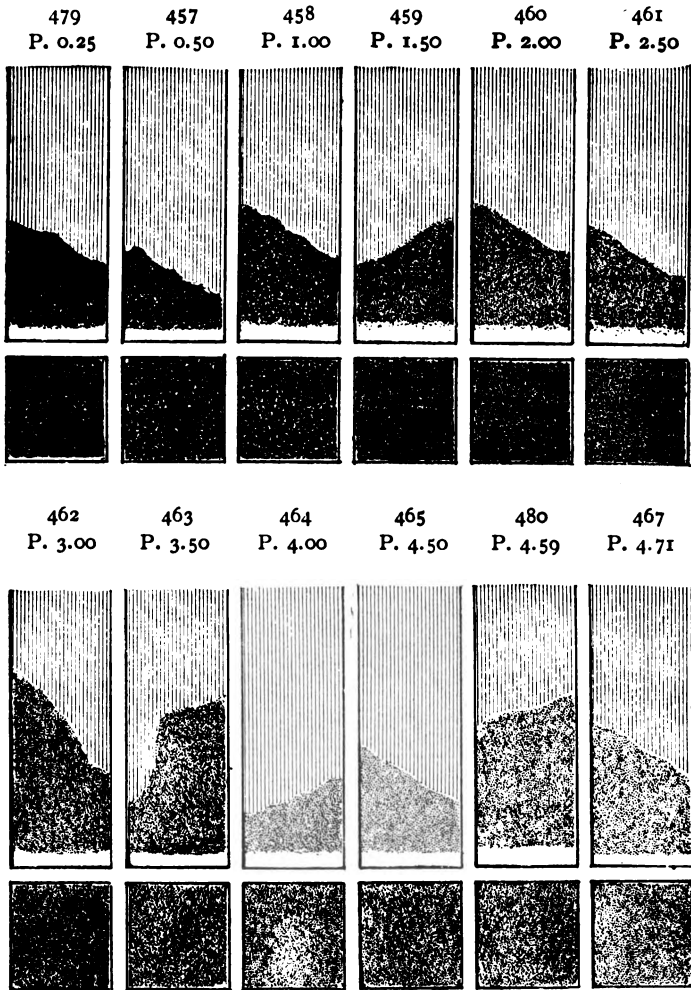

FIG. 35.—FLM and Hamden Series. FLM pig had Si. 1.25, P. 0.08. Hamden pig had Si. 3.16, P. 4.59 per cent. Enough "Pencost" with Si. 11.00 per cent was added to make 3.16 Si. in each. 479 is FLM with Si. 3.16. 480 is Hamden. 467 is Moxahala.

For a more delicate test of phosphorus the author obtained 50 lbs. of "Norway" gray iron with 1.65% of phosphorus (Si. 2.03, S. 0.01, Mn. 0.87, Gr.C. 3.12, Cd.C. 0.63). To dilute the

phosphorus of this iron he used "Stewart" pig iron (P. 0.092, Si. 1.99, S. 0.015, Mn. 0.50) (Method 9).

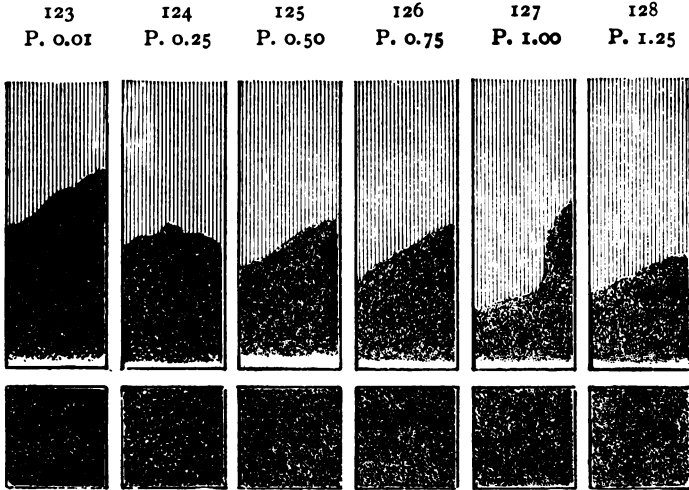

FIG. 36.—Stewart and Norway Series. 123 is Stewart, 118 is Norway.

Of each iron the pig used was the one which was analyzed, and each iron was of nearly the same constitution, except phosphorus, and of this element "Stewart" has less, and Norway more, than would be found in ordinary castings. Therefore a mixture of these irons gives us a series corresponding very nearly with the metal used in ordinary foundry practice.

This series, Figs. 36 and 36a, is free from all objections.

As there are thus five series from which to formulate conclusions regarding the influence of phosphorus in cast iron, and as each series is made on an independent plan, we may place con-

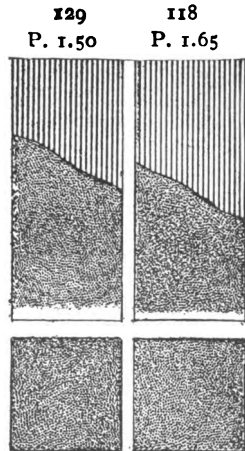

FIG. 36a.

Stewart.—Norway Series continued.

fidence in conclusions based upon them. In any test, consideration is to be given, not to individual variations, but to the general tendency of a whole series.

TABLE XXV.
STEWART + NORWAY PIG IRON.

Test No.	Mixture.	Phos. Added.	Strength.		Dead-load Def.	Shrinkage.		Chill.
			Dead Load.	Impact.		$\frac{1}{4}'' \square$	$1'' \times \frac{1}{16}''$	
123	Stewart alone.....	0.01	385	466	.35	.156	.161	
124	Stewart + Norway....	0.25	392	432	.31	.151	.158	.04
125	Do.	0.50	407	401	.26	.149	.154	.17
126	Do.	0.75	362	262	.18	.152	.158	.10
127	Do.	1.00	388	339	.22	.149	.157	.02
128	Do.	1.25	408	433	.29	.151	.159	.02
129	Do.	1.50	345	246	.17	.153	.159	.20
118	Norway alone.....	1.65	406	356	.21	.153	.158	

TABLE XXVI.
PHOSPHORUS IN THE 19 SERIES OF A. S. M. E.

	Series.	Per Cent of Phosphorus.					
		$\frac{1}{4}'' \square$	$1'' \square$	$1'' \times 2''$	$2'' \square$	$3'' \square$	$4'' \square$
Iroquois.....	1	.211	.213	.214	.215	.216	.216
	2	.273	.269	.270	.271	.272	.270
	3	.270	.267	.268	.267	.266	.267
	4	.284	.283	.281	.280	.283	.281
	5	.333	.331	.330	.327	.325	.329
	6	.300	.299	.296	.298	.297	.299
Hinkle.....	7	.201	.199	.197	.199	.198	.200
	8	.164	.161	.163	.163	.160	.161
	9	.258	.260	.253	.251	.250	.261
	10	.211	.218	.218	.220	.222	.219
	11	.264	.275	.275	.300	.255	.283
	12	.301	.296	.295	.300	.299	.303
Southern.....	14	.809	.801	.795	.800	.804	.797
	13	.826	.828	.830	.817	.830	.825
	15	.980	.975	.972	.972	.971	.973
C. O. Bretting & Co.....	16	.309	.330	.327	.325	.328	.330
Mich. Mall. I. Co.....	17	Average .222 per cent					
Bement, Miles & Co.....	18	" .342 "					
A. Whitney & Sons.....	19	" .352 "					

Table XXVI gives the analysis of phosphorus in each size of test-bar in each mixture that was made for the Testing Committee of the A. S. M. E. (Method 1), and when compared with the tables of physical properties of these same test-bars, especially as compared with the Southern series, it will be seen that 1% of phosphorus does no harm.

Influence of Remelting on Phosphorus.—There is very little change. See analysis of Original Irons on pages 11 and 12, and compare with Table XXVI; also see Table LXIII, p. 136.

The Influence of Phosphorus upon the Grain of Cast Iron.—Phosphorus produces a most peculiar grain, and of such a character that when once observed it is always readily recognized.

The 10.22% phosphide, which is, as nearly as possible, iron and phosphorus, has a flat peculiar fracture, with each grain standing alone, and appearing as though it could be separated easily from those next to it. It is no doubt this peculiarity in the crystallization of iron and phosphorus which causes the weakness of high phosphorus irons. The color is very different from that of the fracture of wrought iron or steel. It is almost white, with a tendency to straw color. If broken when hot, the fracture was beautifully iridescent, shading from brilliant blues to bright gold. In many places there are cavities filled with fine needles of rich colors, the sides of which are brilliantly smooth and straw-colored.

White and straw seem to be the colors imparted by phosphorus. In all further examinations of grain this peculiarity of phosphorus as to color must be remembered. In the Hamden iron the groundwork of the face of the fracture is light-colored, with a very slight yellow tint, and apparently partly imbedded in the surface are what appear to be round grains, either intensely black and shining like minute glass beads, or else reflecting light so as to have such an appearance. The fracture of the gray F^LM iron exhibited a dark spongy grain. The grain of each individual member is such that the grain of a series gradually changed from one of these extremes to the other.

By rubbing the finger across the fracture of the last member of the series, the grains do not cling to each other or to the finger, as in a strong tenacious iron, but to some extent feel as though they were rubbed off.

In an iron deficient in graphite, or containing practically all of its carbon in a combined state, phosphorus has but little effect on the grain.

Iron so deficient in silicon that the carbon is almost wholly combined tends to a lamellar fracture. Judging from the Durham samples of white iron, we are led to think that phosphorus rather increases this tendency.

Incidentally it may be mentioned in this connection that in irons even as low as from 1% to 2% of phosphorus, portions of the surface of castings rapidly cooled are sometimes covered with a brassy yellow tinge. Often the face that runs against the chill is yellowish, or the surface for three-quarters of an inch from the chill will be slightly yellow.

Particularly will a thin casting at the part farthest from the gate show this yellowish color; with irons containing about 2½% of silicon and 1% of phosphorus their castings will shade on the surface from a blue to a golden tinge, which in some cases can be brushed off with the hand.

In color all phosphorus iron is light. Hamden (480) is light, and Moxahala is still lighter, and both have the round, black, bead-like grains. In each phosphorus series the color lightens with each addition of the phosphorus.

Phosphorus and Carbon.—These tests show that the phosphorus exerts no influence to change combined carbon to graphite or *vice versa*. The graphite, if present, must be there through the influence exerted by some other element. The following is a conclusive proof of this: a physical test of No. 1 Star (page 177, Table LXXV) showed almost no chill, it being only 0.01 of an inch, or a mere film.

Mr. J. Blodget Britton found by analysis: "Pure iron 80.480, G.C. 3.405, Si. 4.387, P. 1.470, S. a trace, Cd.C. and

undetermined loss 0.071." He says: "I failed in the attempt to determine the combined carbon. I found that, practically, strictly combined carbon was not present, or at least not in quantity to exert any influence." Phosphorus seems to be a perfectly passive element so far as carbon is concerned.

Phosphorus and Shrinkage.—The shrinkage of a test-bar made from wrought iron was 0.292, while a test-bar containing 10.22% of phosphorus had a shrinkage of 0.164 in., showing that the phosphorus had taken out more than 40% of the shrinkage. This indicates that phosphorus acts by itself.

In testing the influence of phosphorus in cast iron to reduce shrinkage an iron very low in silicon should be taken. Such series are White and P., Table XIX, and White and Durham, Table XXIII. The iron remained white, and for this reason the great decrease cannot be ascribed to any change in carbon, but is to be attributed directly to phosphorus. In the Hamden series there is a rapid fall in shrinkage until 1% of phosphorus is reached. The same is true for the Stewart-Norway series, though the change is not great.

From our knowledge of the effect of silicon through its action on carbon, and of phosphorus acting directly on the iron, the least possible shrinkage must be expected in iron with the largest amount of graphite, silicon, and phosphorus. This is the case. All high phosphorus pig irons have low shrinkage. Certain irons which contain from 4% to 7% silicon have been so much used on account of their ability to soften other irons that they have come to be known as "softeners," and as lesseners of shrinkage. These irons are valuable as carriers of silicon; but those accustomed to their use will perceive that the irons which are sold most as softeners and shrinkage-lesseners are those containing from 1% to 2% of phosphorus. We must therefore ascribe the reputation of some of them largely to the phosphorus and not wholly to the silicon which they contain.

It is new to consider phosphorus in this light in foundry practice, but it must be remembered that from $\frac{1}{2}$ % to 1% will do all

that can be done in a beneficial way, and that all above that amount weakens the iron without corresponding benefit.

The Influence of Phosphorus upon the Strength of Cast-iron.—All of these tests show that while phosphorus of itself, in whatever quantity present, weakens cast iron, yet in quantities less than 1.5% its influence in this direction is not sufficiently great to overbalance other beneficial effects which are exerted before the percentage reaches 1%. Probably no element, of itself, weakens cast iron as much as phosphorus, especially when present in large quantities.

The Influence of Phosphorus upon the Chill of Cast Iron.—In the F^LM series, Table XXII and Fig. 34, silicon decreases with each addition, and as a consequence the depth of chill increases.

In the F^LM and Hamden series in cast 479, which is of F^LM, with its silicon brought to 3.16%, the chill is only a little over 0.10 of an inch deep. The chill is only slightly more in the case of 480, which is of Hamden alone, with 3.16% of silicon.

The chill of each cast of the series does not materially vary from that of the others; 467 is a cast of Moxahala pig iron which was made from a different ore, and where the furnace was running regularly. It shows less chill than Hamden iron, while its phosphorus is higher.

In the Stewart-Norway series the chill remains the same, in fact it decreases as phosphorus increases.

Phosphorus and Hardness.—In the chapter on Hardness and that on Silicon Irons I have shown that the ordinary cause of hardness in cast iron is combined carbon, and that under ordinary conditions silicon may exert a softening influence, but that excessive silicon causes hardness.

The tests reported in this chapter show that phosphorus does not ordinarily harden cast iron, probably because it does not increase combined carbon. Further experiments might show exceptions, for the 10.22% phosphide is hard, while wrought iron cast alone is soft. Hamden is hard, as also is Moxahala.

The mixture of the hard Hamden with soft 479 shows hardness to increase as Hamden increases in quantity.

The hardness records as a whole indicate that phosphorus is neither a hardening nor softening agent; but if it is either, the tendency is on the side of hardening.

Phosphorus and Fluidity.—The conclusion reached from these tests is that the fluidity of the metal is slightly increased by phosphorus, but not to any such extent as has been ascribed to it. By watching the cooling of the metal in the mold after being poured, it was found that the time required for freezing varies directly with the percentage of phosphorus, the phosphide cast holding its heat longer than any other. This property of remaining long in the fluid state must not be confounded with fluidity, for it is not the measure of its ability to make sharp castings or to run into the very thin parts of a mold.

Generally speaking, however, the statement is justified that, to some extent, phosphorus prolongs the period of fluidity of the iron while it is filling the mold.

General Remarks.—The endeavor has been to exhibit the action of phosphorus separated from all other influences. But we must not expect that a given percentage of phosphorus will behave at all times as it has done in these tests, for other elements may be present in such a way as to modify results.

Are the favorite irons high in phosphorus? The old Scotch irons contained about 1%. The foundry irons which make the best thin castings in the Eastern States contain, as a general rule, over 1% of phosphorus. From an extensive examination of English foundry irons Professor Turner concludes that the best foundry iron should contain about 1%. It has always been noticeable that the irons which are rejected by the rolling-mill people on account of phosphorus are most acceptable to the founder. American pig iron will rarely impart to castings more than this percentage.

CHAPTER X.

SULPHUR IN CAST IRON.

SULPHUR exists in nature as a brittle solid, of lemon-yellow color, and has a specific gravity of 2.05. It is of volcanic origin and alloys with pure iron in all proportions. Very small percentages are said to cause wrought iron and steel to become brittle at a red heat, though strong at a white heat and when cold, which peculiarity has given to this kind of brittleness the name of red-shortness. All mineral fuel and many ores of iron contain sulphur, therefore most cast iron contains a small percentage of sulphur, which in gray cast iron is very small indeed, as carbon seems to prevent its absorption. The term red-short cannot be correctly applied to cast iron.

In 1886 Professor Turner said: "We are still in need of exact information as to the influence of sulphur in cast iron."

Almost without exception, writers on the subject say that sulphur in cast iron will cause it to be white and is in every way injurious. All founders believe that a small amount of sulphur in the fuel will work great damage, and that if any castings crack, or if anything out of the general run occurs, it may be charged to sulphur in the fuel. Fuel rarely contains more than 1% of sulphur, and if this can produce so marked an effect, one would suppose it an easy matter to introduce sulphur into cast iron, so as to produce castings containing different desired percentages of sulphur.

As carbon is increased toward saturation, as in white cast iron, about 0.05% of sulphur can be retained; and as silicon

increases, changing carbon into graphite, less sulphur is found in the iron.

Writers say that the influence of sulphur in all cast iron is to drive out carbon and to increase chill, to increase shrinkage, and as a general thing to decrease strength.

By melting iron of uniform composition in a crucible, and adding brimstone, the following results were obtained (Table XXVII, Method 4):

TABLE XXVII.

Test No.	Mixture.	Dead-load Strength.	Shrinkage.
41	With no sulphur.	411	.120
48	With sulphur....	432	.160
47	" "	358	.176
46	" "	263	.207

By three tests, melting the same kind of iron as above in a crucible, and adding fluor-spar free from galena to one crucible, and to other crucibles adding almost pure galena (containing over 14% sulphur), Table XXVIII (Method 4) was obtained.

TABLE XXVIII.

Test No.	Mixture	Dead-load Strength.	Shrinkage.
51	With good fluorspar	367	.137
55	With galena.....	260	.165
56	" "	383	.170

To soft iron from a cupola were added, in one ladle, iron pyrites (containing 39.88% sulphur); in another "blue billy" (with S. 9.15%); in another were placed selected brown spots from coke supposed to be rich in sulphur; in another, the purest coke that could be selected; and in still another, iron ore of practically the

same composition as that in the pyrites and "blue billy," only with no sulphur. Each of these materials was ground to a fine powder, and small foundry ladles were lined with a pound of each, and into each ladle 15 lbs. of iron was poured from the cupola. The result was Table XXIX (Method 2).

TABLE XXIX.

Test No.	Mixture.	Strength.		Dead-load Deflection.	Shrinkage.	Chill.
		Dead Load.	Impact.			
608	Iron alone	342	271	.18	.151	.15
603	Clear coke	332	322	.18	.154	.10
604	Sulphury coke?....	346	271	.18	.153	.10
605	Iron ore	380	345	.19	.159	.13
606	"Blue Billy".....	274	119	.08	.208	White
607	Iron pyrites.....	255	169	.07	.194	"

This test shows that iron pyrites imparts its sulphur to gray iron and turns it white.

In this series of tests the iron alone showed an unusually high shrinkage and chill, because of the ladles being freshly lined and not having had iron caught in them before the test. To find whether this would influence the iron, three ladles were freshly lined and dried. In one of these the iron was caught, and the ladle was then allowed to become cold. Another was used continuously, and the third was not used prior to the test. A set of bars was then poured from each ladle with the following results, Table XXX (Method 2):

TABLE XXX.

Test No.		Dead-load Strength.	Dead-load Deflection.	Shrinkage.	Chill.
624	Hot dried ladle...	335	.18	.143	.07
623	Cold " " ...	386	.20	.151	.04
622	Green fresh ladle.	369	.19	.156	.06

This series shows that conditions often overlooked may influence castings more than chemical constitution. The iron in all the ladles was of exactly the same composition, for it was caught in a large ladle and at once poured into the small ladles.

In the endeavor to make a high-sulphur pig iron (Method 4), 25 lbs. of F^LM gray iron was melted in a crucible, and fed slowly with 8 lbs. of brimstone, keeping it as closely covered as possible. The operation occupied about two hours, and when completed there was at the bottom about 5 lbs. of silver-white iron, covered with a very rich sulphide of iron.

This white iron showed, by analysis, 0.58 sulphur, which was conclusive proof that a carbonized iron rich in sulphur could not be made artificially.

Messrs. Weston and Smith, in Dr. Percy's laboratory, found that it was difficult in any case to cause cast iron to take up sulphur, and they did not say that it turned the iron white. With our knowledge of the action of silicon gained from the preceding pages, their experiments prove rather the reverse.

The author made a series of tests with F^LM gray pig iron, Table XXXI, adding brimstone to the melted metal (Method 7). This series was remelted and the results of the original are given in heavy figures, and of the remelt series in light figures, side by side.

TABLE XXXI.

Test No.	Mixture, Crucible.	Strength.		Dead-load Deflection.	Shrinkage.		Chill.						
		Dead Load.	Impact.		Square Bar.	Flat Bar.							
253	F ^L M and 0.00S.....	.397	.413	.305	.333	.23	.21	.166	.168	.221	.226	.50	.60
265	Do. 0.10S.....	.378	.396	.322	.367	.23	.23	.169	.178	.225	.225	.50	.70
266	Do. 0.30S.....	.395	.397	.384	.368	.26	.25	.172	.181	.231	.231	.65	.70
267	Do. 0.50S.....	.381	.385	.333	.384	.22	.25	.179	.186	.219	.212	.70	.70
268	Do. 0.80S.....	.322	.364	.209	.330	.17	.23	.193	.193	.242	.223	.55	.60
269	Do. 1.00S.....	.345	.336	.362	.322	.22	.21	.192	.193	.228	.222	.50	.70
270	Do. 2.00S.....	.374	.341	.351	.271	.26	.18	.193	.194	.237	.220	.70	.40

The amount of brimstone necessary to produce so great a percentage of sulphur required, towards the last, two or three separate additions, and consequently the burning of two or three

hollow plugs in the metal. The same metal (F^LM) was melted, and the insertion of two empty plugs gave the results shown by the heavy figures of Table XXXII. The remelt is shown by the light figures. The grain of the remelt of 254 is shown in the last number of Fig. 40.

TABLE XXXII.

Test No.	Iron.	Strength.		Dead-load Deflection.	Shrinkage.		Chill.
		Dead Load.	Impact.		Square Bar.	Flat Bar.	
254	F ^L M 0.0 S. with 2 plugs	.425 .408	.339 .360	.23 .26	.180 .166	.179 .250	0.40 .60

Fig. 37 shows the fracture and chill of each of the remelted bars in Table XXXI.

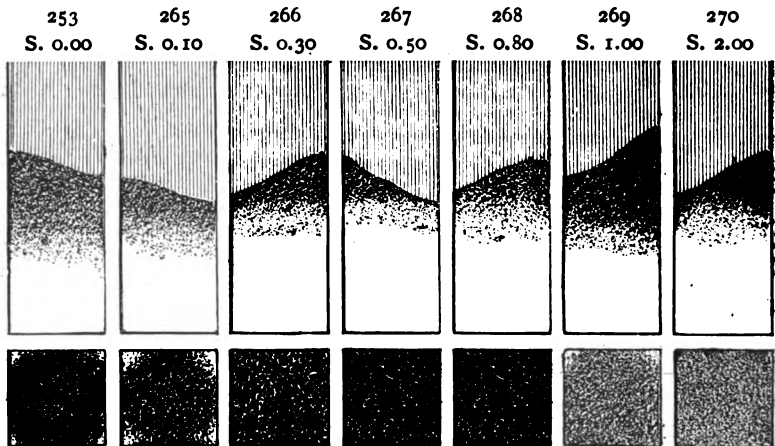
FIG. 37.—F^LM + Brimstone.

While the strength decreases slightly with each addition of brimstone, the shrinkage shows a decided increase, and this increase remains constant in the remelts, while in Table XXXII the shrinkage of the remelt returns to its original figure. The remarkable thing is that the chill is not affected, and the grain, to say the least, is as even after the addition of sulphur as before.

The following series of tests are on a different plan. Sulphide of iron was introduced into molten cast iron from a cupola.

As the sulphide would not give up its sulphur when remelted, it formed a compound of carbonized iron and sulphide of iron. The sulphide was only in the iron a very few moments before it was put in the molds, and therefore most of the sulphur is probably in the test-bars. A number of series were made in this way.

In ordinary foundry practice this union would not occur, but this is the only way to cause a large percentage of sulphur to stay in carbonized iron. The first sulphide that was used contained 25% of sulphur and 75% of pure iron. It had a shrinkage, when cast alone, of square bar .107 and thin bar .125. Enough sulphide was placed in six foundry ladles to give the desired percentage of sulphur to the castings. Enough 11% ferrosilicon was added to keep the silicon the same as in the cupola iron, which was about 2.50%. Enough scrap of the same composition was also added to make the cooling effect the same in each ladle. The iron was caught from the cupola in a large ladle and at once divided among the small ladles. The materials added were cemented to the bottom of the ladle with fire-clay. As the added portions melted, they came to the top through the molten iron and remained there. The bars poured last from a ladle showed that more and more of the sulphide was absorbed as more time was given. The test gave the results of Table XXXIII (Method 2).

TABLE XXXIII.

Test No.	Mixture.	Strength.		Dead-load Deflection.	Shrinkage.	Chill.
		Dead Load.	Impact.		Square Bar.	
625	Cupola iron, 0.00S...	39721	.151	.04
626	Do. .10S...	422	299	.21	.152	.03
627	Do. .30S...	410	352	.21	.152	.06
628	Do. .50S...	400	339	.21	.150	.03
629	Do. .80S...	385	307	.19	.157	.05
630	Do. 1.00S...	340	271	.19	.165	.08

In the 0.80% set of bars the first bar had a shrinkage of .153, and the last .165. In the 1% bars the shrinkage of the bars was .153, .169, .168, .175, and .174, showing that sulphide was absorbed as time was given, or else that the iron highest in sulphide did not run out first. The influence of cooling in the ladle with no sulphide present produces a contrary effect, as is shown, for example, in the following five sets, Table XXXIV. The first bar was poured when the iron was first caught; the second when the iron was half cooled down; and the third when the iron would just fill the mold.

TABLE XXXIV.

NO SULPHUR.	Test No.	Dead-load Strength.			Shrinkage.		
		Very hot.	Partly cooled.	Would just run.	Very hot.	Partly cooled.	Would just run.
	22	366	424	418	.156	.157	.142
23	427	456	478	.120	.128	.121	
24	392	427	450	.151	.148	.135	
25	441	450	473	.154	.154	.151	
26	413	427	.157	.162	.170	

Table XXXV is exactly like the last sulphide series (Table XXXIII) except that the additions were pounded fine and were thrown into the ladle loose, just before the iron was poured in (Method 2).

In this series the sulphide was melted more quickly and formed a more perfect alloy, though a considerable amount floated on top. The grain and chill are shown in Fig. 38.

TABLE XXXV.

Test No.	Mixture.	Strength.		Dead-load Deflection	Shrinkage Square Bar.	Chill.
		Dead Load.	Impact			
614	Cupola iron and 0.00 S.	392	299	.21	.144	.01
609	" .10 S.	395	282	.19	.144	.04
610	" .30 S.	365	254	.20	.161	.03
611	" .50 S.	382	237	.19	.173	.05
612	" .80 S.	348	212	.17	.178	.10
613	" 1.00 S.	312	225	.16	.177	.10

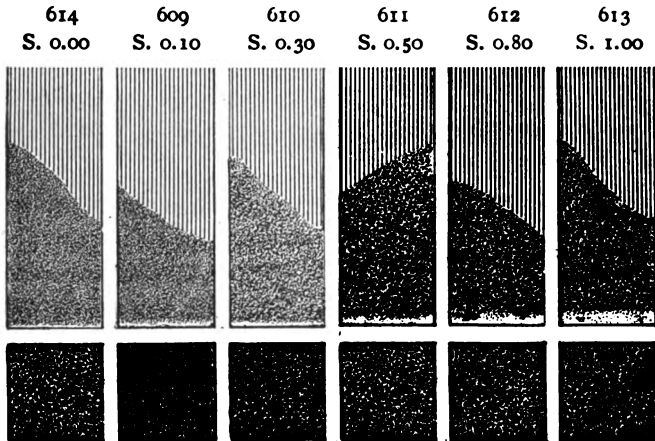

FIG. 38.—Cupola Iron + S.

A series of test-bars was made in a crucible using F¹-M gray pig iron (1.25 silicon and 3.50 carbon), adding a sulphide of iron containing 22% of sulphur. This, unlike Table XXXIII, had no silicon added to keep the silicon uniform, and therefore by the addition of the iron sulphide both silicon and carbon were diluted. The tests gave the following record, Table XXXVI (Method 11):

TABLE XXXVI.

Test No.	Mixture, Crucible.	Strength.		Dead-load Deflection	Shrinkage.		Chill.
		Dead Load.	Impact.		Square Bar.	Flat Bar.	
429	FLM. with 0.00 S.	335	330	.23	.166	.200	.60
430	" .10 S.	344	322	.20	.193	.234	.65
431	" .30 S.	364	263	.14	.208	.240	1.25
432	" .80 S.	389	212	.12	.245	.244	all
433	" 1.00 S.	422	305	.14	.241	.236	all
434	" 1.50 S.	410	248	.14	.245	.244	all
435	" 2.00 S.	366	212	.18	.242	.241	all

Fig. 39 shows the grain of this series.

The decrease of silicon and carbon along with the increase of sulphur introduces a complication; and to find out which produced

the change in strength, shrinkage, chill, etc., examine the results shown in Fig. 33 and Table XXI (Method 13), pp. 69 and 71.

429	430	431	432	433	434	435
T. C. 3.55	T. C. 3.46	T. C. 3.37	T. C. 3.28	T. C. 3.19	T. C. 3.11	T. C. 3.02
Si. 1.20	Si. 1.17	Si. 1.14	Si. 1.11	Si. 1.08	Si. 1.05	Si. 1.02
P. 0.08	P. 0.08	P. 0.07	P. 0.07	P. 0.07	P. 0.06	P. 0.05
S. 0.04	S. 0.10	S. 0.30	S. 0.80	S. 1.00	T. 1.50	S. 2.00

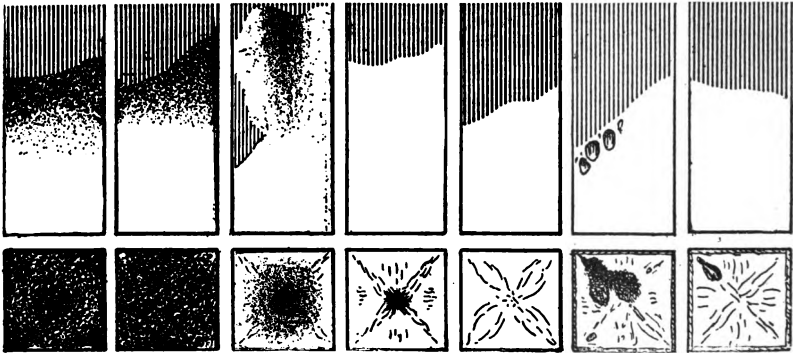

FIG. 39.—FLM + S.

If we subtract each member of Table XXI from the corresponding member of Table XXXVI, we shall find approximately the change due to sulphur.

A series was made (Method 11) with white pig iron in a crucible using the 22% sulphide. The white iron contained 0.186 silicon and 2.98 carbon, and the additions diluted the silicon and carbon as sulphur increased. This is shown in Table XXXVII.

TABLE XXXVII.

Test No.	Mixture.	Strength.		Dead-load Deflection.	Shrinkage.		Chill.
		Dead Load.	Impact.		Square Bar.	Flat Bar.	
424	White iron, with 0.00 S.	305	169	.10	.246	.236	all
425	“ “ .10 S.	349	161	.15	.248	all
426	“ “ .30 S.	269	149	.11	.249	.229	all
427	“ “ .80 S.	179	101	.09	.238	.223	all
428	“ “ 1.00 S.	133	51	.07	.232	.233	all

The grain and chill are shown in Fig. 40. To find the influence due to the dilution of silicon and carbon see Table XVIII and Fig. 30, pp. 67 and 68. Subtracting from Table XXXVII we find the influence of silicon, and that it was the decrease of silicon and carbon that produced the blow-holes.

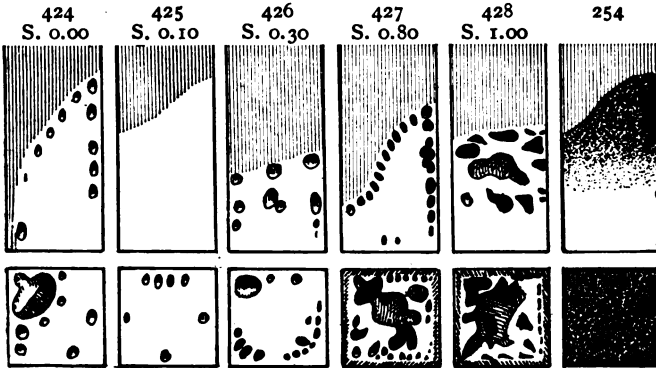

(254 is to be compared with 270 of Fig. 37, having been treated the same except that it contained no sulphide.)

FIG. 40.—White Pig Iron + Iron Sulphide.

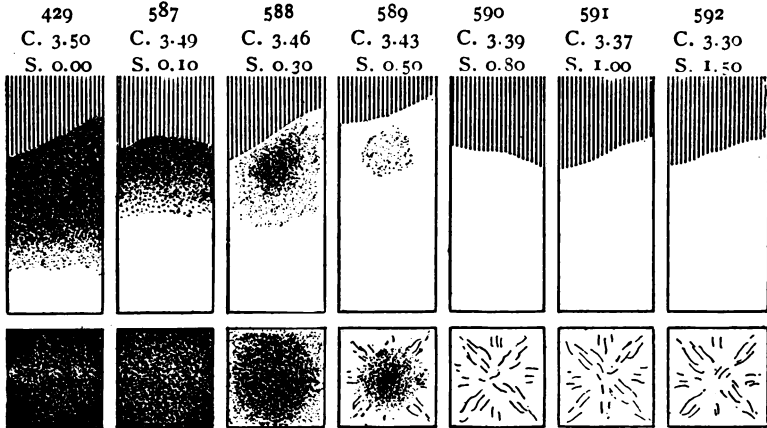

FIG. 41.—FLM + Sulphide, with Si. kept at 1.25%, otherwise this series is the same as Fig 39.

Another series was made in a crucible using FLM and the 25% iron sulphide (Method 4), and in this case there was added enough silicon to keep this element at 1.25% in all cases. The results are shown in Table XXXVIII and Fig. 41.

No cast was made of FLM alone, and therefore test record 429 was used.

The grain of 593 was exactly the same as 592.

As the silicon did not vary, it leaves only one element of uncertainty, viz., the carbon content, which was reduced to 3.22 in the last combination. To ascertain the effect of such a reduction of carbon with no reduction of silicon and without sulphur, the crucible tests (Method 6), Table IV and Fig. 18, page 31, were made with the same F^LM, adding wire to reduce carbon, but keeping silicon uniform by additions of 11% silicon iron.

TABLE XXXVIII.

Test No.	Mixture.	Strength.		Dead-load Deflection.	Shrinkage.		Chill.	Per Cent. Carbon
		Dead Load.	Impact.		Square Bar.	Flat Bar.		
429	F ^L M with 0.00 S.	335	330	.23	.166	.200	.60	3.50
587	" " .10 S.	375	310	.23	.189	.201	.60	3.49
588	" " .30 S.	343	279	.12	.197	.239	.80	3.46
589	" " .50 S.	355	305	.10	.221	.240	1.00	3.43
590	" " .80 S.	390	279	.12	.241	.244	all	3.39
591	" " 1.00 S.	493	347	.15	.250	.248	all	3.37
592	" " 1.50 S.	383	288	.12	.249	.240	all	3.30
593	" " 2.00 S.	410	322	.14	.251	.244	all	3.22

It is seen by comparing the 3.22 C. member in Table XXXVIII with the 3.25 C. member in Table IV that 2% of sulphur reduced strength 50 lbs., turned the iron white, and increased shrinkage 0.77. The reduction of carbon (Table IV) does not turn the iron perfectly white until it reaches 2.25%.

The preceding experiments were each made with 10 or 15 lbs. of material, and were conducted as in ordinary foundry work, and the sulphur was in contact with the melted iron fully as long as would be possible in cupola melting, and in several of the series very much longer.

The following experiments were made by placing a small amount of iron and iron sulphide in a small crucible in a laboratory furnace, where it would necessarily be exposed to the heat for a long time, and the iron and sulphide would have time to form a perfect mixture. As we understand it, the quantity was only sufficient to form a button at the bottom of the crucible.

Professor Turner* says that he remelted artificially prepared iron containing 11% sulphur, and while the sulphur remained in the iron in this case, yet the iron was soft and could be filed and flattened at the corners with a hammer.

Mr. Weston, in Dr. Percy's laboratory, took an artificially made white iron, with over 4% carbon; but as it contained no silicon, it was white. He added sulphur to this by means of a sulphide (29.9 S.). To the first cast was added by the sulphide 4.38% of sulphur, but one-half was lost in melting. The next time 2.38% of S. was added, and only one-quarter was lost. Next 1.24% of S. was added, and nearly one-half was lost.

This last was remelted with no loss of sulphur, but was *mottled*. In the first three cases the product was white, the same as the original iron. The last, in two meltings, had absorbed enough silicon to turn it to a mottle in spite of the decrease of carbon and the presence of sulphur.

Mr. Smith, in the same laboratory, mixed with gray cast iron enough of the sulphide to add 2.68% sulphur, but found only 0.78%, nearly three-quarters being lost. The product was white, as there was not enough silicon present to overcome this amount of sulphur. This was remelted with a further loss of over half the remaining sulphur, leaving a *mottled* iron; that is, the iron contained enough silicon to overcome the influence of 0.40% of sulphur.

He mixed another lot of gray cast iron with enough of the same sulphide to make 0.90% sulphur, with a loss of nine-tenths of the sulphur in melting.

At another time he took a No. 2 gray iron and mixed the sulphide in sufficient quantity to make the sulphur 1.65%, and lost about one-third. The product was white.

In all of the above experiments of Weston and Smith, except the first, graphite separated from the iron and appeared on the outside of the metal.

* Journal of the Iron and Steel Institute, 1888, No. 1, p. 88.

This would not indicate that the sulphur necessarily caused the carbon to retain its combined form.

In the fourth experiment of Mr. Weston, he began with a perfectly white iron and remelted it twice, the first time with 1.24% sulphur, and finally with 0.72%. More than half that was added remained, and yet the casting was mottled. It has been proved by Tables XXXI and IV that if a gray iron has its silicon lessened sufficiently, it will be mottled or white. If it contains but a small percentage of silicon, it cannot be anything but white. In every case Messrs. Weston and Smith used clay crucibles, and the iron would take some silicon from this source, while the grayness of the mottled product shows that the sulphur did not counteract the influence of silicon. In Mr. Smith's experiments, gray cast iron is taken in every case, but the sulphide which he adds is made up of 70% of pure iron and 30% sulphur, and therefore the sulphide addition materially reduces the silicon and carbon in the iron, and in this case it was enough to render the iron white, the same as in Table IV; but by remelting, enough silicon was taken from the crucible to restore the iron to a mottle.

In the experiment of Mr. Smith, where he used a No. 2 iron, the whiteness was no doubt largely due to the dilution of carbon and silicon by the addition of the sulphide; for the iron was No. 2—that is, close-grained from containing a small amount of silicon.

The experiments of these gentlemen have been commented on thus fully because they have been quoted to show that sulphur compels carbon to take the combined form, and that sulphur will drive out carbon—the fact being wholly overlooked that the addition of sulphide diluted the carbon and silicon, and thus whitened the iron. The fact of carbon being on the surface of the casting would seem to prove that sulphur will expel carbon rather than make it combine.

The author's experiments which have been described are in every way similar to those of Messrs. Weston and Smith, except that he kept the sulphur percentages below 1% and melted a large

quantity of material. F^LM iron contained 3.50% of carbon and 1.25% of silicon, or just enough to make the iron gray. The addition of sulphide diminished the carbon in every case and diminished silicon in some cases. Both reductions tend to make the iron white.

All these tests show that sulphur, if present to any extent in cast iron, tends to increase shrinkage and to turn the iron white; but, on the other hand, to prove this tendency we have been obliged to resort to unusual methods, and we have added percentages of sulphur which can never be found in commercial pig iron.

At a number of furnaces ores are used that contain over 3% of sulphur. The fuel also contains nearly 1% of sulphur.

This condition of things would cause the largest possible percentage of sulphur to be taken up by the iron, but all agree that in white iron made from these ores not more than 0.75% of sulphur will be found, and in mottled iron not more than 0.25%, and in gray foundry iron not more than a few hundredths of 1% can be found.

The rapid melting of pig iron in a cupola cannot possibly add much sulphur content to the pig iron. Professor Turner mixed iron, containing 11% sulphur and 10% silicon, with pig iron in proportions to give him 5% of sulphur; but it only contained 0.4%, nine-tenths of the sulphur having disappeared by a single melting.

Gray pig iron will never contain more than 0.10%, and probably never one-half that amount of sulphur. Examining the foregoing experiments with a view to ascertaining the influence of 0.05% of sulphur, we must at once conclude that even this large amount will not exert any appreciable deleterious influence, and that what little is done in this direction is at once corrected if the silicon is slightly increased.

Remembering that the only noticeable effect of these small percentages of sulphur would be to slightly raise the shrinkage, the above conclusion seems to be also proven by the fact that in

a cupola running on a substantially uniform mixture, and returning from 25% to 40% of its iron to the cupola to be remelted over and over again each day, the castings will almost invariably have a less shrinkage than the average of the pig iron used, and yet, as a general thing, the castings will contain more sulphur than the average of the pig iron, and the silicon will always be less than the average of the silicon in the pig iron.

The depth of chill does not seem to be influenced by these small percentages of sulphur, and there is no testimony to show that there is any relation whatever between the sulphur-content and the strength in pig iron or in ordinary castings.

In fact it is generally accepted that one brand of Swedish pig iron owes its strength and adaptability for gun construction to pyrites added in the furnace.

INFLUENCE OF REMELTING ON SULPHUR.

Table XXXIX contains analyses of the sulphur in each of the test-bars of the nineteen A. S. M. E. series, and the analyses of the pig irons is found on pp. 11 and 12. These can be compared with the physical qualities recorded elsewhere. See also Table LXIII, page 136.

From the sulphurs in these tables we can find nothing to show a ground for the origin of the opinion which prevails regarding sulphur. Sulphur is not by any means uniform in the nineteen series, but there is not the least indication of evil result from its presence in the series containing the highest sulphur. The variation between the sulphur of series 5 and 6, or between 4 and 5, "Iroquois," is enough to influence grain and strength if the general opinion is correct, but those with the highest sulphur show the most open grain and are the softest. In "Hinkle," Series 7 and 8, the sulphur does not exert any evil influence. In Series 14, 13, and 15 the sulphur is about as high as is ever found in gray castings, and yet these series show both small and large castings beyond reproach. No chill, no blow-holes, very low shrinkage, and very high strength. The high strength can

•

hardly be ascribed to the high sulphur, for strength in these series does not increase with any uniformity as sulphur increases.

TABLE XXXIX.

	Series.	Per Cent. of Sulphur.					
		$\frac{1}{2}$ " □	1" □	1" X 2"	2" □	3" □	4" □
Iroquois.....	1	.056	.054	.050	.046	.049	.041
	2	.046	.040	.040	.039	.039	.039
	3	.032	.030	.030	.033	.036	.030
	4	.045	.046	.047	.040	.044	.044
	5	.017	.021	.027	.031	.030	.030
	6	.034	.033	.034	.033	.028	.028
Hinkle.....	7	.029	.030	.031	.033	.030	.030
	8	.015	.011	.010	.011	.010	.009
	9	.015	.011	.009	.010	.010	.007
	10	.021	.019	.017	.019	.020	.022
	11	.030	.027	.025	.030	.022	.027
	12	.031	.030	.033	.026	.029	.025
Southern.....	14	.093	.096	.100	.092	.094	.090
	13	.091	.095	.091	.093	.091	.090
	15	.088	.093	.088	.089	.087	.089
Bretting & Co.....	16	.025	.030	.030	.029	.030	.029
Mich. Mall. I. Co..	17	Average 0.031 per cent.					
Bement, Miles & Co.	18	" 0.052 "					
A. Whitney & Sons.	19	" 0.101 "					

There is, however, not the slightest indication that sulphur is in any way beneficial. A small percentage of sulphur will get into a casting from the fuel, and chemists are accustomed to lay any unexplainable peculiarity to sulphur.

In the laboratory tests that have been described, in the effort to prove that sulphur had a tendency to increase shrinkage and chill and to turn iron white, it was necessary to resort to unusual methods, and percentages of sulphur were added which can never be found in commercial pig iron or fuel.

The foregoing tests were made to prove the correctness of the general opinion that sulphur was never anything but injurious, or at least to show how such an opinion originated. Having failed in this effort, if these records shall suggest that the opinion is partly a superstition, and that the gray-iron founder must look

to some other cause for defects in castings, the work will do a great deal of good.

If iron pyrites is put into a cupola, it will harden cast iron at once. At one time a car of limestone which we used as a flux contained pyrites. The first day the shrinkage was .133, but complaints came in that the iron was hard. The second day the shrinkage ran up to 176, and much of the iron could not be drilled. The pyrites were then discovered and the limestone changed (leaving the iron mixture unchanged all the time), and that day the shrinkage was back to 135, and the iron was soft. Sulphur in coke is not in a condition to be so easily taken up by gray iron.

NOTE.—The sulphur percentages given in all tables and figures of this chapter, except Table XXXIX, are amounts added.

CHAPTER XI.

MANGANESE IN CAST IRON.

THE ferromanganese used in these experiments contains Mn. 81.62, Si. 0.256, and Cd.C. 6.153%. This cracks in small pieces when cooling.

Manganese combines with iron in almost any proportion; but if an iron containing manganese is remelted, more or less of the manganese will escape by volatilization, and with oxidation with other elements present in the iron, especially sulphur.

Owing to this escape of manganese the amount of manganese given in the tables is no doubt greater than would be found by analysis.

The following three casts were made, Table XL (Method 2), with three hot ladles: in the first was placed five ounces of gray scrap; in the second four ounces of white iron and one ounce of 11% ferrosilicon; in the third four ounces of ferromanganese and one ounce of the ferrosilicon.

TABLE XL.

No. of Cast.	Manganese added.	Silicon in Casting.	Dead-load Stress.	Dead-load Deflection.	Dead-load Set.	Impact Stress.	Impact Deflection.	Impact Set.	Shrinkage.	Chill.	Hardness.	Hardness of Chill.
1	0	2.50	380	.190	.029	365	.225	.022	.121	.075	70	124
2	0	2.51	398	.195	.029	323	.225	.050	.123	.060	70	124
3	1.08	2.51	380	.165	.017	271	.182	.015	.155	.065	99	160

Into each of these ladles was poured the same amount of cupola melted iron. As the cupola iron contained 2.50% silicon,

the ounce of ferrosilicon kept the percentage of silicon practically uniform.

To prove still further the influence of silicon in manganese irons, and that much of the influence exerted by manganese can in most cases be overcome by silicon, Table XLI and Fig. 42 (Method 10) are presented.

TABLE XLI.

Percentage Manganese.	Silicon Added.	Dead-load Stress.	Dead load Deflection.	Dead-load Set.	Impact Stress.	Impact Deflection.	Impact Set.	Shrinkage.	Chill.	Hardness.	Hardness of Chill.
20.00	0	150	.05	.01	68	.09	.01	.272	White	185	235
20.00	1.66	168	.07	.02	101	.11	.02	.266	0	186	235
20.00	3.00	179	.16	.05	101	.14	.03	.240	0	146	215
20.00	4.84	230	.27	.11	118	.21	.06	.222	0	115	160
20.00	6.20	326	.47	.24	350	.44	.19	.218	.001	123	173
20.00	7.30	195	.30	.12	169	.24	.07	.213	.075	127	205

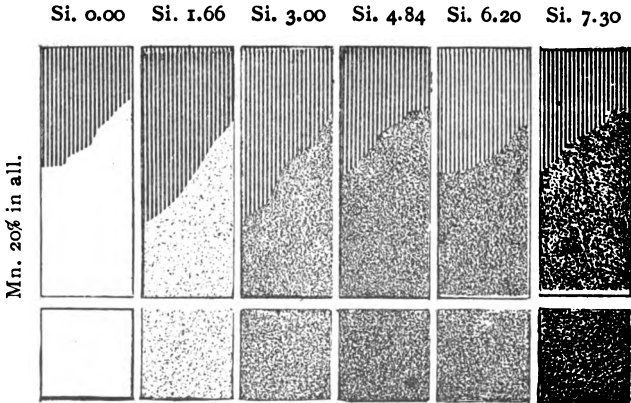

Mn. 20% in all.

FIG. 42.—Spiegeleisen with Silicon added.

The first cast is from spiegel alone and contains hardly any silicon. The fracture is white with the usual reflecting surfaces.

The second has changed the metal to a light gray, with no tendency to chill, and has almost destroyed the specular fracture presented by the spiegel.

Mr. R. A. Hadfield added to 12% white spiegel 3.75% silicon and turned it to a No. 3 gray mill iron.

With F^LM and the ferromanganese were made the tests of Table XLII (Method 4).

TABLE XLII.

Manganese added.	Silicon estimated.	Dead-load Stress.	Dead-load Deflection.	Impact Stress.	Shrinkage.	Chill.
.12	1.247	343	.23	282	.159	.40
.66	1.239	297	.18	226	.161	.40
.75	1.237	342	.16	259	.164	.50
1.00	1.233	334	.15	237	.168	.70

The additions of ferromanganese diminished the silicon in each cast which caused the increase of chill.

With "Stewart" coke iron, Si. 1.53, Mn. 0.50 (Method 4) was made the series of Table XLIII. The ferromanganese was added as near the time of pouring as possible, to prevent the escape of the manganese. As in Table XLII, the silicon was diluted by each addition.

TABLE XLIII.

Manganese added.	Silicon estimated.	Dead-load Stress.	Dead-load Deflection.	Dead-load Set.	Impact Stress.	Impact Deflection.	Impact Set.	Shrinkage.	Chill.	Hardness.
.50	1.53	353	.27	.08	373	.29	.07	.152	.02	62
1.66	1.51	357	.28	.06	381	.26	.05	.156	.05	99
2.26	1.50	329	.21	.03	305	.22	.03	.157	.20	99
3.00	1.48	380	.28	.06	313	.24	.04	.142	.25	
3.83	1.47	331	.26	.05	350	.25	.04	.136	.20	
10.88	1.36	215	.09	.01	118	.11	.01	.232	.50	

Table XLIV represents tests with cupola iron and ferromanganese (Method 2).

TABLE XLIV.

Manganese added.	Silicon estimated.	Dead-load Stress.	Dead-load Deflection.	Dead-load Set.	Impact Stress.	Impact Deflection.	Impact Set.	Shrinkage.	Chill.	Hardness.	Hardness of Chill.
0.	2.50	364	.18	.01	271	.19	.02	.147	.10	90	195
.75	2.48	420	.19	.02	254	.18	.01	.148	.18	103	187
1.87	2.44	394	.16	.01	220	.17	.01	.159	.15	111	235
3.50	2.39	323	.14	.01	204	.15	.01	.165	.12	124	215

The additions in these casts also diluted the silicon as manganese increased.

Table XLV, F^LM and ferromanganese (Method 11), the metal was in the furnace nine hours, and instead of 2% there was only .583 Mn., and .187 of this was in the original pig, the rest having volatilized. The change in physical quality was produced by the manipulation and dilution of silicon, as will be seen by reference to Table XX and Fig. 32, pages 69 and 70.

The last 2.00 Mn. record is exactly like the first O. member, but with 2% manganese added just before the casting was poured and none could have escaped.

TABLE XLV.

Manganese added.	Manganese by Analyses	Silicon Estimated.	Silicon by Analyses	Dead-load Stress.	Dead-load Deflection.	Impact Stress.	Impact Deflection.	Shrinkage.	Chill.
0.	In pig .187	1.25	337	.18	314172	.50
.25	1.25	360	.24	330164	.52
.50	1.24	368	.24	339164	.65
.75	1.24	398	.18	314167	.80
1.00	1.24	398	.17	382178	1.00
1.25	1.23	441	.22	457187	1.25
1.50	1.22	325	.13	296195	1.50
1.75	1.00	431	.17	399205	White
2.00	.583	.98	284	.09	220230	"
2.00	1.22	404	.18	357	.22	.171	.80

Manganese and Carbon.—Cast iron, when free from manganese, cannot hold much more than 3.80% of carbon, but as manganese increases, carbon also increases, until we often find it in spiegel as high as 5%, and in ferromanganese as high as 6%.

Because the spiegeleisen and ferromanganese of commerce are white, it seems to have been taken for granted that the combined state of carbon in irons high in manganese was caused by the manganese.

Mr. Willard P. Ward* says that he made a 16% spiegel perfectly gray and very tough and strong, and yet which

*Trans. of the American Institute of Mining Engineers, vol. x. p. 268.

could not be cut. Mr. Pourcel* reports a gray 15% spiegel. His furnace, like Mr. Ward's, was very hot and enough silicon was taken up to make the iron gray. (See Table XLI and Fig. 42 for the same result.)

A more convincing proof is seen in Figs. 43 to 45a, Swedish irons.



G.C.	0.98
C.C.	3.50
Si.	0.95
Mn.	5.00
P.	0.018
S.	0.005



FIG. 43.

Fig. 43 is an iron containing 5% manganese and very low silicon, but uniform gray, cast in an iron mold, yet takes a very slight chill.

Fig. 44 is white on account of its low silicon and not from manganese, because it has less than Fig. 43.

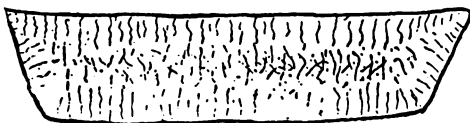

G.C.	0.83
C.C.	3.70
Si.	0.42
Mn.	4.50
P.	0.018
S.	0.006



FIG. 44.

Fig. 45 is an even gray; one and one half per cent of silicon has set free eleven twelfths of all the carbon.

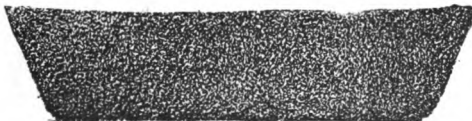

G.C.	3.61
C.C.	0.38
Si.	1.47
Mn.	1.78
P.	0.017
S.	0.009



FIG. 45.



G.C.	0
C.C.	3.70
Si.	0.30
Mn.	0.65
P.	0.017
S.	0.011



FIG. 45a.

Fig. 45a is the same iron with $\frac{1}{2}$ the silicon and $\frac{1}{3}$ the manganese of Fig. 45. The manganese has nothing to do with the grayness or the chill.

* Trans. of the American Institute of Mining Engineers, vol. xi. p. 197.

Manganese and Shrinkage.—Nearly all of these tests show that manganese increases shrinkage. In the tests of Table XL, an increase of 1% has raised the shrinkage 26%. So long as any carbon remains in the combined form an increase of silicon will drive such carbon into graphite, and this in some degree decreases shrinkage, but a high shrinkage caused by manganese seems to be independent of carbon and cannot be taken out without removing the manganese.

Much depends, however, upon how the manganese got into the iron. If present in small quantities in the pig it may not raise shrinkage so much as if introduced by a high-grade ferromanganese.

For a soft iron without shrinkage manganese should be absent, yet it does not seem that where manganese in the pig is below .75% or even 1% its presence will ever be noticed.

Strength.—A general glance at the records conveys an impression that manganese does not influence the ability to resist a dead load, though adding ferromanganese to molten iron generally reduces strength.

The small percentages of manganese found in commercial foundry-irons will have little if any influence on strength.

It will be seen from this discussion that it is almost impossible to determine whether manganese is a benefit or an injury. It is only with the closest calculation and care that we have been able to determine its influence at all when present in cast iron. Much that is present in a pig iron may escape during remelting and it may aid in removing sulphur which has been brought in with the fuel.

Chill.—Judging from these records manganese does not materially influence chill.

Manganese steel is not hardened by sudden cooling, and we might therefore expect that manganese would not add to the chilling quality of cast iron. A decrease of silicon often increases chill, and this may account for the small increase in the tests. If manganese has any chilling tendency, the 20% spiegel tests and

the Swedish irons would show it, and yet each cast of that test shows absolutely no chill, except the very slight chill with 7.30 silicon. It even seems to act in a contrary manner, as in irons without manganese we find it difficult to remove all chill by additions of silicon. The presence of manganese under certain conditions may possibly aid in removing chill.

TABLE XLVI.

	Series.	Per Cent of Manganese.					
		½" □	1" □	1"×2"	2" □	3" □	4" □
Iroquois.....	1	.35	.36	.37	.35	.34	.36
	2	.31	.30	.30	.31	.30	.32
	3	.50	.51	.49	.46	.51	.48
	4	.35	.30	.32	.33	.34	.35
	5	.36	.39	.38	.37	.37	.38
	6	.43	.45	.41	.40	.44	.43
Hinkle.....	7	.47	.44	.46	.47	.45	.48
	8	.37	.34	.37	.36	.35	.37
	9	.48	.47	.44	.49	.47	.51
	10	.63	.71	.43	.43	.47	.44
	11	.58	.74	.71	.58	.64	.54
	12	.59	.56	.53	.56	.54	.61
Southern.....	14	.59	.60	.62	.60	.59	.64
	13	.43	.48	.43	.47	.40	.41
	15	.50	.49	.50	.50	.49	.51
Bretting & Co.....	16	.57	.38	.37	.38	.36	.38
Mich. Mall. Iron Co...	17	Average..... .363 per cent					
Bement, Miles & Co ..	18	"354 "					
A. Whitney & Son.....	19	"350 "					

Hardness.—(Turner's Test.) In the tests of Table XL an increase of 1% of manganese has increased the hardness 40%. In the first two casts the hardness of the chill is 44% greater than that of the unchilled fracture, but in the cast with manganese the difference is only 38%, again showing that manganese does not increase chill. If, however, a hard chill is required manganese gives it by adding hardness to the whole casting. This hardness is probably due to the hardness of the manganese itself and not because more of the carbon has taken the combined form. It

seems that in trying to make soft castings with low shrinkage, manganese should be avoided.

The hardness of the spiegel series is remarkable. The castings with 7.30 silicon look like the softest of open gray iron, but can hardly be touched with a file, and the piece that was left in the crucible could not be cut with a cold-chisel. It was necessary to bring it to a white heat before the chisel could be driven into it with a sledge.

Influence of Remelting on Manganese.—Table XLVI (Method 1) gives the percentage of manganese in each bar of each series made for the Testing Committee of the A. S. M. E., and on pages 11 and 12 is given the analysis of the original irons. See also Table LXIII, p. 136.

CHAPTER XII.

SEGREGATION.

Segregation.—Where any element collects in greater quantity within a casting than the average throughout the mass, such element is said to segregate.

The separation of graphite into the spaces between the crystals and its even distribution throughout the mass is not generally spoken of as segregation, though the aggregation of graphite into patches, as in mottled iron, might be considered as such.

It is known that sulphur is never evenly distributed, but is always greatest at the point which cooled last.

Excellent examples of segregation of compounds of silicon, carbon, and iron were shown at the Columbian Exposition by makers of Swedish pig iron. This iron is the purest iron that can be found, on account of the purity of the ores from which it is made. All Swedish pig iron is said to be run into an iron pig-bed, and the surface of each pig is liable to show the influence of this chilling.

The ordinary Swedish pig-iron slab is 8 or 9 ins. wide by about 16 ins. long. The samples shown in the exhibit were fractured across the slab at its center and the drawings, Figs. 46 and 47, of these fractures are on a scale of $\frac{3}{8}$ of an inch to 1 inch.

Fig. 48 is a very small drawing of a fracture of a pig of American charcoal iron from Lake Superior ores which could not be sold because buyers were afraid of the white spot at the center.

F^LM (Fig. 49) is a greatly reduced drawing of a pig of Swedish gray iron made by Laxa Iron Works (Ltd.), Carlsdal, near

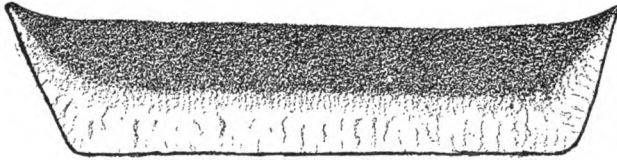

S□E
For Lancashire
Process Steel.



Degafors
For Open-
hearth Steel.

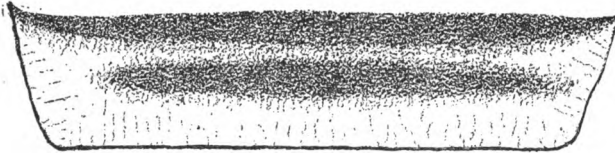

(WS)
Phos. below
0.024. For
Crucible Cast
Steel.

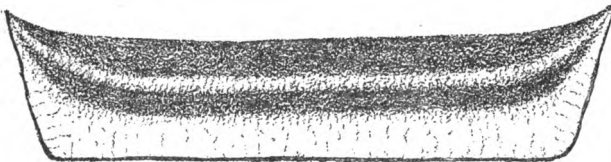

OB N
Phos. below c.02
For Siemens-
Martin Open-
hearth Steel.

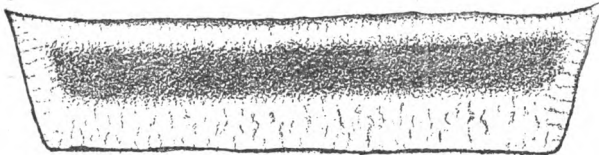

ON
For Lancashire
Firing Process.



AOB
Dannemora.

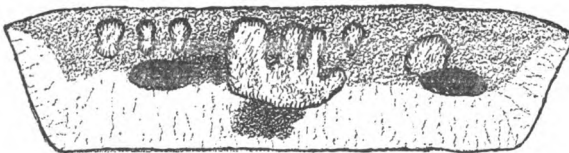

AOB
Dannemora.

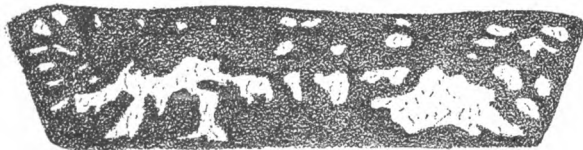

AOB
Dannemora.

FIG. 46.—Fractures of Swedish Pig Irons.

Kortfors. The pigs are cast with deep notches so that they can be broken into pieces about 5 ins. long, 3 ins. wide, and 2 ins. thick. This iron was intended for crucible steel. (Analysis on p. 11.)

A most remarkable example of segregation is shown in Fig. 50. The drawing is the natural thickness of the casting. This iron is from a regular cupola mixture. At the left-hand

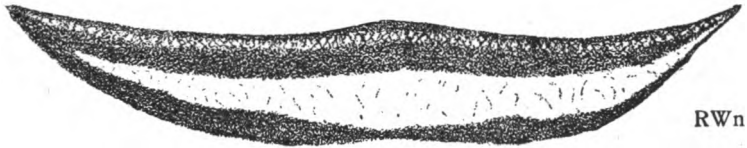

FIG. 47.

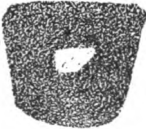

FIG. 48.



FIG. 49.

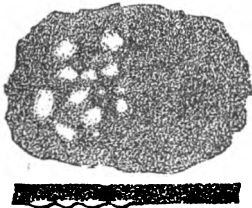

FIG. 52.

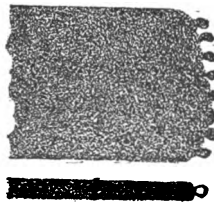

FIG. 53.

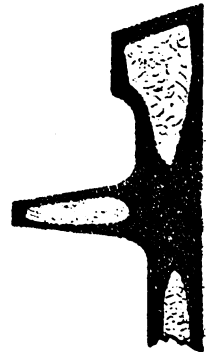

FIG. 51.

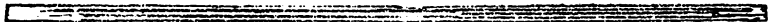

FIG. 50.

portion of the casting there are gray surfaces, then next under each is a white section of about the same thickness, then two gray sections, and at the center another white section, all of equal thickness, making seven distinct strata in a casting $\frac{1}{12}$ of an inch thick. At the right the central white section is again divided making nine strata, five gray and four white. Considering the short time for such a casting to become solid the change of conditions to produce each separate strata must have been nearly instantaneous.

Fig. 51 is a section from the edge of a stove-cover, circular in shape and about 9 ins. in diameter.

The white parts are therefore white rings entirely surrounded by a perfectly soft gray exterior. In the upper part of Table XLVII is given the analysis.

TABLE XLVII.

	T. C.	G. C.	C. C.	Si.	P.	S.	Mn.
Gray, exterior.	3.628	1.874	1.754	2.846	1.00	0.04	0.501
White, interior	3.860	1.307	2.554	2.742	1.00	0.04	0.501
Gray, part.....	3.010	2.480	0.95	0.35	0.90
Gray + white..	2.640	2.470	1.00	0.42	0.91

The analyses below the line are from a segregation (Fig. 52), where white beads were driven down into the mold below the casting. The chemist did not separate all the gray from the white, but made his determination from the gray alone, and then from the gray and white together.

Fig. 53 shows the flat side and edge of a casting which did not run full. Small drops of white iron exuded from the rounded surface of the edge of the casting. It merely suggests a way that the white beads of Fig. 52 may have been formed.

Figs. 54 and 55 show a number of sections of castings, all of true size, showing stratification or segregation in various forms. Figures marked *a* show the fracture at the center and those marked *b* show the end of a test-bar $\frac{1}{2}$ in. \square and 1 ft. long. Those marked *c* are cross-fractures at the center of a bar 1 ft. long with the section shown, the stratification extending nearly or entirely the length of the bar.

Those marked *d* are cross-fractures of a bar $1'' \times \frac{1}{10}'' \times 12''$, run from two gates on one side. No. 208 *d* shows a fracture through the gate, and it would be the same for 209 *e*, and between the gates of 210 *e* and 211 *e*. The drawings 210 *e*, 211 *e*, and 212 *e* show the horizontal structure of these thin test-bars.

SEGREGATION.

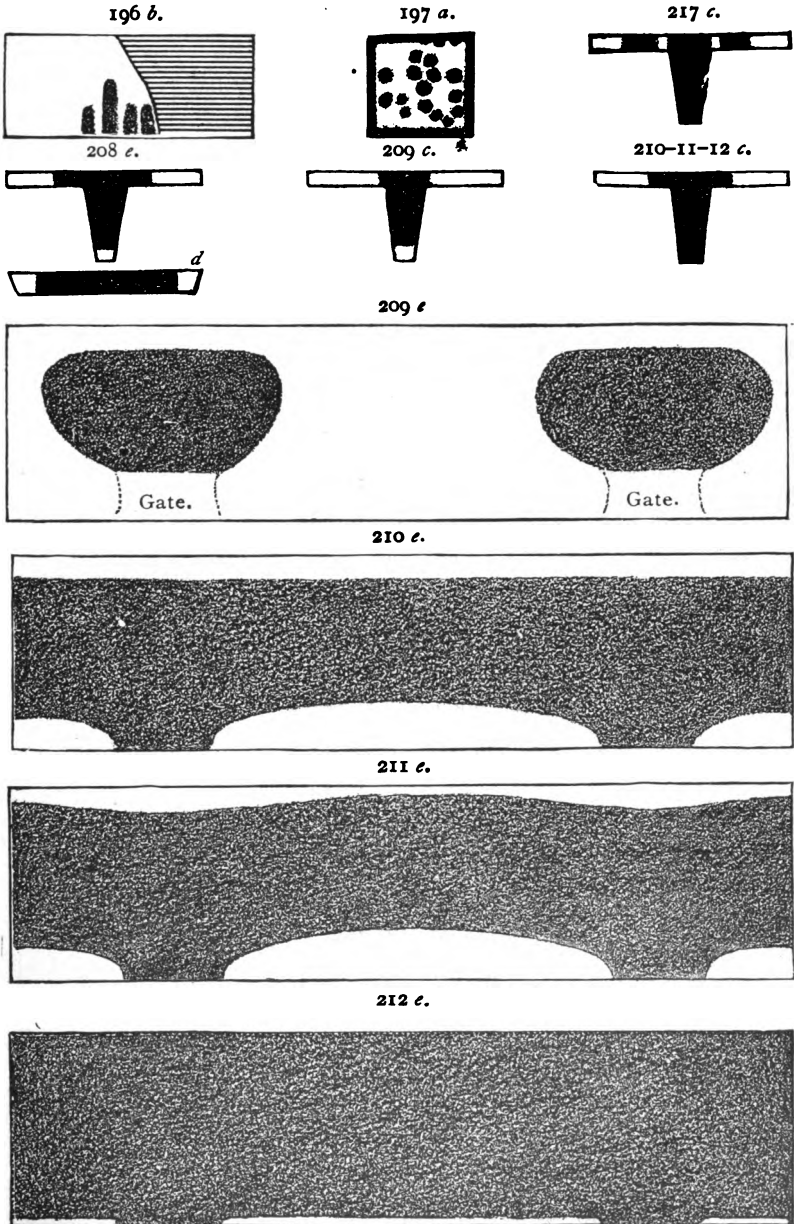

FIG. 54.

In all cases the amount of graphite is shown by the darkness of the fracture.

Test 196 *b* is a fracture of a test-bar containing 1.71% Si., a

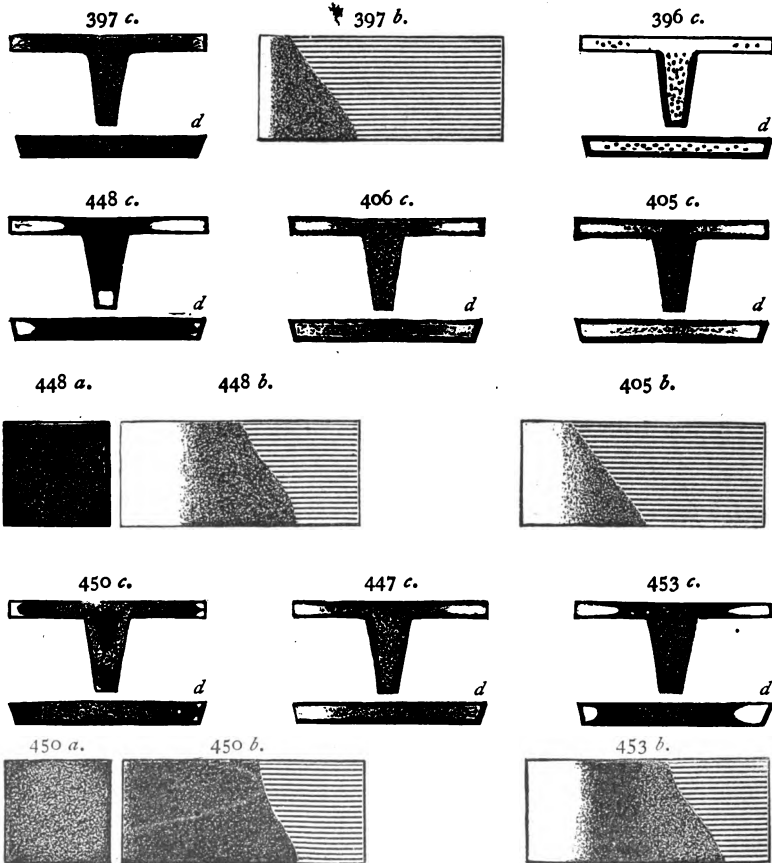

FIG. 55.

mixture of Gaylord white, and 16.32% ferrosilicon; gray pockets extended into the white casting.

Test 197 *a* is the same mixture with 2.82% Si.

4.37% Pencost (Test 397 *c*) shows no tendency to segregate, while the remelt of this same mixture (Test 405 *c*) shows very

marked segregation of a remarkable kind, and exactly the same occurred in the remelt of 6.54% Pencost (Test 406 *c*).

The tests 208 to 212 are a mixture of F^LM with the 16.27% ferrosilicon (Method No. 8).

It is evident from an examination of these analyses and drawings that the occurrence of white spots in castings is not always due to a decrease of silicon, for the silicon is substantially the same in both the gray and the white part of the casting; neither is it due to any increase or decrease in carbon or to the presence of any other element.

For many years such peculiar castings would occasionally appear among our regular castings. All we could find out was that they were made very early in the heat. One day we wanted some test-bars from the first iron and got a white core, but the molder did not know that he did anything out of the regular order. He could not produce the same the next day.

The third day, however, we got the same core, and by watching found that the iron that he used was the first that lay on the sand bottom of the cupola and that it very likely boiled before tapping. It was caught in a fresh ladle and boiled in that, and was changed to another fresh ladle and boiled again. Proceeding in this way we could produce the core when the iron has such a tendency.

Ordinary Commercial Impurities a Benefit.—The irons from which the foregoing examples were made were exceptionally pure, which is an indication that the less the impurities the greater the tendency to segregate.

In ordinary foundry practice such pure iron would not be used and the commercial foundry pig irons do not ordinarily form segregations.

At the right of Fig. 36 *a* (page 75) is a fracture from a test-bar (118) from "Norway" pig which has P. 1.65, S. 0.01, Si. 2.03, Mn. 0.87; which is about as large a percentage of these elements as will often be found, and the grain is absolutely uniform.

In the Swedish exhibit were examples of iron quite high in manganese (Figs. 43 to 45*a*) but otherwise as pure as those already referred to, but these do not segregate.

Chill as Explained by Segregation.—Nearly all who have expressed an opinion on the subject of chill ascribe this phenomenon to a union of silicon and carbon. It is quite certain that the best chilling irons are not those with the lowest silicon. The best chilling irons are charcoal-irons, that is, pure irons with low phosphorus and sulphur.

CHAPTER XIII.

STRENGTH OF CAST IRON.

WHILE a member of the Committee on Testing of the A. S. M. E., the author made nineteen series of tests with silicon varying between 1% and 3.50%.

Records of Tests for Committee A. S. M. E. with all details appear in the Transactions of the American Society of Mechanical Engineers, vol. XVI., 1895, pp. 542 to 568 and 1066 to 1141, also vol. XVII., 1896, pp. 675 to 729. The intended size of pairs of test-bars of each series were $\frac{1}{2}$ " \square , 1" \square , 2" \times 1" and 12" long, 2" \times 1", 1", 2", 3", and 4" square, and 24" long, and round bars $\frac{3}{16}$ ", $\frac{1}{2}$ ", and 1 $\frac{1}{8}$ " diameter. The average strength of each pair of test-bars is given in Tables XLVIII and XLIX.

These test-bars were made in green-sand molds lying flat, and all melting and pouring were exactly as for ordinary work.

When these tests were presented to the society they were so much of a surprise that the committee wished that a parallel set of tests should be made by tension and by compression. This has been done by a committee of the American Foundrymen's Association, with Dr. R. G. Moldenke as chairman.

Record of Tests of Committee A. F. A.—For a series of test-bars the iron was caught in one ladle, then poured into a pool in the foundry floor. At a signal a gate was raised and all molds bedded in the foundry floor at a lower level were filled simultaneously with iron of supposed uniform composition and temperature. This would insure test-bars of the most uniform structure that it was possible to make. All bars were cast on end.

TABLE XLVIII.

AVERAGE MAXIMUM DEAD LOAD (TRANSVERSE) FOR NOMINAL SIZE OF TEST-BARS, A. S. M. E. TESTS.

Iron.	No. Series.	$\frac{3}{4}'' \square \times 12''$	$1'' \square \times 24''$	$2'' \times 1'' \times 24''$	$2'' \square \times 24''$	$3'' \square \times 24''$	$4'' \square \times 24''$	$1'' \square \times 12''$	$1'' \square \times 48''$	$1'' \square \times 54''$	$2'' \times 1'' \times 12''$
		Iroquois (Coke).....	1 2 3 4 422 423 454	282 326 365 422 1,113 454	918 1,883 1,141 1,046 1,962	1,687 6,661 6,853 6,427 7,838	5,062 21,556 17,459 18,035 22,136	24,112 49,201 40,632 46,744 40,247	52,555 1,894 2,369 2,329 555	2,292 1,894 2,369 2,329 555	468 520 481 518 555
Hinkle (Charcoal).....	7 8 9 10 11 12	321 386 316 432 426	972 1,925 985 936 1,108	1,614 1,925 1,665 6,274	6,299 6,419 6,440 6,274	20,791 20,929 17,823 19,363	40,964 51,628 44,114 49,468	3,018 2,146 2,158 1,981	431 469 474 428	414 436 461 468	3,793 3,956 4,066 3,634
Southern.....	14 13 15	359 379 416	1,181 1,080 1,015	1,877 2,137	7,936 7,910 8,272	24,409 22,048 21,661	50,649 50,904 53,357	2,424	611	506	3,858
Foundries.....	19 16 18	358 363 441	1,183 1,024 1,287	2,703 2,066 2,342	8,041 6,789 7,919	30,221 20,882 24,526	65,094 44,217 56,079				
Malleable.....	17	1,297	2,651	12,336	41,968	94,731				

TABLE XLIX.

AVERAGE MAXIMUM LOAD FOR NOMINAL SIZE BAR IN TERMS OF SECTIONS OF TEST-BAR $\frac{3}{4}'' \square \times 12''$ A. S. M. E. TESTS.

Iron.	No. Series.	$\frac{3}{4}'' \square \times 12''$	$1'' \square \times 24''$	$2'' \times 1'' \times 24''$	$2'' \square \times 24''$	$3'' \square \times 24''$	$4'' \square \times 24''$	$1'' \square \times 12''$	$1'' \square \times 48''$	$1'' \square \times 54''$	$3'' \times 1'' \times 12''$
		Iroquois (Coke).....	1 2 3 4 5 6	282 326 365 422 423 454	220 228 285 262 278	211 235 272 228 245	186 208 214 201 205	223 200 162 169 205	205 192 159 183 157	286 237 296 291 277	234 260 259 277
Hinkle (Charcoal).....	7 8 9 10 11 12	321 386 316 432 426	243 262 245 234 259	202 241 208 263	197 201 201 196 190	192 194 165 179 189	150 201 172 193 165	252 268 270 248 256	216 235 237 261	233 249 259 263	235 247 247 223 229 237
Southern.....	14 13 15	359 379 416	295 270 254	235 267	248 247 258	226 204 201	198 199 208	303	305	284	241
Foundries.....	19 16 18	358 364 441	206 256 322	338 258 293	276 212 247	280 193 227	250 173 219				
Malleable.....	17	465	324	331	398	388	370				

Square bars were intended to be $\frac{1}{2}$, 1, $1\frac{1}{2}$, 2, $2\frac{1}{2}$, 3, $3\frac{1}{2}$, and 4 ins. square. Round bars were to be of the same areas, and all 12 ins. between supports. Two lengths and the same shape and sizes of cross-section both \square and \circ were made for tensile tests, using no bars larger than 2 ins. \square or 2.15 ins. diameter.

Other bars of the same sizes were machined down to the next smaller size by cutting $\frac{1}{4}$ in. from each surface, thus a 1-in. \square bar was machined to a bar $\frac{1}{2}$ in. \square .

In tabulating, the $\frac{1}{2}$ in. \square machined section will be placed in the column of the size *that it was cast* (1 in. \square) and the same for other sizes, for the reason that the grain is varied by the size as cast, and therefore comparison can only be made between bars originally cast the same size.

TABLE L.

SERIES E. TRANSVERSE STRENGTH PER SECTION $\frac{1}{2}$ " \square \times 12" LONG.
A. F. A. TESTS.

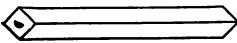
 \square	$\frac{1}{2}$ "	1"	$1\frac{1}{2}$ "	2"	$2\frac{1}{2}$ "	3"	$3\frac{1}{2}$ "	4"
Green sand, not machined	400	384	238	302	330
Dry " " "	410	313	247	274

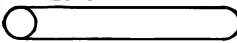
 Diameter \circ	.56"	1.13"	1.69"	2.15"	2.82"	3.38"	3.95"	4.51"
Green sand, not machined	480	290	267	323	354	2.86	289	252
Dry " " "	400	287	242	337	314	3.10	273	320

SERIES D. TRANSVERSE STRENGTH PER SECTION $\frac{1}{2}$ " \square \times 12" LONG.

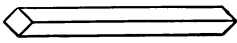
 \square	$\frac{1}{2}$ "	1"	$1\frac{1}{2}$ "	2"	$2\frac{1}{2}$ "	3"	$3\frac{1}{2}$ "	4"
Green sand, not machined	450	3.51	359	348	383	342	283	241
Dry " " "	375	2.91	305	359	391	368	374	370

 Diameter \circ	.56"	1.13"	1.69"	2.15"	2.82"	3.38"	3.95"	4.51"
Green sand, not machined	280	307	440	393	389	389	368	392
Dry " " "	180	277	322	425	352	295	340	363

TABLE L.—Continued.
 SERIES A. TRANSVERSE STRENGTH PER SECTION $\frac{1}{2}$ " \square \times 12" LONG.

	\square	$\frac{1}{2}$ "	1"	1 $\frac{1}{2}$ "	2"	2 $\frac{1}{2}$ "	3"	3 $\frac{1}{2}$ "	4"
Green sand, not machined	308	252	244	218	209	189	171	175	
" " machined		300	204	216	200	187	168	151	
Dry sand, not machined	262	231	222	186	176	151	157	149	
" " machined		265	211	185	174	151	145	135	

	Diameter \circ	.56"	1.13"	1.69"	2.15"	2.82"	3.38"	3.95"	4.51"
Green sand, not machined	445	305	238	218	174	171	170	151	
" " machined		150	235	201	157	153	136	151	
Dry sand, not machined	220	224	218	185	176	156	145	143	
" " machined		160	224	190	142	168	131	135	

SERIES B. TRANSVERSE STRENGTH PER SECTION $\frac{1}{2}$ " \square \times 12" LONG.

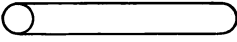
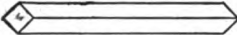
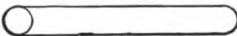
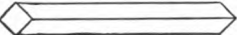
	\square	$\frac{1}{2}$ "	1"	1 $\frac{1}{2}$ "	2"	2 $\frac{1}{2}$ "	3"	3 $\frac{1}{2}$ "	4"
Green sand, not machined	375	295	296	243	233	212	202	195	
" " machined		260	280	241	248	225	209	189	
Dry sand, not machined	295	310	270	252	231	221	214	194	
" " machined		210	251	231	244	214	195	180	

	Diameter \circ	.56"	1.13"	1.69"	2.15"	2.82"	3.38"	3.95"	4.51"
Green sand, not machined	223	288	262	247	252	223	214	195	
" " machined		230	264	227	173	193	191	190	
Dry sand, not machined	192	303	288	241	250	222	214	196	
" " machined		225	223	220	172	192	181	184	

SERIES C. TRANSVERSE STRENGTH PER SECTION $\frac{1}{2}$ " \square \times 12" LONG.

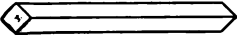
	\square	$\frac{1}{2}$ "	1"	1 $\frac{1}{2}$ "	2"	2 $\frac{1}{2}$ "	3"	3 $\frac{1}{2}$ "	4"
Green sand, not machined	360	272	252	263	223	216	211	202	
" " machined		705	279	257	234	231	224	193	
Dry sand, not machined	380	290	290	252	228	214	208	199	
" " machined		660	270	246	232	227	211	177	

	Diameter \circ	.56"	1.13"	1.69"	2.15"	2.82"	3.38"	3.95"	4.15"
Green sand, not machined	365	290	257	255	248	232	210	204	
" " machined		320	279	251	195	214	200	212	
Dry sand, not machined	342	308	275	240	243	237	211	205	
" " machined		275	303	222	198	213	199	197	

Instead of comparing the measured strengths of each test-bar and to assist in making comparisons, Tables XLIX and L give the average measured strength of a section of each test-bar $\frac{1}{2}$ " \square \times 12" long. (Formula $W_1 = \frac{Wb_1h_1^2l}{bh^2l_1}$, where the plain letters are for the measured test-bar, the letters sub. one are for the other size.)

TABLE LI.

CHEMICAL ANALYSES OF TEST-BARS 1" \square CAST IN DRY SAND. A. F. A.

Series.	Total Carbon.	Graphitic Carbon.	Combined Carbon.	Silicon.	Phosphorus	Sulphur.	Manganese.
E	3.04	0	3.04	0.72	0.45	0.07	0.17
D	2.36	0.06	2.30	0.25	0.48	0.07	0.15
A	3.87	3.44	0.43	1.67	0.95	0.03	0.29
B	3.82	3.23	0.59	1.95	0.41	0.04	0.39
C	3.84	3.52	0.32	2.04	0.58	0.04	0.39

It is unfortunate that only one test-bar in each series of A. F. A. tests was analyzed, and that no analysis of the pig irons entering into the composition was made. Fig. 56 is the average measured strength of a section $\frac{1}{2}$ " \square \times 12" long of each size of test-bar from $\frac{1}{2}$ " \square \times 4" \square A. S. M. E. Series 1 to 6, as given in Table XLIX.

Fig. 57 is the record of Fig. 56 with the curves made regular, i.e. the influences which caused the variations in the different sizes of bars have been eliminated, but the general conditions which influenced each series as a whole are left unchanged.

Referring to the records given in this chapter and especially Fig. 82, page 160: *Strength generally increases with each increase of silicon (up to 3%), in the bars which were cast $\frac{1}{2}$ in. \square .*

An increase of silicon diminishes the combined carbon and removes brittleness and thus increases strength.

Strength does not follow a variation in silicon, but it is foundry experience that *the lower the silicon the weaker the small castings, and the stronger the large castings and the higher the*

silicon (up to 3%), the stronger the small castings and the weaker the larger castings. For large castings therefore it is the practice to use the least silicon that will produce the requisite softness.

Referring to Fig. 57 (and more especially Fig. 82), by following the curve which represents the strength of the different sizes

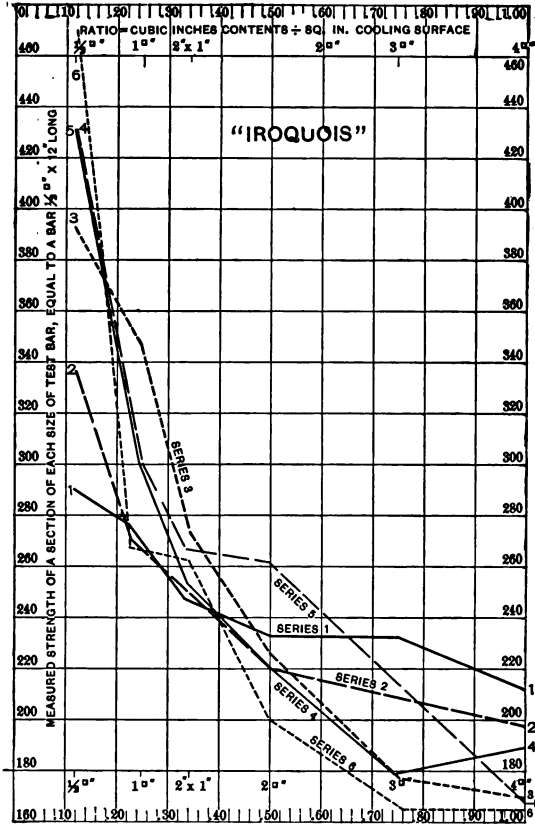

FIG. 56.—A. S. M. E. Tests as Measured.

of test-bars made from one mixture of iron, we see that with castings poured from the same iron:

Strength of a 1/2 in. □ section of each test-bar decreases as the size of the casting increases.

This is because under ordinary conditions large castings cool

more slowly than small castings. Slow cooling gives time for the grains to become larger than when the casting cools rapidly.

Referring again to any one of the curves in Fig. 82 we see that,

Strength of a $\frac{1}{2}$ in. \square section of each test-bar decreases more

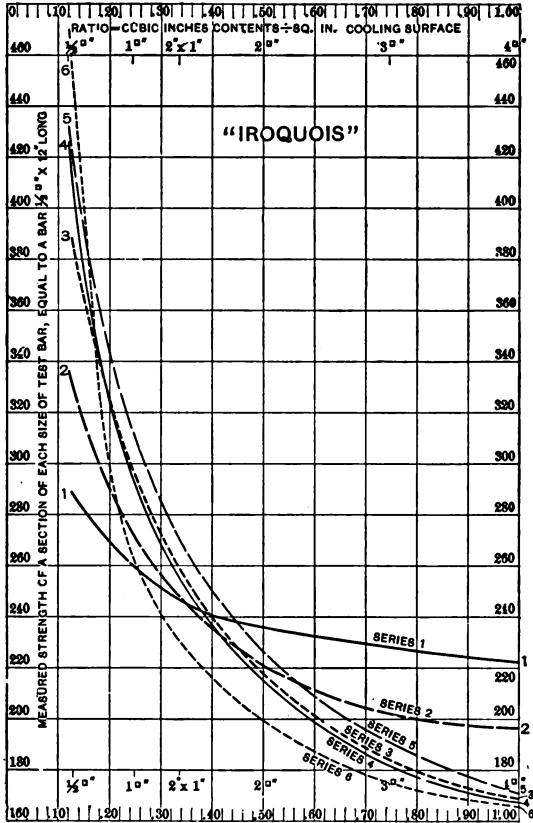

FIG. 57.—Curves of Fig. 56 made uniform.

rapidly with each increase in size near the $\frac{1}{2}$ in. \square end of the series than near the 4 in. \square end.

Also, Decrease in strength due to each increase in size of a casting is greater and more rapid with each increase of silicon.

In Fig. 57 the curve from iron containing 1% of silicon begins

lowest and ends highest. With increase of silicon the curve begins higher and ends lower than curves from iron with lower silicon.

The slower cooling of each larger casting causes each curve to drop quickly at first and less rapidly as the castings increase in size. An increase in silicon causes a more rapid drop throughout. It is in accordance with shop experience and general opinion that an increase in silicon weakens large castings. The fact that small castings grow stronger with each increase in silicon (at least up towards 3%) does not seem to have been noticed, probably because, until the introduction of a ½-in. □ test-bar, a 1-in. □ test-bar was the smallest in general use.

TABLE LII.
TENSILE TEST.

Position of Test-bar in a Casting 9" □ × 18" Long.	Load per □"	
Corner of casting	16,450	Total carbon 2.84 per cent Graphite " .60 " " Combined " 2.24 " " Silicon 1.10 " " Phosphorus .34 " " Sulphur09 " " Manganese . . .49 " "
Side " "	15,406	
Middle " "	13,750	
Corner of casting	24,600	
" " "	25,000	
" " "	25,400	
" " "	25,400	
Side " "	19,700	
" " "	19,850	
" " "	20,200	
Middle " "	15,730	

The center of a casting has a coarser grain and is weaker than the surface of a casting. This is shown by Table LII, giving the strength of two sets of eight bars which were cut from different portions of two castings, also by the compression tests of Table LVII of ½-in. cubes cut from the surface and from the center of square test-bars, therefore,

Removing the surface of a test-bar or casting diminishes its strength per unit of cross-section.

Table LIII proves the following proposition :

Casting test-bars in horizontal molds gives more even strength and more uniform size than in vertical molds. (See also Table LXIII, p. 136.)

The A. F. A. bars were all cast on end, while the A. S. M. E. bars were cast flat. These two series of records can only be compared by finding the ratio of variation in size and strength. The bars were supposed to be the size of the pattern. The ratio of variation would therefore be the difference between the size as cast and the intended size, divided by the intended size.

TABLE LIII.

PERCENTAGE OF VARIATION IN SIZE OF □ BARS IN GREEN SAND.

Size of Test-bars Averaged.		½" □	1" □	2" □	3" □	4" □	Average.
A. S. M. E.	Number of bars averaged.....	120	37	38	38	38	271
"	Percentage of variation.....	2.62	6.70	4.70	4.10	2.66	4.16
A. F. A.	Percentage of variation.....	21.20	7.85	3.50	1.77	2.49	7.36
"	Number of bars averaged.....	14	8	8	8	8	46

PERCENTAGE IN VARIATION IN STRENGTH OF □ BARS IN GREEN SAND.

Size of Test-bars Averaged.		½" □	1" □	2" □	3" □	4" □	Average.
A. S. M. E.	Number of bars averaged.....	120	34	38	38	38	268
"	Percentage of variation.....	7.50	5.58	4.52	5.06	4.29	5.34
A. F. A.	Percentage of variation.....	15.99	13.96	4.06	4.32	4.55	8.57
"	Number of bars averaged.....	12	6	6	6	6	32

The ratio of variation in strength is found by finding the difference between the breaking load of the companion bars of each size and dividing by their average strength.

One reason for such a large percentage of variation in strength of the A. F. A. tests of ½-in. and 1-in. test-bars was that they used a 100,000-lb. tensile testing-machine, while the committee of A. S. M. E. used very sensitive transverse machines.

Tables LIV and LV give the average percentage of variation in strength of each size of test-bars of each size of A. F. A. bars.

These include unmachined and machined bars tested transversely and by tension.

The recorded strength of all unmachined bars tested transversely is the strength as actually measured, and the size of test-bar was in nearly every case slightly larger than intended.

All machined bars were the exact intended size. The strengths of unmachined tension-bars were reduced to strength per square inch. The average per cent variation of these bars is therefore not due to variation in size, but to the inherent quality of the material.

The variation in strength is as great in test-bars machined to exact size, or in tensile bars per square inch, as that of unmachined bars of the measured sizes.

TABLE LIV.
 AVERAGE PERCENTAGE OF VARIATION IN TRANSVERSE STRENGTH,
 A. F. A. TESTS.

	½"□	1"□	1½"□	2"□	2½"□	3"□	3½"□	4"□	Gen. Av.
SERIES A, B, C.									
Green sand bars, not machined.....	15.99	13.96	4.65	4.06	5.68	4.32	3.72	4.55	7.12
" " " machined.....		7.15	12.43	2.73	4.77	2.87	5.98	4.95	5.84
SERIES A, B, C.									
Dry sand bars, not machined.....	14.11	8.90	3.65	1.07	5.50	3.26	2.10	.85	4.93
" " " machined.....		5.44	1.95	3.98	3.62	5.50	4.27	1.81	3.79
SERIES D, E.									
Dry sand bars, not machined.....	4.00	3.42	8.05	20.39	3.48	13.58	3.53	4.02	7.06

	0.56"○	1.13"○	1.69"○	2.15"○	2.82"○	3.38"○	3.95"○	4.51"○	
SERIES A, B, C.									
Green sand bars, not machined....	11.31	14.24	7.22	4.36	4.00	2.70	7.59	3.29	6.84
" " " machined.....		3.12	4.47	3.34	1.02	3.24	1.63	4.05	2.98
SERIES A, B, C.									
Dry sand bars, not machined.....	9.47	9.90	5.81	2.49	2.64	1.88	4.69	2.04	4.86
" " " machined.....		5.65	4.68	6.17	1.89	2.09	1.26	2.05	3.40
SERIES D, E.									
Dry sand bars, not machined.....		10.99	13.63	19.23	5.99	4.47	3.48	8.18	8.25
Average of all □ test-bars.....									
" " " " " " " " " " " "	11.37	7.77	6.15	6.45	4.61	5.91	3.92	3.24	5.75
" " " " " " " " " " " "	9.63	8.78	7.16	7.12	3.11	2.88	3.73	3.92	5.27



The variation in strength to be provided for in ordinary castings is at least 50%. The average of all the bars of the A. S. M. E. series is 5.48%, and the widest variation is 20%; the average of the five A. F. A. series was 8.64%, and the widest is 26%.

In all of these castings the greatest care was taken to have the castings uniform, and each test-bar was tested, while the

castings of commerce often contain concealed flaws that only a test would reveal.

TABLE LV.

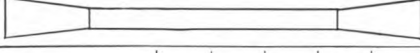
AVERAGE PERCENTAGE OF VARIATION IN TENSILE STRENGTH, A. F. A. TESTS.

											Total Average.
	½" □	1" □	1½" □	2" □	Av.	½" ○	1" ○	1½" ○	2" ○	Av.	
SERIES A, B, C.											
Green sand, not machined	7.27	5.08	6.30	6.61	6.31	5.99	5.42	5.16	4.19	5.19	5.75
" " machined....	10.55	5.48	16.42	10.82	9.22	12.17	13.58	11.66	11.24
SERIES A, B, C.											
Dry sand, not machined.	6.78	2.18	8.69	4.17	5.45	4.97	4.11	12.47	2.63	6.04	5.74
" " machined....	8.14	4.29	6.56	6.33	5.46	10.78	9.61	8.28	7.31
	0.56" ○	1.13" ○	1.69" ○	2.15" ○	Average.	0.56" ○	1.13" ○	1.69" ○	2.15" ○	Average.	Total Average.
SERIES A, B, C.											
Green sand, not machined	6.56	3.37	5.45	5.40	5.19	9.33	3.08	6.66	7.16	6.56	5.87
" " machined....	4.73	6.03	5.32	5.03	12.34	7.12	13.89	11.12	8.07
SERIES A, B, C.											
Dry sand, not machined..	7.31	6.42	4.25	3.26	5.28	7.61	4.10	16.03	3.80	7.88	6.08
" " machined.	4.06	10.08	5.75	6.63	13.00	12.10	12.26	12.46	9.54
Average of all □ bars..	7.02	6.49	6.19	8.44	7.23	5.48	6.05	10.14	7.50	7.79	7.76
" " ○ bars..	6.88	4.64	6.45	4.93	5.53	8.47	8.13	10.48	9.28	9.50	7.39

It is quite surprising that the A. S. M. E. test-bars, molded and cast flat and poured from various ladles with iron caught from the cupola in the usual way, should not vary as much in size and strength as with the A. F. A. test-bars molded and poured with every precaution to insure uniformity.

The variation in strength is due to the natural uneven structure of cast iron, and not in any great degree to varying temperature of iron entering a mold, or to varying chemical constitution, or to the character of the mold.

The strength of any size of casting cannot be calculated by any mathematical formula from data obtained from testing a test-bar of another size. (The ordinary formula is given just before Table LI, page 119.)

A record obtained by a mathematical formula from the test of

a bar of any single size would give the same strength for a given unit of section for a large as for a small bar, and the graphic record would be a straight horizontal line. The formula would give for small castings too small a strength, and for large castings too great a strength.

TABLE LVI.
TENSILE STRENGTH PER □ INCH OF AREA A. P. A. TESTS.



SERIES A.				SERIES B.				
Side of square	½" □	1" □	1½" □	2" □	½" □	1" □	1½" □	2" □
Green sand, not machined..	15,857	13,930	12,140	10,650	15,575	13,245	11,525	10,225
" " machined.....	15,420	12,940	10,945	14,920	13,525	11,530
Dry " not machined...	14,840	12,950	12,285	9,795	15,872	13,075	12,000	10,550
" " machined.....	13,840	13,420	12,124	12,480	12,990	11,255
Diam.	0.56" ○	1.13" ○	1.69" ○	2.15" ○	0.56" ○	1.13" ○	1.69" ○	2.15" ○
Green sand, not machined..	16,015	13,770	12,520	11,065	14,962	12,785	11,860	10,675
" " machined.....	13,760	13,490	12,230	13,980	12,405	10,715
Dry " not machined...	14,277	13,725	11,685	10,530	15,622	13,220	11,485	10,140
" " machined.....	13,600	13,225	10,615	13,400	12,795	10,950
SERIES B.				SERIES C.				
Side.	½" □	1" □	1½" □	2" □	½" □	1" □	1½" □	2" □
Green sand, not machined..	17,100	15,155	12,870	11,460	16,295	14,970	13,315	10,515
" " machined.....	17,620	15,005	12,780	17,780	14,970	12,150
Dry " not machined...	16,310	15,090	13,290	11,135	15,715	15,123	11,740	11,370
" " machined.....	18,420	14,935	12,105	16,180	14,135	12,100
Diam.	0.56" ○	1.13" ○	1.69" ○	2.15" ○	0.56" ○	1.13" ○	1.69" ○	2.15" ○
Green sand, not machined..	16,537	15,865	13,115	11,405	16,210	14,815	13,705	11,335
" " machined.....	17,000	15,375	12,535	18,040	13,870	13,750
Dry " not machined...	16,730	16,160	13,160	11,010	16,830	16,260	14,170	11,090
" " machined.....	16,860	15,090	13,115	17,340	14,855	13,245
SERIES C.				SERIES D.				
Side.	½" □	1" □	1½" □	2" □	½" □	1" □	1½" □	2" □
Green sand, not machined..	17,702	16,020	12,520	11,055	16,430	15,970	11,665	10,765
" " machined.....	18,460	15,130	11,670	17,640	14,020	10,595
Dry " not machined...	16,352	16,020	12,170	11,315	16,772	15,785	12,760	10,890
" " machined.....	17,080	14,125	9,770	17,100	13,390	12,885
Diam.	0.56" ○	1.13" ○	1.69" ○	2.15" ○	0.56" ○	1.13" ○	1.69" ○	2.15" ○
Green sand, not machined..	17,830	15,865	14,170	12,030	17,275	16,535	14,410	11,810
" " machined.....	17,380	14,990	11,570	17,540	15,690	12,215
Dry " not machined...	16,402	15,930	14,045	11,500	17,850	10,000	12,705	10,970
" " machined.....	17,720	15,850	10,430	18,460	14,925	10,230

A glance at the graphic records, Fig. 57, shows how far from the actual strength such a record would be.

When these results were made known in 1895, they were so at variance with general opinion that the question arose whether the

same results would be obtained by tensile tests. It was questioned whether the peculiar-shaped curves of Fig. 82 were not due to applying the ordinary formula to transverse tests to obtain the strength of a $\frac{1}{2}$ -in. \square section of each size of test-bar.

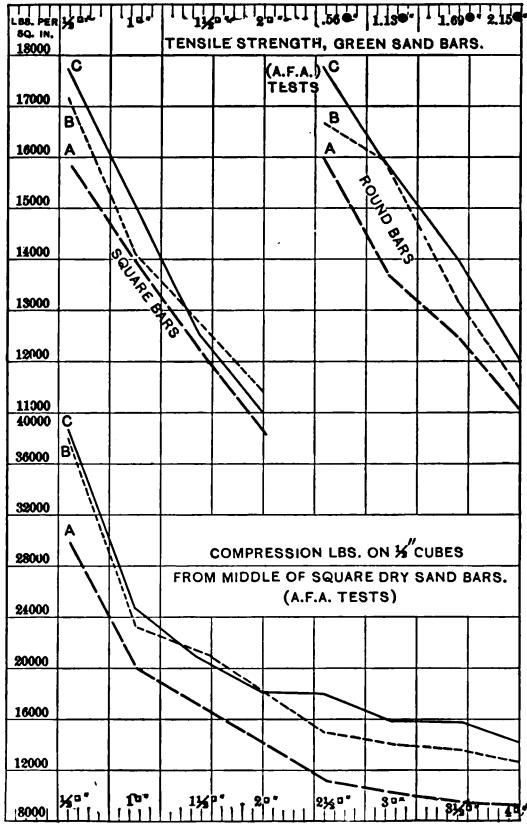

FIG. 58.—A. F. A. Tensile and Compression Tests make the same Character of Curves as A. S. M. E. Tests.

The committee of A. F. A. have in Table LVI supplied exactly what was wanted in their complete set of tensile tests of \square and \circ bars varying in size from $\frac{1}{4}$ sq. in. area to 4 sq. ins. area of cross-section, and they have used two forms of tensile test-bars. Plotting the results we have the upper part of Fig. 58,

exactly the same kind of diagrams as produced from transverse tests. Calculating the strength of one size of tensile bar from the strength of another size is by a simple proportion, but observing the decrease in the tensile strength per square inch of bars of greater area on account of slow cooling, it is seen that the proposition is proven that the strength of a casting cast one size cannot be calculated from another casting cast another size by any formula.

Compression Tests, Table LVII, by the committee of A. F. A. prove the same thing. Cubes with $\frac{1}{2}$ in. \square sides were cut from the square bars cast in dry sand of Series A, B, and C.

One cube was taken from the surface of each bar equidistant from the corners, another cube was taken $\frac{1}{2}$ in. nearer the center of each of the bars, and so on. The results are given in Table LVII. One cube was always taken from the exact center. At the bottom of Fig. 58 these plotted results show the same-shaped diagrams as in Fig. 57.

TABLE LVII.

COMPRESSION TESTS A. F. A. OF $\frac{1}{2}$ " CUBES FROM EACH OF DRY SAND \square BARS.

	Distance from Surface.	$\frac{1}{2}$ " \square	1" \square	1 $\frac{1}{2}$ " \square	2" \square	2 $\frac{1}{2}$ " \square	3" \square	3 $\frac{1}{2}$ " \square	4" \square
Series A.	First	29,570	21,990	17,920	13,750	12,040	11,200	10,770	10,340
	Second	17,180	13,880	11,430	10,270	9,830	9,950
	Third	10,950	10,430	9,540	9,570
	Fourth	9,350	9,350
	Center	29,570	20,010	17,180	13,810	10,950	9,830	9,350	9,100
Series B.	First	38,360	27,440	24,820	21,640	18,270	17,000	15,970	16,140
	Second	20,980	18,740	15,940	14,410	15,200	13,950
	Third	15,060	13,900	13,560	13,760
	Fourth	13,160	12,830
	Center	38,360	23,000	20,980	18,130	15,060	13,790	13,160	12,430
Series C.	First	38,500	27,900	22,060	21,750	19,800	18,170	17,100	16,410
	Second	20,750	19,340	18,050	16,850	16,510	15,250
	Third	17,840	16,040	16,080	14,880
	Fourth	15,880	14,200
	Center	38,500	24,890	20,750	18,010	17,840	15,950	15,830	14,220

Stronger castings are made in green-sand than in dry-sand molds, because castings cool slower in a dry mold. See Table LIV.

Square test-bars are stronger than round test-bars with equal areas of cross-section, shown by Tables LVIII and LIX.

TABLE LVIII.

AVERAGE TRANSVERSE STRENGTH OF □ AND ○ TEST-BARS, A. S. M. E. TESTS.

	$\frac{1}{2}'' \square \times 12''$	$.56'' \circ \times 12''$	$\frac{1'' \square \times 24''}{\text{reduced to } 1'' \square \times 12''}$	$1.13'' \circ \times 12''$
Average of 38 bars; 2 each of the 19 series.....	401	362	2361	2107

TABLE LIX.

AVERAGE TRANSVERSE STRENGTH OF $\frac{1}{4}''$ □ AND ○ SECTIONS OF ALL □ AND ○ BARS, A. F. A.

	$\frac{1}{4}'' \square$	$1'' \square$	$1\frac{1}{2}'' \square$	$2'' \square$	$2\frac{1}{2}'' \square$	$3'' \square$	$3\frac{1}{2}'' \square$	$4'' \square$
Averages of all □ bars.....	363	336	280	258	272	242	242	239
	$.56'' \circ$	$1.13'' \circ$	$1.69'' \circ$	$2.15'' \circ$	$2.82'' \circ$	$3.38'' \circ$	$3.95'' \circ$	$4.51'' \circ$
Averages of all ○ bars.....	313	267	281	283	261	247	222	220
Diff. + in favor of □ bars....	+ 50	+ 69	- 1	+ 25	+ 11	- 5	+ 20	+ 19

AVERAGES OF TENSILE STRENGTHS OF □ AND ○ BARS, A. F. A. TESTS.

	$\frac{1}{4}'' \square$	$1'' \square$	$1\frac{1}{2}'' \square$	$2'' \square$	$\frac{1}{4}'' \circ$	$1'' \circ$	$1\frac{1}{2}'' \circ$	$2'' \circ$
Averages of all □ bars.....	16,360	15,834	13,403	11,234	16,109	15,531	13,003	11,219
	$.56'' \circ$	$1.13'' \circ$	$1.69'' \circ$	$2.15'' \circ$	$.56'' \circ$	$1.13'' \circ$	$1.69'' \circ$	$2.15'' \circ$
Averages of all ○ bars.....	16,173	15,803	13,894	11,510	16,410	15,697	13,573	11,427
Diff. + in favor of □ bars....	+ 187	+ 31	- 491	- 276	- 291	- 166	- 570	- 208

The difference is not great, but the average shows in favor of the square bar. This shows that practically the grain of one is as uniform as the other, and it is fortunate that it is so, because the rectangular shape is more common than the round for ordinary castings, but it is well known that all corners of a pattern should be rounded and all reentrant angles should be as round as possible.

A committee appointed to report to the Western Foundry Association, Nov. 21, 1894,* as to whether a round test-bar cast

* The Iron Trade Review, Nov. 29, 1894.

on end was better than a square bar cast flat, reported that in one group of tests, all square bars cast flat were perfect, while 43% of the round bars cast on end were defective. In another group of tests, 18% of the square bars cast flat were defective, and 54% of the round bars cast on end were defective. The committee reported that they could not endorse the round bar cast on end as against the square bar cast flat.

During 1894 Mr. West made a large number of tests with round bars cast on end and square bars cast flat.* The results exhibited the same differences in favor of the square bar as above stated.

Test-bars 2" × 1" × 36" cast flat and tested flat, and also on edge.—The test-bar 2" × 1", tested with the wide side down,

TABLE LX.

A. S. M. E. TESTS.

Kind of Iron.	No. Test-bar.	Size of Test-bar, 2"×1"×36".				Shearing Stress per □"	Modulus of Elasticity.	Resilience.	
		Breadth	Height.	Max. Load in Lbs.	Deflection in Inches.				Stress per □" in Outer Fibre.
Series 18. Bement, Miles & Co., Philadelphia, Pa.	TESTED NARROW SIDE DOWN.								
	359	1.02	2.00	2,800	.295	37,057	686	15,000,000	413
	366	1.01	1.98	3,000	.355	40,915	750	14,900,000	533
	367	1.01	1.98	3,020	.350	41,173	754	14,900,000	431
	358	1.00	1.99	3,028	.386	41,300	767	16,500,000	637
	364	.99	1.96	3,054	.416	43,000	786	16,000,000	635
	361	1.00	2.00	3,056	.433	41,254	764	14,900,000	662
	369	1.00	1.99	3,100	42,300			
	372	1.04	2.00	3,950	.380	51,400	968	17,304,000	750
	Av'ge	3,251	.377	42,299	782	15,643,428	580
	TESTED WIDE SIDE DOWN.								
	363	1.97	.99	1,342	.623	37,600	345	16,000,000	418
	357	1.98	1.01	1,404	.604	38,400	352	15,200,000	422
	368	2.00	1.00	1,438	.555	38,842	359	14,100,000	399
	365	1.98	1.02	1,480	.750	38,800	282	14,500,000	560
	370	1.99	1.01	1,541	.655	41,100	380	14,000,000	500
	371	2.00	1.00	1,570	.470	42,300	392	17,900,000	370
	362	1.97	1.03	1,578	.750	40,800	287	11,700,000	592
	360	2.00	1.01	1,620	.720	42,800	401	14,900,000	583
	Av'ge	1,497	.556	40,042	349	14,780,000	480

* The Iron Trade Review, Nov. 1, 1894.

has been adopted by the Water-works Association as a test for cast-iron water-pipes. In England this test-bar is in common use and is 36 ins. long. It is there tested with the narrow side down.

The bars (Table LX) were all poured from the same ladle of iron. The averages of actual loads, of bars tested with narrow side down, show nearly three times as great strength as when tested flat. The showing is much better for the founder. The majority of people would not be aware that simply turning the bar edgewise would give nearly three times as high a strength per square inch, but would give credit to the iron. This probably accounts for this size being so generally used in England.

Methods for Producing the Strongest Castings.—This resolves itself into methods for producing a close, strongly interlocked grain free from brittleness.

Using an Iron with Low Silicon for Large Castings.—The slow cooling removes brittleness and makes the casting as soft as required and leaves the grain close.

Using Irons with Higher Silicon which Naturally have a Close Grain.—By this method softer castings are produced and both small and large castings can often be made from the same iron.

By the use of test-bars it will be found that a change of mixture can be made that will very greatly increase strength by using a different proportion of the same irons.

Wrought-iron Borings or Chips put into the cupola along with the pig iron will add strength.

Cast-iron Chips or Turnings Charged in Boxes along with the Pig Iron is very effective to close the grain and will to a great extent prevent spongy cavities at enlarged parts of the casting.

To use cast-iron borings, make boxes from 1-in. cull lumber about 6 ins. deep that will hold 100 lbs. Fill these boxes with clean borings as they are removed from the shop, nail the covers on, and pile each box in a dry place near the cupola. Begin by using 100 lbs. of borings to 1000 lbs. of all other iron charged

and increase as found desirable. Keep wrought-iron borings in separate boxes.

TABLE LXI.

A. S. M. E. TESTS.

	Series.	Per Cent of Total Carbon.						Average per cent.
		$\frac{1}{2}$ " □	1" □	1" × 2"	2" □	3" □	4" □	
Iroquois.....	1	3.82	3.85	3.88	3.88	3.81	3.83	3.845
	2	3.90	3.86	3.83	3.89	3.86	3.91	3.875
	3	3.69	3.73	3.74	3.77	3.70	3.68	3.718
		3.55	3.72	3.70	3.77	3.71	3.75	3.700
		3.54	3.56	3.54	3.58	3.48	3.52	3.553
		3.38	3.46	3.38	3.39	3.30	3.31	3.370
Hinkle.....	7	4.02	4.01	4.01	3.95	4.00	4.01	4.000
	8	3.84	3.88	3.83	3.78	3.83	3.84	3.833
	9	3.81	3.89	3.86	3.92	3.82	3.83	3.855
	10	3.20	3.23	3.29	3.21	3.24	3.27	3.240
	11	3.32	3.34	3.31	3.34	3.36	3.31	3.330
	12	3.34	3.37	3.33	3.35	3.37	3.30	3.343
Southern.....	14	3.15	3.23	3.27	3.27	3.23	3.28	3.335
	13	3.14	3.16	3.16	3.15	3.11	3.15	3.145
	15	3.13	3.10	3.16	3.15	3.15	3.19	3.146
C. G. Bretting & Co....	16	3.79	3.88	3.81	3.81	3.80	3.75	3.806
Mich. Mall. Iron Co....	17	3.11	3.06	3.10	3.06	3.085
Bement, Miles & Co....	18	3.35	3.35	3.42	3.30	3.23	3.31	3.326
A. Whitney & Sons	19	3.74	3.85	3.79	3.81	3.89	3.86	3.823

Total Carbon.—The series made for the A. S. M. E., Table LXI, do not present enough data to form any conclusions. The only way to make comparisons is to compare series containing exactly the same silicon, and otherwise substantially having the same chemical composition. Then it would take a large number of tests to prove anything, for any influence that would cause the grain to be close would increase strength independently of chemical composition, and *vice versa*. It is very difficult to make experiments on carbon in cast iron and preserve uniformity in the rest of the composition. It will not answer to add wrought scrap, for this will not only decrease carbon, but at the same time would decrease the percentage of every other element; and also

because such scrap will close the grain and increase strength, independently of the lessening of carbon.

TABLE LXII.

A. S. M. E. TESTS.

	Series.	Per Cent of Combined Carbon.					
		$\frac{1}{2}$ " □	1" □	1" × 2"	2" □	3" □	4" □
Iroquois.....	1	1.46	1.25	1.05	.80	.76	.70
	2	.70	.54	.59	.56	.54	.60
	3	.48	.45	.42	.37	.34	.13
	4	.45	.48	.43	.36	.11	.50
	5	.35	.16	.20	.11	.10	
	6	.37	.38	.30	.15	.11	.08
Hinkle.....	7	1.24	.88	.72	.53	.52	.46
	8	.67	.44	.50	.49	.46	.42
	9	.53	.42	.50	.46	.15	.11
	10	.29	.36	.43	.37	.44	.45
	11	.32	.12	.09	.09	.08	.08
	12	.27	.09	.09	.09	.09	.09
Southern.....	14	.26	.15	.14	.09	.09	.08
	13	.11	.10	.09	.08	.07	.07
	15	.10	.09	.09	.09	.11	.08
C. G. Bretting & Co....	16	.49	.78	.73	.49	.58	.44
Mich. Mall. Iron Co....	17	2.85	2.78	1.20	1.20
Bement, Miles & Co....	18	.45	.52	.50	.24	.12	.11
A. Whitney & Sons....	19	2.95	.99	.81	.81	.87	.89

Combined Carbon.—This must have been uniformly diffused in the molten metal, to have produced such a uniform variation in the test-bars.

It is the universal opinion that strength is mainly due to the combined carbon which the castings contain, and that weakness is caused by changing it into graphite, which is supposed to mechanically separate the grains.

This opinion originated with the makers of heavy castings, who in making strong castings invariably used irons with high combined carbon, which is always an accompaniment of low silicon, and produces a close grain, and for this last reason gives great strength in a large casting. For example, an 8-ton anvil-

block was made from white pig iron which contained about one half of 1% of silicon, with the carbon nearly all combined. This made a very strong, fine-grained gray casting. Series 17 made white castings in the $\frac{1}{2}$ in. \square , 1 in. \square , and 1" \times 2" test-bars, but the 2-in. \square , 3-in. \square , and 4-in. \square bars were very close-grained gray castings, and of extraordinary strength. "Iroquois," with combined carbon 1.46% in the $\frac{1}{2}$ -in. \square bar, produced a stronger 4-in. \square bar than any other of the six "Iroquois" mixtures, with less combined carbon. Viewing the subject of strength and of combined carbon in the light of chemical analyses alone, no other conclusion could be drawn. But if the whole nineteen series of test-bars are examined, we shall see that combined carbon weakens castings, and never strengthens them.

We shall proceed to prove, from these same series from which we have shown how the accepted opinion was obtained, that the decrease in strength of large castings is wholly due to loosely united crystals, and not to any change in the proportion of combined or graphitic carbon.

Combined Carbon weakens Cast Iron.—In each of the charts we see in the $\frac{1}{2}$ -in. \square test-bars, that with each increase of silicon the combined carbon is decreased, and that the strength is increased in the same proportion. In the $\frac{1}{2}$ -in. \square test-bars of each series containing about 1% of silicon, the combined carbon was about 1.50%, and the iron was weak because it was brittle. As combined carbon decreased in the $\frac{1}{2}$ -in. \square bars with each addition of silicon, the brittleness decreased. This is shown strikingly in Series 14, 13, and 15.

Combined carbon may decrease as castings are larger, but the strength always decreases. This decrease of combined carbon and of strength are both caused by the slow cooling, and the decrease of combined carbon has nothing to do with the decrease of strength.

"Iroquois," Series 1, had 1.46% of Cd. C. in the $\frac{1}{2}$ -in. \square bar, which was about one half white, and Cd. C. decreased in the other sizes to 1.25, 1.05, 0.80, 0.76, and 0.70. In this case strength decreased exactly as Cd. carbon decreased (silicon and

other chemical elements were practically uniform in each size), and as a chemist would look at it, it would appear that there could be no other reason for decrease in strength than the decrease in combined carbon, for this is the only chemical variable.

The fact is, however, the lessening of the combined carbon made the 1-in. □ test-bar gray, and each successive decrease of Cd.C. darkened the color and made the casting more ductile; in other words, slow cooling has done for the larger sizes of test-bars of the series just what the increases in silicon did for the $\frac{1}{2}$ -in. □ bars of the six series, and this should therefore have increased the strength, and it did. But the increase in the looseness of the grains on account of the slow cooling decreased the strength more rapidly than this increase of strength. Whatever the decrease in strength on account of loose crystallization was, it was lessened in Series 1 by the increase in strength due to the decrease in combined carbon, with the result that the larger bars were stronger than any others of the six series.

A further proof is found in the various series in which combined carbon is the same in each size of test-bar; for example, Series 19, which was from a car-wheel mixture in which the iron was mixed in a large ladle and therefore of uniform composition; Cd.C. remained the same in all sizes of test-bars, but the decrease in strength follows the general law.

Another example proving the same thing is Series 2, "Iroquois." The silicon has been increased about two tenths of 1%, and in all but the $\frac{1}{2}$ -in. □ bars the combined carbon is uniform at about .54%, but slow cooling decreases strength in the large test-bars, exactly the same as in Series 1. The increase in silicon has, in the $\frac{1}{2}$ -in. □ bar, taken out brittleness, by diminishing combined carbon, and has thereby increased the strength 45 lbs. This increase in silicon causes the grain to become coarse, in the larger bars, more rapidly than in Series 1. The large bars grow weak faster in Series 2 than in Series 1, in spite of the combined carbon not decreasing in the larger bars. In Series 15 the

$\frac{1}{2}$ -in. \square bar begins with 0.10 of 1% combined carbon, and there is not enough decrease in this element, in the larger bars, to make any difference in any respect, but slow cooling causes the same proportional weakening of the larger bars.

A most interesting test was made by Mr. A. L. Colby, chemist of the Bethlehem Steel Co. Half of a furnace cast was run in sand and half in the iron molds of their casting machine. The former made an open-grained pig and the latter a pig of very close grain as shown in Fig. 59. A portion of each kind was melted separately in a cupola under as uniform conditions as possible, and test-bars $3\frac{1}{2}$ ins. square were cast in horizontal and in vertical molds. The castings from each were exactly alike in grain. The fractures are shown in Fig. 59 and the composition and strength of each is given in Table LXIII.

Mr. Colby ascribed the great strength of the machine-cast pig to the combined carbon, which he considered the only variable. Whereas the sudden cooling in the iron molds caused the grain to be very uniform and close, while the slow cooling of the sand-cast pig produced a very coarse and irregular grain.

If the same close grain could have been produced without any increase of combined carbon the strength would not have been any less.

TABLE LXIII.

SAND OR IRON MOLDS FOR PIG IRON.

	Sand-cast Pig.	Machine-cast Pig.	Test-bars $3\frac{1}{2}'' \square \times 18''$ Long.			
			From Sand-cast Pigs.		From Machine-cast Pigs.	
			Cast Horizontally.	Cast Vertically.	Cast Horizontally.	Cast Vertically.
Total Carbon	3.460	3.380	3.400	3.390	3.364	3.350
Graphitic Carbon	3.210	2.460	2.930	3.022	3.028	3.028
Combined Carbon250	.920	.470	.368	.336	.322
Silicon	3.000	2.990	2.930	2.910	2.960	2.960
Phosphorus770	.773	.766	.769	.772	.774
Sulphur041	.041	.071	.064	.077	.071
Manganese950	.950	.840	.850	.840	.840
Tensile strength lbs. per sq. in. ...	15,000	41,000	18,000	16,300	17,000	17,000

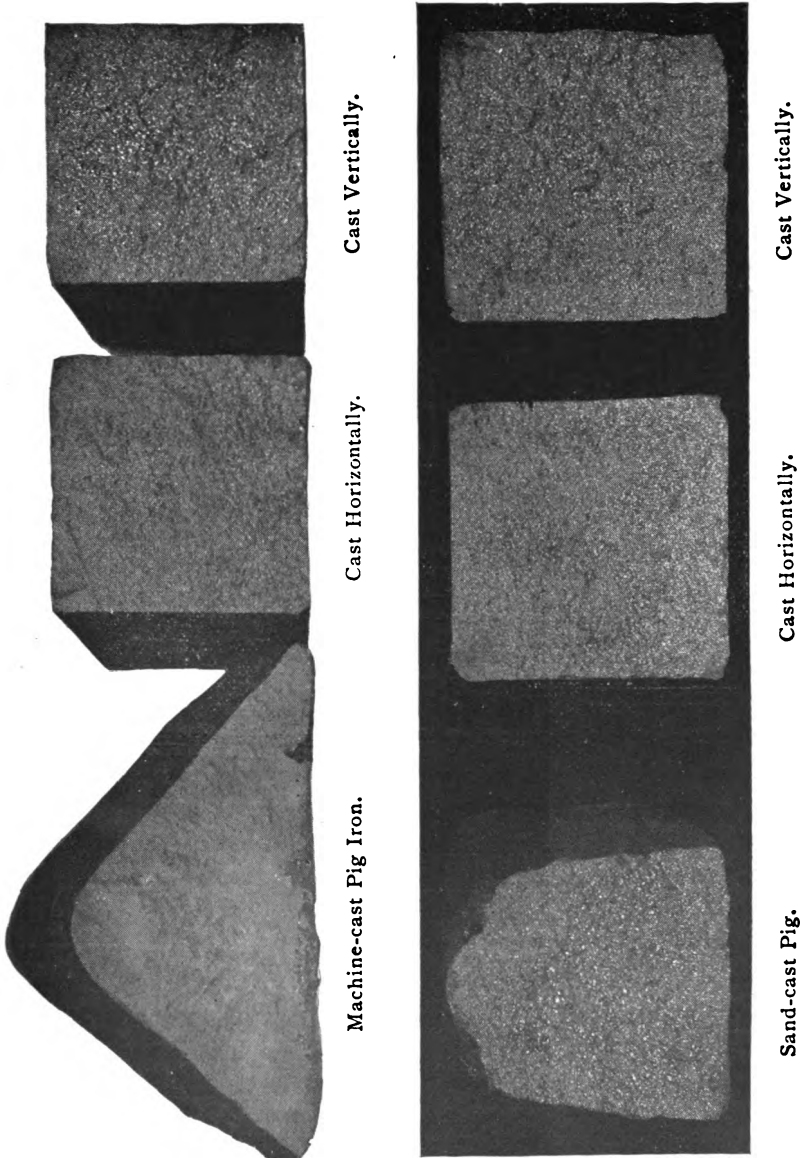

FIG. 59.—Showing Effect of Grain on Strength.

To make it possible to judge of the quality of castings from the fracture of machine-cast pig iron it would be necessary that the conditions in all cases, at all furnaces, should be uniform, and there seems no chance of this. At present there seems to be more variation in conditions than in sand-cast pig.

TABLE LXIV.
A. S. M. E. TESTS.

	Series.	Per Cent of Graphitic Carbon.					
		½" □	1" □	1" × 2"	2" □	3" □	4" □
Iroquois.....	1	2.36	2.60	2.83	3.08	3.05	3.13
	2	3.20	3.32	3.24	3.33	3.32	3.31
	3	3.21	3.28	3.32	3.40	3.36	3.55
	4	3.10	3.24	3.27	3.41	3.60	3.25
	5	3.19	3.40	3.24	3.47	3.38	3.42
	6	3.01	3.08	3.08	3.24	3.19	3.23
Hinkle.....	7	2.78	3.13	3.2	3.42	3.48	3.55
	8	3.17	3.44	3.3	3.29	3.37	3.42
	9	3.28	3.47	3.36	3.46	3.67	3.72
	10	2.91	2.87	2.86	2.84	2.80	2.82
	11	3.00	3.22	3.22	3.25	3.28	3.23
	12	3.07	3.28	3.24	3.26	3.28	3.22
Southern.....	14	2.89	3.08	3.13	3.18	3.14	3.20
	13	3.03	3.06	3.07	3.07	3.04	3.08
	15	3.03	3.01	3.07	3.06	3.03	3.11
C. G. Bretting & Co....	16	3.30	3.10	3.08	3.32	3.22	3.31
Mich. Mall. Iron Co....	17	.2624	1.90	1.86
Bement, M.les & Co....	18	2.90	2.83	2.92	3.06	3.11	3.20
A. Whitney & Sons....	19	.79	2.86	2.98	3.00	3.02	2.97

Graphitic Carbon.—The general opinion is that it causes weakness. If C. C. decreases, the G. C. must increase; therefore, if it was thought that combined carbon produced strength, the same facts that seemed to warrant this conclusion implied that graphitic carbon produced weakness. Again, in graphitic iron, the grain was coarse, and the flakes of graphite lay between the grains, and it seemed self-evident that these graphitic flakes must of necessity separate the grains of iron and cut the casting up.

The same proof that has been produced in the case of combined carbon will apply regarding graphitic carbon.

From an examination of these series, strength or weakness seem to be absolutely independent of this element. The looseness of the grain, produced by slow cooling, so separates the grains that there seems to be more than enough room for the flakes of graphite to lie in the open spaces. It may be even doubted if the graphite ever gets between the grains to make their union less perfect. The graphitic scales seem to have formed in the spaces after the openings have been formed, and either act as a cushion, or the scales lie loosely in the cavities. This latter supposition seems plausible, from the fact that when pig iron, or a casting as large as a pig of iron, is broken, scales of graphite fall out in great abundance.

For the influence of sulphur and manganese on strength consult the chapters on these elements.

Annealing Castings.—To produce very soft castings with very low shrinkage some founders melt only the softest No. 1 pig iron, and do not even use the scrap made from such iron; while others use cheaper irons for the castings, and afterwards place the castings in an annealing oven until most of the combined carbon which they contain is changed into graphite. Instead of increasing silicon in their mixtures to cause a decrease in combined carbon, they prefer to anneal the castings. It would be impossible to get as low a shrinkage or as soft iron in the cupola as by this process.

Table VI, page 33, is an example of this. All bars were poured from one ladle. The chill in the annealed castings is very dull and only half as deep as before annealing. The grain is much darker and is filled with glistening points. The unannealed thin bars broke without taking set, while the annealed thin bars took a set of over four tenths of an inch at the center before breaking. The unannealed square bars took a set of .10 of an inch at 300 lbs., and after annealing took a set of .20 of an inch. The annealing changed three fourths of the combined carbon into graphite and the annealing temperature was high enough to enlarge the grain, thereby weakening the test-bars.

CHAPTER XIV.

IMPACT.

THE object of this chapter is to show the influence of impact upon test-bars of various sizes.

The Test-bars are 1 in. \times 1 in., 1 in. \times $\frac{1}{2}$ in., $\frac{1}{2}$ in. \times 1 in., and $\frac{1}{2}$ in. \times $\frac{1}{2}$ in. in section. One set is 24 ins. long and another set is 12 ins. The bars are of tool-steel having a uniform spring-temper produced in a gas-muffle. Each bar was then ground to the exact standard size on a surface-grinder.

The Recording Apparatus (page 189) holds the ends of the bars in clamps which rest on bearings exactly 24 ins. or 12 ins. apart. The impulse is received by a cage clamped to the center of the bar, and the motion is multiplied five times by an arm which carries a pencil at its end, which makes an autographic diagram of the movement of the center of the test-bar.

Dead Load.—A single-lever machine, shown in Figs. 92 and 93.

TABLE LXV.

Dead Load.		25 lbs.	50 lbs.	75 lbs.	100 lbs.	200 lbs.	300 lbs.	400 lbs.	500 lbs.
Deflections in inches.	1 in. \times 1 in. \times 24 in.	.0028	.0056	.0084	.0112	.0224	.0336	.0448	.0560
	1 " \times $\frac{1}{2}$ " \times 24 "	.0056	.0112	.0168	.0224	.0448	.0672	.0896	.1120
	" \times 1 " \times 24 "	.0224	.0448	.0672	.0896	.1792	.2688	.3584	.4480
	" \times $\frac{1}{2}$ " \times 24 "	.0448	.0896	.1344	.1792	.3584	.5376	.7168	.8960
	1 " \times 1 " \times 12 "	.0003	.0007	.0011	.0014	.0028	.0042	.0056	.0070
	1 " \times $\frac{1}{2}$ " \times 12 "	.0007	.0014	.0021	.0028	.0056	.0084	.0112	.0140
	" \times 1 " \times 12 "	.0028	.0056	.0084	.0112	.0224	.0336	.0448	.0560
	" \times $\frac{1}{2}$ " \times 12 "	.0056	.0112	.0168	.0224	.0448	.0672	.0896	.1120

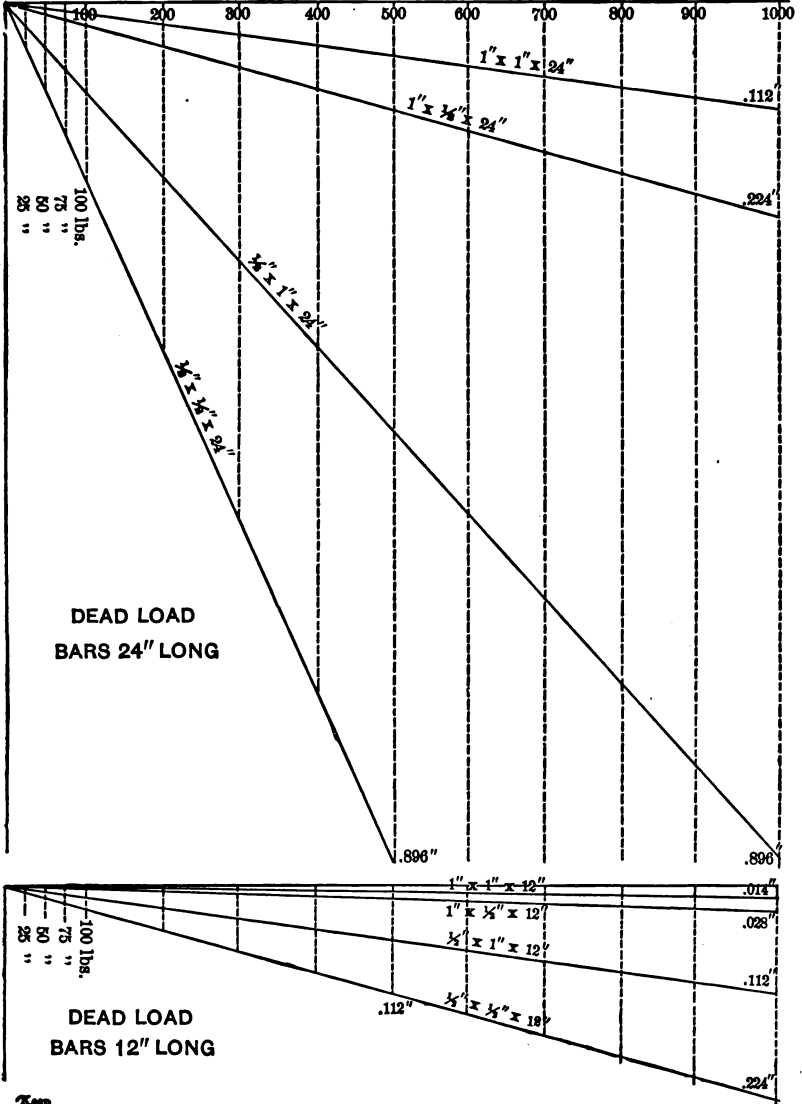

FIG. 60.

Dead-load Diagrams (Fig. 60).—It must be remembered that all of these test-bars are perfectly elastic for the loads applied to them, and for this reason dead-load deflections are proportioned to loads. The diagrams show that:

Deflection is inversely as the breadth of the test-bar.

“ “ “ “ “ cube of the height of the test-bar.

“ “ directly “ “ “ “ “ length of the test-bar.

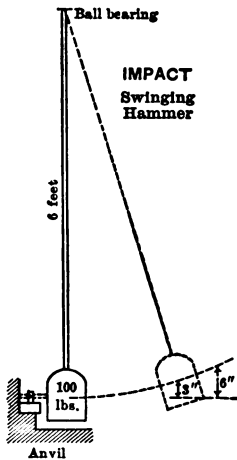

FIG. 61.

Impact Testing Machine (Fig. 61, page 188) with its Hammer Swinging on a wooden vertical arm 6 ft. long. The weight of the hammer can be varied between 25 and 100 lbs.

With a swinging hammer the bar receives the impulse in a horizontal direction and the bar bends until the motion of the hammer is stopped. The bar then springs back and throws the hammer away, when it is caught by the hand and clasped to the trip for the drop from the next higher point. The dead load of the hammer is carried by the vertical arm to which it is attached.

Impact Diagrams made with a Swinging Hammer.—To obtain a complete record of each motion of the center of the test-bar, a shaft $\frac{3}{4}$ in. in diameter was made to revolve 1250 revolutions per minute. The paper-holder was connected to this shaft by a cord. Just as the blow was given the shaft was caused to revolve, and the winding of the cord caused the paper to move its whole 24-ins. length in half a second. The length of the diagram of a single impulse, and of the vibrations until the bar comes to rest, is from 1 to 4 ins., and the pencil makes this record in from $\frac{1}{4}$ to $\frac{1}{1\frac{1}{2}}$ of a second.

The diagrams (Figs. 62 to 68) are reduced to one third actual size. Figs. 62 and 64 are swinging blows from 25 and 100-lb. hammers, both 1-in. drop, on the same test-bar. The bar

TABLE LXVI.

DEFLECTIONS WITH SWINGING HAMMAR.

Size Bars.	Weight of Hammer.	Height of Drop in Inches.						
		0 in.	$\frac{1}{2}$ inch.	1 inch.	1 $\frac{1}{2}$ inches.	2 inches.	2 $\frac{1}{2}$ inches.	3 in.
1"X1"X24"	25 lbs.	.0	.060	.087	.105	.122	.130	.144
	50 "	.0	.075	.107	.130	.150	.162	.176
	75 "	.0	.088	.126	.152	.175	.193	.210
	100 "	.0	.099	.141	.172	.200	.220	.240
1"X $\frac{1}{2}$ "X24"	25 "	.0	.077	.110	.139	.158	.175	.194
	50 "	.0	.100	.145	.174	.201	.226	.250
	75 "	.0	.122	.175	.210	.241	.271	.300
	100 "	.0	.141	.200	.241	.280	.314	.347
1"X1"X24"	25 "	.0	.110	.165	.205	.237	.270	.300
	50 "	.0	.168	.242	.300	.350	.400	.435
	75 "	.0	.210	.314	.385	.448	.508	.550
	100 "	.0	.260	.370	.460	.532	.605	.665
1"X $\frac{1}{2}$ "X24"	25 "	.0	.150	.225	.280	.322	.365	.410
	50 "	.0	.230	.332	.410	.470	.530	.580
	75 "	.0	.295	.425	.525	.600	.670	.732
	100 "	.0	.342	.493	.610	.705	.791	.870
1"X1"X12"	25 "	.0	.035	.048	.057	.069	.078	.084
	50 "	.0	.044	.065	.080	.093	.107	.119
	75 "	.0	.053	.080	.099	.118	.133	.149
	100 "	.0	.062	.093	.115	.138	.155	.174
1"X $\frac{1}{2}$ "X12"	25 "	.0	.046	.062	.026	.090	.100	.110
	50 "	.0	.058	.084	.100	.118	.133	.147
	75 "	.0	.069	.100	.120	.140	.160	.177
	100 "	.0	.080	.115	.138	.162	.186	.203
1"X1"X12"	25 "	.0	.060	.090	.110	.125	.139	.150
	50 "	.0	.080	.115	.140	.161	.182	.200
	75 "	.0	.100	.120	.175	.200	.223	.246
	100 "	.0	.119	.166	.200	.234	.265	.293
1"X $\frac{1}{2}$ "X12"	25 "	.0	.070	.100	.126	.148	.155	.181
	50 "	.0	.091	.131	.164	.191	.218	.239
	75 "	.0	.117	.165	.207	.238	.270	.295
	100 "	.0	.140	.197	.241	.280	.315	.345

vibrated once and a trifle more with 25 lbs., and twice as many times with 100 lbs. The hammer is caught by the hand and allowed to strike the test-bar but once. By letting the hammer swing against the bar until it came to rest, the 25-lb. hammer

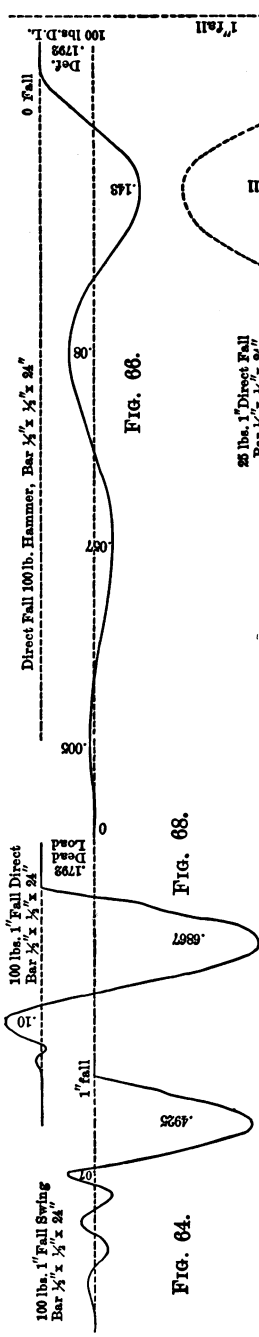

FIG. 66.

FIG. 68.

FIG. 64.

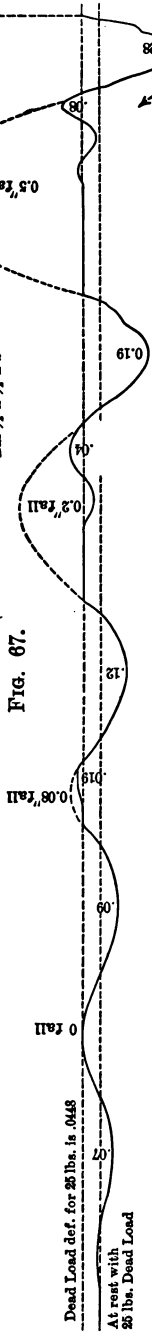

FIG. 67.

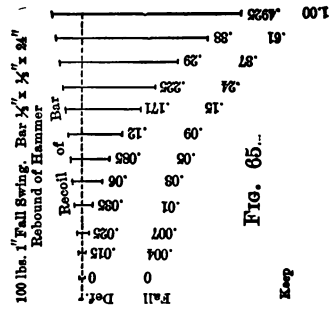

FIG. 65...

Keep

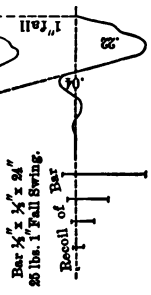

FIG. 63.

FIG. 62.

All diagrams on this page are $\frac{1}{2}$ actual size.

made the series of records shown in Fig. 63 and the 100-lb. hammer the record of Fig. 65.

The regular diagram is made by moving the paper slightly for a base-line when the test-bar is at rest (see Fig. 70). The hammer is then raised to a catch hung in the hole of the graduated arc for $\frac{1}{8}$ -in. drop and let drop upon the test-bar. The record is a vertical line five times as long as the actual deflection of the center of the test-bar. The paper is then moved $\frac{3}{16}$ in. and the hammer let drop $\frac{1}{4}$ in. and so on, each drop being $\frac{1}{8}$ in. higher than the next preceding.

Each record is continued above the base-line, because when the hammer swings back the center of the test-bar goes past its original position, and the bar vibrates several times before it comes to rest. By drawing a line through the lower ends of the record line we get a curve showing the total deflections for drops from 0 to the highest drop. By connecting the upper ends of the record-lines we have a curve showing the vibrations of the test-bar.

Diagrams from Test-bars which are not Perfectly Elastic.—

Fig. 69 shows a dead-load diagram from a bar of ingot iron $\frac{1}{2}$ in. by $\frac{1}{2}$ in. by 12 ins. When the metal began to flow rapidly the load was removed, and the pencil rested a distance below its original position equal to the set taken by the test-bar. When the load was again applied, a new diagram was made which joins the former diagram at the point where the load was released. A diagram from a $\frac{1}{2}$ -in. square steel bar is added, which is shown by the dotted line and coincides with the spring-line of the ingot iron.

Fig. 70 shows an impact diagram from a test-bar cut from the same bar of ingot iron. With dead load the bar took no set until it gave way. With impact, set began almost at once. The upper line shows the vibration of the bar. The dotted lines show impact diagrams from the tempered-steel bar. As it took no set the line of sets coincides with the base-line.

Figs. 71 and 72 are diagrams from bars of rolled puddled

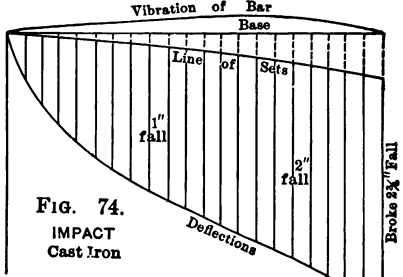
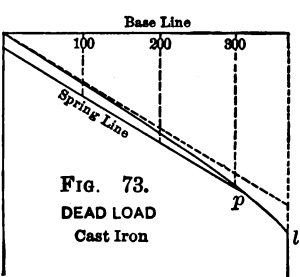
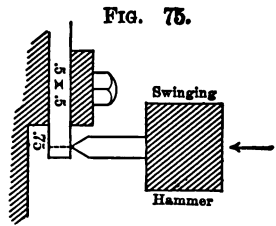
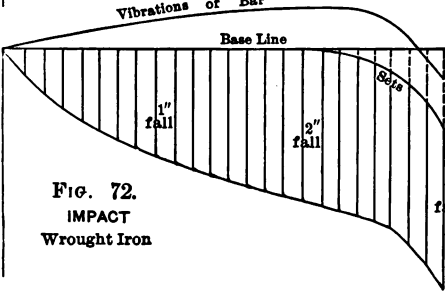
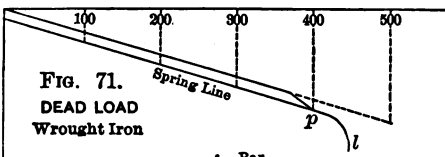
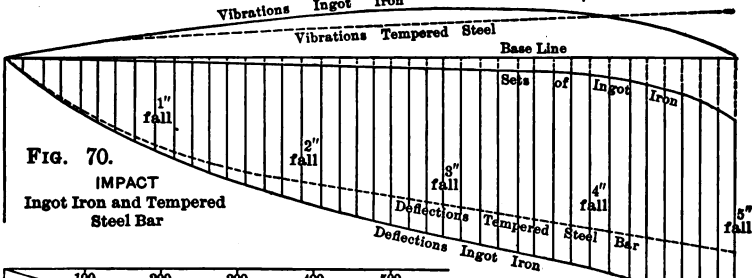
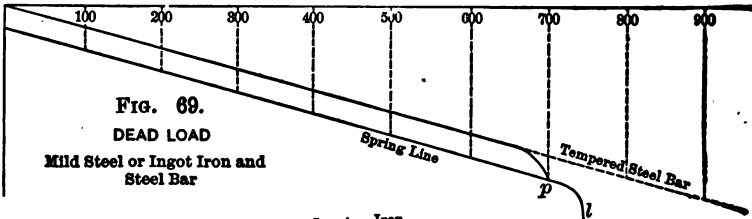

All Test Bars on this page are $\frac{1}{2}$ " x $\frac{1}{4}$ " x 12" all Impacts are with a 25 lb. Swinging Hammer, all diagrams Full Size. Deflections multiplied by 5.

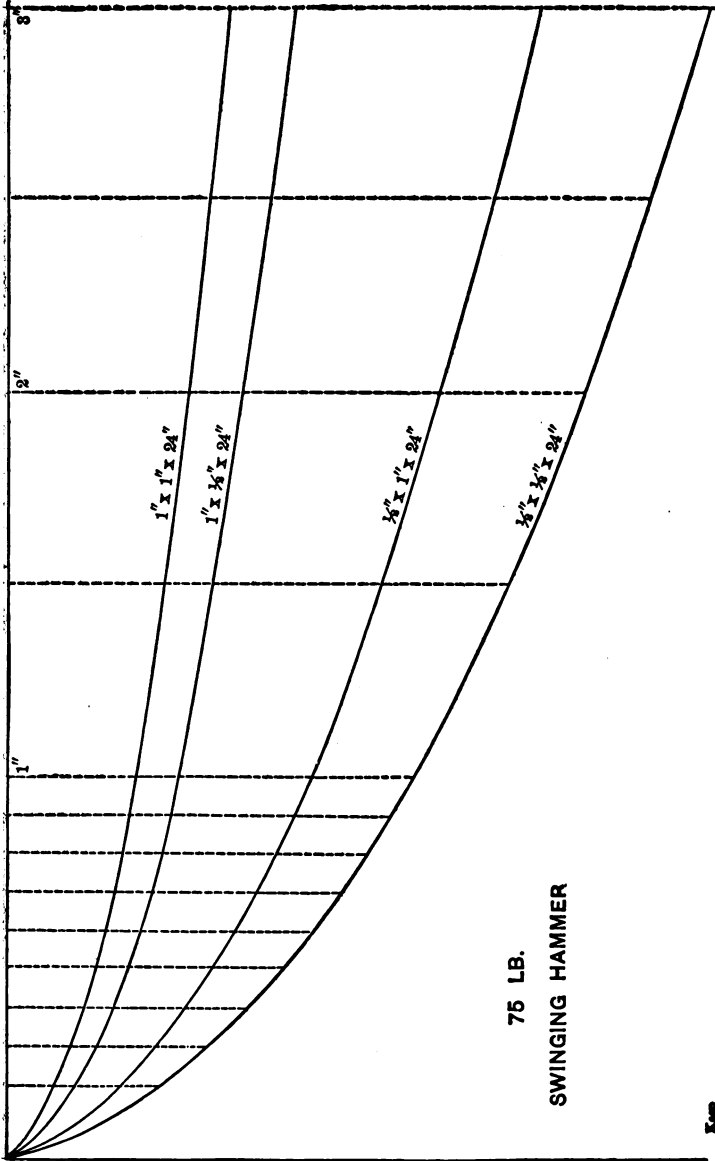

FIG. 76.

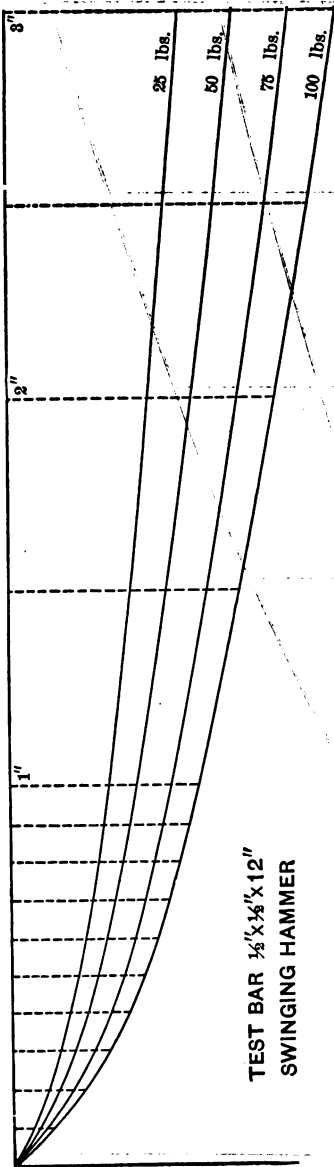

FIG. 77.

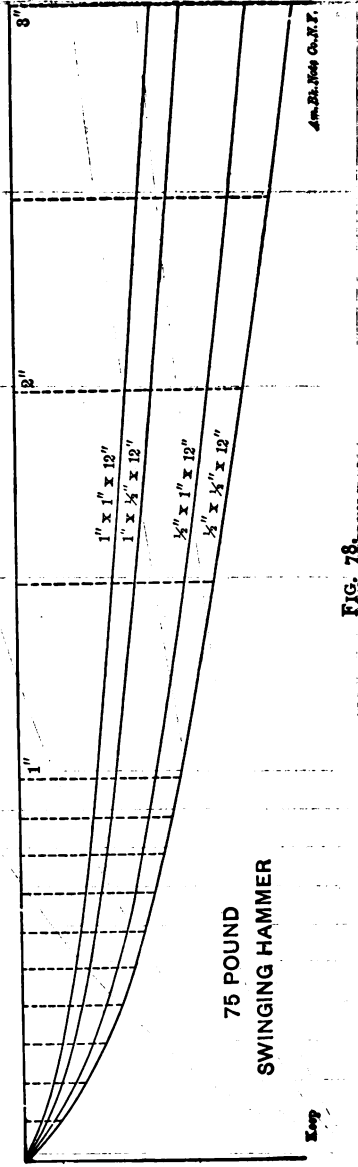

FIG. 78.

iron. Figs. 73 and 74 are diagrams from gray cast iron, which takes set with the smallest load, but after having been subjected to a given dead load, in this case 300 lbs., it is perfectly elastic for less loads.

In every case the deflection is greater with impact than with dead load.

Figs. 76 and 78 show the deflections with drops from 0 to 3 ins. of a 75-lb. hammer on each of the test-bars, and Fig. 77 shows deflections from all the hammers on a 1-in. \square bar.

Impact Diagrams made with a Hammer having a Direct Drop.—Fig. 79 shows the same hammers as with swinging blows, hung on a horizontal wooden arm 8 ft. long, which allows the hammer to drop practically in a vertical line without guides.

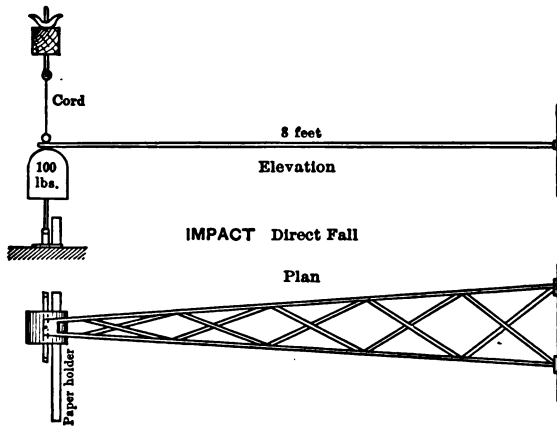

FIG. 79.

The hammer is fastened by a cord to a timber overhead, and is then raised or lowered by a thumb-screw until it is exactly the required height above the test-bar.

The cord is cut to let the hammer drop. With a direct drop the hammer acts on the test-bar as a dead load, and also by impact. When the motion of the hammer has been stopped by the elasticity of the test-bar, in springing back the bar must lift

the hammer as a dead load, and toss it upward when it reaches its normal position.

The test-bar when the hammer leaves it vibrates until it comes to rest.

The hammer drops again on the bar, is tossed a second time, the bar vibrating until at rest, when it receives the hammer again, which finally rests on the bar, bending it as a dead load.

If a 100-lb. hammer is suspended as in Fig. 79, so that it just rests on the test-bar, say $\frac{1}{2}$ in. by $\frac{1}{2}$ in. by 24 ins., but does not bend it, and is lowered slowly, the bar will bend .1792 in., and come to rest supporting the 100-lb. weight; but if the cord was cut and the hammer allowed to drop, it is the same as a .1792 in. drop on the bar, less the resistance of the bar during this drop, and the bar bends nearly .1792 from the drop + .1792 for dead load.

Fig. 66 on page 144 is a diagram from 0 drop of 100-lb. hammer.

TABLE LXVII.
DEFLECTIONS WITH DIRECT DROP HAMMER.

Size Test-Bars.	Weight of Hammer.	Height of Drop in Inches.						
		0 in.	$\frac{1}{4}$ inch.	1 inch.	$1\frac{1}{4}$ inches.	2 inches.	$2\frac{1}{4}$ inches.	3 in.
$1'' \times 1'' \times 24''$	25 lbs.	.005	.065	.092	.119	.130	.145	.150
	50 "	.010	.080	.115	.140	.159	.174	.187
	75 "	.015	.100	.135	.162	.181	.201	.219
	100 "	.020	.116	.160	.187	.209	.230	.248
$1'' \times \frac{1}{2}'' \times 24''$	25 "	.011	.087	.130	.155	.174	.191	.205
	50 "	.023	.112	.165	.196	.221	.241	.265
	75 "	.034	.134	.191	.229	.262	.289	.316
	100 "	.047	.161	.221	.266	.305	.339	.370
$\frac{3}{4}'' \times 1'' \times 24''$	25 "	.046	.145	.205	.251	.285	.315	.340
	50 "	.084	.230	.317	.376	.420	.454	.483
	75 "	.126	.300	.415	.485	.531	.571	.611
	100 "	.171	.359	.482	.564	.620	.670	.715
$\frac{3}{4}'' \times \frac{1}{2}'' \times 24''$	25 "	.070	.206	.300	.365	.418	.456	.482
	50 "	.141	.332	.453	.525	.578	.618	.652
	75 "	.230	.453	.586	.663	.720	.766	.800
	100 "	.333	.566	.702	.790	.851	.900	.941

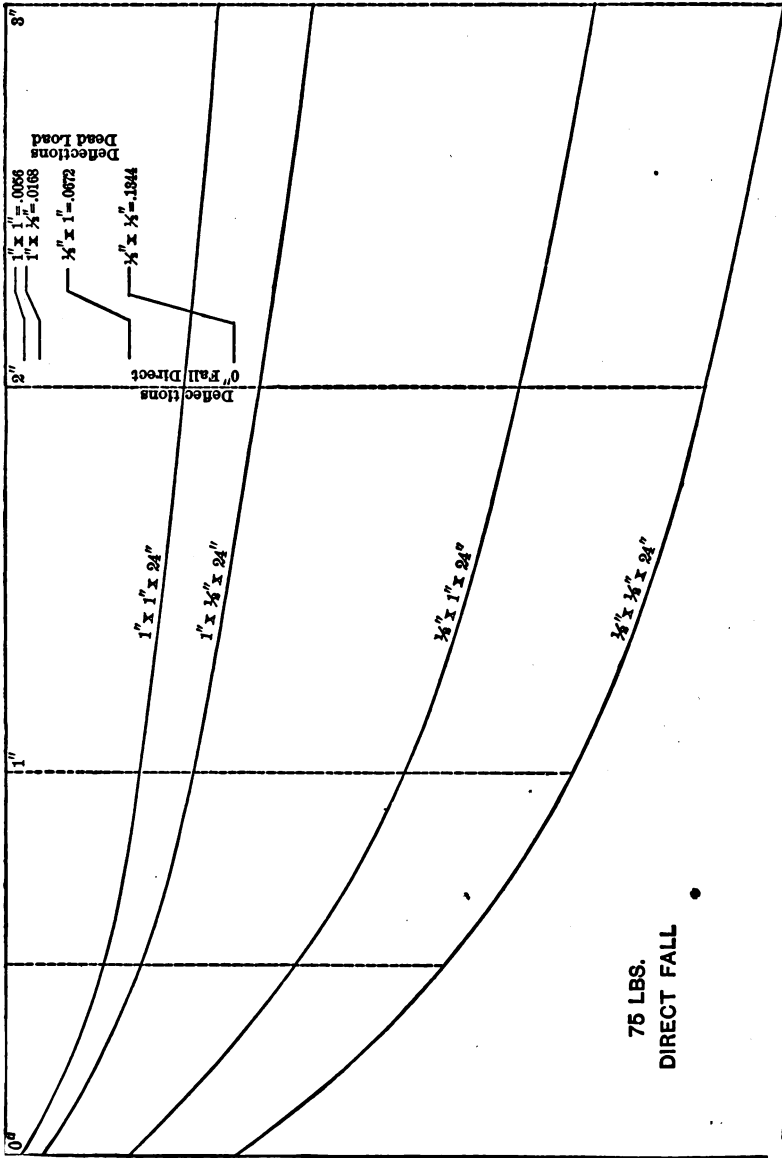

Am. Bldg. News Co. N. Y.

Fig. 80.

Keep

Fig. 67 is a diagram showing the influence of a single direct 1-in. drop of 25 lbs. as compared with the influence of a single 1-in. drop of a 25-lb. swinging hammer (Fig. 62).

The diagram (Fig. 80) was constructed from actual records of direct drop.

Impact Tests.—To determine the resilience of a material, support a test-bar at the ends and deliver blows at the center. After a test-bar has been tested in this way to find its resistance to impact without any distortion as a test of brittleness, a portion of the same bar should be clamped on the anvil of the testing-machine so that one end shall project (see Fig. 75, p. 146). Blows should be delivered on the projecting end as far from the clamp as $1\frac{1}{2}$ times the depth of the bar. An inch bar would receive blows $1\frac{1}{2}$ inches from the clamp and a $\frac{1}{2}$ -in. bar $\frac{3}{4}$ in. from the clamp.

Size of Test-bars for Impact.—Some *one size* of test-bar must be selected for comparisons. The size for cast iron which would seem to give the best results is a bar 1 in. by 1 in. by 24 ins. struck with a 50-lb. hammer. This has the same relative proportions as a bar $\frac{1}{2}$ in. by $\frac{1}{2}$ in. by 12 ins., and if a 25-lb. hammer is used for the latter, the record is the same as with a 1-in. by 1-in. by 24-in. bar with a 50-lb. hammer; but this does not take into account the change in grain due to size of casting.

Impact with a Swinging Hammer.—On account of this giving simple impact unmixed with dead load and other modifications which accompany the direct drop, the swinging hammer appears to be the best mode of application of impact for ordinary test-bars.

Its convenience is greatly in its favor. It does not affect the surface of the test-bar. The height of drop is exact to $\frac{1}{8}$ in. It can be operated by hand rapidly.

Blows should be begun with the same drop at all times, which should be less than the lowest possible breaking drop, and then each drop should be increased by $\frac{1}{8}$ in. until fracture takes place.

Influence of Shock on Cast Iron.—In Trans. A. S. M. E.,

vol. XIX. pp. 351 to 386, a large number of tables prove the following :

Striking test-bars on the side or in the direction of their length decreases their length slightly, probably by the grains readjusting themselves so as to lie closer together.

This explains the frequent cracking of castings while breaking off the gates.

Tumbling, in contact with other castings, test-bars which are covered by sheet-iron cases which fit perfectly, slightly shortens them.

Tumbling test-bars in contact with other castings lengthens them.

The amount that they are lengthened is proportioned to their malleability. A tempered-steel bar and a bar of white cast iron were not lengthened. A bar of soft wrought iron was lengthened.

It was proved that at first, all soft cast-iron bars were slightly shortened, and then the peening action of the blows on their sides lengthened them. Shipping test-bars 1000 miles, loose in a box and in contact with each other, with the box lying on the floor of a box-car, did not produce any difference in length that could be measured.

Influence of Shock on Strength.—The test-bars shipped by rail were apparently not influenced. Blows delivered on the side or end of a test-bar (even 500,000 blows) did not alter the strength, at least very slightly.

Test-bars tumbled in a tumbling-barrel are always stronger than companion bars not tumbled.

This fact seems to have been discovered by Mr. A. E. Outerbridge. He described this in a letter to the author in the last part of 1894, and he published a description in Transactions of the American Institute of Mining Engineers, vol. XXVI., 1896, p. 176. He explains the gain in strength by the "mobility of molecules," relieving an overcrowded condition of the grains at the surface of a casting. The chapter on Crystallization shows that in a test-bar there can be no crowding, but

that each individual grain tends to pull away from those next to it. A shock therefore allows the grains to settle more closely together, making the test-bar slightly shorter.

The author endeavored to find the true reason for the increase in strength and discovered the following:

Test-bars $\frac{1}{2}$ in. square increase in strength until they have been tumbled two or three hours, but not materially by longer tumbling.

Of tumbled test-bars, the weakest bars are strengthened most, and the strongest bars are strengthened very little.

The removal of the surface weakens a test-bar.

Smoothing the surface of a test-bar without removing the surface strengthens it.

Smoothing the surface of a test-bar by pounding with a hammer increases its strength.

Pounding the surface of a test-bar strengthens it by condensing the grain.

Therefore the strength gained by tumbling is due to making the surface of the test-bar smooth and to condensing the surface by peening.

Test-bars of gray iron containing least silicon gain most by the process of tumbling.

This therefore proves that tumbling test-bars does not strengthen to any great extent, if any, on account of the grains moving on each other and readjusting themselves; but the great increase in strength is on account of the condensing the grain by pounding, and by smoothing, thus removing notches which would induce fracture.

CHAPTER XV.

GRAPHIC METHOD FOR CLOSELY APPROXIMATING THE PERCENTAGE OF SILICON, THE SHRINKAGE, AND STRENGTH OF ANY OTHER SIZE OF CASTING THAN THE ONE TESTED.

WE may take "Iroquois" Series 1 as a fair representation of irons suitable for a moderately heavy casting a little more than 1 in. thick, having a considerable surface and with a shrinkage of one eighth of an inch to the foot, and containing about 1% of silicon. We may take Series 15 as a fair representation of iron suitable for the lightest castings, say from one quarter of an inch down to one sixteenth of an inch thick, and of considerable surface, and with a shrinkage of one eighth of an inch per foot.

Shrinkage.—Table LXVIII is constructed with these series as extremes, and it will be found that "Iroquois," Series 1 to 6, with Series 15, nearly correspond to the shrinkages of this table.

TABLE LXVIII.

APPROXIMATE RELATION OF SHRINKAGE TO SIZE AND PERCENTAGE OF SILICON

	½" □	1" □	2" × 1"	2" □	3" □	4" □	Percentage Silicon.
Perpendicular readings show decrease shrinkage due to increase in silicon.	.183	.158	.146	.130	.113	.102	1.00
	.171	.145	.133	.117	.098	.087	1.50
	.159	.133	.121	.104	.085	.074	2.00
	.147	.121	.108	.092	.073	.060	2.50
	.135	.108	.095	.077	.059	.045	3.00
	.123	.095	.082	.065	.046	.032	3.50

Horizontal readings show decrease of shrinkage due to size.

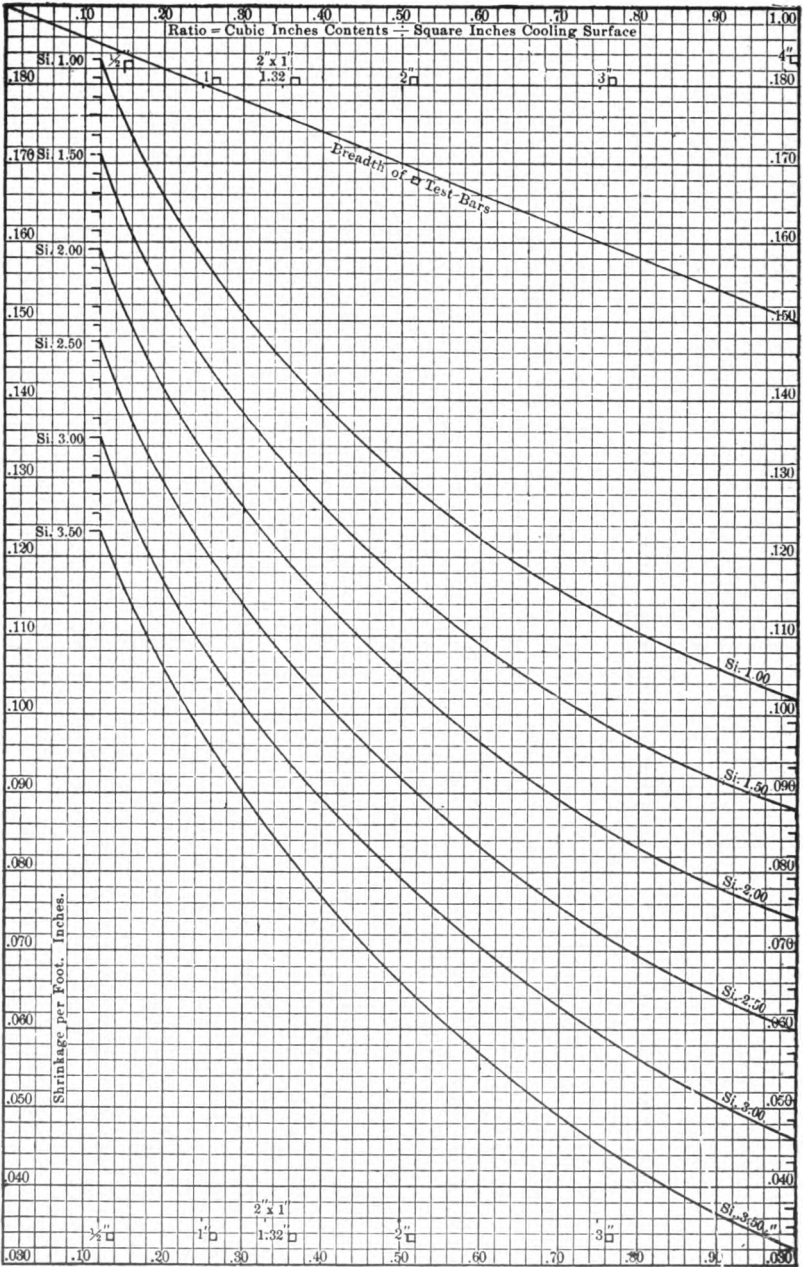

FIG. 81.—Keep's Shrinkage Chart. Approximate Relation of Shrinkage to Size and Percentage of Silicon.

In Fig. 81, the shrinkages of this table are shown graphically.

The figures on each side of this denote the shrinkage in inches per foot. The numbers at the top and bottom show the ratio of cooling. Each curved line shows the variation in shrinkage in varying sizes of castings, containing a given percentage of silicon. The percentage of silicon to produce these curves is marked at each end of each curve.

To find the approximate percentage of silicon in any iron mixture, locate on the $\frac{1}{2}$ -in. \square vertical line (.12) the shrinkage of a $\frac{1}{2}$ -in. square test-bar from that mixture, and this will show the approximate percentage of silicon that should produce this shrinkage.

From this chart a founder can at a glance see the difference in shrinkage between different parts of a casting on account of size. He can tell the shrinkage of any casting larger or smaller, made from the same mixture, from the shrinkage of any size of test-bar which he may use. If he knows the size of a casting and the shrinkage that is desired, he can calculate the ratio of the casting and can locate the shrinkage on Fig. 81 and, by following the curved line either way, can find approximately the percentage of silicon which the iron mixture should contain to produce the desired shrinkage. The following examples illustrate some of the uses of Fig. 81.

Example 1.—Wanted, to make a cylinder with walls 3 ins. thick and so long that we may neglect the end cooling-surface. The shrinkage of a $\frac{1}{2}$ -in. test-bar from the iron mixture is .153. What percentage of silicon does it contain, and what will be the shrinkage of the casting?

Imagine a strip of the 3-in. casting of any size, say $10'' \times 1''$; this contains 30 cu. ins. and 20 sq. ins. of cooling-surface; 30 divided by 20 equals a ratio of 1.50. In Fig. 81 find shrinkage .153 on the left-hand margin. A horizontal line will cut the silicon scale at 2.25, which is the approximate silicon. Follow between the curves until the perpendicular for the ratio 1.50 is

reached (in this case outside the chart), and it will be found that the approximate shrinkage of the casting will be .062.

If it had been required to make a casting of these dimensions with a shrinkage of .062 per foot, which had been found satisfactory for hydraulic cylinders, or for water-pipe, and it was required to find the silicon in a mixture to produce such a casting, follow down the ratio 1.50 until .062 is reached, then run along the curve to a silicon scale, and we will find the silicon to be 2.25.

If we had wished a shrinkage of one eighth of an inch per foot, we would have lessened the percentage of silicon in the mixture to about 1%.

Example 2.—Having .153 as the shrinkage of a $\frac{1}{2}$ -in. square bar, it is necessary to reduce this record to that of a 1-in. square bar. Find .153 on the left-hand side of the chart, carry it across to the perpendicular corresponding to ratio of a $\frac{1}{2}$ -in. bar (.125), run down the curves until the lines corresponding to the ratio (.25) of a 1-in. square bar is reached, which shows a shrinkage of .128.

The shrinkage of a bar 1" \times 2" can be found in the same way to be .116.

If we had used a 1-in. square bar, we could from the chart reduce its record to that of any other size.

Fig. 81 will be found to be a near approximation of the results in any foundry. By its use any founder can produce a definite size of casting by varying the silicon in the iron from which the casting is made.

In every-day foundry practice the silicon or the size of the pattern cannot be varied to suit the shrinkage of every thickness of casting to be made at one cast; therefore, the shrinkage of each one of the castings made cannot be kept uniform at one eighth of an inch per foot.

This is especially the case in the large and small parts of a single casting of varying thickness.

A measure of shrinkage with any one size of test-bar measures the relative influence exerted by silicon; and for convenience, in

the use of Figs. 81 and 82, a definite silicon percentage is ascribed to each shrinkage. For the reasons previously given, this percentage is only an approximation of what might be found by analysis, but represents the *influence* to be *expected* from the definite percentage of silicon named.

Each founder must establish a standard shrinkage of one size of test-bar which is found to accompany the best castings in his own foundry, and then he can use the charts with his mixture of iron; and if the composition is uniform an increase of silicon will decrease shrinkage, and *vice versa*.

In Fig. 81 draw a horizontal line across the chart through the point which represents a shrinkage of .125. The point where it crosses the perpendicular representing the rate of cooling of each size of test-bar will also (by a curve passing through that point and parallel to those next to it) show the percentage of silicon needed in each size of casting to produce a shrinkage of .125. A bar 2" \times 1" needs 1.75%, 2-in. \square 1.25%, and for 3 ins. and 4 ins. square less than 1%.

Although we may not be able to reduce records of pig irons or of mixtures in different shops to a definite relation between the percentage of silicon and the shrinkage, yet in any one foundry, with a substantially uniform mixture or in any special mixture repeated, the shrinkage will indicate whether the silicon in the mixture should be increased or diminished.

It is a fact of the utmost importance that, owing to the irregular composition of cast iron, even that poured from one ladle, every physical and chemical record, however obtained, is only an approximation to what would be obtained by another test. A considerable margin must be allowed in all calculations relating to cast iron.

Strength.—In Fig. 82 is shown the variation of strength for various sizes of castings with various percentages of silicon.

Iron mixtures should be divided into at least three classes:

1. Those made from very soft pig iron, or with an addition of very soft scrap, which will produce a $\frac{1}{2}$ -in. test-bar with an

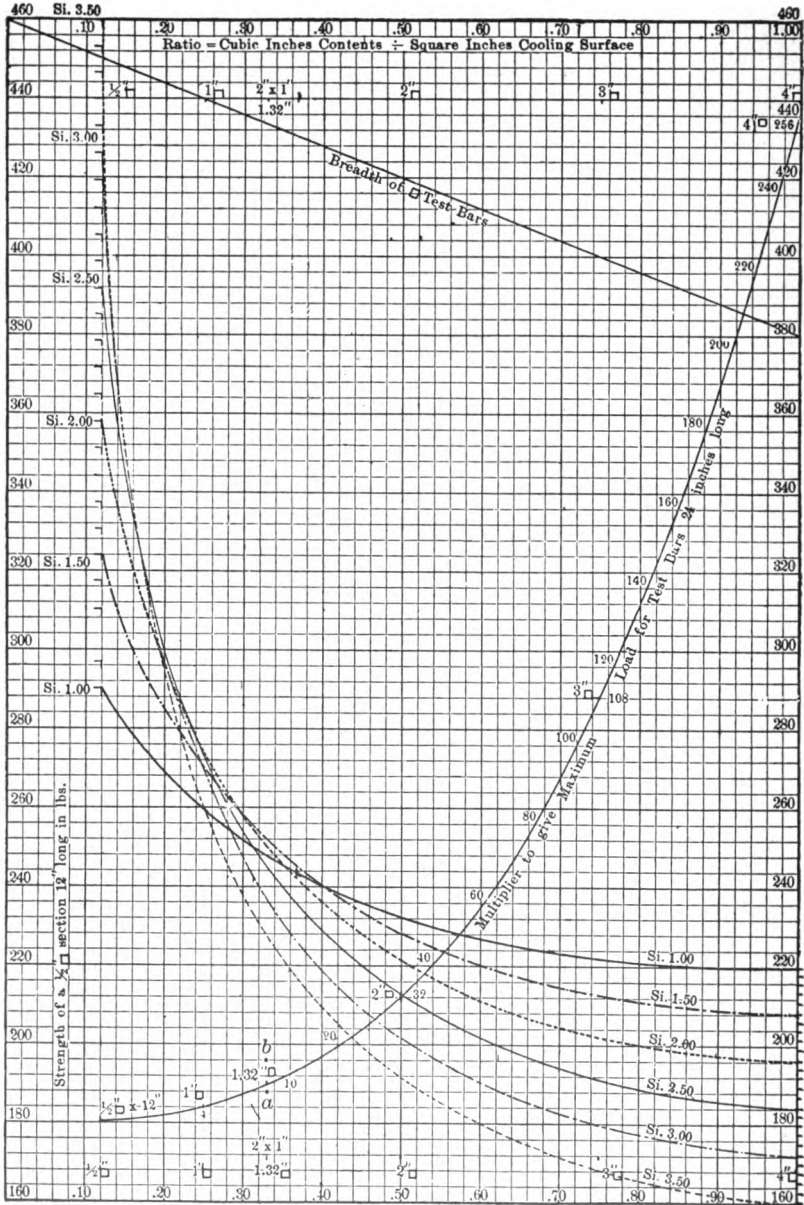

FIG. 82.—Keep's Strength Chart.—Approximate Relation of Strength to Size and Percentage of Silicon.

(Strength of a $\frac{1}{2}$ " \square \times 12" section of each Size of Test-bar.)

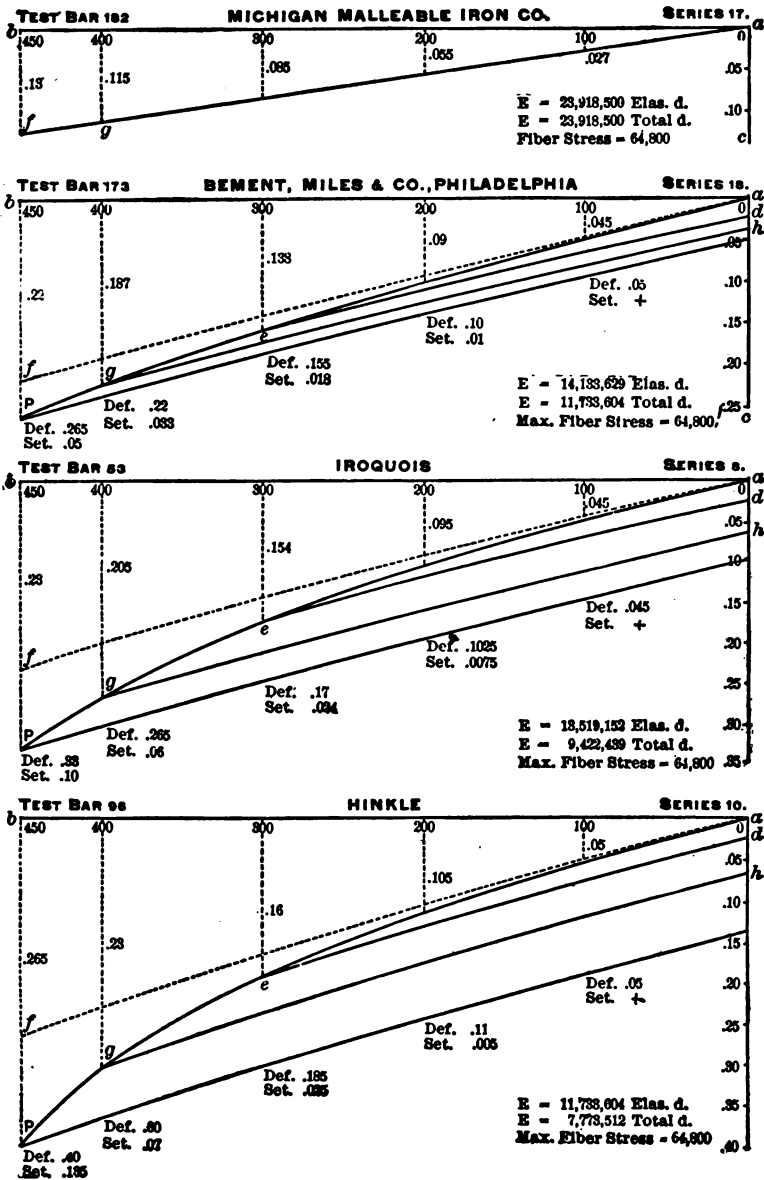

FIG. 83.

open grain and of a dark color, with great deflection, as bars 53 and 96 of Fig. 83. In such mixtures a very small percentage of silicon will open the grain so as to greatly decrease the strength of large castings. These are used when softness is more desirable than strength, and should never be used for heavy castings. All of the series from 1 to 12, and Series 16, are from such mixtures.

2. A mixture made from close-grained pig iron and close-grained scrap, or a mixture which has had its grain closed by some process, and which will make a $\frac{1}{2}$ -in. test-bar of compact, close grain, and not very dark in color, and with a moderate deflection, as bar 173 in Fig. 83. Such a mixture will make strong, large castings, and will be soft enough for small machinery work. Series 18 is from such a mixture.

3. Mixtures which produce a white, $\frac{1}{2}$ -in. test-bar, with small deflection, as in bar 182 of Fig. 83. Such a mixture should only be used for heavy castings thicker than 1 in. Series 19 is an example of such a mixture.

To find the strength of a section $\frac{1}{2}$ in. square by 12 ins. long of a large test-bar from Fig. 82.

For ordinary calculations with soft iron find the percentage of silicon from Fig. 81, which corresponds to the shrinkage of the test-bar used.

On the Strength Chart, Fig. 82, find the curve corresponding to this same silicon percentage, and this is the strength curve for that iron. Now find the perpendicular which represents the size of the test-bar which has been used, and place a dot on it where the horizontal representing the strength of the test-bar crosses this perpendicular; then draw a curve through that dot exactly like the curve which has been found.

All points on the new curve give close approximations to the strength of a section $\frac{1}{2}$ " \square \times 12" long of any other size of test-bar poured from the same iron.

To find the actual strength of the test-bar of the required cross-section.—Find the perpendicular which passes through the size of test-bar of which you wish the strength and note the point

where it crosses the strength curve, and note the strength represented by that point. Follow the same perpendicular to the point where it crosses the curve of multipliers, and the number, on this curve at the point of crossing, multiplied by the strength of the $\frac{1}{2}$ -in. \square section, gives the strength of a bar of the required cross-section and 24 ins. long.

The approximation will not vary more than would an actual test of two bars of that size, taking into account the variation in size of grain due to the difference in size, also the changes due to variations in the percentage of silicon, and of all other influences.

In calculating the strength of different sizes of cast-iron castings, from data obtained from a test of a bar of another size, the mathematical formula should never be used, but an approximation should be obtained from Fig. 82.

In calculating the strength of cast iron it is necessary to use a large factor of safety, even after taking all precautions, for the following reasons:

The strength of cast iron does not depend to any great extent upon its chemical composition, but it depends upon its granular structure, which is often such that slow cooling, or a variation of silicon, does not change it as it would be expected to do.

CHAPTER XVI.

HARDNESS OR THE WORKABILITY OF METALS.

PROFESSOR TURNER says: "Hardness I understand to be the property whereby a body is enabled to blunt or wear away the edge of a tool used upon it. In this it differs from tenacity, which, though increasing the force necessary to be employed in cutting, does not wear away the edge of the tool."

A test of the workability of a metal does not distinguish between hardness and tenacity.

A punch pressed into the surface of a metal is hindered by both these properties.

The machine used in making tests is shown on page 187. The full record of tests may be found in *Trans. A. S. M. E.*, vol. XXII., and proves that a variation of the speed of the test-drill did not materially affect the test-record.

The record increased with increase of load. A straight-fluted drill with the heel ground away so as to leave the cutting-edge like a flat drill, gave the best result. The cutting-edge was injured when ground on a dry wheel, and a wet stone was therefore used (page 188). The best angles were those recommended by makers of drills, but the angles could vary and need not be alike for the two lips, yet to prevent question the wet grinder made all proportions of the two cutting-edges exactly alike, so that each lip takes the same depth of cut.

It was found that however carefully a surface was cleaned grit would blunt the tool, and that the surface should be ground, bright, or the point of a $\frac{1}{2}$ -in. drill should be entered to give the

test-drill a clean cut. Though in ordinary shop-testing it is not necessary, yet the drill was ground before each test.

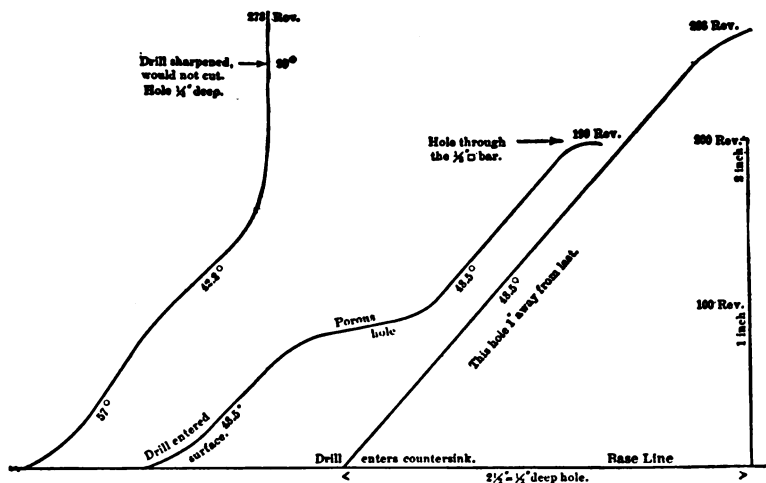

FIG. 84.—Hardness Diagram.

The record of hardness is a diagram lying between 0° and 90° , the latter being the limit of a steel drill. Fig. 84 shows diagrams from $\frac{1}{2}$ -in. \square test-bars. The first to the left is from a bar having hard spots, and one was struck that the drill could not penetrate. The diagram next to this shows that the drill entered a spongy spot and afterwards solid iron. The upper end shows where the drill passed through the upper surface of the bar. The drill entered both these bars from a flat ground-surface. The drill for the third diagram entered a countersink causing the drill to take a full cut. The hole was very near the last, but the metal was uniform.

Drillings for Chemical Analysis.—A tray fits dust-tight under the test-piece and catches all drillings. The table has a ridge around the $\frac{1}{2}$ -in. hole, through which the drill passes, which fits dust-tight against the specimen and prevents any dirt mixing with the drillings. As the machine is practically frictionless with a uniform pressure on the drill, the size of the chips will vary with the hardness, giving a relative uniformity. The drillings

should be all used, and not selected with a magnet, so as to use the finest particles of carbon.

Hardness and Chemical Composition.—Table LXIX gives the hardness records of each size of test-bar of the nineteen series of A. S. M. E. tests, and shows the sizes of bars and the silicon

TABLE LXIX.
HARDNESS—NINETEEN SERIES, A. S. M. E. TESTS.

Kind of Iron.	Calculated Silicon.	No. of Series.	$\frac{1}{2}$ in. sq. x 12 in.	1 in. sq. x 24 in.	$\frac{2}{1}$ in. x 1 in. x 24 in.	$\frac{2}{2}$ in. sq. x 24 in.	$\frac{3}{3}$ in. sq. x 24 in.	$\frac{4}{4}$ in. sq. x 24 in.
"Iroquois," with silicon added by "Pencost".....	1.00	1	58°	41°	34°	28°	28°	27°
	1.50	2	34	30	37	32	28	28
	2.00	3	33	31	32	27	27	20
	2.50	4	36	32	39	30	20	25
	3.00	5	31	29	26	27	24	32
	3.50	6	33	33	32	21	30	28
"Hinkle" and "Pencost".....	1.00	7	62	28	30	25	30	26
	1.50	8	29	32	30	33	24	27
	2.00	9	30	23	31	32	28	30
	2.50	10	31	31	28	30	30	33
	3.00	11	32	27	22	19	22	22
	3.50	12	24	19	24	19	23	21
	Actual Average							
Michigan Stove Co.	2.82	14	35	28	25	23	24	38
	3.18	13	34	23	25	19	27	37
	3.50	15	29	26	25	23	28	33
Car-wheel iron.....	0.77	19	90	41	37	36	32	30
Light machinery.....	1.76	16	38	37	34	38	24	27
Heavy machinery....	2.06	18	45	33	32	31	28	28
Airfurnace for malleable iron.....	0.89	17	90	90	90	90	44	39

HARDNESS—SERIES D AND E, A. F. A. TESTS.

Series.	Kind of Mold.	$\frac{1}{2}$ in. sq. x 12 in.	1 in. sq. x 12 in.	$\frac{1\frac{1}{2}}$ in. sq. x 12 in.	$\frac{2}{2}$ in. sq. x 12 in.	$\frac{2\frac{1}{2}}$ in. sq. x 12 in.	$\frac{3}{3}$ in. sq. x 12 in.	$\frac{3\frac{1}{2}}$ in. sq. x 12 in.	$\frac{4}{4}$ in. sq. x 12 in.
D, Grill Roll.	Green sand.	90°	90°	90°	39°	35°	35°	30°	33°
	Dry sand...	90	90	90	39	33	37	36	36
E, Sand Roll.	Green sand	90	90	90	61	38	33	36	33
	Dry sand...	90	90	90	55	36	40	37	31

The Chemical Analysis of the A. S. M. E. Series can be found, T. C., Table LXXIV; G. C., LXXV; Cd. C., LXXVI of Chap. XIII; Si., Table XVIII, Chap. VII; P., Table XXXV, Chap. IX; S., Table L, Chap. X; Mn., Table LX, Chap. XI. The Analysis of A. F. A. Series, Table XXV, Chap. VIII.

in each. The full analysis can be found in the chapters on each element. The holes for hardness were near the holes from which the drillings were taken for analysis.

At the bottom of the table is the hardness of two series made by the committee of the A. F. A. Series 17 and Series D are very similar, both being from an air-furnace. Series E is also iron that runs white in bars smaller than $1\frac{1}{2}$ ins. square.

Test-bars from such low-silicon irons have hard and soft spots distributed throughout their mass, and the test record is likely to be variable. Series 1, 7, and 19 are similar in this respect, having low silicon.

Hardness seems to follow combined carbon. Manganese hardens cast iron, but the quantities present do not seem to influence hardness.

Table VI shows the influence of annealing ordinary gray cast iron. Table LXX shows test records of six irons. The hardness of pigs and test-bars is given showing that melting and casting has changed the character of the iron. The analyses are of the pig.

TABLE LXX.

	Dead Load.		Shrinkage.	Chill.	Hardness of Test-bars.	Hardness of Pigs.	Total Carbon.	Graphite.	Combined Carbon.	Silicon.	Phosphorus.	Manganese.
	Strength.	Deflection.										
Ensley gray forge.....	368	.20	.185	.25	48°	93°	3.14	2.21	.93	2.62	.88	.16
Summerlee, No. 1, f'dy.	377	.17	.165	.65	33°	46°	3.38	2.92	.46	2.50	1.27	1.67
Tuscarawas, No. 2, f'dy	418	.24	.154	.30	33°	44°	3.62	3.18	.44	1.93	.70	.85
Napier, No. 3, foundry.	423	.19	.165	.80	37°	15°	3.05	3.50	.15	1.76	.85	.48
Eureka, No. 3, "	443	.25	.159	.45	37°	55°	3.45	2.90	.55	1.54	.83	.23
Ashland, No. 3, "	352	.15	.156	.50	58°	3.33	3.12	.21	4.70	1.54	.96

CHAPTER XVII.

MECHANICAL ANALYSIS, OR CHEMICAL ANALYSIS FOR REGULATING FOUNDRY IRON.

Mechanical Analysis consists of measuring the physical properties of castings by means of test-bars.

Mechanical analysis is founded upon the author's discovery in 1885 that the shrinkage of a test-bar varies inversely as the silicon in the casting. In other words, the measure of shrinkage is practically equivalent to a chemical analysis of silicon. The measure of shrinkage tells whether more or less silicon is needed to bring the quality of the casting to an accepted standard of excellence. It is also founded on the fact that the physical properties, aside from shrinkage and softness, are not wholly dependent upon the chemical composition of the casting. Mechanical analysis measures the physical properties of the iron, which are shrinkage, strength, deflection, set, and depth of chill. The measure of the physical quality of a casting shows the combined influence (not the percentage) of each element in the chemical composition, and in addition to this it shows the influence of fuel and of every varying condition attending melting.

An increase of silicon will counteract all such influences and very largely the influence of sulphur. Each foundry fixes upon its best record as its standard. If the shrinkage is higher than the standard, more silicon is needed; if lower, less silicon is required—that is, the more scrap may be used.

Chemical and mechanical analysis each determine whether more or less silicon is needed, and both aim to produce castings having the best physical composition. Each approaches the subject from an opposite direction. The chemist calculates a

chemical composition which he predicts will produce the desired physical composition. To find whether his calculation was correct, it is necessary for him to determine the physical quality. The mechanical method measures the physical quality first, and the variation in shrinkage tells what change of silicon is needed to more nearly reach the standard. Mechanical analysis uses test-bars which cost but a few cents, and the foreman can determine the physical quality in a few moments.

It can be used alone, as it gives all necessary information.

The size of test-bar which will show the greatest variation in strength and shrinkage for the smallest variation in chemical composition is the best size for mechanical analysis.

Whether chemical or mechanical analysis is used, any estimate regarding the physical quality of a casting is only approximate, because conditions attending melting which are not under the control of the melter and cannot be provided for often exert a greater influence on the casting than variations in the chemical composition.

Advantages of Mechanical Analysis.—It is cheap and quick, and can be operated by any one of ordinary intelligence. It tells the founder exactly what physical properties his castings have, and tells him exactly what to do to bring each physical quality to standard. It tells whether more or less silicon is needed to overcome all influences, whether due to chemical change or adverse conditions which cannot be foreseen.

By this method a founder can determine whether a low-priced iron is suitable for his use.

If it is desired to purchase a lower-priced iron, order a carload and substitute a small quantity of it in the mixture in place of an equal quantity of the iron which it is to replace.

If the shrinkage decreases, it is a better scrap-carrier than the other. If the shrinkage increases, silicon must be made up in some other way, and the new iron may not be economical at a reduced price. The same process tells which irons in a mixture are most economical and which contain most silicon.

It is the small founder that needs help most, for he cannot increase his business unless he can make money while his plant is small.

If we would benefit the founder we must devise simple methods which can be used by all, whether they have had the advantage of a chemical education or not.

The methods must be used by the men now in business without adding to the expense of operating their works.

The objection made by chemists to mechanical analysis is that it gives information after the castings are made.

Mechanical analysis assumes that the founder uses more than one iron in his mixture (the more the better), which would prevent the variation in different parts of a pile of iron from exerting a decided influence on the castings, and that he makes no radical change at any time. When a change is made, it is to get closer to the standard or to reduce cost.

The user of mechanical analysis is using chemistry all the time, but says and thinks very little about it. He has only time for results.

Founders who are thorough chemists soon find that the most practical way to control their mixture is by mechanical analysis.

Chemical Analysis.—By this term it is understood that each carload of coke and iron and other material which is received shall have its chemical composition determined. Much good would result from this, but only a small portion of these articles depend upon their chemical composition for their usefulness. For example, in selecting sand, facing, flux, and brick, analysis would be of benefit, but a single analysis would determine which of those that were within the reach of the founders were best adapted for this special work. It is, however, a fact that each of these materials may give the best satisfaction and yet not conform in composition to an ideal analysis. If good castings are produced with low-priced materials, the result is just as satisfactory as if they are composed of the ingredients which a chemist would consider most desirable.

The chemist assumes that when he knows the chemical composition of the iron which is charged into the cupola, he knows the composition of the iron which enters the mold, and knows from this the physical qualities of the casting. This is the mistake which most chemists make. They will find that a variation of silicon in any individual iron mixture will vary the shrinkage, hardness, and brittleness of castings, but that it is not true that a given percentage of silicon, or of all of the other elements, will in different iron mixtures give like physical results.

Strength is more dependent upon size and shape of grain than upon any chemical composition. Of two irons which, by analysis, show exactly the same chemical composition, one may be 50% stronger than the other.

Drawbacks to Chemical Analysis.—A chemist must be employed and a laboratory provided. To be successful even in a small foundry, the chemist must give his whole time, if each iron and the coke are to be subjected to anything like a complete analysis.

Analysis has been found to be slow, especially if other elements than silicon are determined.

For this reason it is necessary to purchase iron far in advance of needs, and there must be room to pile each carload by itself. This adds to the expense of transportation from the yard to the cupola.

If, as is usual with small foundries, iron is purchased as needed, there would not be time for analysis.

There is always a difficulty in sampling. Chemists are not agreed as to the most desirable part of a pig from which to take drillings, and a few grains of sand from the surface would render analysis worthless. The chemist would be obliged to watch each step, for the class of men employed in a foundry yard cannot be entrusted with this work.

Pig iron is not homogeneous, therefore drillings taken from one part may not represent the average of the whole pig, much

less of the whole carload, even if the drillings are taken from ten or twenty pigs.

The small fraction of an ounce of drillings used for the determination of the chemical composition of a carload of iron makes the chance of error very great.

In most foundries a large proportion of scrap is used, and as each piece of scrap comes from a different foundry mixture, no correct analysis can be made.

Two irons showing exactly the same chemical composition will sometimes produce castings having totally different physical qualities.

The chemist does not like to admit this fact, because the success of chemical analysis depends upon the supposition that the same physical quality always accompanies a given chemical composition, and it cannot take account of the unforeseen conditions which often entirely alter the physical character of the castings.

Notwithstanding all this we must know approximately the silicon in each of the pig irons that enter our mixture. The best way to ascertain this is to require the furnace to furnish the silicon percentage with each car, and to guarantee that the other elements are within required limits.

There is less need of an analysis of scrap than of pig iron, because scrap castings have been made under the ordinary foundry conditions and can be relied upon to make the same quality of castings if they are of the same size and if a slight allowance is made for the hardening influence of remelting. If a smaller casting is made, it would be likely to be hard.

CHAPTER XVIII.

CHEMICAL ANALYSIS WILL NOT ACCOUNT FOR ALL PHYSICAL PROPERTIES OF CAST IRON.

SEVERAL tests are presented to show the influence of a few of the unavoidable conditions which attend foundry operations. Some years ago several chemists claimed that they could formulate a chemical prescription which would produce any physical quality. The author produced two $\frac{1}{2}$ -in. square test-bars with the physical record, marked strongest 780 and 782, Table LXXI, and challenged any chemist to give a prescription of elements that such test-bars must contain to give such a variation of strength. They were not told both test-bars were made from the same ladle.

Instead of an endeavor to give such a formula of composition, it was claimed that before it could be done an analysis of the castings must be made. Another example was then produced, strongest 784 and 787, and silicons and sulphurs of all four were given.

Influence of Iron Standing in a Ladle.—There is practically no variation in chemical composition and yet there is a very great change in strength. The first bar of each test was poured as soon as the iron was taken from the cupola, while the bar 782 was poured $1\frac{1}{2}$ minutes later, the iron being stirred with a steel bar, but none of the steel was melted. The bar 787 was poured $2\frac{1}{2}$ minutes after 784, the iron being allowed to stand quietly in the ladle. These records are from individual bars which were analyzed. The same test-numbers used in the table are for averages of three test-bars cast at the same time.

The iron for the tests of Table LXXI was supposed to contain

TABLE LXXI.

TREATMENT OF MOLTEN IRON.*

No. Test.	28 lbs. of Iron for each series.	Dead Load.		Shrinkage.		Chill.		
		Str.	Def.	$\frac{1}{4}'' \square$	$\frac{1}{16}'' \times 1''$			
†780	28 lbs. on reaching floor.....	418	.22	.123	.139	.05		
781	" $\frac{1}{4}$ minute later.....	488	.27	.128	.139	.04		
†782	" $\frac{1}{4}$ " ".....	508	.27	.12102		
783	" $\frac{1}{4}$ " " did not run.....		
†784	" on reaching floor.....	388	.23	.128	.143	.02		
785	" 1 minute later.....	393	.21	.128	.139	.02		
786	" 1 " ".....	424	.21	.128	.135	.02		
†787	" $\frac{1}{4}$ " ".....	466	.24	.128	.135	.02		
		Silicon.	Sulphur.					
780	Strongest bar of three	3.520	.081	440	.23	.123	.139	.05
782	" " "	3.520	.080	530	.27	.13102
784	" " "	3.460	.079	400	.23	.128	.143	.02
787	" " "	3.450	.083	500	.25	.128	.136	.02

* Tests 781 and 782 were stirred with a $\frac{3}{4}''$ steel bar but no steel was melted.
Each record is average of three test-bars.

TABLE LXXII.

DIFFERENCE OF CUPOLA TEMPERATURE.

No. Test.	Separate Ladle for Each Test. Each Record Average of 3 Test-bars.	Dead Load.		Shrinkage.		Chill.		
		Str.	Def.	$\frac{1}{4}'' \square$	$\frac{1}{16}'' \times 1''$			
799	First iron.....	415	.23	.159	.165	.07		
800	One hour later.....	453	.23	.136	.148	.03		
801	" " " than last.....	455	.25	.130	.141	.05		
802	Last iron.....	477	.27	.125	.140	.06		
788	First iron.....	373	.21	.162	.182	.15		
789	One hour later.....	369	.21	.137	.147	.04		
790	" " " than last.....	367	.21	.130	.141	.05		
791	Last iron.....	398	.22	.121	.140	.07		
788	First iron, strongest bar.....	390	.22	.163	.182	.15		
791	Last " " ".....	400	.22	.121	.140	.07		
	Analysis Strongest Bars.	T.C.	G.C.	Cd.C.	Si.	P.	S.	Mn.
788	First iron.....	2.910	2.280	0.630	3.220	1.025	0.123	0.490
791	Last ".....	2.950	2.470	0.480	3.140	1.055	0.100	0.470

3.45 silicon. It was drawn from the cupola as fast as melted. The ladle held 28 lbs. of metal, and on reaching the molders' floor the first set of three test-bars was poured. The ladle was set on the floor and rested, when the next was poured, and so on. It took one quarter of a minute to pour the three flasks of each set. (See also Table LXXIX, tests 776-779.)

Influence of Temperature of Cupola.—In Table LXXII the first iron was weakest, because it boiled on the cupola bottom. The last iron from a hot cupola is always strongest. The analyses are of the strongest test-bars.

The Influence of Dry and Green Ladles is shown in Table XXX, page 84.

The Influence of Wet and Dry Molds.—This question is often raised. The author has purposely gone to extremes in Table LXXIII. In 814 the mold was so wet that one bar was perfectly hollow from a blow-hole. In the other wet molds the sand was as wet as possible to get sound castings. The dry molds were thoroughly dried. The regular mold was tempered as for ordinary work.

These extraordinary series prove that the difference in the temper of ordinary green-sand molds cannot influence the physical character of test-bars $\frac{1}{2}$ " □ so as to materially alter the record.

TABLE LXXIII.

No. Test.	All Three Poured from One Ladle.	Dead Load.		Shrinkage.		Chill.
		Str.	Def.	$\frac{1}{2}$ " □	$\frac{1}{16}$ " × 1"	
814	Very wet mold	420	.22	.146	.149	.04
815	Regular "	430	.23	.136	.142	.04
816	Very dry "	414	.23	.130	.142	.06
827	} Ditto	417	.23	.138	.147	.04
828		417	.24	.129	.144	.05
829		421	.24	.122	.140	.04
830	} Ditto	375	.21	.142	.150	.05
831		387	.22	.140	.148	.04
832		390	.22	.129	.141	.04

Silicon is More Effectual as found in some Irons than in Others.—In Table LXXIV, F^LM is the Swedish charcoal pig which is used in trying other irons. It is very sensitive to any outside influence. The Ashland (525) is a very close-grained silvery iron. The No. 3 Sloss silvery (794) contained nearly the same silicon and had a similar close grain. For 793 and 792 enough of these silvery irons were added to F^LM to make the silicon of the mixture 2.50%. If only an analysis of silicon and combined carbon had been made, it would have been conceded that 794 was better than 525.

TABLE LXXIV.

No. Test.	Name of Iron Melted in Crucible.	Dead Load.		Shrinkage.		Chill.
		Str.	Def.	$\frac{1}{4}'' \square$	$\frac{1}{10}'' \times 1''$	
441	F ^L M.....	362	.27	.168	.186	.40
525	No. 3 ashland silvery..	352	.15	.156	.155	.50
794	No. 3 Sloss " ..	260	.17	.184	.183	.01
793	441 + 525.....	378	.22	.143	.156	.23
792	441 + 794.....	407	.25	.190	.185	.15

	T.C.	G.C.	C.C.	Si.	P.	S.	Mn.
441	3.55	3.22	.33	1.25	.08	.04	.19
525	3.33	3.12	.21	4.70	1.54	.04	.96
794	1.21	1.16	.05	4.4111
793	2.50
792	2.50

As a reducer of shrinkage 525 is perfect, but 794 *increases* shrinkage. As a reducer of chill 794 is better than 525. The inability of 794 to reduce shrinkage seems to lie in its own lack of total carbon. Total carbon in 792 is decreased so much that the silicon had nothing to act on.

This proves positively that a silicon analysis, or silicon, sulphur, and combined carbon analysis, is not as safe a guide in the purchase of an iron as the shrinkage test, which is a mechanical analysis of all elements.

Table LXXVI shows that irons having nearly the same chemical composition may have totally different physical qualities.

TABLE LXXV.

No. Test.	Dead Load.		Impact.	Shrinkage.		Chill.	T. C.	G. C.	C. C.	Si.	P.	S.	Mn.
	Str'gth.	Def.		Str'gth.	$\frac{1}{16}'' \square$								
489	465	.21	348	.146	.150	.15	2.876	2.350	1.400	.083	.930
137	426	.15	231	.220	all374	1.848	.115	.176
143	336	.19	265	.150	.179	.04	3.230	2.770	.460	2.043	1.457	.027	.673
136	363	.14	226	.167	.193	.80	3.490	2.810	.680	.877	1.555	.039	.284
135	355	.13	193	.168	.190	.90	3.200	2.080	1.120	.882	1.792	.042	.204
141	375	.25	350	.144	.153	.00	3.320	2.900	.420	2.290	1.567	.023	.659
142	380	.26	390	.150	.157	.07	3.160	2.780	.380	1.310	1.482	.020	.648
138	327	.18	254	.162	.155	.01	3.420	2.940	.480	1.946	1.569	.019	.389
144	379	.24	356	.147	.153	.10	3.510	3.110	.400	1.531	1.535	.024	.623
139	390	.27	373	.124	.132	.00	3.260	3.080	.180	4.157	1.299	.019	.511
140	381	.21	390	.152	.143	.00	3.380	3.200	.180	4.349	1.544	.018	.480
108													
	Chattanooga, Tenn.,												
	No. 2.....	419	407	.154	.157	.04	3.209	3.045	.164	1.840	.399	.025	.370
166	Easley, No. 1 soft.....	353	339	.152	.160	.02	3.326	3.120	.206	3.470	.696	.085	.155
66	Star, Ohio No. 1.....	300	15	220	.160	.148	3.476	3.405	.071	4.387	1.470	Tr.	
178	Globe, " ".....	297	16	204	.187	.170	3.154	3.852	.302	5.899	1.100	.020	1.000
77	Ashland, Ohio No. 1....	310	19	101	.132	.141	3.240	3.034	.216	5.717	1.556	.040	.960
	" " " ".....	307	18	237	.137	.146	3.333	3.124	.209	5.602	1.543	.044	.963
58	Licking, Ky., No. 1.....	361	299	.137	.132	2.980	2.270	.710	4.780	1.025	.210	.850
59	" " " " B 1.....	340	.19	200	.120	.137	3.738	2.329	.205	.439
637	Calumet No. 1.....	290	.16	262	.139	.153	3.560	2.460	1.100	3.150	1.066	.020	1.350

On account of what has been shown there is no given shrinkage for any given percentage of silicon. There are two many unknown conditions occurring in foundry practice to make the metallurgy of cast iron an exact science. For these reasons it is impossible to prescribe a given chemical composition that will at all times give a required physical record. All estimates must be approximated.

TABLE LXXVI.

Melted in Cupola.	Carbon.	Silicon.	Strength.	Shinkage.
One mixture.....	3.24	2.87	485	.131
Another mixture.....	3.08	2.85	413	.172

Table LXXV gives the physical tests and chemical analyses of several pigs of iron for comparison. See also pages 167 and 195, and the physical and chemical tests of the nineteen A. S. M. E. series.

CHAPTER XIX.

TEST-BARS.

THERE is a difference in opinion regarding the best size of test-bars to use.

Test-bars $\frac{1}{2}$ " \square \times 12" are as small as it is practicable to make. For gray iron it cools so quickly that its grain is influenced very little by the time occupied by cooling, so that the variation in shrinkage more nearly agrees with variation in silicon than any other size. The measure of shrinkage of such a test-bar is a "mechanical analysis" for silicon.

Test-bars 1" \square have been more generally used than any other size.

Test-bars 2" \times 1" tested with the flat side down are used because some think they represent a casting 1 in. thick better than 1-in. square bars.

Such a bar is more inconvenient to handle and to make than a 1-in. square bar, and requires a larger testing-machine.

Test-bars 2" \square , 3" \square , and 4" \square are seldom used on account of the difficulty in breaking them. The slow cooling exerts more influence than the chemical composition.

The $\frac{1}{2}$ -in. square and the 1-in. square bars, on account of their convenience in making and in testing, seem the only sizes suited to general foundry testing, and taken together fix two points for the strength curve of Fig. 82.

The same size of test-bar should be used as far as possible to allow of a comparison of records. The routine of molding and testing should be the same. The smallest size that will run gray

should be used. Very little satisfaction will result from tests of white test-bars. Whatever size is used the strength of any other size of test-bar or of casting can be obtained by Fig. 82.

Advantages and Disadvantages of 1" □ Bars as a Test of Strength.—Some have conceived that the size of test-bar which would give the most uniform results for all cast-iron mixtures would be the best size for a standard. In examining Fig. 82, it is seen that as each curve crosses each of the others at a point near the 1-in. square bar, therefore the 1-in. bar shows very nearly the same strength for each percentage of silicon. Professor Turner estimates from his tests with a 1-in. square bar that 1½% silicon will make the strongest castings. But the maker of heavy castings knows, and Fig. 82 shows, that the 1% silicon iron or less will make a stronger heavy casting than one with a greater percentage.

The small variation in the records of 1-in. square bars shows that for castings about 1 in. thick a variation of 1% of silicon in the mixture does not make much difference in the strength of the casting, and this accounts for the success of the average founder who makes castings of about this thickness.

This showing will explain why the 1-in. square test-bar has been used almost universally, and why so little satisfaction has been found with the records of such test-bars. This was because the nature of cast iron has not been understood. The strongest iron is that which contains the amount of silicon necessary to remove brittleness and to produce the closest possible grain in the individual size of casting to be made.

Variation in Size of Test-bars Due to Poor Molding.—For very small changes in size of ½-in. □ bars there need be no calculated change in the strength record. By an examination of Fig. 82 it is seen that a very slight increase in size of a ½-in. □ bar causes a decided decrease in strength per ½-in. □ section because of the change in the ratio of cooling.

A measure of size of a cast-iron bar is at best only an approximate measure of section, for in any case the surface is uneven,

being a series of elevations and depressions corresponding to the shape of the grains of sand which composed the mold, and the caliper measures across the highest points.

A depression or a cold-shut, so small that it is difficult to detect it even after fracture, may act as a notch and often hastens fracture; and bars with the corners round on account of the corners not running full, even if the round corners are placed down, will often show as great strength as other full bars from the same ladle. Such round corners are perfectly smooth, never having touched the sand mold, and there are therefore no depressions to start a fracture.

A test-bar attached as a coupon to a larger casting is of no value, as the slow cooling caused by its location will enlarge its grain and diminish its strength.

CHAPTER XX.

KEEP'S TEST APPARATUS.

Keep's Test Apparatus for Mechanical Analysis.—Fig. 85 is an iron follow-board containing brass patterns for two test-bars $\frac{1}{2}$ " \square \times 12" long, with skim-gate, the iron entering on the under side of the test-bar. Iron yokes are used to chill the ends of the test-bars and to insure an accurate measure of shrinkage.

Fig. 86 is an iron flask to insure accurate size of bars.



FIG. 95.

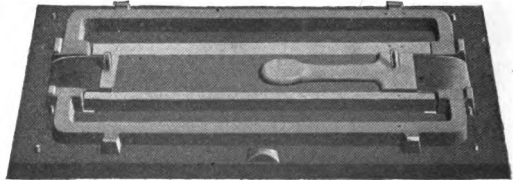

FIG. 85.—Keep's Test-bars $\frac{1}{2}$ " \square \times 12".

Moisten the chills with kerosene before and after using to prevent rusting. Mold test-bars in stove-plate sand without rapping

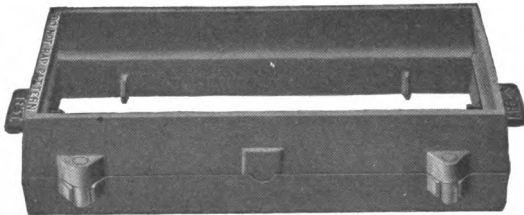

FIG. 86.—Flask for Test-bar $\frac{1}{2}$ " \square \times 12".

pattern and without facing. Mark the bottom of the mold with the same number of dots as appear on the chill-yokes. Remove

the sand that falls between the ends of the patterns and chills to give a full clean casting.

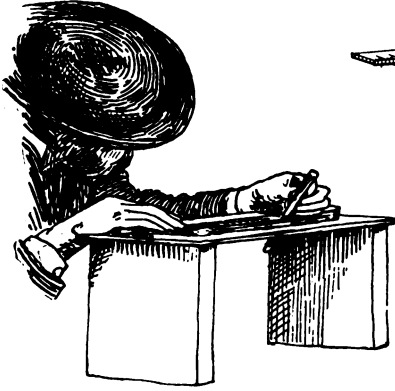

FIG. 88.



FIG. 87.

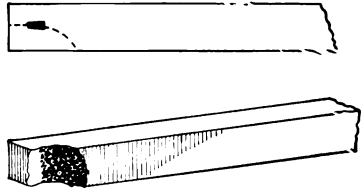

FIG. 89.

Place the castings on the follow-board exactly as the patterns lie, and *always* use the same yokes in which the bars were cast when you measure shrinkage (Fig. 88).

Pass the taper-scale (Fig. 87) without pressure between the end of the test-bar and the chill, and read the mark which appears at the upper surface of the bar as the shrinkage per foot. If greater than your standard, increase the silicon in the next cast; if less, increase scrap or low silicon iron.

Keep's Dead-load Testing Machine, No. 10 (Fig. 90). Capacity 1000 lbs.—Fasten the test-bar with gate-marks down in the flexible bearings. Clamp the pencil-arm to the center of the test-bar. Move the paper to draw a base line, then fasten the paper-holder to the chain behind it, and roll the load to 0;

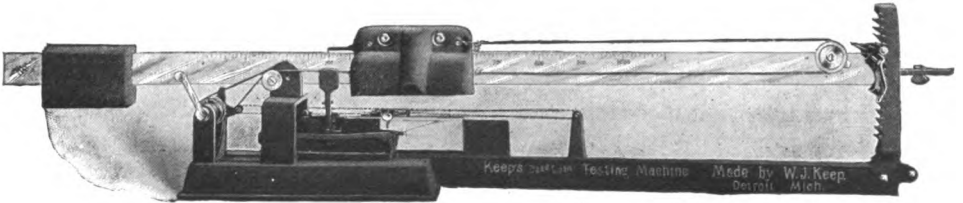

FIG. 90.—Keep's Dead-load Testing Machine, No. 10.

mark position of pencil, roll load until bar breaks, reading breaking load from the beam. Full-size diagrams are shown on page 161. To measure the chill, split the end of the bar as Fig. 89. Measure deflection with a scale marked 20th and read as 100th.

For Irons that are White in a $\frac{1}{2}$ -in. \square Test-bar, use a 1-in. \square test-bar and use No. 40 testing machine, Fig. 92. Fig. 91 is similar to Fig. 85, only the test-bar pattern is made of hard wood

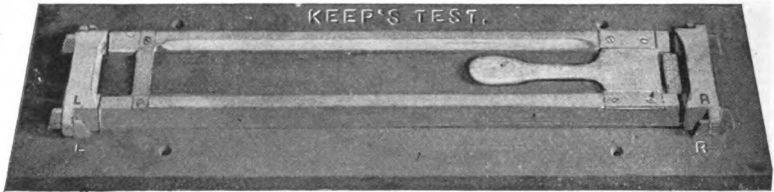

FIG. 91.—Keep's Test-bars 1" \square \times 24".

and is 1 in. \square and either 12 ins. or 24 ins. long. The 24-in. bar makes a better diagram than a 12-in. bar and leaves one or two 12-in. bars if a second test is desired. Take half the reading for the shrinkage per foot of a 24-in. bar.

Keep's Dead-load Testing Machine, No. 40 (Figs. 92 and 93). Capacity 4000 lbs.—After making a base-line, roll the load 100 lbs. back of 0, and place on the end of the beam weights to within 1000 lbs. of the load the test-bar will stand, which is known after a few trials. Roll the load to 0, mark the position of the pencil, roll the load forward until the bar breaks, and read the load from the beam. The diagram will be like the lower part of Fig. 94. To get a full record, after making a base-line, roll the load to 0, mark the position of the pencil, roll to 1000 lbs., raise the pencil from paper and roll back to 0; mark the position of the pencil to show set. Roll the load 100 lbs. back of 0, place very carefully 1000 lbs. on the end of the beam. Roll the load to 0, mark position of pencil, roll the load until the bar breaks, which gives the whole diagram of Fig. 94. A bar 1" \square \times 12" long would require two additions of weights to the end of the beam.

Advantages.—These machines are operated very rapidly. A few turns of a crank give a permanent and absolutely accurate

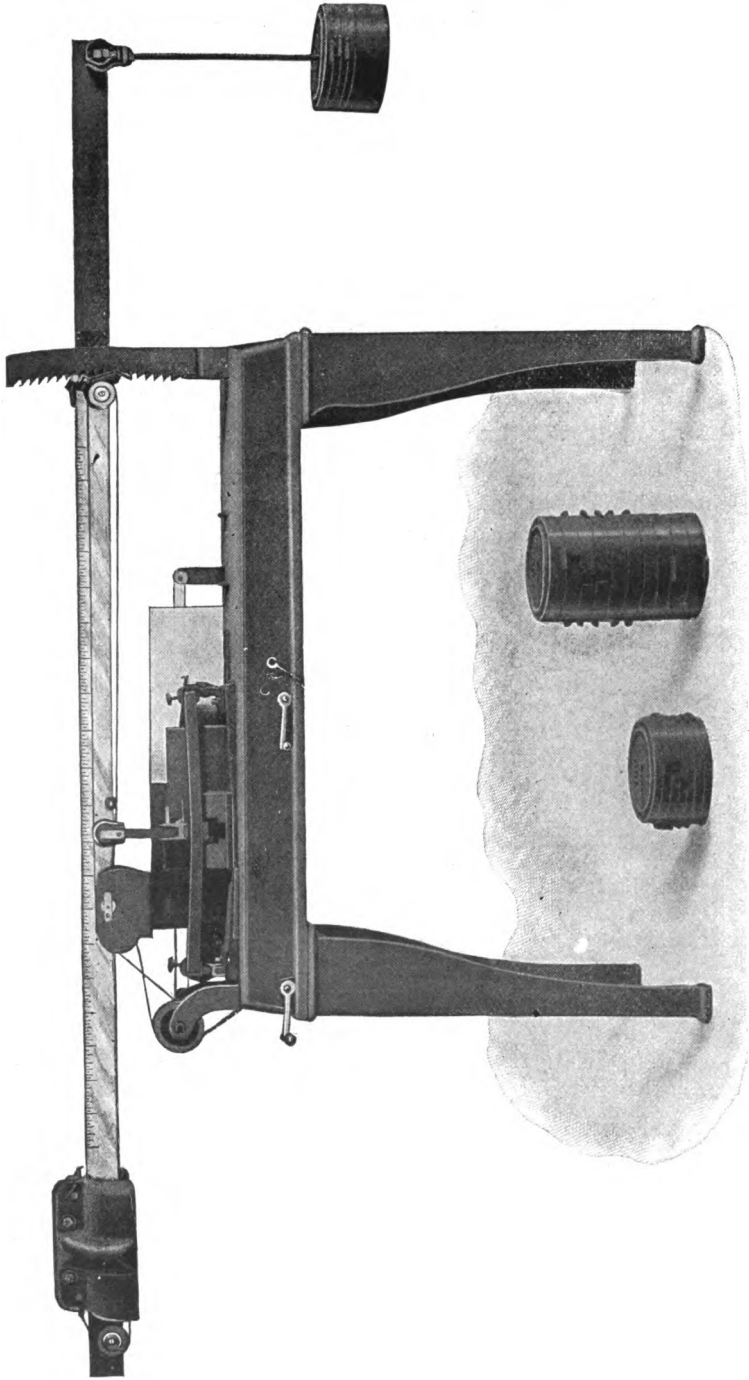

FIG. 92.—Keep's Dead-load Testing Machine, No. 40.

autographic record of the behavior of the test-bar at each instant of the test.

With a tester applying the load by a hand-wheel and screw,

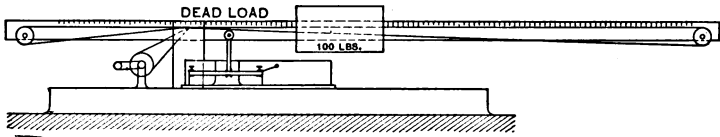

FIG. 93.—Outline of No. 40 Testing Machine.

and moving a jockey-weight to measure the load, the test-bar often breaks before the reading can be taken, and in any event the time taken would be from half an hour to an hour.

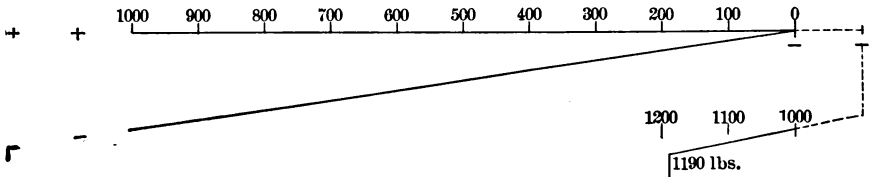

FIG. 94.—Diagram from Dead-load Machine, No. 40.

Fig. 95 shows *extension pieces* to allow test-bars to be used in ordinary testing machines. (Cut is with Fig. 85.)

Keep's Hardness Testing Machine (Fig. 96). (Chas. A. Bauer's Drill-test.)—A $\frac{3}{8}$ straight-fluted drill of standard hardness at 200 revolutions per minute makes an autographic record of the workability of a pig or test-bar to any depth, and shows tendency to sponginess or blow-holes.

A tray that slides under the table, on which the test-piece is clamped, catches all of the drillings for chemical analysis. The drill enters the test-piece on the under side, and each particle falls into the tray.

To the table, by four rods, is suspended a load near the floor so that, including the test-bar, the load on the drill-point is 150 lbs.

The table is raised, or lowered, or held by a hand-wheel at the top of the machine. The machine is started by a clutch, and

thrown out at any desired point by a trip. The downward motion of the table is transferred through steel ribbons, through a ball-bearing arm, to the pencil, which makes a record on a curved

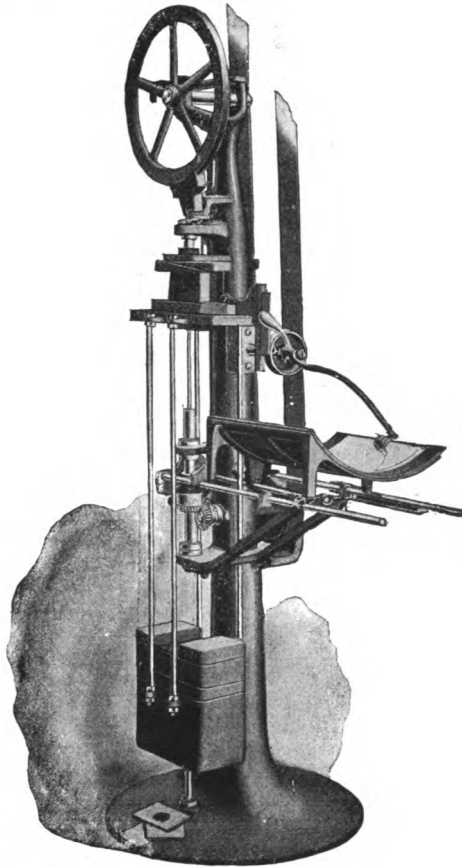

FIG. 96.—Keep's Hardness-testing Machine.

paper-holder which moves at right angles to the path of the pencil by means of a screw.

For diagrams see Fig. 84, Chapter XVI, p. 165.

Wet Grinder for $\frac{3}{8}$ Drills, making both lips to cut exactly alike with standard angles (see Fig. 97).—Enter the drill in the holder

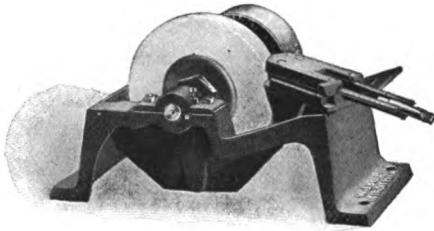

FIG. 97.—Keep's Wet Drill-grinder.

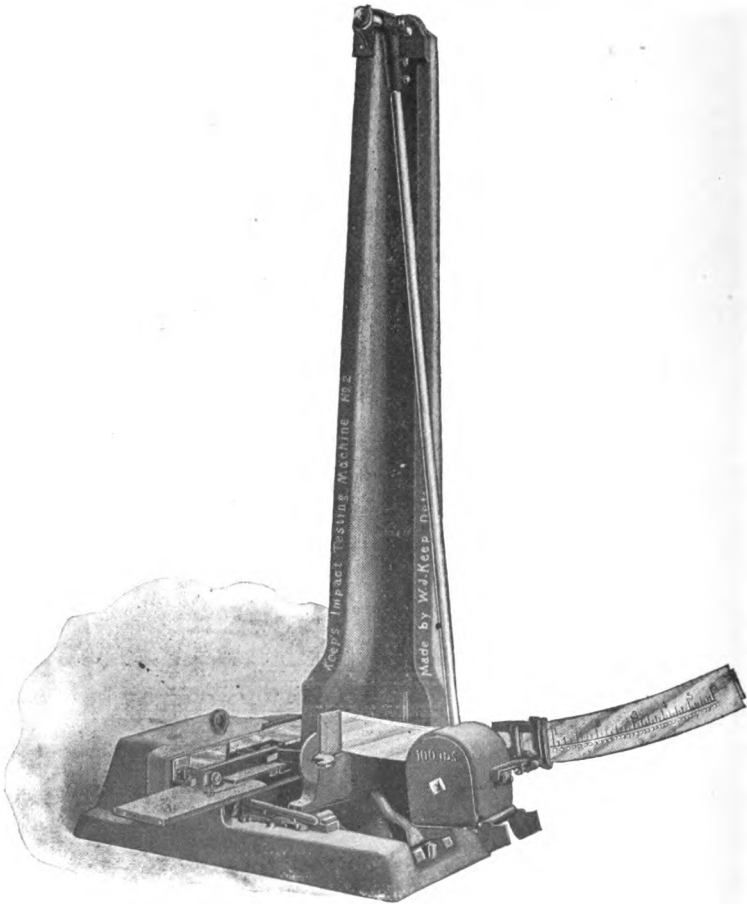

FIG. 98.—Keep's Impact-testing Machine, No. 2.

with the cutting edges horizontal, while the holder is clear up to the stone.

Tighten the set-screw to hold the drill and press the drill against the stone until it will cut no more. Turn the holder over and press the other lip against the stone as before.

Keep's Impact-testing Machine, No. 2 (Fig. 98).—The anvil weighs 1000 lbs., and the hammer is varied from 25 to 100 lbs. It tests up to 1" \square \times 24" bars.

Recorder for No. 2 Impact, or No. 40 Dead-load Machine (Fig. 99).—It multiplies the movement of the center of the test-bar five times, and a parallel motion gives the pencil a vertical motion.

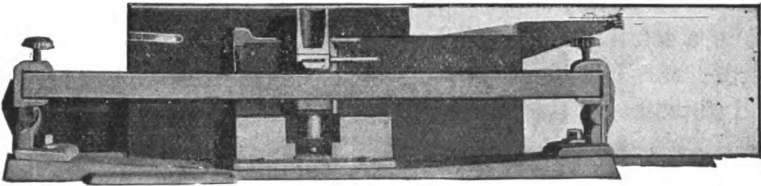

Recorder for No. 40 Dead-load and No. 2 Impact Machines.

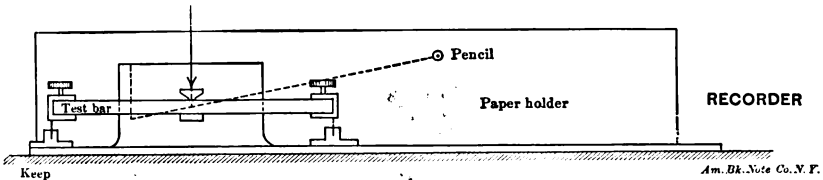

FIG. 99.—Outline of Recorder.

Operation.—The test-bar is clamped in position. The location of the pencil is marked on the paper. The hammer is hung on the graduated arc for a $\frac{1}{8}$ -in. drop. A trip releases the hammer, which swings against the test-bar. On its rebound it is caught by the operator's left hand and returned to the trip, which has been moved to $\frac{1}{4}$ -in. drop with his right hand. The left hand depresses a lever on the bed-plate, which moves the paper $\frac{3}{16}$ in., and so on. The highest drop is 6 ins. After the test a base-line is drawn parallel to the edge of the paper. The autographic

diagrams, Figs. 69 to 74, Chapter XIV, show deflection and set for each blow. Use a 25-lb. hammer for a $\frac{1}{2}$ -in. \square bar, and a 100-lb. hammer for a 1-in. \square bar.

Professor Thomas Turner's Hardness-test Machine (Fig. 100).—The number of grams on a diamond that are required to

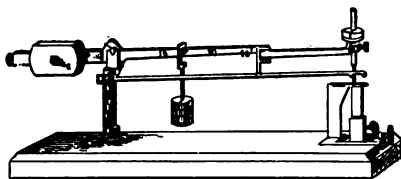

FIG. 100.—Professor Turner's Hardness-test Machine.

make a scratch on a polished surface is used as the degree of hardness. This is especially adapted to white and chilled iron and to tempered steel.

Keep's Cooling-curve Machine (Fig. 101).—This makes an

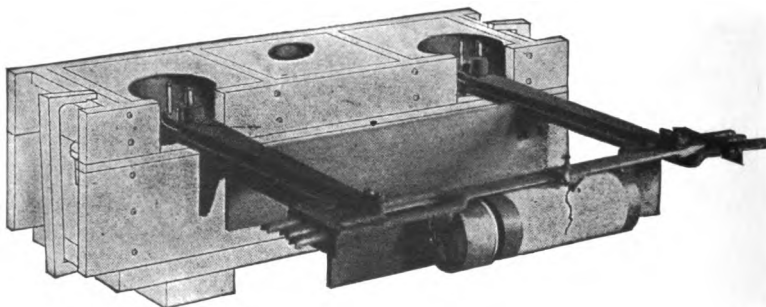

FIG. 101.—Keep's Cooling-curve Recording Machine.

autographic record of the behavior of a test-bar 1" \square \times 24" long, while becoming solid, while graphite is forming, and during cooling. The recording drum is moved by a clock. It also makes a diagram of the critical points of iron and steel.

One-half-inch Test-bar Patterns with Yokes.—Fig. 102 shows an iron follow-board with two brass $\frac{1}{2}$ -in. \square test-bar

patterns, and Fig. 103 shows one $\frac{1}{2}$ -in. \square test-bar with one $\frac{1}{10}'' \times 1''$, all 1 ft. long, used for tests recorded in this book.

Yokes with the taper-scale are used for measuring shrinkage.

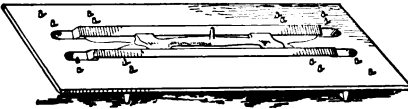

FIG. 102.

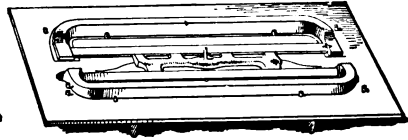

FIG. 103.

Record-paper.—One-hundred-pound manila paper makes the best diagram. Strips $3\frac{1}{8}$ ins. wide and 14 ins. long fit No. 10, and $6\frac{1}{8}$ ins. wide and 18 ins. long fit No. 40 recorder.

CHAPTER XXI.

PIG IRONS AND SILICON IRONS.

Pig Iron.—Cast iron from the blast-furnace is run into a pig-bed, the runner which feeds the pigs being called a sow. In America the pig-bed for all the irons to be used in the foundry is generally made in sand, and sand is often thrown on the surface of the pigs to cause the iron to cool more slowly, that the fracture may show an open grain and dark color.

Pig iron is graded into different classes according to the color or the size of the grain, or to the percentage of silicon indicated by analysis. On account of silicon changing combined carbon into graphite, hereby softening iron, silicon irons have come to be called “softeners.”

Ferrosilicon is the name applied to irons which carry 10% and over of silicon. The fracture of the pig is coarser than No. 1 Silvery in Fig. 104.

Flaky Silvery, named from the appearance of its fracture, is made in a very hot furnace, and generally contains from 7% to 10% silicon.

No. 1 Silvery (Fig. 104).—An open-grained, light-colored iron, with more than 6% silicon.

No. 2 Silvery (Fig. 104) is of closer grain than No. 1.

No. 3 or Close Silvery (Fig. 105).—Quite often silvery iron is offered for sale that has a very close uniform grain and which has the ring of white iron. It is not generally very high in silicon, averaging perhaps 4.50% to 6%.

The Tennessee Coal, Iron and R. R. Co. selected sample pigs from the eleven grades of iron made by them, and after

No. 1.
Silvery.

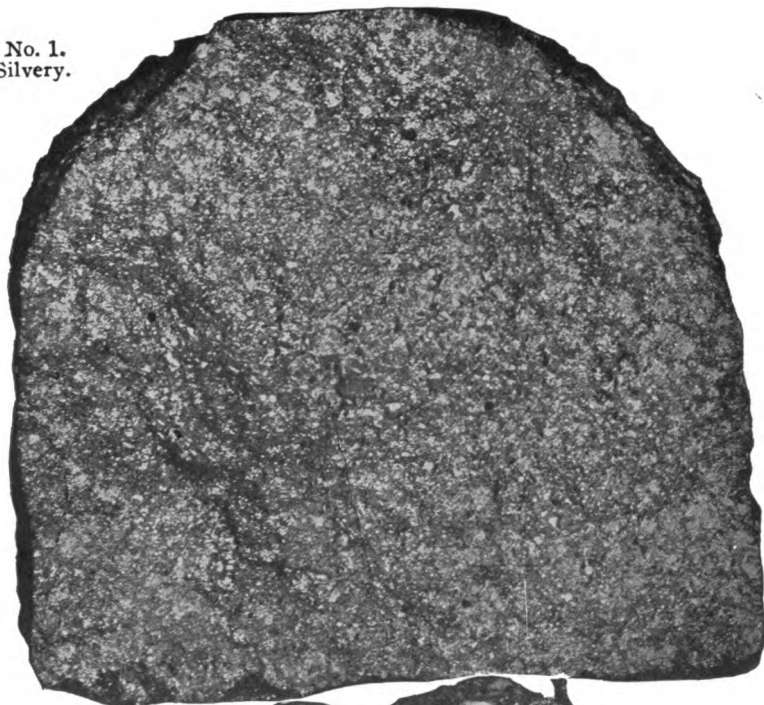

No. 2.
Silvery

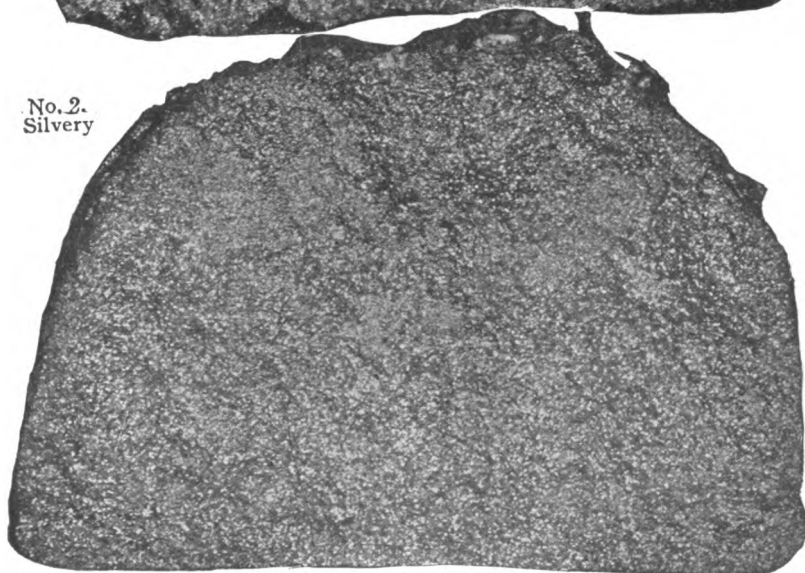

FIG. 104.

Southern
Silvery
Grey.

No. 3.
Silvery

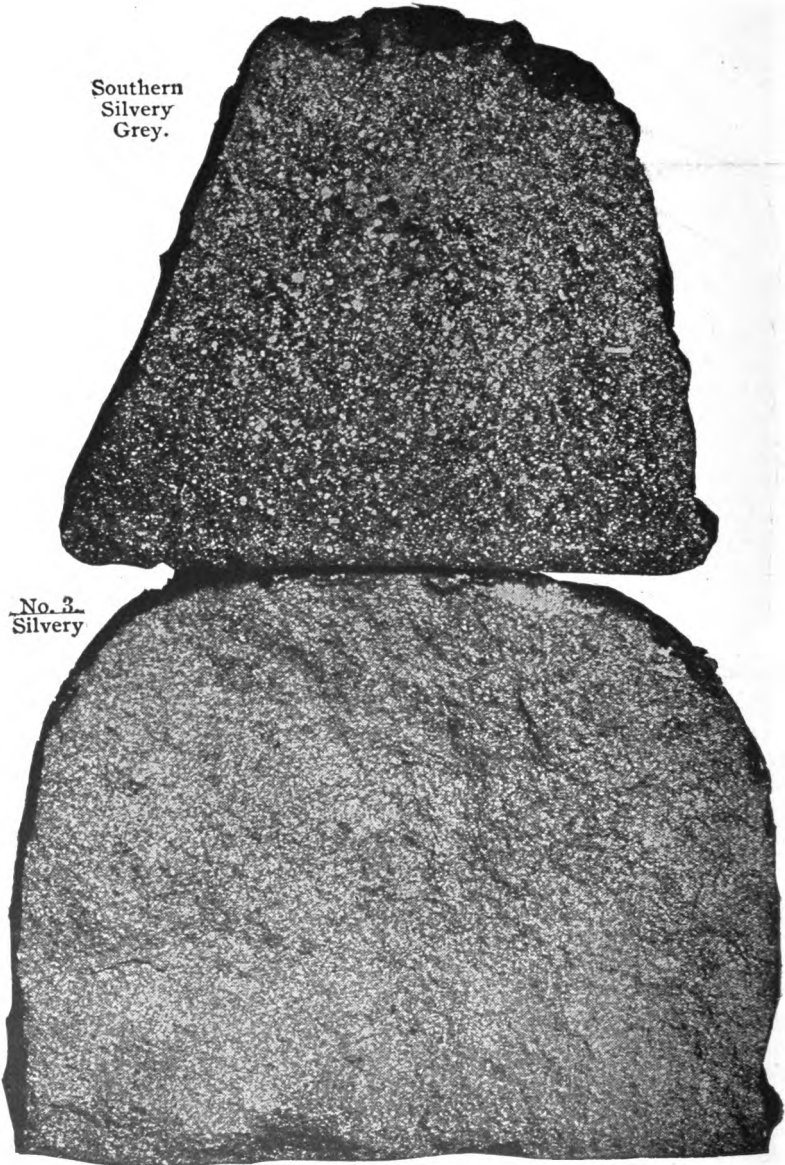

FIG. 105.

making a very careful chemical analysis sent the pigs for use in this description. Table LXXVII gives for ready reference both the composition and physical qualities of these samples.

TABLE LXXVII.
ANALYSIS OF PIG IRONS AND SI. IRONS.

CHEMICAL ANALYSIS.

No. of Test.	Southern Pig Iron.	Total Carbon.	Graphitic Carbon.	Combined Carbon.	Silicon.	Phosphorus.	Sulphur.	Manganese
731	No. 2 silvery.....	1.51	0.58	0.93	4.91	0.58	0.08	0.25
730	" 1 "	2.17	1.60	0.57	4.70	0.59	0.06	0.27
728	" 1 soft.....	2.94	2.11	0.83	3.65	0.60	0.06	0.27
729	" 2 "	2.81	2.00	0.81	3.24	0.76	0.05	0.21
721	" 1 foundry.....	2.88	2.42	0.46	2.53	0.60	0.04	0.23
724	Foundry forge.....	2.29	2.28	0.01	2.16	0.62	0.19	0.19
722	No. 2 foundry.....	2.16	1.90	0.26	2.00	0.79	0.08	0.23
723	" 3 "	2.14	2.04	0.10	1.83	0.77	0.10	0.31
725	Grey forge.....	1.79	1.51	0.28	1.74	0.70	0.17	0.38
726	Mottled	2.74	1.00	1.74	1.36	0.76	0.36	0.31
727	White.....	2.01	0.67	1.34	0.94	0.76	0.42	0.29

PHYSICAL ANALYSIS.

No. Test.	Southern Pig Iron.	Dead Load.		Impact.		Shrinkage.		Chill.
		Strength.	Def.	Strength	Def.	Square	Flat.	
731	No. 2 silvery.....	295	.24	305	.27	.140	.136	.01
730	" 1 "	360	.27	407	.32	.131	.138	.02
728	" 1 soft	375	.27	407	.32	.149	.157	.04
729	" 2 "	293	.25	322	.32	.130	.154	.02
721	" 1 foundry	384	.25	407	.30	.156	.145	.01
724	Foundry forge....	362	.20	305	.21	.164	.164	.15
722	No. 2 foundry....	365	.27	373	.30	.159	.161	.01
723	" 3 "	354	.19	254	.20	.161	.148	.30
725	Grey forge.....	365	.23	356	.27	.160	.163	.0
726	Mottled	372	.11	186	.14	.226	.218	white
727	White.....	435	.13	237	.15	.240	white

Fig. 106 shows the appearance of the fracture of these first samples of Southern irons and of various silicon irons in a $\frac{1}{2}$ -in. □ test-bar.

The drawings of fractures of silicon pigs in this chapter

are from a set of Ashland pigs with silicons determined by analysis.

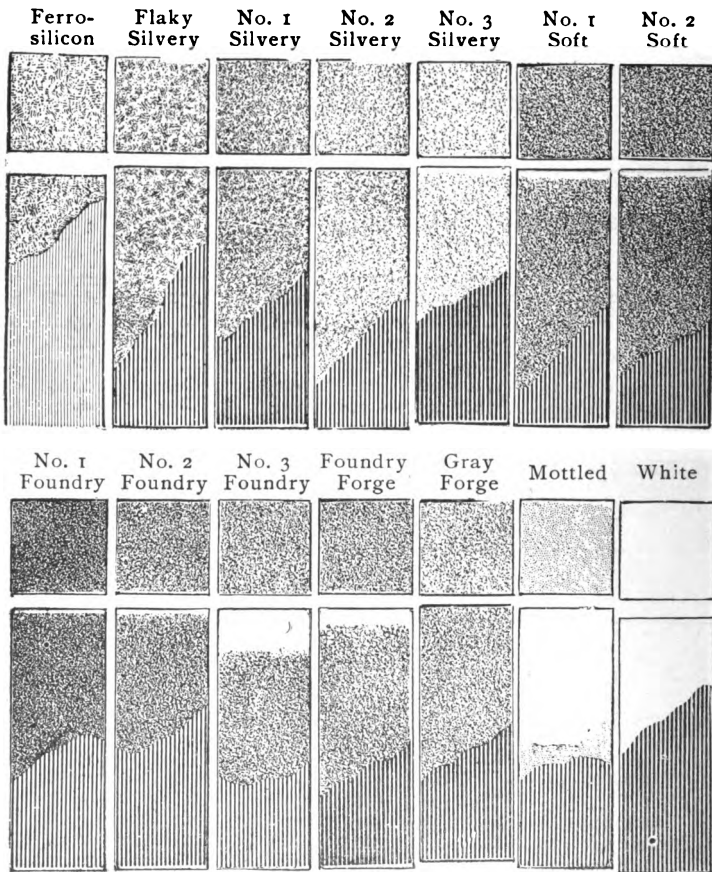

FIG. 106.—Fractures of Test-bars $\frac{1}{2}$ " \square .

The fractures of Southern pigs in this chapter are from a second set sent by the Tennessee Coal, Iron and R. R. Co. without silicon analysis. The fractures represent their ordinary grading.

Southern Silvery (Fig. 105) is made when the furnace is very hot and is not a regular product. It is as good a softener as regular silvery iron. The silicon ranges between 4% and 5%.

No. 1 Soft and *No. 2 Soft* (Fig. 107) are grades peculiar to a

No. 1
Soft.

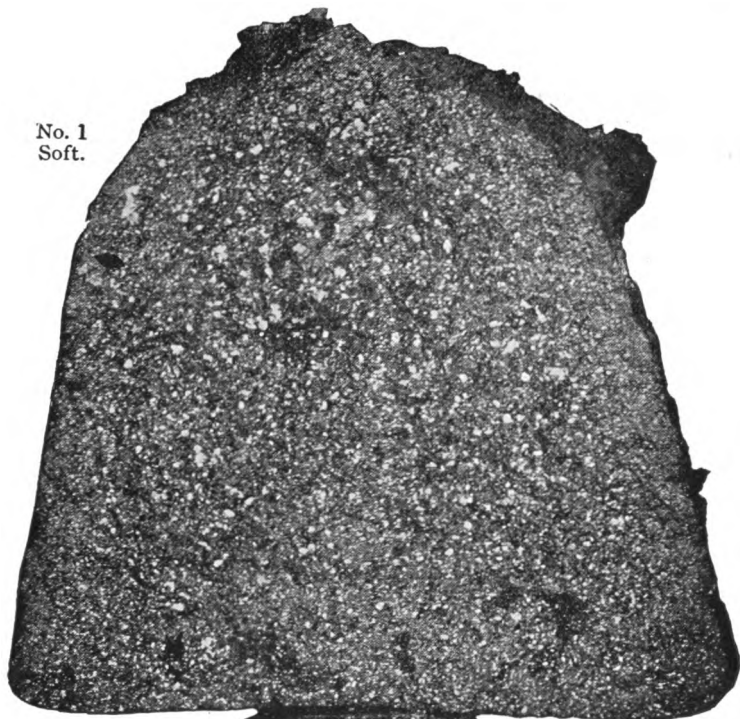

No. 2
Soft.

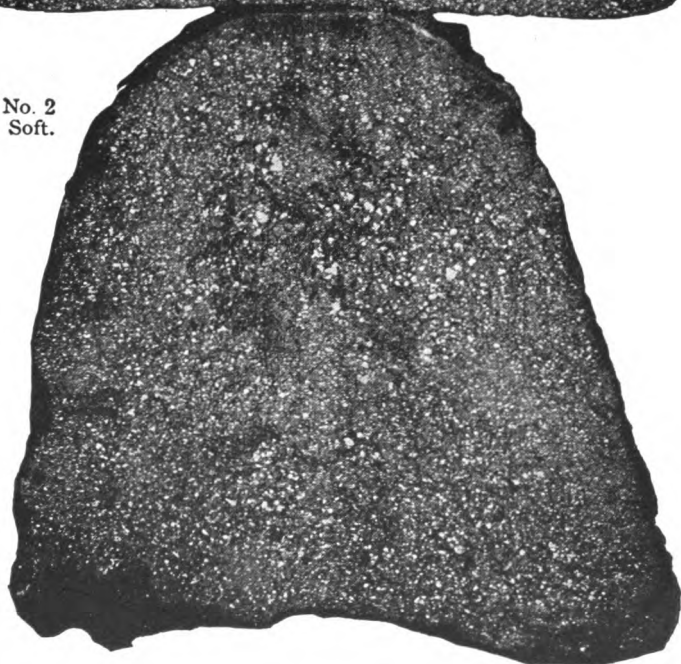

FIG. 107.

Southern furnace. They contain too low silicon to be classed as silvery iron and too much to be classed as foundry iron. If the fracture is close it is No. 2 soft. Both are expected to contain over 3.25% silicon. These pigs have a smooth face. There is a temptation to mix close-grained light-colored low silicon irons with No. 2 soft before shipping.

No. 1 Foundry (Fig. 108) is a choice grade, having coarse grain and dark color. It makes fine-appearing and accurate thin and intricate castings. The surface of the molten metal is dark and sluggish looking, and does not give off sparks. Under the surface of the melted iron there are splashes of light. The pig has a blue velvet face where the surface is smooth.

No. 2 Foundry (Fig. 108).—The fracture is lighter in color than No. 1, and usually the surface of the pig is smoother. The grain is closer and there is often a closeness around the edges of the pig. It is generally a little harder and stronger than No. 1 and it is not quite as fluid, as its carbon and silicon are generally less. The surface of the melted iron is a clearer red, and throws off some sparks, splashes only a little as it cools, and its surface exhibits a series of lines or figures ever varying as though the surface were in circulation, such appearance continuing until the iron becomes pasty. The closeness of No. 2 may often arise from the way it is handled in the pig-bed, and it often has as high carbon and silicon as No. 1. It is generally as good an iron as is needed for the best foundry castings.

No. 3 Foundry (Fig. 109).—The fracture is still lighter in color, the crystals are much smaller, and the fracture is smoother but contains some pits. It is stronger than the preceding grades. It contains less silicon and carbon than Nos. 1 and 2, and has not the same fluidity. The molten metal throws off sparks abundantly as it runs from the cupola. The surface figuring is less apparent than with No. 2. It is used in the foundry for heavy work, but it will not take much scrap on account of its low silicon.

No. 4 Foundry or Foundry Forge (Fig. 109) is a grade that

No. 1
Foundry.

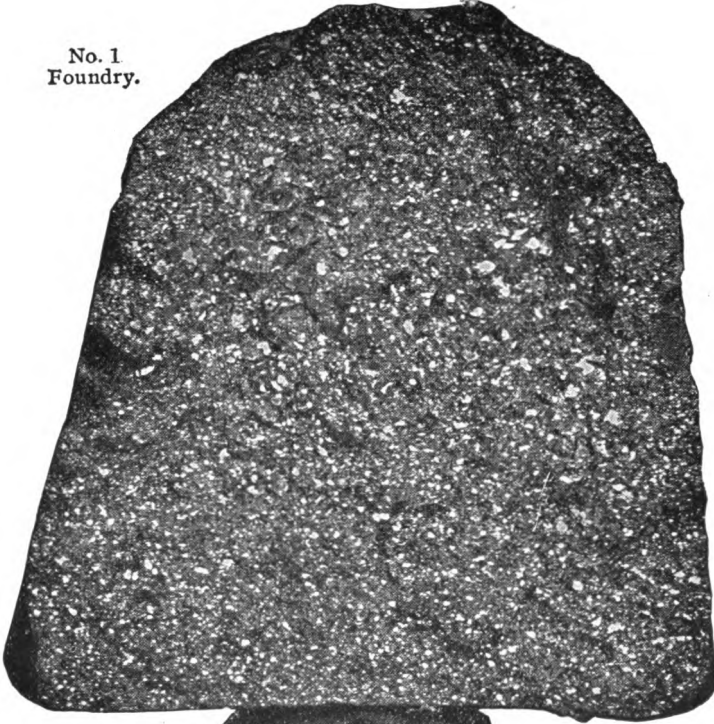

No. 2
Foundry.

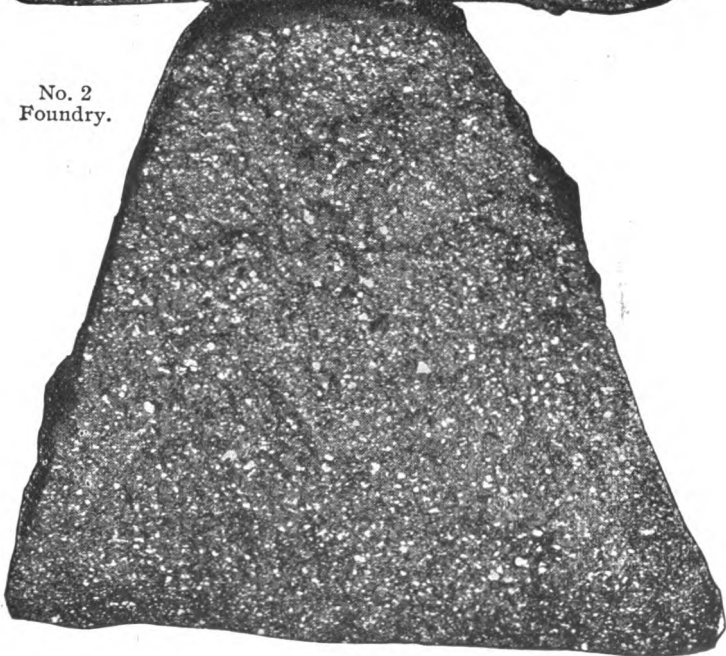

FIG. 108.

No. 3
Foundry.



No. 4
Foundry.



FIG. 109.

is too close and with silicon too low for No. 3 Foundry and too open for Gray Forge. The surface of the pig has larger and more pits than No. 3.

Gray Forge is known by its larger pits. It has too close a grain to be classed as Foundry Forge. It may be used to advantage for heavy castings. In Chapter XVI, Table LXX are given analyses and records of tests of several Gray Forge Irons.

Mottled is the highest pitted iron that is made. The name does not indicate any grade, but a mottled appearance of grain formation. The iron may be quite gray, or it may be white with only a gray tinge. The latter would be high mottled.

White is made in a cold furnace and carries more sulphur than any other grade.

One of the advantages of making the pigs of foundry iron in iron molds or in one of the modern casting machines would be that the fracture of the pig would indicate the kind of casting that the iron would make. A non-chilling iron would show a gray even fracture against the mold as in Fig. 59, while the slightest tendency to chill would be shown in chilled surfaces of the pig. The close-grained foundry iron which is cast in iron molds will make as soft castings as the same iron pigged in sand. (See Table LXIII.)

REMARKS ON SILICON IRONS.

Weakness of Silicon Irons.—Softeners are invariably weak in the pig and would make very brittle and weak castings if used alone or to excess. Silicon irons often run from 1% to 2% phosphorus. Mill cinder is quite extensively used in the ore mixture for silicon iron, and imparts a silvery whiteness to the pig.

History of the Use of Silicon Iron.—Until within the last fifty years Scotch pig iron which contained about 3% silicon was imported and used as a softener. It was found that No. 1 American pig was often as good a softener as Scotch pig. About thirty years ago it was found that the iron ores found in Ohio

would make a peculiar light-colored iron which imparted great fluidity and softness to the irons made from the refractory Lake Superior ores. At once these irons took the name of *Ohio Softeners*.

In 1888 the author made a large number of tests to determine the influence of remelting on silicon. The tables of records and remarks can be found in *Trans. A. I. M. E.*, vol. xvii. pp. 252-261. In remelting in a crucible not in contact with blast, the loss of silicon in irons containing less than 10% of silicon was 0.55%, and of the irons containing over 10% the loss was 2.80% of the silicon contained. In a second remelting the proportion of the loss was reversed, but the loss was very small in either case.

It was proved that in the use of silicon iron to impart silicon to low-silicon irons the mixture contained within 0.10% of what was calculated. The percentage loss was, however, not half as much when silicon irons with less than 6% silicon were used.

CHAPTER XXII.

TESTING SMALL SAMPLES OF PIG IRON.

A CRUCIBLE furnace may be made by lining a sheet-iron drum 26 ins. diameter and 30 ins. deep with fire-brick set on end. It should be set in a pit with its top even with the floor. Cross-bars are fixed across the brick ashpit to allow 1-in. square grate-bars to slide under the furnace. The upper part should be connected to a chimney 12 ins. square inside and 30 ft. high to give a natural draft. The furnace-top is closed with a round cover. Seventy-two-hour coke is the best fuel. A No. 16 brass crucible is the most convenient size and can be handled with long-handled tongs taking hold of the edge. The crucible will settle down as the fuel burns away. Fifteen pounds of iron will melt in from 30 to 45 minutes. When the pot and iron cannot be seen in the furnace the iron is fit to pour.

By keeping the furnace ready for use, after lunch a fire can be put in, and when hot the iron can be melted before four o'clock, when the molder would have put up his day's work and can put up a flask of test-bars.

A Small Cupola.—A sheet-iron cylinder 16 ins. diameter and 4 ft. high, with a cast-iron bottom bolted on, is lined 2 ins. thick with pounded fire-brick and fire-clay. This is set on a block of stone about 2 ft. from the floor. Just above the bottom lining is fixed a spout lined like the cupola, and a foot above is a 3-in. pipe fastened to the side for a tuyere. Bring wind from a small

fan by a portable pipe. When a heat is to be made, put in enough 72-hour coke the size of a hen's egg to heat the cupola red hot, and to leave the incandescent coke 14 ins. above the tuyere. Then charge the iron and cover with coke. Such a test is almost exactly like using iron from an ordinary cupola.

CHAPTER XXIII.

ALUMINUM IN CAST IRON.

A NUMBER of series of tests were made in 1887 with both FLM and with "Gaylord" white pig iron, introducing aluminum by ferroaluminum (containing 10% Al. and 3% Si.).

After the results of these tests were published it was claimed that the 3% of silicon produced the results.

TABLE LXXVIII.

Calculated.				Actual Percentage found in Test-bars.										
No. of Test.	Aluminum.	Silicon.	Silicon for Actual Al.	Aluminum.	Silicon.	Total Carbon.	Graphite.	Comb'd Carbon.	No. of Test.	Silicon.	Total Carbon.	Graphite.	Comb'd Carbon.	
WHITE BASE IRON AND ALUMINUM.									WHITE REMELTS.					
Pig.	.00	.186	.18	.00	.186	2.98	.95	2.03	Pig.	.186	2.93	0.95	2.03	
363	.00	.18	.18	.00	.08	2.98	1.27	1.71	376	.25	3.13	1.62	1.51	
364	.25	.26	.27	.25	1.37	377	2.97	2.14	.83	
365	.50	.35	.36	.54	2.84	1.35	1.40	378	3.12	1.53	1.59	
366	.75	.43	.47	.89	3.10	1.81	1.29	379	2.75	1.83	.92	
367	1.00	.52	.62	1.28	.62	2.90	1.71	1.19	380	.12	1.57	
									381	.12	2.52	1.44	1.08	
FLM GRAY IRON AND ALUMINUM.									FLM REMELTS.					
Pig.	.00	1.25	1.25	.00	1.249	3.55	3.22	.33	Pig.	1.249	3.55	3.22	.33	
368	.00	1.25	1.25	.00	1.245	3.41	2.26	1.15	382	1.160	3.97	2.81	1.16	
369	.25	1.33	1.28	.10	4.09	2.72	1.37	383	2.61	2.37	.24	
370	.50	1.41	1.29	.14	3.55	2.66	.89	384	3.86	2.98	.88	
371	.75	1.50	1.37	.32	3.53	2.78	.75	385	3.57	2.60	.97	
372	1.00	1.58	1.50	.75	3.45	2.56	.89	386	3.65	2.77	.88	
373	2.00	1.92	1.75	1.50	3.58	2.50	1.08	387	3.37	2.32	1.05	
374	3.00	2.26	1.99	2.23	3.34	2.76	.58	388	3.72	2.49	1.23	
375	4.00	2.70	2.54	3.84	2.280	3.10	2.44	.66	389	.978	3.53	1.82	1.71	

WHITE IRON AND ALUMINUM, COWLES' AND PURE METAL.

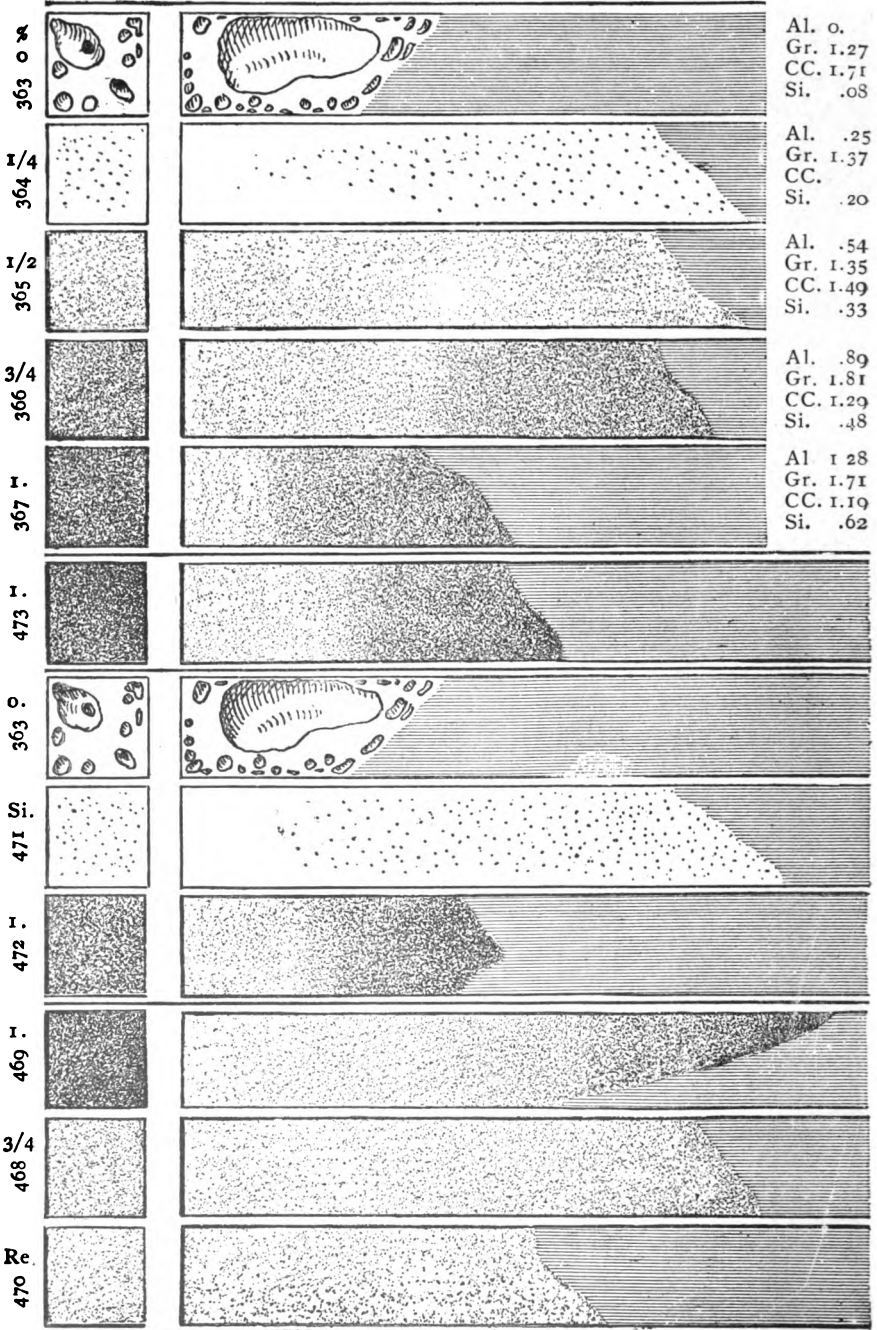

FIG 110.

The author then repeated the tests, using pure aluminum. Fractures of the test-bars are shown in Figs. 110 and 111. The chemical analyses are given in Table LXXVIII and in Figs. 112, 113, and 114. The test numbers of bars accompany each record for reference.

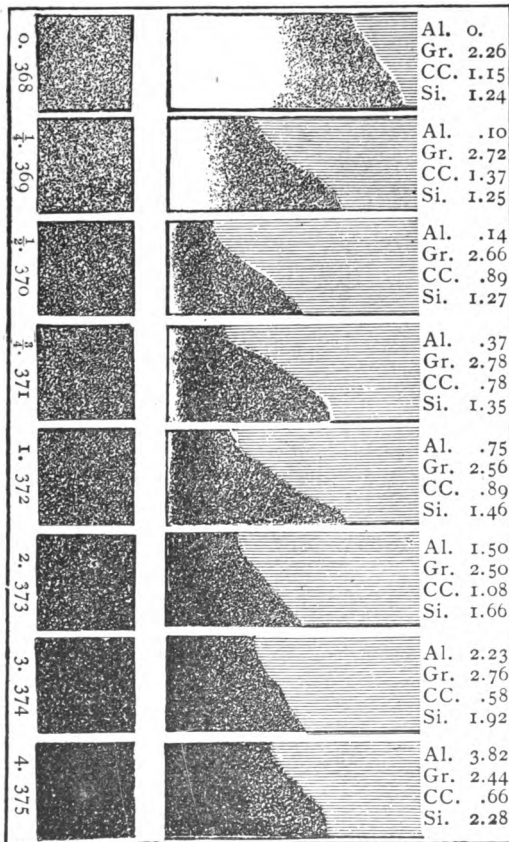

FIG. 111.—F²M Gray Iron and Aluminum.

Influence of Aluminum on the Grain of Cast Iron.—In tests with white iron, Fig. 110, in bar 364 one quarter of 1% of aluminum has prevented blow-holes. Test-bar 471 made with silicon alone

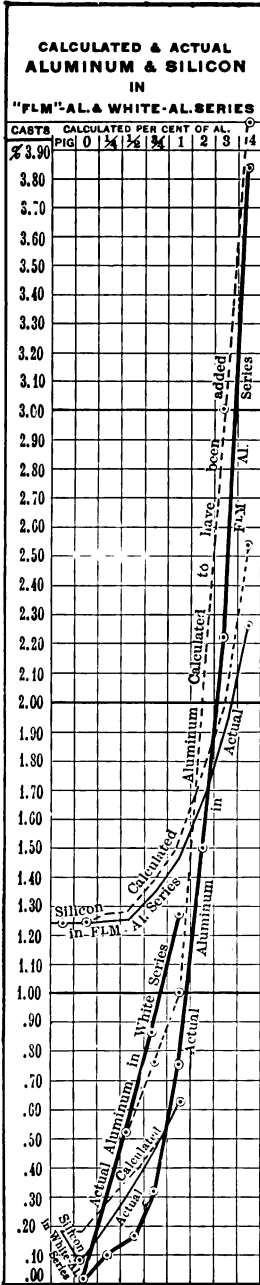

FIG. 112.

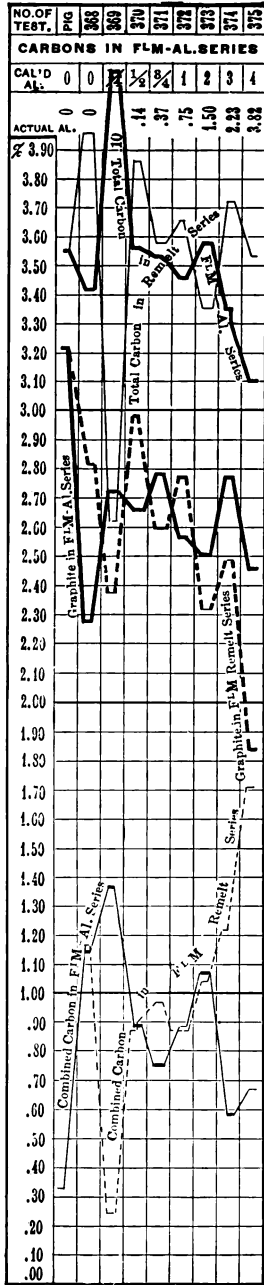

FIG. 113.

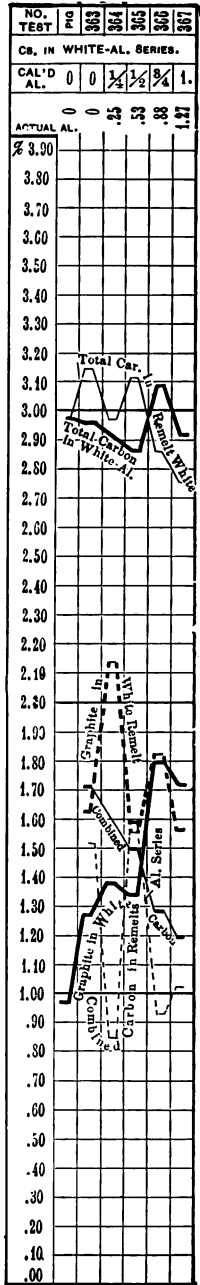

FIG. 114.

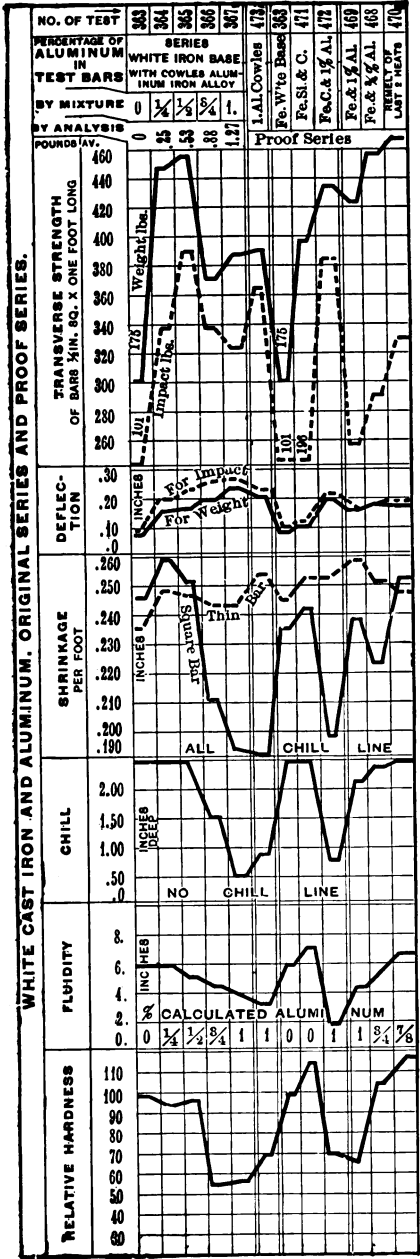

FIG. 115.

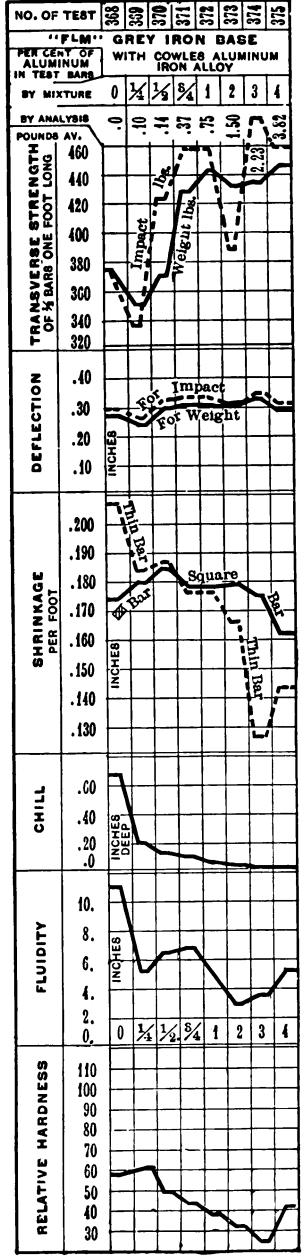

FIG. 116.

is free from blow-holes. In 365 one half of 1% of aluminum has made the test-bar a light gray. In 366 with 0.75% of aluminum, the casting is decidedly gray, and in 367 with 1.28% of aluminum the chill is reduced to $\frac{1}{2}$ in.

Test-bar 473 was made to prove 367, and when compared with 366 and 367 it is just what a 1% bar should be. So far the aluminum was introduced by 10% ferroaluminum. There was added to 471 exactly the same silicon and carbon as there was in 473. The difference in the appearance is due to the aluminum in 473. One quarter of 1% of aluminum in 364 produced the same effect as 0.62 silicon in 471. Pure Al. added to 471 made 472 the exact duplicate of 473.

The grain is the same, and these tests prove that 0.50% of Si. and 1% of Al. will change a white porous iron into a solid gray casting.

The author added 1% pure aluminum to white iron to make 469, and 0.75% Al. for 468. (See also 440 of Fig. 30, Chapter IX.) This shows that Al. alone will make solid gray castings out of porous white iron.

It had been claimed that aluminum would not stay in a casting. 468 and 469 were melted together and produced 470, which was still gray, showing that the Al. was still there. Fig. 111 shows the influence of Al. from 0 to 3.82%. The formation of an intensely black grain directly back of the chill was first shown in Fig. 111 in 1887, and it was soon found to be more or less apparent back of any chill. Analysis of similar castings shows more graphite just behind the chill in this dark portion than farther back where the casting cooled more slowly.

The author's discovery of the influence of aluminum on cast iron was made in 1887 and published August, 1888 (see Trans. American Association for the Advancement of Science, 1888).

Aluminum in Steel Castings.—Very full records are in Trans. A. I. M. E., vol. XVIII. pp. 835-850.

Aluminum in Wrought-iron Castings, *ibid.*, pp. 851-858. These were the first series of records made to show the influence

of Al. in steel and wrought iron. Castings were made of both steel and wrought iron with 0.25%, 1%, 2%, and 3% aluminum. The Mitis Co. had used Fe.Al. for some time in castings of wrought iron, but never used more than 0.25%, and they claimed that none of the aluminum remained in the casting, and that its only effect was to make a sound casting. Dr. Mabery's analyses proved that aluminum remained in the casting.

The author discovered that iron with 50% of Al. would in a short time fall to a powder. These experiments for the first time determined the shrinkage of Al. and the influence of Al. on the shrinkage and strength of steel and cast iron.

CHAPTER XXIV.

INFLUENCE OF VARIOUS METALS IN CAST IRON.

THE object of this chapter is to show the effect of a chance introduction to F^LM (Method 3) of the more common metals into cast iron. Instead of using cupola iron the F^LM was melted in a crucible.

TABLE LXXIX.

No. Test.	Melted in a Crucible.	Dead Load.		Impact.		Shrinkage.		Chill.
		Str.	Def.	Str.	Def.	$\frac{1}{2}'' \square$	$\frac{1}{16}'' \times 1''$	
755	Nickel alone.....	500	.18	400	.21	.198	.195	
756	F ^L M o% Nickel.....	375	.28	356	.30	.169	.190	.90
757	“ $\frac{1}{4}$ “	327	.23	356	.29	.178	.200	.70
758	“ $\frac{1}{2}$ “	295	.19	246	.19	.184	.205	.70
	“ $\frac{3}{4}$ “	330	.24	356	.26	.190	.192	.70
	Copper alone.....	60	.11248		
751	F ^L M o% Copper.....	379	.27	390	.30	.172	.187	.70
752	“ $\frac{1}{4}$ “	375	.25	348	.26	.172	.195	.60
753	“ $\frac{1}{2}$ “	370	.23	337	.25	.173	.198	.60
754	“ $\frac{3}{4}$ “	383	.23	432	.28	.173	.198	.50
	Zinc alone.....	50	.05148		
759	F ^L M o% Zinc.....	363	.28	382	.31	.168	.182	.60
760	“ $\frac{1}{4}$ “	340	.22	373	.28	.169	.190	.60
761	“ $\frac{1}{2}$ “	341	.22	381170	.195	.50
762	“ $\frac{3}{4}$ “	330	.1816640
	Tin alone.....	20	.09053		
763	F ^L M o% Tin.....	370	.25	322	.25	.168	.185	.70
764	“ $\frac{1}{4}$ “	357	.23	399	.28	.178	.195	.70
765	“ $\frac{1}{2}$ “	357	.21	350183	.200	.60
766	“ $\frac{3}{4}$ “	333	.20	305	.23	.187	.199	.50
	Lead alone.....	10	.04113		
767	F ^L M o% Lead.....	387	.24	350	.22	.125	.141	.03
768	“ $\frac{1}{4}$ “	377	.22	350128	.137	.02
769	“ $\frac{1}{2}$ “	390	.22	407129	.138	.03
770	“ $\frac{3}{4}$ “	390	.21	365129	.138	.01
776	“ 1st set.....	403	.21	296	.22	.127	.140	.02
777	“ 2nd “	463	.26	313126	.137	.02
778	“ 3rd “	481	.26	423	.24	.127	.135	.02
779	“ 4th “	483	.26	304	.20	.12701

In all cases the iron was hot enough to melt all of the added metal, although the last metal barely filled the molds. The effect of the stirring alone is shown by tests 776-9.

TABLE LXXX.

No. Test.	Chromium.	Dead Load.		Shrinkage.		Chill.
		Str.	Def.	$\frac{1}{4}'' \square$	$\frac{1}{16}'' \times 1''$	
429	F.L.M. .0% Chromium.....	335	.23	.167	.200	.60
594	" 0.10 "	332	.20	.171	.195	.65
595	" 0.50 "	345	.24	.167	.194	.75
596	" 1.00 "	475	.24	.187	.222	.60
597	" 1.50 "	345	.17	.186	.220	.75
598	" 2.00 "	355	.21	.172	.199	.75
599	Gaylord White 1.00% Chromium.....	365	.12	.227	All
620	Cupola Iron .0% Chromium.....	374	.21	.13203
615	" 0.10 "	362	.21	.13601
616	" 0.50 "	366	.20	.14203
617	" 1.00 "	373	.15	.15407
618	" (1.50) "	363	.19	.15005
619	" (2.00) "	352	.18	.15608

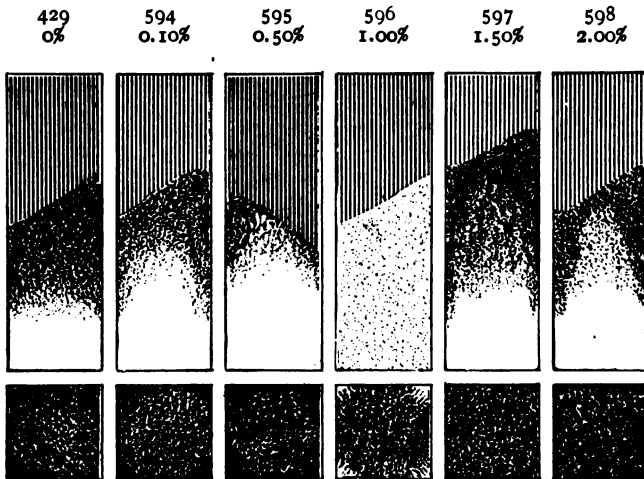

FIG. 117.—Chromium in Cast Iron.

Chromium in Cast Iron.—Mr. R. A. Hadfield in his paper before the Iron and Steel Institute, "Chromium in Steel," proposed that the author should determine the influence of chromium

in cast iron, and ne furnished the ferrochromium to make the necessary tests.

The ferrochromium was added after the iron was melted (Method 4), and the pot was returned until all was melted, which gave time for the chromium to become thoroughly incorporated and to exert its influence on the metal.

Chromium does not seem to be of any benefit in cast iron, and it exerts little or no influence except to slightly increase shrinkage when present in quantities less than 1%.

INDEX.

- Action of fluid iron in a foundry ladle, 21; of iron floating in, 20, 63.
- Aluminum, and solid castings, 67, 207; changes combined carbon into graphite, 205; in cast iron, 205; in wrought iron and in steel castings, 210; with 50% iron, crumbles to powder, 211.
- American Foundrymen's Association, analysis of test-bars, 119; description of tests, 115, 117; shrinkages, 48; strength tests, 117, 118, 123, 124, 125, 126, 128, 129.
- American Society of Mechanical Engineers, Testing Committee, 115; strength tests, 116, 123, 129, 130.
- Analysis, A. F. A. test-bars, 119; aluminum mixtures, etc., by Dr. C. F. Mabery, 205; annealed test-bars, 33, 139; Ashland pig, 176; A. S. M. E. test-bars, Si. 42, P. 76, S. 97, Mn. 105, T.C. 132, Cd.C. 133, G.C. 138, by Dickman and Mackenzie; cube, 122; cupola iron, 177; Durham pig, 72; eleven pigs (Pencost by Dr. Lord), 45; FLM pig and test-bars, 11, 35, 70, 176, 205; ferromanganese, 99; Gaylord pig iron and test-bars, 11, 35, 205; Hamden pig iron by Dr. Locke, 73; Hinkle pig iron by C. D. Chamberlain, 12; Iroquois pig iron by D. & M., 11, 12, 42, 43; machine and sand cast pig and test-bars by A. L. Colby, 136; Norway pig, 74; Pencost pig, 12, 45; segregation, 110; silicon iron test-bars, 35, 38, 40; six pigs, 167; Sloss pig, 176; Star pig, 78; Stewart pig, 74; strong and weak test-bars, 174; Swedish Mn. irons, 103; Tenn. C., I. & R.R. Co. pigs, by Dr. W. B. Phillips, 195; test-bars of cooling curves by E. E. Mains, 53, 55; three pigs, 176; twenty pigs (Dayton by H. S. Fleming), 178.
- Annealed castings, analysis, 33, 139; physical quality, 33, 139; temperature for, 63.
- Ashland Iron and Steel Co., 12.
- Axes of crystals of cast iron, 20, 22.
- Blast-furnace, reduction of ore in, 26.
- Blowholes, 30, 72; and aluminum, 207; and phosphorus, 72; and silicon, 72, 210; and sulphur, 91, 96; prevented by graphite, 30.
- Blue-billy added to gray iron, 84.
- Borings of cast iron, close grain, 131.

Breaking or ultimate strength, 7.

Brimstone added to gray iron, 83, 85.

Brittleness by combined carbon removed by silicon, 119; caused by Cd.C., 134, 135; of phosphorus irons, 66.

Britton, J. Blodget, analysis of Star iron, 78.

Bulk of carbon, 10; of other elements, 10, 28, 29.

Carbon, 25; and chill, and fusibility, 29; and fluidity, 29, 30; and hardness, 29, 167; and phosphorus, 78; and silicon, 28, 38, 45, 176; and strength, 132, 133, 134, 136, 138; and sulphur, 82 to 98; bulk of, 10, 28, 29; coloring power of, 25; combined, 27, 133; combines at red heat, 62; combined, the natural condition, 27, 28; combined, produces hardness, 166; diffusion of, 28, 133; diluted by adding steel, 30, 71; diluted and Si. kept uniform, 31; dissolved in fluid iron, 27; driven out by sulphur, 83, 93, 94; if decreased, gray iron turns white, 30, 31, 94, 95; in cast iron, 25; influence of remelting, 27, 30, 33; invisible in carbonic acid, 25; not increased in cupola, 27; of the three expansions, 55; origin of carbon, 26; quantity of, 27; reduces shrinkage, 46; relation to silicon, 45; replaced by silicon, 38, 45; saturation of, 26, 27; segregation of, 107; silicon acts through, 38, 47, 176; specific gravity, 25; total, and strength, 132; total, determines influence of silicon, 38, 39.

Carbonic acid, 25, 26.

Carbonic oxide, 26.

Cast iron, 3; crystals of, 19; does it expand in freezing, 20; fusibility of, 29; with low silicon tends to lamellar fracture, 78; various metals in, 212.

Casting machine, pig-iron, 136; conditions should be uniform, 138.

Castings, classes of, 159; cracking of, 24, 153; green sand stronger than dry, 28; with close-grained pig, 162; spongy, 21, 22, 162; with heavy and light parts, 24.

Chemical analysis, 1; drawbacks of, 171; drillings for, 165; will not account for all physical properties, 38, 39, 40, 173; what it does, 170.

Chemical composition, and hardness, 166; a shrinkage test for, 46; does not always determine strength, 163, 168, 177.

Chemists assume that chemical composition insures physical quality, 169, 171; must measure physical quality to prove prediction, 169; not agreed on methods of sampling, 171.

Chill, 7; and carbon, 29; and manganese, 100, 103, 104, 105, 106; and phosphorus, 80; and silicon, 44, 101, 102; and sulphur, 83, 86, 96; explained by segregation, 114; measure of, 183; of annealed castings, 33, 139; process instantaneous, 51.

Chromium, in cast iron, 213; in steel, R. A. Hadfield, 213.

Coal, 4.

Coke, 4.

Colby, A. L., machine and sand cast pig iron, 136.

Cold-shortness of phosphorus iron, 66.

Cold-shut in test-bars hastens fracture, 181.

Color of grain of phosphorus irons, 77.

- Coloring power of carbon, 25.
- Combined carbon, 27, 133; accompanied by low silicon, 133; causes brittleness, 134, 135; changed to graphite by aluminum, 205, by annealing, 139; by silicon, 36, 119; during 3d expansion, 56; influence of increase in size on strength, 133, 135; produces hardness, 166; the natural condition, 27, 28; weakens, never strengthens, 133, 135.
- Composition of irons may be alike and yet make unlike castings, 171.
- Compression test, 2, 127, 128.
- Conditions influence castings, 85, 168, 176; unavoidable, 173.
- Cooling curves, 50; begin when casting is solid, 51, 54; carbons of three expansions, 55; for hard and soft iron, 55; for rolled steel, 63; influence of size of casting, 58, 59, 61; of 1st, 2d, and 3d expansions, 54; of hot and dull iron, 59; of phosphorus, manganese, and sulphur, 58; of test-bars in yokes, 51; of various metals, 51; of yokes, 51; practical application, 58; relation of size to expansion, 58; temperature of expansions, 61; test of quality at each minute, 54.
- Cooling in ladle, 88.
- Cooling ratio, 157.
- Copper in cast iron, 212; cooling curve of, 52.
- Cracking of castings, 24, 153.
- Critical points of cast iron, 65.
- Crucible, furnace, 203; iron for tests, 14.
- Crushing test, 2, 127, 128.
- Crystallization, 19; carbon causes, 46; castings larger after, 46; no change after 3d expansion, 56; of a mill roll, 21; very rapid, 55, 109.
- Crystals, arrangement during 3d expansion, 56; axes of, 20, 22; do they expand, 20; formation of, 19, 20, 21; octahedral, 19; of cast iron, 9.
- Cubic foot of cast iron, weight of, 28.
- Cupola, iron for tests, 13; small, for testing samples, 203; temperature, 175.
- Dead load, 7; diagram, 186; diagrams of cast iron, 5, 146, 161; diagrams of steel bars, 140, 141; Keep's testing machine, 183, 184; records of deflection, 140, 141.
- Deflection, 5; dead-load records, 140, 141; elastic, 6; greater for impact, 149; impact records, 143, 150; relation of, to dimensions of bar, 142; set, 6.
- Dickman and Mackenzie, analyses, 11, 12, 42, 76, 97, 105, 132, 133, 138.
- Diffusion, of carbon, 28, 133; of silicon, 41.
- Direct test, 1.
- Drills, angles for, 164; for hardness test, 164.
- Drillings for analysis, 165.
- Dry-sand castings weaker than green-sand, 128.
- Dull iron, cooling curves of, 59, 61, 62.
- Durham pig iron, 72.
- Elasticity, 6; measure of, 6.
- Elements in cast iron, bulk of, 10, 28, 29.

- Expansion, and shrinkage, 54; carbons of, 55; combined carbon changes to graphite during 3d, 56; crystals take final form during 3d, 56; 1st, 2d, and 3d, 54; is the cause of less shrinkage, 64; silicon increases the 3d, 57; takes place at definite temperatures, 61, 62, 65; 3d indicates red-shortness, 65; 3d is when carbon combines before fusion, 62; time it takes place, 54.
- Factor of safety for cast iron, 124, 163.
- Feeding castings, 21, 22.
- Ferromanganese, 99; cracks when cooling, 99.
- Ferrosilicon, 192.
- Ferrostatic pressure in mold, 22.
- Flask for test-bars, 182.
- Fleming, H. S., analysis of Dayton pig iron, 178; phosphide of iron, 66.
- FLM pig iron, analysis of, 11, 35.
- Floating of solid on liquid iron, 20, 63.
- Fluid iron, its action in foundry ladle, 21; less dense than solid iron, 21; phosphorus irons remain so, 81; should be poured dull, 24.
- Fluidity, and carbon, 29, 30; and phosphorus, 81; and silicon, 44.
- Fluor-spar, melted with gray iron, 83.
- Formula for strength, 119, 163; strength of cast iron cannot be calculated by, 125.
- Foundry irons, silicon in, 41.
- Fracture, 5; from a notch or cold-shut, 181.
- Fractures, illustrations of, of aluminum mixtures, 206, 207; of castings, 23; of chromium in cast iron, 213; of dilutions of carbon, 31, 67, 71; of FLM remelted, 70; of irons used in tests, 35; of machine and sand cast pig, 132; of phosphorus and FLM, 71; of phosphorus and white iron, 70; of segregations of American pig, 109; of segregation of stove castings, 109; of segregation of Swedish irons, 108, 109; of segregations of test-bars, 111, 112; of silicon and FLM, 37; of silicon and white iron, 37; of silicon 1½% to 3%, 39; of silicon 2½%, 40; of silicon pig iron, 193, 194; of spiegel and silicon, 100; of sulphide of iron and FLM, 90; of sulphide and silicon and FLM, 91; of sulphur and cupola iron, 89; of sulphur (brimstone) and FLM, 86; of sulphur and white iron, 91; of Swedish manganese irons, 103; of Tenn. C., I. & R.R. Co. pig irons, 169, 197, 199, 200; of white iron remelted, 67.
- Fuel, 4; sulphur in, 5, 82.
- Fusibility, and carbon, 29; and phosphorus, 66; Truran's rule for, 29.
- Galena melted with gray iron, 83.
- Gaylord pig-iron analysis, 11, 35.
- Grain, 7; and aluminum, 207; and phosphorus, 77, 78; darkened and made coarser by annealing, 139; of phosphide of iron, 77. (*See Fractures.*)
- Graphic method for approximating silicon and shrinkage, 155, 156; strength, 160; to find the silicon in any iron mixture, 157; to find the shrinkage of any size of casting, 157.

- Graphic records, 8; advantages, 8.
- Graphite, 25; and strength, 133; changes to combined carbon before melting, 62; does it separate the grains, 138; flakes of, 19, 138, 139; in cast iron, 27; in spaces between the grains, 139; segregation of, 107; silicon changes combined carbon to, 36, 119; strength and weakness independent of, 139.
- Gray forge pig iron, 167, 195, 201.
- Gray iron, melting of, 30; more fluid than white, 30.
- Green-sand castings stronger than dry-sand, 128.
- Grinder for $\frac{3}{8}$ drills, 164, 187.
- Hadfield, R. A., chromium in steel, 213; spiegel and silicon, 100.
- Hamden pig iron, 73; chill, 80; grain, 77, 78; hardness, 80.
- Hardness, and carbon, 29, 167; and chemical composition, 166; and manganese, 104, 105, 106; and phosphorus, 58, 80; and silicon, 44; and sulphur, 93, 98; diagrams, 165; follows combined carbon, 44, 167; Keep's testing machine, 164, 186; or workability, 166; record of, 165; records of A. S. M. E. and A. F. A. tests, 166; test does not distinguish between hardness and tenacity, 164; Turner's definition of, 164; Turner's test for, 29, 190; Turner's testing machine, 190.
- Hard spots in castings, 107 to 114, 165, 167.
- Heavy and light portions of the same casting, 24.
- Hinkle pig iron, analysis, 12.
- Horizontal stronger than vertically cast test-bars, 123.
- Hot and dull iron, cooling curves of, 59, 61, 62.
- Impact, 140; advantages of swinging hammer, 152; arbitrary values for, 32; diagrams from test-bars not perfectly elastic, 145; diagrams of cast iron, 146; influence of shock on cast iron, 152; Keep's testing machine, 142, 189; recording apparatus, 140, 189; records of steel test-bars with direct drop, 144, 149, 150, 151; records of test-bars with swinging hammer, 142, 143, 144, 146, 147, 148; tests, 1, 152; striking bars shortens them, 153; to determine resilience, 152.
- Impurities, a benefit, 113; prevent segregation, 113.
- Iroquois pig iron analysis, 12.
- Iron, cast, 3; ingot, 3; to find if low-priced is economical, 169.
- "Keep's Test" name suggested, 49.
- Kish, graphite floating on liquid iron, 27.
- Ladle, action of fluid iron in, 21; hot, cold, and green, 84, 175; iron standing or stirred in, 59, 88, 173, 212.
- Lamellar fracture caused by low silicon, 78, 100.
- Large castings proportionally weaker than small, 22, 120.
- Lead, cooling curve of, 52; in cast iron, 212.
- Lime, 4.
- Lines of weakness in cast iron, 22, 23, 24.

- Machine cast pig, conditions should be uniform, 138; tests and analyses, 136, 137; advantages of, 201.
- Machines, *see* Testing machines.
- Manganese, analysis, A. S. M. E. tests, 105; and carbon, 101, 102, 103, 104; and chill, 100, 103, 104, 105, 106; and hardness, 58, 104, 105, 106; and remelting, 99, 102, 104, 106; and shrinkage, 100 to 104; and silicon, 100, 102, 103, 104; and strength, 104; does not make gray iron white, 102, 103; gray spiegel, Ward's, 102; Pourcel's, 103; influence on cooling curves, 58; nothing to do with grayness or chill, 103; removes chill, 105; removes sulphur, 99, 104; Swedish irons, 103; whiteness of spiegel not from Mn., 102, 103.
- Measure, of elasticity, 6; of rigidity, 6; of usefulness, 7.
- Mechanical analysis, 168; advantages of, 169; can be used alone by any one, 169; it is chemistry for the uneducated founder, 170; Keep's apparatus for, 182 to 190; measures physical properties, 168; simple method benefits ordinary founder most, 170; shows combined influence of chemical elements and of all conditions, 168; tells whether more or less silicon is needed, 168.
- Mechanics, 5.
- Metis Co.'s use of aluminum, 211.
- Methods of investigation, 12; methods, 1 to 9, pp. 13 to 16; 10 to 14, pp. 17 and 18.
- Mill cinder in silvery iron, 201.
- Moldenke, Dr. Richard, A. F. A. tests, 115.
- Molds, wet and dry, 175.
- Mottled pig iron, 93, 94.
- Moxahala pig iron, 73, 78; grain, and color of fracture, 78; chill and hardness, 80.
- Nickel in cast iron, 212.
- Norway pig iron, 74, 113.
- Outerbridge, A. E., tumbled test-bars, 153.
- Paper for records, 191.
- Patterns for test-bars, 182, 184, 191.
- Pencost pig iron, 12, 35, 45.
- Phosphide of iron, 66; grain of, 77; shrinkage of, 79; hardness, 80.
- Phosphorus, 66; analysis of A. S. M. E. test-bars, 76; and blowholes, 72; and brittleness, 66; and carbon, 78; and chill, 78, 80; and cold-shortness, 66; and cooling curves, 58; and fluidity, 81; and fusibility, 66; and grain, 77, 78; and hardness, 58, 80; and remelting, 77; and shrinkage, 79; and strength, 80; color of casting sometimes straw-colored, 78; in favorite foundry irons, 81; irons low in silicon have lamellar fracture, 78; specific gravity, 66; Turner on, 66, 81; irons, weakness of, 77; white and red, 66.
- Physical tests, 1.

- Pig irons**, 192; used in tests, 11, 12; ferrosilicon and silvery iron, 192; foundry Nos. 1, 2, 3, 4, 198; gray, 28; gray forge, 201; mottled, 201; not homogeneous, 171; physical tests of, 195; soft, Nos. 1 and 2, 196; Southern, analysis of, 178, 195, 196; testing small samples of, 203; to find if low-priced is desirable, 169; white, 28, 201.
- Pyrites** added to gray iron, 84, 96, 98.
- Quenching** cast iron in ice-water, 55.
- Ratio of cooling**, 157.
- Red-short**, 82; at time of 3d expansion, 65.
- Relative tests**, 1.
- Remelting**, influence on carbon, 27, 30, 33; on manganese, 99, 102, 104, 106; on phosphorus, 77; on silicon, 42, 202; loss in, 12; on sulphur, 85, 93, 96; reduces carbon, 30.
- Resilience**, test for, 152.
- Rigidity**, 6; diagram of, 6; measure of, 6; no, 6; perfect, 6.
- Round and square test-bars**, of Mr. West, 130; of Western Founders' Association, 129; strength of, 128.
- Samples of pig iron**, to test, 203.
- Sampling**, chemists not agreed on method of, 171.
- Saturation of carbon**, 26, 27, 38.
- Scale**, of casting peels, 45; taper for measuring shrinkage, 183.
- Scotch pig iron**, 81, 201.
- Scrap**, appearance a practical guide, 172; no correct analysis can be made of, 173.
- Scrap-carrier**, the pig that has the lowest shrinkage, 161.
- Segregation**, 107; analysis of, 110; explains chill, 114; in a stove cover, 110; of American pig, 107; of graphite, 107; of sulphur, 107; of Swedish iron, 107; prevented by impurities, 113; remarkable examples, 108; to produce a white core, 113; white beads, 110.
- Set**, 6; increased by annealing, 139.
- Shock**, influence on cast iron, 152.
- Shrinkage**, 46; A. F. A. tests, 48; a safer guide than silicon analysis, 176; A. S. M. E. tests, 48; a test for chemical composition, 46, 168; and carbon, 38, 47, 176; and expansion go on at the same time, 65; and manganese, 100 to 104; and phosphorus, 79; and silicon, 47, 57; and sulphur, 83, 86 to 95; autographic curves of, 50; carbon reduces, 46 caused by other elements, 47; chart showing percentage of silicon, 156; decrease in cooling the same as increase in volume by melting, 46, 51; decreases as silicon increases, 48; decreases as size increases, 49; graphic method, 155; if lower, the pig iron is a better scrap-carrier, 169; is lessened by expansion, 64; least with greatest graphite, silicon, and phosphorus, 79; less in casting than in pig, 96; measure of, is equivalent to chemical analysis of silicon, 168; measure of, gives relative influence of silicon, 158, 159; measure of, tells whether more or less silicon is needed,

- 159, 168; measuring, 183; of annealed castings, 138; of different grades of iron, 47; of fluid iron, 51; of heavy and light parts of the same casting, 24; of large and small castings, 22; of pure iron, 46; one size of test-bar to study variations in chemical composition, 46; $\frac{1}{8}$ ", for any size of casting, 47, 158, 159; relation to percentage of silicon, 44, 155, 168; silicon lessens, 47, 56; soft castings with low, 139; standard, 159, 168; taper scale for measuring, 183; there is no definite, for a definite percentage of silicon, 176; to find, for different sizes of castings, 157; to study relation of, to variation in size of test-bar, use iron of uniform composition, 46; varies with size of casting, 46, 155. (*See* Cooling curves.)
- Shrink-holes, 25, 165.
- Shrink-rule, 46.
- Silicon, 34; acts through carbon, 38, 47, 176; a definite percentage will not always produce a definite shrinkage, 37, 176; a greater quantity acting a shorter time or vice versa, 40; a softener, 44, 56, 79; alloys with iron, 34; amount needed told by shrinkage, 49, 168; analyses, A. S. M. E. tests, 42; analysis not as safe a guide as shrinkage, 176; an approximation of, all that can be obtained by analysis, 44; and carbon, 28, 38, 45, 176; and chill, 44; and fluidity, 44; and hardness, 44; and manganese, 100 to 104; and spiegel, 100; and strength, 119, 121; an increase counteracts most evil influences, 168; approximated by shrinkage chart, 156; as it increases shrinkage decreases, 48, 100; carriers of, 79; changes white iron to gray, 36, 37; controls mixture, 41; decreased, increases chill, 101, 102; decreasing, increases shrinkage, 47; decreasing, turns gray iron white, 94, 95; diffusion of, 41, 43; exact percentage, even by analysis, impossible, 43; expels carbon, 39; graphic method for determination of, 155; history of its use, 201; in foundry irons, 41; in some irons more effective than in others, 176; increases 3d expansion, 57; influence depends on total carbon, 38; influence indirect through carbon, 38; influence of remelting, 42, 202; influence modified by various conditions, 39; its influence, not its percentage, 37, 38; low for large castings, 131; lowers saturation of carbon, 38; makes gray iron more gray, 36; the more total or less combined carbon the less silicon required, 39; overcomes sulphur, 93; percentage increased or decreased according to shrinkage, 159; pig iron, 192, 201; reduces combined carbon, thereby removes brittleness and increases strength, 119; specific gravity, 34; reduces shrinkage, 47, 57; relation to carbon, 45; the percentage in pig iron must be known, 172; the percentage is but an approximation, 44; to find percentage from a test-bar, 157; to produce $\frac{1}{8}$ " shrinkage per foot, 47, 159; Turner on, 34, 36; varies shrinkage, 168; weakness of silicon irons, 201.
- Size, influence on cooling curve, 58, 59, 61; of a casting varies shrinkage, 46, 49; of test-bars due to poor molding, 180; one size of test-bars should be used for comparison, 180; of test-bars only approximate, 180; variation of, in test-bars, 123.
- Slag, 4.
- Slow cooling increases size of grain, 121.
- Small castings proportionately stronger than large, 22, 120.

- Smith and Weston's tests with sulphur, 85, 93.
 Smoothing surface of a test-bar strengthens it, 154.
 Soft, Nos. 1 and 2 pig iron, 96; castings, to produce, 139.
 Softeners, 79; Ohio, 202; Scotch, 201; silicon, 44, 56, 192; weak, 201.
 Solidifying, of cast iron, 19 to 22, 54; test to find quality at each minute, 54.
 Southern pig irons, analysis of, 167, 176, 178, 195.
 Specific gravity, of elements of cast iron, 10; of fluid and solid cast iron, 21;
 of graphite, 25; of phosphorus red and white, 66; of pig irons, 28, 29;
 of pure iron, 2, 3; of silicon, 34; of sulphur, 82.
 Spiegeleisen, and silicon, 100; carbon of, 102; whiteness of, caused by low
 silicon, 102; hardness, 106; Pourcel's gray, 103; Ward's gray, 102.
 Spongy spots in castings, 21, 22, 165; to prevent, 131.
 Spring-line, 6.
 Square test-bars stronger than round bars, 128, 129, 130.
 Standard shrinkage, 2, 159, 168.
 Star pig-iron analysis, 78.
 Steel, 3; additions of, dilute all elements, 30, 71; and aluminum, 210; man-
 ganese, 104, scrap increases strength, 30, 31, 131, 132.
 Stewart pig iron, 75.
 Stiffness, 6.
 Stirling's toughened cast iron, 31.
 Strain, 5.
 Strength, 7; and carbon, 132, 133, 134, 136, 138; and manganese, 104; and
 phosphorus, 80; and silicon, 119, 121; and sulphur 86, 96; breaking, 7;
 by pounding surface of test-bar, 154; by smoothing the surface of test-
 bar, 154; by steel or wrought-iron scrap, 30, 31, 131, 132; cannot be cal-
 culated by formula, 125, 128, 163; chemical composition and, 163, 168,
 171; close approximation of, 163; comparisons of, must be made of bars
 that were cast the same size, 117; curves, 127; decrease of, due to
 coarse grain, 134; decreases as size increases, 22, 120; diagrams of A. S.
 M. E. tests, 120, 121; formula for, 119; graphic method for, 155, 159;
 increased by tumbling test-bars, 153; increases with each increase of
 silicon in small castings, 119; influence of shock on, 153; maximum
 breaking, 7; more dependent on size of grain than on chemical com-
 position, 171; of A. S. M. E. tests, 115, 116, 119, 130; of annealed cast-
 ings, 33, 139; of castings made in green and in dry sand, 128; of center of
 a casting less than the outside, 122, 128; of horizontally and vertically
 cast test-bars, 123; of machined and unmachined test-bars, 117, 118,
 124; of square and round test-bars, 128, 129, 130; of test-bars 2" X 1"
 tested flat or on edge, 130; proportionate, decreases as size of casting
 increases, 22, 120; proportional decrease in, due to size, is more rapid
 and greater with each increase of silicon, 121; proportionate, decreases
 more rapidly with increase in size of small than of large test-bars, 121;
 removing surface of test-bar decreases, 122, 154; sulphide of iron
 reduces it, 92; tests from various parts of a cube, 122; to find the actual
 for any size of test-bar, 162; to find, for a 1/2" square section of a large cast-
 ing, 162; the lower the silicon the greater, for large test-bars, and vice

- versa, 119; ultimate, 7; variations in, due to character of cast iron, 125; variations of, in test-bars, 123; variations in ordinary castings, 124; with combined carbon and low silicon, 132.
- Stress, 5.
- Striking test-bars shortens them, 153.
- Strong castings, by using an iron low in silicon, 131; by using cast iron borings, 131; by using close-grained pig iron, 131; by using wrought iron or steel scrap, 30, 31, 131, 132; to produce, 131.
- Sulphide of iron, analysis of, 87, 89; compound of, with carbonized iron, 87; its own iron reduces silicon and carbon in test-bars, 94; reduces strength, 92; shrinkage, 87.
- Sulphur, 82; and carbon, 82, 83; and chill, 83, 86, 96; and cooling curves, 58; and F.L.M., 85; and hardness, 58, 93, 98; and shrinkage, 83, 86 to 97; and strength, 86 to 97; added to gray iron by brimstone, 83, 85; by blue-billy, 84; fluor-spar, 83; galena, 83; pyrites, 84, 98; sulphide, 87 to 92; castings contain more than the pig, 96; drives out carbon, 83, 93, 94; in A. S. M. E. tests, 96, 97; in cast iron injurious, 82, 95, 97; influence of, in commercial pig iron, 95, 96; not beneficial, 97; loss in remelting, 85, 93, 96; overcome by silicon, 93; percentage in pig iron, 82, 95; segregation of, 107; turns gray iron white, 92, 95; Turner's experiments with, 93, 95; Weston and Smith's experiments, 85, 93, 94.
- Surface, and silicon, 45; removing, weakens, 122, 154; smoothing, strengthens, 154.
- Swedish irons, and pyrites, 96; segregation of, 107, 108; manganese, 103.
- Taper scale for measuring shrinkage, 183.
- Tennessee Coal, Iron and R.R. Co., various grades of iron, 178, 195 to 201.
- Tensile test, 2, 122, 127, 129, 136.
- Test-bars, 12, 179; a cold-shut will hasten fracture, 181; advantages and disadvantages of 1" \square , 180; analysis of (*see* Analysis); as a coupon not satisfactory, 181; best size, to use, 179; flask for, 182; in yokes, cooling curves, 51; machined or unmachined, 117; patterns for, 182, 184, 191; same size, should be used by all, 179; size of, 12, 179; size, best that shows greatest variation for the least variation in chemical composition, 169; smallest that will run gray is best, 180; strength of square and round, 128; that give most uniform results not best, 180; 2" \times 1" tested flat or on edge, 130; used in impact tests, 140; variation in size and strength of, 123; Waterworks Association, 131; with yokés, 190; why 1" \square , gives uniform results, 180.
- Test, chemical, 1; compression or crushing, 2; definition of, 1; direct, 1; impact, 2; physical, 1; preparing for, 12; relative, 1; tensile, transverse, 2.
- Tests, consider general tendencies not individual variations, 76; of aluminum in cast iron, 210; of silicon, Prof. Turner's, 36.
- Testing machines, advantages, 184; cooling curve, 50, 190; dead-load, 183, 184; drill-grinder, 188; hardness, 186; impact, 189; patterns, 182, 184, 190; recorder, 189; Turner's hardness, 190.
- Testing small samples of pig iron, 203.

- Tin, in cast iron, 212; cooling curve of, 52.
- Transverse test, 2.
- Truran's rule for fusibility, 29.
- Tumbling strengthens test-bars, 153; discovery of A. E. Outerbridge, 153.
- Turner, Professor Thomas, definition of hardness, 164; experiments with sulphur, 93, 95; hardness machine, 190; hardness test, 29, 190; on phosphorus, 66; on silicon, 34, 35, 36; on strength, 180.
- Usefulness, measure of, 7.
- Variation, of carbon, 28; in size of test-bars, 123; in strength due to character of cast iron, 125; in strength of machined and unmachined test-bars, 124; in strength of ordinary castings, 124; in test-bars due to poor moulding, 180.
- Vertically cast test-bars, strength of, 123.
- Waterworks Association, size of test-bars, 131.
- Weakness, lines of, 22; of phosphorus irons, 77; of silicon irons, 20.
- Western Founders' Association report, 129.
- Weston and Smith's experiments with sulphur, 85 to 93.
- Wet and dry molds, 175.
- White pig iron, 28, 201; melts more easily than gray, but is not as fluid, 30; silicon changes to gray, 36; thick and pasty as it cools, 30.
- White spots in castings, 113, 107 to 114.
- Workability or hardness, 164.
- Wrought iron, 3; and aluminum, 210; added to cast iron, 77, 132; shrinkage, 79.
- Yokes, cooling curves from, 51; of test-bars in, 51; for test-bars, 190.
- Zinc in cast iron, 212; cooling curves of, 51.

Kidder's Architect's and Builder's Pocket-book. Rewritten Edition.	16mo, morocco,	5 00
Merrill's Stones for Building and Decoration.....	8vo,	5 00
Monckton's Stair-building	4to,	4 00
Patton's Practical Treatise on Foundations.....	8vo,	5 00
Peabody's Naval Architecture.....	8vo,	7 50
Siebert and Biggin's Modern Stone-cutting and Masonry.....	8vo,	1 50
Snow's Principal Species of Wood.....	8vo,	3 50
Sondericker's Graphic Statics with Applications to Trusses, Beams, and Arches.	8vo,	2 00
Wait's Engineering and Architectural Jurisprudence.....	8vo,	6 00
	Sheep,	6 50
Law of Operations Preliminary to Construction in Engineering and Architecture.....	8vo,	5 00
	Sheep,	5 50
Law of Contracts.....	8vo,	3 00
Wood's Rustless Coatings: Corrosion and Electrolysis of Iron and Steel...	8vo,	4 00
Woodbury's Fire Protection of Mills.....	8vo,	2 50
Worcester and Atkinson's Small Hospitals, Establishment and Maintenance, Suggestions for Hospital Architecture, with Plans for a Small Hospital.	12mo,	1 25
The World's Columbian Exposition of 1893.....	Large 4to,	1 00

ARMY AND NAVY.

Bernadou's Smokeless Powder, Nitro-cellulose, and the Theory of the Cellulose Molecule.....	12mo,	2 50
* Bruff's Text-book Ordnance and Gunnery.....	8vo,	6 00
Chase's Screw Propellers and Marine Propulsion.....	8vo,	3 00
Craig's Azimuth.....	4to,	3 50
Crehore and Squire's Polarizing Photo-chronograph.....	8vo,	3 00
Cronkrite's Gunnery for Non-commissioned Officers.....	24mo, morocco,	2 00
* Davis's Elements of Law.....	8vo,	2 50
* Treatise on the Military Law of United States.....	8vo,	7 00
	Sheep,	7 50
De Brack's Cavalry Outpost Duties. (Carr.).....	24mo morocco,	2 00
Dietz's Soldier's First Aid Handbook.....	16mo, morocco,	1 25
* Dredge's Modern French Artillery.....	4to, half morocco,	15 00
Durand's Resistance and Propulsion of Ships.....	8vo,	5 00
* Dyer's Handbook of Light Artillery.....	12mo,	3 00
Eissler's Modern High Explosives.....	8vo,	4 00
* Fieberger's Text-book on Field Fortification.....	Small 8vo,	2 00
Hamilton's The Gunner's Catechism.....	18mo,	1 00
* Hoff's Elementary Naval Tactics.....	8vo,	1 50
Ingalls's Handbook of Problems in Direct Fire.....	8vo,	4 00
* Ballistic Tables.....	8vo,	1 50
* Lyons's Treatise on Electromagnetic Phenomena. Vols. I. and II. 8vo. each.	8vo. each,	6 00
* Mahan's Permanent Fortifications. (Mercur.).....	8vo, half morocco,	7 50
Manual for Courts-martial.....	16mo, morocco,	1 50
* Mercur's Attack of Fortified Places.....	12mo,	2 00
* Elements of the Art of War.....	8vo,	4 00
Metcalf's Cost of Manufactures—And the Administration of Workshops, Public and Private.....	8vo,	5 00
* Ordnance and Gunnery. 2 vols.....	12mo,	5 00
Murray's Infantry Drill Regulations.....	18mo, paper,	10
Peabody's Naval Architecture.....	8vo,	7 50
* Phelps's Practical Marine Surveying.....	8vo,	2 50
Powell's Army Officer's Examiner.....	12mo,	4 00
Sharpe's Art of Subsisting Armies in War.....	18mo, morocco,	1 50

* Walke's Lectures on Explosives.....	8vo	4 00
* Wheeler's Siege Operations and Military Mining.....	8vo,	2 00
Winthrop's Abridgment of Military Law.....	12mo,	2 50
Woodhull's Notes on Military Hygiene.....	16mo,	1 50
Young's Simple Elements of Navigation.....	16mo morocco,	1 00
Second Edition, Enlarged and Revised.....	16mo, morocco,	2 00

ASSAYING.

Fletcher's Practical Instructions in Quantitative Assaying with the Blowpipe.....	12mo, morocco,	1 50
Furman's Manual of Practical Assaying.....	8vo,	3 00
Miller's Manual of Assaying.....	12mo,	1 00
O'Driscoll's Notes on the Treatment of Gold Ores.....	8vo,	2 00
Ricketts and Miller's Notes on Assaying.....	8vo,	3 00
Ulke's Modern Electrolytic Copper Refining.....	8vo,	3 00
Wilson's Cyanide Processes.....	12mo,	1 50
Chlorination Process.....	12mo,	1 50

ASTRONOMY.

Comstock's Field Astronomy for Engineers.....	8vo,	2 50
Craig's Azimuth.....	4to,	3 50
Doolittle's Treatise on Practical Astronomy.....	8vo,	4 00
Gore's Elements of Geodesy.....	8vo,	2 50
Hayford's Text-book of Geodetic Astronomy.....	8vo,	3 00
Merriman's Elements of Precise Surveying and Geodesy.....	8vo,	2 50
* Michie and Harlow's Practical Astronomy.....	8vo,	3 00
* White's Elements of Theoretical and Descriptive Astronomy.....	12mo,	2 00

BOTANY.

Davenport's Statistical Methods, with Special Reference to Biological Variation.....	16mo, morocco,	1 25
Thomé and Bennett's Structural and Physiological Botany.....	16mo,	2 25
Westermaier's Compendium of General Botany. (Schneider.).....	8vo,	2 00

CHEMISTRY.

Adriance's Laboratory Calculations and Specific Gravity Tables.....	12mo,	1 25
Allen's Tables for Iron Analysis.....	8vo,	3 00
Arnold's Compendium of Chemistry. (Mandel.).....	Small 8vo,	3 50
Austen's Notes for Chemical Students.....	12mo,	1 50
* Austen and Langworthy. The Occurrence of Aluminium in Vegetable Products, Animal Products, and Natural Waters.....	8vo,	2 00
Bernadou's Smokeless Powder.—Nitro-cellulose, and Theory of the Cellulose Molecule.....	12mo,	2 50
Bolton's Quantitative Analysis.....	8vo,	1 50
* Browning's Introduction to the Rarer Elements.....	8vo,	1 50
Brush and Penfield's Manual of Determinative Mineralogy.....	8vo,	4 00
Classen's Quantitative Chemical Analysis by Electrolysis. (Boltwood.)....	8vo,	3 00
Cohn's Indicators and Test-papers.....	12mo,	2 00
Tests and Reagents.....	8vo,	3 00
Copeland's Manual of Bacteriology. (<i>In preparation.</i>)		
Craft's Short Course in Qualitative Chemical Analysis. (Schaeffer.)....	12mo,	1 50
Dolezalek's Theory of the Lead Accumulator (Storage Battery). (Von Ende).....	12mo,	2 50
Drechsel's Chemical Reactions. (Merrill.).....	12mo,	1 25
Duhem's Thermodynamics and Chemistry. (Burgess.).....	8vo,	4 00
Eissler's Modern High Explosives.....	8vo,	4 00
Effront's Enzymes and their Applications. (Prescott.).....	8vo,	3 00
Erdmann's Introduction to Chemical Preparations. (Dunlap.).....	12mo,	1 25

Fletcher's Practical Instructions in Quantitative Assaying with the Blowpipe	12mo, morocco,	1 50
Fowler's Sewage Works Analyses	12mo,	2 00
Presenius's Manual of Qualitative Chemical Analysis. (Wells.)	8vo,	5 00
Manual of Qualitative Chemical Analysis. Part I. Descriptive. (Wells.)	8vo,	3 00
System of Instruction in Quantitative Chemical Analysis. (Cohn.)	2 vols.....	8vo, 12 50
Fuertes's Water and Public Health	12mo,	1 50
Furman's Manual of Practical Assaying	8vo,	3 00
* Getman's Exercises in Physical Chemistry	12mo,	2 00
Gill's Gas and Fuel Analysis for Engineers	12mo,	1 25
Grotenfelt's Principles of Modern Dairy Practice. (Woll.)	12mo,	2 00
Hammarsten's Text-book of Physiological Chemistry. (Mandel.)	8vo,	4 00
Helm's Principles of Mathematical Chemistry. (Morgan.)	12mo,	1 50
Hering's Ready Reference Tables (Conversion Factors)	16mo, morocco,	2 50
Hinds's Inorganic Chemistry	8vo,	3 00
* Laboratory Manual for Students	12mo,	75
Holleman's Text-book of Inorganic Chemistry. (Cooper.)	8vo,	2 50
Text-book of Organic Chemistry. (Walker and Mott.)	8vo,	2 50
* Laboratory Manual of Organic Chemistry. (Walker.)	12mo,	1 00
Hopkins's Oil-chemists' Handbook	8vo,	3 00
Jackson's Directions for Laboratory Work in Physiological Chemistry	8vo,	1 25
Keep's Cast Iron	8vo,	2 50
Ladd's Manual of Quantitative Chemical Analysis	12mo,	1 00
Landauer's Spectrum Analysis. (Tingle.)	8vo,	3 00
Lassar-Cohn's Practical Urinary Analysis. (Lorenz.)	12mo,	1 00
Leach's The Inspection and Analysis of Food with Special Reference to State Control. (In preparation.)		
Löb's Electrolysis and Electrosynthesis of Organic Compounds. (Lorenz.)	12mo,	1 00
Mandel's Handbook for Bio-chemical Laboratory	12mo,	1 50
* Martin's Laboratory Guide to Qualitative Analysis with the Blowpipe	12mo,	60
Mason's Water-supply. (Considered Principally from a Sanitary Standpoint.)	3d Edition, Rewritten.....	8vo, 4 00
Examination of Water. (Chemical and Bacteriological.)	12mo,	1 25
Meyer's Determination of Radicles in Carbon Compounds. (Tingle.)	12mo,	1 00
Miller's Manual of Assaying	12mo,	1 00
Mixter's Elementary Text-book of Chemistry	12mo,	1 50
Morgan's Outline of Theory of Solution and its Results	12mo,	1 00
Elements of Physical Chemistry	12mo,	2 00
Morse's Calculations used in Cane-sugar Factories	16mo, morocco,	1 50
Mulliken's General Method for the Identification of Pure Organic Compounds.	Vol. I.....	Large 8vo, 5 00
Nichols's Water-supply. (Considered mainly from a Chemical and Sanitary Standpoint, 1883.)	8vo,	2 50
O'Brine's Laboratory Guide in Chemical Analysis	8vo,	2 00
O'Driscoll's Notes on the Treatment of Gold Ores	8vo,	2 00
Ort and Kolbeck's Text-book of Chemical Technology. (Lorenz—Bozart.)	(In preparation.)	
Ostwald's School of Chemistry. Part One. (Ramsey.) (In press.)		
* Penfield's Notes on Determinative Mineralogy and Record of Mineral Tests.	8vo, paper,	50
Pictet's The Alkaloids and their Chemical Constitution. (Biddle.)	8vo,	5 00
Pinner's Introduction to Organic Chemistry. (Austen.)	12mo,	1 50
Poole's Calorific Power of Fuels	8vo,	3 00
Prescott and Winslow's Elements of Water Bacteriology, with Special Reference to Sanitary Water Analysis	12mo,	1 25
* Reisig's Guide to Piece-dyeing	8vo,	25 00

Richards and Woodman's Air, Water, and Food from a Sanitary Standpoint.	8vo,	2 00
Richards's Cost of Living as Modified by Sanitary Science.	12mo,	1 00
Cost of Food a Study in Dieteries.	12mo,	1 00
* Richards and Williams's The Dietary Computer.	8vo,	1 50
Ricketts and Russell's Skeleton Notes upon Inorganic Chemistry. (Part I.— Non-metallic Elements.)	8vo, morocco,	75
Ricketts and Miller's Notes on Assaying.	8vo,	3 00
Rideal's Sewage and the Bacterial Purification of Sewage.	8vo,	3 50
Disinfection and the Preservation of Food.	8vo,	4 00
Ruddiman's Incompatibilities in Prescriptions.	8vo,	2 00
Sabin's Industrial and Artistic Technology of Paints and Varnish. (<i>In press.</i>)		
Salkowski's Physiological and Pathological Chemistry. (Orndorff.)	8vo,	2 50
Schimpf's Text-book of Volumetric Analysis.	12mo,	2 50
Essentials of Volumetric Analysis.	12mo,	1 25
Spencer's Handbook for Chemists of Beet-sugar Houses.	16mo, morocco,	3 00
Handbook for Sugar Manufacturers and their Chemists.	16mo, morocco,	2 00
Stockbridge's Rocks and Soils.	8vo,	2 50
* Tillman's Elementary Lessons in Heat.	8vo,	1 50
* Descriptive General Chemistry.	8vo,	3 00
Treadwell's Qualitative Analysis. (Hall.)	8vo,	3 00
Quantitative Analysis. (Hall.)	8vo,	4 00
Turneure and Russell's Public Water-supplies.	8vo,	5 00
Van Deventer's Physical Chemistry for Beginners. (Boltwood.)	12mo,	1 50
* Walke's Lectures on Explosives.	8vo,	4 00
Wassermann's Immune Sera: Hæmolysins, Cytotoxins, and Precipitins. (Bol- duan.)	12mo,	1 00
Wells's Laboratory Guide in Qualitative Chemical Analysis.	8vo,	1 50
Short Course in Inorganic Qualitative Chemical Analysis for Engineering Students	12mo,	1 50
Whipple's Microscopy of Drinking-water.	8vo,	3 50
Wiechmann's Sugar Analysis.	Small 8vo,	2 50
Wilson's Cyanide Processes.	12mo,	1 50
Chlorination Process.	12mo,	1 50
Wulling's Elementary Course in Inorganic Pharmaceutical and Medical Chem- istry.	12mo,	2 00

CIVIL ENGINEERING.

BRIDGES AND ROOFS. HYDRAULICS. MATERIALS OF ENGINEERING RAILWAY ENGINEERING.

Baker's Engineers' Surveying Instruments.	12mo,	3 00
Bixby's Graphical Computing Table.	Paper 19½ X 24½ inches.	25
** Burr's Ancient and Modern Engineering and the Isthmian Canal. (Postage, 27 cents additional.)	8vo, net,	3 50
Comstock's Field Astronomy for Engineers.	8vo,	2 50
Davis's Elevation and Stadia Tables.	8vo,	1 00
Elliott's Engineering for Land Drainage.	12mo,	1 50
Practical Farm Drainage.	12mo,	1 00
Folwell's Sewerage. (Designing and Maintenance.)	8vo,	3 00
Freitag's Architectural Engineering. 2d Edition, Rewritten.	8vo,	3 50
French and Ives's Stereotomy.	8vo,	2 50
Goodhue's Municipal Improvements.	12mo,	1 75
Goodrich's Economic Disposal of Towns' Refuse.	8vo,	3 50
Gore's Elements of Geodesy.	8vo,	2 50
Hayford's Text-book of Geodetic Astronomy.	8vo,	3 00
Hering's Ready Reference Tables (Conversion Factors).	16mo, morocco,	2 50
Howe's Retaining Walls for Earth.	12mo,	1 25
Johnson's Theory and Practice of Surveying.	Small 8vo,	4 00
Statics by Algebraic and Graphic Methods.	8vo,	2 00

Kiersted's Sewage Disposal.....	12mo,	1 25
Laplace's Philosophical Essay on Probabilities. (Truscott and Emory.)	12mo,	2 00
Mahan's Treatise on Civil Engineering. (1873.) (Wood.)	8vo,	5 00
* Descriptive Geometry.....	8vo,	1 50
Merriman's Elements of Precise Surveying and Geodesy.....	8vo,	2 50
Elements of Sanitary Engineering.....	8vo,	2 00
Merriman and Brooks's Handbook for Surveyors.....	16mo, morocco,	2 00
Nugent's Plane Surveying.....	8vo,	3 50
Ogden's Sewer Design.....	12mo,	2 00
Patton's Treatise on Civil Engineering.....	8vo half leather,	7 50
Reed's Topographical Drawing and Sketching.....	4to,	5 00
Rideal's Sewage and the Bacterial Purification of Sewage.....	8vo,	3 50
Siebert and Biggin's Modern Stone-cutting and Masonry.....	8vo,	1 50
Smith's Manual of Topographical Drawing. (McMillan.)	8vo,	2 50
Sondericker's Graphic Statics, with Applications to Trusses, Beams, and Arches.....	8vo,	2 00
* Trautwine's Civil Engineer's Pocket-book.....	16mo, morocco,	5 00
Walt's Engineering and Architectural Jurisprudence.....	8vo,	6 00
Sheep,		6 50
Law of Operations Preliminary to Construction in Engineering and Archi- tecture.....	8vo,	5 00
Sheep,		5 50
Law of Contracts.....	8vo,	3 00
Warren's Stereotomy—Problems in Stone-cutting.....	8vo,	2 50
Webb's Problems in the Use and Adjustment of Engineering Instruments.....		
16mo, morocco,		1 25
* Wheeler's Elementary Course of Civil Engineering.....	8vo,	4 00
Wilson's Topographic Surveying.....	8vo,	3 50

BRIDGES AND ROOFS.

Boller's Practical Treatise on the Construction of Iron Highway Bridges.....	8vo,	2 00
* Thames River Bridge.....	4to, paper,	5 00
Burr's Course on the Stresses in Bridges and Roof Trusses, Arched Ribs, and Suspension Bridges.....	8vo,	3 50
Du Bois's Mechanics of Engineering. Vol. II.....	Small 4to,	10 00
Foster's Treatise on Wooden Trestle Bridges.....	4to,	5 00
Fowler's Cofferdam Process for Piers.....	8vo,	2 50
Greene's Roof Trusses.....	8vo,	1 25
Bridge Trusses.....	8vo,	2 50
Arches in Wood, Iron, and Stone.....	8vo,	2 50
Howe's Treatise on Arches.....	8vo,	4 00
Design of Simple Roof-trusses in Wood and Steel.....	8vo,	2 00
Johnson, Bryan, and Turneure's Theory and Practice in the Designing of Modern Framed Structures.....	Small 4to,	10 00
Merriman and Jacoby's Text-book on Roofs and Bridges:		
Part I.—Stresses in Simple Trusses.....	8vo,	2 50
Part II.—Graphic Statics.....	8vo,	2 50
Part III.—Bridge Design. 4th Edition, Rewritten.....	8vo,	2 50
Part IV.—Higher Structures.....	8vo,	2 50
Morrison's Memphis Bridge.....	4to,	10 00
Waddell's De Pontibus, a Pocket-book for Bridge Engineers.....	16mo, morocco,	3 00
Specifications for Steel Bridges.....	12mo,	1 25
Wood's Treatise on the Theory of the Construction of Bridges and Roofs.....	8vo,	2 00
Wright's Designing of Draw-spans:		
Part I.—Plate-girder Draws.....	8vo,	2 50
Part II.—Riveted-truss and Pin-connected Long-span Draws.....	8vo,	2 50
Two parts in one volume.....	8vo,	3 50

HYDRAULICS.

Bazin's Experiments upon the Contraction of the Liquid Vein Issuing from an Orifice. (Trautwine.)	8vo, 2 00
Bovey's Treatise on Hydraulics.	8vo, 5 00
Church's Mechanics of Engineering.	8vo, 6 00
Diagrams of Mean Velocity of Water in Open Channels.	paper, 1 50
Coffin's Graphical Solution of Hydraulic Problems.	16mo, morocco, 2 50
Fletcher's Dynamometers, and the Measurement of Power.	12mo, 3 00
Folwell's Water-supply Engineering.	8vo, 4 00
Frizell's Water-power.	8vo, 5 00
Fuertes's Water and Public Health.	12mo, 1 50
Water-filtration Works.	12mo, 2 50
Ganguillet and Kutter's General Formula for the Uniform Flow of Water in Rivers and Other Channels. (Hering and Trautwine.)	8vo, 4 00
Hazen's Filtration of Public Water-supply.	8vo, 3 00
Hazlehurst's Towers and Tanks for Water-works.	8vo, 2 50
Herschel's 115 Experiments on the Carrying Capacity of Large, Riveted, Metal Conduits.	8vo, 2 00
Mason's Water-supply. (Considered Principally from a Sanitary Stand-point.) 3d Edition, Rewritten	8vo, 4 00
Merriman's Treatise on Hydraulics. 9th Edition, Rewritten.	8vo, 5 00
* Michie's Elements of Analytical Mechanics.	8vo, 4 00
Schuyler's Reservoirs for Irrigation, Water-power, and Domestic Water-supply.	Large 8vo, 5 00
** Thomas and Watt's Improvement of Rivers. (Post., 44 c. additional),	4to, 6 00
Turneure and Russell's Public Water-supplies.	8vo, 5 00
Wegmann's Design and Construction of Dams.	4to, 5 00
Water-supply of the City of New York from 1658 to 1895.	4to, 10 00
Weisbach's Hydraulics and Hydraulic Motors. (Du Bois.)	8vo, 5 00
Wilson's Manual of Irrigation Engineering.	Small 8vo, 4 00
Wolf's Windmill as a Prime Mover.	8vo, 3 00
Wood's Turbines.	8vo, 2 50
Elements of Analytical Mechanics.	8vo, 3 00

MATERIALS OF ENGINEERING.

Baker's Treatise on Masonry Construction.	8vo, 5 00
Roads and Pavements.	8vo, 5 00
Black's United States Public Works.	Oblong 4to, 5 00
Bovey's Strength of Materials and Theory of Structures.	8vo, 7 50
Burr's Elasticity and Resistance of the Materials of Engineering. 6th Edition, Rewritten.	8vo, 7 50
Byrne's Highway Construction.	8vo, 5 00
Inspection of the Materials and Workmanship Employed in Construction.	16mo, 3 00
Church's Mechanics of Engineering.	8vo, 6 00
Du Bois's Mechanics of Engineering. Vol. I.	Small 4to, 7 50
Johnson's Materials of Construction.	Large 8vo, 6 00
Keep's Cast Iron.	8vo, 2 50
Lanza's Applied Mechanics.	8vo, 7 50
Martens's Handbook on Testing Materials. (Henning.) 2 vols.	8vo, 7 50
Merrill's Stones for Building and Decoration.	8vo, 5 00
Merriman's Text-book on the Mechanics of Materials.	8vo, 4 00
Strength of Materials.	12mo, 1 00
Metcalf's Steel. A Manual for Steel-users.	12mo, 2 00
Patton's Practical Treatise on Foundations.	8vo, 5 00

Rockwell's Roads and Pavements in France	12mo,	1 25
Smith's Materials of Machines	12mo,	1 00
Snow's Principal Species of Wood	8vo,	3 50
Spalding's Hydraulic Cement	12mo,	2 00
Text-book on Roads and Pavements	12mo,	2 00
Thurston's Materials of Engineering. 3 Parts	8vo,	8 00
Part I.—Non-metallic Materials of Engineering and Metallurgy	8vo,	2 00
Part II.—Iron and Steel	8vo,	3 50
Part III.—A Treatise on Brasses, Bronzes, and Other Alloys and their Constituents	8vo,	2 50
Thurston's Text-book of the Materials of Construction	8vo,	5 00
Tillson's Street Pavements and Paving Materials	8vo,	4 00
Waddell's De Pontibus. (A Pocket-book for Bridge Engineers.)	16mo, mor.,	3 00
Specifications for Steel Bridges	12mo,	1 25
Wood's Treatise on the Resistance of Materials, and an Appendix on the Pres- ervation of Timber	8vo,	2 00
Elements of Analytical Mechanics	8vo,	3 00
Wood's Rustless Coatings: Corrosion and Electrolysis of Iron and Steel	8vo,	4 00

RAILWAY ENGINEERING.

Andrews's Handbook for Street Railway Engineers. 3X5 inches. morocco	1 25
Berg's Buildings and Structures of American Railroads	4to, 5 00
Brooks's Handbook of Street Railroad Location	16mo. morocco, 1 50
Butts's Civil Engineer's Field-book	16mo, morocco, 2 50
Crandall's Transition Curve	16mo, morocco, 1 50
Railway and Other Earthwork Tables	8vo, 1 50
Dawson's "Engineering" and Electric Traction Pocket-book. 16mo, morocco	5 00
Dredge's History of the Pennsylvania Railroad: (1879)	Paper, 5 00
* Drinker's Tunneling, Explosive Compounds, and Rock Drills, 4to, half mor.,	25 00
Fisher's Table of Cubic Yards	Cardboard, 25
Godwin's Railroad Engineers' Field-book and Explorers' Guide	16mo, mor., 2 50
Howard's Transition Curve Field-book	16mo, morocco. 1 50
Hudson's Tables for Calculating the Cubic Contents of Excavations and Em- bankments	8vo, 1 00
Molitor and Beard's Manual for Resident Engineers	16mo, 1 00
Nagle's Field Manual for Railroad Engineers	16mo, morocco, 3 00
Philbrick's Field Manual for Engineers	16mo, morocco, 3 00
Searles's Field Engineering	16mo, morocco, 3 00
Railroad Spiral	16mo, morocco, 1 50
Taylor's Prismoidal Formulas and Earthwork	8vo, 1 50
* Trautwine's Method of Calculating the Cubic Contents of Excavations and Embankments by the Aid of Diagrams	8vo, 2 00
The Field Practice of Laying Out Circular Curves for Railroads.	12mo, morocco, 2 50
Cross-section Sheet	Paper, 25
Webb's Railroad Construction. 2d Edition, Rewritten	16mo. morocco, 5 00
Wellington's Economic Theory of the Location of Railways	Small 8vo, 5 00

DRAWING.

Barr's Kinematics of Machinery	8vo, 2 50
* Bartlett's Mechanical Drawing	8vo, 3 00
* " " " " Abridged Ed.	8vo, 1 50
Coolidge's Manual of Drawing	8vo, paper, 1 00
Coolidge and Freeman's Elements of General Drafting for Mechanical Engi- neers. (In press.)	
Durley's Kinematics of Machines	8vo, 4 00

Hill's Text-book on Shades and Shadows, and Perspective	8vo,	2 00
Jamison's Elements of Mechanical Drawing. (<i>In press.</i>)		
Jones's Machine Design:		
Part I.—Kinematics of Machinery	8vo,	1 50
Part II.—Form, Strength, and Proportions of Parts	8vo,	3 00
MacCord's Elements of Descriptive Geometry	8vo,	3 00
Kinematics; or, Practical Mechanism	8vo,	5 00
Mechanical Drawing	4to,	4 00
Velocity Diagrams	8vo,	1 50
* Mahan's Descriptive Geometry and Stone-cutting	8vo,	1 50
Industrial Drawing. (Thompson.)	8vo,	3 50
Reed's Topographical Drawing and Sketching	4to,	5 00
Reid's Course in Mechanical Drawing	8vo,	2 00
Text-book of Mechanical Drawing and Elementary Machine Design	8vo,	3 00
Robinson's Principles of Mechanism	8vo,	3 00
Smith's Manual of Topographical Drawing. (McMillan.)	8vo,	2 50
Warren's Elements of Plane and Solid Free-hand Geometrical Drawing	12mo,	1 00
Drafting Instruments and Operations	12mo,	1 25
Manual of Elementary Projection Drawing	12mo,	1 50
Manual of Elementary Problems in the Linear Perspective of Form and Shadow	12mo,	1 00
Plane Problems in Elementary Geometry	12mo,	1 25
Primary Geometry	12mo,	75
Elements of Descriptive Geometry, Shades, and Perspective	8vo,	3 50
General Problems of Shades and Shadows	8vo,	3 00
Elements of Machine Construction and Drawing	8vo,	7 50
Problems, Theorems, and Examples in Descriptive Geometry	8vo,	2 50
Weisbach's Kinematics and the Power of Transmission. (Hermann and Klein.)	8vo,	5 00
Whelpley's Practical Instruction in the Art of Letter Engraving	12mo,	2 00
Wilson's Topographic Surveying	8vo,	3 50
Free-hand Perspective	8vo,	2 50
Free-hand Lettering	8vo,	1 00
Woolf's Elementary Course in Descriptive Geometry	Large 8vo,	3 00

ELECTRICITY AND PHYSICS.

Anthony and Brackett's Text-book of Physics. (Magie.)	Small 8vo,	3 00
Anthony's Lecture-notes on the Theory of Electrical Measurements	12mo,	1 00
Benjamin's History of Electricity	8vo,	3 00
Voltaic Cell	8vo,	3 00
Classen's Quantitative Chemical Analysis by Electrolysis. (Boltwood.)	8vo,	3 00
Crehore and Squier's Polarizing Photo-chronograph	8vo,	3 00
Dawson's "Engineering" and Electric Traction Pocket-book	16mo, morocco,	5 00
Dolezalek's Theory of the Lead Accumulator (Storage Battery). (Von Ende.)	12mo,	2 50
Duhem's Thermodynamics and Chemistry. (Burgess.)	8vo,	4 00
Fletcher's Dynamometers, and the Measurement of Power	12mo,	3 00
Gilbert's De Magnete. (Mottelay.)	8vo,	2 50
Hanchett's Alternating Currents Explained.	12mo,	1 00
Hering's Ready Reference Tables (Conversion Factors)	16mo, morocco,	2 50
Holman's Precision of Measurements	8vo,	2 00
Telescopic Mirror-scale Method, Adjustments, and Tests	Large 8vo,	75
Landauer's Spectrum Analysis. (Tingle.)	8vo,	3 00
Le Chatelier's High-temperature Measurements. (Boudouard—Burgess.)	12mo,	3 00
Löb's Electrolysis and Electrosynthesis of Organic Compounds. (Lorenz.)	12mo,	1 00
* Lyons's Treatise on Electromagnetic Phenomena. Vols. I. and II.	8vo, each,	6 00
* Michle. Elements of Wave Motion Relating to Sound and Light	8vo,	4 00

Niaudet's Elementary Treatise on Electric Batteries. (Fishback.)	12mo,	2 50
* Rosenberg's Electrical Engineering. (Haldane Gee—Kinzbrunner.)	8vo,	1 50
Ryan, Norris, and Hoxie's Electrical Machinery. Vol. I.	8vo,	2 50
Thurston's Stationary Steam-engines	8vo,	2 50
* Tillman's Elementary Lessons in Heat	8vo,	1 50
Tory and Pitcher's Manual of Laboratory Physics	Small 8vo,	2 00
Ulke's Modern Electrolytic Copper Refining	8vo,	3 00

LAW.

* Davis's Elements of Law	8vo,	2 50
* Treatise on the Military Law of United States	8vo,	7 00
	Sheep,	7 50
Manual for Courts-martial	16mo, morocco,	1 50
Wait's Engineering and Architectural Jurisprudence	8vo,	6 00
	Sheep,	6 50
Law of Operations Preliminary to Construction in Engineering and Architecture	8vo,	5 00
	Sheep,	5 50
Law of Contracts	8vo,	3 00
Winthrop's Abridgment of Military Law	12mo,	2 50

MANUFACTURES.

Bernadou's Smokeless Powder—Nitro-cellulose and Theory of the Cellulose Molecule	12mo,	2 50
Bolland's Iron Founder	12mo,	2 50
"The Iron Founder," Supplement	12mo,	2 50
Encyclopedia of Founding and Dictionary of Foundry Terms Used in the Practice of Moulding	12mo,	3 00
Eissler's Modern High Explosives	8vo,	4 00
Eiffont's Enzymes and their Applications. (Prescott.)	8vo,	3 00
Fitzgerald's Boston Machinist	18mo,	1 00
Ford's Boiler Making for Boiler Makers	18mo,	1 00
Hopkins's Oil-chemists' Handbook	8vo,	3 00
Keep's Cast Iron	8vo,	2 50
Leach's The Inspection and Analysis of Food with Special Reference to State Control. (<i>In preparation.</i>)		
Metcalf's Steel. A Manual for Steel-users	12mo,	2 00
Metcalf's Cost of Manufactures—And the Administration of Workshops, Public and Private	8vo,	5 00
Meyer's Modern Locomotive Construction	4to,	10 00
Morse's Calculations used in Cane-sugar Factories	16mo, morocco,	1 50
* Reising's Guide to Piece-dyeing	8vo,	25 00
Smith's Press-working of Metals	8vo,	3 00
Spalding's Hydraulic Cement	12mo,	2 00
Spencer's Handbook for Chemists of Beet-sugar Houses	16mo, morocco,	3 00
Handbook for Sugar Manufacturers and their Chemists	16mo, morocco,	2 00
Thurston's Manual of Steam-boilers, their Designs, Construction and Operation	8vo,	5 00
* Walke's Lectures on Explosives	8vo,	4 00
West's American Foundry Practice	12mo,	2 50
Moulder's Text-book	12mo,	2 50
Wiechmann's Sugar Analysis	Small 8vo,	2 50
Wolf's Windmill as a Prime Mover	8vo,	3 00
Woodbury's Fire Protection of Mills	8vo,	2 50
Wood's Rustless Coatings: Corrosion and Electrolysis of Iron and Steel	8vo,	4 00

MATHEMATICS.

Baker's Elliptic Functions.....	8vo,	1 50
* Bass's Elements of Differential Calculus.....	12mo,	4 00
Briggs's Elements of Plane Analytic Geometry.....	12mo,	1 00
Compton's Manual of Logarithmic Computations.....	12mo,	1 50
Davis's Introduction to the Logic of Algebra.....	8vo,	1 50
* Dickson's College Algebra.....	Large 12mo,	1 50
* Answers to Dickson's College Algebra.....	8vo, paper,	25
* Introduction to the Theory of Algebraic Equations.....	Large 12mo,	1 25
Halsted's Elements of Geometry.....	8vo,	1 75
Elementary Synthetic Geometry.....	8vo,	1 50
Rational Geometry.....	12mo,	1 75
* Johnson's Three-place Logarithmic Tables: Vest-pocket size.....	paper,	15
100 copies for.....		5 00
Mounted on heavy cardboard, 8 X 10 inches,.....		25
10 copies for.....		2 00
Elementary Treatise on the Integral Calculus.....	Small 8vo,	1 50
Curve Tracing in Cartesian Co-ordinates.....	12mo,	1 00
Treatise on Ordinary and Partial Differential Equations.....	Small 8vo,	3 50
Theory of Errors and the Method of Least Squares.....	12mo,	1 50
* Theoretical Mechanics.....	12mo,	3 00
Laplace's Philosophical Essay on Probabilities. (Truscott and Emory.)	12mo,	2 00
* Ludlow and Bass. Elements of Trigonometry and Logarithmic and Other Tables.....	8vo,	3 00
Trigonometry and Tables published separately.....	Each,	2 00
* Ludlow's Logarithmic and Trigonometric Tables.....	8vo,	1 00
Maurer's Technical Mechanics.....	8vo,	4 00
Merriman and Woodward's Higher Mathematics.....	8vo,	5 00
Merriman's Method of Least Squares.....	8vo,	2 00
Rice and Johnson's Elementary Treatise on the Differential Calculus. Sm.,	8vo,	3 00
Differential and Integral Calculus. 2 vols. in one.....	Small 8vo,	2 50
Sabin's Industrial and Artistic Technology of Paints and Varnish. (<i>In press.</i>)		
Wood's Elements of Co-ordinate Geometry.....	8vo,	2 00
Trigonometry: Analytical, Plane, and Spherical.....	12mo,	1 00

MECHANICAL ENGINEERING.

MATERIALS OF ENGINEERING, STEAM-ENGINES AND BOILERS.

Baldwin's Steam Heating for Buildings.....	12mo,	2 50
Barr's Kinematics of Machinery.....	8vo,	2 50
* Bartlett's Mechanical Drawing.....	8vo,	3 00
* " " " Abridged Ed.....	8vo,	1 50
Benjamin's Wrinkles and Recipes.....	12mo,	2 00
Carpenter's Experimental Engineering.....	8vo,	6 00
Heating and Ventilating Buildings.....	8vo,	4 00
Cary's Smoke Suppression in Plants using Bituminous Coal. (<i>In preparation.</i>)		
Clerk's Gas and Oil Engine.....	Small 8vo,	4 00
Coolidge's Manual of Drawing.....	8vo, paper,	1 00
Coolidge and Freeman's Elements of General Drafting for Mechanical Engineers. (<i>In press.</i>)		
Cromwell's Treatise on Toothed Gearing.....	12mo,	1 50
Treatise on Belts and Pulleys.....	12mo,	1 50
Durley's Kinematics of Machines.....	8vo,	4 00
Flather's Dynamometers and the Measurement of Power.....	12mo,	3 00
Rope Driving.....	12mo,	2 00

Gill's Gas and Fuel Analysis for Engineers	12mo,	1 25
Hall's Car Lubrication	12mo,	1 00
Hering's Ready Reference Tables (Conversion Factors)	16mo, morocco,	2 50
Hutton's The Gas Engine	8vo,	5 00
Jones's Machine Design:		
Part I.—Kinematics of Machinery	8vo,	1 50
Part II.—Form, Strength, and Proportions of Parts	8vo,	3 00
Kent's Mechanical Engineer's Pocket-book	16mo, morocco,	5 00
Kerr's Power and Power Transmission	8vo,	2 00
MacCord's Kinematics; or, Practical Mechanism	8vo,	5 00
Mechanical Drawing	4to,	4 00
Velocity Diagrams	8vo,	1 50
Mahan's Industrial Drawing. (Thompson)	8vo,	3 50
Poole's Calorific Power of Fuels	8vo,	3 00
Reid's Course in Mechanical Drawing	8vo,	2 00
Text-book of Mechanical Drawing and Elementary Machine Design	8vo,	3 00
Richards's Compressed Air	12mo,	1 50
Robinson's Principles of Mechanism	8vo,	3 00
Smith's Press-working of Metals	8vo,	3 00
Thurston's Treatise on Friction and Lost Work in Machinery and Mill Work	8vo,	3 00
Animal as a Machine and Prime Motor, and the Laws of Energetics	12mo,	1 00
Warren's Elements of Machine Construction and Drawing	8vo,	7 50
Weisbach's Kinematics and the Power of Transmission. Herrmann—Klein	8vo,	5 00
Machinery of Transmission and Governors. (Herrmann—Klein)	8vo,	5 00
Hydraulics and Hydraulic Motors. (Du Bois)	8vo,	5 00
Wolff's Windmill as a Prime Mover	8vo,	3 00
Wood's Turbines	8vo,	2 50

MATERIALS OF ENGINEERING.

Bovey's Strength of Materials and Theory of Structures	8vo,	7 50
Burr's Elasticity and Resistance of the Materials of Engineering. 6th Edition, Reset	8vo,	7 50
Church's Mechanics of Engineering	8vo,	6 00
Johnson's Materials of Construction	Large 8vo,	6 00
Keep's Cast Iron	8vo,	2 50
Lanza's Applied Mechanics	8vo,	7 50
Martens's Handbook on Testing Materials. (Henning)	8vo,	7 50
Merriman's Text-book on the Mechanics of Materials	8vo,	4 00
Strength of Materials	12mo,	1 00
Metcalf's Steel. A Manual for Steel-users	12mo,	2 00
Smith's Materials of Machines	12mo,	1 00
Thurston's Materials of Engineering	3 vols., 8vo,	8 00
Part II.—Iron and Steel	8vo,	3 50
Part III.—A Treatise on Brasses, Bronzes, and Other Alloys and their Constituents	8vo,	2 50
Text-book of the Materials of Construction	8vo,	5 00
Wood's Treatise on the Resistance of Materials and an Appendix on the Preservation of Timber	8vo,	2 00
Elements of Analytical Mechanics	8vo,	3 00
Wood's Rustless Coatings: Corrosion and Electrolysis of Iron and Steel	8vo,	4 00

STEAM-ENGINES AND BOILERS.

Carnot's Reflections on the Motive Power of Heat. (Thurston)	12mo,	1 50
Dawson's "Engineering" and Electric Traction Pocket-book	16mo, mor.,	5 00
Ford's Boiler Making for Boiler Makers	18mo,	1 00

Goss's Locomotive Sparks	8vo,	2 00
Hemenway's Indicator Practice and Steam-engine Economy	12mo,	2 00
Hutton's Mechanical Engineering of Power Plants	8vo,	5 00
Heat and Heat-engines	8vo,	5 00
Kent's Steam-boiler Economy	8vo,	4 00
Kneass's Practice and Theory of the Injector	8vo	1 50
MacCord's Slide-valves	8vo,	2 00
Meyer's Modern Locomotive Construction	4to,	10 00
Peabody's Manual of the Steam-engine Indicator	12mo,	1 50
Tables of the Properties of Saturated Steam and Other Vapors	8vo,	1 00
Thermodynamics of the Steam-engine and Other Heat-engines	8vo,	5 00
Valve-gears for Steam-engines	8vo,	2 50
Peabody and Miller's Steam-boilers	8vo,	4 00
Pray's Twenty Years with the Indicator	Large 8vo,	2 50
Pupln's Thermodynamics of Reversible Cycles in Gases and Saturated Vapors. (Osterberg.)	12mo,	1 25
Reagan's Locomotives: Simple, Compound, and Electric	12mo,	2 50
Rontgen's Principles of Thermodynamics. (Du Bois.)	8vo,	5 00
Sinclair's Locomotive Engine Running and Management	12mo,	2 00
Smart's Handbook of Engineering Laboratory Practice	12mo,	2 50
Snow's Steam-boiler Practice	8vo,	3 00
Spangler's Valve-gears	8vo,	2 50
Notes on Thermodynamics	12mo,	1 00
Spangler, Greene, and Marshall's Elements of Steam-engineering	8vo,	3 00
Thurston's Handy Tables	8vo,	1 50
Manual of the Steam-engine	2 vols. 8vo,	10 00
Part I.—History, Structure, and Theory	8vo,	6 00
Part II.—Design, Construction, and Operation	8vo,	6 00
Handbook of Engine and Boiler Trials, and the Use of the Indicator and the Prony Brake	8vo	5 00
Stationary Steam-engines	8vo,	2 50
Steam-boiler Explosions in Theory and in Practice	12mo	1 50
Manual of Steam-boilers, Their Designs, Construction, and Operation	8vo,	5 00
Weisbach's Heat, Steam, and Steam-engines. (Du Bois.)	8vo,	5 00
Whitham's Steam-engine Design	8vo,	5 00
Wilson's Treatise on Steam-boilers. (Flather.)	16mo,	2 50
Wood's Thermodynamics Heat Motors, and Refrigerating Machines	8vo,	4 00

MECHANICS AND MACHINERY.

Barr's Kinematics of Machinery	8vo,	2 50
Bovey's Strength of Materials and Theory of Structures	8vo,	7 50
Chase's The Art of Pattern-making	12mo,	2 50
Chordal.—Extracts from Letters	12mo,	2 00
Church's Mechanics of Engineering	8vo,	6 00
Notes and Examples in Mechanics	8vo,	2 00
Compton's First Lessons in Metal-working	12mo,	1 50
Compton and De Groodt's The Speed Lathe	12mo,	1 50
Cromwell's Treatise on Toothed Gearing	12mo,	1 50
Treatise on Belts and Pulleys	12mo,	1 50
Dana's Text-book of Elementary Mechanics for the Use of Colleges and Schools	12mo,	1 50
Dingey's Machinery Pattern Making	12mo,	2 00
Dredge's Record of the Transportation Exhibits Building of the World's Columbian Exposition of 1893	4to, half morocco,	5 00

Du Bois's Elementary Principles of Mechanics:

Vol. I.—Kinematics.....	8vo,	3 50
Vol. II.—Statics.....	8vo,	4 00
Vol. III.—Kinetics.....	8vo,	3 50
Mechanics of Engineering. Vol. I.....	Small 4to,	7 50
Vol. II.....	Small 4to,	10 00
Durley's Kinematics of Machines.....	8vo,	4 00
Fitzgerald's Boston Machinist.....	16mo,	1 00
Flather's Dynamometers, and the Measurement of Power.....	12mo,	3 00
Rope Driving.....	12mo,	2 00
Goss's Locomotive Sparks.....	8vo	2 00
Hall's Car Lubrication.....	12mo,	1 00
Holly's Art of Saw Filing.....	18mo,	75
* Johnson's Theoretical Mechanics.....	12mo,	3 00
Statistics by Graphic and Algebraic Methods.....	8vo,	2 00
Jones's Machine Design:		
Part I.—Kinematics of Machinery.....	8vo,	1 50
Part II.—Form, Strength, and Proportions of Parts.....	8vo,	3 00
Kerr's Power and Power Transmission.....	8vo,	2 00
Lanza's Applied Mechanics.....	8vo,	7 50
MacCord's Kinematics; or, Practical Mechanism.....	8vo,	5 00
Velocity Diagrams.....	8vo,	1 50
Maurer's Technical Mechanics.....	8vo,	4 00
Merriman's Text-book on the Mechanics of Materials.....	8vo,	4 00
* Michie's Elements of Analytical Mechanics.....	8vo,	4 00
Reagan's Locomotives: Simple, Compound, and Electric.....	12mo,	2 50
Reid's Course in Mechanical Drawing.....	8vo,	2 00
Text-book of Mechanical Drawing and Elementary Machine Design.....	8vo,	3 00
Richards's Compressed Air.....	12mo,	1 50
Robinson's Principles of Mechanism.....	8vo,	3 00
Ryan, Norris, and Hoxie's Electrical Machinery. Vol. I.....	8vo,	2 50
Sinclair's Locomotive-engine Running and Management.....	12mo,	2 00
Smith's Press-working of Metals.....	8vo,	3 00
Materials of Machines.....	12mo,	1 00
Spangler, Greene, and Marshall's Elements of Steam-engineering.....	8vo,	3 00
Thurston's Treatise on Friction and Lost Work in Machinery and Mill Work.....	8vo,	3 00
Animal as a Machine and Prime Motor, and the Laws of Energetics.....	12mo,	1 00
Warren's Elements of Machine Construction and Drawing.....	8vo,	7 50
Weisbach's Kinematics and the Power of Transmission. (Herrmann—Klein.).....	8vo,	5 00
Machinery of Transmission and Governors. (Herrmann—Klein.).....	8vo,	5 00
Wood's Elements of Analytical Mechanics.....	8vo,	3 00
Principles of Elementary Mechanics.....	12mo,	1 25
Turbines.....	8vo,	2 50
The World's Columbian Exposition of 1893.....	4to,	1 00

METALLURGY.

Egleston's Metallurgy of Silver, Gold, and Mercury:

Vol. I.—Silver.....	8vo,	7 50
Vol. II.—Gold and Mercury.....	8vo,	7 50
** Iles's Lead-smelting. (Postage 9 cents additional.).....	12mo,	2 50
Keep's Cast Iron.....	8vo,	2 50
Kunhardt's Practice of Ore Dressing in Europe.....	8vo,	1 50
Le Chatelier's High-temperature Measurements. (Boudouard—Burgess.).....	12mo,	3 00
Metcalf's Steel. A Manual for Steel-users.....	12mo,	2 00
Smith's Materials of Machines.....	12mo,	1 00

Thurston's Materials of Engineering. In Three Parts.....	8vo,	8 00
Part II.—Iron and Steel.....	8vo,	3 50
Part III.—A Treatise on Brasses, Bronzes, and Other Alloys and their Constituents.....	8vo,	2 50
Ulke's Modern Electrolytic Copper Refining.....	8vo,	3 00

MINERALOGY.

Barringer's Description of Minerals of Commercial Value. Oblong, morocco.....	2 50
Boyd's Resources of Southwest Virginia.....	8vo, 3 00
Map of Southwest Virginia.....	Pocket-book form, 2 00
Brush's Manual of Determinative Mineralogy. (Penfield.).....	8vo, 4 00
Chester's Catalogue of Minerals.....	8vo, paper, 1 00
Cloth.....	1 25
Dictionary of the Names of Minerals.....	8vo, 3 50
Dana's System of Mineralogy.....	Large 8vo, half leather, 12 50
First Appendix to Dana's New "System of Mineralogy.".....	Large 8vo, 1 00
Text-book of Mineralogy.....	8vo, 4 00
Minerals and How to Study Them.....	12mo, 1 50
Catalogue of American Localities of Minerals.....	Large 8vo, 1 00
Manual of Mineralogy and Petrography.....	12mo, 2 00
Eakle's Mineral Tables.....	8vo, 1 25
Egleston's Catalogue of Minerals and Synonyms.....	8vo, 2 50
Hussak's The Determination of Rock-forming Minerals. (Smith.) Small 8vo.....	2 00
Merrill's Non-metallic Minerals: Their Occurrence and Uses.....	8vo, 4 00
* Penfield's Notes on Determinative Mineralogy and Record of Mineral Tests. 8vo, paper.....	0 50
Rosenbusch's Microscopical Physiography of the Rock-making Minerals. (Iddings.).....	8vo, 5 00
* Tillman's Text-book of Important Minerals and Docks.....	8vo, 2 00
Williams's Manual of Lithology.....	8vo, 3 00

MINING.

Beard's Ventilation of Mines.....	12mo, 2 50
Boyd's Resources of Southwest Virginia.....	8vo, 3 00
Map of Southwest Virginia.....	Pocket-book form, 2 00
* Drinker's Tunneling, Explosive Compounds, and Rock Drills. 4to, half morocco.....	25 00
Eissler's Modern High Explosives.....	8vo, 4 00
Fowler's Sewage Works Analyses.....	12mo, 2 00
Goodyear's Coal-mines of the Western Coast of the United States.....	12mo, 2 50
Ihlseng's Manual of Mining.....	8vo, 4 00
** Iles's Lead-smelting. (Postage 9c. additional.).....	12mo, 2 50
Kunhardt's Practice of Ore Dressing in Europe.....	8vo, 1 50
O'Driscoll's Notes on the Treatment of Gold Ores.....	8vo, 2 00
* Walke's Lectures on Explosives.....	8vo, 4 00
Wilson's Cyanide Processes.....	12mo, 1 50
Chlorination Process.....	12mo, 1 50
Hydraulic and Placer Mining.....	12mo, 2 00
Treatise on Practical and Theoretical Mine Ventilation.....	12mo 1 25

SANITARY SCIENCE.

Copeland's Manual of Bacteriology. (<i>In preparation.</i>).....	8vo, 3 00
Folwell's Sewerage. (Designing, Construction and Maintenance.).....	8vo, 4 00
Water-supply Engineering.....	8vo, 4 00
Fuertes's Water and Public Health.....	12mo, 1 50
Water-filtration Works.....	12mo, 2 50

Gerhard's Guide to Sanitary House-inspection.....	16mo,	1 00
Goodrich's Economical Disposal of Town's Refuse.....	Demy 8vo,	3 50
Hazen's Filtration of Public Water-supplies.....	8vo,	3 00
Kierstedt's Sewage Disposal.....	12mo,	1 25
Leach's The Inspection and Analysis of Food with Special Reference to State Control. (<i>In preparation.</i>)		
Mason's Water-supply. (Considered Principally from a Sanitary Standpoint.) 3d Edition, Rewritten.....	8vo,	4 00
Examination of Water. (Chemical and Bacteriological).....	12mo,	1 25
Merriman's Elements of Sanitary Engineering.....	8vo,	2 00
Nichols's Water-supply. (Considered Mainly from a Chemical and Sanitary Standpoint.) (1883.).....	8vo,	2 50
Ogden's Sewer Design.....	12mo,	2 00
Prescott and Winslow's Elements of Water Bacteriology, with Special Reference to Sanitary Water Analysis.....	12mo,	1 25
* Price's Handbook on Sanitation.....	12mo,	1 50
Richards's Cost of Food. A Study in Dieteries.....	12mo,	1 00
Cost of Living as Modified by Sanitary Science.....	12mo,	1 00
Richards and Woodman's Air, Water, and Food from a Sanitary Standpoint.....	8vo,	2 00
* Richards and Williams's The Dietary Computer.....	8vo,	1 50
Rideal's Sewage and Bacterial Purification of Sewage.....	8vo,	3 50
Turneure and Russell's Public Water-supplies.....	8vo,	5 00
Whipple's Microscopy of Drinking-water.....	8vo,	3 50
Woodhull's Notes and Military Hygiene.....	16mo,	1 50

MISCELLANEOUS.

Barker's Deep-sea Soundings.....	8vo,	2 00
Emmons's Geological Guide-book of the Rocky Mountain Excursion of the International Congress of Geologists.....	Large 8vo	1 50
Ferrel's Popular Treatise on the Winds.....	8vo	4 00
Haines's American Railway Management.....	12mo,	2 50
Mott's Composition, Digestibility, and Nutritive Value of Food. Mounted chart.....		1 25
Fallacy of the Present Theory of Sound.....	16mo	1 00
Ricketts's History of Rensselaer Polytechnic Institute, 1824-1894. Small 8vo.....		3 00
Rotherham's Emphasized New Testament.....	Large 8vo,	2 00
Steel's Treatise on the Diseases of the Dog.....	8vo,	3 50
Totten's Important Question in Metrology.....	8vo	2 50
The World's Columbian Exposition of 1893.....	4to,	1 00
Worcester and Atkinson. Small Hospitals, Establishment and Maintenance, and Suggestions for Hospital Architecture, with Plans for a Small Hospital.....	12mo,	1 25

HEBREW AND CHALDEE TEXT-BOOKS.

Green's Grammar of the Hebrew Language.....	8vo,	3 00
Elementary Hebrew Grammar.....	12mo,	1 25
Hebrew Chrestomathy.....	8vo,	2 00
Gesenius's Hebrew and Chaldee Lexicon to the Old Testament Scriptures. (Tregelles.).....	Small 4to, half morocco,	5 00
Letteris's Hebrew Bible.....	8vo,	2 25

