





200. 10. 100.

A WORK
ON
OPERATIVE DENTISTRY

IN TWO VOLUMES.

VOLUME TWO,
THE TECHNICAL PROCEDURES IN FILLING TEETH.

INDEX.

447 ILLUSTRATIONS.

BY

G. V. BLACK, M.D., D.D.S., Sc.D., LL.D.

DEAN AND PROFESSOR OF OPERATIVE DENTISTRY, DENTAL PATHOLOGY AND BACTERIOLOGY
NORTHWESTERN UNIVERSITY DENTAL SCHOOL.

SECOND EDITION.

CHICAGO:
MEDICO-DENTAL PUBLISHING COMPANY.

LONDON:
CLAUDIUS ASH, SONS & CO., LTD.

1914

Entered, according to Act of Congress, in the year 1914,
by G. V. Black,
in the Office of the Librarian of Congress, Washington, D. C.

Entered at Stationers' Hall,
London, Eng.

CONTENTS OF VOLUME II.

THE TECHNICAL PROCEDURES IN FILLING TEETH.

	PAGE
INTRODUCTION	1
NOMENCLATURE	2
Cavity Nomenclature	2
Classification of Cavities into Artificial Groups.....	5
Nomenclature of Internal Parts of Cavities.....	6
Nomenclature of Enamel Margins.....	14
Planes of the Teeth and the Inclination of Cavity Walls.....	14
Divisions of the Surfaces of the Teeth in Cavity Description..	15
CUTTING INSTRUMENTS	17
Instrument Nomenclature	17
Names of Operating Instruments.....	18
Formula Names	22
The Metric System of Measurement, The Dental Instru- ment Gauge, The Centigrade Circle, The Boley Gauge.	
Classification of Instruments.....	26
Instrument Construction	29
Sharpening Instruments	33
Studies of Instrument Forms and Formulas with Brief Out- line of their Uses	38
Arrangement of Instruments in the Operating Case.....	43
USE OF THE DENTAL ENGINE.....	44
USE OF WATER.....	49
INSTRUMENT GRASPS	52
FINGER POWER	53
POSITIONS AT THE CHAIR.....	56
FINGER POSITIONS	60
THE RUBBER DAM.....	69
Rubber Dam Grasps.....	73
Tabulation of Grasps Used in the Application of the Rubber Dam	73
Aids in Adjusting the Rubber Dam.....	79
Use of Ligatures.....	85
Rubber Dam Clamps.....	88

	PAGE
HISTOLOGICAL STRUCTURE OF THE TEETH IN RELATION TO CAVITY PREPARATION	93
Histological Characters of the Enamel in Relation to the Preparation of Cavities.....	94
Recessional Lines of the Pulpal Horns.....	102
CAVITY PREPARATION	105
Brief Review of the Injuries to the Teeth by Caries, in their Relation to Cavity Preparation	105
Order of Procedure in Cavity Preparation.....	110
EXCAVATION OF CAVITIES BY CLASSES.....	117
Class 1. Pit and Fissure Cavities.....	120
Case, Small Pit Cavity in Central Fossa of an Upper First Molar; Variations. Case, Large Pit Cavity in Central Fossa of an Upper First Molar. Deep Oeclusal Cavities in Molars; Variations. Pit Cavities in the Buccal Surfaces of Molars. Pit Cavities in the Lingual Surfaces of Incisors.	
Smooth-Surface Cavities	140
Extension for Prevention. What Extension for Prevention Means.	
Class 2. Cavities in the Proximal Surfaces of the Bicuspids and Molars	143
The Oeclusal Step. Extension Limited by the Separation of the Teeth. What Extension for Prevention does not Mean. Early Discovery of Cavities. Extensions of Caries Gingivally. Similarity of Gingival Extensions of Caries to the Undermining of Gingival Walls of Fillings. Plans of Excavating. Case, Mesio-oeclusal Cavity in Upper Molar; Variations. Danger of Pulp Exposure in Cavity Preparation. Case, Mesio-oeclusal Cavity in Upper Molar. Illustrations from Cross Sections.	
Management of Weak Walls in Bicuspids and Molars.....	167
Case, Mesio-oeclusal Cavity in Lower Second Molar. The Lingual Groove in Lower Molars. In Upper Molars. Undermining of the Disto-lingual Cusp of Upper First Molars. Undermining of Angles of Bicuspids. Mesio-disto-oeclusal Cavities in the Bicuspids when the Pulp is Alive and when the Pulp is Removed.	

Class 3. Cavities in the Proximal Surfaces of the Incisors and Cuspids Which do not Require the Removal and Restoration of the Incisal Angle..... 177

 Case, Mesial Cavity in Upper Central Incisor. Case, Distal Cavity in Upper Central Incisor. Case, Distal Cavity in Upper Lateral Incisor. Case, Mesial Cavity in Upper Central Incisor.

General Observations on the Preparation of Proximal Cavities in the Incisors and Cuspids..... 189

Class 4. Cavities in the Proximal Surfaces of the Incisors Which do Require the Removal and Restoration of the Incisal Angle 191

 Conditions that may Present. General Statement of Choice of Plans. Anchorage by Undercutting Incisal Edge. Anchorage by Forming a Step in the Incisal Edge. Anchorage in the Pulp Chamber.

Class 5. Cavities in the Gingival Third — not Pit Cavities — in the Buccal, Labial or Lingual Surfaces of the Teeth.. 199

 Case, Buccal Cavity in Upper First Molar. Case, Buccal Cavities in Upper Bicuspids and Molars. Case, Labial Cavity in Upper Central Incisor. Variations.

Senile Decay of the Teeth..... 210

Interproximal Wear and Its Treatment..... 211

Abrasion of the Teeth..... 215

PHYSICAL PROPERTIES OF FILLING MATERIALS AND CORRELATION OF FORCES CONCERNED 224

Filling Materials 224

 Gold. Amalgam. Porcelain and Gold Inlays. Forms of Gold. Welding Properties of Gold. Annealing Gold.

The Specific Gravity and Resistance to Crushing Stress of Pure Gold in Varying Physical Conditions and in Fillings.. 232

 Table Showing Specific Gravity of Pure Gold, Cast, Hammered and Annealed, and Per Cent of Shortening Under Stress. Table Showing Same for Gold Fillings.

The Nature of Blows and the Relation of Size of Plugger Points to Force as Used in Filling Teeth..... 237

 Table Showing Diameter and Area of Plugger Points, and Stress by Fall of Mallets.

Strength of the Bite..... 245

	PAGE
FILLING WITH GOLD.....	247
Filling with Non-cohesive Gold.....	247
Filling with Cohesive Gold.....	249
Preparation of Gold Foil. Application of Force in Filling with Cohesive Gold. The Relation of the Size of Plugger Points to the Application of Force. Plugger Points. Back Action and Quadrangle Instruments.	
Separating Teeth	259
FILLING CAVITIES WITH GOLD BY CLASSES.....	265
Class 2. Proximal Cavities in Bicuspids and Molars.....	265
Case, Mesio-occlusal Cavity in Upper First Molar. Starting the Filling with Cohesive Gold. The Angle at which the Condensing Force should be Applied. The Wedging Principle. Covering the Gingival Wall. Covering the Cavo-surface Angle. Building into the Occlusal Step. Building the Contact Point. Covering the Occlusal Margins. After-condensation. Combination of Non-cohesive and Cohesive Gold in Proximal Cavities in the Bicuspids and Molars. Distal Cavities in Bicuspids and Molars.	
Class 1. Pit and Fissure Cavities.....	280
Occlusal Cavities. Other Pit and Fissure Cavities.	
Classes 3 and 4. Proximal Cavities in the Incisors and Cuspids	282
Case, Distal Surface of Upper Central Incisor. The Gingival Portion. Incisal Retention. Contact Point. After-condensation. Variations Occurring in Incisor Proximal Cavities. The Lamination of Gold in Incisor Proximal Cavities and Building of Angles that have been Lost.	
Class 5. Cavities in the Gingival Third of Buccal and Labial Surfaces	289
FINISHING GOLD FILLINGS.....	291
Separation. The Saws. Finishing Knives. Finishing Files. Proper Form of Proximal Surface Fillings. Form of Contact Point. The Occlusal Surface. Polishing.	

	PAGE
AMALGAM	299
Historical	299
Summary of Results of Experimental Work. Measurement of Bulk Changes. Developments of My Own Experi- mental Work. Experiments with Silver-tin Alloys. Exhibit of Unmodified Silver-tin Alloys. Modifica- tions of Silver-tin Alloys by the Addition of other Metals. Exhibit of Modified Silver-tin Alloys. Color of Amalgams. Discoloration of the Substance of the Teeth by Amalgam.	
The Strength of Amalgam Depends on Several Factors.....	316
The Metals Entering into the Alloy. Manner of Mixing and Packing. The Length of Time the Cut Alloy Stands. The Flow of Amalgam. The Spheroiding of Amalgam.	
Principles Governing the Manipulation of Amalgam.....	319
Shrinkage and Expansion of the Amalgam Used is not Under Control of Manipulation by the Operator. Strength of Amalgam is Directly Under Control of Manipulation. The Kneading. Four Surrounding Walls for all Cavities. Pluggers and Packing Amal- gam.	
Filling with Amalgam.....	324
Cavity Preparation. The Rubber Dam. The Matrix. Sep- aration. Placing the Filling. Trimming. Polishing.	
PORCELAIN AND GOLD INLAYS.....	330
Selection of Cases for Porecelain and Gold Inlays.....	331
Preparation of Cavities for Inlays.....	333
Case, Labial Cavity in Upper Central Incisor.	
The Porecelain Inlay.....	344
The Matrix. Making the Inlay. Furnaces for Inlay Work. Setting the Inlay.	
The Gold Inlay.....	352
THE CEMENTS	355
GUTTA-PERCHA	360

	PAGE
EXPOSURE AND REMOVAL OF THE DENTAL PULP AND THE FILLING OF	
ROOT CANALS	363
Exposure of the Dental Pulp.....	363
Destroying the Dental Pulp with Arsenic.....	365
Anesthetizing the Dental Pulp with Cocain.....	366
Opening the Pulp Chamber Preparatory to Removal of the	
Pulp	368
Removal of the Pulp.....	371
Variations in the Forms of Pulp Chambers. Opening Pulp	
Chambers in Sound Teeth. Cleaning Root Canals.	
Cleaning Infected Pulp Canals.	
Filling Root Canals.....	382
INDEX	387

LIST OF ILLUSTRATIONS.

	NUMBER
CAVITY NOMENCLATURE	1-14
Nomenclature of internal parts of cavities.....	1-7
Nomenclature of enamel margins	8
Planes of the teeth.....	9, 10, 11
Divisions of the surfaces of the teeth in cavity description.....	12, 13, 14
CUTTING INSTRUMENTS	15-24
Instruments incorrectly and instruments correctly contra- angled	15, 16
Dental instrument gauge	17
Boley gauge	18
Set of one hundred and two excavators.....	19, 20, 21
University set of forty-eight excavators.....	22, 23
Short set of twenty-five excavators.....	24
CONTRA-ANGLE HAND-PIECE	25
INSTRUMENT GRASPS	26-30
DENTISTS' MANUDYNAMOMETER	31, 32, 33
POSITIONS AT THE CHAIR	34-45
FINGER POSITIONS	46-61
THE RUBBER DAM.....	62-99
Positions of holes in the rubber dam.....	62-65
Rubber dam grasps.....	66-83
Tying ligatures on incisors and cuspids, danger of injury to the soft tissues	84, 85, 86
Knots	87, 88, 89
Rubber dam clamps	90-94
Hatch clamp	95-99

	NUMBER
HISTOLOGICAL STRUCTURE OF THE TEETH IN RELATION TO CAVITY	
PREPARATION	100-110
Straight enamel	100
Curled enamel	101, 102
Enamel wall preparation	103
Directions of enamel rods over different portions of crowns of the teeth	104-108
Recessional lines of the pulpal horns.....	105-107
Gingival portion of enamel.....	109
Caries enamel.....	110
CAVITY PREPARATION.....	111-292
Brief review of the injuries to the teeth by caries, in relation to cavity preparation.....	111-119
Pit and fissure cavities.....	111, 112, 113
Smooth-surface cavities	114-119
CLASS 1. PIT AND FISSURE CAVITIES.....	120-153
Instruments used in preparing.....	120, 121, 122
Small pit cavity in occlusal surface of upper first molar, and filling	123, 124
Fissured grooves in occlusal surface of upper first molar, and filling	125, 126
Salts dialyzed from saliva and crystallized.....	127
Excavation of deep occlusal cavities in molars.....	128-137
Split upper molar, with occlusal decays and cavity prepara- tion	138-141
Occlusal cavities in upper molar, cavity preparation and filling..	142 143, 144
Cavity in occlusal of lower molar, and chisel in position for beveling cavo-surface angle.....	145, 146
Buccal pit cavities in upper molars, and fillings.....	147, 148
Buccal pit cavities in lower molars, and fillings.....	149, 150
Buccal pit cavity in lower molar, and two plans of preparation	151 152, 153
CLASS 2. PROXIMAL CAVITIES IN BICUSPIDS AND MOLARS.....	154-210
Instruments used in preparing.....	154
Conditions in which narrow cavities bucco-lingually may be used	155-160
Use of the prominent contact.....	161, 162, 163

NUMBER

Secondary extension of caries gingivally and cavity outline . . .	164
Mesio-occlusal cavity in upper first molar, preparation and filling	165-169
Convenience points	170-173
Split mesio-occlusal cavity and names of internal parts . . .	174-177
Mesio-occlusal cavity in lower first molar, preparation and filling	178-181
Mesio-occlusal cavity in upper second bicuspid, preparation and filling	182-186
Methods of excavating deep mesio-occlusal cavities in molars and avoiding pulp exposure	187-196
Cross sections of proximal decays, preparations and fillings . .	197-205
Mesial cavity in molar, with narrow and wide bucco-lingual preparations and fillings	206-210
MANAGEMENT OF WEAK WALLS IN BICUSPIDS AND MOLARS	211-245
Mesio-occlusal cavity in lower molar, preparation and filling . .	211 212, 213
Occlusal cavity in lower molar with weak lingual wall, preparation and filling	214, 215, 216
Distal cavity in upper molar with weak disto-lingual angle, preparations and fillings. Use of prominent contact . .	217-226
Mesial cavity in upper first bicuspid with weak mesio-buccal angle, preparation and filling	227-232
Mesio-disto-occlusal cavities in the bicuspids when pulp is alive and when pulp is removed, preparation and filling . . .	233-245
CLASS 3. PROXIMAL CAVITIES IN INCISORS AND CUSPIDS WHICH DO NOT REQUIRE THE REMOVAL AND RESTORATION OF THE INCISAL ANGLE	246-271
Instruments used in preparing	246
Cavity in mesial surface of upper central incisor, preparation and filling	247-250
Minimum and maximum extension in incisor proximal cavities, and method of retention	251-257
Recurrence of decay about proximal fillings	258, 259, 260
Cavity in distal surface of upper lateral incisor with lingual marginal ridge undermined, preparation and filling . . .	261-264
Extensive decay in mesial surface of upper central incisor, preparation without and with removal of pulp, and filling	265-271

	NUMBER
CLASS 4. PROXIMAL CAVITIES IN INCISORS WHICH DO REQUIRE THE REMOVAL AND RESTORATION OF THE INCISAL ANGLE.	272-280
Instruments used in preparing.	272
Mesial cavity in upper central incisor, anchorage by under- cutting incisal edge, preparation and filling.	273, 274, 275
Mesial cavity in upper central incisor, anchorage by incisal step, preparation and filling.	276-280
Lamination of gold.	279, 280
CLASS 5. GINGIVAL THIRD CAVITIES IN BUCCAL AND LABIAL SUR- FACES	281-292
Instruments used in preparing.	281, 282
Gingival third cavity in buccal surface of upper first molar, preparation and filling.	283, 284, 285
Gingival third cavities in buccal surfaces of the upper bicuspids and molars, and fillings.	286, 287
Gingival third cavities in buccal surfaces of the lower bicuspids and molars, and fillings.	288, 289
Gingival third cavity in labial surface of upper central incisor, preparation and filling.	290, 291, 292
INTERPROXIMAL WEAR	293-297
ABRASION	298-310
Abrasion of bicuspids and molars.	298-302
Calcification of pulp in abrasion.	303, 304
Abrasion of upper central incisors and treatment by filling.	305-310
THE NATURE OF BLOWS AND THE RELATION OF SIZE OF PLUGGER POINTS TO FORCE AS USED IN FILLING TEETH.	311-319
Instruments used in experimental work.	311, 312
Falling weight apparatus.	313, 314
Thrust dynamometer	315
Measurements of force of blows.	316-319
Force required for plugger points of different sizes.	320-323
FILLING WITH GOLD.	324-332
Set of plugger points for cohesive gold.	324
Reverse pluggers and their uses.	325, 326, 327
Direct-acting quadrangle pluggers and their uses.	328, 329, 330
Reverse quadrangle pluggers and their uses.	331, 332

	NUMBER
UNIVERSAL PERRY SEPARATOR AND ITS APPLICATION.....	333-337
FILLING CAVITIES WITH GOLD BY CLASSES.....	338-398
CLASS 2. PROXIMAL CAVITIES IN BICUSPIDS AND MOLARS.....	338-355
Result of attempt to adapt gold by force perpendicular to cavity wall	338, 339
Building of all cohesive gold filling in mesio-occlusal cavity in upper first molar.....	340-355
Starting the filling.....	342
Covering the gingival wall.....	344, 345
Covering the cavo-surface angle.....	346, 347
Wedging principle	348
Building into the occlusal step.....	350-353
Lamination of gold.....	355
Combination of non-cohesive and cohesive gold in mesio-occlusal cavity in upper first molar.....	356-364
Lamination of gold.....	364
CLASSES 3 AND 4. PROXIMAL CAVITIES IN INCISORS AND CUSPIDS..	365-374
Cohesive gold in distal cavity in upper central incisor.....	365-374
Lamination of gold	279, 280
FINISHING GOLD FILLINGS.....	375-398
Saws and their uses.....	375-379
Finishing knives and their uses.....	380-382
Finishing files and their uses.....	383-388
Stones, disks, strips and their uses.....	389-392
Forms of proximal portion of filling and contact point.....	393-398
AMALGAM	399-418
HISTORICAL	399-407
Dr. Hitchcock's micrometer.....	399
Author's micrometer	400
Amalgam test tubes	401, 402
Test filling showing no movement.....	403
Test fillings showing shrinkage.....	404, 405
Matrix for experimental fillings.....	406, 407

	NUMBER
PRINCIPLES GOVERNING MANIPULATION OF AMALGAM.....	408-410
Mercury spoon forceps.....	408
Mercury meter	409
Set of amalgam pluggers.....	410
FILLING WITH AMALGAM	411-418
Matrices	411-414
Application of matrix.....	415, 416
Application of separator and removal of matrix.....	417, 418
EXPOSURE AND REMOVAL OF THE DENTAL PULP AND THE FILLING OF ROOT CANALS	419-447
Bicuspid split bucco-lingually, showing form of pulp chamber..	419
Central incisor split mesio-distally, with cavity exposing pulp, and enlargement of canal with fissure bur to facilitate removal of pulp.....	420, 421
Horizontal sections of upper first molars showing form of pulp chamber and root canals.....	422, 423
Lengthwise sections of upper molars showing pulp chambers and root canals.....	424-431
Horizontal sections of lower molars showing form of pulp cham- ber and root canals.....	434, 435
Lengthwise sections of lower molars showing pulp chambers and root canals.....	432-434, 436-442
Position for passing broach into canal of distal root of any lower molar	443
Incisor split labio-lingually, method of opening pulp chamber and canals through the lingual surface.....	444-447

THE TECHNICAL PROCEDURES IN FILLING TEETH.

INTRODUCTION.

UNDER the term Operative Dentistry we include all those operations upon the natural teeth and soft parts immediately connected with them that are usually performed by the dentist. But for convenience in teaching, and by common consent, certain operations are consigned to other departments. The extraction of teeth belongs to Oral Surgery; the preparation of natural teeth, or their roots, for crowns and bridges, belongs to crown and bridge work; the regulation of irregular teeth to Orthodontia, etc., until to-day operative dentistry is pretty strictly confined to those operations upon the natural teeth and soft parts immediately connected with them for the repair of damage inflicted by caries, to prevent further caries, and the treatment of diseases resulting from exposure or death of the pulps of the teeth. To this is added that group of diseases of the periodental membrane beginning at the gingival border.

In this book only the hard tissues of the teeth will be considered, further than some mention of diseases of the dental pulp and the periodental membrane that interfere with operations on the hard structures. All diseases of the soft structures connected with the teeth are consigned to dental pathology and therapeutics, to be considered separately.

The subject matter in this volume will be confined to a presentation of the technical procedures in filling teeth. No study of pathological conditions will be undertaken; not even of dental caries, further than a study of the position and forms of cavities and such observations as may be necessary in the explanation of the relation of technical procedures in the preparation of cavities and in filling teeth to the prevention and cure of disease. The nomenclature relating to cavities and cavity preparation, instruments and instrumentation, will be fully presented.

NOMENCLATURE.

NOMENCLATURE treats of systems of naming things. Dental nomenclature treats of the terms, or names, used in dentistry. The subject is of first importance, for, if we do not know the names by which things are called, we will be unable to understand each other in speaking of them. Every profession, business or trade, has its special system of naming things pertaining to it, and this nomenclature must be understood before the student can become proficient. In operative dentistry this system of nomenclature is very simple and comprises but few words. However, these words are used in a fairly wide range of combinations that will be very perplexing to the student who has not a good knowledge of them. He should understand them when spoken by others and be able to use them freely and correctly in his ordinary speech. Otherwise he will be unable to understand his professors or fellow students as accurately as he should, and thus find his studies more difficult than they otherwise would be.

For the most part, the words are the same as those used in Dental Anatomy, with which the student and every dentist should be already familiar. But they are applied differently and to different subjects. This new use now becomes a subject of study as applied in cavity preparation and cavity nomenclature.

Cavity preparation includes all those operations required in the removal of carious material from cavities formed in the teeth by decay, forming the cavities for the reception of fillings, and such extensions and preparations as will best fit the affected surfaces of the teeth to resist decay in future.

CAVITY NOMENCLATURE.

ILLUSTRATIONS: FIGURES 1-14.

RULE: *Cavities in the teeth take the names of the surfaces of the teeth in which they occur.*

We group cavities together according as the decayed surfaces are similarly situated. A further grouping may also be made into classes, each class including those cavities that require similar treatment.

Cavities occurring in the occlusal surfaces of the teeth are called occlusal cavities. They occur in the molars and bicuspid, constituting a group.

Cavities occurring in the buccal surfaces of the bicuspid and molars are called buccal cavities, and constitute a group.

Cavities occurring in the lingual surfaces of the bicuspid and molars are called lingual cavities. They are not frequent.

Cavities occurring in the proximal surfaces of the teeth are called proximal cavities. These are divided into two groups: those occurring in the bicuspid and molars forming one group, bicuspid and molar proximal cavities; and those occurring in the incisors and cuspids forming a separate group, incisor proximal cavities. The forms of the proximal surfaces of these two groups of teeth are so different as to require differences in consideration and treatment. Each of these groups is again subdivided into mesial cavities and distal cavities. Mesial cavities are those that are in surfaces of the teeth toward the median line as we follow the curve of the arch. The median line is the central line of the face, the head, or of the whole body, from before backward, perpendicularly. Distal cavities are those that are in the surfaces of the teeth farthest from the median line, following the curve of the arch.

Cavities occurring in the lingual surfaces of the upper incisors are considered as a separate group, incisor lingual cavities.

Cavities occurring in the labial surfaces of the incisors and cuspids are called labial cavities.

When a cavity involves two or more surfaces of a tooth, either by the extension of decay or by cutting in its preparation, a complex cavity is formed. Complex cavities are named by combining the names of the surfaces of the tooth involved by the cavity: as mesio-occlusal cavity; mesio-occluso-distal cavity, etc.

In each of these groups the individual cavity name is rendered specific by adding the name of the tooth in which it occurs, as: Occlusal cavity in the left upper first molar, mesial cavity in the right upper central incisor, etc. We use proximal cavity or cavities only as a general term, always using mesial or distal when speaking of a particular proximal cavity.

In addition to these terms, all cavities which occur in the axial surfaces of the teeth are called axial surface cavities. An axial surface of a tooth is one, the general plane of which is parallel with the long axis of the tooth. These include all buccal, or labial, lingual and proximal cavities.

In each of these localities decay has peculiarities in its mode of attack, or there are differences of approach and of instrumentation in the preparation for filling and in the insertion of fillings, that render differences in their consideration necessary.

Cavities are also divided into two groups; pit and fissure cavities forming one group, and smooth-surface cavities forming a second group. This constitutes a most important division of cavities, calling for a radical distinction in consideration and treatment.

PIT AND FISSURE CAVITIES have their beginning in minute faults in the enamel of the teeth. Pits are formed where three or more lobes of the teeth join, because of imperfect closure of the enamel plates, as upon occlusal surfaces of the bicuspid and molars and the lingual surfaces of the incisors, or at the endings of grooves, as upon the buccal surfaces of the molars. Fissure cavities occur where there is imperfect closure of the enamel plates along the lines of the grooves. These latter may occur along the lines of the grooves of any of the teeth, but are seen mostly in the occlusal surfaces of the bicuspids and molars.

SMOOTH-SURFACE CAVITIES are those formed by decay beginning in surfaces of the teeth that are without pits, fissures, or faults of the enamel, i. e., in perfectly smooth surfaces. These positions are all on the axial surfaces and in such positions that the surfaces are habitually unclean, either because of the position in relation to the motions of food in chewing or the proximation of the surfaces of other teeth, as upon the proximal surfaces. Decay is the result of fermentation in these positions with the formation of an acid which dissolves the calcium salts of the teeth.

Among the groups of cavities, all of the occlusal cavities in the bicuspids and molars are, in their beginning, pit or fissure cavities. A part of the buccal cavities in the molars are pit or fissure cavities occurring in the buccal pits or fissured grooves, and part are smooth-surface cavities, occurring in the smooth portion of the enamel of this surface to the gingival of the pit, or in the gingival third of the buccal surface. All buccal cavities in the bicuspids are smooth-surface cavities. All labial cavities in the incisors and cuspids are smooth-surface cavities. All lingual cavities in the upper incisors are pit or fissure cavities. A few fissure cavities occur in the occlusal half of the lingual surfaces of the molars. All proximal, or mesial and distal cavities, whether in the molars, bicuspids or incisors, are smooth-



FIG. 1.

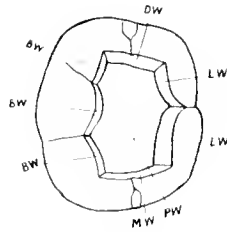

FIG. 2.

FIG. 1. A lower first molar with a prepared cavity in the occlusal surface.

FIG. 2. Diagram for explanation and naming of cavity walls in Figure 1. m w. Mesial wall. b w, B w, b w. Buccal wall. d w. Distal wall. l w, L w. Lingual wall. p w. Pulpal wall. If the contour of a wall is broken by the cutting out of grooves or other necessary deviation of form, as occurs in the buccal wall in this case, the wall is named as a whole, the same as if the form were regular.



FIG. 3.

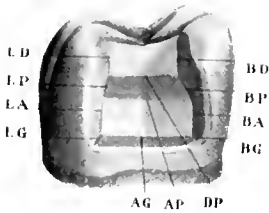

FIG. 4.



FIG. 5.

FIG. 3. Illustration of the naming of the walls in proximo-occlusal cavities, a mesio-occlusal cavity. LW, Lingual wall. GW, Gingival wall. DW, Distal wall. BW, Buccal wall. PW, Pulpal wall. AW, Axial wall. In the text these walls are given separately for the proximal portion and for the occlusal, or step portion. With this division, the buccal wall and the lingual wall are each given twice, because these walls belong to both portions of the cavity.

FIG. 4. Line angles of a mesio-occlusal cavity. See rules for naming cavity angles. LD, Linguo-distal angle. LP, Linguo-pulpal angle. LA, Linguo-axial angle. LG, Linguo-gingival angle. BD, Bucco-distal angle. BP, Bucco-pulpal angle. BA, Bucco-axial angle. BG, Bucco-gingival angle. AG, Axio-gingival angle. AP, Axio-pulpal angle. DP, Disto-pulpal angle. In the text the line angles are divided into the first and second sets for the proximal portion and the first and second sets for the occlusal, or step portion; in each case the line angles which run from the enamel margin to the pulpal wall or to the axial wall constitute the first set, and those which form the boundaries of the pulpal wall or of the axial wall constitute the second set.

FIG. 5. Point angles of a mesio-occlusal cavity. DLP, Disto-linguo-pulpal angle. PLA, Pulpo-linguo-axial angle. GLA, Gingivo-linguo-axial angle. DBP, Disto-bucco-pulpal angle. PBA, Pulpo-bucco-axial angle. GBA, Gingivo-bucco-axial angle. In the text the point angles are given separately for the proximal portion and the step portion of the cavity.

surface cavities. Lingual cavities in the gingival half of the molars are also smooth-surface cavities.

Pit and fissure cavities occur in surfaces of the teeth that are habitually clean, except as the imperfections of the enamel — pits and fissures — afford places for the lodgment and fermentation of debris, which causes the beginning of decay. Therefore, in their preparation for filling, they require no extension for prevention of recurrence of decay, further than a sufficient opening of the cavity to completely uncover the carious area and to find margins sufficiently level and smooth, i. e., free from grooves, to allow of a good finish of the margins of the filling to be made.

Smooth-surface cavities occur in positions in which the surface of the enamel is habitually unclean, and usually begin in the central portion of the unclean area. The injury to the enamel surface tends to spread superficially from the central area of first beginning toward the margins of the unclean area. Therefore, such cavities require such extension in their preparation for filling as will include the habitually unclean area within their outline in order to prevent the recurrence of caries.

CLASSIFICATION OF CAVITIES INTO ARTIFICIAL GROUPS.

In a classification of cavities, it is the intention to group together in classes cavities of decay that require a similar line of treatment, in order that these may be more closely associated.

CLASS 1. Cavities beginning in structural defects in the teeth; pits and fissures. These are located in the occlusal surfaces of the bicuspid and molars, in the occlusal two-thirds of the buccal surfaces of the molars, in the lingual surfaces of the upper incisors, and occasionally in the lingual surfaces of the upper molars.

CLASS 2. Cavities in the proximal surfaces of the bicuspid and molars.

CLASS 3. Cavities in the proximal surfaces of the incisors and cuspids which do not involve the removal and restoration of the incisal angle.

CLASS 4. Cavities in the proximal surfaces of the incisors which do require the removal and restoration of the incisal angle.

CLASS 5. Cavities in the gingival third — not pit cavities — of the labial, buccal or lingual surfaces of the teeth.

Classes 2, 3, 4 and 5 are all smooth-surface cavities. They

all occur in positions in which the surfaces of the teeth are habitually unclean.

With respect to manipulative procedures, each of these classes has its especial peculiarities. For instance, Class 5, which includes all buccal, labial and lingual cavities, requires, in most cases, the use of the Hatch clamp on the incisors and bicuspid, and the special clamps on the molars to extend the rubber dam sufficiently to the gingival, and the method of the instrumentation in their preparation is peculiar to them. Classes 2, 3 and 4 all agree in requiring the use of the separator to give room for finishing, because all are proximal cavities, but each of these classes presents especial peculiarities in manipulative procedure, which will receive attention later.

NOMENCLATURE OF THE INTERNAL PARTS OF CAVITIES.

In giving the nomenclature of the internal parts of cavities, the rules and illustrations of each rule will be given. Students should not burden themselves with memorizing these illustrations, or lists, for, if they know the rules and their application, they can make complete lists at any time. This should be practiced until the walls and angles of any cavity can be named at sight without hesitation.

WALLS OF CAVITIES.

RULE: *The surrounding walls of a cavity take the names of those surfaces of the teeth adjoining the surface decayed, toward which they are placed.*

Illustration: Occlusal cavities, Figures 1, 2, have —

A mesial wall, M. w.

A buccal wall, B. w.

A distal wall, D. w.

A lingual wall, L. w.

And —

A fifth wall, which is called the pulpal wall, P. w.

RULE: *That wall of a cavity which is to the occlusal of the pulp, and in a plane at right angles to the long axis of the tooth, is called the pulpal wall. In case the pulp of the tooth is removed, and the cavity thus extended to the floor of the pulp chamber, it is called the sub-pulpal wall.*

Illustration: Buccal and lingual cavities have —

A mesial wall,

An occlusal wall,
 A distal wall,
 A gingival wall,

And —

A fifth wall, called the axial wall.

RULE: That wall of a cavity in an axial surface of a tooth that covers the pulp is called the axial wall. If the pulp of the tooth is removed, the cavity is extended to include the pulp chamber, the wall takes the name of the wall of the pulp chamber.

Simple mesial or distal cavities (proximal cavities), in the bicuspid and molars, have —

A lingual wall,
 A buccal wall,
 A gingival wall,
 An occlusal wall,

And —

An axial wall.

But mesial and distal cavities, as usually prepared in bicuspid and molars, become mesio-occlusal or disto-occlusal cavities (complex cavities); the occlusal wall is missing and a step is cut in the occlusal surface.

RULE: When one of the surrounding walls of a cavity is missing by reason of extension of decay, or by extension by cutting in the preparation for filling, so as to involve another surface of the tooth, a complex cavity is formed and the remaining walls extend to the new surface involved. A complex cavity is named by combining the names of the surfaces involved, as mesio-occlusal cavity.

Therefore, when a mesial or a distal cavity in a bicuspid or molar has involved the occlusal surface, the buccal and the lingual walls will terminate at the occlusal enamel margin. The axial wall will also extend to the occlusal enamel margin if no step has been formed, and the occlusal wall will be missing. When a step has been formed, its walls will be named as in a simple occlusal cavity, except that that wall toward the cavity from which the step is formed will be missing.

Therefore, mesio-occlusal (or disto-occlusal) cavities, Figure 3 (see also Figures 6, 7), in the bicuspid and molars have —

In the proximal portion:

A gingival wall, G. W.
 A buccal wall, B. W.
 A lingual wall, L. W.

And —

An axial wall, A. w.

In the step portion:

A distal (or mesial) wall, D. w.

A buccal wall, B. w.

A lingual wall, L. w.

And —

A pulpal wall, P. w.

Notice that in mesial cavities, the mesial wall of the step portion will be missing, and in distal cavities the distal wall of the step portion will be missing.

In a mesio- or disto-occlusal cavity in a bicuspid or molar in which the pulp is removed, the pulpal and axial walls are removed. The floor of the pulp chamber becomes the sub-pulpal wall of the cavity. This is usually distinct from the gingival wall, because it is on a different level. Therefore, a mesio- or disto-occlusal cavity in a molar or bicuspid with pulp removed, has —

A buccal wall,

A lingual wall,

A gingival wall,

A distal (or mesial) wall,

And —

A sub-pulpal wall.

Also some portions of the mesial (or distal) wall of the pulp chamber will remain next to the gingival wall as a mesial (or distal) wall. In a bicuspid or molar with a single broad pulp canal, there is no sub-pulpal wall.

Proximal cavities in the incisors and cuspids, on account of the wedgelike or triangular form of these surfaces, have but three surrounding walls:

A labial wall,

A lingual wall,

A gingival wall,

And —

An axial wall.

When, in incisor or cuspid proximal cavities, the incisal angle becomes involved so that its removal is required, a complex cavity is formed by cutting an incisal step. There is in this case no change in the naming of the walls of the proximal portion of the cavity, as no one of the walls named has been completely removed. Such a cavity will have —

In the proximal portion:

A lingual wall,
 A labial wall,
 A gingival wall,

And —

An axial wall.

In the step portion:

A labial wall,
 A lingual wall,
 A mesial (or distal) wall,

And —

A pulpal wall.

Labial and lingual cavities in the incisors and cuspids have —

A mesial wall,
 A distal wall,
 A gingival wall,
 An incisal wall,

And —

An axial wall.

ANGLES OF CAVITIES.

In naming cavity walls and angles, the typical idea of the cavity is that of a cuboid space, or the form of a box. No matter how irregular the actual form of the cavity, its walls and angles are named as if the form were regular.

Each simple cavity has two sets of line angles and one set of point angles.

RULE: All line angles are formed by the junction of two walls along a line, and are named by combining the names of the walls joining to form the angle. They are, therefore, named in two terms.

RULE: All point angles are formed by the junction of three walls at a point, and are named by joining the names of the walls forming the angle. They are, therefore, named in three terms.

In simple cavities one set of line angles is formed by the junction of the four surrounding walls with each other, forming lines which run from the enamel margin to the pulpal wall in occlusal cavities, or to the axial wall in axial cavities. A second set of line angles is formed by the junction of the surrounding walls with the pulpal wall in occlusal cavities, or with the axial wall in cavities in the axial surfaces of the teeth.

The point angles are formed where the line angles of one set meet the other set at the angles of the cavity. The broader rule for naming angles, to which there is but a single exception, is:

RULE: *All angles of cavities are named by combining the names of the walls joining to form the angle. The particular order in which these are named is not important. Linguo-distal angle and disto-lingual angle mean the same thing.*

Illustrations: (Each angle named is formed by the junction of the walls, the names of which enter into the name of the angle.)

Occlusal cavities have —

First set of line angles:

- A mesio-buccal angle,
- A mesio-lingual angle,
- A disto-buccal angle,
- A disto-lingual angle.

Second set of line angles:

- A bucco-pulpal angle,
- A linguo-pulpal angle,
- A mesio-pulpal angle,
- A disto-pulpal angle.

Point angles:

- A mesio-bucco-pulpal angle,
- A disto-bucco-pulpal angle,
- A mesio-linguo-pulpal angle,
- A disto-linguo-pulpal angle.

In case the pulp is removed, the pulpal wall is removed and the floor of the pulp chamber becomes the sub-pulpal wall of the cavity, and the pulpal angles become sub-pulpal angles.

A buccal or a lingual cavity in molars or bicuspid has —

First set of line angles:

- A mesio-gingival angle,
- A disto-gingival angle,
- A mesio-occlusal angle,
- A disto-occlusal angle.

Second set of line angles:

- An axio-gingival angle,
- An axio-mesial angle,
- An axio-occlusal angle,
- An axio-distal angle.

Point angles:

- An axio-mesio-gingival angle,
- An axio-mesio-occlusal angle,
- An axio-disto-occlusal angle,
- An axio-disto-gingival angle.

A simple mesial or distal cavity in a bicuspid or molar has —



FIG. 6.

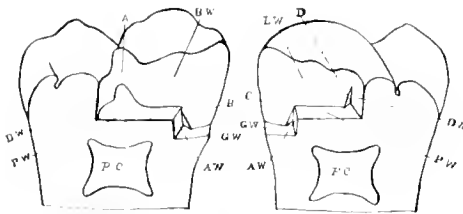

FIG. 7.

FIG. 6. An upper first molar with a prepared mesio-occlusal cavity, split mesio-distally, displaying the cavity form. The buccal half is on the left and the lingual half on the right side. The mesial surfaces of the two halves are next each other. The dotted lines rounding from these show the form of the mesial surface of the filling if it were placed.

FIG. 7. An outline view of the cavity shown in Figure 6 for a further study of the internal parts. D.W., Distal wall. P.W., Pulpal wall. G.W., Gingival wall. A.W., Axial wall. B.W., Buccal wall. L.W., Lingual wall. P.C., Pulp chamber. A, Acute angle formed by cutting out the buccal groove. B, Convenience point cut in the disto-linguo-pulpal angle. C, Convenience point cut in the bucco-axio-lingual angle. D, Convenience point cut in the linguo-axio-lingual angle.

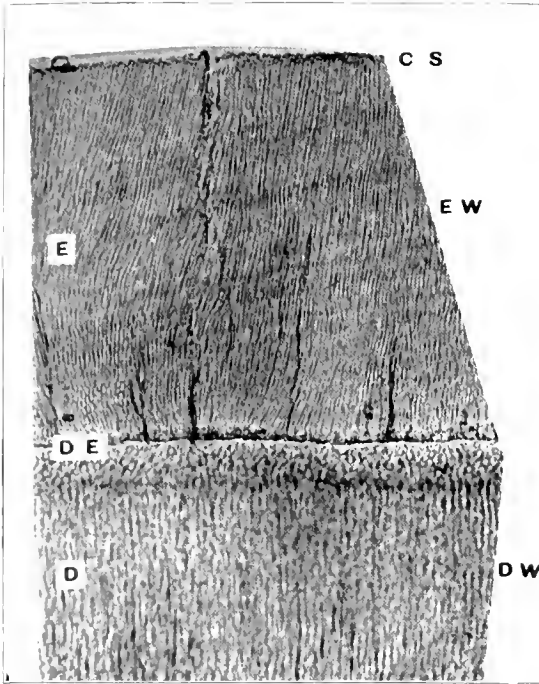

FIG. 8.

FIG. 8. A portion cut from a photomicrograph of a section of a tooth showing: E, Enamel; D, Dentin; DE, Dento-enamel junction; DW, Dentin wall; EW, Enamel wall; CS, Cavo-surface angle. A dentin wall and an enamel wall may be continuous on the same plane as the cut on the left-hand side of the figure; or, the dentin wall and the enamel wall may be cut on different planes as on the right hand side of the figure.

First set of line angles :

A linguo-gingival angle,

A bucco-gingival angle,

A linguo-occlusal angle,

A bucco-occlusal angle.

Second set of line angles:

An axio-lingual angle,

An axio-occlusal angle,

An axio-buccal angle,

An axio-gingival angle.

Point angles:

An axio-linguo-gingival angle,

An axio-bucco-gingival angle,

An axio-linguo-occlusal angle,

An axio-bucco-occlusal angle.

But in mesial and distal cavities in the bicuspids and molars as prepared for filling, the occlusal wall is generally cut away and a step formed in the occlusal surface, forming a complex cavity. In this case, the occlusal wall is missing and all of the angles formed by the junction of this wall with others are also missing. Then the step in the occlusal surface has its angles the same as in a simple occlusal cavity, except that the angles pertaining to the missing wall, mesial or distal, are also missing. This is a universal rule with complex cavities. Line angles are shown in Figure 4. Point angles are shown in Figure 5. See also Figures 6, 7.

Hence a mesio- or disto-occlusal cavity has —

In the mesial or distal portion:

First set of line angles:

A bucco-gingival angle, B. G.

A linguo-gingival angle, L. G.

Second set of line angles:

A bucco-axial angle, B. A.

A linguo-axial angle, L. A.

A gingivo-axial angle, G. A.

Point angles:

A gingivo-bucco-axial angle, G. B. A.

A gingivo-linguo-axial angle, G. L. A.

In the step portion:

First set of line angles:

A bucco-distal (or mesial) angle, B. D.

A linguo-distal (or mesial) angle, L. D.

Second set of line angles:

A disto- (or mesio-) pulpal angle, D. P.

A linguo-pulpal angle, L. P.

A bucco-pulpal angle, B. P.

Point angles:

A disto- (or mesio-) bucco-pulpal angle, D. B. P.

A disto- (or mesio-) linguo-pulpal angle, D. L. P.

And a line angle formed by the junction of the axial and pulpal walls.

An axio-pulpal angle, A. P.

And two point angles, formed by the junction of the pulpal and axial walls with the lingual wall and with the buccal wall.

A pulpo-linguo-axial angle, P. L. A.

A pulpo-bucco-axial angle, P. B. A.

The rule illustrated in the above is universal. A buccal cavity with an oclusal step, or united with an oclusal cavity, would also have its pulpo-axial angle. The angles belonging to the oclusal wall of the buccal cavity would be missing, and the angles belonging to the buccal wall of the oclusal cavity would also be missing. This, however, makes no difference whatever with the naming of the remaining angles. If, however, the pulp of the tooth is removed, removing the axial and pulpal walls, the angles formed by the junction of these walls with the other walls are also removed, and the angles of the pulp chamber (sub-pulpal angles) substituted.

Labial or lingual cavities in the incisors and cuspids have —

First set of line angles:

A mesio-gingival angle,

A disto-gingival angle,

A mesio-incisal angle,

A disto-incisal angle.

Second set of line angles:

An axio-gingival angle,

An axio-mesial angle,

An axio-distal angle,

An axio-incisal angle.

Point angles:

An axio-mesio-gingival angle,

An axio-disto-gingival angle,

An axio-mesio-incisal angle,

An axio-disto-incisal angle.

Mesial and distal cavities in the incisors and cuspids have,

on account of their triangular form, but three angles instead of four. They have—

First set of line angles:

- A labio-gingival angle,
- A linguo-gingival angle,
- *An incisal angle.

Second set of line angles:

- An axio-labial angle,
- An axio-lingual angle,
- An axio-gingival angle.

Point angles:

- An axio-labio-gingival angle,
- An axio-linguo-gingival angle,
- *An axio-incisal angle.

In mesial and distal cavities in the incisors and cuspids involving the loss of the incisal angle of the tooth, the incisal angle and the axio-incisal angle will be missing and the incisal step when formed will have its set of angles. These are—

First set of line angles:

- A mesio- (or disto-) labial angle,
- A mesio- (or disto-) lingual angle.

Second set of line angles:

- A pulpo-distal (or mesial) angle,
- A pulpo-lingual angle,
- A pulpo-labial angle,
- A pulpo-axial angle.

Point angles:

- A mesio- (or disto-) labio-pulpal angle,
- A mesio- (or disto-) linguo-pulpal angle.

While all angles are theoretically and actually present as named and according to the rules given and illustrated, these incisal steps are so narrow that it would rarely be desirable to name the point angles in any directions for cavity preparation or in cavity description.

These lists of cavity angles may seem long and tedious, but it must be remembered that in any directions for the preparation of cavities, or in cavity descriptions, very few of them

* NOTE.—The incisal angle given here is the one exception to the rule of naming cavity angles. If the rule were followed strictly, it would be the labio-lingual line angle, for it is formed by the junction of the labial and lingual walls. In like manner the axio-incisal point angle would be the axio-labio-lingual angle. This latter is formed by the junction of the labial, lingual and axial walls, but is never called by the compound name formed by these words. The name, incisal angle, is distinctive and gives rise to no confusion.

need to be mentioned. However, the student should be able to understand just what is meant when any one of them is mentioned, or be able to name any of them in any cavity. This he will not do by memorizing lists that are given, but by so learning the application of the rules as to be able to correctly apply a name to any angle of any cavity.

NOMENCLATURE OF ENAMEL MARGINS.

The enamel margin includes the whole outline of the cavity and is equivalent to the marginal lines of the cavity. In this sense the enamel margin marks the outlines of the cavity.

THE CAVO-SURFACE ANGLE of a cavity, or of the enamel, is the angle formed by the junction of the wall of the cavity with the surface of the tooth. Figure 8, c. s. The cavo-surface angle of a cavity will ordinarily be of enamel; under some unusual conditions it may be of dentin; or, in cavities that extend beyond the gingival line, the cavo-surface angle will be of cementum. The term cavo-surface angle is used especially when it is desired to indicate the form to be given this angle in any particular portion of the enamel margin, or outline of a cavity; as, the buccal cavo-surface angle is to be beveled.

THE DENTO-ENAMEL JUNCTION is the line of junction of the dentin and enamel as it appears in the walls of cavities. Figure 8, d. e.

THE ENAMEL WALL is that portion of the wall of a cavity which consists of enamel. e. w. It includes the thickness of the enamel from the dento-enamel junction to the cavo-surface angle.

THE DENTIN WALL is that portion of the wall of a cavity which consists of dentin. d. w.

The dentin wall of a cavity and the enamel wall may be on the same inclination and continuous as on the left hand of Figure 8, supposing that to be the wall of a cavity. Or the dentin wall may be on one inclination and the enamel wall on another, as shown by d. w. for the dentin wall and e. w. for the enamel wall, supposing these to constitute the cavity wall.

THE PLANES OF THE TEETH AND THE INCLINATION OF CAVITY WALLS.

The teeth have three planes which may frequently be used to advantage in cavity description, and especially in speaking of the inclination of cavity walls.

THE HORIZONTAL PLANE, Figure 9, is at right angles to the



FIG. 9.



FIG. 10.



FIG. 11.

FIG. 9. An upper molar tooth cut in the horizontal plane.
FIG. 10. An upper molar tooth cut in the axio-mesio-distal plane.
FIG. 11. An upper molar tooth cut in the axio-bucco-lingual plane.

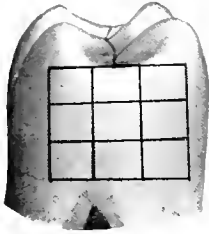

FIG. 12.

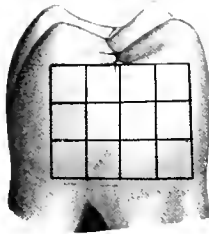

FIG. 13.

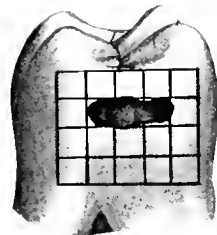

FIG. 14.

- FIG. 12. A surface of a tooth divided into thirds.
- FIG. 13. A surface of a tooth divided into thirds occluso-gingivally and into fourths bucco-lingually.
- FIG. 14. A surface of a tooth divided into fifths bucco-lingually and into fourths occluso-gingivally. A cavity in this surface occupies the middle three fifths bucco-lingually of the second fourth occluso-gingivally.

long axis of the tooth and may be supposed to cut through the crown at any point in its length.

THE AXIO-MESIO-DISTAL PLANE, or the mesio-distal plane, Figure 10, passes through the tooth mesio-distally parallel with its long axis.

THE AXIO-BUCCO-LINGUAL PLANE, or the bucco-lingual plane, Figure 11, passes through the tooth bucco-lingually parallel with its long axis. In the incisors and cuspids this is the labio-lingual plane.

The inclination at which walls of cavities are cut, or of the dentin wall and the enamel wall, when each is specifically mentioned, is reckoned from these planes of the teeth. When great accuracy of statement is desired, the inclination may be given in centigrades. More generally the term, outward inclination, or inclined outward, is used, with some word expressing degree, as slightly, strongly, etc. In this use of words the wall of the cavity mentioned is always inclined away from the plane of the tooth in passing from within outward. The enamel wall and the dentin wall of any given part of a cavity may be on different inclinations; for instance, the lingual dentin wall of a mesial cavity in a first molar tooth may be cut in the mesio-distal plane and the enamel wall inclined outward five or six centigrades, as shown in Figure 8. This will make a slight angle at the dento-enamel junction.

The bevel of the cavo-surface angle is always reckoned from the plane of the enamel wall.

THE USE OF DIVISIONS OF THE SURFACES OF THE TEETH IN CAVITY DESCRIPTION.

Whenever we wish to indicate in words the portion of a surface of a tooth involved in decay, or the extent of a cavity, we may conveniently do so by an imaginary division of the surface into thirds, fourths or fifths. This division may be mesio-distally upon a buccal, lingual, or occlusal surface, or ocluso-gingivally upon a buccal, lingual, mesial or distal surface, or it may be bucco-lingually upon an occlusal, mesial or distal surface. In other words, the divisions may be made upon any one of the planes of the tooth. Figures 12, 13, 14.

For instance, of a cavity in a buccal surface, we may say it involves the middle third mesio-distally of the gingival third ocluso-gingivally. Or, if the cavity is broader, we may say it involves the middle three-fifths bucco-lingually of the second fourth of the surface ocluso-gingivally, as in Figure 14.

In this use of words, it must be borne in mind that when the adverbial form is used, it indicates direction. Mesio-distally means from mesial to the distal. Bucco-lingually means from the cheek toward the tongue, etc. This use of words is so simple that it should only require mention to be perfectly understood. Surgeons continually use this plan in speaking of the location of fractures of the bones. As, for instance, the humerus was broken at the junction of the middle and upper thirds, or the radius was broken in the middle of the lower third, etc. There is no need of any specific rules for this use of words in dividing the surfaces of the teeth in cavity descriptions, as any divisions intelligently made will be readily understood, and the portions of the surface involved quite accurately described. If it is said that a cavity in the mesial surface of a first lower molar extends from the occlusal surface to the junction of the gingival and middle thirds, and bucco-lingually from the mesio-buccal angle to the junction of the middle and lingual thirds, it should be understood. The same conception of the cavity should be obtained if it is said that it occupies the buccal two-thirds bucco-lingually, or that it occupies the buccal and middle thirds. There is scarcely any limit to the use that may be made in cavity descriptions of these divisions of the surfaces of the teeth.

CUTTING INSTRUMENTS.

ILLUSTRATIONS: FIGURES 15-24.

IN the past the want of some recognized scheme of nomenclature and classification of dental operating instruments which would individualize the instruments of the several orders and classes has been a great bar to progress in teaching instrumentation. This has been felt by all who have labored for exactness in their operations, or have endeavored to express the manner of their performance in writing, or to speak of the instruments used. A teacher had no means of telling his students just what particular instrument he would use in performing a specific act in excavating a given cavity. So long as the writer or speaker is without this means of communication, students in school, dentists in societies, or readers of the literature, will be unable to know just what is meant, and any description of cavity preparation will be confusing and without the force of exactness. That which is needed is a strict classification of the useful forms of excavators, pluggers, etc., and a nomenclature that will designate each individual form.

Students need in the beginning of school work a close drill in the appreciation of the forms, particularly of cutting instruments, which will enable them to discover the peculiarities of each with exactness, as to width, length and angle of blade and the proportions of the several parts. If this be coupled with a close drill in the uses and observation of the capabilities of each of the several classes of forms, an impression will be made upon the mind and a skill acquired by the hand that will be a great aid in the development of manipulative ability. Such a nomenclature has now had sufficient trial and is found adapted to the naming of all manner of cutting instruments and pluggers.

INSTRUMENT NOMENCLATURE.

NAMES OF PARTS. Each excavator is composed of a shaft, which is used as a handle, a shank and a blade. Usually in excavators, the shaft is perfectly straight and without variation in size. The *shank* begins with the first turned part and connects the shaft with the blade or working point. It usually tapers

from its connection with the shaft to where the blade begins. The *blade* is the part bearing a cutting edge. It begins at the angle which terminates the shank — the last one, if there are two or more — and terminates in a cutting edge.

Pluggers have no cutting edge. The part corresponding with the blade in excavators terminates in a blunt point called the *nib*, or simply the point. The end of this nib is called the *face* of the plugger, and is usually finely serrated or roughened to prevent slipping. The face itself may be flat or rounded. The form of the face may be round, square, or a parallelogram.

NAMES OF OPERATING INSTRUMENTS.

Each of the names applied to instruments has a meaning. They are descriptive of their uses, as excavator, plugger, separator; or the manner of use, as hand plugger. They describe the forms of blades of cutting instruments, as hatchet, hoe, spoon; or they describe the form of the shank, as contra-angle, binangle, etc.

Note especially that there are four classes of names. First, those which denote the purpose, are order names, as plugger, excavator; second, those which denote position or manner of use, sub-order names, as hand or mallet plugger, enamel hatchet; third, those which describe the form of point, class names, as hatchet, spoon; and fourth, those which describe the form of shank, sub-class names, as binangle, contra-angle, bayonet, etc.

These names are classified as follows:

- Order names,
- Sub-order names,
- Class names,
- Sub-class names.

ORDER NAMES denote purpose and answer the question, "what for?"

- Examples: Excavators,
Pluggers,
Separators,
Scalers,
Clamps, etc.

SUB-ORDER NAMES denote the manner or position of use, and answer the question, "where or how used?" and are usually a prefix to an order name.

- Examples: Hand mallet,
Hand plugger,
Mallet plugger,

Enamel hatchet,
 Push scaler,
 Pull scaler,
 Molar clamp, etc.

CLASS NAMES are descriptive of the working point of the instrument.

Examples: Hatchet, see Figure 22.
 Hoc, " " 22.
 Spoon, " " 22.
 Discoid, " " 23.
 Cleoid, " " 23.
 Serrated plugger,
 Smooth plugger, etc.

These are also used as prefixes to order names, as in the last two; and also as in hatchet excavator, hoe excavator, etc.

SUB-CLASS NAMES describe the shape of the shank of the instrument.

Examples: Mon-angle,
 Binangle,
 Triple-angle,
 Quadrangle,
 Contra-angle,
 Bayonet, etc.

These names are often combined for more complete descriptions of the instruments named, thus: Mon-angle excavator, or, mon-angle hatchet excavator, binangle spoon excavator, contra-angled enamel hatchet, etc. In these combinations each name is descriptive of some part of the instrument or of its uses. In general, however, those descriptive of the shank are omitted.

Order names and sub-order names are sufficiently defined above, but class names and sub-class names need further definition and description.

CLASS NAMES OF EXCAVATORS.

ILLUSTRATIONS: FIGURES 22-23.

HATCHET. The shank has one or more angles or curves, the last length forming the blade, the flat sides of which are in the plane of the angle or angles, or, if the blade were at an angle of 25 centigrades with the shaft, the cutting edge would be parallel with the shaft.

HOE. The shank has one or more angles, the last length forming the blade, the flat sides of which are in a plane inter-

secting at right angles the plane of the angle or angles, or is at right angles with the shaft.

CHISEL. Straight blade with cutting edge formed by beveling from one side. The blade is usually straight with the shaft, but may be slightly curved.

BINANGLE CHISEL. A chisel blade placed at a slight angle with the shaft in the hoe form. They are contra-angled.

ENAMEL HATCHETS. Chisel blades placed in hatchet form by the direction of the angles of the shank. They are made rights and lefts by the bevel of the cutting edge being placed on opposite sides of the blades to constitute the pair. They are intended to assist the chisels in chipping away overhanging enamel and other work in the preparation of cavities.

SPOONS. The spoons are always made in pairs. They are first made in the form of enamel hatchets and then the blade of the one is curved to the right and the blade of the other is curved to the left, then the cutting edge is ground to a semi-circle and sharpened to a thin edge. This curve of the blade is in a plane that intersects at right angles the plane of the principal angle or angles. This direction of the curve of the blades makes the instruments true rights and lefts, i. e., lateral cutting instruments.

GINGIVAL MARGIN TRIMMERS. These instruments are formed like the spoons both as to the curves of the blades and the dimensions, but the angle of the cutting edges of one pair is arranged for beveling of the cavo-surface angle of the gingival wall of a mesial cavity, and the angle of the cutting edge of another pair is arranged for beveling the cavo-surface angle of the gingival wall of a distal cavity. For this work the cutting edge is ground in a bevel instead of being ground to a thin edge as in the spoons. They have no other use.

DISCOID (Disc-like, circular). The blade is circular in form, having a cutting edge extending around the whole periphery, except that portion by which it is joined to the shank. This circular blade is placed at more or less of an angle with the shaft.

CLEOID (Claw-like, in the form of a claw). Sharp pointed blades in the form of a claw, with cutting edges on two sides of the blade.

SUB-CLASS NAMES.

A sub-class name is one applied to, and is descriptive of the angles and curves of the shank of an instrument which leads to the blade or working point.

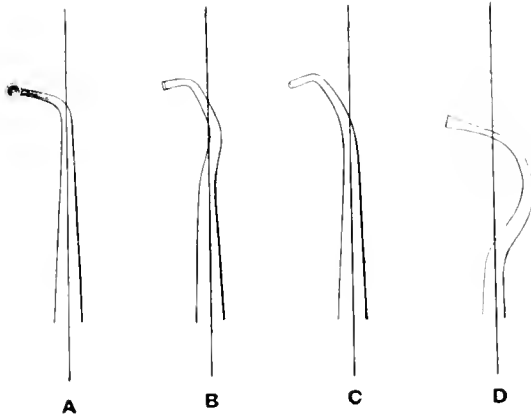

FIG. 15.

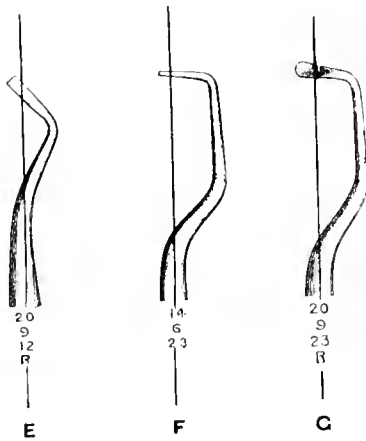

FIG. 16.

FIG. 15. Instruments wrongly contra-angled. Their points are so far from the line of the central axis of the shaft, as shown by the line, that they incline to twist, or turn, in the fingers when the effort is made to cut with them. They are out of balance.

FIG. 16. Instruments correctly contra-angled. Their points are brought close enough to the line of the central axis so that they will not be inclined to twist, or turn, in the fingers when the effort is made to cut with them. They are well balanced.

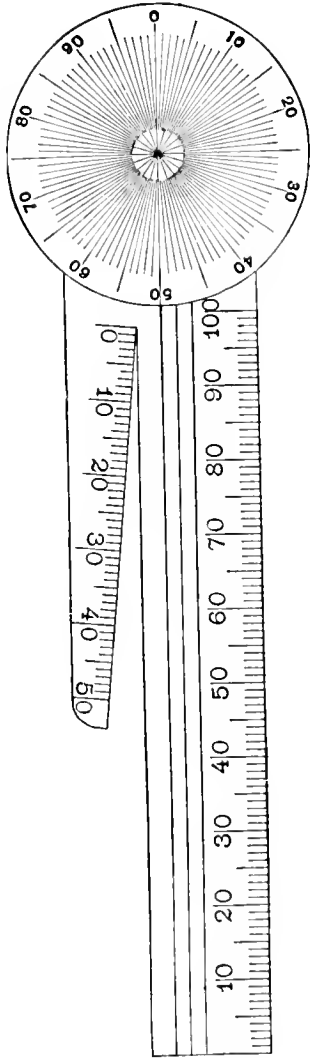

FIG. 17.

FIG. 17. The dental instrument gauge.

MON-ANGLE. An instrument having one angle only leading to the working point, as in pluggers, or in the blades of excavators. Mon-angles form a large majority of ordinary hatchet and hoe excavators. In the more considerable angles only the shorter blades can be successfully used as mon-angles, for the reason that when the blade is long, its inclination carries its working point laterally so far from the central line of the shaft as to render the instrument liable to turn in the hand when the edge is forcibly applied, as the instruments in Figure 15. This renders the instrument unsteady and ineffective.

CONTRA-ANGLE. All cutting instruments, in which the angle and length of blades would carry the cutting edges more than three millimeters from the line of the central axis of the shaft, should be contra-angled, as in Figure 16. In the contra-angles there are the binangles and the triple-angles.

BINANGLE CONTRA-ANGLE. In an instrument of the angle of 12 centigrades or less, the binangle contra-angle will bring the cutting edge sufficiently near the central line of the shaft, and at the same time carry the shank sufficiently out of the way to permit the use of the full length of the blade (see enamel hatchets and spoons, Figure 22). In forming a binangle contra-angle the shank of the instrument is first bent backward (from the direction of the cutting edge), and nearer the cutting edge another bend is made forward — this length forming the blade, the object being to form a long blade, the edge of which will be near the central line of the shaft, as shown in Figure 16.

TRIPLE-ANGLE CONTRA-ANGLE. In instruments of a greater angle than 12 centigrades a binangle will not bring the cutting edge sufficiently near the central line of the shaft, therefore a triple-angle contra-angle must be made (see hatchet 12-5-23 and hoe 12-5-23, Figure 22). This is done by first bending the shank backward, as in the binangle contra-angle, and then forming another angle which will bring the remainder of the shank parallel with the shaft; then passing forward a space of more or less length as may be required, another bend is made forward by which the blade is formed. In this way the cutting edge of a long blade is brought sufficiently near the central line of the shaft for effective work and the shank carried sufficiently out of the way to permit the full use of the length of the blade.

Long blades that require contra-angling are mostly for use in places where a long reach of blade is necessary. (See long hatchets and long hoes, Figure 21.)

RULES FOR FORMING CONTRA-ANGLES. RECAPITULATION.

1st. All blades, the angle and length of which will bring the cutting edge more than three millimeters from the central line of the shaft, should be contra-angled.

2d. All instruments with angles of 12 centigrades or less, when requiring contra-angles, should be binangle contra-angles.

3d. All instruments with angles of more than 12 centigrades, when requiring contra-angles, should be triple-angle contra-angles.

4th. When the contra-angle is used, the cutting edge of the instrument should be brought within two millimeters of the central line of the shaft, or better — when the contra-angle is used, the working edge should be brought just so near the central line of the shaft that, when the instrument is laid edge downward upon a plane surface (as the top of a table), the edge should just touch, but not actually rest upon the surface.

FORMULA NAMES.

Formula names have been adopted for the cutting instruments which describe each individual instrument so accurately that each one may be known when its class and formula is spoken or written. This is necessary in order that a teacher or writer may be understood when speaking of the use of particular instruments, and that students and dentists may speak intelligently of these matters to each other.

These formula names are formed upon the same principle as that used by the carpenter in naming his chisels or augers, as half-inch chisel, one-inch chisel, three-quarter-inch auger, etc. But to sufficiently describe the point of an excavator so that the particular instrument will be known at sight, it is necessary to give three measurements. In all of this, the metric system of measurement is used and there are three distinct units: One for width of blade, the tenth of a millimeter; one for length of blade, the millimeter; one for the angle of blade, the centigrade. We give first the class name, as hatchet, hoe, spoon, etc., and then give the formula of the point or working part. This formula consists of the measurement, first, of the width of the blade in tenths of a millimeter used as the unit; second, of the length of the blade in millimeters; third, the angle of the blade with its shaft or handle, in centigrades, or hundredths of the circle. Note particularly that the width and length make up the size of the blade. Also, in order that the individual instruments of the set

may be easily learned and remembered, we confine the set to a regular range of sizes and range of angles of blades that will give an orderly set for practical use and a sufficient variety of forms. In this way, unnecessary multiplication of forms is prevented.

THE METRIC SYSTEM OF MEASUREMENT.

There is but one possible way of learning any system of measurement and that is by using it. The denominations of the system may, however, be learned from books. In the metric system these denominations, so far as our uses in dentistry require, are:

Meter	39 inches approximately.
Decimeter, tenth of a meter.....	4 " "
Centimeter, hundredth of a meter...	$\frac{2}{5}$ " "
Millimeter, thousandth of a meter...	$\frac{1}{25}$ " "
Tenths, hundredths and thousandths of a millimeter.	

Thousandths of a millimeter are called microns. The micron is used only in microscopic measurements. In measurements of ordinary small bulks of liquids, or of solids, the cubic centimeter (abbreviation c.c.) and the liter are the principal denominations used. Here the measurement is of the three sides of a cube, thus: $10 \times 10 \times 10 = 1,000$. Therefore, there are one thousand cubic centimeters in one liter of water or other liquid. This is all simple enough for any one to understand at a glance, but to really know what it means or to know it in use so that one may have an actual knowledge of what the terms and figures mean, requires a wide, practical use of it.

DENTAL INSTRUMENT GAUGE.

ILLUSTRATION: FIGURE 17.

This gauge for dental instruments is used especially in the measurement of excavators, pluggers and burs. It is in the metric system. The smaller gradations on the principal bar are millimeters. The gradations of the width of the slot formed by the smaller bar on the left are tenths of millimeters. The circular head has one hundred divisions — centigrades — for the measurement of angles. It is used as follows:

1. Measure the width of the blade in the slot numbered from 0 to 50, which gives the width in tenths of a millimeter. In this case the tenth millimeter is used as the unit and entered as a whole number. This is the first figure in the formula.

2. Measure the length of the blade in the gradations on the principal bar, which gives the length of the blade in millimeters. This is the second figure of the formula.

3. Measure the angle of the blade with its shaft. Lay the handle of the instrument on the main bar of the gauge, parallel with the lengthwise lines, and, while keeping it so, bring the blade (turned toward the small numbers to the right) parallel with one of the gradations of the circular head. This will give the angle of the blade with the shaft in centigrades or hundredths of the circle. This gives the third figure of the formula and completes it.

Whenever it is necessary to designate the angle of the cutting edge of a blade with its shaft, it is done by sliding the instrument, without rotating it, to the left, keeping its shaft parallel with the longitudinal lines on the gauge, until the angle of the cutting edge corresponds with one of the lines of the larger numbers to the left. This number is then entered in brackets following the width number. (See gingival margin trimmers, Figure 23.) When not so designated, the cutting edge is at right angles with the length of the blade. Note particularly that all angles are made from the line of the long axis of the handle or shaft of the instrument and express the deviation of the blade from that line.

These formulas are stamped on the handles of the excavators. Plugger points may be measured and designated in a similar manner.

The diameters of burs and drills, and the dimensions of plugger points may be obtained by measurement in the slot. The instrument gauge here described is necessarily a rather expensive instrument, designed more especially for the use of instrument makers and others where great exactness is required. The Boley gauge described later, and which every dentist and dental student should have, though less convenient, will answer for all instrument measurements except the measurement of angles. The measurement of angles may be done as well on the illustration of instrument here published; other measurements can also be made, but less perfectly.

THE CENTIGRADE CIRCLE, Figure 17, was adopted for the measurement of the angles of instrument blades with shafts or handles after much inquiry and trial of the divisions of the circle in general use. The astronomical divisions of the circle (360 degrees) would be very cumbersome because of its excessive number. The division of the mariner's compass (32 points) was not found well suited to this work. After much measurement

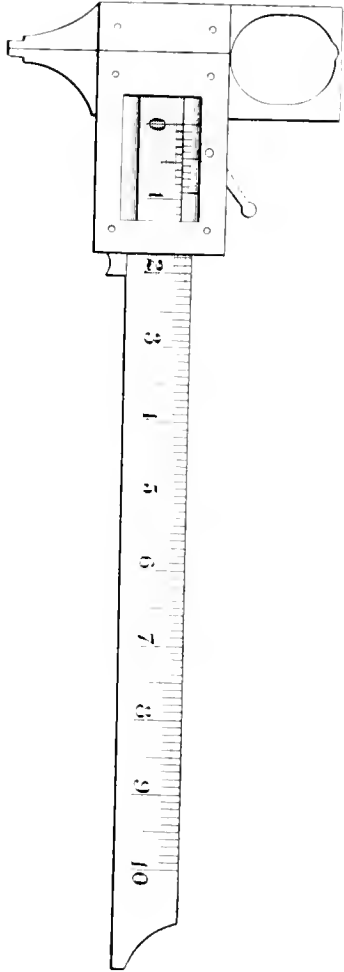

FIG. 15.

FIG. 18. The Boley gauge

and study of the angles of instruments in the market, and especially of the favorite instruments in dentists' cases, the following angles in degrees of the astronomical scale were tried: 20, 40, 60, 80, 100 degrees. This was not found to give a good mental conception of the relation of the angles to the quarter circle, which was the principal factor sought. The centigrade circle was tried with so much better results that it was adopted. It was found also that a fairly even progression of numbers gave better angles. It has proven very easy of mental grasp as compared with the other scales or divisions of the circle. To convert centigrades into degrees, multiply 360 by the number of centigrades and divide by 100, or simply cut off two figures (move the decimal point two figures to the left), as in calculating interest. The following is a comparison of the centigrades angle used, with degrees:

6	centigrades	=	21.6	degrees.
12	"	=	43.2	"
18	"	=	64.8	"
23	"	=	82.8	"
28	"	=	100.8	"
80	"	=	288.0	"
95	"	=	342.0	"

The two last are angles of the cutting edges of the gingival margin trimmers. See Figure 23.

THE BOLEY GAUGE.

In dentistry, the metric system is much better suited to the measurements necessary than feet and inches. For all of this work, except the measurement of instruments, the Boley gauge, Figure 18, is much the best device. It should be in the hands of every student and dentist. It is widely used by watchmakers and scientific men, and it is cheap enough for any one to own. With it, one can make measurements to one-tenth millimeter without difficulty. As there are approximately twenty-five millimeters to the inch, this is one-two hundred and fiftieth of an inch. In doing this the Vernier is used. This is the short scale on the sliding piece by which the jaws of the instrument are opened. Notice particularly that the ten divisions of this short scale — the Vernier — are equal to nine divisions of the principal scale on the instrument bar. When, in reading a measurement, it is found not to coincide with a division of the instrument bar, but is plus a part of a division, the division of the Vernier to the right that is opposite a division of the bar, gives the tenths

plus of the true measurement, completing the reading. Though the Boley gauge is not so convenient for the purpose as the more expensive instrument gauge, Figure 17, all of the instrument measurements may be made with it, except the measurements of the angles of blades. Besides the measurement of instrument blades, plugger points, burs, drills, etc., there are hundreds of uses for it in dentistry, and its use contributes to accuracy of observation.

There is no other one item in manual training that does more for the acquirement of appreciation of form than that of making many accurate measurements. In the human mouth it is rather rare that the central incisors differ so much in width as to be noticed by the ordinary observer, yet, with the Boley gauge, modified by grinding the ends of the straight points moderately thin so that they will go deeply into the embrasures between the teeth, it will be found that these two important teeth are generally not exactly the same in width. The instrument should be used much for measurements in building out broken angles of teeth and in the selection and adaptation of artificial substitutes for lost teeth. If it was more generally used, fewer ugly errors would be made. The man who makes much use of delicate measurements acquires a much finer appreciation of size and form by the eye alone than the man who does not make such measurements.

CLASSIFICATION OF INSTRUMENTS.

One of the special objects sought in this classification is to limit the sizes, lengths and angles of blades of excavators to a well graded, sufficient number, and exclude all others for the prevention of that confusion which indefiniteness brings. This can be seen and appreciated in the illustrations of the Ordinaries, Figures 19, 20. The angles of the blades of these are 6, 12, 18 and 23 centigrades. These angles are found to be ample for all purposes in dentistry, and no other angles of blade are admitted. Angles between those given might certainly be good instruments, or lengths and widths of blades between these also might be good, but why have a greater variety of angles or sizes of blades? What use does such a multiplication of indefinite forms subserve? They create confusion without benefit, and burden manufacturers with unending lists of indefinite forms from which dentists choose indiscriminately, without guide, in the formation of instrument sets, to find finally dissatisfaction with their choice and disorder in their instrument cases. Any

one of these infinite number of forms might be designated accurately by class names and formulas, but why? Can there be any possible advantage gained in general operative procedures? When it is understood that a certain number of definite angles serve our purpose, why not make up the set of instruments of these alone?

The instruments illustrated in Figures 19, 20, 21, are available for use in schools or in practice. They are divided into Ordinaries (48), consisting of an equal number of hatchets and hoes formed on definite ranges of formulas; Specials (38) formed on separate ranges of formulas from the Ordinaries, consisting of enamel hatchets — beveled rights and lefts, spoons, — double plane rights and lefts, or lateral cutting instruments, gingival margin trimmers for the especial purpose indicated by the name, straight and binangle chisels; side instruments (8), consisting of a few instruments of radically different forms from the others named; and a set of 8 long blades.

Notice that each of these are designated by special class names in addition to the formula names. These are so few and simple as to be easily remembered. And yet the number (102) is much greater than any dentist should have in his case for daily use; or better stated, he would not use so large a number of forms if he had them. However, if any one wants some special instrument among his side instruments, a class designed for odd forms, he can order what he may want by the formula plan and get just what his formula calls for. An instance illustrating this occurred some time ago. A dentist ordered an instrument made, giving the formula "Hatchet 20-2-25." This form was so unusual that the manufacturer thought there must have been some error in writing the formula. He therefore made a careful drawing of the instrument and returned it with the question. The answer was, "Correct, send it on." The object of such a large number of gradations of form, size, angles, etc., is to give range of choice under the formula plan of forming definite sets of instruments to suit the varying notions of men, for practitioners and for schools. In forming instrument sets from the Ordinaries, strike out from this list all of a certain range of formulas, retaining all of other certain ranges of formulas, of both hatchets and hoes. As these forms have a similar range of use, their numbers and sizes should be equal.

A LONG SET may be made by taking the sizes 12-5, 8-3 and 6-2, in each of the four angles, cutting this general list in half

This gives twelve hatchets and twelve hoes in the set, which, with the Specials, is an ample assortment for any practitioner.

THE UNIVERSITY SET, Figures 22, 23. In this set all in the angle 18 centigrades are also stricken out from the long set, reducing the number to nine hatchets and nine hoes, eighteen instruments. In this set the side instruments are reduced to four, and the angles 6 and 23 centigrades of spoons are omitted, giving a total of forty-eight cutting instruments. This is found ample for the school or the office. This set of cutting instruments has been in actual use in schools for ten years and many are using it in general practice, so that it has had an abundant trial. Of course, any one who has learned the formula plan can add other instruments of the general set at any time without confusion whenever he finds it desirable in his practice, but for school work it seems unnecessary. This set only will be used in this book.

THE SHORT SET, Figure 24, consisting of twenty-five instruments, is probably as good as can be made with that number. It is a very effective set for school work. It is the shortest set of cutting instruments that should ever be required of students. Occasionally there will be some difficulty in deep cavities for the want of longer blades. In general the work can be well done, but not quite so conveniently.

It will be noticed in forming the long set from the general set of 102 instruments, Figures 19, 20, 21, that the ranges of sizes of blades 14-6, 10-6 and 4-1, are all discarded from the Ordinaries, both in hatchets and hoes; reducing the number of sizes of blades one-half but retaining blades in all of the angles. This forms a very complete and orderly set of instruments for the dentist's instrument case. In the next reduction of the number for the formation of the University set, Figures 22, 23, all of the angles 18 centigrades are dropped out. This is done as a result of the observation that dentists generally will choose the angle 18 centigrades less often than the others. Also that where this angle would be used it can easily be supplied by the angle of 12 centigrades or by the angle 23.

In the further reduction to form the short set, a further compromise is made by selecting the sizes of blade 10-4 and 6-2 only. It forms a usable set for most operations, but to reduce the number of angles in any of these sizes would be inadmissible.

Other sets may be formed besides those given, but in any selection made on this plan, the even running of the ranges of formulas should be carefully preserved. In no case should instru-

Ordinaries—Hatchets.

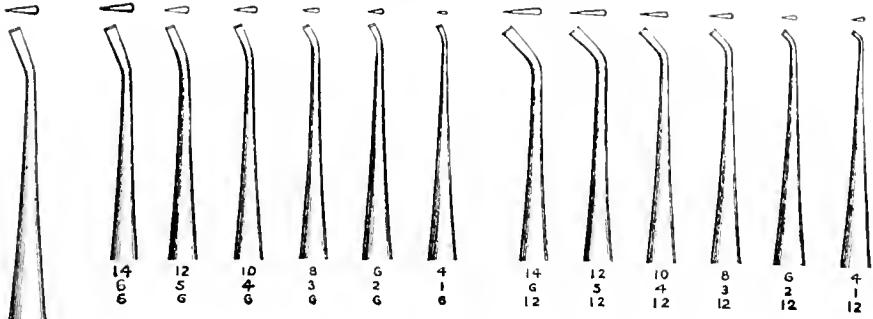

Ordinaries—Hatchets.

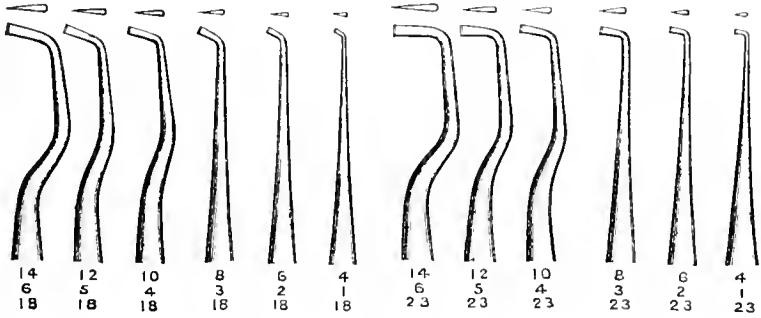

Ordinaries—Hoes.

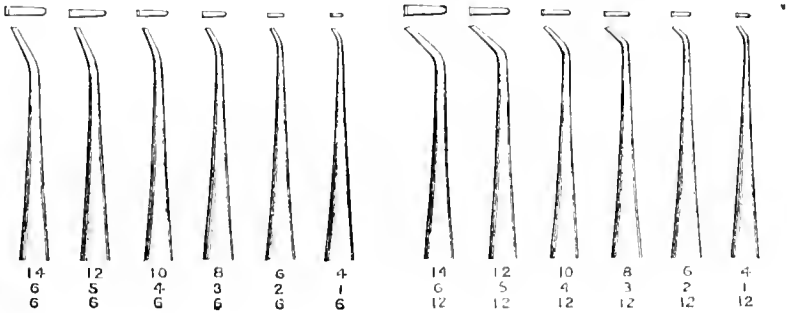
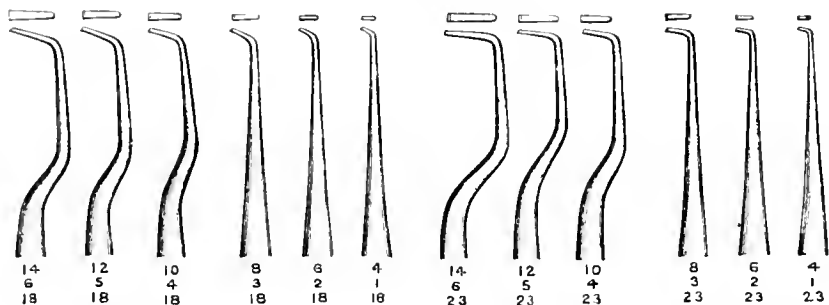

FIG. 19.

FIG. 19. Figures 19, 20, 21, illustrate a set of one hundred and two excavators, classified and arranged on the formula plan, by which each instrument point is conveniently designated by its class name, as hatchet, hoe, etc., and a formula name which designates its size and angle of blade.

Ordinaries—Hoes.



Specials—Enamel Hatchets.

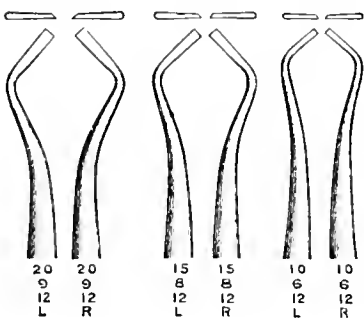

Specials—Spoons.

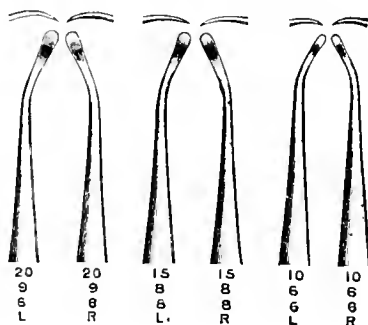

Specials—Spoons.

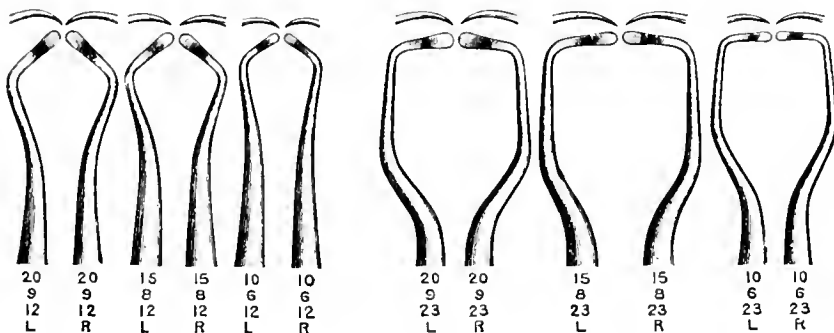
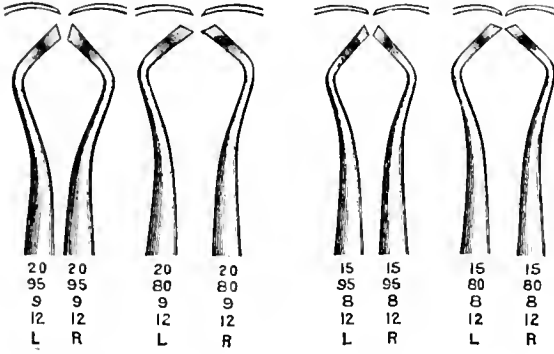

FIG. 20.

FIG. 20. Figures 19, 20, 21, illustrate a set of one hundred and two excavators, classified and arranged on the formula plan, by which each instrument point is conveniently designated by its class name, as hatchet, hoe, etc., and a formula name which designates its size and angle of blade.

Specials—Gingival Margin Trimmers.



**Specials
Bin-Angle Chisels.**



**Specials
Straight Chisels.**

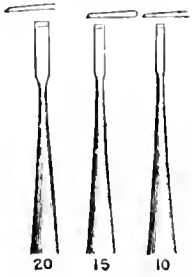

Hatchets.



Side Instruments.

Discoids.



Cleoids.



Long Hatchets.

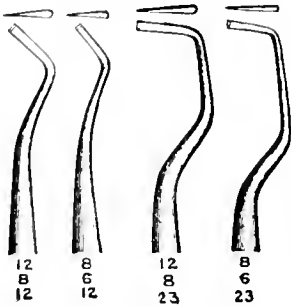

Long Hoes.

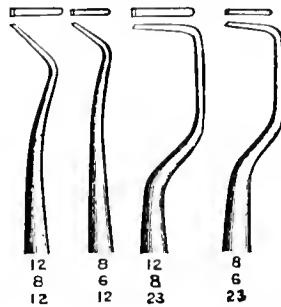
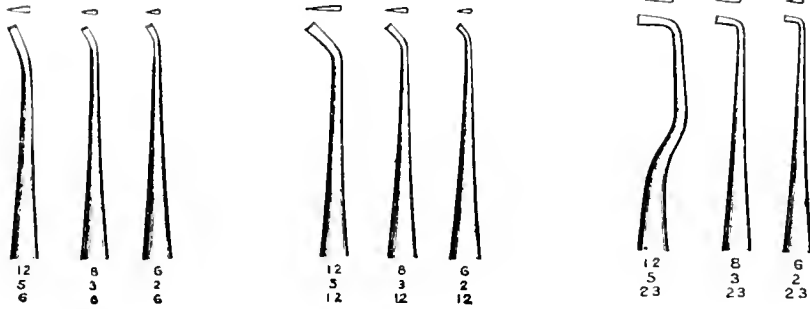

Fig. 21.

FIG. 21. Figures 19, 20, 21, illustrate a set of one hundred and two excavators, classified and arranged on the formula plan, by which each instrument point is conveniently designated by its class name, as hatchet, hoe, etc., and the formula name which designates its size and angle of blade.

Ordinaries—Hatchets.



Ordinaries—Hoes.

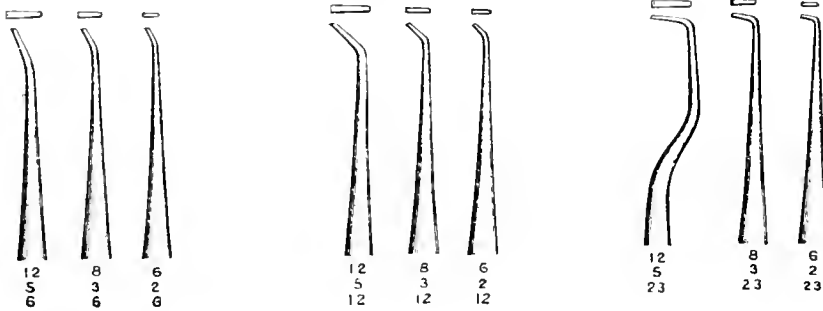

Specials Enamel Hatchets.

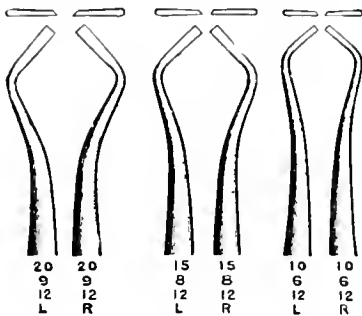

Specials—Spoons.

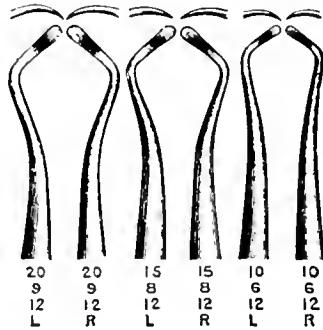
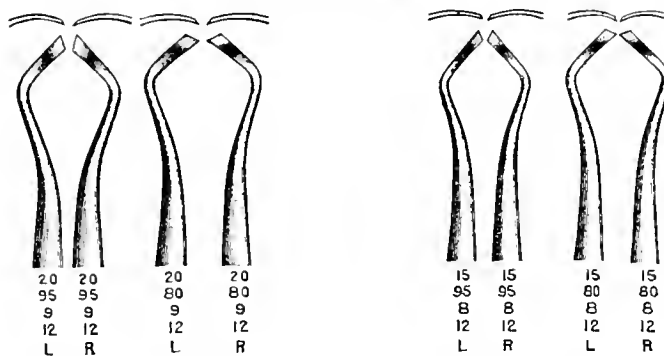

FIG. 22.

Fig. 22. Figures 22, 23, illustrate the University set of forty-eight excavators as selected and arranged from the general set of one hundred and two, shown in Figures 19, 20, 21.

Specials—Gingival Margin Trimmers.



**Specials
Bin-Angle Chisels.**

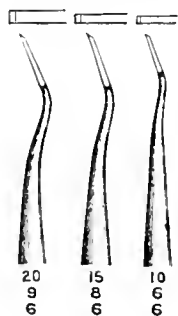

**Specials
Straight Chisels.**



**Side
Hatchets.**



**Instruments.
Discoid. Cleoid.**



FIG. 23.

FIG. 23. Figures 22, 23, illustrate the University set of forty-eight excavators, as selected and arranged from the general set of one hundred and two, shown in Figures 19, 20, 21.

Ordinaries – Hatchets.

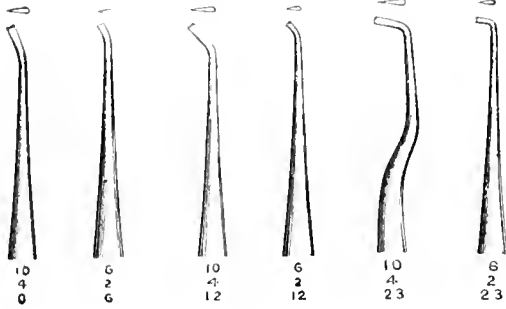

**Specials
Bin-Angle Chisels.**



Ordinaries—Hoes.

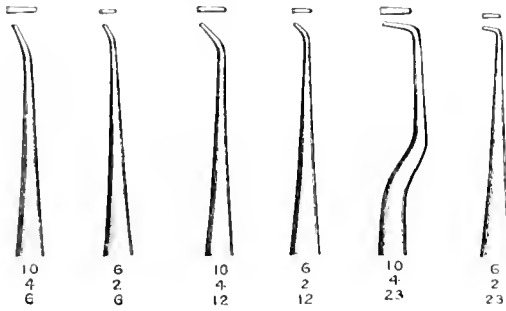

**Specials
Straight Chisels.**



Specials—Spoons.

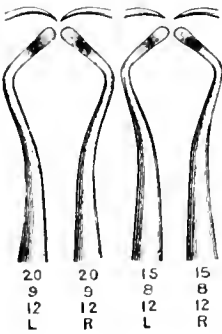

**Specials—Gingival
Margin Trimmers.**

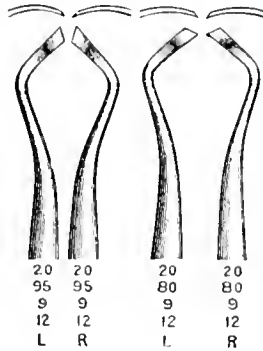

**Side
Instrument
Hatchet.**



Fig. 24.

Fig. 24. The short set of twenty five excavators, as selected and arranged from the set of one hundred and two shown in Figures 19, 20, 21.

ments be selected at random without reference to an even range of formula gradation. If an instrument of the size of blade 12-5 is wanted, that size will be needed as often in the angle 12 centigrades as in the angle 6 centigrades and is required to make an evenly balanced set in practical work at the chair. This is true of any one of the ranges of sizes. When a size of blade is discarded, the whole range of that size should be discarded. The same should be done with angles. But as a matter of fact, it is found that less than three angles will not do in any one range of sizes. When a haphazard selection is made, it soon becomes unsatisfactory in practice. The formulas come to apply to the particular instrument only instead of the instruments of its class and its benefits in teaching the possibilities of the adaptation of instrument forms to practical operations, as well as the reading of instrument points to facilitate this, are lost. The important benefit, other than in teaching, which is greater than all else, is that the student learns to read his instrument points and to know them individually. At the same time, he learns the use of the individual ranges of sizes and the ranges of angles of blades of instruments and makes correct selections without confusion. All of this contributes to accuracy and speed in operating.

It will be noticed that the side instruments are made up of uneven forms. The object of introducing this class is to furnish a place in the mind of the operator, as well as in his operating case, for such odd forms as he may need, or such forms as do not fall easily into the general ranges of formula designation. This prevents the confusion that would occur both in the mind and in the operating case by mixing these with other instruments that are graded in the definite ranges of forms, sizes and angles. This is in harmony with all methodical arrangement of scientific thought and classification and should be carefully observed. Possibly every man will have a few things of personal preference which he should drop into this class of side instruments. Any considerable multiplication of such things will, however, result in confusion and waste of time.

INSTRUMENT CONSTRUCTION.

Dentists should be familiar with the principal points in the construction of instrument forms that render them adapted to the particular uses designed. The reduction in the sizes of instrument points used by dentists that has steadily been going on for the last hundred years is quite as remarkable as the dif-

ferences in form. The general tendency noticed is toward smaller and smaller working points in all cutting instruments and pluggers. This has reference to those instruments in greatest use by dentists, decade after decade. With this difference in size has also come a difference in instrument grasps, and in the method of handling instruments in dentistry. All of the older instrument forms were based on the developments in fine carving and engraving. Carving was highly developed in very ancient times. The instruments for all of the more delicate work were adapted to manipulations in which the object being cut could be turned to suit the hand and the instrument grasp. In all of the books on dentistry more than one hundred years old, the instrument handles were designed to be grasped in the same way as instruments were grasped by persons doing fine carving. The handles were large, the points were large and rigid and they were used with the palm grasp, palm-and-thumb grasp, or palm-thrust grasp. See instrument grasps, Figures 26-30. The dentist operating on the natural teeth could not turn the tooth about to accommodate his hand. And as the conception of the delicacy needed in this work grew in his appreciation, we find that he gradually changed the forms of his instrument handles, making them suitable for the more delicate pen grasp with its larger variety of applications, and reduced the size of the working points in proportion to the reduction of power in the form of grasp. This is clearly a case of the survival of the fittest, or those forms and methods of use of instruments best adapted to the objects designed. Enamel and dentin are hard substances to cut, and in order to cut them effectively, the force that can be exerted by the hand with the grasp used must be concentrated upon a very short length of blade. It is a mistake to use a broad blade, of a chisel for instance, where much enamel is to be cut away. The length of the cutting edge is too great for the power of the hand to do effective work. Narrower blades and more careful direction by the hand contribute to speed, because the whole force of the hand is concentrated on the smaller area and becomes that much more effective. The dentist should never lose sight of this fact.

At the present time and with the excellent quality of steel that it is possible to put into instrument points, these should always be small and the edge should be kept in the best condition. With proper care, and especially with a proper appreciation of the strength of steel, a light chisel or excavator, properly tempered, is rarely broken. The breakage of instruments is

generally by careless handling. A certain degree of stiffness is essential in the shanks of excavators. They should be no larger than is actually required for this. Within the range of exact observation, thirty-five pounds lateral pressure on an instrument point is the limit that any man has been able to make with the pen grasp. For a large proportion of the smaller blades, twenty pounds is abundant. Indeed, it is only a small minority of men who can exert that force with the pen grasp. The only possible need of stronger instruments nowadays is in the possible use of the palm-and-thumb grasp, which is limited to a very few instrument forms. This allows us to use instruments of very delicate forms, that are also elegant, and obscure the following of the work by the eye to the least possible amount.

RIGHTS AND LEFTS. While the greater number of cutting instruments are *direct* cutting, there is a distinct division of *lateral* cutting instruments better known as "rights and lefts." These are all *double plane* instruments. If an instrument with two or more curves or angles in the shank is laid on a table, it will generally be found that all of the curves are in a single plane, which may be made to coincide with the plane of the table top. Or, if held before the eye, or between the eye and a window, in a certain position in relation to its curves, it forms a straight line. This is a *single plane* instrument because all of its angles and curves are on one plane. All of the lateral cutting instruments have an angle or curve in a plane at right angles to this principal plane. This will be seen by holding any of the spoons or gingival margin trimmers before the eye. The curve of the blade is in the opposite plane to the angles. It is this that makes it a lateral cutting instrument. They are therefore *double plane* instruments. Angles that are in any other direction than in one of these planes are inadmissible. It often appears that an angle in a different direction would enable one to do certain things easier and many instruments have been so made. None of them have remained long in use because of their unfitness. There seems to be some undefined sense of antagonism to the muscular sense or the appreciation of motion that causes all such instrument forms to become awkward and obnoxious.

BIBEVELED CUTTING INSTRUMENTS. In the Ordinaries, the hatchets are all bibeveled cutting instruments intended for direct cutting. In forming the edges, the blades are equally beveled on the two sides. In sharpening these, they should be ground equally on the two sides. They cut by being pushed forward

in the direction of the length of the blade, or shave a wall by being inclined toward it at about the angle of the bevel, or again they may be used laterally with a scraping motion. This form of instrument has a great range of usefulness in all of the more delicate cutting in the preparation of cavities, and especially in the incisor teeth. In the angle of 6 centigrades much use can be made of them with the push motion somewhat similar to the use of a chisel. Indeed, it has the greatest variety of applications of any instrument the dentist has in his outfit.

THE HOES are essentially pull motion cutting instruments and in the angles of 12 and 23 centigrades are used most with a scraping motion. In the angle of 6 centigrades they are used most with a push motion or as chisels. This is a very important form of the hoe, especially in the sizes 8-3 and 12-5. The hoe is beveled on the distal side of the blade only, and the bevel should be rather short, much like the bevel of chisels. Efforts have been made from time to time to form a right angle hoe to work with a push motion by beveling on the mesial side of the blade instead of the distal. This has not been sufficiently successful for any such instrument to be continued in use.

BEVELED RIGHTS AND LEFTS. Beveled rights and lefts are direct cutting instruments made into rights and lefts by placing a bevel on one side of the blade of one, and on the other side of the blade of another, forming a pair. These are not double plane instruments, however, neither are they lateral cutting, but are direct cutting instruments in which one is suited for shaving down one wall of a cavity and the other suitable for the opposite wall. (See enamel hatchets, Figure 22.) Such instruments are made heavier and stronger in their shanks and blades than others for the heaviest usage in chipping enamel and shaving enamel or dentin walls. The edges are of a shorter bevel, to enable them to better stand the strain of this heavy cutting of hard enamel. Yet, they will cut dentin equally well.

CONTRA-ANGLES. Contra-angles are formed for the purpose of placing the cutting edge of an instrument with a long blade in the line of the axis of the shaft, or so nearly so that the divergence will not be material in its effect in the working balance of the instrument, rules for which have been given. See Figures 15, 16. This is an important factor in instrument construction that has been much ignored by persons designing instrument forms. For this reason, persons selecting instruments should examine carefully to see that the working point is sufficiently near the line of the central axis of the shaft for

the instrument to be fairly balanced in the hand when pressure is made with its cutting edge. This will be better appreciated by trying such an instrument as any of those illustrated in Figure 15, which have been incorrectly contra-angled. At every effort to cut with such an instrument, there is felt a tendency to turn in the fingers, and, unless this is closely guarded in every considerable effort, it may do damage. Under any conditions such an instrument will be found lacking in usefulness as compared with a similar length of blade properly contra-angled as shown in Figure 16. The object of the contra-angle is to enable one to use a long blade effectively.

In Figures 15, 16, a line has been drawn over the handle and instrument point to show the relation of the point to the long axis of the instrument handle. It will be noticed that those in Figure 15 have the point far to one side of the central line of the shaft, while those in Figure 16 have the contra-angle so made that the working point is close to the line of the central axis of the shaft. These latter will reach into a deep cavity just as well as the former, and will be steady under pressure in cutting. In using those made as in Figure 15, the hand will always be struggling to prevent the instrument from tipping or turning. This will not be felt in the use of those made as shown in Figure 16.

Formerly dentists used instruments with very large handles, as has been mentioned; often as much as three-quarters of an inch in diameter and these were used with the palm grasp. An instrument with a blade such as the spoons in Figures 20 or 22 would need no contra-angling when used with such a handle and such a grasp, and this contra-angling was then not thought of. In the change to the small handles suitable to the pen grasp, there has been much tendency to continue these old forms. Also many persons seem to have had the thought that a very crooked instrument with a point far off from the line of the shaft would enable them to reach into very deep cavities better. An examination of the long blades in Figure 21 will dispel this idea. Such instrument points not only reach into deep cavities well, but they are also well balanced in use and much more effective because of that fact.

SHARPENING INSTRUMENTS.

Nothing in the technical procedures of dental practice is more important than the care of the cutting edges of instruments. No man has ever yet become a good and efficient dentist

until after he had learned to keep his cutting instruments sharp. It is simply impossible to effectively prepare cavities for filling without sharp instruments. The student who can not, or will not, learn this should abandon the study of dentistry.

A good Arkansas stone is a necessity and is one of the best pieces of property in the outfit of a dentist. If properly cared for, it will serve for a lifetime. It is therefore well worth while to be careful in its selection and to pay a price that will command a stone of the best quality. It is of first importance that the stone be very hard. Dental instruments are very small, and if the attempt is made to use a soft stone, the point will catch and ruin both the edge of the instrument and the surface of the stone. The quickness of cutting, or the so-called "sharpness" of the stone is certainly a very desirable quality, but should be held as secondary to hardness; for, if the surface of the stone easily becomes roughened or uneven, it becomes ineffective. A very hard stone that will cut with only medium quickness is much more desirable than a quicker cutting stone that is continually losing the evenness of its surface. Dental instruments do not need much grinding but do need accurate grinding.

The size of the stone should not be less than one and one-half by five inches. A little larger stone is better, but a dentist should not use a smaller one. The stone should be cared for methodically and carefully. It should be kept in a light but strong case or box that will protect it from breakage in any ordinary fall. The stone should be thoroughly soaked in oil and then wiped off as dry as possible. It may then be used with oil or used dry, but however used the surface should be cleaned after using with a woolen cloth and oil. In grinding steel, the steel cuttings fill up the "teeth of the stone" and soon the stone becomes dulled and will not cut well. The oil on the woolen cloth removes these cuttings and serves to keep the face of the stone sharp and otherwise in good condition. It is well to keep such a cloth in the box with the stone and always clean the stone after using, before it is put away. In operating at the chair, the stone should always be conveniently at hand for correcting the edge of any instrument that is not just right. If, in time, the surface of the stone becomes in any way marred or is worn unevenly, it may be refaced by rubbing it on a sheet of emery paper laid flat on a smooth table or level board. The facing should be finished on the finest grade of emery paper.

In grinding the cutting edges of excavators, the correct bevel should be carefully maintained. The bevel wanted on each

class of instruments should have careful study. The hatchet ordinaries should be ground to a thin edge equally beveled on the two sides — bibeveled — and the degree of bevel should be the same at each grinding. The motion in grinding should be the full length of the stone at each stroke, and a finger rest on the face of the stone, or of its box, should slide with the stroke in order to maintain the particular angle of the blade to the stone throughout the length of each stroke in order that the grinding will be flat. One principal fault observed in the sharpening of hatchet ordinaries is the tendency to rounding of the edges instead of keeping them straight, square with the blade, and the angles with the blades sharp and definite. These instruments do the best work when their edges are ground in this form. This is true of all dental cutting instruments except the gingival margin trimmers, which are made with a special angle of cutting edge, which adapts it to one special purpose.

The hoes have only one bevel. This is on the distal side of the blade. They are ground on that side only. These are used mostly with a scraping motion, and for this purpose a short bevel is best. A bevel of ten to twelve centigrades is good. In grinding the hoes, the blades of which are twelve centigrades angle with the shaft, the shaft will stand almost perpendicular to the surface of the stone in order to obtain this bevel. If the edge is turned from the operator, the grinding should be done mostly with the pull motion. On the push movement, the instrument is likely to chatter if pressure is used. The hoes with twenty-three centigrades angle of blade should be placed on the stone with the edge down and the shaft inclined toward the operator sufficiently to give the correct bevel of the blade, and in the movement back and forth the principal pressure should be applied on the push motion. It is not difficult, with a little careful attention, to keep the edge straight and square with the blade. The hoes of six centigrades angle must also have their particular position on the stone to give their blades the proper bevel. With the end of the stone to the hand, lay the beveled side of the hoe downward with the point toward the distant end of the stone. Then raise the handle until the blade is at the proper angle with the surface of the stone to give the correct bevel in grinding. Then use that particular position in grinding all of the hoes of this angle. From this it will be seen that each class of point has its particular position on the stone for each of its angles. The size of the blade does not affect its relation to the stone. For each instrument we use, the best relation to the stone for that form

should have careful attention. It is to be done in the same way day after day and correct habits of grasp and movement should be formed for each instrument.

The chisels and enamel hatchets, which are much used for chipping enamel and trimming enamel walls, should have a short bevel similar to that of the hoes. The chisels are ground in a manner very similar to the grinding of the hoes. They are the simplest and easiest of the cutting instruments to sharpen correctly. In grinding the enamel hatchets, the stone should be laid differently to the hand and the instrument should be grasped differently. In grinding the right-hand instrument, lay the stone crosswise to the length of the arm. Catch the instrument shaft between the third and fourth fingers, with the point between the thumb and forefinger. Find the position that will give the correct bevel and grind with an elbow movement, sweeping from end to end of the stone. In this grasp, the end of the second finger may slide on the stone as a rest. In grinding the left-hand instrument, use the ordinary pen grasp, turn the hand until the thumb nearly touches the stone, use the third finger as a rest, find the position that will make the correct bevel and grind with the elbow movement.

In all of these, the edges should be kept straight and should be equally sharp in all parts of their length. Too much grinding should be carefully avoided. Make the edge sharp and no more. One should be always trying the edges to ascertain the degree of sharpness, and these trials should include three points on the edge of each instrument even to the smallest of the excavators: the center of the length of the edge and each of the angles of the edge with the blade. The trials should be made on the thumb or finger nails. Touch the edge to the nail lightly and see that it takes, or catches; if, with this very light pressure, any part of the edge will slip on the nail instead of taking hold, it is not fully sharp and needs more grinding. This test on the nails is a very delicate one and if delicately used will not mar the nails and will very certainly reveal any lack of perfection in the edge of the instrument. The correct angle of the edge with the length of the blade should be very carefully preserved in all of the grindings. When all of this is done carefully, the edges kept in good form, sharp, and not overground, the instruments furnished us will do an immense amount of service. An instrument will occasionally be found that is too hard, so that the edge crumbles, or is too soft, so that the edge will not hold. The tempering of these small instrument points is an extremely delicate process and

occasional errors should be expected. When these are discovered, the particular instrument should be discarded at once and its place supplied by a new one.

The spoons and discoids are ground easiest by so placing them on the stone that the motion in grinding will be parallel with the length of the circular edge, and during each stroke from end to end of the stone the instrument shaft should be rotated in its length on its point in the line of the length of the stroke so as to bring every point in the circular edge on the stone. In this movement, the point of the instrument is first toward the near end of the stone, and with the progress of the stroke the angle is progressively changed so that in the center of the stone the shaft is perpendicular to the stone, and at the end of the stroke the point will be toward the distant end of the stone. In the progress of each stroke, the circular edge is ground at the proper bevel in every part of its length. When this stroke is once learned, it is easily and rapidly done and these circular edges may be very accurately ground. The spoons may also be ground with fine emery disks in the engine. The spoon should be held in the left hand and the rapidly rotating disk so placed that its motion is from the edge. By carrying the disk regularly around the circumference, the edge may be given the proper curve. After a few efforts a particular way of holding the instrument for obtaining accuracy of bevel in all parts of the circumference of the edge will be readily found. In sharpening a pair of spoons, the disk should revolve to the right for one, to the left for the other. The emery disk will not make as fine an edge, however, as a good Arkansas stone.

The special points in grinding the gingival margin trimmers are: to carefully maintain the bevel of the edge and the correct angle of the edge with the shaft of the instrument. They should be very sharp, but the bevel should be rather short.

Burs and finishing files are ground with knife-edged slips of Arkansas stone. These may be obtained from the jeweler's supply houses. A very hard stone is essential. A strip of fine emery cloth on a flat board completes the necessary outfit. The stone is used as in delicate filing of the leaves of blades of the bur or finishing file. The edges of the stone should be flooded with oil. When the edge of the stone has become dulled or rounded by use, it is ground to correct form on the emery cloth. Every blade of the bur or file should be made sharp and the work should be so regularly done that the edges of the different blades will be of equal height. This may be done by the dentist

himself, or he may have the instrument maker do it for him. The very small worn burs had as well be thrown away. All of the larger ones can be made as good as new several times by grinding. The finishing files may be reground many times and still do good work. There is perhaps no instrument more seriously injured by becoming dulled than the finishing files. Therefore, frequent sharpening is very essential to their usefulness. Any small bur that has been once used on enamel, for instance, in cutting a slot into the occlusal surface of a molar from a proximal cavity for the formation of a step, should at once be discarded. The edges will have become so injured that it will be unfit for further use. Such a bur may be used many times for a similar amount of cutting in dentin without serious injury.

STUDIES OF INSTRUMENT FORMS AND THEIR FORMULAS, WITH BRIEF OUTLINE OF THEIR USES.

NOTE: In this, only the University set of instruments will be used, but, by changing the formulas to agree with another set chosen, the plan here given may be used in a similar way.

ORDINARIES.

The set of ordinaries has been so called because it includes the hatchet and hoe forms that have been most used by dentists in the past. Instruments similar to them, but less perfectly assorted, are found in every dentist's operating case. The smaller sizes of this set are used but little except in the preparation of cavities in the incisor teeth, and mostly in the final shaping of the walls and angles of these cavities after they have been opened by other instruments.

The hoe 12-5-6 used as a chisel is the most useful instrument in opening cavities in the incisors, especially for cutting away the labial enamel margins until the proper form has been reached. The hatchet 12-5-6 performs the same office for the gingival wall. Very often, in the more delicate cutting, the middle sizes, i. e., hoe 8-3-6 and hatchet 8-3-6, will serve better. In many cases it will be found more convenient to use the same sizes in the angle of 12 centigrades, or the hoe 12-5-12 and hatchet 12-5-12, etc., or the sizes 8-3. The smallest size, or 6-2-6, -12 and -23, are used only in shaping the internal parts of cavities in the incisors and cusps, and especially in squaring out the axial line angles of these cavities so that they are sharp and definite. Those with the angle of 23 centigrades are convenient for reaching certain

points not easily reached with the angles 6 and 12 centigrades, but are used much less than the latter.

READING INSTRUMENT POINTS. Every dentist should learn to read his instrument points, or to know each at a glance. In learning this the following forms may be used:

FIRST FORM. Write the figures of the tabular forms printed below on a sheet of ordinary ruled writing-paper two lines apart, each form on a separate sheet.

Select the hatchets from the set of ordinaries, using Figure 22 to assist, if necessary. Lay each above the line of figures stamped on its handle, or shaft.

The blades are 12 wide, 5 long, 6 centigrades angle.

8	“	3	“	6	“	“
6	“	2	“	6	“	“
12	“	5	“	12	“	“
8	“	3	“	12	“	“
6	“	2	“	12	“	“
12	“	5	“	23	“	“
8	“	3	“	23	“	“
6	“	2	“	23	“	“

Note particularly the repetitions in these lines of figures. Carefully compare the width and length of blade of each instrument with the figures of the first two columns. Take up each instrument and measure the size of its blade on the printed gauge as directed for instrument measurement, Figure 17, and return each to its place on the page. Measure the angles of each and return. Be careful to follow the directions accurately.

SECOND FORM. Lay the hoes together on this form, each over the figures which agree with those stamped on its handle.

The blades are 12 wide, 5 long, 6 centigrades angle.

12	“	5	“	12	“	“
12	“	5	“	23	“	“
8	“	3	“	6	“	“
8	“	3	“	12	“	“
8	“	3	“	23	“	“
6	“	2	“	6	“	“
6	“	2	“	12	“	“
6	“	2	“	23	“	“

This form brings those of the same sizes of blade together, while in the first form the equal angles are together. Look them all over carefully in this relation to each other, examining breadth, length and angles of the points particularly. Note that

the hatchets and hoes are represented by the same formulas. Take up the hoes, one by one, and lay each beside the hatchet of corresponding formula; study the blades in this position. Now remove the hatchets, one by one, and place them on the second form, each with the formula on its handle, over the corresponding line of figures. It will be seen now that the hatchets and hoes are of the same sizes and of the same angles; there are the same ranges of sizes and angles. There are in this set, three groups with blades of equal sizes, with three instruments in each group; also three groups of equal angles with three instruments in each, of each of the sizes of hatchets and hoes. Each group of equal sizes has a range of three angles; each group of equal angles has a range of three sizes, a large, a medium and a small size. Each blade belongs with a definite class (hoe or hatchet), and has a definite formula. It will not fit any other.

When this has been studied, take up the hatchets and jumble them together, and, looking at the blades only, try naming each in its turn, laying it in its proper place on the paper on which the formulas have been written. Do the same with the hoes. Do this once per day until each blade can be named at sight, as hatchet 12-5-6, hoe 8-3-23, hoe 6-2-12, hatchet 6-2-23, etc., for all this set. After this, form the habit of calling each by its full name. Some will learn these at a single effort, others may need as much as five or six. Then, use of the names will fix them permanently in the memory. It is not so much that one may learn this list of instruments as that he shall learn the application of formulas to instruments and become able to read formulas from instrument points or to read the form of instrument points from formulas. To do this well, he should make many measurements.

THE SPECIALS.

The set of specials are so called because each instrument is designed for a special use. The formulas of this set are upon a different set of sizes, or the ranges are on different sizes, the plan of measurement being the same. In these are also three size ranges, or widths and lengths of blade. There is, in the University set, only one angle of blade — 12 centigrades — for all except the binangled chisels, which are 6 centigrades angle.

The specials present less difficulty in learning to read the points than the ordinaries, because they are in smaller groups under the class names. They may be studied, however, on the same plan recommended for the ordinaries. These groups, except the chisels, have each the same or similar ranges under

formula names. They are illustrated in Figures 20, 21, and those included in the University set are shown in Figures 22, 23.

The enamel hatchets form one group of three pairs, each pair different in size and length of blade, and in the University set they are all of one angle. They are enamel hatchets 20-9-12, 15-8-12 and 10-6-12, each pair beveled rights and lefts, direct cutting instruments. Their use has been particularly mentioned.

The spoons are also three pairs of true lateral cutting rights and lefts of the same formulas as the enamel hatchets. They are spoons 20-9-12, 15-8-12 and 10-6-12. The sizes of the blades of both these sets of pairs ought to be readily remembered, and the class and formula names spoken on sight after a few trials, coupled with measurements on different days.

The gingival margin trimmers are incomplete in the range of sizes, in that no 10-6-12 is used. But the formulas 20(95)-9-12 and 15(95)-8-12 are the same as hatchets and spoons, except for the addition of the angle of the cutting-edge. (See directions for measurement of angles of cutting edges on instrument gauge.) In all the other instruments the cutting-edge is at right angles to the length of the blade; but in these a different angle of the edge with the blade is introduced. They are made for the one purpose of beveling the gingival cavo-surface angle of proximal cavities in the bicuspid and molars. For this purpose the blades of one pair are cut so that the edge is at an angle of 95 centigrades with its shaft, fitting it for the beveling of the gingival cavo-surface angle of a distal cavity in a bicuspid or molar, the one cutting to the right and the other to the left. The other pair of instruments have the cutting edges cut to 80 centigrades with the shafts, fitting them for the similar beveling of the gingival cavo-surface angle of a cavity in the mesial surface of a bicuspid or molar. On account of this peculiarity of form, two pairs of each size of blade are necessary: one pair for distal cavities and one pair for mesial cavities.

The pairs of gingival margin trimmers 15(95)-8-12, and 15(80)-8-12, are for use in bicuspid cavities which are often too narrow mesio-distally to admit the width of the pair 20(95)-9-12, or 20(80)-9-12. The approach of the 20(80)-9-12 to the gingival wall of a mesial cavity is shown in Figure 195.

In the binangle chisels we use the 6 centigrades angle only, as in the range, binangle chisel 20-9-6, 15-8-6 and 10-6-6, or we name them simply as chisel 20-9-6, etc. The straight chisels we designate the range as chisel 20, chisel 15 and chisel 10, using only the width term.

Of the groups of specials, the enamel hatchets are rights and lefts, because of the form of the bevel of the cutting edge. The spoons and gingival margin trimmers are made rights and lefts by the curve of the blade. All the specials are designed for special work. They are used, except the smallest size of the spoons, almost exclusively in the bicuspid and molars, and should be used for almost all of the work of excavating in these teeth.

The chisels and enamel hatchets are used for chipping away the enamel in opening cavities in the bicuspid and molars, and in cutting the outlines to the required form. The enamel hatchets are used especially for cutting away the buccal and lingual walls in occlusal or proximal cavities, and also in cutting and shaping the gingival walls of proximal cavities in these teeth. Both the chisels and enamel hatchets are used in the final shaping of the enamel wall and in beveling the cavo-surface angle of the enamel.

The gingival margin trimmers are designed especially for the purpose of beveling the cavo-surface angle of the enamel along the gingival wall of proximal cavities in the bicuspid and molars. These are the only instruments made that will do this particular bit of work accurately and easily, and are essential to accurate operating.

The spoons are used for scooping out softened material (cariou dentin) from the deeper parts of carious cavities in the bicuspid and molars. Occasionally the smaller sizes are used in the incisors. They should be used only after the cavity walls have been cut to form by other instruments. They are not at all suited to cutting hard dentin.

SIDE INSTRUMENTS.

In the University set we have but four side instruments. The hatchets 5-3-28 and 3-2-28 stand to themselves as a range. They are for the one purpose of cutting a retention groove in the incisal angle of simple proximal cavities in the incisors and cuspids.

Discoid 20-2-12 and cleoid 20, also single instruments, are not connected with any set of ranges in the University set. The discoid is found to be a very useful instrument. Sometimes in cavities of easy access it will take the place of a spoon. It is used much more, however, for catching and removing points of overlap of filling material about irregularities of the surface of the enamel along the margins of cavities in the occlusal surfaces of bicuspid and molars. It is, therefore, more of a finishing instrument than an excavator.

The cleoid is used most for trimming out the angles of pulp chambers in order to reach the canals with the broach more readily, especially the canals in the mesio-buccal roots of the upper molars and the mesio-buccal and mesio-lingual angles in the lower molars.

ARRANGEMENT OF INSTRUMENTS IN THE OPERATING CASE.

The following is presented as a very satisfactory arrangement of the instruments of the University set in the operating case:

Chisels.	Enamel Hatchets.	Gingival Margin Trimmers.	Spoons.
20			
15			
10			
20-9-6			
15-8-6			
10-6-6			
	20-9-12 R		
	20-9-12 L		
	15-8-12 R		
	15-8-12 L		
	10-6-12 R		
	10-6-12 L		
		20(95)-9-12 R	
		20(95)-9-12 L	
		20(80)-9-12 R	
		20(80)-9-12 L	
		15(95)-8-12 R	
		15(95)-8-12 L	
		15(80)-8-12 R	
		15(80)-8-12 L	
			20-9-12 R
			20-9-12 L
			15-8-12 R
			15-8-12 L
			10-6-12 R
			10-6-12 L
Hoes.	Hatchets.	Side Instruments.	
12-5-6	12-5-6	Hatchet	5-3-28
8-3-6	8-3-6	Hatchet	3-2-28
6-2-6	6-2-6	Discoid	20-2-12
12-5-12	12-5-12	Cleoid	20
8-3-12	8-3-12		
6-2-12	6-2-12		
12-5-23	12-5-23		
8-3-23	8-3-23		
6-2-23	6-2-23		

When the instruments are placed in the operating case for use, they should be arranged in a definite form and always kept so. It is not important what form is used so that the form selected is adhered to in all of the work. But the form given is preferred. In this way there should never be any search for the particular instrument wanted for any purpose. The man who knows his instrument points at sight and is able to think and speak in their formulas, will, by this fact, be able to do one-third more excavating in a given time and do it more accurately than one who does not know them. Up to the present time, the average dentist, who has not learned to think in his instrument forms and in the adaptation of these to his needs, wastes fully one-third of his time in searching for, and in making changes, to find instruments with which to do certain things. This time will be much more than saved by the orderly method of procedure. Many of the more successful men in practice have learned, without special method, to think in a few favorite forms and use the

few for almost all of their work. An orderly arrangement such as the formula plan gives will enable them to think easily in several ranges of forms and to adapt a greater variety of forms to the varying needs. This will contribute both to accuracy and to speed in operating. This is worth many hundred times what it costs in effort to accomplish it.

USE OF THE DENTAL ENGINE.

ILLUSTRATION: FIGURE 25.

The effort to use some kind of mechanical device for the turning of burs and drills in the excavation of cavities and in finishing fillings was begun many years ago. As early as 1840 several persons had made devices for this purpose, worked by a lever in the handle operated by a finger or thumb. None of these became diffused through the profession, but were individual instruments, usually rudely made by the operators who used them. Toward the close of the sixth decade of the last century, a small pneumatic engine was attached to a sleeved mandrel carrying a bur or drill, which was worked by a bellows-like air pump connected with the instrument by a rubber tube. This pump was put in action by the foot of the operator. It proved practicable, and was the first device for this purpose regularly manufactured for the use of dentists. Within ten years many different forms of dental engines were offered the profession. These soon became crystallized into a few favorite forms and their use at the operating chair rapidly became general.

The engine is used for certain parts of the work of excavating cavities, for trimming fillings to form after they have been inserted, and for a large amount of the work of polishing. For these several purposes, engines should be equipped with certain sizes and forms of excavating burs, a few sizes and forms of finishing burs, stones for grinding and sandpaper disks of different grades of fineness, rubber disks for carrying polishing powders, etc. In excavating, the bur is nowadays indispensable, and yet but a small part of the excavating should be done with burs. The tendency among students, as well as practitioners, is to continually use the bur too much and to use it in improper places.

The forms of bur most useful are what are known as the inverted cone bur and the fissure bur. Round burs are not often used to advantage, and yet there are certain definite purposes requiring round burs.

The sizes of burs are very important. With the dental engines with which we were supplied a few years ago, no large burs could be used to advantage, for the reason that the motion was conveyed by a cable, which allowed large burs to jump and chatter. Cord engines give to the bur a much smoother motion and better cutting power. Practically none of them have sufficient power to run a large bur to advantage. For our use, then, burs for excavating that are over one and a half millimeters in diameter should not be used at all. The most useful burs are one millimeter and less in diameter.

THE ROUND BUR. The round bur is used only for the one purpose of opening pit cavities in which decay has only just begun. For this purpose round burs, from a little less than one millimeter to one and a half millimeters in diameter, should be used by placing them in the pit while in motion and swaying the hand-piece to and fro so as to rotate the bur laterally while it is rapidly turning upon its axis. This lateral motion of the hand-piece will cause the bur to cut much more rapidly than when simply held against the work. Use the smaller size first, and when it has entered the pit, change it for a larger, using this in a similar way, and follow this again with a larger size. Then the round bur should be laid aside and the cavity finished, if further enlargement is required, with other instruments. There is no other use for a round bur in excavating cavities. It should never be used for removing decayed dentin. If the pit cavity requires no further extension, the round bur should be followed by an inverted cone that will square out the pulpal or axial wall of the cavity and make the angles with the surrounding walls sharp and definite. A cavity with rounded angles is the most difficult of all cavity forms to fill perfectly and should never be made when any kind of metallic filling is to be used.

THE INVERTED CONE BUR, THE FISSURE BUR. For other purposes in excavating, it is a matter of choice in individual cases between the use of the inverted cone and the fissure bur. These burs should be used in several positions, which will be pointed out.

In cutting seats or steps for anchorage in mesio- or disto-occlusal cavities in the bicuspids and molars: After the mesial or distal cavity has been well opened with cutting instruments, and the cutting of a step in the occlusal surface is required, choose a small inverted cone or fissure bur, never more than one millimeter in diameter, and begin within the dentin close against the dento-enamel junction, causing the bur to enter, and then

draw it to the surface of the enamel; engage it again in the same way and repeat the motion. With this movement, using a small bur, a groove is readily cut through the enamel into the center of the occlusal surface. In this cutting, the line of the mesial (or distal) groove should be followed, because this is the weakest part of the enamel. If the bur is too large, it will not cut so well. It is only by concentrating the force on a small bur that the enamel can be cut to any advantage, and even then the cut should be made from within outward. After this first cut has been made, the groove or channel formed should be broadened by chipping away the enamel with chisels, or the enamel hatchets, and the inverted cone bur again used to undermine the enamel upon either side, which is again chipped away. In this way a seat or occlusal step of any required extent is readily formed, the pulpal wall of which will have sharp and definite angles with the surrounding walls.

Grooves that need to be cut out, merely for the purpose of finding a position for finishing the filling, i. e., when there is solid dentin beneath, are to be cut in the same manner with the inverted cone or fissure bur. In none of these cases should any attempt be made to cut the enamel from without inward with the bur. Cutting the enamel with the bur dulls the blades very quickly. After the bur has been used a few times, it should be discarded and a new one employed. The dull bur may be sharpened by the instrument maker.

In squaring out angles of cavities, the inverted cone bur may often be used to advantage in such positions as are readily accessible, as in the occlusal, labial and buccal cavities. Usually this is done by flattening the pulpal wall in occlusal cavities, or the axial wall in buccal or labial cavities. In order to accomplish this with the bur, the approach must be such that the square end of the bur may be placed in the plane of the pulpal or axial wall to be formed, or, in other words, the axis of the hand-piece must be at right angles to the pulpal or axial wall to be formed. Then the side or periphery of the bur is engaged in the deeper part of the rounded pulpal or axial wall, and made to cut toward one of the surrounding walls. This is then repeated in another direction, and the bur is finally carried in a similar way around the whole circumference of the cavity in such a way that its square end leaves the pulpal or axial wall flat, and the line angles with the surrounding walls are made sharp and definite.

In making extensions for prevention in any of the axial

surface cavities, the small inverted cone burs may be used to advantage. If, in excavating proximal cavities, we find that after cutting the gingival wall to sound dentin it is desirable to extend the cavity further to the gingival, place the end of an inverted cone bur, five to eight-tenths of a millimeter in diameter, against the gingival wall upon the dentin, close against the dento-enamel junction, and incline the hand-piece just enough to cause the periphery of the bur to cut, and press it toward and into the bucco-gingival angle; then incline the hand-piece in the opposite direction and press the bur in the linguo-gingival angle. By repetitions of these movements, cut as deeply to the gingival as may be required, keeping close against the dento-enamel junction. This undermines the enamel, which may be easily removed with the enamel hatchets. In extending to the buccal or to the lingual, the enamel hatchets generally serve best, but occasionally the operation is facilitated by starting a small inverted cone bur in the axio-bucco-gingival angle and drawing it to the occlusal, cutting away the dentin of the buccal wall just beneath the enamel, which may then be removed with the enamel hatchet. The same operation is repeated upon the lingual wall.

In this extension, it is important that the bur be kept close against the enamel, so that it shall not cut into the tooth so deeply as to endanger the pulp. There should be no attempt to cut the enamel with the bur, for the reason, first, that it is not easily done, and second, because it ruins the bur. Whenever it is regarded as important that enamel should be cut with a bur, one must expect that the bur will be ruined in the operation. That is to say, the blades will be so dulled that it will be unfit for further use, and a new bur must be provided for the next operation. A good bur will cut dentin, however, for many operations.

In making starting points for packing gold, the smaller inverted cone bur is especially useful. In mesial and distal cavities in nearly all positions, starting points in the axio-gingivolingual angle and the axio-gingivo-buccal (or labial) angle are important conveniences. They are best made by placing the end of an inverted cone bur in the angles named, and by a slight swaying of the hand-piece cause the bur to enter just a little, then draw the bur toward the occlusal (or incisal, if in incisor cavities,) a short distance, making a slight groove leading away from the pit first formed to give strength to the gold when placed. The pit itself should not be directed into the gingival

wall, or only slightly, but to the lingual or buccal (buccal in the incisors and cuspids), and the groove should be close against the axio-buccal or axio-lingual line angle. In this method of cutting these starting points, the square end of the bur gives a square floor to the pit at the point where the first piece of gold is placed, which prevents any tendency of the gold to roll from side to side in the first efforts to condense it, so that a very shallow pit, a mere sharp angle, is all that is necessary. It should be remembered always that in proximal cavities in bicuspids and molars, these convenience points are not anchorage points for the filling, but are simply starting points for the temporary anchorage of the first pieces of gold.

THE DRILL. The use of drills should be confined to certain especial purposes. These should be used when for any reason it becomes necessary to cut into the pulp chamber of a sound tooth, or one that has already been filled. This necessity occurs frequently because of hyperemia or death of the pulp after a filling has been made, or from death of the pulp from a blow or some unknown cause. In these cases it is often necessary to cut from the surface of the tooth to the pulp chamber, either through a filling or through the enamel and dentin. The bur is not suitable for this work. The flat drill, bibeveled to a point, is the proper instrument; or the drill, followed by a round bur to enlarge the opening. In doing this where considerable tissue is to be cut through, it is best to use a small drill first, and when this has penetrated some distance, enlarge the opening with a larger drill or a round bur, then penetrate farther with the small drill and again enlarge. Proceed in this way until the pulp chamber is reached. In the attempt to drill deeply with a small flat drill, the instrument does not clear itself of chips readily and is apt to heat; also, it is likely to be broken by any movement of the patient.

The drill is also the best instrument for enlarging root canals for setting posts or pins for artificial crowns. It will be seen that these uses of the drill are aside from cavity excavation.

THE CONTRA-ANGLE HAND-PIECE, Figure 25, is often useful for doing this work in cavities in the lower second and third molars. With it the proper position of the bur may be obtained in those places that are not accessible to the straight hand-piece. The right-angle hand-piece has been used much in the past for this purpose, but it is a very awkward instrument, for the reason that the working end of the bur is far out of the line of the axis of the hand-piece. This renders it ineffective. The contra-



FIG. 25.

FIG. 25. The contra angled hand piece. This instrument takes the place of the former right angle hand piece. It is properly balanced in the hand by bringing the bar to, or very near to, the line of the shaft.

angle hand-piece remedies this defect. However, this instrument has not the same power and is never so effective as the straight hand-piece, and should not be used in any case in which the straight instrument can be brought into position to do the work. In most cases this squaring out of the pulpal or axial walls to definite angles with the surrounding walls is done just as easily and quickly with the hoes 12-5-6, 12-5-12, or the 8-3-6, 8-3-12, used with a scraping motion. These instruments will reach any of these positions if the surrounding walls have been properly formed previous to their use.

THE USE OF WATER.

Every dental office should have a liberal supply of both warm and cold water. The use of water for the hands of the operator is in itself important, and the wash basin, while not necessarily before or about the operating chair, should be convenient, and in such position that the patient may at least know when the operator washes his hands. Cleanliness and neatness are important in gaining and in holding a practice.

Water should be constantly ready for use at the operating chair for washing the teeth and gums of patients. For use in the mouth, water should generally be heated to about 105 degrees Fahrenheit, or just a little warmer than blood temperature. In the large majority of cases, this temperature will be found most grateful to patients. If, however, cases occur, as they will, in which some of the teeth are very sensitive to thermal changes, the temperature of 105 degrees will cause considerable pain, and in such cases the temperature should be carefully reduced to 98½ degrees, or blood temperature.

Every dental office should be supplied with an apparatus for keeping water at a constant temperature for use at the chair. There are various forms of thermostats in the market that are effective and suitable for use in the construction of these, either for gas or electricity, and manufacturers could furnish such an apparatus, that would be well within the financial reach of the ordinary practitioner. In the use of this, the water may always be ready at the proper temperature for immediate use, saving the annoyance of drawing and mixing hot and cold water to obtain the proper temperature and avoiding many painful errors in using water that is too hot or too cold on sensitive teeth.

The uses of water at the operating chair are:

For cleaning the teeth preparatory to operating.

For keeping the teeth and mouth free from blood and debris

while removing calculus, or in doing any operations upon diseased gums, or while treating diseases of the periodontal membranes.

For washing cavities during any portion of the work of excavating that may be done before placing the rubber dam.

For cleaning the necks of the teeth before applying the rubber dam.

For treating the gums after removing the rubber dam.

For removing debris and polishing powders during any portion of the polishing of fillings that may be done without the rubber dam.

For any and all of these uses a good rubber bulb water syringe, which will hold about four ounces, is necessary. A very small water syringe is a nuisance. A syringe should be used with which the mouth can be flooded with water, or a strong, continuous stream thrown for several seconds.

For cleaning the teeth preparatory to operating, warm water should be used in almost every case, even though the teeth are apparently in a cleanly condition. In the best conditions there is usually more or less gummy material, containing many microorganisms about the necks of the teeth, or about cavities, especially proximal, buccal and labial cavities, which should be loosened up with scalers and removed with a strong stream of water. In very many cases the teeth should be cleaned with a rubber disk and powdered stone and washed clean with a jet of water before anything is done toward excavating cavities. In all cases the field of operation should be made clean as the first procedure.

The use of water while removing calculus is imperative. The field of operation requires to be repeatedly washed with strong jets of water, in order to do both operator and patient justice. This is necessary in order to remove particles of loosened calculus from about the necks of the teeth, and to remove blood and debris that the next step of the operation may be seen. It is necessary to impart a sense of cleanliness and comfort to the patient. During this operation the operator's hands should be washed very frequently.

In excavating cavities, water should be used freely in any portion of the operation that is done before placing the rubber dam. In many cases it is desirable to open cavities and do the rougher parts of the excavating before the dam is applied. During such part of the operation as may be done without the rubber dam, the cavity should be frequently washed with strong jets

of water at the proper temperature, for the purpose of removing all debris from the cavity and from the mouth of the patient.

Before placing the rubber dam, water should be used to free the necks of the teeth from microorganisms, even in the most cleanly mouths. A thin sealer should be passed around all of the surfaces, loosening up any gummy substance adhering to them, and this should be washed away with a strong jet of warm water. If the case is not especially cleanly, there is greater necessity for this proceeding, provided, of course, that this has not been done preparatory to some previous operation at the same sitting.

The object of this care is especially to prevent pushing a mass of microorganisms and debris under the free margin of the gum by the rubber and the ligature. Often the gums are more or less bruised by this procedure, and if at the same time a mass of debris containing many active microorganisms is crowded into the soft tissue and held there for a considerable time, the microorganisms will take hold of this injured tissue, and cause very inconvenient soreness, or actual suppuration. Many incurable cases of phagedenic pericementitis are started in this way.

After removing the rubber dam, the gums should be treated with a thorough douching with warm water while kneading them thoroughly with the fingers of the other hand. This is especially important to the comfort of the patient. The rubber dam has been in place for a considerable time, perhaps for an hour or more, and during this time the free margins of the gums have been tightly compressed by the rubber and the ligatures or other appliances for securing it in place. The circulation of the blood through this part has been impeded. The douching, together with the kneading, causes the blood to return to these tissues, starts it into active circulation again, and removes any poisonous material that may have been forced into the gingival space by the rubber. It imparts a feeling of comfort to the parts and causes at once the most complete feeling of rest from the operation that it is possible for the operator to give.

The washing away of powdered stone and debris during and after polishing fillings, should be thorough and complete, and the patient dismissed with a clean mouth.

INSTRUMENT GRASPS.

ILLUSTRATIONS: FIGURES 26-30.

The manner of holding instruments in performing dental operations is very important, and especially is it important that young men beginning their life work should begin right; that they assume at the start a grasp which will give them power, facility and delicacy of touch. When men have been in practice for some years using a wrong grasp, it becomes difficult for them to change the form of their grasp for a better form. A careful study of the form of grasp used by noted operators, those who have made much more than an ordinary reputation based on their dexterity and power in manipulation, has shown a remarkable uniformity in the grasp of instruments.

THE PEN GRASP, so-called, is the grasp used for the principal part of the work in the excavation of cavities and in placing fillings. But this grasp is made differently by different men; therefore there is the pen grasp in good form, indifferent form and bad form. Wherever much force is to be exerted and yet with great delicacy and facility of movement, the form of pen grasp represented in Figure 26 should be used. Notice particularly that the pulps of the thumb end and the first and second finger ends are upon the shaft of the instrument, so that the full power of all three are used to prevent the instrument slipping when making a powerful thrust. Careful observation of the form of the grasp and power of thrust of many men has shown that on the average men who use this particular form of grasp have nearly one-third stronger thrust than those who use any other form. The form of the grasp shown in Figure 27 gives good facility of movement, but much less power. A careful noting of the difference shows that the instrument crosses the nail of the second finger instead of having the pulp of the finger end on the instrument as shown in Figure 26. The power of the thrust is much less in this second form. Figure 28 shows the worst form possible of the so-called pen grasp. It gives neither power of thrust nor facility of movement. Notice that the fingers are much bent and that the instrument crosses the second finger at the first joint. The power that should be exerted by that finger is almost entirely lost. The fingers are so bent that the range of movement is badly crippled.

THE PALM AND THUMB GRASP, Figure 29, has a limited range of use in dentistry. In this the instrument is grasped in the palm



FIG. 26.



FIG. 27.



FIG. 28.

FIG. 26. The pen grasp, which is the best form of instrument grasp for dental operations. Notice particularly that the bulbs of the thumb and of the first and second fingers are on the instrument shaft.

FIG. 27. A poor form of the pen grasp for the use of force. Notice that the instrument crosses the nail of the second finger. The power of the grasp of the bulb of that finger is lost.

FIG. 28. A very bad form of grasp in which both the power and range of motion are limited.



FIG. 29.



FIG. 30.

FIG. 29. The palm and thumb grasp, in which lateral pressure against the thumb, as a rest, or counter pressure, is used.

FIG. 30. The palm thrust grasp. Used only for making powerful thrusts.

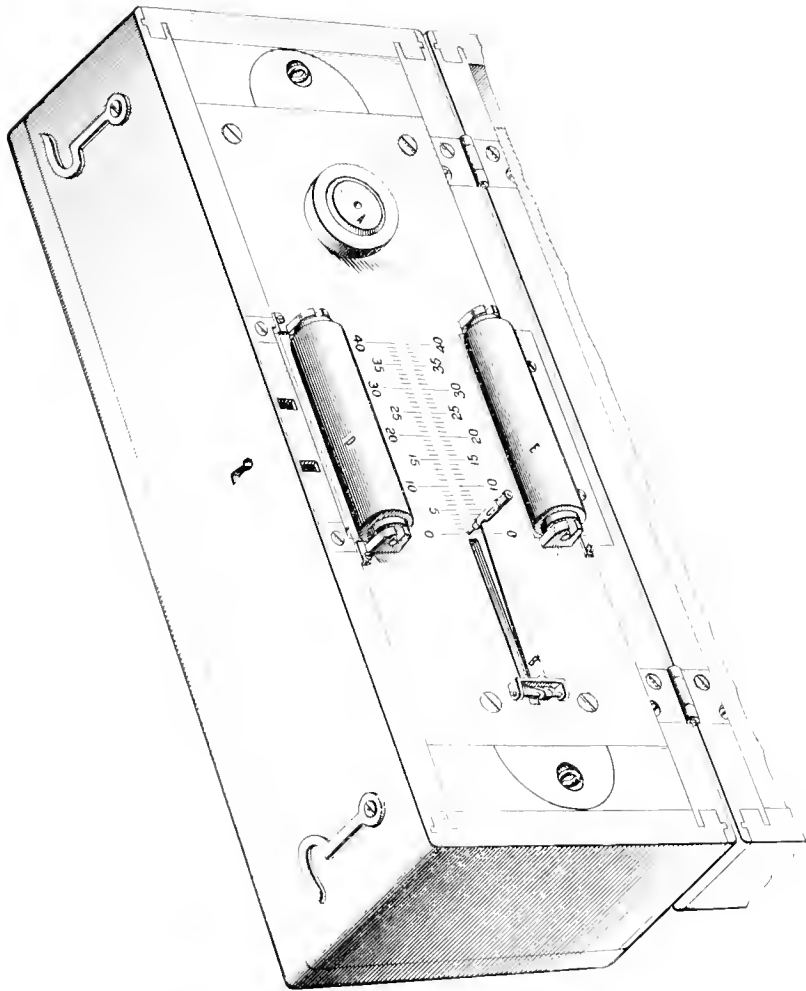

FIG. 31.

FIG. 31. The dentist's manudynamometer, designed by the author. An instrument for weighing the force exerted by an instrument thrust. The scale is in pounds. In use, a paper scale moves across the scale plate and the power exerted in each thrust is registered in pounds, automatically. The thrust is made with the instrument on the block A, and as a result the mechanism causes the bar B, carrying a pencil in its point C, to move over the scale plate, registering the number of pounds. The paper with the painted scale, Figure 32, is placed under the rollers D and E, and is moved to the left automatically with each thrust, making a record as shown in Figure 33. The illustrations of instrument grasps, Figures 26-30, show the instrument in position on the block, also the rollers with paper under them, and the end of the recording bar which carries the pencil.

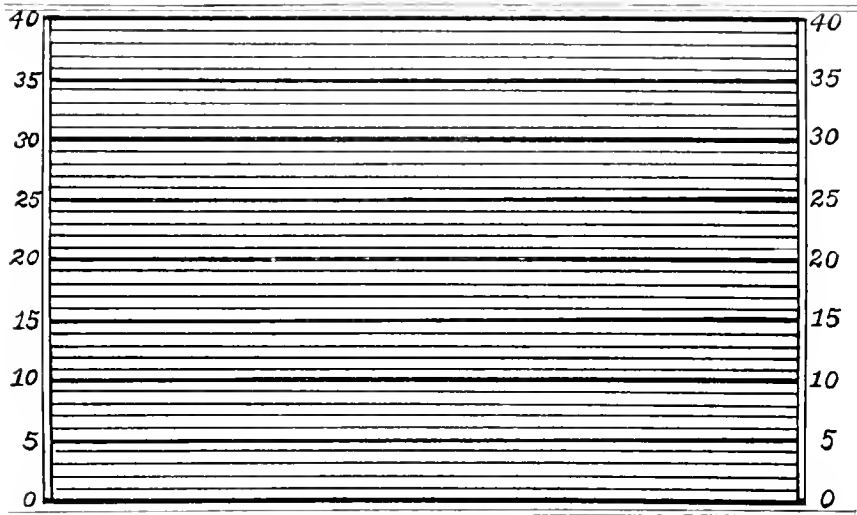

FIG. 32.

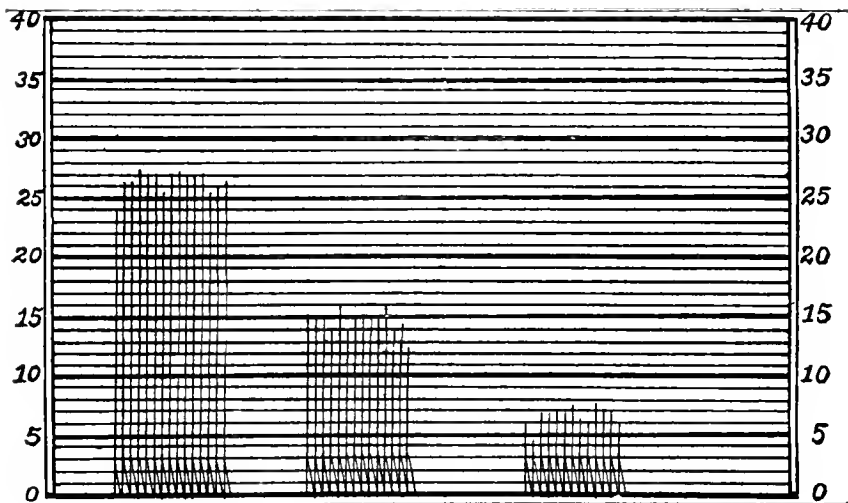

FIG. 33.

FIG. 32. The printed scale used for automatic registration of force exerted on the dentist's manodynamometer shown in Figure 31. The scale is in pounds.

FIG. 33. A specimen of the scale with three registrations of the force exerted by the hand, using the pen grasp.

of the hand and is brought in opposition to the thumb. Its use depends upon finding a suitable thumb-rest in the position of use. This can be done many times in the front of the mouth, particularly in using cleavers in stripping enamel from teeth in preparation for the bands for artificial crowns, and also a limited use of it may be made in filling operations. This grasp should be cultivated by every operator.

THE PALM THRUST GRASP, Figure 30, is now almost obsolete in dental operations. It was much used before the advent of cohesive gold in the heavier work of non-cohesive gold filling. The instruments were made with large handles having a rounded end to rest in the palm of the hand. It affords great power, but is wanting in delicacy of touch or movement. It can not be used to much advantage with our modern instruments, yet on occasions demanding it one may use much more force in a thrust than with the pen grasp. Indeed most men can use as much as three times the force of their pen-grasp thrust. Persons not realizing this may do injury by using too much force when grasping an instrument in this way. It is not suitable for any other movement than the thrust.

FINGER POWER.

ILLUSTRATIONS: FIGURES 31-33.

The power exerted by the pen grasp is directly dependent upon the ability of the person to so grasp the shaft of the instrument as to prevent it from slipping in the fingers. In this the placing of the instrument so that the pulpy portion of the thumb and finger ends grasp it, is of principal importance. Pressure of the instrument on the side of the finger gives some support in movement, but very little increase of power over a grasp with the forefinger and thumb alone. The power of the finger grasp is, of course, the important feature of difference between men. Few persons realize the difference that really exists between persons in this respect. The range of difference between men in power of thrust with the pen grasp runs from five to thirty-five pounds, with the average at about fifteen pounds, as shown by numerous tests made at meetings of dentists. It seems very curious to find large muscular men with feeble finger power, yet a man's general muscular development is no index to his power in handling delicate instruments.

Figure 31 represents the instrument, the dentist's manudynamometer, designed by the author, with which these tests are made. It is a registering spring scale of moderate delicacy,

that is arranged with paper slips, Figure 32, for permanent automatic records. Figure 33 represents one of these record slips bearing the records of three persons of widely different finger power, one of seven pounds, one of fifteen pounds and another of twenty-seven pounds. The highest record made on this instrument with the pen grasp was thirty-five pounds, made by the late Dr. J. H. McKellops, of St. Louis. He took the instrument as nearly as possible as represented in Figure 26, with the wrist and hand bent as shown, as most men will when making the thrust downward, and without haste went across the whole page of the slip with less than one pound variation. If one will think for a moment, he will certainly realize what an enormous advantage the possession of this extraordinary finger power gave him over the average man in doing dental operations, and of the desirability that every dentist cultivate this to the full limit. Much careful observation has shown conclusively that delicacy in the accurate control of instrument movement is very generally an accompaniment of a high degree of finger power.

An experience of over ten years in taking these measurements shows that much increase of finger power, as well as delicacy of movement, can be acquired by careful training, and also that it is easily lost by careless habits. For instance, a class of one hundred and sixty students made an average of nine pounds at the end of their first year, thirteen pounds at the end of the second year, and seventeen pounds at the end of the third year. Some of these same young men fell into careless habits and went backward in finger power. Others gave later tests showing continued gain of power. One young man who left school with a power of only ten pounds and failed to gain anything during his first two years in practice, put himself into careful training in the use of a correct form of grasp and the full use of his power, and within six months made twenty pounds as easily as he had made the ten pounds formerly.

Delicacy of control of movement usually increases with power of movement. Therefore, from all points this training of the hand is exceedingly desirable in dentistry. The training is purely a matter of careful practice with the best form of grasp, so that the full muscular power of the hand is brought into exercise some portion of the time each day. The size of the instrument handle has much less to do with the exertion of force than most persons seem to think. An instrument handle one-fourth inch in diameter is large enough, and three-sixteenths will generally show no diminution. But with anything smaller than

that the power of thrust is rapidly diminished. A larger size than one-fourth inch gives no advantage. This is the rigorous conclusion after witnessing trials of different sizes of instrument handles by many men.

A study of the instrument grasps in the illustrations of finger and instrument positions will do much to enable one to form correct conceptions of them. The positions assumed at the chair are more natural than those assumed in trials on the man-dynamometer. Among these will be found a few illustrations in which the grasp is put at ease as in doing some very light manipulative work. In this the instrument is often shifted to the true pen grasp with the shaft crossing the nail of the second finger.

Ten years of exact observation of the finger power of dentists is not sufficient time to give very reliable historical data of the variations that will occur in averages by practitioners because of different methods of practice with different forms of instruments and varying habits of manipulation. Only a few trials of the power used by men in filling teeth are on record and these are too vague to be regarded as giving definite information. Somewhere the late Jonathan Taft has said that, with the old large-handled instruments used in making fillings with non-cohesive gold, he used as much as seventy-five pounds pressure. He complained that this work was very hard on the muscles of the chest. But the method of weighing was not given. Only a few remarks of this kind can be gathered from our literature. It was common in filling with non-cohesive gold to use the palm thrust grasp, as shown in Figure 30. With this grasp and such an instrument handle, the exertion of such force was possible. Indeed, the full power of the arm could be used. We now know also that such force properly applied would be readily borne by the molar teeth of persons whose habits of chewing food were good. There is much evidence that in the days in which much of filling teeth was done with non-cohesive gold, using hand pressure, and particularly in the latter part of that period when the smaller instrument handles of modern times were used, men exerted much more force than now in filling teeth. That is, fifty to seventy-five years ago. This was continued by many into the cohesive gold work. In my first trials of the registering of the hand force used by men in dental association meetings, I noticed that the older men, who had their first training in non-cohesive gold work, were giving, on the average, the highest records. This has continued, and, as these men drop away, the average of the

records so made has diminished. The diminution of finger power seems to be due to the use of the dental engine in excavating and of the mallet in making fillings. These are both necessary and a marked improvement over former methods, but the excessive use of the engine to the exclusion of hand instruments in the preparation of cavities, is bad; not so much for the reason that power and delicacy of manipulation with hand instruments is not being so well developed, but intrinsically because excessive use of the engine means poor cavity preparation.

Whatever may be the cause, a distinct loss in the average of finger power by dentists, as shown by tests made at society meetings, has become apparent within the ten years that these tests have been made. Fewer men are found who can use twenty pounds pressure with the pen grasp.

POSITIONS AT THE CHAIR.

ILLUSTRATIONS: FIGURES 34-45.

In the training for one's life work in dentistry the positions assumed at the dental chair become a very important matter, and should be considered with great care in order that the best may be done for both the operator and the patient. (1) The position should be such that the operation may be well done. (2) The position should not be especially trying to the patient. (3) The position should be the most comfortable to the operator in each given case that is consistent with (1) and (2). It is obvious that the dentist who expects to stand at his chair during most of the hours of each day, should study positions of reasonable comfort; and also those changes of position that will give rest without interfering with his progress should be studied very closely in the formation of his habits at the chair. Observation has shown men to be in a large degree creatures of habit, and that habits once formed are not very easily changed. Therefore, every young man should give this matter very careful attention as one among the many elements of success.

The modern dental chair needs no description. Many styles are offered in the market, but all the better ones agree fairly well in the essentials of usefulness. All are made to raise and lower as a whole on their pedestals sufficiently for the practical purposes intended, and very many of them may be raised much higher than is ever necessary. The chair should be adjusted (1) to the height of the operator; (2) to the height of the patient; and (3) so that the mouth of the patient shall be level with the lower half of the operator's upper arm (humerus) when stand-



FIG. 34

FIG. 34. Right side in front position at the chair. Upper teeth.



FIG. 35

FIG. 35. Right side behind position at the chair. Upper teeth.



FIG. 36.

FIG. 36. Left side behind position at the chair. Upper teeth. Inverted pen grasp



FIG. 37.

FIG. 37. Left side in front position at the chair. Buccal surfaces of the left upper molars



FIG. 38.

FIG. 38. A position in front and over the patient, in which the operator must look upward and operate with the hands held high. A position to be avoided.



FIG. 39.

FIG. 39. Right side in front position at the chair. Lower molars. The chair is too high. The operator's hands are held up in a tiresome position.



FIG. 40.

FIG. 40. Arranging the chair. The patient's head is too high.



FIG. 41.

FIG. 41. Right side behind position at the chair. Lower teeth. If the patient's head were two or three inches lower, it would be better.



FIG. 42.

FIG. 42. Left side in front position at the chair. Lower teeth. The patient's head is too high. Such a position should not be maintained more than a few moments to do some special thing. See Figure 43.



FIG. 43

FIG. 43. Left side in front position at the chair. A much better position than that shown in Figure 12, for operations on the buccal surfaces of the left lower molars.



FIG. 44.

FIG. 44 Left side behind position at the chair. For operations on the occlusal surfaces of the right lower molars.



FIG. 45.

FIG. 45. Left side in front position at the chair. Lower teeth. An excellent position for some things, particularly on the occlusal surfaces of lower molars with a strong lingual inclination.

ing upright with his elbow at his side. The range of one-half of the humerus will be quite sufficient for all ordinary operations in any part of the mouth. Only a few things out of the usual order may require different positions.

Adjustments of the patient must be made to facilitate operating at this particular height. If the patient is to sit upright for operations on the lower teeth, the chair will be correspondingly low. If, on the other hand, the chair is thrown far back for operations on the upper teeth, this movement brings the patient's head lower, and the chair should be raised to correspond in order that the field of operation may come to the proper height. The patient's head must be turned to one side or the other, to bring the particular part of the mouth desired into view, so that operations may be performed easily. If the field of operation is too low, too much bending of the back is required. If too high, the arms must be raised. Either one of these positions becomes tiresome to the operator, but of the two, holding the hands up is much the more tiresome, and will break the man down faster. The object is to find those positions in which the operator can work many hours with the least fatigue, month after month for years together. This is of especial importance from the point of the continued health and endurance of the dentist.

Otherwise than height there are four positions of the operator at the chair which are best defined as: (1) Right side in front, Figure 34 for the upper, and Figure 39 for the lower teeth. In this position both of the operator's hands are at the front or side of the patient's mouth without passing the left arm around the patient's head. In each case the position is defined by the position of the operator's hands rather than the actual position of his person. (2) Right side behind, Figures 35, 41. In this position the left arm is passed around or over the head of the patient. (3) Left side behind, Figures 36, 44. The right hand is around or over the head of the patient. (4) Left side in front, Figures 37, 45. In this both hands are in front of the patient on the left side. These four positions for the upper and four positions for the lower teeth, form the basis for all definitions of the operator's position at the chair. In the exhibit of finger and instrument positions in which the hands and a part of the face only are shown, the actual position of the operator will be easily read. Besides the instruction in position, it affords a language, or nomenclature of positions which may be of especial use in all teaching, whether in school or society work.

In the group of pictures several have been selected that are

out of good form, for the purpose of calling attention to errors frequently met with among students and in offices. Some desirable positions could not be so photographed to show them properly. Further, it will be obvious that the illustrations could not include everything desirable. Figure 34 shows a very easy and comfortable position for doing many things of the lighter sort for the upper teeth of the right side. Figure 35 shows the head of the patient just a little too high and the operator's arms raised too much as a consequence of this error. With that corrected, by dropping the chair a little, it is the position in which to do the greater bulk of operating upon the upper teeth. In many cases the position and the work will be rendered easier by turning the patient's head over to one side or the other in order to reach certain positions easier.

Figure 36 gives a position of left side behind which, as a change and rest from that given in Figure 35, enables the operator to do some part of the same operation with the inverted pen grasp. This grasp is well shown in Figure 55, with the third finger resting on the upper teeth. Operations that do not require much finger power should be chosen for this grasp. The operator may step around the chair for a little while, change the position of the head of the patient a bit, for the rest and comfort it will be to both during a tedious operation.

Figure 37 gives a very easy and comfortable position on the left side in front for doing considerable of the excavating and filling of buccal surfaces in the upper bicuspids and molars of the left side, and also for doing certain things in distal cavities in these teeth. The difficulty operators will find at first in this position is the holding of the upper lip out of the way with the third and fourth fingers of the right, or instrument, hand while also using the instrument. A little experience will overcome this.

In Figure 38 is a position that is decidedly undesirable. Perfectly good fillings can be made, but it is a position that wears out strong men with great rapidity. This is because (1) of the stretching the arms upward in long, tedious operations; (2) the head of the operator is held too high and there is a constant tendency to stretch the eye open too wide, to relieve the muscles of the neck; (3) the position is very undesirable because of the relative position of the operator and patient; (4) the natural position to assume is looking downward at the work, not upward, and one tires much more in any position where this is required. In assuming such positions any man does himself a wrong and injures his usefulness.

Turning now to the lower teeth, Figure 39 shows a position which, when corrected by dropping the chair a few inches lower, is excellent for doing much of the work of excavating and filling cavities in the teeth of the right side of the lower jaw. The face of the patient is turned rather too much away from the camera to show the left hand, which is holding the lips away. It is a position that should be carefully cultivated. In Figure 40 the operator has run the chair up too high so that he could not well assume the desired position of right side behind. The patient is also tilted too far back. This is in part corrected in Figure 41 by turning the chair forward and lowering it. But it is still a little too high for easy operating. A few inches lower would give an easier position. When thus corrected this is the best position for the greater amount of operating on the lower teeth. The head of the patient should always be so well forward that the light will fall full upon the lower teeth. This position will depend somewhat upon whether the source of light is a high window or a low one. The angle of light, when from a high window, will allow the head of the patient to be farther back, and relieve the operator from some of the bending of the back required when the source of light is low.

While this position has the widest range of usefulness for operations on the lower teeth, every operator should be able to relieve tired muscles by changing occasionally. For the teeth of the left side, the position shown in Figure 42 may be used temporarily for some part of the work, but this is not good for any considerable work at one time. The position in Figure 43 is better and can often be very effectively used for operations in the buccal surfaces of the lower bicuspid and molars of the left side, when one has learned to hold the tissues away in part with the unemployed fingers of the instrument hand. Figure 44 is the true left side behind position. This gives a very desirable position for operations in the occlusal surfaces of the lower molars of the right side, when these teeth have not too much lingual inclination. It is especially a favorable position for the use of great force, when that is required, in chipping enamel from the buccal walls of cavities in these teeth with the straight or binangle chisel, for various things in excavating, and for a part of the packing of gold. Figure 45, the full left side in front position, is especially useful for distal cavities in the lower incisors and cuspids, and for buccal cavities in the bicuspid and often also in the first and second molars.

From the foregoing statements it is seen that one may work

practically all around his chair, finding favorable positions to do particular things, and also positions that bring other muscles in play to relieve those that are tired, contributing to comfort and health while continuing needful operations.

FINGER POSITIONS.

ILLUSTRATIONS: FIGURES 46-61.

In considering positions at the chair and finger positions, it is necessary in the first instance to use full length illustrations. But in these it is impossible to give with much definiteness the finger positions in the use of instruments because the pictures are too small. In this subject the use of rests for the instrument hand is to be considered, and also the use of the left hand in holding the tissues away, thus aiding the right hand by exposing the field of operations to view. Occasionally also the left hand should aid the right hand more directly by guiding the instrument point with a finger. The guiding by a finger of the left hand is often a very important item in accurate operating. It must not be forgotten, however, that a considerable part of instrumental work in the mouth should be done by the free hand without any rests whatever. Rests, however, are to be sought continually, for with a good finger rest the hand becomes very much steadier than it can possibly be in free-hand work. This is important in many positions in which an instrument is liable to slip and do damage. If there is a good finger rest, such slips are very much better under control than if the finger rest is not used. It must not be forgotten, however, that finger rests always limit freedom of motion in an important degree and in this respect are bad. A dentist should do much of his work without them.

A finger rest, to be reliable and definite, must be upon the teeth of the same jaw with the tooth operated upon. At least, this is much the best finger rest. In any effort to rest the finger upon the teeth of the opposite jaw, the movements of the jaws are apt to derange the relative positions of the instrument and tooth. Finger rests upon the soft tissues are very much less reliable than finger rests upon the teeth, and yet they may often be used to advantage, particularly if the rest can be made on portions that are not movable, or where the bones are but thinly covered with tissue. However, a rest upon the face will generally come upon the opposite jaw and the movements of the patient are apt to disturb it seriously. Such rests must always be reckoned as unreliable.



FIG. 46.



FIG. 47.

FIG. 46. Finger position, for right upper molars. Finger rest on soft tissues. Right side in front position at chair.

FIG. 47. Finger position, for right lower molars. Finger rest on lower incisors. Right side in front position at chair.



FIG. 48.



FIG. 49.

FIG. 48. Finger position for buccal surfaces of the lower molars of the right side. Notice the third finger resting on the lower teeth. Right side in front position at chair.

FIG. 49. Finger position for upper bicuspids of the left side. Notice that the forefinger of the left hand is guiding the instrument point. Right side behind position at chair.



FIG. 50.



FIG. 51.

FIG. 50. Finger position, the same as in Figure 49 but without the rubber dam. Notice carefully the instrument grasp. Right side behind position at chair.

FIG. 51. Finger position. Starting a filling, using a holding instrument with the left hand. Notice that the third finger of the left hand is holding back the rubber dam and the upper lip. Also that the right hand has grasped the instrument so that it crosses the nail of the second finger, a grasp suitable to light work only. The finger rest is on the upper teeth of the left side. Compared with Figure 50, the right hand is turned over. Right side behind position at chair.



FIG. 52.



FIG. 53.

FIG. 52. Finger position for operations on the occlusal surfaces of the lower molars of the left side. The forefinger has crossed the arch and is holding away the tongue. Right side behind position at chair.

FIG. 53. Finger position for use of the straight hand-piece of the engine in the buccal surfaces of the lower molars. Notice that the third finger of the right hand is resting firmly on the gum holding away the lip and the point of the instrument crosses over it and is at work to the mesial of the finger end. Right side behind position at chair.



FIG. 54.



FIG. 55.

FIG. 54. Finger position for operations, especially with binnacle chisels, in opening cavities in the occlusal surfaces of the lower molars of the right side. Left side behind position at chair.

FIG. 55. Finger position, using the inverted pen grasp. Suitable to a few things only. Left side behind position at chair.



FIG. 56.



FIG. 57.

FIG. 56. Finger position suitable for some operations on the buccal surfaces of the upper molars. Notice the instrument grasp and the finger rest with the back of the third finger. Left side in front position at chair.

FIG. 57. Finger position suitable for reaching certain positions in distal cavities. Left side in front position at chair.



FIG. 58.



FIG. 59.

FIG. 58. Finger position for operations on the buccal surfaces of the lower molars. Left side in front position at chair.

FIG. 59. A cross mouth finger position suitable for doing some things on the lingual portion of the left upper molars. Right side behind position at chair.



FIG. 60.



FIG. 61.

FIG. 60. A cross mouth finger position that is often important in cases in which the lower molars have a strong lingual inclination. Left side in front position at chair.

FIG. 61. A cross mouth finger position by which the lower molars on the left may be reached. Right side behind position at chair.

In some degree, rests are shown in the illustrations, though this has not been an especial object. In this group of illustrations, the position of the operator at the chair will be indicated by the position of the right or instrument hand and of the left in exposing the field of operations. The positions of both the hands should be carefully studied. When both hands are on the right side of the face, the position of the operator is to the right side in front. He could not stand elsewhere and use his hands in the positions shown. When the right hand is on the right side of the face and the left hand on the left side, the positions of the hands will readily indicate the position of the operator, although the right hand is on the right side and the left hand on the left side in both the right side behind position and left side behind position. In the left side in front position, both the hands of the operator are on the left side of the patient, or reaching across from the left side. Observing the hands carefully will always indicate the relative positions of the operator and patient.

RIGHT SIDE IN FRONT. UPPER TEETH. Figure 46 illustrates a common position when operating upon the upper molars of the right side, especially in opening cavities with a chisel, or with the enamel hatchet, also in doing various other things upon the occlusal or proximal surfaces of these teeth. It is a position to be used in very many cases. The left hand exposes the field of operation easily, while the right is free in the handling of the instrument. Generally the rest is not a good one for it must be on the soft tissues of the lower jaw, and is necessarily an unreliable rest for that reason, but it is the only finger rest that can be had in this position. The effort to rest the fingers on the lower teeth would be just as bad as the rest shown in the illustration. It is an excellent position for free-hand manipulation in the use of the chisel, or other cutting instruments, and in packing gold. With the patient's head well back and the chin well up from the patient's breast, the position is very easy and should be much used in the operations in the occlusal and proximal surfaces of the molars of the right side.

RIGHT SIDE IN FRONT. LOWER TEETH. The approach to the lower molars of the right side is much easier from the right side in front than from other positions for the reason that it brings the left hand in good position to expose the field of operation to view. This is very well seen in Figure 47, illustrating the use of an enamel hatchet with a half inverted pen grasp. (See Figure 55.) As the operator would ordinarily stand in using this position, his person would be between the field of operations and the

camera. Changed to that position, the instrument hand would be much less bent, though the position as shown is very good for many operations. The third finger of the instrument hand is on the lower incisors, which gives a very secure rest. For heavy cutting with the enamel hatchets the operator should stand more to the front, bring the right hand and fingers nearly straight, the palm down, third finger on the incisors and the thumb of the left hand well under the body of the lower jaw, while the fingers expose the teeth as shown. Then the full power of the hand can be exerted and the control of the instrument is as perfect as it is possible to make it. This position, with its variations, is the best for very much of the work on the lower molars of the right side. Some of the operating upon the lower right bicuspid may also be done in this position, but as the front of the mouth is approached, the right side behind becomes the better position.

A modification of this position, such as is shown in Figure 48, is especially good for much of the work on the buccal surfaces of the lower teeth. Notice in this that the third finger is resting on the lower teeth, affording a very steady and secure rest, which gives great steadiness to the instrument hand.

In both of these positions it should be particularly noted that the head of the patient is upright and the chin is down. If the patient's head is inclined a little to the left side, it will usually make the position easier for the operator when working in buccal surfaces. These positions on the right side in front should be much used for operations on the lower molars. They afford a very great variety of modifications for reaching various positions easily. When the patient's head is properly adjusted to height, the position is very restful after long confinement in some other position, such as the right side behind.

RIGHT SIDE BEHIND. UPPER TEETH. The position, right side behind, is the most important of all of the positions assumed at the dental chair. The operator can reach more varied points and do more things than from any other position. This finger position is shown in Figure 49 in the use of a binangle chisel opening a cavity in the distal surface of an upper second bicuspid. Note particularly that the left hand is passed over the head of the patient, the fingers exposing the bicuspid or molar teeth of the upper jaw. The thumb of the left hand is holding the tissues away, while the forefinger, resting upon the teeth lightly, is guiding the point of the instrument, rendering the operating more precise than could be done with the free hand alone. In this position, only an imperfect rest may be had by the fingers

of the instrument hand on the tissues of the lower face, and yet the position is a good one for the beginning of the opening of cavities, or in packing gold or other instrumentation in the bicuspids or molars in either the proximal or occlusal surfaces. This picture shows the position of the second finger in the instrument grasp to advantage. Notice particularly the instrument grasps in all of these illustrations. In this particular picture, the grasp is very well seen, though the instrument hand is not in sharp focus. In Figure 50 the rubber dam has been removed to show the grasp and the position of the fingers more definitely than could be done with the rubber dam in position. It also shows the use of a chisel in opening a distal cavity in a bicuspid. Often the position may be changed so as to turn the right hand partly over, and bring the third, and sometimes the third and fourth fingers, upon the upper teeth, forming a rest. That can usually be done if the instrument can approach its work upon an angle a little more from the front of the mouth.

This is shown in Figure 51 in the representation of the use of two instruments in starting a filling in the mesial surface of a second bicuspid. The left hand is holding the tissues away with the second and third fingers, and also holding the holding instrument principally with the thumb and first finger, but it lies across the second finger as well. This holding instrument is so formed that, when placed, only light pressure is needed to keep it steady. The use of a left-hand instrument should be carefully cultivated by every operator. The right hand has the third finger resting upon the upper teeth of the other side of the mouth, giving great precision in the use of the plugger point. In this notice that the plugger crosses the nail of the second finger, a grasp that is unsuited for heavy pressure, but may often be used well with mallet pressure, or anything in which light pressure only is to be used.

Positions quite similar to these last three may be used almost all around the mouth in the upper jaw, the patient's head being thrown well back, as shown in these illustrations. The patient's head should often be turned this way or that to gain better positions. The right side behind is the position for the largest amount of operating in either the upper or the lower jaw.

RIGHT SIDE BEHIND. LOWER TEETH. In Figure 52 we have very nearly the most usual position for operations upon the lower molars of the left side. It is exactly the position that should generally be had in introducing a broach into the distal root of any of the lower molars upon the left side of the mouth.

For this use of the broach in any of the lower molars that stand normally in the arch, the shaft of the instrument should cross the upper teeth at about the median line, when the mouth of the patient is thrown widely open. The broach will then glide evenly and smoothly into the canal of the distal root. On the right side the position would be the right side in front with the instrument handle crossing the incisors at the median line. If any of the lower teeth are inclined much to the lingual, the better position will be over the lateral incisor, or even the cuspid of the right side of the upper jaw to the molars of the left side, making it almost a cross-mouth position. Notice particularly the position of the fingers of the left hand in exposing the parts to view, a position that is found an excellent one, for, if the field of operation is not too far back in the mouth, the forefinger of the left hand may pass across the teeth and keep the tongue out of the way, while the second finger and thumb control the lips. This position with its modifications, which are very numerous, is the position for the greater amount of instrumental work upon the teeth of the left side of the lower jaw.

Figure 53 illustrates a finger position and form of grasp that will be found very excellent for the use of the engine in the buccal surfaces of the lower teeth of the right side. Most operators will find it difficult to obtain facility in the use of this position and grasp without considerable practice. This is most suitable for work with the straight hand piece, for by its use we may place the square end of a bur against the axial wall of a buccal cavity and make such extensions as may be necessary to the mesial and to the distal, preserving the flat form of the axial wall. This can be done as far back as the second molar usually, and, in some cases, even to the third molar. Of course, this class of cutting must be done before the rubber dam is placed, or at least without a clamp in such a position as to interfere. It will be noticed that the end of the third finger has drawn the lips back and has found a rest upon the teeth, or upon the gums, to the distal of the tooth operated upon. The instrument point is passed across the finger and is operating to the mesial of the finger end.

When this position and grasp are once well learned, the operations are easily done, provided the position is not continued too long, and generally there will be no necessity for holding it more than a few minutes at one time, as the work is accomplished very quickly.

A position very similar to this may also be found for using the engine in cutting gingival third cavities in the buccal surfaces

of the teeth of the left side of the mouth, the operator standing to the left in front. By the use of these positions, the necessity for the contra-angle hand piece is very much diminished. In fact, that instrument should rarely be used in buccal cavities.

LEFT SIDE BEHIND. LOWER TEETH. Turning now to Figure 54, we find a most excellent position for operating upon the occlusal surfaces of the lower molars and bicuspid of the right side. In opening cavities particularly, this position is especially good when the teeth are not inclined too much to the lingual. It is often an excellent position for packing gold. It will sometimes happen that a lingual inclination of the teeth will defeat any effort at operating in the position shown. Generally in the molar teeth the cutting of the enamel away from the buccal side of a cavity with the chisel will be best done from this position, while the lingual side will be cut more easily from a position to the right side in front, using the enamel hatchets. In this case, the right side in front will give the left hand a better position for exposing the field of operation to view. This position is shown in Figure 47. Sometimes in this work a position on the left side in front, with the patient's face turned toward the operator, will give the left hand a much better position in which to both expose the field of operations and support the lower jaw.

LEFT SIDE BEHIND. UPPER TEETH. In Figure 55 is represented a position obtained on the left side behind, which is occasionally useful. In this the inverted pen grasp is illustrated particularly. The instrument point is directed in almost the opposite direction from its usual position by the bending of the fingers. Hence the term, inverted pen grasp. The grasp may be considerably varied to suit different positions. Notice that the third finger is on the upper incisors, forming a rest that is safe and the control very accurate for doing any delicate thing in operating, while the forefinger of the left hand, with the first joint sharply bent, is holding the tissues away. It is easy to expose the teeth much more perfectly than is shown in this picture by holding the lower lip away with the second finger, or by holding the upper lip with the thumb and the lower lip with the first finger. In using this position as shown, the head of the operator, in order to see the progress of the work, would generally be between the camera and the instrument hand. The grasp is not one of great power, but one in which very accurate work may be done after a little practice. Positions calling for its use are not very frequent.

LEFT SIDE IN FRONT. UPPER TEETH. Figure 56 illustrates a

position for operations on the buccal surfaces of the upper teeth of the left side. In this, note that there is a finger rest upon the bones of the cheek that is very good, and the grasp is one giving great power. When this position has been used considerably, it is found to be excellent for much of the excavating and also of the filling in buccal cavities. In this position the left hand exposes the field of operation very conveniently. Positions of this kind should be very carefully cultivated. To persons who have operated only from the right side behind, as some do, such positions are at first very awkward.

In Figure 57 is shown a method of reaching the distal surfaces of the upper bicuspids of the left side, and occasionally the distal surface of the first molars may be reached in a similar way. The reaching of these from this position is important in both excavating and the introduction of the filling in many of the very large cavities in the distal surfaces of these teeth, in which the enamel of the buccal surface has been so undermined by caries that it must be cut away; but only for a part of the operation, however. The bulk of the operation is done from the right side behind. It is only those portions of the operation where it is required to cut from the buccal portion of the cavity, or to condense gold from that position.

LEFT SIDE IN FRONT. LOWER TEETH. Figure 58 represents a position somewhat similar to that shown in Figure 57, for operations upon the buccal surfaces of the lower molars and bicuspids. Frequently most of the operations upon these may be done from this position more conveniently than any other. When the position has been assumed often enough for the operator to become familiar with it, it is found to be excellent, and a great relief from continuous standing at the right side behind.

CROSS-MOUTH POSITIONS. Occasionally it is necessary in doing some things that take up little time and require no great force, to work across the mouth in what may properly be termed "cross-mouth positions." Generally it is impossible to use the full force that may be used with the instrument in other positions, because it must be grasped so far from its point. This is illustrated in Figure 59. The finishing of fillings and various points in the cutting of cavities is occasionally facilitated by assuming this cross-mouth position. It may be used anywhere on the lingual of the bicuspids and molars of the upper jaw. Occasionally, when it is used upon the right side, the operator will stand to the right side in front, or upon occasion on the left side in front, but for positions on the left side, the operator need not

change his position; but may change the position of the patient's head to gain a better view. It is not a suitable finger position for doing any considerable amount of operating.

In Figure 60 is shown another cross-mouth position, in which the grasp of the instrument comes out very clearly, the instrument reaching across the mouth to the occlusal surface of the lower molars on the opposite side. The left hand, it will be noted, is in an excellent position for exposing the field of operation, and it steadies the lower jaw by its grasp on the teeth with the third and fourth fingers under the chin. On lower molars that have a very strong lingual inclination, this position becomes very important in some parts of the operation of condensing gold, also in some parts of the operation of chipping enamel, and various portions of the work of excavating. The position may be changed frequently with other positions, especially a position on the right side behind for the use of enamel hatchets. By turning the patient's face sharply toward the operator, very much of the work in occlusal and mesio-occlusal cavities may be done from this position. The principal objection to it is the long reach of the instrument.

In Figure 61 we have the opposite cross-mouth position, in which the instrument reaches across from the right side to the teeth on the left side of the mouth, which is used for similar purposes and can be assumed at will without particular change of the position of the operator from the usual one in operating upon these teeth. It is only a change in the position of the hands, for in operating on the left side of the lower jaw, the position on the right side behind will be the better position for general use; and the instrument hand of the operator will vary according to the necessities of the case. In the few cases in which cavities occur in the lingual surfaces, facility in the use of cross-mouth positions becomes especially important. In some of these, the entire operation must be done across the mouth.

The few finger positions and finger rests illustrated will afford much opportunity for forming variations of the cases shown to suit the varied conditions that are presented in practice.

In these suggestions of finger positions, no pretense has been made of illustrating, or even mentioning, all of the better positions. The object has been to give such notice of this subject of positions at the chair and of finger positions as will be something of a guide in the search that each student or dentist may make for convenient finger positions and rests to serve him in cases as they appear in practice. They should be carefully

sought, first, to the end of accomplishing the operations easily and expeditiously, and, second, for that change of position of the relation of the operator to his patient that will be a rest to his muscles as he continues at the chair hour after hour. One of the great difficulties in dental practice has been the confinement of the operator to one position for long intervals at a time, in this way tiring out certain sets of muscles, which comes to be very wearing upon the whole nervous system. This tends to break down the operator prematurely, while the frequent changes of position that may be had by seeking favorable finger positions in other than the principal position for the operator, which is the right side behind, bring movement and rest and keep the operator in a condition very much better fitted for prolonged service at the chair. It has been the observation that many of those who stand in unfavorable positions steadily without much change about the chair, tend to break down much earlier than those who are moving from position to position frequently. The introduction of the fountain spittoon in the form that gives it a permanent position in the left side of the chair, has been serving to limit the positions of the operator much more than it should. If the spittoon is so arranged that it is easily pushed aside for the moment, allowing the operator to assume the position of left side in front upon occasion, it should not interfere with these movements. Such an arrangement should always be selected.

Heretofore we have had no nomenclature of this subject or any systematization by which discussion of it could be had. Generally in teaching operative dentistry, or in writing, the subject has been passed almost without notice. The definitions of positions introduced here should enable students and teachers to understand each other better than heretofore and discussion should do much good in amending bad positions which cause needless wear to both operators and patients. This whole subject should be very closely studied for the benefit of all concerned.

THE RUBBER DAM.

ILLUSTRATIONS: FIGURES 62-99.

THE rubber dam is a thin sheet rubber used for the purpose of keeping any field of operations on the teeth clean and dry; also for keeping the field aseptic when that is required. This latter is desirable when treating or filling the roots of teeth. In use, a piece of the rubber of suitable size for the purpose is cut or selected and holes much smaller than the teeth punched at proper positions. These are stretched over each of as many teeth as may be necessary. The rubber draws tightly around the necks of the teeth and becomes moisture tight, if well arranged. Then so many teeth as are in this way exposed can be kept clean and dry for any desired operation. This is essential in all filling operations, in all treatments of the pulps of teeth, or in the treatment and filling of root canals. The rubber is furnished by the dealers in several grades as to thickness. Generally, a medium thickness is to be preferred. If of good quality, it is very elastic, tough and strong.

PREPARATION FOR PLACING THE RUBBER DAM. Teeth upon which the rubber dam is to be placed should be clean. This should always be looked to carefully as the first step preparatory to placing the rubber dam. Especially any accumulations about the margins of the gums should be carefully removed. Often these accumulations are composed mostly of microorganisms, and, if they are not removed, will frequently be pushed under the free margin of the gum in placing the rubber dam. Then, with some bruising of the soft tissues that often occurs, there will be infection and inflammation; and in some instances suppuration following. This is caused by forcing microorganisms into the bruised tissues, and should always be avoided by careful cleaning. Especially great care should be had to clean the interproximal spaces. This is most easily done with the ligature. The ligature should first be passed between the contact points to determine whether or not there will be any difficulty in passing them with the rubber dam. While this is being done, the space may be well cleaned with the ligature. In many cases where it is desirable to place the rubber dam, there is more

or less decay, with sharp edges of broken enamel margins which will cut the ligature, and which will be liable to cut the rubber also. In any such case, the sharp edges should be found and so cut away with a chisel that they will not interfere with the work of placing the rubber dam. When this cleaning and examination have been satisfactorily done, the parts should be flooded with tepid water as the final step of the cleaning.

PREPARING THE RUBBER DAM. Cut or select a suitable piece of rubber dam for the case. If it is for the upper incisors, a piece of the size and form shown in Figure 62 will answer. There should be enough rubber above the holes to fully cover the upper lip, but it should not cover the patient's nostrils. Below the holes there should be enough to cover the lower lip and chin. To the sides there should be enough to give good room to place the rubber dam holders to stretch it back out of the way. If, in any case, the part covering the upper lip should be a little long and interfere with the breathing by covering or partly covering the nostrils, it should be cut away with the scissors.

The cutting of the holes for the teeth is done with the rubber dam punch. It is very important to have these in the right position and the proper distance apart. The rubber should generally be placed over two or more teeth to either side of the one to be operated upon, if in the front of the mouth. If it is the central incisor, the rule should be to expose the six front teeth. If the tooth is to the side, an equal number of teeth to each side should be exposed. If it is a bicuspid or molar, one tooth to the distal and two or three to the mesial should be exposed. Special conditions will often require deviations from these rules. In individual cases there may be missing teeth, bridges, etc., that will interfere and make something different necessary. The cutting of the holes will depend in part upon conditions of interference with the ordinary rules of procedure.

When the holes have been cut and the rubber dam placed, it should lay smoothly without wrinkles or drawing. The distance apart of the holes and their relation to each other, whether in a curved line or otherwise, must depend upon the individual case. For the incisors and cuspids in the normal arch, the holes should be in an arc of a circle somewhat larger than that described by the arch, as shown in Figure 62. This will cause that part of the rubber covering the roof of the mouth to be loose and it will be apt to lay well up against the tissues out of the way in doing any necessary work upon the lingual sur-

faces, or in using the mouth mirror. To serve this purpose, the holes should be cut slightly farther apart than the whole width of the teeth over which the rubber is placed. The holes should be of a size to hug the necks of the teeth tightly, but not so small as to endanger the rubber by too severe stretching in getting it over the teeth. Further, when the rubber is in place, the septum of the rubber between the holes will be stretched much more than any other part, and, unless there is much more width of it than at first glance would seem necessary, it may be too narrow to hug closely around the necks of the teeth and leakage will result. This will occur whenever the holes are cut too close together, which is a very common error. In case of the lower incisors, it is often necessary to cut the holes so far apart as to cause just a little wrinkling of the rubber in order to have the septum of rubber between the teeth broad enough to make it tight. The necks of these teeth are much the broader from labial to lingual, and their mesial and distal surfaces are often very nearly flat. It is therefore often difficult to make the dam water tight. It will not be water tight unless the space between the holes is broader than the teeth. The bicuspid often offer a similar difficulty. This is to be remedied by cutting the holes a little farther apart than the mesio-distal breadth of the teeth. Therefore, the rule should be to cut the holes as much farther apart than the mesio-distal breadth of the teeth as can be done without causing the rubber to wrinkle. If in any case the proximal surfaces are very flat, it is better to overstep this a little, a slight wrinkling of the dam being better than leakage.

In case there are special conditions, the position of the holes in the rubber dam must be varied to meet them. For instance, Figure 63 illustrates the position of the holes for a case of some recession of gum with decay far to the gingival on the buccal surface of an upper first bicuspid, on which it is intended to set a Hatch clamp. Notice that the hole intended for the first bicuspid is a little out of the line of the arch. If this were not so, by stretching the rubber to the gingival enough to expose the cavity it is likely to be pulled away from the cuspid and second bicuspid and cause leakage. (See Figures 97, 98, 99.) In other cases, the positions of the holes must be varied to meet the conditions; as when teeth are very irregular in the arch or the rubber is to be stretched this way or that, a tooth missing, etc. Forms for other parts of the mouth are shown in Figure 64 for the lower incisors and Figure 65 for the bicuspid and molars, upper or lower. Notice particularly that in Figure

64 the longer reach of the rubber is toward the upper lip instead of the lower as in Figure 62. The reason for this is sufficiently obvious. A broader reach of the rubber in that direction is essential to cover the mouth. It should be distinctly understood that the primary and principal object of the rubber dam is to keep the field of operation dry and clean, and it should reach far enough in every direction to do this. When this has been accomplished, more is a nuisance. It requires only good reasoning with sufficient care in practice to arrange the positions of the holes correctly for the case in hand. While, in general, two teeth to either side of the one operated is best, and all things considered, most convenient and most cleanly, there will be many cases in which one tooth to either side, as in Figures 97, 99, will be most available. Yet the former should be the rule. To undertake to operate with only one tooth exposed, is generally a bad arrangement.

When the first molars are operated, the rubber should always include the second. Generally, when the second molar is operated, the third molar should be exposed. When any of the bicuspids are operated, the rubber dam clamp should be on the first molar, etc.

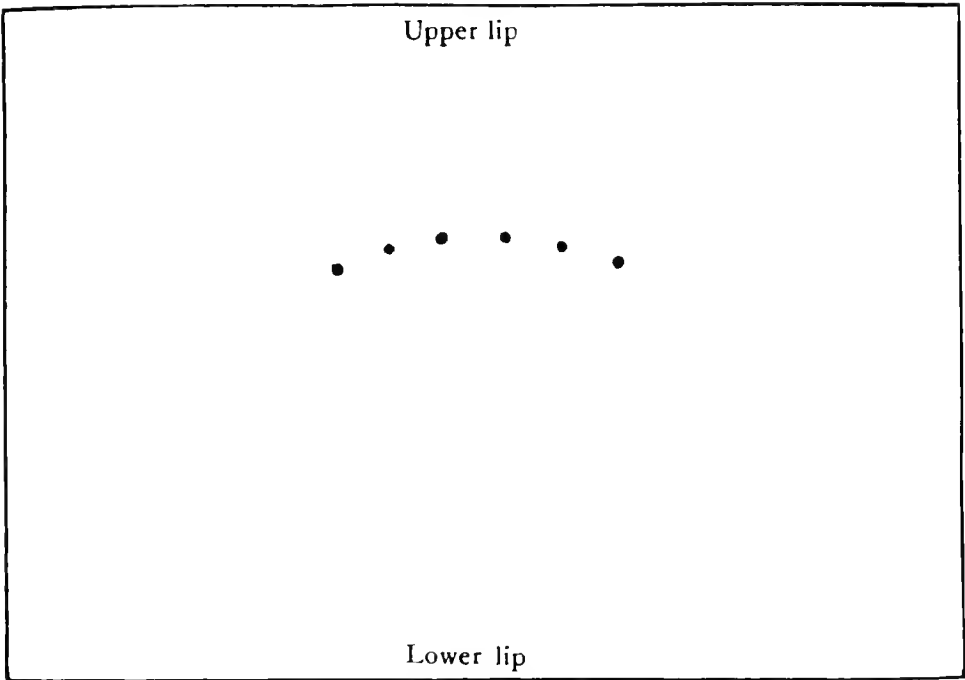

FIG. 62.

FIG. 62. A diagram representing a sheet of rubber dam of suitable size, with the holes cut the proper size and distance apart, and in the position suitable for placing it over the six upper front teeth. The edges covering the upper lip and the lower lip are marked. These proportions should be carefully observed.

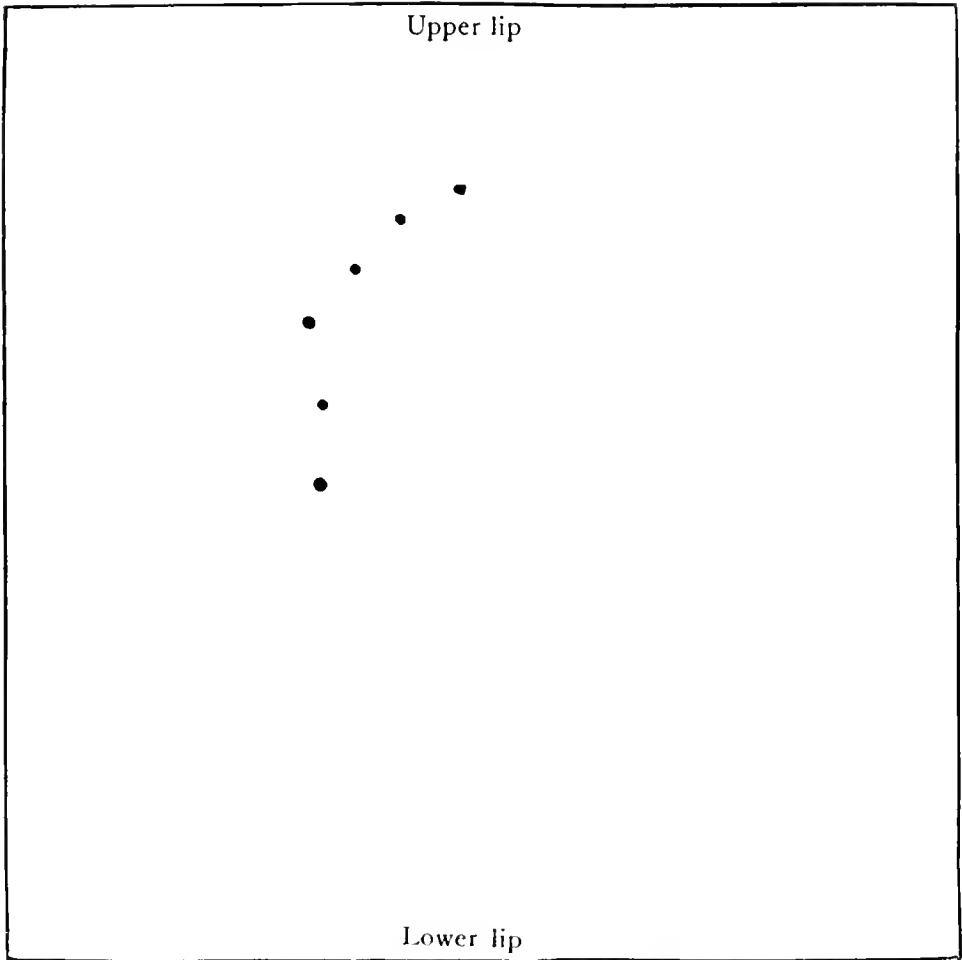

FIG. 63.

FIG. 63. The size, form and position of the holes for applying the rubber dam to an upper first bicuspid tooth in case of recession of the gum in which it must be stretched far to the gingival on the buccal surface. The teeth to be included are those from the central incisor to the first molar. Notice the position, out of line, of the hole designed for the first bicuspid and its distance from the next holes. This position is necessary to prevent pulling the rubber away from the cuspid and second bicuspid in stretching it to the gingival. With this the Hatch clamp is used.

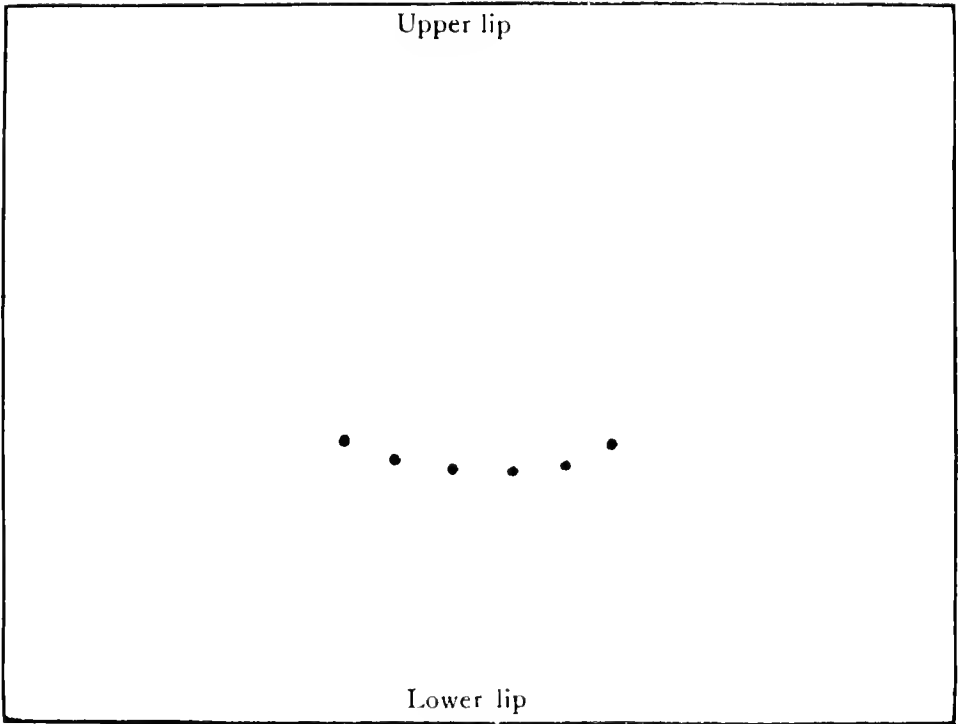

FIG. 64.

FIG. 64. A piece of rubber dam with holes cut for the six lower front teeth. Compare with Figure 62.

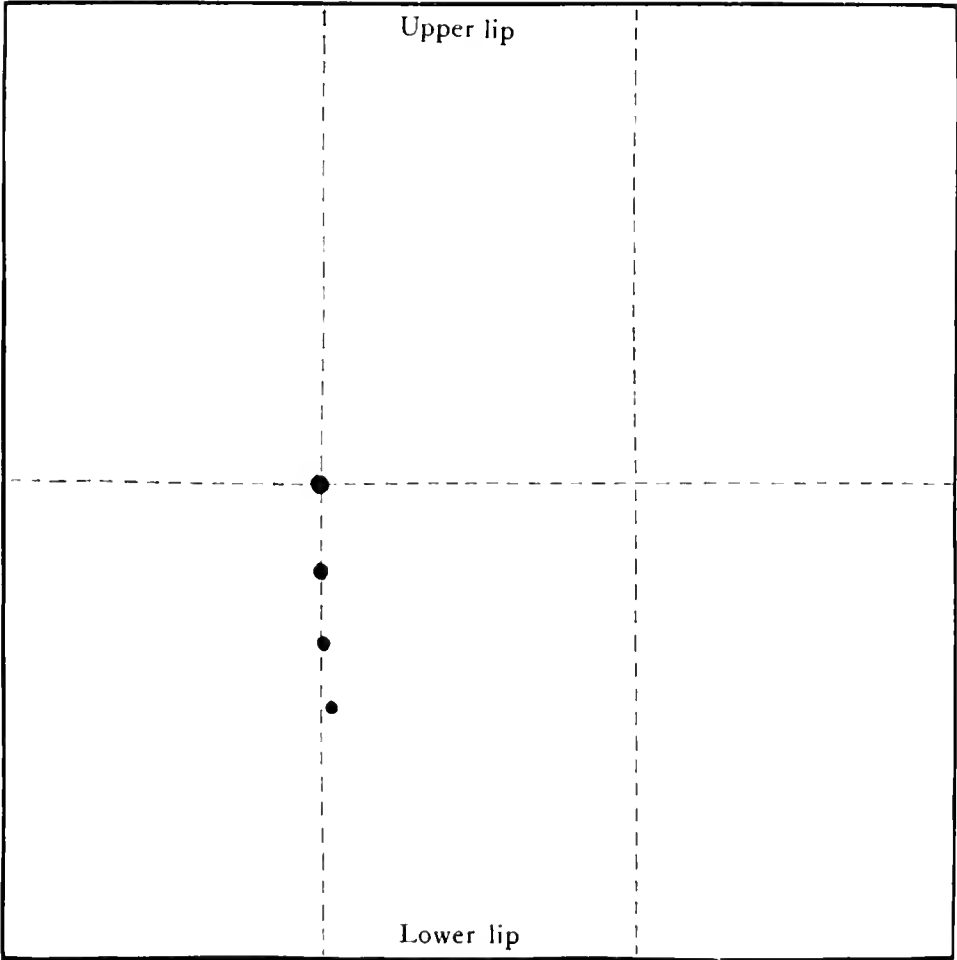

FIG. 65.

FIG. 65. A piece of rubber dam prepared to include the lower bicuspids and first and second molars of the right side. Notice the divisions of the rubber by the dotted lines, which, in the cutting of the holes, are easily followed as imaginary lines.

RUBBER DAM GRASPS.

ILLUSTRATIONS: FIGURES 66-83.

TABULATION OF GRASPS USED IN THE APPLICATION OF THE RUBBER DAM.

PREPARATIONS FOR APPLYING.

1. Remove all calculus, gummy material, etc., from necks of teeth, and douche them with warm water.
2. Pass ligature through interproximal spaces to clean them and test contacts. Trim contacts if necessary.
3. Punch holes as far apart as centers of teeth to be included, and include two teeth on each side of one to be operated on, if convenient.

No.	OPERATOR'S HANDS.		POSITION AT CHAIR.	POSITION OF CHAIR AND PATIENT.	TEETH PATIENT.	
	L.	R.			R.	L.
1.	occl.	x o x	Right side, in front	Thrown well back	6 5 4 3 2 1	1 2 3
	ging.	1 1	Left side, in front	Thrown well back		3 4 5 6
2.	occl.	1 o x	Right side, behind	Thrown well back	EDCBA	2 3 4 5
	ging.	x 1	Right side, behind	Upright, chin down		
3.	occl.	x o 1	Right side, behind	Thrown well back	5 4 3 2	ABCDE
	ging.	1 x	Right side, behind	Upright, chin down		
4.	occl.	1 o 1	Behind, above	Low, thrown back	6 5 4	4 5 6
	ging.	x x	Right side, in front	Upright, chin low		FED
5.	occl.	x 1 o 1 x	Behind, above	Low, thrown back	8 7 6	6 7 8
	ging.	2 2	Right side, in front	Upright, chin low		HGF

REMOVAL.

1. Remove all ligatures and clamp.
2. Draw rubber to buccal or labial, and cut portions extending between the teeth with blunt-ended seissors, draw rubber to lingual, and remove.
3. Douche gums with warm water and knead them to restore circulation.

In the first column of this tabulation, the numbers of the five grasps are given; in the second column the grasps are given; x represents the thumb, 1 the first finger, 2 the second finger, o the hole in the rubber, and the line the piece of rubber, with the sides that will, when it is in place, be toward the occlusal surfaces of the teeth and next to the gums, marked occl. and ging. respectively. At the head of this column an L and an R indicate the left and right hands of the operator. In the third column the position of the operator at the chair is given; in the fourth column

the position of the chair and the patient. In the fifth column the teeth over which the rubber may be applied by the various grasps are represented by figures for the upper teeth and letters for the lower. The perpendicular line in the center of this column indicates the median line of the mouth and the upper and lower teeth of each side are numbered from 1 to 8, or A to H, in each direction from the median line. The operator is considered as facing the patient and the teeth on the right side of the patient's mouth are opposite the operator's left hand, as indicated by the letters R and L at the top of the column. For example, with the second grasp, the operator's left first finger would be on the occlusal side of the rubber and the left thumb on the gingival side, while the right thumb would be on the occlusal side and the right first finger on the gingival. The operator would stand on the right side behind the chair, and have the chair thrown well back to apply the rubber over the upper left lateral incisor, cuspid, first and second bicuspid teeth; or have the chair upright, and the patient's chin down to apply the rubber over the lower right central and lateral incisors, cuspid, first and second bicuspids.

It should be understood that it is not attempted in this tabulation to give the exact teeth over which the rubber may be placed by each grasp, but to suggest the general positions in the mouth.

The particular manner of grasping the rubber dam when about to apply it, is very important and should be studied with much care in the beginning of the student's experience; and good habits of practice formed. There are five ways of grasping the rubber dam, which are called the Rubber Dam Grasps, each of which is effective for placing it upon the teeth easily and quickly. Certain ways of grasping the rubber dam are particularly suited to the application of it in certain positions in the mouth, or to certain teeth; also to certain positions of the operator when applying it. If these are well learned in the beginning, it will save much time and much of the difficulty in attaining facility in this work. It is one thing to get the rubber dam well placed after a scramble, and quite another to place it without worry to either the patient or the operator.

The illustrations representing the rubber dam grasps and different movements are comprised in Figures 66 to 83, and will be treated as a group to which frequent references will be made. Each grasp of the rubber is illustrated. Another illustration shows the position at the end of the first movement in placing it on the teeth; or, at the time the rubber has been carried over the tooth to the gingivæ. A third illustration shows the position

when the grasp on the rubber has been released, but while it is still held against the gingivæ to allow it to close around the tooth. These are the critical points in placing the rubber dam. If the definitions given, and the systematization of the plans of this work are carefully studied in the beginning, the placing of the rubber dam will be relieved of much of its difficulty.

In considering these grasps, the side of the rubber which, when applied, will be next the gingivæ, is called the gingival side; and that which will be toward the occlusal surfaces of the teeth, is called the occlusal side. The five ways in which the rubber dam may be grasped in applying it to teeth in the different positions in the mouth will be numbered as they are presented. Notice particularly, that one of the most essential things in grasping the rubber dam is that the thumb and finger nails shall come against the labial and lingual surfaces of the tooth to which it is applied.

THE FIRST GRASP is used when the dam is to be applied to the upper front teeth. Grasp the rubber between the thumb and first finger of each hand, with the thumbs on the occlusal side of the rubber and their ends with the nails touching together immediately over the hole to be first used. The finger-ends should be on the gingival side of the rubber, midway the balls of the thumbs, Figure 66. Stretch the rubber a little with the thumbs still touching end to end. It is especially important in this, and all other rubber dam grasps, that the nails of the thumbs, or fingers, on the occlusal side of the rubber be over the margin of the hole to be used, as seen in Figure 66, so that, in pressing the rubber down over a tooth, they will carry the actual margin of the hole to the gingivæ. Also the nails must be in such position that they will be next to the teeth to hold the margin of the hole more securely in position while the rubber dam slips under the finger end, or end of the thumb, in drawing around the neck of the tooth. It is largely upon the correctness of this particular hold upon the rubber that success in placing it easily and quickly depends. When grasped in this way, stretch the rubber a little more, and, standing to the right side in front of the patient, pass the hole over the upper incisor tooth, the right thumb on the lingual and the left on the labial side. In doing this, first place the free edge of the rubber at one side of the hole between the teeth, and, with a slight sawing motion, force it past the contact on that side; then stretch it over the tooth and force it past the contact on its other side in a similar way. Now carry each of the thumb nails against the gingivæ, the one on the labial, the other on the lingual side. This is the end of the first movement. The position is

shown in Figure 67. Note particularly that the fingers grasp the rubber dam on the gingival side up to this point. At this point, hold the thumbs in position, release the hold of the rubber with the fingers and allow it to draw around the neck of the tooth before loosing the pressure with the thumbs. This is the second movement. Figure 68. Note that the fingers have released the rubber dam, but the thumbs are still holding it against the gingivæ. Generally, the rubber will be felt to draw around the thumbs, and then they should be given a slight shaking motion, which will allow the rubber to draw around the tooth. This last must be assured before releasing the pressure of the thumbs and removing them. Otherwise, the rubber may be pulled off of the tooth in removing the thumbs. When the rubber is applied in this way, it will generally be found to cling to the neck of the tooth, and to have its cut edge turned under the gingivæ. Repeat this motion with each hole in the rubber, grasping it anew, and in the same manner for each, and pass it over the appropriate tooth with a similar motion. This grasp and these motions will answer for all of the upper teeth as far back as the first molars. When applying it with this grasp to the teeth of the left side, the face of the patient should be turned strongly to the right; or the operator should pass to the left side of the patient.

THE SECOND GRASP is a modification of the first, which allows the left hand of the operator to be passed around the head of the patient, when standing in the position right side behind. This will generally be found more convenient for the upper teeth of the left side as far back as the bicuspids. In this, the rubber is grasped with the right hand in the same way as before, but with the left hand the grasp is inverted so that the forefinger takes the place of the thumb, or is on the occlusal side of the rubber, while the thumb is on the gingival side about opposite the first joint of the finger. The finger and thumb on the occlusal side of the rubber are just over the margin of the hole to be used when the rubber is stretched, as shown in Figure 69. In applying the dam with this grasp to the upper teeth of the left side, the operator's position is right side behind, the thumb of the right hand is placed on the lingual side of the tooth and the forefinger of the left on the labial, or buccal, side. Otherwise than this change of position, the motions with which the rubber is placed are the same as with the first grasp. The first movement, Figure 70, and the second movement, Figure 71, must be distinctly separate. This grasp is also suitable in applying the rubber to the lower teeth of the right side, as far back as the second bicuspid.



FIG. 66.



FIG. 67.



FIG. 68.

FIG. 66. First rubber dam grasp, for upper front teeth. See tabulation of grasps, also text. The two thumbs on the buccal side with the nails of each over the edges of the hole, which is stretched a little. The two forefingers are on the lingual side opposite the thumbs.

FIG. 67. First grasp. Position right side in front; patient's head thrown back. First movement; pass the rubber over the tooth; thumb nails are next to tooth and carry the edge of the hole hard against the gums. Notice particularly that the object is to carry the edges of the hole in the rubber fully to the gingivæ.

FIG. 68. First grasp. Second movement; hold the thumbs firmly in position as in Figure 67; let go the grasp of the rubber with the forefingers, still holding it with the thumbs, with the nails against the tooth. A little shaking motion of the thumbs, without releasing the pressure, allows the rubber to close around the tooth; remove the thumbs. If these movements are rightly made, the edges of the hole will be tucked under the gingivæ. Grasp the next hole in the rubber in the same way and repeat the same movements for tooth after tooth. This particular use of the nails is essential in all rubber dam grasps.



FIG. 69.



FIG. 70.



FIG. 71.

FIG. 69. Second rubber dam grasp, for upper left incisors, cuspid and bicuspids, and lower right incisors, cuspid and bicuspids. Right thumb and left forefinger on occlusal side; nails of each over margin of hole. Left thumb and right forefinger on gingival side.

FIG. 70. Second grasp. Position right side behind; head of patient thrown back. First movement; nails of both thumb and finger next to the tooth, pass the rubber over tooth and with the nails carry it to the gingiva.

FIG. 71. Second grasp. Second movement; release the grasp with the left thumb and right forefinger, on gingival side of rubber, but hold it with right thumb and left forefinger on occlusal side until rubber has closed around the tooth. Repeat movements for tooth after tooth as shown in illustration.



FIG. 72.



FIG. 73.

FIG. 74.

FIG. 72. Third rubber dam grasp, for upper right incisors, cuspid and bicuspids, and lower left incisors, cuspid and bicuspids. Left thumb and right forefinger on occlusal side, with nails over margin of hole in rubber. Right thumb and left forefinger on gingival side.

FIG. 73. Third grasp. Position at chair right side behind. First movement; rubber passed over tooth; nails of thumb and finger on occlusal side against the tooth.

FIG. 74. Third grasp. Second movement; release the grasp on rubber by thumb and finger on gingival side, holding it against the gums with the nails of the thumb and finger on the occlusal side until the rubber has closed around the tooth.



FIG. 75.



FIG. 76.



FIG. 77.



FIG. 78.



FIG. 79.

FIG. 77. The fourth rubber dam grasp, for bicuspid and first and second molars, both right and left sides, upper and lower. Both forefingers on the occlusal side, with the finger ends coming together in the form of an inverted letter A, with the nails over the margins of the hole to be used. Both thumbs on the gingival side.

FIG. 75. Fourth grasp. For upper left bicuspid, position right side behind; head of patient thrown back. First movement; pass the rubber over the tooth, bringing the nails of both forefingers hard upon the gingiva and hard against the tooth.

FIG. 76. Fourth grasp. Second movement; release the rubber from the grasp by the thumbs on the gingival side while holding it firmly on the gingiva by the finger nails on the occlusal side until the rubber has closed around the tooth.

FIG. 78. Fourth grasp. For lower left bicuspid, position right side in front; head of patient upright. First movement; pass the rubber over the tooth, bringing the nails of both fingers hard against the gums close against the tooth.

FIG. 79. Fourth grasp. Second movement; release hold by thumbs on gingival side of rubber, while holding it firmly down by the fingers on the occlusal side; see that the rubber has closed around the tooth, then remove the fingers.

THE THIRD GRASP is a modification of the second, in which the two hands are simply inverted, so that the thumb of the left is on the occlusal side of the rubber and the thumb of the right is on the gingival side. In every other way, the grasp is the same. This is suited to placing the rubber on the lower teeth of the left side of the mouth as far back as the second bicuspid, and on the upper teeth of the right side as far back as the second bicuspid, the operator standing on the right side behind. Figure 72 shows the position of the rubber in the hands with the hole stretched open a little. The rubber dam is then carried over the tooth and the first movement completed, as shown in Figure 73. The grasp on the rubber is then released to allow it to close around the tooth while held against the gingivæ with the finger and thumb nails, as shown in Figure 74.

THE FOURTH GRASP is a complete inversion of the first. In this the thumbs are both placed on the gingival side of the rubber, and both forefingers on the occlusal side. The rubber is grasped with the thumbs opposite the first joint of the forefingers, or thereabouts. The ends of the forefingers come together over the hole to be used, not directly end to end, but in the form of a letter V, the finger-ends forming the angle. The rubber is now stretched so as to open the hole slightly, while the finger-ends are close against its margins, Figure 77. Then it is carried over the tooth, stretching the rubber sufficiently by spreading the fingers apart, made to pass the contact points between the teeth, one after the other by a slight sawing motion, and the finger-ends (the nails next to the tooth) carried hard against the gingivæ, one on the buccal side and one on the lingual side of the tooth. This completes the first movement. Figure 75, upper, and Figure 78, lower teeth. Then the grasp of the thumbs is released while maintaining the position of the fingers, and the rubber allowed to close around the tooth. If the rubber is felt to close on the finger-ends, which it will often do, and fails to close on the tooth, make a slight oscillating motion of the fingers, which will allow it to slip past them and hug to the tooth before removing the fingers. This completes the second movement. Figure 76, upper, and Figure 79, lower teeth. The rubber is now grasped anew and in the same way, to be passed over the next tooth, being careful to place the finger-ends very close on either side of the hole to be used in each instance.

This grasp is particularly suited to the upper bicuspid and first molars, the operator standing on the right side behind the patient. For this, the head of the patient should be thrown well

backward. This grasp is very convenient for placing the rubber on the lower bicuspids and first molars, the operator standing to the right and in front of the patient. For this position, the head of the patient should be upright.

THE FIFTH GRASP is used for placing the dam on the second and third molars, or where it is necessary to reach far back into the mouth; and particularly for placing the rubber over the bow of a clamp previously placed on either one of these teeth, upper or lower. In doing this, the dam is first taken between the first and second fingers of each hand, with the forefingers and thumbs on the occlusal side. Then the second, third and fourth fingers are closed, or nearly closed, and the dam grasped between the thumbs and second fingers, with the thumbs placed opposite the second joint of the fingers, or between the first and second joints, as in Figure 80. Notice that the first fingers are free. With this grasp, stretch the dam a little and engage the two forefingers in it close on either side of the hole to be used, and with them stretch the hole open, as in Figure 81. To the beginner it is generally necessary that the hole be opened sufficiently wide so that the tooth to which it is to be applied can be seen through it; but when its use is well learned, the tooth will be found by the sense of touch. Carry the rubber back into the mouth and pass it over the tooth with the forefingers, the one on the buccal, the other on the lingual, and engage one edge of the hole between the teeth, preferably the mesial first, and cause it to pass the contact by a sawing motion. When this has passed into the interproximal space, throw the rubber over the distal surface, and, if it is a second molar, pass the contact in a similar way. Then carry each of the finger-ends hard against the gums on either side, buccal and lingual, of the tooth, completing the first movement. While holding the forefingers firmly in position, release the dam with the thumbs and second fingers. The dam will now close around the tooth, or else it will be felt drawing on the ends of the forefingers. In the latter case, a little motion of the ends of the fingers will allow the dam to slide by them and close firmly around the tooth. Then, and not until then, the fingers may be removed, completing the second movement. It often happens that beginners make this application of the rubber correctly to the completion of the first movement and then pull the dam off the tooth in removing the fingers. The dam may now be grasped again in the same way and the forefingers engaged on either side of the next hole to be used and it brought over the next tooth in a similar manner. Notice particularly that the grasp on the



FIG. 80.



FIG. 81.



FIG. 82.

FIG. 83.

FIG. 80. Fifth grasp, for molar teeth, particularly the third molars. See text for description. First position; the rubber is caught between the first and second fingers of both hands, with both thumbs on the occlusal side; each thumb grasps the rubber against the second joint of the closed second finger.

FIG. 81. Fifth grasp. Second position; stretch the rubber by the grasp between the thumbs and second fingers; by bending the two forefingers, catch them in the rubber close on either side of the hole to be used, which is cut a little larger than usual, and stretch the hole open as shown. See that the distal margin of the hole comes over the end portion of the pulps of the fingers and that the median sides of the fingers are well over the margins of the hole as shown.

FIG. 82. Fifth grasp. Position right side behind, head of patient thrown well back. The special rubber dam clamp has previously been set over the upper third molar of left side. First movement; find the rubber dam clamp by the sense of touch; pass the distal margin of the hole in the rubber over the lingual portion of the distal margin of the clamp; it may be heard and felt to snap as it goes over; bring the finger on the lingual side to the lingual foot of the clamp, then holding carefully, direct the patient to close the teeth lightly on the fingers to move the ramus of the lower jaw backward out of the way and sweep the finger on the buccal side over the clamp to its buccal foot.

FIG. 83. Fifth grasp. Second movement; release the hold on the rubber with the thumbs and second fingers; generally the rubber will be felt closing on the fingers; a slight shaking movement will cause it to slip by the fingers and close around the tooth under the clamp. These movements should be conducted by the sense of touch; and for this reason it is unnecessary to have the rubber held away by the fingers of the assistant, as shown in the illustration, except for the purpose of photographing.

rubber is to be released entirely at the end of its application to each particular tooth and grasped anew for the next. In grasping it anew for this purpose, the fourth grasp will often be more convenient. The use of this grasp for placing the rubber over the special clamps, which is really its most important use, will be given below.

It is just as important to know how to remove the fingers from the rubber without pulling the rubber away with them after it has been placed on the tooth as it is to place the rubber over the tooth. Special attention should be given to the necessity of noting very carefully the manner of doing this, and to the fact that the dam should be allowed to fully close around the tooth while the fingers are still pressed against the tooth and gums on its buccal and lingual sides. When this is done, it will generally be found that the margins of the hole in the rubber are turned toward the gingival. This is especially what is needed to render the rubber secure in its position on the tooth. This applies to all grasps whatsoever that may be used in adjusting the rubber dam.

In using the fifth grasp, the operator can use the full length of the forefingers for reaching back into the mouth, and yet have full command of the rubber and readily place it on the tooth where the contacts can be passed with a sawing motion of the fingers; and, in ordinary cases, it will hold without the aid of a ligature while passing it over other teeth. Of course, there are molar teeth around which the gums are so high that the rubber can not be passed far enough onto the crown in this way for it to hold. There are also tooth crowns so rounded that the dam must be forced actually to the gingival line and tied down with a ligature, or held by a clamp, before it can be induced to remain in place. With these grasps, however, everything can be done that it is possible to do with the unaided fingers.

AIDS IN ADJUSTING THE RUBBER DAM.

THE LIGATURE. There are many cases in which the rubber can not be forced between the contact points of adjoining teeth with the unaided fingers, and then it must be forced with the ligature. This is done best by an assistant. However, by careful practice, one may learn to do it successfully alone. The ligature may be used with any of the five grasps. To accomplish this, wrap the end of the ligature on the little finger of the left hand, and catch a part of its length in the same grasp with the rubber in the thumb and finger of the right hand, leaving just sufficient length between so that the ligature may be tightly

drawn by a movement of the little finger on which it is wrapped. Bring this ligature over the contact to be forced beside the finger, or the thumb of the left hand, at the same time that the rubber is stretched over the tooth. Then, by drawing with the little finger of the left hand and by the grasp with the right, the ligature is forced through, carrying the rubber before it. To get just the right length and adjustment of the ligature, generally requires a little manuevering in each individual case. The observant operator will see his way clearer and be better able to avoid difficulties with each failure.

In cases in which considerable force is required to drive the rubber past the contact, the grasp with the fingers is often insufficient. The ligature will slip in the fingers and the rubber will be stretched too much, and a general derangement of the position will result. In this case, it will be necessary to arrange to use greater force. To do this, wrap the ligature on the little finger of each hand, noting carefully that the length between the fingers is just right. It will often be necessary to try this length a number of times before getting it to exactly suit the particular case. Then bring the ligature over the contact and under one of the fingers or thumb with which the rubber is forced down, and stretch down the rubber into the embrasure as far as possible; then draw the ligature with the little fingers so as to tighten it on the rubber to hold it, and work the finger on the opposite side of the tooth onto the ligature, so that it may be forced on both sides of the tooth at the same time. The accomplishment of this last movement is the most difficult point, but it can generally be done after a few efforts. Then the operator has command of the situation. The rubber can be forced into the contact with all of the power of the fingers. After forcing the first contact, the grasp of the rubber must generally be released, a second ligature wrapped on the fingers, the rubber grasped anew, and the second contact forced in the same way. This may now be continued until the rubber has been placed on a sufficient number of teeth. Generally, when the rubber has been forced past one close contact, this holds the rubber as a starting point and the rest is much easier of accomplishment. Many of the difficulties of adjusting the rubber are relieved by having an assistant pass a ligature or set a clamp in position in these difficult cases.

THE RUBBER DAM CLAMP. The clamp is one of the most important aids in adjusting the rubber dam. The kind of clamp suitable for different positions, or the choice of clamp, will be

considered later. In any case in which the rubber dam is placed on the bicuspid and one or more molars beginning with the mesial tooth and proceeding backward, the clamp should at once be placed on the distal tooth by the assistant, or by the operator himself, if he is working alone. If this is done by the assistant, it is done at the moment the rubber is stretched over the distal tooth and secures it perfectly in position at the point at which it is most liable to be pulled away. The plan of placing this by the operator alone will be given later. In the placing of the rubber on bicuspid and molar teeth beginning with the distal tooth, the immediate use of the clamp to secure the rubber dam in position, instead of using ligatures, simplifies the matter of securing the first hold on the teeth in all of the more difficult cases. After this has been done, the rubber may be placed over other teeth toward the front, one after the other, without danger of losing this first hold. The simplest way of doing this is to place the rubber over the distal tooth of the group to be exposed and while holding it in position have an assistant set on a clamp. In this it is unimportant as to passing the contacts in the first instance in placing the rubber dam over the tooth. This can be done with the ligature later. In doing this, any of the rubber dam grasps may be used, but some dexterity must be acquired by the operator in getting his own hands out of the way of the assistant while placing the clamp. For this reason the fourth or fifth grasp is preferred because the fingers will take up less room and will allow the hand more freedom of motion in clearing the way for the clamp while still holding the dam over the tooth. In the act of passing the clamp on the tooth, it is also necessary that the fingers slip away as the clamp slips over the tooth to the gum line. When the two persons have practiced these movements until they are readily done in concert, the time required is only a few seconds.

For one to do this alone is not so easy. However, in those cases in which the rubber may be made to pass the contacts, it is easily held down by a finger of the left hand on one side of the tooth only while the clamp is being placed with the right. When the contacts can not be passed in this way, it is necessary to contrive to hold the rubber on both sides of the tooth with the fingers of one hand. (In any of the ways of placing it alone the clamp must be in the forceps and should be opened to the necessary width to go easily over the tooth, and laid in readiness.) For this purpose I have usually used a modification of the fourth rubber dam grasp in which the second finger of the left hand is

substituted for the first, leaving the first finger free. When the rubber is passed over the tooth, the forefinger of the left hand takes the place of the forefinger of the right, leaving the right hand free. The clamp is then set on the tooth passing over the finger of the left hand. When the reach back into the mouth is not too great, the grasp may be as usual and the thumb of the left hand used to relieve the finger of the right, but in this case more of the hand is in the way of the clamp forceps. Some persons seem to have much difficulty in bringing the ends of the first and second fingers close enough together to hold the rubber close against both the lingual and buccal sides of the tooth after spreading them over the arch. In doing this, a certain bending of the fingers is necessary in the first of the movement and a straightening of the first finger as the clamp is placed. These movements are usually difficult for the beginner, and any one intending to use them should first practice them on models out of the mouth and then in the mouth before undertaking the work for patients. This should generally be done without pain to patients.

After the clamp has been placed over the rubber, the rubber may be forced past the contact with the ligature. On the mesial side of the tooth, that is perfectly simple; but it often is more difficult to pass the contact distal to the clamp. In a large proportion of the cases it will be unimportant whether the rubber passes this contact or not. If the clamp is steady and there is no leakage, there is no necessity for passing the contact. But often it will leak and occasionally it is necessary to remove the clamp in order to place a separator.

TYING A LIGATURE UNDER A CLAMP will require different maneuvers with different clamps, depending much on the form of the bow. Often with the special clamp the ligature may be brought into position to pass the contact after passing it to the distal of the bow; especially if after it is passed around the foot of the clamp to the buccal and lingual it is caught with hatchet 6-2-23 (a dull instrument of similar shape would be better, as the danger of puncturing the rubber would be avoided), passed through the bow of the clamp, to hook it up and pull it forward into position to enter between the two teeth. In order that the ligature may readily slip off the instrument into place, it must be caught from above, not from below. In doing this alone the ligature must first be passed to the foot of the clamp, both buccal and lingual, with one end wrapped on the little finger of the left hand, and with the second finger of the left at

the foot of the clamp. Then the left forefinger is brought across the arch onto the ligature, which is finally placed by the right hand between the thumb and forefinger of the left and so both ends are held. Then the instrument is used by the right hand as related above and the ligature slackened or tightened with the left as required, until it is brought into position to enter between the teeth. Or the ligature may be passed through the bow of the clamp and held against the foot of the clamp on the lingual and strongly pulled into the lingual side of the contact so that it will be held in position. The other end of the ligature may then be passed back through the bow of the clamp and the contact fully passed.

When necessary to secure the rubber dam for the removal of the clamp to place a separator, it is good policy to tie a small bead to the ligature and pull this close into the buccal embrasure before making the knot in the ligature securing it to the tooth. This will secure the rubber dam much more firmly against being pulled away in removing the clamp and substituting the separator. In the absence of a bead, a hard pellet of cotton may be tied into the ligature by several knots; this will do quite as well. It is often well to use these beads or knots to the distal of the distal tooth exposed if for any reason a clamp is not to be used or changes are to be made. It secures the rubber very firmly.

APPLYING THE RUBBER DAM OVER THE SPECIAL CLAMP. Another method of avoiding the most serious difficulty in passing ligatures to force the rubber between teeth far back in the mouth, is to set a special clamp (Figure 90, rights and lefts) on the tooth first, and then throw the rubber over the bow of the clamp. For this purpose, the fifth grasp should be used, and the hole in the rubber should be a little larger than usual. The ends of the forefingers should be placed fully to the distal side of the hole, or so that its distal edge is fully between the finger ends and upon their palmer surfaces. Then it must be so stretched that the distal edge of the hole may be passed over the distal edge of the bow of the clamp, Figures 80, 81, starting it first over its lingual portion, bringing the lingual finger under the lingual side of the clamp and sweeping the other finger around over the buccal portion, bringing the fingers down against the outer margins of the jaws of the clamp, Figure 82. Then release the grasp on the rubber, and, by a little careful motion of the fingers, it is allowed to close around the tooth under the clamp, Figure 83. The passing of the rubber over the clamp should be done entirely by the sense of touch, and should first be practiced out of the mouth for

the purpose of learning the points to be made by this sense. These are: first, the ability to feel the position of the distal margin of the hole in the rubber on the fingers; and, second, by the sense of touch, to bring this over the distal edge of the bow of the clamp. This may readily be made to snap over the bow of the clamp so that it is readily felt and heard. Then the finger on the lingual will feel its way to the lingual foot of the clamp and hold that position while the finger on the buccal side slides to the buccal foot of the clamp. Then release the rubber with the fingers and complete the operation as directed below. In other words, when the rubber has passed to the distal of the clamp, a sweep of one finger on the lingual to the gums, then sweep the other to the buccal over the bow of the clamp following its curvature, completes this part of the movement. Then, while the fingers are held against each foot of the clamp, the rubber dam is released with the thumbs. Figure 83. As the rubber is felt to draw on the fingers, a little oscillating movement is made, which allows the rubber to close around the neck of the tooth under the jaws of the clamp. This is generally done easily and quickly when the particular relation of the fingers to the hole in the dam is appreciated. After this starting point has been secured, it is not very difficult to secure the rubber over the teeth mesial to it. When the rubber dam has been placed in this way on a second molar, the rubber may catch on the cusps of the third molar and require to be pulled forward into position between the teeth; or it may refuse to enter the contact between the teeth sufficiently to exclude moisture. Often it may be teased into place by a pellet of cotton in the foil pliers. If this does not succeed promptly, a ligature should be thrown around the clamp over the rubber dam, and with this the rubber is readily drawn into position between the teeth.

In the upper jaw the most serious difficulty met with in throwing the rubber over the bow of the clamp placed on the third molar is the interference of the ramus of the lower jaw, which comes forward when the mouth is opened wide and does not leave room for the finger to pass over to the buccal side. This difficulty may be seen when the clamp is applied. The patient should be instructed to close the teeth lightly on the operator's fingers at a word while the operator's finger passes that point. This clears the way for the finger to pass easily. As these movements are directed entirely by the sense of touch, the closing of the mouth, or the lapping of the rubber over the fingers is of no consequence.

In the lower jaw the bow of the clamp will sometimes be found hard against the soft tissues near the foot of the clamp on the buccal side. Generally this may be remedied in a degree by changing the position of the clamp slightly. Or, if the rubber can be brought over the bow and to the lingual foot of the clamp and held, it may generally be forced or teased between the clamp and the tissues on the buccal side. In any case in which it is far enough over the bow of the clamp to have a tendency to slide toward the foot, it may be released and a ligature passed over the bow of the clamp, with which the rubber may be pulled into place.

Some operators prefer to adjust the rubber over the bow of the rubber dam clamp after the clamp has been fixed in the clamp forceps and before the clamp has been placed on the tooth. Then the rubber dam is so folded together as to be as little as possible in the way, and the clamp set upon the tooth. Then, when the forceps are removed, the dam slides partly into position. It may then be unfolded and adjusted to the face of the patient, and can be worked under the jaws of the clamp with the flat curved burnisher and be made to exclude moisture. It is afterward adjusted to the teeth mesial to the one upon which the dam clamp has been placed. This plan may be made very successful, but is more difficult and takes more time than that by throwing the rubber over the clamp after it is placed on the tooth. Also, the rubber dam folded about the clamp and forceps obscures the vision at the time when it is most important to see to adjust the clamp accurately.

THE USE OF LIGATURES.

ILLUSTRATIONS: FIGURES 84-89.

Passing the contact with the ligature should be done with much care, for, if it is allowed to snap onto the gums, it will often cause considerable pain and do the patient a real injury by cutting into the tissues. To avoid this, always catch the ligature very close to the tooth on both the buccal and lingual sides. This will prevent the forcible snap onto the sensitive tissues that is sure to occur if this precaution is not observed.

In many cases a ligature must be tied over the rubber to hold it in place, or to force the gums sufficiently away to expose the gingival margin of the cavity. In doing this, the ligature should be carefully forced close to the gingival line and tightly drawn with a surgeon's knot. Figure 88, upper knot. Gener-

ally, it is not necessary to tie ligatures on every tooth over which the dam is placed. Often, when ligatures seem necessary, if the rubber is just drawn down well, the ligature may be at once removed and the rubber will remain in position. Ligatures are often painful, and when the results can be well accomplished without them, they should not be used.

Often there will be difficulty in adjusting the ligature to the lingual side of the incisors with the unaided fingers. The shape of the lingual surface causes it to slip off. In these cases the ligature should be thrown loosely around the tooth and the first half of the knot formed, but, before it is drawn up, the flat-curved burnisher should be passed to the lingual of the tooth inside the loop of the ligature and carried to the gingival line and so inclined that when the ligature is drawn with the other hand, it will be guided to the right position. Then the burnisher may be removed and the knot closed. This burnisher is useful in many positions as an aid in the adjustment of ligatures.

A caution should be given regarding the tying of ligatures on the incisor teeth, and particularly on the teeth of young people. The photograph of an incisor tooth, Figure 85, shows the arching of the gingival line over from labial to lingual, which is the line of the normal attachment of the gum tissue to the tooth. This arch of the gingival line is met with continually in the illustrations of incisors.

If the ligature is forced close to the gingival line on the lingual side and then is forced also hard to the gingival on the labial side of the tooth and tightly drawn, it will cut the tissue arched over in the interproximal space on both the mesial and the distal surfaces, and, occasionally, cases occur in young persons in which the ligature has actually passed between the interproximal bone tissue and the root of the tooth. The pain caused by this is often extreme. Cases are coming under observation much too frequently in which injury is done in this way that will never be recovered from. There may result a permanent diseased condition of the periodontal membranes from which the teeth will remain sore and are liable to be lost finally.

If ligatures are placed on the incisor teeth, they should never be pushed hard to the gingival on the labial side after pushing them to the gingival line on the lingual side and then tightly drawn; or, as some do, draw them tightly and then force them hard to the gingival. If the dentist feels that he must tie a ligature on these teeth, he should generally tie it in the position shown in Figure 84, and in the tying draw it only tight enough

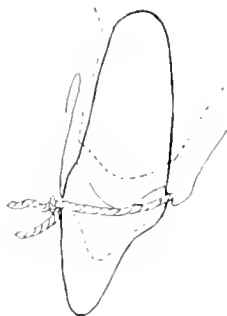

FIG. 84



FIG. 85.

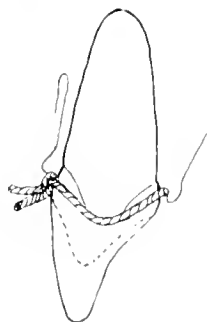

FIG. 86.

FIGS. 84, 85, 86. A series of illustrations showing the danger of injury to the attachment of the soft tissues to the proximal sides of the incisors and cuspids by tying ligatures.

FIG. 84. Diagram showing the relation of the ligature to the attachment of the soft tissue at the summit of the arch as it passes labio-lingually.

FIG. 85. A photograph of the mesial surface of an incisor tooth showing the normal form of the arch of the gingival line in passing across the arch labio-lingually.

FIG. 86. Illustration of the position of the ligature in its relation to the interproximal attachment of the soft tissues to the tooth. If this is firmly drawn and pushed to the gingival as far as shown, the cutting of the attachment of the soft tissues to the neck of the tooth is inevitable.

to hold. Generally if one will work carefully and not draw the ligature too tightly in tying, the ligature may rest upon the attachment of the tissue at the crest of the arch, as shown in Figure 86, and do no harm. This should always be done with great care. I have traced incurable disease of the peridental membranes to this as the initial lesion so many times, much too many of which were done by myself, that I feel like making this warning as decisive as possible. Most dentists are much too careless about doing injury in such ways as this. Many more have never thought that permanent injury is liable to occur from ligatures tied on these teeth.

On the bicuspid and molars there is not the same danger from tying ligatures for the reason that the arching of the gingival lines does not occur in them. It is generally very nearly horizontal all around these teeth. Ligatures should not be tied on any teeth on which any kind of a clamp, matrix or a separator is to be placed. In case ligatures have been tied for the purpose of excavating, they should be removed before placing the separator. The same rule should apply to any kind of clamp or matrix. The tendency is to use ligatures more than the necessities require. Every dentist should make it a rule to avoid them as much as possible. In no case should the rubber dam be tied on an incisor and the labial free border of the gum pushed away with a ligature for the treatment of labial cavities. This should always be done with the Hatch clamp, described later. Neither should it be so tied for any other purpose whatever.

In tying ligatures about the teeth, the first half of a surgeon's knot (the upper one in Figure 88) should first be formed and tightly drawn. In doing this, the ligature should be grasped as close to the knot as practicable and held close against the teeth, one end to the mesial and the other to the distal. If the ligature is over the bicuspid or molars, catch the distal end of it over the end of the forefinger of one hand and force it to the distal close against the teeth while pulling the mesial end with the other hand. If the ligature has been well waxed, the first half of the knot will not slip or loosen; but it must not be pulled or disturbed in the least while forming the other half of the knot. Let the ends fall perfectly loose while forming the second half and work it up carefully until it is just right and then draw it tight at a single pull, again keeping the fingers close against the arch, both to the mesial and distal. A ligature tied in this way will always be tight around the tooth. It is essential that the surgeon's knot used should be the true surgeon's knot shown in

the upper knot in Figure 88, and not the bastard surgeon's knot below this. The first half of these two knots is formed in the same way, but in the second the crossing of the ends of the ligature has been different so that the end does not come out of the knot beside the entering end in the bastard knot, as it does in the true surgeon's knot above. Notice that in the bastard knot these come out in such a way that the ends of the twist in making the first half are pulled away instead of being tight, as in the upper knot. This allows such a knot to loosen just a little, which is often fatal to the hold of the ligature on the tooth. The ends of the cords with which these knots were made for these pictures were of different colors in order that each thread could be traced through and its return on itself, or its variation from that, discovered. Notice the upper knot in Figure 87, which is the most perfect tie for ordinary purposes that has yet been made, the famous square knot. Compare it with the bastard square knot below. Trace the cords in and out and try making knots in each way and find the difference in the direction of crossing the cords for forming the second half of the knot. The square knot is really a better knot than the surgeon's knot, only that in forming it, the single wrap of the cords together is apt to slip and loosen while forming the second half of the knot. The two wraps of the surgeon's knot prevent this, provided sufficient care is taken not to disturb them while forming the second half. The knot shown in Figure 89 we may call the fool's knot. One end of the cord is held straight and both the first and second half of the square knot formed around it. This is readily seen by following the threads in each of the three, one loosely thrown ready to pull tight, the second partially drawn and the lower one drawn tight. Many people seldom tie any other knot. This knot will always slip and loosen unless the cord is rough so that slipping will be prevented. To make any kind of a knot (of ordinary forms) that will not be liable to slip, both of the ends must be turned upon themselves and crossed in forming the second half. A dentist should always have the knot he uses, which should always be the surgeon's knot, the upper one in Figure 88, so perfectly at his finger-ends that he will make no mistake in any position.

RUBBER DAM CLAMPS.

ILLUSTRATIONS: FIGURES 90-99.

Rubber dam clamps are used upon the teeth to secure the rubber dam in position, and incidentally to hold the rubber more out of the way than it would be without them. They contribute



FIG. 87.



FIG. 88.

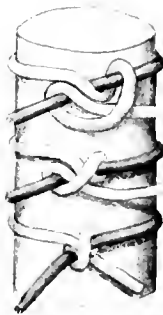

FIG. 89.

FIG. 87. The square knot. The upper one is the correct square knot; the lower one is the bastard knot. The ends of the cord are of different colors so that the windings in the formation of the knots are easily followed.

FIG. 88. The surgeon's knot above. The surgeon's bastard knot below.

FIG. 89. The fool's knot. The upper one thrown together loosely; the second drawn closer, and the third drawn full tight. Notice that in this knot the light end of the cord is given simply a hitch around the dark end. Such a knot will always slip and pull out, unless some roughness of the cord holds it. Many people tie this knot. Some will be found who give the dark end a hitch around the light end after tying the first to keep it from slipping.



Fig. 90.



Fig. 91.



Fig. 92.



Fig. 93.



Fig. 94.

Figs. 90-94. The author's special clamps.

Fig. 90. Special third molar clamps, rights and lefts, used in passing the rubber dam over the bow of the clamp.

Figs. 91-94. Special root clamps for use in the treatment of root canals when this becomes necessary after cutting away the crown in placing artificial crowns, or prepared abutments for bridges. The clamp can be placed on any root that may receive a band without injury to the soft tissues, and the bows are well out of the way. All are made with strong bows so that they are very steady on the teeth. All are intended for use by first setting them on the root and afterward applying the rubber over the bows. Figure 91, a large pair, rights and lefts; Figure 92, a smaller pair, rights and lefts; Figure 93, a side view; Figure 94, a view showing the form of the foot to facilitate the drawing of the rubber around the root.

greatly to the usefulness of the rubber dam by rendering it secure and relieving the operator of care or anxiety as to the dryness and cleanliness of his field of operation. The question of what clamps to use is often a troublesome one. Many dentists have boxes of them in the endeavor to have something for any case that may be presented. As often as otherwise they fail to find just that which they want. All things considered, it seems best to limit the number very rigidly and make them do. Besides the pair of special clamps, Figure 90, one or two clamps for molars will be a sufficient number. Then, one or two selections for possible use in bicuspid cases in which the molars are missing. The two pairs of root clamps, Figures 91-94, are also essential.

In selecting the molar and bicuspid clamps, it should be a first object to obtain very strong bows in order to have a clamp that will not be wobbling about on the tooth and annoying the patient, hurting the gums, etc. A light bow that takes hold of a tooth gingerly is a nuisance. They are always on the wiggle and are generally gouging the patient's gums at each wiggle. A clamp with a strong bow does not hurt a tooth if put on and taken off carefully, and its steadiness renders it comparatively comfortable. The foot of the clamp should never be quite as broad mesio-distally as the tooth on which it is placed if it is to be used at all during the excavation and filling of cavities or in the finishing of fillings. Otherwise it will often be in the way, limiting the field of operation unnecessarily. There is no use whatever for wings and such things for any one who has learned to handle the rubber dam easily and well.

In filling cavities in the bicuspid, the rubber should be secured on the molar tooth distal to them with a rubber dam clamp. The bow of the clamp holds the rubber out of the way and gives space and a better view of the field of operation. In excavating and filling cavities in the molars, this is still more necessary. Whenever practicable, the clamp should be placed upon the first molar for operations on the bicuspid, and on the second molar for operations on the first molar. Generally, it is thought that in operations on the second molar not involving the distal surface, a clamp with a bow standing well to the distal should be placed on the same tooth in order to avoid the difficulty of placing the dam on the third molar. But if one has learned to handle the special clamp and the rubber with the fifth grasp, it is about as easy to place it on this as any other tooth. In distal cavities in the second molar it is essential. Rubber dam clamps

on the bicuspid are not permissible at all except in cases where the molar teeth are missing; and even then, they are of doubtful usefulness. Any of those found in the market are so unsteady as to cause the patient much annoyance and often considerable pain. If our dealers would give us a bicuspid clamp with a forked foot on the buccal and a stiff enough bow to hold it firmly when placed, it would occasionally be very useful.

In buccal and labial cavities, that approach near to, or pass beyond, the gingival line, the special clamp, Figure 90, should be used on the molars, and the Hatch clamp, Figures 95, 96, on the bicuspid and front teeth. Except in the most difficult cases, the special clamp will answer the purpose if the rubber, after being placed on the tooth, is drawn well away from the buccal side and the clamp applied, or if the clamp is put on first and the rubber passed over it. This latter plan is especially serviceable when the decay is such as to require especial accuracy in the adjustment of the clamp. When the Hatch clamp is applied to the front teeth with labial cavities, the rubber must be drawn well away from the labial surface and the points placed in position and the set-screw made tight, as in Figures 97, 98, 99. Then the rubber may be allowed to draw tightly around it, and is fairly certain to exclude moisture perfectly. For this purpose, the hole in the rubber should be cut a little larger than usual, and a little to the labial, or buccal, of the line of holes used for the adjoining teeth. See Figure 63.

When the Hatch clamp is to be used on any of the incisors or cuspids, in order to expose the gingival margin of a labial cavity that is close to the gingival line, no ligature should be tied on the tooth. No effort should ever be made to expose the gingival margin of such cavities by use of the ligature, for the reason that the cavity margin on the labial surface of the tooth is so generally further rootwise than the attachment of the gum tissue on the proximal surfaces of these teeth. This is made so by the curve of the gingival line as it passes around the incisors and cuspids, as has been explained. Therefore, such use of the ligature causes unnecessary pain and is apt to cause permanent injury by tearing the gum tissue away from the tooth on its proximal sides.

In placing the Hatch clamp, the left side behind position, as shown in Figures 97, 98, is best on the lower teeth of the right side. For other positions, the right side behind is best. In any case, the clamp is to be adjusted and tried to see that it is open just sufficiently to be slipped in place and no more, so that a turn

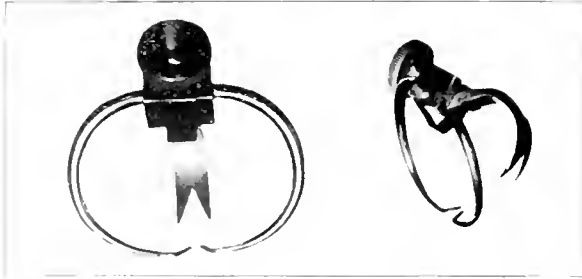

FIG. 95.

FIG. 96.



FIG. 97.

FIG. 95. The Hatch clamp, front view.

FIG. 96. The Hatch clamp, partially diagonal side view.

FIG. 97. Placing the Hatch clamp on a lower cuspid. Position for this tooth is left side behind. The rubber is pulled to the gingival by a grasp between the thumb and second finger. The forefinger is left free to come forward and assist in holding the foot of the clamp while the set-screw is tightened with the fingers of the right hand. In this case, the holes in the rubber have not been cut in the correct position, for it is seen that the upper lip will not be covered. Compare with Figure 99, which is correct.



FIG. 98.



FIG. 99.

FIG. 98. Placing the Hatch clamp. The grasp of the rubber with the left hand in stretching it to the gingival is not good in that the forefinger is used instead of being left free on the occlusal side of the rubber to assist in holding the foot of the clamp while the set screw is tightened. Compare with Figure 97.

FIG. 99. The Hatch clamp adjusted with correct adjustment of the rubber to the upper lip. A very dark treatment of decay with silver nitrate appears in the gingival portion of the cuspid tooth.

of the thumb-screw will fasten it. Then the rubber dam is to be prepared and placed. Choose a position in which the right hand will manipulate the clamp easily while the left holds away the rubber. There should always be one finger in place to steady the clamp and prevent it from turning when tightening the screw. If, in stretching away the rubber dam, the rubber is caught with the thumb and second finger of the left hand, as in Figure 97, leaving the first finger free, it will come forward at the instant needed, or it may be done by the second or third finger of the right hand which is ready also to come forward against the bow. Pull the rubber dam well out of the way so that the place to set the points of the clamp is in full view and give the screw a turn to fasten it. Then let the rubber draw against the points of the clamp. Settle the rubber carefully against the attachment of the gums to the tooth with a pellet of cotton in the foil pliers. Or the flat burnisher may be passed under the outer margin of the piece of rubber dam, and its point brought into position between the gum and the gingival side of the rubber. The gum may then be pressed back with one side of the instrument point while the other side is so inclined as to allow the margin of the hole to draw down next to the tooth. This will give a perfect view of the cavity, keep it perfectly dry and give command of the conditions for any operation needed. Generally this clamp may be used as far back as the second bicuspid, and occasionally on a first molar.

The pairs of root clamps, Figures 91-94, do important service in any case in which treatments should be placed in the canal of a root that has been prepared for an artificial crown or bridge abutment. These, if carefully placed, will hold securely on any root upon which a band can be placed. The rubber dam may be thrown over such a clamp and the treatment made as cleanly and securely as in any other case. They are a very essential clamp, and so far the only clamps that will do this work well.

With the most skillful operators, some impossible cases occur with any and all of these instruments. Then resort must be had to holding the dam in position with an instrument in the left hand while performing the operation with the right hand. This is difficult, but practicable, after it has been practiced sufficiently. The best instrument for this purpose is a straight shaft with a broad flat point cut in the form of a fork or a V-shaped notch.

Often in proximal cavities, where the gingival wall is very difficult to reach, the rubber may be forced into position and held

with a matrix, or the matrix may be placed first and securely tied and the rubber applied over it. Sometimes a similar device will accomplish the same purpose upon buccal surfaces. A plan I have often used in buccal cavities extending much beyond the gingival line, is to fill the cavity with an overplus of gutta-percha (after suitable preparation) and let it stand several days to push away the gums a little from the cavity margin. Then trim the gutta-percha to form with the gold finishing knives, Figures 380, 381, 382. Shape a piece of stiff German silver plate so that it will lay snugly on the filling and overlap the margins of the cavity. Warm this and stick it to the filling and adjust it to position. When cold, set the special clamp on this matrix and throw the rubber dam over it. This matrix should be only broad enough to easily accommodate the clamp. The gutta-percha can then be removed and one has command of the cavity.

REMOVAL OF LIGATURES AND RUBBER DAM. When the operation is completed, great care should be had to remove all ligatures before removing the rubber, for if the rubber is pulled away with a ligature on, a ring of rubber will sometimes be torn away and remain around the neck of the tooth unobserved and do great damage before the cause is discovered. Cut the ligature and pull it away first. In removing the rubber dam, always stretch it well to the labial or buccal and cut each septum going between the teeth with a small pair of blunt-end scissors. After the rubber is removed, examine it carefully to see if any part has been torn away and possibly left between the teeth or about their necks. The best way to do this, is to hold it up to the light to see that it is all there. This will avoid the danger of leaving bits of rubber dam hanging between the teeth. Finally, when the rubber has been removed, the gums should be well kneaded with the fingers, while being flooded with warm water from the syringe. The gums have been compressed and the circulation interfered with, and this will clean the parts and start the blood into full activity and prevent the severe soreness that will sometimes follow if this is neglected.

The Histological Structure of the Teeth in Relation to Cavity Preparation.

THE ENAMEL.

ILLUSTRATIONS: FIGURES 100-110.

THE structure of the enamel is of such importance in its relation to the preparation of cavities for filling that it requires special study. It is difficult to so prepare specimens of the enamel that they show its structure well, and when the specimens are well prepared it requires a large amount of study to gain that intimate knowledge of it that is necessary to the most intelligent practice in filling operations. On the ordinary book page, we can not place photomicrographs that are sufficiently amplified to show the enamel rods well and at the same time show a sufficient amount of the tooth form to give their relations. Therefore, the only way to study these effectively is under the microscope itself, but after the microscopic study, much more can be done by diagrammatic illustrations.

The enamel, when examined macroscopically, appears as a very hard, vitreous body, white, or a bluish white, very dense and brittle, in which no traces of structure can be determined. It cuts with much difficulty and is inclined to chip and crumble, but shows decisive cleavage lines. If, however, it is examined with a good hand magnifying glass, certain striations can be observed that give a suggestion of histological structure.

Although the enamel seems to be opaque, or slightly translucent, by ordinary examination, it is found to be almost as transparent as glass when ground into thin, finely polished sections. When so prepared, very little of the structure can be seen with the microscope without some preparation that will cause its histological elements to appear. It is largely for this reason that so little is seen of the structure of enamel in the sections ordinarily prepared for microscopic observation.

HISTOLOGICAL CHARACTERS OF THE ENAMEL IN RELATION TO THE PREPARATION OF CAVITIES.

Enamel is composed of rods or fibers cemented together by an intervening cement substance. These rods and cement substance have very nearly the same density or quality of refracting light, so that when examined in the perfect state, the enamel seems to be almost homogeneous, or without special structure. In the most perfect specimens of enamel, only a striation suggesting structure can be seen. It has been learned, however, that the cement substance between the rods, by which they are united, dissolves more readily in acids than the rods themselves. We may avail ourselves of this fact, and partially isolate the rods by solution of the cement substance with very dilute hydrochloric or lactic acid, and in that way obtain good views of them. We can not, however, carry this solution very far, for the reason that the rods will also be dissolved and the whole tissue disappear. Still, by working carefully with very dilute acids, the surface may be so etched as to give excellent views of the enamel rods.

The enamel rods seem to be made up of globules or little balls pressed together in rows or lines. One can readily copy this formation by taking small balls of soft clay and pressing one upon the other, forming a rod. In some enamel, these globular forms are very prominent in the apparent make-up of the rod and produce the cross markings on the rods seen in microscopic examinations in many of the illustrations. In some other specimens, these globules are so perfectly fused together and so smooth as to be almost invisible. This latter is rather the exception than the rule.

The enamel rods are stronger than the cement substance that unites them together, so that in any attempt to break up or cut the enamel, it is inclined to split along the length of the rods. Since the enamel is very hard and difficult to cut, a knowledge of the direction of the rods becomes of first importance in any attempt to form cavities in teeth. The rods, while hard to cut, are, when they are parallel, very easy to split apart. Indeed, much of human enamel will split almost as easily as straight-grained pine, if the force is applied in just the right direction to the margin of any opening that has been previously made. Figure 100. This is because the cementing substance that cements the rods together is much weaker than the rods themselves. In

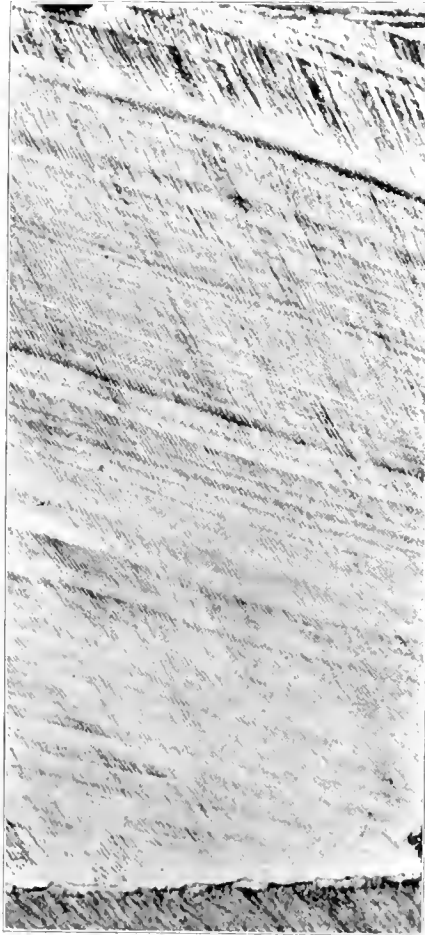

FIG. 100.

FIG. 100. Enamel with straight parallel rods.



FIG. 101.

FIG. 101. Enamel section showing curled enamel, or bundles of rods intertwined among each other. Notice that these become parallel in the outer third of its thickness.

other specimens of enamel, the rods, instead of lying parallel with each other, are very much interwoven and twisted together, as shown in Figure 101; so much so, indeed, as to prevent them being readily split apart. This enamel, instead of splitting like straight-grained pine, is more like the pine knot, which is very difficult to split or cut as compared with the straight-grained wood. Formerly it was supposed that this difference in the enamel to cutting instruments was due to a greater amount of calcium salts or the hardening element. We have learned in recent years, however, that this is not the case. The one contains no greater proportion of lime salts than the other and will not resist decay any better. But the difference is due wholly to the difference in the relative interlacing of the enamel rods.

This interlacing or twisted form of enamel is usually confined to the inner half or two-thirds of its thickness. While in the outer portion of the enamel, the rods are parallel and will split apart readily, the rods of the inner portion are interwoven or twisted in such a way as to prevent splitting, as shown in Figures 101, 102. Therefore, when a chisel or enamel hatchet is applied for the purpose of splitting it off, it will, if supported by sound dentin, split but part way and the remaining part of the thickness can be removed with great difficulty. It is then almost a necessity that we undermine this by cutting away the dentin from beneath it, after which we may break it down quite readily.

The enamel rods are almost always parallel with each other in the outer part or near the surface of the enamel. This fact should be observed carefully, for it is of the utmost importance in the preparation of the cavo-surface angles of cavities. All that we have said of the splitting apart of the enamel rods, applies with all of its force to this outer portion of the enamel, no matter how much the rods may be twisted in the deeper portions, and for this reason cavities should be so prepared that no portion of the cavo-surface angle will present short ends or rods unsupported; that is, if the enamel wall should be parallel with the length of the rods, a bevel of the cavo-surface angle should cut off the ends, as shown at *A* in Figure 103, so that there may be no loose ends of rods upon the surface to fall away while packing gold or after finishing the filling. This may readily be accomplished if we know the direction of the enamel rods. An enamel wall sloped as shown at *B*, Figure 103, makes the strongest wall possible, because there are no free ends of enamel rods in any part of its surface. In this case, the slope or inclination of the

enamel wall relates especially to its deviation from the direction of the enamel rods.

The direction of the rods may be known, first, by obtaining a good general knowledge of their course by the study of prepared sections of enamel; second, by observing the direction of cleavage during the preparation of cavities. By the term "cleavage" we express the tendency of a substance to split or separate in given directions. The direction of cleavage is the direction in which it splits most readily, which, again, is along the length of the enamel rods. Therefore, for our purpose, the terms "cleavage" and "splitting" are practically synonymous.

STATEMENTS OF THE DIRECTIONS OF THE ENAMEL RODS IN DIFFERENT PARTS OF THE CROWNS OF THE TEETH.

It may be stated, as a general rule, that the direction of the enamel rods is from the center of the crown of the tooth toward the surface, or better, they are most commonly at right angles to the surface. Everywhere on the crown of the tooth the ends of the enamel rods present to the surface. Over the greater portion of the crown, the direction of the enamel rods is perpendicular to the surface, but in every tooth there are certain portions in which the enamel rods approach the surface at a more or less considerable inclination.

(1.) In a central perpendicular section labio-lingually through an incisor tooth, the enamel rods will be cut parallel with their length in all of its parts, but they will not all be at right angles to the surface of the tooth. The deviations in this respect are shown in diagram, Figure 104.

(2.) In a central perpendicular section bucco-lingually through a bicuspid tooth, the enamel rods will be cut parallel with their length in all of its parts, but the enamel rods will not all stand at right angles to the surface of the tooth. The deviations in this respect are shown in diagram in Figure 105.

(3.) In a central section mesio-distally through a lower molar tooth, the enamel rods will be cut parallel with their length on the mesial and distal surfaces and over the marginal ridges onto the occlusal surface, but will be cut irregularly diagonally across in parts of the occlusal surface, depending upon the relation of the section to the developmental grooves and pits. This is illustrated in diagram, Figure 106.

(4.) In a perpendicular section from a point in the occlusal surface of a molar tooth in a line passing directly over the point of any cusp and along the axial line angle to the gingival line, the

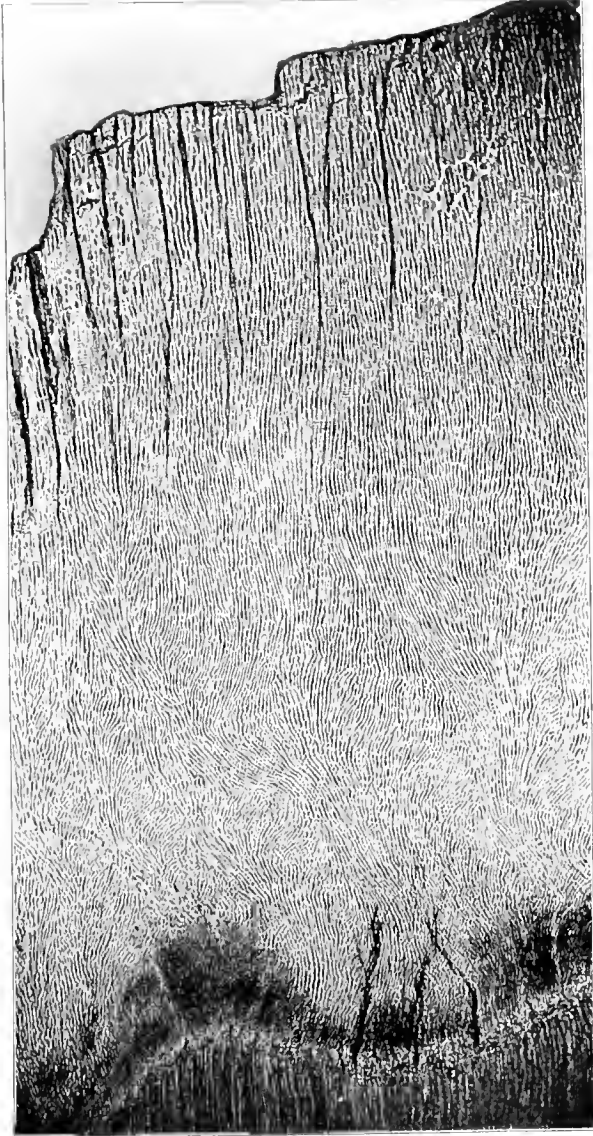

FIG. 102.

FIG. 102. Curled enamel.

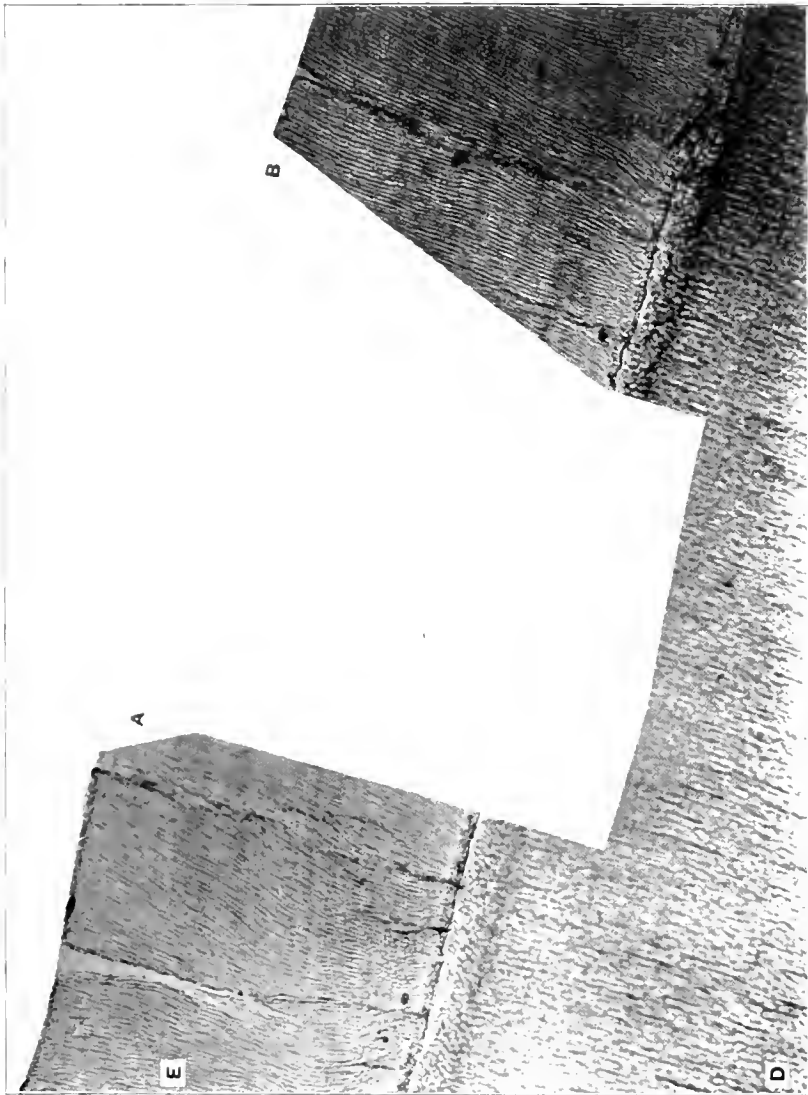

FIG. 103.

FIG. 103. A section of enamel through which a cavity has been cut into the dentin. E, Enamel. n, Dentin. R. A strong enamel wall with a strong cavo-surface angle. A, An enamel wall cut in such a relation to the direction of the enamel rods that it would be very frail and liable to chipping without the bevel of the cavo-surface angle shown at A. With the bevel shown the wall is good.

enamel rods will be cut parallel with their length in all of its parts. But the rods will not all stand at right angles with the surface of the tooth. The deviations in this respect are shown in diagram, Figure 107.

(5.) In a section perpendicular to the surface of a tooth cut across any deeply grooved developmental groove or pit, the enamel rods will be inclined toward the groove or pit from both sides. The deeper the opening of the groove or pit, the greater will be the inclination of the rods toward it and the larger the area of the enamel affected. Figure 108.

With the necessities for the formation of good enamel walls in view, a careful study of these diagrams in their relations to the surfaces of the teeth, the variations of the inclination of the enamel rods from a right angle to the surface in approaching and in passing over the cusps and the marginal ridges, the disturbance in their direction by deep grooves, fissures or pits, and their disposition over ridges and angles of the teeth, one should quickly obtain such an insight into the general principles controlling these deviations that he will be able to forecast them with reasonable accuracy upon the examination of any portion of the surface of a tooth. This careful study, with the end in view of so preparing the enamel walls of cavities that they shall be parallel with the direction of the enamel rods, and especially that there shall be no short ends of rods on their cavo-surface angles, is a necessity to close and careful work in filling teeth.

One of the first things to be noticed is that, when sections are cut parallel with the long axis and perpendicular to the axial surfaces of the teeth, the enamel rods are cut parallel with their length in every position from the gingival line to, and over, the marginal ridges and cusps of the occlusal surface of the bicuspids and molars, and the cutting edges of the incisors. Therefore, in the direction of these sections, the enamel rods are at right angles to the surface of the tooth at all points. The normal and regular deviations from the right angle to the surface are all in the direction of the length of the tooth so far as the axial surfaces are concerned. These are confined to the approach to the gingival line at the one extreme and the approach to the marginal ridges, cusps and cutting edges at the other. With this view of the case, the whole matter becomes very simple and the whole of these variations are shown in the five diagrams. While this is true as the statement of a general fact of normalcy that may be taken as a working basis of action in the preparation of cavities, it must not be forgotten that there

are frequent variations from the normal direction of these rods which must be found by noting the direction of cleavage, or feeling for it, as hereafter described.

If the attempt be made to prepare a cavity upon an axial surface of one of these teeth for filling, and this cavity approaches a cusp or a marginal ridge, the enamel wall must be inclined outward (or toward the occlusal) very greatly, or else short ends of enamel rods will be left at the surface. And if inclined enough to prevent this, the filling material will be so thin at its margin that it will not have sufficient strength. These facts forbid us laying enamel margins near the occlusal margins of the axial surfaces of the teeth. Figures 104, 105, 106.

On the occlusal surfaces of the bicuspid and molars, the matter would seem more complicated because of the greater variations of the disturbing causes affecting the directions of rods. In the larger sense this is true, but, from the standpoint of the preparation of cavities, it is, in fact, simpler. If we examine carefully the diagrams in Figures 105, 106, we will discover that the direction of the enamel rods in the occlusal surfaces is such that perpendicular and parallel cavity walls about cavities occurring in pits, will, except in very large cavities, be particularly strong enamel walls, because the inclinations of the enamel rods are all toward the center of the area in which fillings are made. In this, variations from this normal are rarely so wide as to turn the inclination in the opposite direction. It is only in the approach to the marginal ridges and apices of the cusps around the occlusal surfaces that especial care must be taken regarding the directions of the rods. In very large occlusal fillings this is always to be reckoned with, and the enamel walls sloped outward to agree with the outward inclination of the rods as shown in the diagrams. This inclination is found by examination of the cleavage, as will be described later.

In the incisors and cuspids, the general directions of the enamel rods are as shown in the diagrams. On the distal surfaces, where the distal angle is much rounded, the deviation of the enamel rods from the right angle to the surface begins farther from the incisal angle than upon the mesial surface and is often much more considerable before reaching close to the angle. The enamel wall at this point requires special care. The greatest difference occurs in the distal surface of the upper lateral incisor, which has the most rounded incisal angle. On the mesial surface, where the angle is acute, the change of direction occurs very suddenly at the incisal angle, and the considerable inclina-

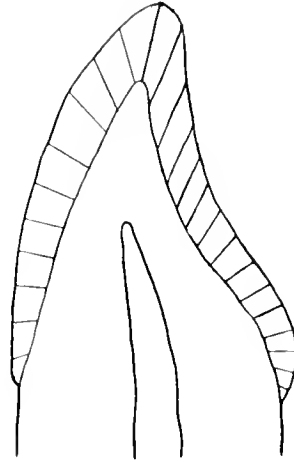

FIG. 104.

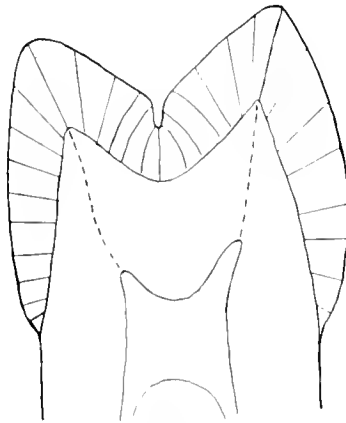

FIG. 105.

FIGS. 104-108. A series of diagrams representing the normal directions of the enamel rods over different portions of the crowns of the teeth, and the recession lines of the horns of the pulp. These latter are shown by the dotted lines reaching from the cusps to the horns of the pulp.

FIG. 104. An axio-labio-lingual section of an incisor in which the directions of the enamel rods in the different parts of the plane of the section are shown by lines from the surface of the enamel to the dento-enamel junction.

FIG. 105. A bicuspid tooth split bucco-lingually showing the directions of the enamel rods in the different parts of the plane of the cut. The recession lines of the horns of the pulp are shown by the dotted lines.

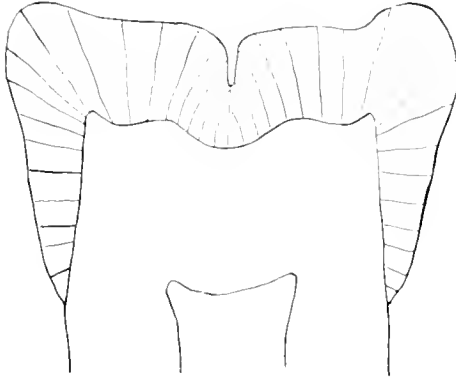

FIG. 106.

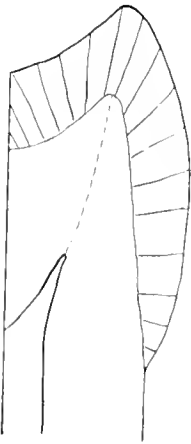

FIG. 107.

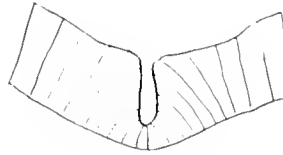

FIG. 108.

FIG. 106. A mesio-distal section of a lower molar tooth showing the more usual directions of the enamel rods in the different parts of the plane of the section.

FIG. 107. A perpendicular section through a cusp of a molar tooth showing the directions of the enamel rods in its several parts. The recession line of the horn of the pulp is shown by the dotted line.

FIG. 108. Section across a deep fissure showing the more general relation of the direction of the enamel rods to pits and fissures. This is an object lesson in the preparation of cavity walls. The margins of such fissures never chip or break before they are undermined by caries.

—

tion that would seriously interfere with the formation of the cavity wall is most generally so close to the angle as to be out of the way. Yet, it should always have careful attention. Cavities in the mesial surfaces of the upper incisors can therefore approach the incisal angle more closely with safety and afford opportunity for a good margin for a filling — without too thin an edge — than can cavities in the distal surfaces of these teeth.

In following the inclination of the enamel rods around the incisors and cuspids in the circumferential direction, we find them generally standing perpendicular to the surface at the junction of the middle and gingival third of the length of the crown. A notable exception to this, is the approach to and over the mesio- and disto-lingual marginal ridges. Here the enamel rods incline somewhat toward the marginal ridges, but, in passing over these ridges, their direction or inclination changes very suddenly and often very irregularly. For this reason this becomes rather a dangerous point in the preparation of proximal cavities in the incisors. When the marginal lines of these proximal cavities reach to the lingual marginal ridge, it is rarely safe to leave any of the ridge remaining, because of the very uncertain direction of the enamel rods. Especially is this true of lateral incisors in which the curve of the ridge is often very abrupt. While this ridge is very strong in the perfect tooth, it becomes very frail when its support on either side has been destroyed, and the only safe course seems to be to cut it away sufficiently to be certain of the direction of the enamel rods upon the margin formed. The rounding of the labio-mesial or labio-distal angles is not so abrupt, and the enamel rods usually hold closely to a direction perpendicular to the surface, so that good margins can be made at any point by observing carefully the form of the tooth and the enamel cleavage.

In following the varying inclination of the enamel rods as the gingival line is approached on buccal and labial surfaces on many teeth, considerable deviations from the normal will be noted. The photomicrograph, Figure 109, is an example from the gingival third of the labial surface of an incisor in which the course of the rods is very irregular, showing many twists and turns. The checks in it show the easier cleavage lines that would be found in chipping with a chisel. The ragged character of the breaks would be noted by an experienced operator as indicating the irregular course of the rods. Similar irregularities will be found frequently in any parts of the enamel. These are shown by the checks in the buccal surface of the bicuspid cut in cross

section, Figure 197, and a much greater irregularity may be noted in Figure 97, Volume I, in a photomicrograph showing a segment of a cross section of carious enamel. Such examples show that the normal directions shown by the diagrams can not be too implicitly depended upon in preparing cavity walls. These must be verified by the chisel and corrected.

HOW TO STUDY THE DIRECTIONS AND INCLINATIONS OF THE ENAMEL RODS.

The first studies of the enamel rods should, of course, be made by grinding sections, etching them before mounting, so that the rods may be seen well, and studying these with the aid of the microscope. But when a fairly good idea of the structure has been obtained in this way, one should continue the study by using the chisel in splitting off the enamel, which is the easiest way of removing frail margins, and noting carefully the cleavage of the enamel while operating at the chair. In preparing cavities, the direction of the cleavage should be carefully noted, and, knowing that this cleavage follows the length of the enamel rods, one may be continuously studying their direction in different positions upon any and all of the teeth. This study, when pursued for some time, enables an operator to so place his instruments (hand instruments only should be used) as to split off the enamel easily in opening cavities, which is of immense advantage, as he will do it easier and quicker than by any other method. Irregularities in the course of the rods, which occur frequently, will be detected and the enamel wall may be inclined more or less to avoid leaving short ends of rods at any point. This knowledge can be obtained only by the use of hand-cutting instruments. If there was no other reason for using them instead of burs this would be sufficient. The operations will also be greatly improved because of more perfect preparation of the enamel walls and cavo-surface angles. One soon learns to feel for the direction of the enamel rods with the cutting instruments and to take advantage of the irregularities of the cleavage in cutting the enamel, and then readily feels this in the formation of the enamel wall and its cavo-surface angle and knows when the enamel margin is firm and strong. One who will carry on the study at the chair will become a rapid and strong operator.

The shaving or planing of the enamel in finishing the enamel wall should be looked to with great care. Those points at which the enamel rods are more or less broken apart will generally appear a little whitish, and, in pushing a sharp edge

lightly along them, the loosened rods are easily dislodged in what appears as a fine powder. This whitened appearance may be due to caries of the enamel. In this case, all of the whitened part must be cut away. If the enamel is sound, by continuing the shaving motion it will become clear and have a firm, vitreous appearance. This condition of the enamel wall should always be obtained in finishing the preparation of the cavity.

Rarely there are white spots in the enamel because of imperfect development (See Figures 46, 47, Volume I) that may be included in the area of the cavity or appear on the line upon which the enamel margin should be found. In the latter case it will become a question whether to cut them out or leave them. When these are covered in with a good glazed surface, it is perfectly safe to leave them, provided a good filling can be made without breaking the margin. Generally this may be done; though in some cases they should be cut away. These white spots must be distinguished sharply from caries of enamel which also may show as white spots. Both cut more easily than normal enamel. Generally the white spots due to faulty development have a glazed surface; carious spots do not. Often caries of the enamel occurs as a considerable area of whitening on several teeth, particularly on buccal surfaces in which the enamel rods have been separated to a considerable depth, as shown in Figure 110. This is often spoken of as chalky enamel. The condition has been produced by caries.

In the study of the enamel in sections, it has been seen that the lines of the grooves are weak lines on account of the imperfect fusion of the enamel plates in coming together during development. This is true even in those grooves that are most perfectly closed. But in very many cases they are imperfectly closed, so that along these lines the enamel has no strength. Also when cutting near to a groove, the enamel rods incline toward the groove, increasing the danger of leaving short ends of rods at the cavo-surface angle.

RULE: When in the preparation of a cavity, the line of the cavity margin must approach near a groove, cut past the groove.

This rule should be regarded as applying in all positions upon the teeth if the cavity margin is parallel, or very nearly parallel, with the groove. For instance, in preparing large cavities in the distal surfaces of upper molars, the lingual portion of the disto-lingual groove is often approached. In such cases, the enamel should be cut away, including the groove, to and over the ridge onto the lingual surface, where its direction is more to

the mesial. Then break away from it rather suddenly, forming a kind of step, if the enamel of this portion of the lingual surface is strong enough to remain. See Figures 225, 226.

If the mesio-buccal angle of a molar is so decayed as to make the removal of a considerable part of it necessary, cut to the buccal groove, for if this is not done the intervening portion of the enamel is very likely to break away. The same rule applies to the triangular grooves of the bicuspids that pass over to the buccal surfaces to the mesial and distal of the buccal cusps. If, in any case, the enamel of the angles of these teeth is so undermined by decay that the cavity lines should approach near these grooves, cut past the grooves.

In any case in which the angle of an incisor must be removed, cut to the labial groove, whether it be mesial or distal. This is for the reason that the lines of the grooves are weak and the enamel is likely to break along them.

RECESSIONAL LINES OF THE PULPAL HORNS.

These are the lines along which the pulp has receded during the growth of the dentin. They are also the lines in which unusually long horns are found and often exposed when these lines are cut. The accidental exposure of the pulp usually occurs from the cutting of the recessional lines at too great a depth in the tooth, or too close to the body of the pulp.

In the early growth of the tooth, the full size of the occlusal surface of the tooth is represented when the first joining of the enamel plates of the several lobes of the tooth has occurred. At this time but a very thin layer of dentin has been formed on the inner surface of the enamel cap. The whole, practically, of the dentin of the crown of the tooth is represented in pulp tissue. The dentin grows from the dento-enamel junction inward. The pulp recedes and becomes smaller as the dentin is formed. This is rapid, comparatively, during the childhood period, but under normal conditions gradually slows down until the person is forty years old or past. Under abnormal conditions of irritation from very slowly progressive caries, erosion, abrasion, etc., this is much hurried; and may go on to the complete obliteration of the pulp chamber. In this normal and abnormal recession of the pulp, the pulpal horns become shorter and shorter. It is the track of this recession of the horns of the pulp that we call the recessional lines of the pulpal horns. It not infrequently happens that a horn of a pulp will persist as a slender thread of

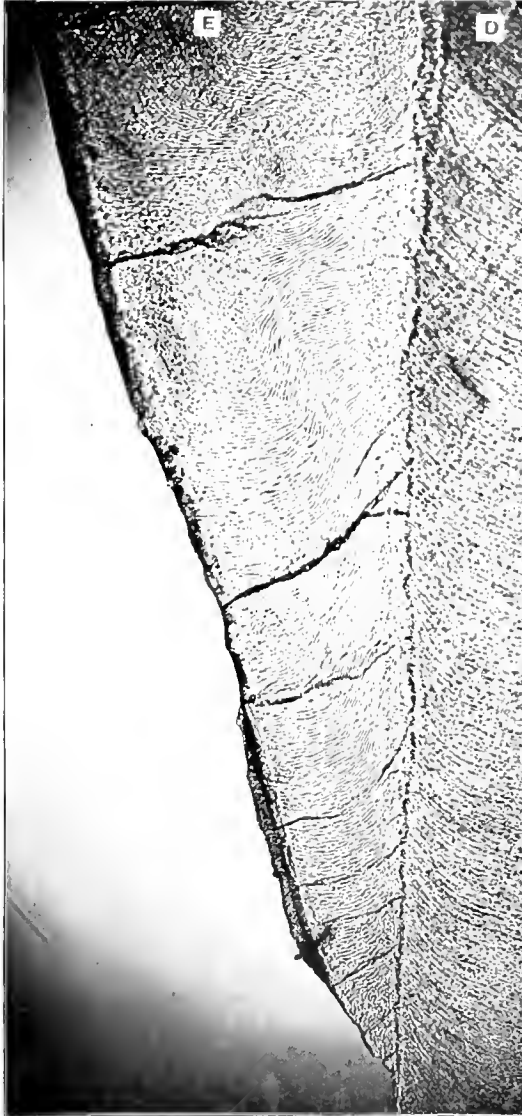

FIG. 109.

FIG. 109. The enamel of the gingival portion of a section of a tooth showing the general direction of the enamel rods. In some portions of the section, however, considerable deviation from the usual course will be noticed.

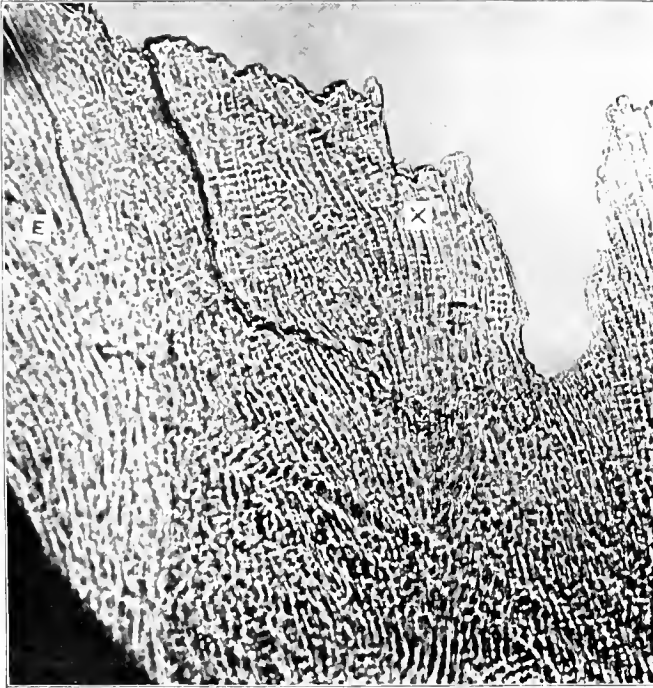

FIG. 110.

FIG. 110. Carious enamel. E. Sound enamel. X. Carious enamel. Notice that the enamel rods seem smaller in the carious portion. This is much easier cut with a chisel than sound enamel.

pulp tissue reaching far toward the point of a cusp to or past middle age, even when the pulp chamber has become quite small.

Careful observation shows that fully ninety per cent of the accidental exposures of the pulp in the preparation of cavities of medium and moderately deep decays occurring in either occlusal pits or proximal surfaces in molar teeth, are exposures of the horns of the pulp. These exposures are all made by cutting across the recessional lines of the pulpal horns. These lines are, therefore, especially dangerous.

The recessional lines lead from the axio-occlusal margin or crest of the pulp on one of its angles, toward the point of each of the cusps of the tooth. This line is usually nearly straight, but a little bent in the form of the concavity of the occlusal surface of the tooth. In Figure 105, the recessional lines of the pulpal horns are indicated by dotted lines. The anatomy and histology of the tooth in respect to these lines should be very closely studied for the advantage it will give in locating and avoiding these lines in the excavation of cavities. If the reader will review the forms of occlusal and occluso-proximal cavities in molar teeth illustrated in this book, he will find that in all but a single one, of those with living pulps, the recessional line of the mesio-buccal horn of the pulp has been avoided in their preparation. When the decay is such that this can not be done, the pulp is in imminent danger of exposure. This one cavity making the exception, is the cavity prepared for the illustration of the packing of gold. This cavity was cut as broad as would be permissible in the tooth of a person forty or fifty years old. It was cut broad for the purpose of giving the best view of the progress of building a gold filling. While there are frequently conditions that justify the formation of such a cavity in persons of advanced age, this one should not be taken as typical of the usual preparation of cavities in the molar teeth. For young people such lines of cavity preparation would expose many pulps for the reason that the recessional line of the mesio-buccal horn of the tooth would be cut.

While the mesio-buccal horn of the pulp is the most dangerous of the horns of the pulp in the molar teeth in regard to exposure, counting very much the larger number of accidents, the mesio-lingual horn of the lower molar is also very dangerous. Indeed, all horns of the pulp have their recessional lines, and all of these are to be shown due respect in cavity preparation.

The recessional lines of the crests of pulps may also be traced in histological specimens. While these are much lower

than the horns, they are responsible for a minority of the exposures by accident in the preparation of cavities in the proximal surfaces of the molar teeth. In proximal cavities the crest of the pulp is a frequent point of exposure by decay.

Probably the best means of studying the forms of the pulp chamber is to obtain teeth not too much decayed from numbers of persons of known age, from childhood to advanced life, cut them in the horizontal plane at or near the gingival line, leaving the greater part of the pulp chamber in the crown portion. A sufficient number of such specimens, if carefully studied in series, would give an excellent idea of the progress of shortening of the horns of the pulp and the general reduction of its size by reason of age.

In the preparation of cavities, the rule should be to avoid cutting any of the recessional lines of the pulpal horns whenever the extension of decay will allow of its complete removal without so doing. In the preparation of proximo-occlusal cavities there is usually room to occupy one-third of the bucco-lingual breadth of the tooth in a step without interfering with the pulpal horns, provided the step is not cut too deep, i. e., deeper than necessary for substantial strength. In mesial cavities in upper molars, the occlusal step may be rather broader than in distal cavities in upper molars, or in mesial or distal cavities in lower molars, because the lingual horn of the pulp in the upper molars is placed farther to the distal, giving more room in the neighborhood of the mesial surface. In all of the molar teeth there is more danger from cutting these recessional lines in the mesial than in the distal areas because the pulpal horns are longer, giving less room between the occlusal surface of the tooth and the probable ends of the pulpal horns.

CAVITY PREPARATION.

DEFINITION. By the phrases "Excavation of cavities," "Preparation of cavities," or "Cavity preparation," is meant such a mechanical treatment of the injuries to the teeth produced by dental caries as will best fit the remaining part of the tooth to receive a filling restoring the original form, give it strength, and prevent recurrence of decay in the same surface. To do this best requires a good knowledge of the pathology of dental caries, as a basis for further study by observation and practice. In this place certain leading facts as to the character of these injuries, and the steps of the progress of caries, though given before, will be regrouped and given as a guide to the beginning of the work of cavity preparation.

BRIEF REVIEW OF THE INJURIES TO THE TEETH BY CARIES, IN THEIR RELATION TO CAVITY PREPARATION.

ILLUSTRATIONS: FIGURES 111-119.

Caries never begins on clean, smooth surfaces of the teeth. So long as the function of mastication of food is normally performed, much the greater proportion of the surface of each tooth is habitually kept sufficiently clean to prevent caries from beginning. In chewing, food stuff is forced over the surfaces of the teeth at each meal time, cleaning most of the surface of each tooth, preventing decay at all points so cleaned. There are, however, certain regions of the surface of each tooth that are so protected by their position, or by their form, that they are not well cleaned by this process. Of these there are two main divisions in which caries occurs: (1) Pit and fissure cavities; (2) Smooth-surface cavities.

PIT AND FISSURE CAVITIES. These occur in the pits, fissures, or deep grooves in the occlusal surfaces of the bicuspid and molars, less frequently in pits in the occlusal half of the buccal surfaces of the molars, and occasionally in pits in the lingual surfaces of incisors. In a few instances also caries will occur in the lingual portion of the disto-lingual groove of the upper molars, or in the mesio-lingual groove when there is a fifth cusp

on an upper first molar. All of these are on the occlusal portions of the teeth, which are well cleaned by mastication except as lodgments occur in these pits and grooves.

In each instance dental caries is caused by a colony of microorganisms which grow in contact with the enamel in a secluded place, covered in and protected by a gelatinoid substance which they form, or by debris, or other similar coating which will seclude the colony from disturbance and allow continuous growth. In this seclusion they form acid products which are protected from washings by the general fluids of the mouth, which would dissipate them. This latter is a necessary condition in order that the acid formed may act upon the calcium salts of the enamel and destroy it. In acting upon enamel microorganisms never enter the tissue, but remain on the surface. The acid acts by percolation into the enamel from the surface. The enamel is a solid having no natural openings into which microorganisms can grow. They can not enter the substance of the tooth until the enamel has been penetrated by solution by the acid. This far microorganisms and their acid products must be protected by some kind of covering. After they have entered the dentinal tubules they form their acid products within the tissue itself, and the softened dentin forms a sufficient protection.

Decay beginning in pits and fissures, where protection is secured by the depth of these, does not spread on the surface outside of the pits or fissures, because all of the enamel surface about them is cleaned by the scouring of food in mastication. It is confined in the first instance to the deeper part of the pit, as shown by the photograph in Figure 111. The area of such decays in the enamel may be represented by a cone, with its base at the dento-enamel junction, Figure 112. After it has penetrated the enamel, it at once spreads in every direction along the dento-enamel junction, as shown in outline in the diagram Figure 112, in the occlusal portion of the tooth represented. It also follows the dentinal tubules toward the pulp of the tooth, forming a conical area of decay in the dentin with the base of the cone against the enamel. At the same time the enamel decays from within outward (backward decay of enamel) in the area which has been undermined. This finally causes the enamel covering to crumble. This form of decay is shown in the photograph, Figure 113, in a case in which the point of the cone has extended to the pulp of the tooth.

In the preparation of cavities of this class it is only necessary to remove the enamel covering the area undermined by

caries, and form the cavity in the dentin, as will be described later. Further extension is not necessary for the prevention of caries except as it may be required to follow out deep grooves to places where a good, smooth finish of the filling may be made.

SMOOTH-SURFACE CAVITIES. In the beginning of caries in the smooth surfaces of the teeth, the reverse of this is found. These surfaces are free from any defects. The enamel is smooth. The decay beginning in this smooth enamel constantly shows a tendency to spread within certain limits upon the surface, and to penetrate from the surface inward in a continually widening area. Therefore, instead of presenting a conical form in the enamel with the base of the cone toward the dento-enamel junction as shown in the occlusal pit in Figure 112, it presents a cone with the base at the surface of the enamel, as shown in the same figure near the gum line of the buccal surface, being just the reverse of the condition found in the pit cavity. A decay of the enamel of this form, that has penetrated the enamel only part way, is seen in the mesial surface of the tooth in the photograph, Figure 111. It appears as a slightly whitened area. This is again shown in diagram, Figure 114, in both of the proximal surfaces and in the buccal surface. Note particularly the difference in the breadth of the base of the cone on the surface of the enamel in Figure 112, which is a section cut in the axial plane bucco-lingually, and in the buccal surface in Figure 114, which represents the same decay cut in the horizontal plane. This tendency to spread most in particular directions on the surface of the enamel is also a constant character in decays of the enamel beginning on the smooth surfaces. If the decays in the mesial and distal surfaces illustrated in Figure 114 were cut in the axial plane, they would appear as cones with very narrow bases on the surface of the enamel, because the principal spreading from a central starting point is buccally and lingually. This important clinical fact is strongly shown in the photograph of a cross section of a bicuspid tooth with broad spreading decays of enamel on the proximal surfaces, Figure 115. This is also shown again in diagram Figure 117, in which the several teeth are cut in the horizontal plane. The decays of the enamel, shown by the darkened areas, are all broad when cut in this direction, while if they were shown cut in the axial plane, they would be narrow. It will be noticed that the bucco-proximal angles of the teeth are in each case left white, indicating that decay has not spread across these angles. This represents a fact which becomes apparent when the cavities occurring in a considerable number

of persons are tabulated. The angles are almost always immune to decay, but a few cases will be found in which decay has crossed these angles, or in which decays from the proximal and buccal surfaces have joined. Cases will rarely be found in which decay has surrounded the crown of the tooth completely. Therefore decays beginning in the smooth enamel have a constant tendency to spread on the surface in a direction around the crown of the tooth, but very seldom cross an angle.

This is illustrated in diagram Figure 116. In this figure the lowest line, the dotted line, represents the gingival line at which the gums are attached to the tooth. The next dark line, which is continuous from tooth to tooth, represents the position of the free margin of the gum, and the width of the space between this and the dotted line represents the depth of the free portion of the gum, the gingiva, and the distance to which this overlaps the enamel. The double line which cuts through the darkened areas and rises toward the occlusal as it passes to the proximal surfaces, represents a saw-cut along the center of the most susceptible area to the beginning of decay as it passes around the crowns of the teeth. Figure 117 represents the same teeth after the occlusal portions of the crowns have been removed. The line of greatest susceptibility will be seen to be near, but not quite touching the free border of the gum in every part, following the arching of the gum septum between the teeth. Figure 118 shows the portion of this line that is most highly susceptible on the proximal portion, while Figure 119 shows the same on the buccal surface. If a similar line were drawn about the crowns of the incisors and cuspids, it would similarly represent the areas of greatest susceptibility as they exist on the smooth surfaces of these teeth. Of this line the central part of the proximal portion is the most susceptible to the beginning of caries. The tendency is to spread buccally and lingually. In persons who are making the normal use of their teeth in chewing food, this seldom, if ever, spreads across the angles of the tooth to the buccal or lingual surfaces. The extent of spreading to the buccal and lingual is very variable, and is controlled in large degree by the shape of the proximal surfaces. When the teeth are well rounded, the points of proximal contact narrow, the embrasures to the buccal and to the lingual deep, food runs through them well in chewing, and keeps the surfaces of the teeth forming these embrasures, i. e., the angles of the teeth, well cleaned. In this case the area of decay will be narrow bucco-lingually. In the reverse conditions, in which the proximal contacts are broad, the surfaces of



FIG. 111.

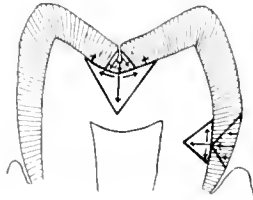

FIG. 112.



FIG. 113.

FIG. 111. A photograph from an upper third molar split mesio-distally in the axial plane, showing a whitened area of beginning decay in a pit in the occlusal surface, and a slighter decay of enamel in the mesial surface, showing as a whitened area.

FIG. 112. A diagrammatic representation of the penetration of enamel and dentin in the central pit of the occlusal surface, and also on the smooth buccal surface, in a molar tooth cut buccolingually in the axial plane. In each, the particular direction of the penetration in each tissue is shown by small arrows. In the occlusal pit there is no spreading of decay on the surface of the enamel; the area of enamel involved is broadest at the dento-enamel junction, forming a conical area of decay with the base at the dento-enamel junction and the apex at the surface of the enamel. On the smooth enamel of the buccal surface the decay spreads laterally on the surface, each part of the widened area of beginning penetrating in the line of the length of the enamel rods, which gives a conical area of decay with the base of the cone at the surface of the enamel. Notice that after the penetration of the enamel, decay at once spreads laterally along the dento-enamel junction in every direction. This direction of spreading is confined to an area very close to the dento-enamel junction, but as each new dentinal tubule is reached, spreading along it toward the pulp of the tooth occurs. In the first ones entered it goes the deepest because they begin first, and this gives a conical area of decay.

FIG. 113. A photograph from a split upper molar, showing a blackened area of decay in the dentin, which has begun by the penetration of the enamel through the occlusal pit.

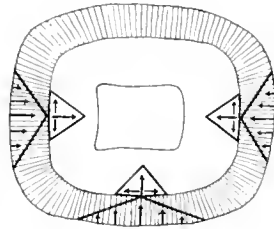

FIG. 114.

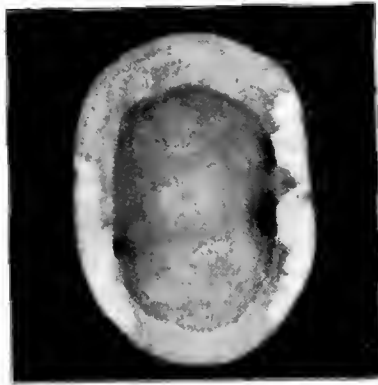

FIG. 115.

FIG. 114. A diagrammatic representation of a cross section of a lower molar, showing beginning decays in the proximal surfaces and in the buccal surface. In these the directions of the penetration are marked by arrows. Notice that these are broader than in Figure 112, for the reason that the greater spreading of decay of the enamel is in a direction around the crown of the tooth.

FIG. 115. A photograph from a cross section of a bicuspid tooth, showing broad whitened areas of caries of enamel on the proximal surfaces.

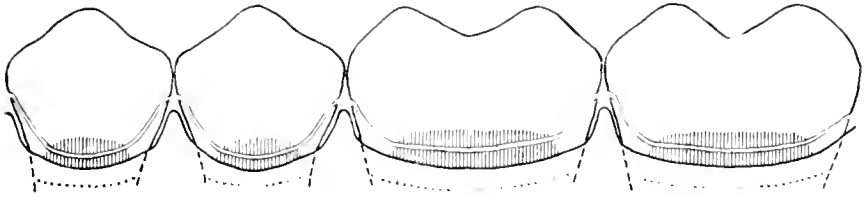

FIG. 116.

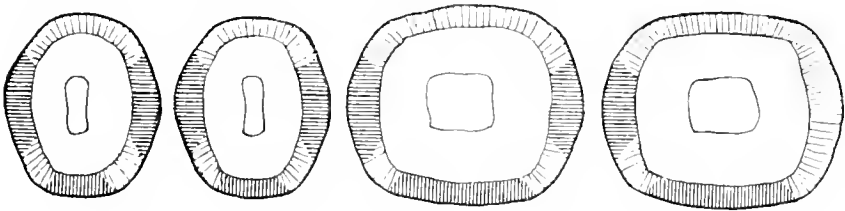

FIG. 117.

FIGS. 116, 117. A diagrammatic representation of caries of the buccal surfaces, Figure 116, and of cross sections of the crowns, Figure 117, of the lower first and second bicuspids and first and second molars, showing the location of caries and tendency to spread in a direction around the crowns of the teeth, following the free margin of the gingiva. In Figure 116, the dotted line represents the gingival line, or line of the attachment of the gum tissue to the teeth. The continuous dark line represents the line of the free margin of the gingiva, which arches toward the occlusal in passing between the teeth. The double line represents a saw cut dividing the crowns through the decayed areas of the enamel. Figure 117 represents the decayed areas of enamel exposed by cutting away the crowns. The portions darkened represent the parts of the enamel most liable to caries, while the areas left white at the mesio- and distobuccal angles of the teeth represent areas that are almost always immune to caries.

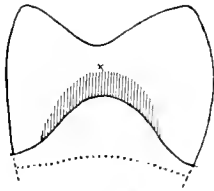

FIG. 118.

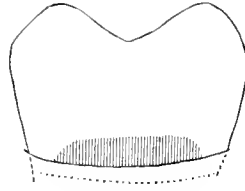

FIG. 119.

FIGS. 118, 119. Diagrammatic representation of the areas of liability to caries on the proximal surfaces of the bicuspids and molars, Figure 118, and on the buccal surfaces of the bicuspids and molars, Figure 119. The arching of the free border of the gum tissue as it passes between the teeth is illustrated in Figure 118. The form of this arch varies greatly in different cases. In many, and particularly in young persons, the summit of the arch is nearly flat for a more or less considerable space.

the teeth very flat, the embrasures shallow, and much of these surfaces are in near approach to each other, decay beginning in the enamel will be likely to spread from angle to angle, as shown by the whitened enamel in the transverse section of a bicuspid, Figure 115. It will be noted particularly that this condition gives the poorest opportunity for the cleaning of these parts by the friction of food in mastication.

These conditions furnish the information upon which cutting for extension for prevention should be based in the preparation of proximal cavities. The most general rule is to extend in each individual case toward the buccal and lingual angles of the tooth to such a point that the cavity margin will be so separated from near contact with the proximating tooth that food will run between the two in mastication and keep the margin of the filling clean. The amount of this will, of course, depend upon the form of the contact point and of the rounding of surfaces of the teeth.

On the buccal surfaces the area of greatest susceptibility is usually near the center mesio-distally, close to, but just a little to the occlusal of the free border of the gum. This is a variable point. In the child the gingivæ are long, covering a considerable part of the crowns of the teeth. As the child grows older, the gingivæ become shorter and cover a less amount of the crowns of the teeth. As the person grows old, the gingivæ disappear almost entirely so that practically the whole of the enamel of the teeth is exposed to view. Therefore if decays in this position have begun in the child, they may be mid-length the crown when the child has arrived at adult age. Therefore the particular position of the beginning of these decays on the buccal surfaces will depend much on the age of the patient at the time of their beginning. They are, however, always near the free border of the gingivæ at the time of beginning. If such cavities are filled for young persons without pushing the gingivæ well back in each case so that the border of the cavity can be extended well under it, the natural shrinkage of the gingivæ will soon expose the enamel between the gingivæ and the filling. This will then be liable to decay again. Fortunately these decays are not frequent in young people.

The extension of these cavities from the center of the surface far toward the mesial and distal angles of the tooth is so common that the rule should be to cut them close to the angles of the tooth in every case, but never past the angle. That is the only safe course to pursue. If that is not done and the susceptibility to decay (which will receive mention below) continues,

decay is quite certain to rebegin to the mesial or to the distal, or both, and the filling will be lost. In these cavities there is generally no need of extension toward the occlusal farther than is required to remove all caries and obtain a good enamel and dentin wall. In speaking of the smooth-surface cavities, only caries of the enamel has been mentioned, for the reason that caries of enamel is the first lesion and is of principal importance in the preparation of cavities. It is sufficient to say that when caries has entered the dentin its penetration of that tissue is the same as in pit cavities. That is, the spreading in dentin is in every direction along the dento-enamel junction, and the direction of penetration is along the dentinal tubules directly toward the pulp of the tooth.

In all of this it must be remembered that there is a general or systemic susceptibility to dental caries, and there is also immunity to dental caries, independently of the local conditions discussed above. In every community some persons are found who never have had a decayed tooth. In these the local conditions may be just as favorable to decay as in others. Pits and grooves in their teeth may be deep and well calculated to hold lodgments, and yet caries does not occur. The systemic conditions are such that caries does not occur even if the contacts are broad, etc. Persons who are very susceptible to caries in their youth, tend to become immune as they grow older. Quite a large proportion of persons become immune to dental caries when they arrive at adult age, provided the teeth have been properly protected, and they have continued to use them vigorously in chewing food. On the other hand, if persons neglect carious cavities, if the teeth become sensitive to such a degree that this interferes with mastication, the tendency to caries will generally become worse and worse and the teeth will be lost. This seems to be because the teeth do not have the cleaning effect of active mastication.

ORDER OF PROCEDURE IN CAVITY PREPARATION.

GENERAL PRINCIPLES. There are certain fundamental principles that are general to the excavation of carious cavities in the teeth, the observance of which will simplify and facilitate these operations, which may be expressed as follows:

First, obtain the required outline form.

Second, obtain the required resistance form.

Third, obtain the required retention form.

Fourth, obtain the required convenience form.

Fifth, remove any remaining carious dentin.

Sixth, finish the enamel wall.

Seventh, make the toilet of the cavity.

In certain conditions, which will be given in detail later, the fifth of these should be placed as the second. These will be found to be exceptions to the general rule.

The careful observance of this order of procedure by the student will greatly facilitate his operations, lead to more careful consideration of the requirements in individual cases and will guide him to the use of the appropriate instruments for the different parts of the operation.

OUTLINE FORM is the form of the area of the tooth surface to be included within the outline or enamel margins of the finished cavity; the laying out of and cutting to these lines should be the first thing considered and accomplished. In all pit cavities the outline of the cavity will be found by cutting away all enamel overhanging the decayed area, completely uncovering it, and following out any sharp grooves connecting with the cavity to such points as will enable a perfect finish to be given to the margins of the filling when placed. This should always be done before there is any attempt made to remove the decay from the deeper parts of the cavity. As these cavities occur in surfaces of the teeth that are habitually cleaned by the abrasion of mastication, except for lodgments in the pits or fissures in which the decay begins, no further extension is required. In this class of cavities this work is done generally with chisels and the enamel hatchets. However, in the first opening of pits in which but little decay has occurred, and in following out fissures and grooves, the bur is often the best instrument.

In smooth-surface cavities, that is, in proximal cavities and in buccal and labial gingival third cavities, which do not begin in pits or fissures, but occur in the central portion of an area of uncleanness that is habitual, in which the superficial injury to the enamel tends to spread, the laying out of the outline form of cavities is done upon a different principle. In these it is not simply cutting away overhanging enamel for the exposure of the dentin already decayed, but the object should be to include within the outline of the cavity such portions of the surface as are especially liable to decay in the future. As decay is liable to occur upon areas of surfaces habitually unclean, and only upon the unclean areas, the whole of the habitually unclean area should be included within the outline of the cavity. This requires a careful study of the conditions surrounding each smooth-surface

cavity and the extension of the cavity outlines to include the area of the surface that may have suffered superficial injury, or is in danger of decay in the future. This will often require that sound enamel and dentin be cut away to obtain the correct outline form, and is known as extension for prevention of the recurrence of the decay. The study of the case should be made, the outline determined upon and the cavity cut to the outline form required as the first procedure.

If the student will take a large number of decayed teeth and select all of those that have small cavities in some one or more of their surfaces, which properly represent the place of the beginning of decay, he will find a remarkable uniformity as to the particular spot in each individual surface in which decay begins. In all of the pit and fissure cavities, he will find that the decay of the enamel, superficially, is confined to the immediate pit or fissure, but that it spreads in the internal parts of the tooth and the enamel finally is decayed from the inside outward; backward decay of enamel. In all, or nearly all, of the smooth-surface decays, when small, he will find a different condition, the decay beginning in the surface of the enamel tends to spread superficially on the surface from some point, usually central to the surface, toward the margins of the surface. In this superficial spreading of decay, the widest possible variations will be found, from decays of exceedingly small superficial area to those that are very broad. It is only after the decay has penetrated the dentin considerably that the enamel is undermined, as in the pit and fissure cavities. In this study, the student should note particularly the number of decays he can find beginning upon the axial angles of the teeth and make a careful comparison of the number of these with those beginning centrally upon the surfaces. This will demonstrate very certainly that the axial angles of the teeth are, on account of their position, comparatively immune to decay, and point out to him the directions and extent to which extensions of cavities should be carried in their preparation for filling to prevent the recurrence of decay after the filling has been made. In this, he will find that extensions should be made toward the angles, and that such extensions should never be carried past the angles. The central area is most liable to the beginnings of decay, the angles least liable to decay. Hence, any extension beyond an axial angle would be an extension into a region of greater liability to decay.

RESISTANCE FORM is that shape given to a cavity intended to afford such a seat for the filling as will best enable it to with-

stand the stress brought upon it in mastication. Its importance stands in direct relation to the degree of the exposure of the filling to the occlusion and to the strength of the closure of the teeth. It is necessary to provide for a force of from one to two hundred pounds, and, in some cases, more. The resistance form consists in a flat seat for the filling, cut at right angles with the direction of the stress of mastication, or usually, at right angles with the long axis of the tooth. In occlusal cavities, for example, the pulpal wall is to be cut flat and all of the surrounding walls should be cut to definite angles with the pulpal wall. In proximo-occlusal cavities, in which the greatest possible support is needed, the gingival wall of the proximal portion is cut flat and in the horizontal plane, with definite angles. The step is also given a flat, horizontal seat. However, if in any case cutting to a flat form to the full depth of decay in the central part will endanger exposure of the pulp, the squaring-out should be in the form of a shelf around the margins, as will be explained later.

RETENTION FORM is the provision for preventing the filling from being displaced. A large part of this is provided for by the resistance form. But it is further required that provision be made that will prevent the filling from being thrown out of the cavity by such lateral or tipping force as may be brought against it. All cavities should be provided with ample retention form, but this provision is required in its most perfect form in mesio- or disto-occlusal cavities in the bicuspid and molars. In these the provision is made in the form of a step cut into the occlusal surface, which is more or less dovetailed. In most cavities the retention form is made by so shaping certain of the opposing walls that they will be strictly parallel or slightly undercut in order that when the filling material is thoroughly packed between them, it will be securely held in place. This is done variously in different situations. It is to be looked to especially when the outline and resistance form of the cavity has been developed. Formerly, pits and grooves were much depended upon for this purpose, but have proved delusive, so that laterally it has been required that the form of the walls be such as to perform this function.

CONVENIENCE FORM, though secondary to other points in the formation of cavities, should not be neglected. When the general form of the cavity has been developed, modifications are to be made that will render the form more convenient for placing the filling material. Often by cutting a wall away to a certain inclination, the plugger point will reach some portion of the

cavity better or at a more available angle, enabling the operator to pack gold more certainly and more securely in certain important parts of the cavity. Also such cutting may render the filling so much more convenient as to save time and much wear and tear upon both patient and operator.

A second order of convenience form consists of slight undercuts situated in angles or other parts of the cavity as starting points in packing gold, or that will hold the first portions of the filling material while other portions are being packed, or until the true retention form of the cavity has been filled. The study of the use of these conveniences and the wise placing of them, is especially important, as it assists in starting the filling and securing the first portions. These pits and grooves are usually placed in the axio-linguo-gingival and axio-bucco-gingival angles of proximal cavities, and in similar positions in other cavities.

REMOVAL OF REMAINING CARIOUS DENTIN. Generally when the cavity has been cut to form, no carious dentin will remain. But in the larger decays it will often be a question whether or not the pulp will be exposed when all decayed dentin overlaying it is removed. It is especially an object that we do not cut toward the pulp until the cavity is otherwise well prepared, for the reason that if a pulp exposure is found, the cavity shall be fully cleaned and ready for the immediate treatment of the pulp in any way indicated. Then when this stage in cavity preparation has been reached, the remaining softened dentin is carefully and completely removed with broad spoon excavators, usually with the 20-9-12. It will often be required that the pulp of a tooth be exposed for the purpose of making an application to destroy it. In all of these cases, the overhanging enamel should be removed and the walls of the cavity completely cleaned and so formed as to safely hold the temporary filling, before cutting toward the pulp. In many cases in which pulp exposure is expected, where it is in doubt, or where a knowledge of the extent of the depth of the decay seems necessary to the completion of the resistance form and retention form, it is best to remove the decay at once after the outline form has been satisfactorily completed. This must be conditioned, however, on having obtained, in getting the outline form, such conditions as will allow immediate treatment of a possible pulp exposure and the sealing of the cavity without any considerable further excavating. When all of this has been done and after the rubber dam is securely in place, lift off the remaining decay with a large spoon excavator, laying the pulp bare. If this is properly done, very little pain is induced.

FINISH OF ENAMEL WALL. Finishing the enamel wall and beveling the cavo-surface angle is the last cutting done in the preparation of a cavity. This should always be done with the rubber dam in place and with all provisions made for the immediate placing of the filling material.

The cavo-surface angle of the cavity in every part of its outline should receive especial attention. The plane of the enamel wall should be as nearly as practicable in the line of the length of the enamel rods, or such as will certainly cut more from the outer than the inner ends of the rods, and should be made smooth by a slight planing motion of a sharp chisel or enamel hatchet, the motion being in line with the length of the margin. When this has been satisfactorily accomplished, the cavo-surface angle of the enamel should be cut to a distinct bevel outward, also by a planing motion of the chisel, enamel hatchet or the gingival margin trimmer, used very lightly. The depth of this bevel should generally not include more than one-fourth the thickness of the enamel wall. The angle of the bevel should be from six to ten centigrades from the plane of the enamel wall. The object is, first, to cut away any loose ends of enamel rods that might afterward fall away and render the margin imperfect; and, secondly, to strengthen the cavo-surface angle of the enamel as a safeguard against possible checking in packing the filling material.

In this last work, two things should be held closely in view. The cavo-surface angle of the enamel is friable and readily broken by violence, and beveling will materially lessen this liability. But the marginal angle of the filling material which covers the bevel must not be made too thin by too great a bevel of the cavo-surface angle of the enamel. If so, it will have no strength and will tend to roughen, and in this way render the margin imperfect. Therefore, the bevel of the cavo-surface angle of the enamel must not be too great.

TOILET OF CAVITY. This is the final step in cavity preparation and consists in freeing all surfaces from chips and dust that have accumulated during the excavation. The bulk of this is done, of course, with water or the chip blower during the progress of the excavating. But there will remain some fine dust upon the walls and margins that can not be removed in this way. It is not well to wash this with any known liquid, for, even with the use of pure alcohol and after drying with the air syringe, something will be left coating the walls. The best thing yet devised is thorough wiping, or sweeping, of all parts of the cavity

with absorbent cotton or with bits of spunk held in the pliers. This should be well done and the cavity is then ready for filling.

RULE: No moisture of any kind whatever should enter a cavity after the last of the cutting is done, and if, by any accident, a portion of the cavity should become wet, it should be dried thoroughly and then the portion that has been damp should be freshened by cutting away the surface.

EXCAVATION OF CAVITIES BY CLASSES.

NOTE. The determination of the conditions calling for filling operations is dependent upon pathological processes presented in Volume I. As it is the intention to confine this volume as strictly as possible to the technical procedures of filling operations, the pathological processes will not be discussed. Here our principal attention must be given to the physical conditions presented by individual teeth with only brief references to the pathology and principles on which the treatment is based. Brief restatements of pathological conditions will, however, be frequently made.

As previously stated, cavities are divided into five groups or classes, in each of which the cavities require similar treatment and instrumentation, as follows:

Class 1. Cavities beginning in structural defects in the teeth, pits and fissures.

Class 2. Cavities in the proximal surfaces of the bicuspid and molars.

Class 3. Cavities in the proximal surfaces of the incisors and cuspids which do not involve the removal and restoration of the incisal angle.

Class 4. Cavities in the proximal surfaces of the incisors which do require the removal and restoration of the incisal angle.

Class 5. Cavities in the gingival third — not pit cavities — of the labial, buccal or lingual surfaces of the teeth.

A definite order of procedure, which should be followed in cavity preparation, has been given. This consists of obtaining outline form, resistance form, retention form, convenience form, the removal of remaining carious dentin, the finishing of the enamel wall and the toilet of the cavity. Generally, each of these should be considered in the order mentioned, but in the actual preparation of many cavities it will be impossible to definitely separate each of these procedures from the others. For example, resistance and retention form will practically always be obtained by the same instruments and at the same time; and in the smaller cavities, all of the carious dentin may be removed incidentally in securing resistance and retention form. Each of these procedures should, however, be in the mind of the operator in the preparation of each cavity.

TABULATED INSTRUMENTATION FOR PREPARATION OF CAVITIES BY CLASSES.

Measurements of burs are given in tenths of millimeters.

CLASS 1. PIT AND FISSURE CAVITIES. In the occlusal surfaces of bicuspids and molars, in the occlusal two-thirds of the buccal surfaces of molars, in the lingual surfaces of upper incisors, and occasionally in the lingual surfaces of upper molars.

OUTLINE.	RESISTANCE.	RETENTION.	CONVENIENCE.	REMOVAL OF REMAINING CARRIES.	ENAMEL WALL CAVO-SURFACE ANGLE.
BICUSPIDS AND MOLARS, SMALL PITS.					
Round bur 8-10. Inverted cone 8-10. Straight chisel 10. Binangle chisel 10-6-6.	Inverted cone 10.	None.	Spoons 10-6-12.	Straight chisel 15. Binangle chisel 15-8-6.	
BICUSPIDS AND MOLARS, LARGE PITS.					
Straight chisel 15. Binangle chisel 15-8-6. Mallet. Inverted cone 10-12. Hatchet 8-3-23.	Inverted cone 12-14. Hoe 12-5-6. Hoe 12-5-12.	Care about inclination of mesial and buccal walls.	Spoons 15-8-12 or Spoons 20-9-12.	Straight chisel 20. Binangle chisel 20-9-6.	
INCISORS, LINGUAL PITS.					
Round bur 8-10. Inverted cone 8-10. Care not to expose pulp with bur. Hoe 8-3-6. Hoe 8-3-12.	Hoe 8-3-6. Hoe 8-3-12.	None.	None.	Hoe 12-5-6. Hoe 12-5-12. Care about inclination of incisal wall.	

It will occasionally be necessary to use the contra-angle hand-piece in occlusal cavities in lower molar, and occasionally in the buccal and lingual pits in molars.

CLASS 2. SMOOTH SURFACE CAVITIES. In the proximal surfaces of bicuspids and molars.

OUTLINE.	RESISTANCE.	RETENTION.	CONVENIENCE.	REMOVAL OF REMAINING CARRIES.	ENAMEL WALL CAVO-SURFACE ANGLE.
Straight chisel 15. Binangle chisel 15-8-6. Mallet. Enamel hatchets 15-8-12. Inverted cone 10-12.	Inverted cone 12, pulpal. Enamel hatchets 15-8-12. Inverted cone 12, gingival.	Inverted cone 10. Care about inclination of the axial and buccal walls in distal cavities particularly in lower teeth.	Spoons 20-9-12. Spoons 15-8-12.	Straight chisel 20. Binangle chisel 20-9-6. Enamel hatchets 20-9-12. Gingival margin trimmers 20 (80)-9-12, mesial, 20 (95)-9-12, distal.	

Generally use contra-angle hand-piece for distal cavities in lower molars and occasionally for distal cavities in upper molars.

CLASS 3. SMOOTH SURFACE CAVITIES. In the proximal surfaces of incisors and cuspids not involving restoration of incisal angle.

OUTLINE.	RESISTANCE.	RETENTION.	CONVENIENCE.	REMOVAL OF REMAINING CARRIES.	ENAMEL WALL CAVO-SURFACE ANGLE.
Hoe 8-3-6, labial. Hoe 8-3-12, lingual. Hatchet 8-3-12, gingival. Hatchet 12-5-6, labio-gingival angle, gingival half of lingual. Hoe 12-5-6, lingual half of gingival, scraping, or hatchet 12-5-12 from labial. Inverted cone 6-8. Enamel hatchets 10-6-12, gingival.	None.	Hoe 8-3-12 or hatchet 8-3-23, round on incisal angle. Hatchet 8-2-28, buccal groove. Hoe 6-2-23, hatchet 6-2-23, axio-labial line, angle 6. Hoe 6-2-12, 6-2-23, axio-lingual line angle. Inverted cone 6-8, axio-labio-lingual, axio-linguo-gingival.	Inverted cone 6-8.	Spoons 10-6-12.	Straight chisel 15. Binangle chisel 15-8-6. Hoe 12-5-6. Hoe 12-5-12. Enamel hatchets 10-6-12, gingival.

These cavities may often be prepared more easily if rubber dam and separator are applied early.

CLASS 4. SMOOTH SURFACE CAVITIES. In the proximal surfaces of incisors involving the restoration of the incisal angle. Instrumentation same as for Class 3, except the incisal step, therefore only the additional instruments used in cutting the step are given.

OUTLINE.	RESISTANCE.	RETENTION.	CONVENIENCE.	REMOVAL OF REMAINING CARRIES.	ENAMEL WALL CAVO-SURFACE ANGLE.
Carborundum stone. Inverted cone 8. Hoe 8-3-12.	Fissure bur 8-10.				

CLASS 5. SMOOTH SURFACE CAVITIES. In the gingival third of buccal, labial and lingual surfaces.

OUTLINE.	RESISTANCE.	RETENTION.	CONVENIENCE.	REMOVAL OF REMAINING CARRIES.	ENAMEL WALL CAVO-SURFACE ANGLE.
LABIAL CAVITIES. Generally require "Hatch" clamp.					
Inverted cone 10-12. Hoe 12-5-6. Straight chisel 15. Binangle chisel 15-8-6.	None.	Inverted cone 10-12. Hoe 6-2-12. Hatchet 6-2-23, axio-incisal angle.	Inverted cone 6-8.	Spoons 10-6-12.	Straight chisel 15. Binangle chisel 15-8-6.
BUCCAL AND LINGUAL CAVITIES. "Hatch" clamp or "Special" clamp.					
Inverted cone 10-12. Straight chisel 15. Binangle chisel 15-8-6.	None.	Inverted cone 10-12. Hoe 12-5-12. Hoe 12-5-23.	Inverted cone 8-10.	Spoons 15-8-12.	Straight chisel 20. Binangle chisel 20-9-6. Gingival margin trimmers 20(95)-9-12 for mesial wall.

It will occasionally be necessary to use the contra-angle hand-piece for second and third molars, but in these the straight band-piece is preferable for making extensions to the distal and retention in the distal portion of the cavity.

In connection with the presentation of the subject of cavity preparation, the instruments most frequently used in typical cases of each class are illustrated, and are presented in tabular form on the preceding pages. It should be borne in mind that these lists are only suggestive and many deviations will be necessary to meet conditions in particular cases. Generally, however, similar instruments of different sizes will be suitable. If one is ambitious to do the best operating in the least time, he should learn to systematize the preparation of each cavity so that each step will be performed in its proper order and the cutting to be done by each instrument will be completed while that instrument is in the hand. He should learn to decide beforehand just what part of the preparation of a given cavity will be performed by each instrument to be used. If one will form the habit of selecting the instruments to be used in the preparation of each cavity and placing them on the operating tray in the order that he expects to use them, it will be of material aid in systematizing these operations. The illustrations of groups of instruments presented in connection with the preparation of cavities of each class, form a good basis for this study. If the operator will place these instruments on his tray in their proper order for each cavity to be prepared, he will soon learn what deviations from the lists are necessary for particular cases.

CLASS I. CAVITIES BEGINNING IN PITS AND FISSURES.

ILLUSTRATIONS: FIGURES 120-153.

These occur in the occlusal surfaces of the bicuspid and molars; in the occlusal half of the buccal surfaces of the molars, or in the buccal pits; more rarely in the lingual portion of the disto-lingual groove of the upper molars; and in the lingual surfaces of the upper incisors; most frequently in the laterals.

The primary physical condition leading to the location of caries in these positions is a fault, or imperfection in the enamel — an imperfect closure of the enamel plates — which leaves an opening of more or less depth in the enamel as a pit or fissure. It is in these that decay starts. (See Figures of beginning decays in pits, First Volume, Figures 68, 75, 76, 77, 104, 106.) The surface of the enamel in the immediate neighborhood of these is fully exposed to the friction of mastication and is kept well cleaned. For this reason there is no disposition to the spreading of the carious process upon the surface of the enamel. Therefore, these cavities all belong to the class which do not require extension of the cavity outlines for the prevention of the recur-

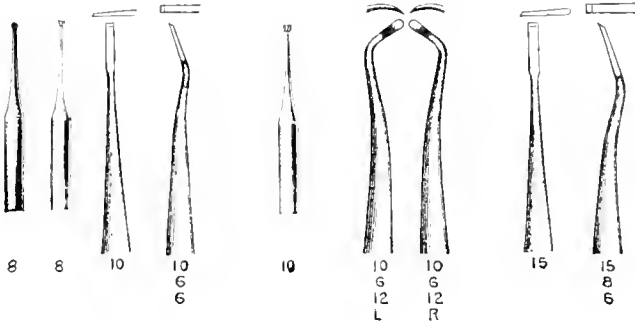

FIG. 120.

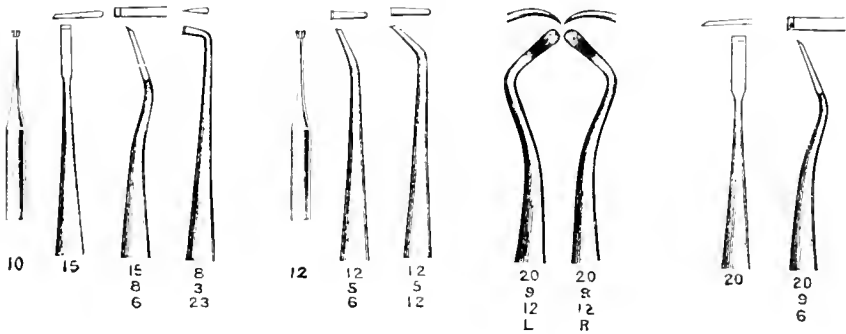

FIG. 121.

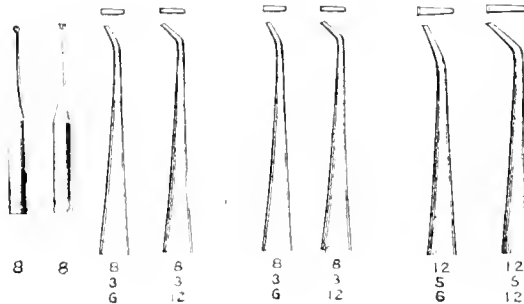

FIG. 122.

FIG. 120. The cutting instruments for opening and preparing small pit cavities in the bicuspids and molars. The round bur 8, inverted cone bur 8, straight chisel 10, binangle chisel 10-6-6 are for securing outline form; the inverted cone bur 10 for resistance and retention form; the spoons 10-6-12 for removal of remaining carious dentin; the straight chisel 15, binangle chisel 15-8-6 for finishing the enamel wall.

FIG. 121. The cutting instruments for opening and preparing large pit cavities in the bicuspids and molars. The inverted cone bur 10, straight chisel 15, binangle chisel 15-8-6, hatchet 8-3-23 are for securing outline form; the inverted cone bur 12, hoe 12-5-6, hoe 12-5-12 for resistance and retention form; the spoons 20-9-12 for removal of remaining carious dentin; the straight chisel 20; binangle chisel 20-9-12 for finishing the enamel wall.

FIG. 122. The cutting instruments for opening and preparing cavities in the lingual pits of the incisors. The round bur 8, inverted cone bur 8, hoe 8-3-6, hoe 8-3-12 are for securing outline form; the hoe 8-3-6, hoe 8-3-12 for resistance and retention form; the hoe 12-5-6, hoe 12-5-12 for finishing the enamel wall.



FIG. 123.



FIG. 124.



FIG. 125.



FIG. 126.

FIG. 123. The occlusal surface of an upper first molar, showing a small pit decay.
FIG. 124. The same as Figure 123 after excavating and filling the cavity.
FIG. 125. An upper molar showing the grooves fissured.
FIG. 126. The same as Figure 125 after excavating and filling the fissured grooves.

rence of decay. All the extension that is necessary is such cutting away of the cavity walls as will fully uncover the carious area and present a surface upon which a good, smooth finish may be made; it is necessary that all sharp grooves connecting with the cavity be cut out to a point where the enamel is sufficiently level to make a smooth finish.

As a primary study of the conditions presented in this class of cavities, the student should select a number of teeth from a collection of extracted teeth and open the pit cavities. This is best done, when a suitable jeweler's lathe with slide rest can be had, by sawing the tooth through the central area of decay with an aluminum disk charged with carborundum powder in soapy water. When this can not be had, much good work can be done by filing or grinding away one-half of the tooth, retaining the other half with its exposed cavity for study. Much familiarity with the conditions that will be presented by these cavities as they occur in the mouth may be obtained also by opening and forming these as it would be done in the mouth in preparation for filling. Enough of this work should be done to render the student familiar with the directions and the extent which decays in the occlusal surfaces and other pit cavities burrow under the enamel.

For this work to be effective, the teeth must not have been dried. A dried tooth has become checked by shrinkage. In any effort to prepare a cavity, the enamel, particularly, is liable to split off from the dentin, and the dentin is also liable to go to pieces. Therefore, dried teeth are unfit for this purpose.

SMALL PIT CAVITY IN CENTRAL FOSSA OF AN UPPER FIRST MOLAR.

DESCRIPTION. Upon examination, a small pit is found in the enamel and the point of the exploring tine passes through it into the dentin, which seems to be softened, showing that caries has begun. The surface of the enamel about the pit is clear and clean. The buccal groove is deep and sharp, but the mesial and distal grooves are shallow, fairly smooth and well closed. (Figure 123.)

OUTLINE FORM. In opening this cavity, a round bur, *8, in the engine is placed in the pit while in rotation and fairly strong pressure applied, while the hand-piece is swayed to and fro. In

* The tenth of a millimeter is the unit of measurement for cutting edges of excavators, sizes of plugger points and diameters of burs. Figures are not used as arbitrary numbers, but as formulas indicating measurement of size, as diameter, width, length, angle, etc. See instrument gauge, Figure 17.

most cases the bur will cut through the enamel and enter the cavity within a few seconds. If it does not do so promptly, it should be removed for a moment and allowed to cool — for heat will develop quickly — and then reapplied in the same manner. This should be repeated until the bur passes through the enamel and enters the softened dentin. Immediately this occurs, the bur should be removed from the hand-piece and round bur 10 chosen. This should also be passed through the opening in the enamel. This completes the use of the round bur, and it is the only use made of it in excavating cavities. Any further enlargement of the opening found necessary is made with hand instruments. An examination should now be made with a curved exploring tine to determine more nearly the extent of the decay in the dentin. In case no softened dentin extending laterally under the enamel is found, the rubber dam should be applied. The cavity should now be sufficiently extended to include the sharp slopes toward the pit without cutting it deeper. The extent of this broadening should be determined and the enamel undermined by pressing the edge of an inverted cone bur, 8 or 10, under it while in rotation, removing the dentin. This should at once be carried around all parts of the cavity that require to be made broader for the purpose named. Then the undermined enamel should be chipped away with straight chisel 10 or 15 and binangle chisel 10-6-6 or 15-8-6, or enamel hatchets of similar widths. This undermining and chipping is repeated until the desired outline form has been obtained. In such a cavity this should be only sufficient to smoothly obliterate the slopes of the pit so that a smooth finish of the filling with the surface of the enamel may be made. With straight chisel 10, or binangle chisel 10-6-6, the enamel is chipped away along the buccal groove as far as it will readily split off. Then inverted cone bur 8 is passed into the cavity and made to enter the dentin toward the buccal groove just beneath the dento-enamel junction, and, while rotating, slowly drawn to the surface of the enamel. It is then entered again at the same point and this motion repeated, making out after cut, following the line of the groove until the groove has been opened to a point where it is sufficiently shallow, or the surface of the enamel is sufficiently level for a good finish of a filling to be made. Figure 124. Often it will be necessary to follow this groove to the crest of the marginal ridge. This done, chip away the mesial and distal walls of the groove with straight chisel 10, or binangle chisel 10-6-6, sufficiently to remove the inclines of the buccal groove.

The outline of the cavity should now be reëxamined, and if irregularities occur that would prevent a smooth finish, the cavity must be sufficiently extended to obtain conditions that will allow a good, smooth finish of all parts of the margin to be made.

RESISTANCE FORM AND RETENTION FORM. An inverted cone bur 10, held with its square end against the pulpal wall, should be carried entirely around the pulpal wall, making a sharp angle along the line of junction of the pulpal wall with the four surrounding walls. The pulpal wall is at the same time made flat, giving the proper resistance form. In doing this, the cavity is not to be cut deeper, but is made broader. All cavities should be made as shallow as the removal of all decay will permit, provided good anchorage in dentin can be had.

CONVENIENCE FORM. No convenience form is usually necessary in a cavity so small. However, a convenience point in which to place the first piece of gold may be made, if desired. These points will be described later.

REMOVAL OF REMAINING CARIOUS DENTIN. All of the carious dentin will generally have been removed in obtaining resistance and retention form. If any remains, it should now be removed with spoons 10-6-12.

FINISH OF ENAMEL WALL. The enamel wall should be finished by careful paring or planing with a sharp chisel. So far as possible the movement of the edge of the chisel should be in the direction of the length of the margin or around the cavity. In such a cavity as this, both the dentin and enamel walls may be perpendicular and the opposing walls parallel. The enamel rods will be inclined toward the cavity in every part, and no outward inclination of the enamel walls is necessary. The cavo-surface angle of the entire margin should be slightly beveled to diminish the danger of fracture in placing the filling material. The toilet of the cavity should then be made, as will be described in the preparation of the larger pit cavity. Figure 124 represents the cavity filled.

In some cases in which there is no more decay present in the central pit than in the case shown in Figures 123, 124, the grooves will be poorly closed, as shown in Figure 125 and beginning decay will be found at a number of points along the lines of the grooves of the occlusal surface, or in the disto-lingual groove of upper molars where it passes to the lingual surface. In such cases, the grooves should be cut out as far as they may be open, even to their ends, when that is necessary to obtain a smooth finish for the filling. The outline form in this case is

shown in the filled cavity, Figure 126. Often advantage may be taken of the point where a groove passes the crest of the marginal ridge (which bounds the occlusal surface) and a good finish made in a moderately sharp groove. At such a point, instruments of suitable form to work in the line of the groove may be used, fashioning the margin of the filling to the form of the groove. It may then be polished by rotary disks of suitable form working in the line of the groove. In many cases of decays occurring in the upper molars, the cavity in the central fossa, with the buccal and mesial groove, may be filled separately from the cavity in disto-lingual groove, that is, without cutting through the oblique ridge.

VARIATIONS. It will often happen that in a cavity having the superficial appearance of those above described, a considerable area of decayed dentin will be found beneath the enamel after the burs have been passed through into it. In this case, the overhanging enamel must be chipped away with straight chisel 10 or 15 and binangle chisel 10-6-6 or 15-8-6, until sound dentin is reached. When this has been done, the remaining portion of the buccal groove should be cut out as described, first completing the outline of the cavity. Then the pulpal wall should be squared up so that its angles with the surrounding walls are sharp and definite, using hoe 12-5-6, or, in some positions hoe 12-5-12, with a scraping motion. In many cases this will be as conveniently and accurately done with a square-ended fissure bur 12, or with an inverted cone bur. In this use of the bur, the shaft should be held parallel with the long axis of the tooth so that the square end of the bur will cut the pulpal wall of the cavity flat and make its angles with the surrounding walls sharp. Then, if there is remaining decay, this is best removed with spoons 15-8-12 or 20-9-12, as may best suit the size of the cavity. Enter the blade beneath the softened material close against the enamel wall at the lingual or buccal side, as shown in Figure 132, and force it with a strong thrust in a curved direction to the other side of the cavity; two or three strokes well made should be sufficient. The rule will be, however, that such cavities will not be too deep to square up the whole depth of the decay in squaring up the pulpal wall in the first cutting. This will complete both the resistance form and the retention form. The enamel wall should be finished and cavo-surface angles beveled the same as before. In many cases the mesial groove will be so sharp and deep that it will require cutting out well toward, or even to the mesial marginal ridge. In lower

molars the lingual groove will oftenest require cutting out to the crest of the marginal ridge.

In any case in which the cavity in the dentin is of considerable breadth and depth, the danger of cutting the recessional lines of the horns of the pulp and of exposing the horns of the pulp in squaring out the pulpal wall should be carefully considered and such changes of form made as will certainly prevent such an accident. It should be remembered that teeth with long, sharp cusps will have long pulpal prolongations pointing toward the points of the cusps, and that these are much longer in the teeth of children than of adults. Therefore, the lines of these horns from the pulp toward the points of the cusps (the recessional lines of the pulpal horns) are dangerous lines in the excavation of cavities. Of these, the recessional line of the mesio-buccal horn in molars is especially dangerous.

LARGE PIT CAVITY IN CENTRAL FOSSA OF AN UPPER FIRST MOLAR.

DESCRIPTION. The pit is open so that the exploring tine readily passes in, giving room to be turned about, revealing a considerable decayed area; some ashy discoloration shows through the enamel, which also indicates undermining of the enamel.

OUTLINE FORM. Begin the excavation by chipping away the overhanging enamel with straight chisel 15. Or, if the orifice in the enamel is still very small, begin with straight chisel 10, and use the 15 later. This may be done by hand pressure, but mallet pressure is much better. In using mallet pressure for the purpose of chipping enamel, the instrument should be held between the fingers with the third finger resting against the adjoining teeth whenever practicable. The instrument so held should be placed lightly on the enamel near the margin of the cavity and so directed as to throw the chips into the cavity. A single quick, sharp stroke should be used. The grasp upon the instrument should be sufficient to prevent the stroke of the mallet from driving it into the depths of the cavity and causing pain by striking its more sensitive parts. Continue this chipping as far as the enamel can be readily cut in this way, or until sound dentin is found supporting the enamel at every point. Look carefully to the relations of the outline of the cavity to the surface and proceed at once to cut out any grooves that will interfere with a perfect finish of the filling. Take hatchet 8-3-23, or, if the opening into the cavity is too small for this, take hatchet 6-2-23, and sweep its edge around the dentin wall of the cavity

with a few vigorous strokes, loosening up and partially removing the softened material, and see whether or not there are some points at which decay extends beneath the enamel. This is readily determined by placing the edge of the hatchet under any suspected overhanging enamel and pulling toward the occlusal. The edge will be held if there is any overhang, and the depth to which the blade has entered will indicate its extent. If such an overhang is found, chip the enamel away and perfect this part of the cavity outline. At this point, any grooves entering the cavity that will interfere with a perfectly smooth finish of the surface of the filling should be cut out as far as necessary on the same plan as that described for the small pit cavity, using the smaller fissure bur 8 or 10, and chipping away the overhanging enamel sufficiently so that all sharpness of the grooves may be made smooth in finishing the filling.

RESISTANCE FORM AND RETENTION FORM. The next step should be to square up the dentin walls. If there is a considerable mass of decay obscuring the cavity, it may be first removed roughly by a few vigorous strokes with spoons 20-9-12 or 15-8-12. In squaring up the dentin walls, an inverted cone bur or a square-end fissure bur 12 should be used. The fissure bur may be used in cases in which it may be brought parallel, or nearly parallel, with the long axis of the tooth, which can generally be done in the occlusal cavities in the upper first molars and bicuspids. This is placed with its end upon the pulpal wall, and, while rotating, pressed laterally against one of the surrounding walls and carried around the whole cavity in a series of cuts. In all deep cavities this must be modified to avoid cutting the recessional lines of the pulpal horns and thus avoid the possibility of exposing the pulp, as will be explained later. This will square up the surrounding dentin walls and the square end of the bur will leave the pulpal wall flat and its angles with the surrounding walls sharp and definite. The flat pulpal wall completes the resistance form, and if the dentin walls are cut parallel with each other in some considerable part, that will be sufficient retention form. It is necessary, however, to have these points distinctly in mind in each case. This is to be taken as the plan of squaring up the surrounding and pulpal walls (and axial walls in buccal and labial cavities) when burs are used for that purpose. But burs should not be used in this way in such positions as will endanger the pulp of a tooth. This use of the bur should be in the smaller cavities only, or only in particular parts of the larger cavities. Care should be had not to continue any single cut so long as to

develop considerable heat. Often much unnecessary pain is produced, and, occasionally, serious injury done to the pulp of the tooth by the heat developed by rapidly rotating burs.

To those who have learned to handle cutting instruments well and have developed good finger power, the squaring up of the enamel wall is best done with chisels and enamel hatchets. Also the flattening of the pulpal wall will be better and more accurately done with hoe 12-5-6 or 12-5-12, used with a scraping motion. Often the binangle chisels may be used to advantage in this work, especially in cavities of considerable area.

Parallel walls and a flat pulpal wall as a seat give perfect anchorage. It will happen in very broad cavities that decay will approach the marginal ridges so closely at some points that insufficient dentin will be left to give sufficient strength to some parts of the walls. Then the dentin wall itself, if the condition as to caries will allow, must be sloped in such a way as to give greater strength, i. e., flared outward in that particular part so that in the deeper part the dentin will be stronger. While it is desirable that all parts of the dentin walls be parallel, this must not be regarded as a necessity that shall lead to cutting them too thin. Any two walls parallel with each other will generally give sufficient anchorage. No undercuts are required.

CONVENIENCE FORM. Generally such cavities need no convenience points for starting fillings, but when large and the operator feels that slight convenience points will aid him, there is no special objection to their use. They should be placed in the walls in the distal portion of the cavity and not in the pulpal wall.

REMOVAL OF REMAINING CARIOUS DENTIN. The deeper portion should be freed of any remaining softened material with the spoon excavators. In no case should any decayed and softened material be left. It is better to expose the pulp of the tooth than to leave it covered only with softened dentin.

FINISH OF ENAMEL WALL. When the walls of the cavity have been squared up and the angles of the pulpal wall with the surrounding walls made sharp and definite, and all carious material removed, the enamel walls may be planed to form and made smooth in every part. Unless the enamel walls approach very close to the marginal ridges, they may be in the same plane with the dentin walls, or parallel to the long axis of the tooth. But if they do approach closely to the marginal ridges, the enamel rods will be inclined toward the ridges, and the enamel wall must be similarly inclined to be in correct form. This may always be

discovered by noting carefully the direction of the cleavage of the enamel while chipping it away. The inclination of the enamel wall should be made to correspond with the enamel cleavage wherever this inclines away from the center of the cavity, i. e., toward the circumference of the occlusal surface. After the enamel wall is in correct form and planed smooth, the cavo-surface angle should be slightly beveled in every part. This bevel should not extend to more than one-fourth the thickness of the enamel, and often should be much less.

TOILET OF THE CAVITY. The making of the toilet of the cavity is the last thing done before beginning the process of inserting the filling. This should be left until all other preliminary work has been completed. Everything else should be in readiness to proceed at once with the filling when this is done.

(1.) If the cavity is dry and freshly cut, the enamel wall finished and the cavo-surface angle beveled, and it is intended to immediately insert the filling, the chip-blower should first be used to clear the cavity of all cuttings and fine dust that may be thus removed. Then a bit of spunk, or a pellet of absorbent cotton — the latter is better, should be taken in the foil pliers and every part of the cavity carefully swept. With a second pellet of cotton, every part of the walls and margins of the cavity should be carefully rubbed to remove the last trace of adhering particles of dust. It is well to use the air blast again to remove particles of dust that have been loosened from the walls but have not adhered to the cotton. If there is no leak in the rubber dam and no appearance of moisture anywhere, the filling should be begun at once. The habit sometimes indulged in of swabbing out cavities thus prepared with alcohol or other substance for a better cleaning, is useless and is liable to do harm by introducing something with the liquid that will not be easily removed.

(2.) If a fixed oil* of any kind has been used in the cavity, the removal of which may be incomplete, free swabbing with alcohol, or sulphuric ether, is desirable for cleaning purposes and to free the walls of the cavity of the oil. This should be repeated several times and much care should be taken to have the alcohol or ether pure and clean. Simple wiping of the cavity with cotton moistened with alcohol is not sufficient. It should be a thorough washing. The cavity should then be dried with cotton, followed by the chip-blower. Every part of the sur-

* The essential oils, when pure, evaporate completely. But they are often adulterated with fixed oils. A pure essential oil dropped upon a clean white paper will dry and leave no mark. If adulterated with a fixed oil, a spot will be left.

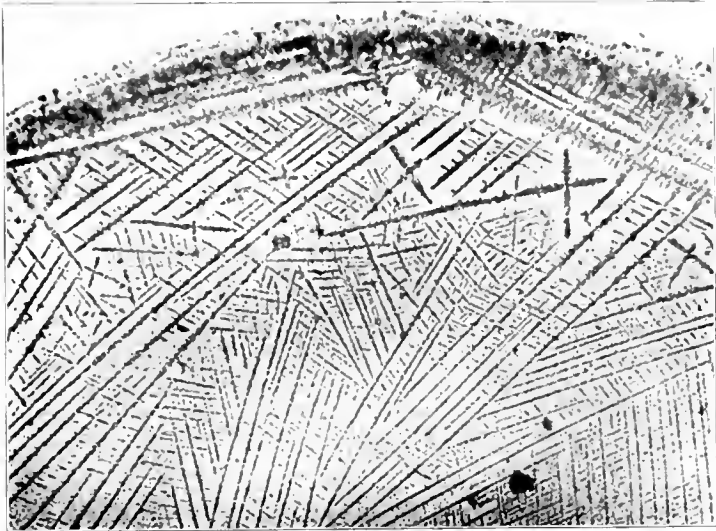

FIG. 127.

FIG. 127. A photomicrograph of salts dialyzed from the saliva and crystallized by drying, forming a coating on the glass. These salts and also the gummy material from the saliva, are left in the same manner on the walls of the cavity whenever a cavity wet with saliva is dried by the warm air blast. Any one may see the film by drying a drop of saliva on a clean glass.

rounding walls and margins should be gone over with a cutting instrument and scraped to form fresh cut, clean surfaces. After this, the toilet proper should be made as previously stated.

(3.) If a leak in the rubber dam has occurred, or if from any cause some portion of a cavity wall has become wet with saliva or any fluid exuded from about the gingival margin, or elsewhere, this should be wiped away with absorbent cotton and then dried by the air blast. Then all parts noticed as having been wet, and as much more as may be necessary for certainty of including all, should be trimmed, planed or scraped, to give a perfect fresh-cut surface. Then the toilet should be made. In such cases, the walls of the cavity can not be cleaned by drying. It is just as important to have cavity walls clean as to have them dry. The saliva or serum that may exude from the soft tissues are each loaded with salts, mucin or albuminoids, that are left on the cavity wall after it has been dried. Figure 127 is a photomicrograph of salts from the saliva left from the evaporation of the distilled water into which these salts were dialyzed to free them from the mucin, albuminoid and gummy material. The illustration includes only the margin of salts deposited from a tiny drop. Any one may see this deposit from the saliva by placing a small drop of saliva on a clean glass and allowing it to dry.

In the drying of a spot of moisture on a cavity wall, the mucin and gummy material would be left as a hard transparent film with the salt crystals. In drying with hot air or cold air without other preparation, this mass of crystals and gummy remains would be left and the filling placed over it. These materials will subsequently dissolve out, forming a leak. This may not be much, but where these dissolve out, acids may and will go in if it is at any point on the margin where microorganisms may grow; and decay may easily recur. If, at a point that is well cleaned, perhaps it will be seen only as a discoloration, or so-called blue margin.

(4.) In cases in which the cavity has been prepared and the filling is delayed until another sitting; immediately before the filling is placed, the walls and margins should always be so trimmed as to give perfectly fresh cut surfaces to fill against, no matter how complete the previous preparation nor how perfect the temporary filling may have been. Then the final toilet of the cavity may be made. In case it is expected that the filling will be made at another sitting, the final finish of the cavity should be made at that time. To sum this all up in one sentence,

every filling of whatever description that is intended for permanence should be made against clean freshly cut walls. These need neither washing nor drying. But they should be freed from all chips and dust as described.

The above will be taken as the method under the varying conditions named of making the toilet of a cavity whenever, and wherever, this is mentioned in the following pages. The description of the process will not be repeated, as that given here is regarded as applying to all possible locations and conditions.

DEEP OCCLUSAL CAVITIES IN MOLARS.

ILLUSTRATIONS: FIGURES 128-137.

Turning now to the management of deep pit cavities in the occlusal surfaces of molars, we may illustrate the process of excavation more completely. The operator should have clearly in his mind not only the form of the tooth, but every part of its anatomy clearly outlined, together with the length of the horns of the pulp in teeth with long, sharp cusps, as compared with the length of the horns of the pulp in teeth with short, obtuse cusps, the probable form of these in the child and the reduction of the size of the pulp and the shortening of its horns that occurs with age. In the child the pulp will become exposed by a decay of much less depth than it would do if the patient were thirty or forty years old. It is also much more liable to be exposed in the preparation of cavities unless these matters are held clearly in view. In this, the recessional lines of the pulpal horns are of especial importance and require careful consideration.

DESCRIPTION OF CASE. In Figure 128 an upper molar is represented with a large pulp chamber and with long pulpal horns. It is split bucco-lingually, exposing a decay, which, under the conditions, is dangerously deep. It is the first illustration in a series of ten for the purpose of more fully explaining the steps in excavating such cavities and avoiding the dangers of pulp exposure.

OUTLINE FORM. Such a cavity is opened best with chisels, such as straight chisel 15 and binangle chisel 15-8-6. The instrument should be placed near the margin of the pit and used with hand pressure, throwing the chips into the cavity as represented in Figure 128. This should be continued, going partly around the original opening, as shown in Figure 129, enlarging the opening and substituting the mallet for the hand pressure. This will give room for the cavity to be cleared of the chips thrown loosely

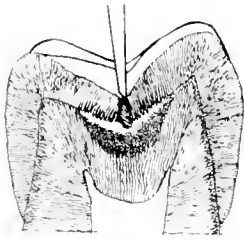

FIG. 128.

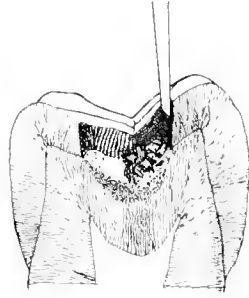

FIG. 129.



FIG. 130.

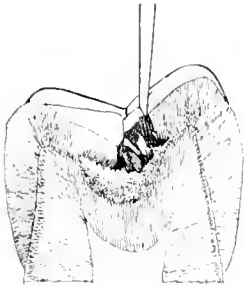

FIG. 131.

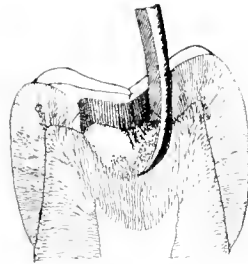

FIG. 132.

FIGS. 128-137. The excavation of deep occlusal cavities in the molars, illustrated progressively in ten pen pictures of a cavity in an upper molar, split buccolingually. The enamel and dentin are distinguished definitely in each picture. In this case the tooth represented is from a young person, in which the horns of the pulp are still very long, and in danger of exposure.

FIG. 128. The distal half of the split tooth, displacing the carious area in the dentin with its relation to the crests of the marginal ridges of the pulp. Opening the cavity with the chisel.

FIG. 129. Progress of opening the cavity with the chisel.

FIG. 130. Further progress in chipping away the undetermined enamel, using the chisel with the pulling movement.

FIG. 131. Shaving the enamel walls to form with the chisel, and smoothing them.

FIG. 132. Removing softened material with spoon 20912. In this case this is done before squaring up the dentin walls because there is believed to be danger of exposing the pulp of the tooth.

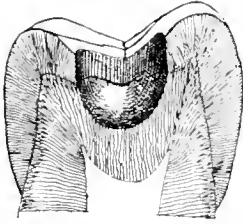

FIG. 133.

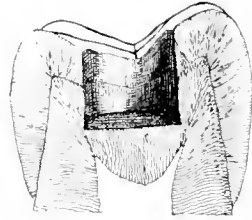

FIG. 134.

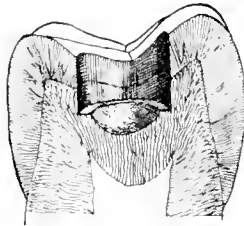

FIG. 135.

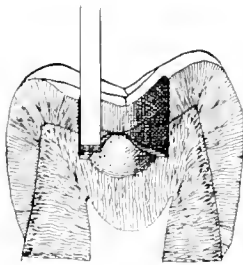

FIG. 136.

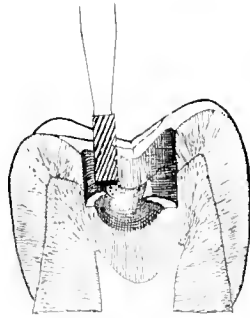

FIG. 137.

FIG. 133. The cavity with concave pulpal wall as left when the decayed material is removed. The pulp is not exposed.

FIG. 134. The cavity with the dentin walls squared up to the full depth of the decayed area. The proximity of the cutting to the recession lines of the marginal crests of the pulp, which may be traced in the picture, shows that to square up the dentin walls to this depth would be a very dangerous proceeding, because of the great liability of exposing the horns of the pulp.

FIG. 135. The same cavity with ledge cut with square angles instead of squaring up the dentin walls to the full depth. The squaring up of the dentin walls may be but part way round the cavity in any case in which exposure of the pulp is especially feared, as shown in Figures 136, 137.

FIG. 136. Using the binangle chisel or enamel hatchet with a scraping motion in squaring up the dentin wall and cutting a ledge around the deeper portion of the cavity.

FIG. 137. Using the fissure bur for squaring up the dentin walls, and cutting a ledge around the deeper part of the cavity.

into it. Then the same instrument may reach across to the opposite side and its edge (which must be very sharp) engaged near the margin of the pit, and, with a pulling motion, by hand pressure, the undermined enamel may be rapidly split off, as shown in Figure 130. This pulling motion in splitting off undermined enamel is peculiarly effective and rapid if the enamel is touched just right. The direction of force after engaging the edge of the chisel is shown by the small arrow placed above the instrument point in Figure 130. This kind of chipping should be continued until the enamel is found to be supported by sound dentin, in which case it will not chip away so easily; and if the use of considerable force is persisted in, it will crumble instead of splitting. The enamel wall should be smoothly trimmed parallel to the long axis of the tooth in all of its parts, as shown in Figure 131. All of the circumference of the dento-enamel junction should be carefully examined with the edge of hatchet 6-2-23, by sweeping it around the cavity to see if any points of softening remain, or if further undermining of the enamel can be discovered. If the edge of the hatchet readily catches under the margin of the enamel, it should be cut away until the hatchet no longer catches. This completes roughly the outline form, except as it may be necessary to follow out deep grooves, which these illustrations are unfavorable for showing.

REMOVAL OF DECAY WHEN EXPOSURE OF PULP IS FEARED. The opening of the cavity is such that if the pulp should be found exposed at any point upon removal of the decay, it will be ready for immediate treatment and protection by a temporary filling. It is often best in such a cavity to remove the decay before completing the resistance and retention form and gain further insight as to its depth. Up to this point it would be entirely wrong to make more than the most superficial examination of the depth of the decay, or to do anything that might possibly disturb an exposed pulp. Any examination of the extent of the cavity up to this time should be directed to the lateral extension under the enamel and not in the direction of its depth. If the rubber dam has not been placed in the beginning, it should be placed before going further.

The next movement is shown in Figure 132. The walls have been so trimmed that the lateral margins of the area of softened dentin may be approached from any point. For a cavity of this extent, spoon 20-9-12 should be chosen and the edge examined to see that it is sharp. It should be introduced under the most convenient margin of the decayed area, as shown in Figure 132,

and driven under it with a circular motion, following as closely as possible the hard dentin beneath, the endeavor being to turn out the whole of the softened mass at a single sweep. Often this may be done, but frequently it will hang at one side or the other and require a second, more rarely a third, stroke to completely remove it. In the case under consideration, the pulp is not exposed in this process. Any remaining softened material is now carefully removed by a scraping motion with the same instrument, and its fellow, and all parts of the cavity cleaned.

COMPLETION OF OUTLINE FORM. The cavity is now in the form shown in Figure 133, which, in a young person, must be regarded as a deep cavity. At this point any deep grooves that would interfere with the perfect finish of the filling should be cut out to obtain a finishing point, thus completing the outline form. The grooves in a cavity of this depth need to be cut no deeper than just a little into the dentin. But no endeavor will be made to show them in the present cavity.

RESISTANCE FORM AND RETENTION FORM. If it is the judgment of the operator that the pulp of the tooth will be in no danger from the proceeding, the pulpal wall should now be squared out and made flat, as shown in Figure 134, completing the resistance form and the retention form. An examination of the figure, however, shows plainly that such a procedure would, under the conditions, be extremely hazardous. On the lingual, the recessional line of the lingual horn of the pulp as shown, is dangerously approached or actually cut, and on the buccal it is also closely approached, though as this tooth is cut from buccal to lingual only the extended crest of the pulp is shown on the buccal side, the horns proper under the point of the cusp being much longer. For these reasons great care should be taken in squaring out deep cavities in the teeth of young people, that unnecessary pulp exposure may be avoided. Therefore, for the completion of the retention and the resistance form, a ledge should be cut around the border of the deeper part of the cavity, as shown in Figure 135. In this procedure the recessional line of the horn of the pulp is approached less closely and the point of approach is farther from the pulp. In doing this, the better plan is to use the enamel hatchets or the binangle chisels, placing the blade as shown in Figure 136, using a scraping motion, or, in some cases, the fissure bur may be used as shown in Figure 137.

Neither is it necessary in a cavity of this depth that even this ledge be cut all the way around the cavity. Certainly it is better to leave parts sloped or rounded away for the protection

of the horns of the pulp, than to run imminent risk of exposing them. But always sufficient ledges should be obtained to furnish ample seating area to prevent the possibility of a filling tipping and moving on a rounded surface like that shown in Figure 133. Such a cavity is the most difficult of all forms to fill satisfactorily and should not be attempted. Filling the rounded portion with cement does not help matters. In such cases ledges of firm dentin should be had to receive the stress to prevent the possibility of movement, both in the packing of gold or amalgam, and also in the after stress of usage in mastication. When this has been done, the deeper rounded portion may be filled to the level of the ledges with cement to act as a non-conductor of thermal changes when that is thought desirable.

CONVENIENCE FORM. The cavity should be carefully examined with reference to convenience form for insertion of the filling. For filling with amalgam, the rule will be that nothing more is required; but for filling with gold in a cavity of such depth, one should be careful to have the approach for plugging instruments such that the filling can be easily packed against every part of every wall of the cavity by direct mallet force. In upper first molars this is generally easily done when the walls are parallel with the long axis of the tooth. But in upper second and third molars and in any of the lower molars, the mesial wall or the mesial and part of the buccal wall or both should be sloped more toward the marginal ridge, cut to its crest, or even cut slightly over the marginal ridge, to give convenience and certainty in packing gold against them. Therefore, such modifications should be made as this may demand, completing the convenience form.

FINISH OF ENAMEL WALL AND TOILET OF CAVITY. Finally the enamel walls must be finished and the cavo-surface angle slightly beveled, and the toilet of the cavity made by sweeping out the last of the cuttings not removable with the air syringe.

VARIATIONS. In very deep cavities of this class, and especially when it is suspected that the pulp is near exposure, it is well to fill the deeper portion as far as the ledge cut around the margin with cement and allow this to harden before placing gold or amalgam. The best way to do this is to cut a bit of stiff paper or light cardboard to fit the cavity loosely, and, having mixed the cement and worked it until it begins to stiffen, form a globule of suitable size and take this on the paper and place both in the cavity, forcing the cement into the concavity in the dentin by

pressure on the paper. When the cement becomes hard, the paper may be pulled away.

Another matter briefly mentioned above, that frequently becomes important, is shown in the split cavity, Figures 138-141. In this case, as shown in Figures 138, 139, of a molar tooth split mesio-distally, there are two decays, one in the central pit and one in the distal pit, both extending widely along the dento-enamel junction, almost completely undermining the enamel of the occlusal surface in the mesio-distal direction. This has gone so far that only the marginal ridges on the mesial and distal can be retained. If the dentin walls were cut parallel with the long axis of the tooth, the strength of the dentin remaining would be insufficient. In such cases, the mesial and distal walls, one or both, should be so sloped as to retain sufficient strength of dentin, as shown in Figures 140, 141. To the buccal and to the lingual of the cavity, there is abundant material and a sufficient part of these walls may be made parallel to render the filling perfectly secure. This is especially true in cases in which the depth in relation to the pulp, the patient being of mature age, allows the full squaring out of the pulpal wall, as represented in this case.

It should be noticed also that the disto-lingual groove in Figure 140, and the buccal groove in Figure 141, were each made with a cut which only entered the dentin a little, not cutting this part to the depth of the principal cavity. Deep cutting in these position weakens the tooth without accomplishing any mechanical or protective advantage. Cuts following out grooves in order to find points to make a good finish, should always be deep enough for independent anchorage of the ends farthest out from the cavity. In these illustrations the enamel cap has been made sufficiently prominent for the dento-enamel junction to be followed in all of the parts. It should be particularly noted that this line rises as the enamel is cut back onto the slopes of the cusps, apparently deepening the cavity. The size and form of the pulp chamber in this case represents greater age of the patient than that in the previous series of illustrations, giving more freedom in squaring out the pulpal wall.

Figures 142-144 represent a tooth with decay, cavity prepared, and filling placed, in a similar case to that shown in Figures 138-141. The excavation of such cavities as these is carried out in a manner practically the same in its details as that represented in Figures 128-137. There is considerably more chipping of enamel in uncovering the areas of decay, and some-



FIG. 138.



FIG. 139.



FIG. 140.



FIG. 141.

FIGS. 138-141 inclusive. Split upper molar, showing cavities that have begun in the central and distal occlusal pits, which have undermined most of the enamel on the line of the mesio-distal section. In this case, as shown in Figures 140, 141, the mesial and distal marginal ridges are closely approached in removing the last traces of the decay undermining the enamel. These walls, therefore, are not made parallel but are sloped outward in order that there may be more strength of dentin left. Notice also that in cutting out the disto-lingual groove, Figure 140, and the buccal groove, Figure 141, these have been made only a little deeper than the thickness of the enamel. In this case the person is of mature age and there is not the same danger of pulp exposure as in the case represented in the series, Figures 128-137.



FIG. 142.



FIG. 143.



FIG. 144.

FIG. 142. A cavity formed by beginnings of decay in the central and distal pits in an upper molar similar to that shown in Figures 138-141.

FIG. 143. The cavity, Figure 142, prepared for filling. In this case the mesio-buccal angle of the cavity and the mesial half of the buccal wall have been strongly sloped to the mesial and to the buccal for convenience in placing the filling. This plan of inclination of the cavity walls is often much more necessary in cavities in the second and third molars.

FIG. 144. The same as in Figure 143, with the filling placed and finished.

times the oblique ridge must be cut through along the distal groove with the bur in the same manner that grooves are cut out elsewhere before the enamel can be chipped away, connecting the two cavities. When this is done, however, it is easily removed. It is also necessary to follow out the disto-lingual groove to the crest of the marginal ridge, and often over it onto the lingual surface. These, however, are minor differences in the same plan of procedure. In this case the mesial half of the buccal wall and the mesial wall, including the mesio-buccal angle, have been strongly sloped toward the marginal ridges for convenience in packing gold against them.

In second and third molars some differences of procedure and of instrumentation are necessary on account of the differences of position. Often the bur can not be brought into position for effective use in squaring up the surrounding and pulpal walls, and this is done best with the hoe 12-5-12, or, in some positions, especially in lower molars, hoe 12-5-23, used with a scraping motion. In some cases the bur may be used effectively in the contra-angle hand-piece, Figure 25, but this is an awkward and generally ineffective instrument and its use instead of hand instruments should be reserved for cases of the greatest necessity. This instrument is, however, much better than the right-angle hand-piece formerly used, for the reason that the working point is in the line of the shaft, which gives it the proper balance in the hand. Often one can not follow the progress of the work well with the eye and there is much greater danger of inaccurate cutting, which increases the risk of pulp exposure.

The mesial wall, and especially the mesio-buccal angle of oclusal cavities in the second and third molars, should be so inclined to the mesial and buccal as to allow of packing gold against them easily. The amount of this inclination will depend upon the position and the character of the approach to the cavity. If the mouth of the patient opens well, giving a good view, and allows instruments to be placed very nearly parallel with the long axis of the tooth operated, very little inclination mesially and buccally will be required. If, on the other hand, the mouth does not open well and the approach of the instruments must be at a considerable inclination to the distal, the mesial wall and the mesio-buccal angle must be inclined in proportion, or sufficiently to allow of mallet force being applied parallel with the plane of this wall and angle. Any failure in this will require, in filling with gold, that the gold be packed against this wall with reverse pluggers or by lateral hand pressure, which greatly

increases the difficulty of making a good filling. When the preparation is for amalgam fillings, this is not demanded but it is still desirable.

When the distal pit in the occlusal surface of the upper molars is the seat of operation, the procedure is not essentially different, except that the approach should be rather more from the buccal. The same instruments and the same methods should be employed. In these, it is very generally necessary to cut out the disto-lingual groove to the crest of the lingual marginal ridge, and frequently to follow it over onto the lingual surface of the tooth. This should be done with the inverted cone bur, as previously described, followed by the necessary chipping of the enamel with hand instruments. In the lower molars the grooves are generally deeper and more deeply sulcate than in the upper molars (except the disto-lingual groove), and will much oftener require cutting out to the crests of the marginal ridges.

In the lower molars there will often be a decay starting in a pit to the mesial and a pit to the distal of the central pit. When this occurs and the decay has burrowed rapidly along the dento-enamel junction, nearly the whole occlusal surface must be removed, making a very broad cavity, as shown in Figure 145. Often these are comparatively shallow, and again the central pit decay only will be deep, so that a ledge may be formed to the mesial and distal, on which to rest the filling after the deeper central part has been filled with cement in cases in which a non-conductor seems desirable.

When the walls of cavities approach the crests of the marginal ridges, as in that shown in Figure 145, care must be taken as to the direction of the enamel rods forming the wall, to see that there are no short ends left at the cavo-surface angle. It is best to bevel the cavo-surface angle slightly in all such cases with a chisel held lightly in the fingers, using with a planing motion, as shown in Figure 146. This motion should be along the length of the cavo-surface angle. This lessens the liability of checking this angle in packing gold over it, and is also especially important in preventing checking in usage in mastication. Very many occlusal fillings come to have imperfect margins within a few years from the checking of the cavo-surface angle of the enamel by usage, and this should be prevented. This checking of the enamel in usage has become especially prominent in connection with the use of porcelain inlays in occlusal surfaces, and will be so with the more recent gold inlays unless this matter be looked to with great care. This applies to all cavities in occlusal surfaces where



FIG. 145.

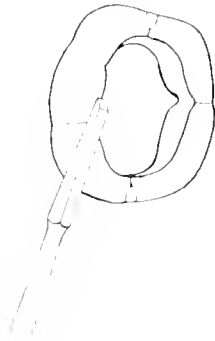

FIG. 146.

FIG. 145. A lower molar with a broad but not very deep occlusal cavity.

FIG. 146. An outline of the tooth and cavity, Figure 146, with a chisel in position for beveling the cavosurface angle of the cavity. The motion of the chisel is parallel with the cavity margin.

these walls are so near the crest of the marginal ridges that the enamel rods may be parallel with the cavity wall.

The chipping of undermined enamel in obtaining the outline form in the lower molars is so similar to that described for the upper molars that no separate description seems to be needed. In principle it is the same. Differences in position give rise to some little differences in instrumentation. These teeth frequently have a lingual inclination which renders occlusal cavities less easy of approach. In this they present great variation, many being as easy of approach as the upper teeth, and some easier. Yet, frequently there occurs a lingual inclination that renders them very difficult. The rule is that the lower molars are most accessible to instruments which approach them over the median line at the upper front teeth, or when much inclined lingually a line over the cuspid of the opposite side is often better. (See Figure 52, finger positions.) In many cases these cavities, when in the right lower molars, are easily approached from a position left side behind with the instrument shaft close against the side of the face. (See Figure 54, finger positions.)

If these are prepared for filling with gold by the use of direct force, the mesial wall must be inclined to the mesial and the mesial portion of the buccal wall must be strongly inclined to the buccal to allow of direct force being used. It is in such cases, however, that reverse pluggers have their greatest use, and when such cavities are to be prepared for the use of these, the mesial and buccal walls may be squared up in the axial plane (any plane one direction of which is parallel with the long axis of the tooth) without inclination, by use of the square-ended fissure bur in the contra-angle hand-piece, or with hoes 12-5-12 and 12-5-23, and the binangle chisels. Gold can then be well packed with reverse pluggers, but not by direct mallet force.

Occlusal cavities in the upper bicuspids are so easy and direct of access that little difficulty is experienced in their preparation. The principal points of instrumentation are the same as have been described. In these, however, the pits in which decay starts are so close to the marginal ridges, especially in first bicuspids, that the enamel of the marginal ridge, and not infrequently also of the proximal surface, is undermined very quickly. This often requires a proximo-occlusal filling in a case that seemed to be only a slight pit cavity.

Occlusal cavities in the lower bicuspids are difficult only in cases of strong lingual and distal inclination of these teeth. In these cases, the instrumentation is similar to that described for

the second and third lower molars, except that smaller cutting instruments will be required.

PIT CAVITIES IN THE BUCCAL SURFACES OF THE MOLARS.

ILLUSTRATIONS: FIGURES 147-153.

These must be distinguished sharply from smooth-surface cavities occurring in these surfaces. The pit cavities have their beginning only in the buccal pits and are primarily in the occlusal half of the buccal surface, as shown in Figures 147, 148. Smooth-surface buccal cavities are primarily in the gingival third of the buccal surface and begin in the smooth portion of the enamel close to the gum margin.* They are not always very close to the gingival margin of the buccal surface of the tooth, because the free margin of the gum often, particularly in young people, considerably overlaps the gingival portion of this surface.

In these pit cavities, the principles of instrumentation are the same throughout as that described for occlusal cavities, except as their location and the direction of approach render differences necessary. Pits, in which decay has just begun, should be opened with burs as described for occlusal surfaces. Where more decay has occurred, so as to allow the use of chisels, or hoes used as chisels, the opening should be made by chipping away the enamel. The squaring up of the axial and surrounding walls and making the axial line angles definite, should be done in the same way as in occlusal cavities, if done with burs or if done with the hoes and chisels. If these are filled early, or as soon as decay is discoverable, they are very simple cavities, requiring no further extension than that required to fully uncover the area of decay, as shown in the upper first molar in Figures 147, 148. Sometimes in the second molars, and generally in the third molars, the angle of approach will be such that the straight hand-piece of the engine can not approach the cavity at the correct angle, and the contra-angle hand-piece, Figure 25, must be used, or, what is usually better, the work must be done with hoes and binangle chisels. In finishing the enamel walls, the case is different in that the enamel rods will generally be found inclining toward the pit from every direction around it for a little distance, but farther away they will be perpendicular to the surface upon

* NOTE.—Distinguish carefully between the terms *gum margin* and *gingival line*, or a *gingival margin* of a surface of a tooth. Gum margin refers to the position of the free edge of the gum, while the gingival line is the line of junction of the enamel with the cementum, or the normal line of the attachment of the gums to the tooth. The gingival margin of a surface of a tooth is at its gingival line.



FIG. 147.



FIG. 148.

FIG. 147. Caries beginning in the buccal pits of the upper first and second molars.

FIG. 148. Cavities shown in Figure 147 as prepared and filled, which show the outline forms of the cavity preparations.

the central part of the tooth surface but inclining toward the oclusal as the oclusal margin of the surface is approached. See Figures 106, 107. Therefore, the inclination of the enamel rods, or the direction of the cleavage, should be closely noted while chipping away the enamel, and the oclusal enamel wall finished in inclination to the oclusal, so as to be parallel with the line of the cleavage. If in any case it is found that because of close approach to the oclusal surface, the inclination of the enamel wall to the oclusal will render the filling material too thin at its margin to have sufficient strength, the buccal groove should be opened over the crest of the marginal ridge and the filling carried onto the oclusal surface in the form of a step, as shown in the upper second molars in Figures 147, 148, and in the lower second molars in Figures 149, 150. Neglect of this precaution is causing the loss of many otherwise good fillings in this position.

It is only occasionally that a good finish can be made along the line of the buccal groove, as shown in Figures 151, 152. Generally the extension should be made to include the central pit of the oclusal surface, including more or less of the grooves, as shown in Figure 153. It so generally happens that there is also decay in the central pit of either the upper or lower molar when decay has begun in the buccal pit, that it is not inconvenient to cut out the buccal groove between the two and unite them as shown in Figure 153. This gives the safest treatment of these pit cavities when they have been so neglected as to have burrowed deeply, or have undermined considerable enamel near the marginal ridge. The judgment between a simple filling and this extension must be based altogether on the conditions revealed in individual cases in the excavation of these cavities.

Pit or fissure cavities on lingual surfaces do not occur in the lower molars, but do occur occasionally as independent cavities in the lingual grooves of the upper molars and rarely in the mesio-lingual groove of the upper first molars where there is a fifth cusp. The instrumentation in these is on the principles already given and requires no special description.

PIT CAVITIES IN THE LINGUAL SURFACES OF THE UPPER INCISORS.

In the preparation of these cavities two points of special caution need to be mentioned. First, the location of the cavity is such that the pulp is easily reached, and accidentally and unnecessarily exposed, unless especial caution be observed. The use of burs should be limited strictly to the first opening of pits but little decayed. Neither inverted cone nor fissure burs should

be used in squaring up the axial and surrounding walls, because the angle of approach is such that the sharp angle of the bur is presented toward the pulp instead of its square end. This necessarily defeats the object as to squaring up the axial and surrounding walls and rendering the axial line angles sharp, and especially endangers the pulp. All of this work should be done with the hoes and the smaller chisels.

Except in the smaller cavities, the direction of the enamel rods will be much inclined to the incisal upon the incisal wall of the cavity. This should be carefully noted in chipping away the enamel, and the finished enamel wall should have the proper inclination to give it the necessary strength.

These cavities not infrequently occur in children soon after these teeth take their places in the arch. They are then difficult of treatment, because the long, heavy, free margin of gum on the lingual is in the way of the proper adjustment of the rubber dam. This, however, is the only special difficulty. These cavities are so very dangerous when neglected that a special effort should be made to fill them while very small.

SMOOTH-SURFACE CAVITIES.

CLASSES. GENERAL CONSIDERATIONS. Smooth-surface cavities include four classes, as follows: Class 2. Proximal cavities in bicuspid and molars. Class 3. Proximal cavities in incisors and cuspids which do not require the restoration of the incisal angle. Class 4. Proximal cavities in incisors which do require the restoration of the incisal angle. Class 5. Buccal and labial gingival third cavities. These comprise by far the greater number of decays that occur in the human teeth. Occasional smooth-surface cavities occur on lingual surfaces and at other points, but they are so infrequent, and their treatment is so similar to those classified above, that they may be ignored in this connection.

The smooth-surface cavities are quite distinct in the conditions of occurrence from the pit and fissure cavities. In all pit and fissure cavities there are actual pits or fissures which cause the localization of decay in those points. The pits act as shelters for the growth of colonies of microorganisms in which they may easily be covered in. In this position their acid products are protected from dissipation in the general fluids of the mouth. Therefore the acids are applied directly to the solution of the calcium salts of which the enamel about them is composed. The enamel immediately outside the pit is exposed to the friction of

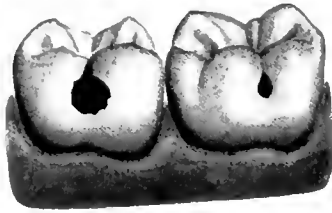

FIG. 149.

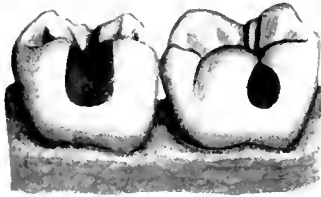

FIG. 150.

FIG. 149. Lower first and second molars with decays beginning in the buccal pits.
FIG. 150. The decays shown in Figure 149 after having been excavated and filled. This shows the outline forms of the preparations. Notice that the cavity in the second molar has been cut over onto the occlusal surface. See Figures 151, 152, 153.



FIG. 151.



FIG. 152.



FIG. 153.

FIG. 151. Mesio-occluso-buccal view of a lower second molar in which the burrowing of decay from a buccal pit has approached the occlusal surface too closely for safe treatment without cutting over the marginal ridge.

FIG. 152. A plan of treatment which may occasionally be employed.

FIG. 153. The plan of treatment that should generally be employed in such cases. The cutting in the occlusal surface will, of course, depend upon conditions found in that surface. Fissures may need extensive cutting or decay may demand it.

mastication and washings by the saliva. For that reason there is no tendency for decay beginning in pits or fissures to spread on the surface of the enamel. Therefore, superficially, decay beginning in these points is strictly confined to them and spreads only within the substance of the tooth.

In the smooth surface cavities, the conditions are reversed. The surfaces in which they begin are all smooth, polished and free from pits or roughness of any kind. But they are all in positions in which the teeth are not well cleaned by friction or by washings by the saliva, as between the teeth in the proximal decays, and near the gums in the buccal and labial decays. The centers of these unclean areas become the *nidi*, or special points, in which colonies of microorganisms lodge and develop; and where they remain covered in and protected from washings by the saliva, forming acid in contact with the enamel. In these positions they are not confined to the immediate nidus or point of first beginning of growth, as in the pits and fissures, but gradually spread over the surface to the limit of the unclean area, unless stopped by the falling away of the enamel supporting the central nidus. When the enamel in the center of the area or point of attachment is destroyed, the remaining marginal portions of the superficial colony are usually destroyed also. If a filling is so placed as to restore the original form and conditions, a new colony will probably become attached and grow on the filling in this restored locality. The filling being indestructible, this colony will continue to spread until it has extended as far as the scouring by mastication will allow. If the filling made is not broad enough to reach a line where this scouring will prevent the second colony spreading beyond its margins, decay is liable to begin again beside the filling. This requires that certain extensions be made in the preparation of smooth-surface cavities, often cutting away more or less sound tissue at certain points, or in certain directions, for the purpose of preventing the recurrence of decay.

The areas of the surface of the enamel about the angles of the teeth extending ocluso-gingivally are found to be most generally immune to the beginnings of decay. These angles of the teeth are the mesio-buccal, disto-buccal, mesio-lingual and disto-lingual. During mastication, the food is driven through the embrasures opening to the buccal and to the lingual between the teeth, tending to keep these lines clean. Therefore, in the preparation of proximal cavities, the object should be to take advantage of these conditions and lay the buccal and lingual margins

far enough out into the embrasures toward the angles of the teeth so that food passing over the margins of the filling will keep them clean. This is called extension for prevention. In the preparation of gingival third buccal or labial cavities, these should be extended far enough toward the angles to effect a similar object.

EXTENSION FOR PREVENTION is a definite requirement. The phrase as first used meant the laying of cavity margins at points, or along lines, that would be cleaned by the excursions of food in chewing. It had the definite object of preventing the recurrence of decay at the margins of fillings where recurrence of decay had been most often observed, by so laying the margins as to obtain this cleaning effect. In proximal cavities the points were those which, on account of near contact with proximating tooth surfaces, were not well cleaned by excursions of food in chewing, especially at the linguo-gingival and labio- or bucco-gingival angles. This led to squaring out these angles, making the gingival wall flat, or strictly in the horizontal plane, which was found to be a decided gain. It was also found that in filling buccal and labial gingival third cavities, there was rarely a recurrence of decay if the cavity margins were extended nearly to the mesial and distal angles. Further study of conditions disclosed the fact that so long as the teeth were actively used in mastication, no superficial beginnings of decay were found on those angles of the teeth reaching from occlusal to the gingival; i. e., the mesio-buccal, disto-buccal, mesio-lingual and disto-lingual angles of the teeth. A strict examination of ten thousand persons applying for dental operations in the clinic of Northwestern University Dental School discovered but nine persons in whose teeth decay had spread superficially, or on the surface of the enamel, across these angles. While another count of the same number of persons might give a different result, this is enough to show that these angles are very generally immune areas. It also seemed to demonstrate that decay never crossed these angles in persons who were making the ordinary use of their teeth in chewing food. In each case discovered, the person could not chew food because of sensitive cavities that prohibited the ordinary use of the teeth, and each one had been in that condition for from one to several years. This served to further establish a fact long before demonstrated by ordinary clinical observation.

WHAT EXTENSION FOR PREVENTION MEANS. Extension for prevention means only the laying of the margins of cavities so near these angles as to obtain the benefit of cleaning in the excursions

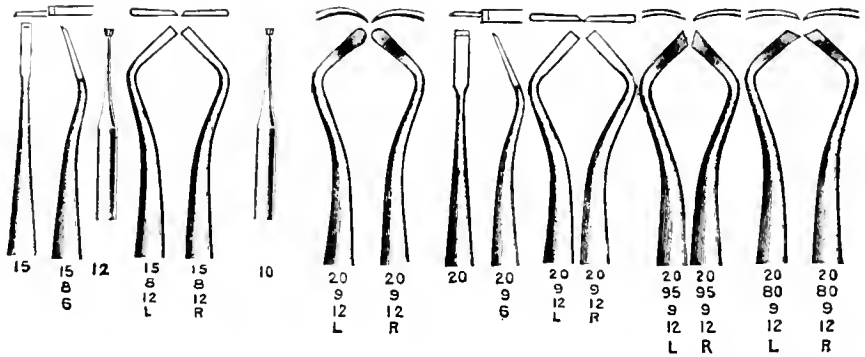

FIG. 154

FIG. 154. The cutting instruments used in the preparation of cavities of the second class, or proximal cavities in the bicuspids and molars. The straight chisel 15, binangle chisel 15-8-6, inverted cone bur 12, chamel hatchets 15-8-12 are for securing outline form; the same instruments, particularly the inverted cone bur, for resistance and retention form; the inverted cone bur 10 for convenience form; the spoons 20-9-12 for removal of remaining carious dentin; the straight chisel 20, binangle chisel 20-9-6, chamel hatchets 20-9-12, gingival margin trimmers 20(95)-9-12 (for distal) and 20(80)-9-12 (for mesial) for finishing the enamel wall.

of food. If this can be had in narrow cavities, it is well. If it can be obtained by separating the teeth and building prominent contacts, that is well. If the case requires wide cutting to accomplish it, that should be done. If the case is one that has become immune to caries, that fact may have consideration.

CLASS 2. CAVITIES IN THE PROXIMAL SURFACES IN BICUSPIDS AND MOLARS.

ILLUSTRATIONS: FIGURES 154-245.

CASE ILLUSTRATING THE MEANING OF EXTENSION FOR PREVENTION. Figure 155 shows a narrow decay penetrating the enamel and burrowing in the dentin. Figure 156 represents the rounded gingival portion in this case when the thinner margins of the enamel, which had been undermined by the spreading of decay along the dento-enamel junction, had been removed and the cavity cleared of carious dentin. From the mechanical standpoint, it is a form of cavity unfit to receive a substantial filling because of its rounded contour. Figure 157 represents the same cavity squared out into the box form, with a step cut in the occlusal surface to give the filling additional stability, and Figure 158 exhibits the filling from the same view. Figure 159 represents the abnormal relation of this tooth to its next neighbor, which rendered this narrow cavity ample to remove the margins of the filling from near contact. This is shown in the occlusal view in Figure 160, which gives the outline of the occlusal step after the removal of the sharper grooves of the occlusal surface of the tooth. The excursions of food in chewing will be over the margins of the filling to the gum line and thus the requirements of extension for prevention are satisfied. The cutting of the step in the occlusal surface has nothing to do with extension for prevention. The step is designed to give the filling the greatest possible stability, and, incidentally, to remove all danger from occlusal pits.

THE OCCLUSAL STEP. The demand for the cutting of this step in the occlusal surface is absolute, because of the more secure seating and rigidity which it gives the filling in all proximo-occlusal cavities in bicuspids and molars, wherever the marginal ridge is broken. It must also be cut for filling this class of cavities even if the marginal ridge is as yet unbroken by decay in all cases where the proximating tooth is present, or is to be supplied by a substitute, for the reason that otherwise a good opportunity can not be had to make the filling, nor can a reasonably safe contact point be formed. In a few cases in which the proximating

tooth is to be absent permanently and the decay in the mesial surface is well to the gingival, and the marginal ridge well supported by dentin, a simple proximal filling may be justified. Also in a few cases of decay beginning near the gingival line in old people (so-called senile decay) this may be done to avoid the great amount of cutting that would be required. Cases for this plan of procedure should be confined to those of the most urgent necessity of shielding the patient from prolonged discomfort in the chair in cases that can be most easily approached from the buccal surfaces in such a way as to make the operation reasonably good.

EXTENSION LIMITED BY SEPARATION OF TEETH. Figures 161, 162, 163, illustrate the opposite condition to that given in Figures 155-160. In these, flat surfaces of the second bicuspid and first molar are lying together, as shown in Figure 161. A prepared cavity so narrow as that shown in Figure 157 will not do, but by separating the teeth and building out a prominent contact as shown in Figure 162 or 163, the case is, without excessive cutting, brought into good form for the perfect cleaning of the marginal lines of the filling by the excursions of food. The result is brought about principally by wedging the teeth apart, or separating them sufficiently to build out a prominent contact point. This plan not only protects the margins of the filling in the bicuspid but also places the, as yet undecayed, mesial surface of the first molar in much better condition to escape decay. In Figure 163 the case is made much safer by just a little further extension of the buccal wall of the cavity, showing what just a little bit of cutting will do at a point where the two proximal surfaces are rounding away from each other.

In Figures 217-220, classed under "Management of Frail Walls," the same plan has been used, and may be used to advantage in a large number of cases in practice. In many cases, particularly where the susceptibility to dental caries is very great, wide cutting to bring the margins of the cavity into the cleanest area of the angles of the tooth, which will be illustrated as we proceed, becomes necessary to the highest degree of success. But under no circumstances should extension be carried around the angles of the tooth onto a buccal, labial or lingual surface with the idea of extension for prevention of recurrence of caries, for the reason that the angle of the tooth is the safer place under all ordinary conditions. In cases of rotated teeth, or teeth in abnormal positions in the arch, lines corresponding to the changed relations must be chosen.



FIG. 155.



FIG. 156.



FIG. 157.



FIG. 158.

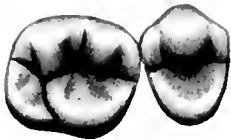

FIG. 159.



FIG. 160.

FIGS. 155-160. A series explaining conditions in which narrow cavities bucco-lingually may be used.

FIG. 155. An upper bicuspid with a narrow decay bucco-lingually that has made some progress in the dentin.

FIG. 156. The frail walls of enamel trimmed away and decay removed, forming cavity with rounded gingival wall, and without an occlusal step. Not a suitable cavity preparation.

FIG. 157. The same as 156 with the gingival wall made flat with the angles squared out to the buccal and lingual walls and an occlusal step cut to afford suitable rigidity for the filling when placed.

FIG. 158. The cavity filled.

FIG. 159. The occlusal surfaces of the bicuspid and first molar before the cavity was prepared, showing the form of contact which caused the cavity to be so narrow bucco-lingually.

FIG. 160. The filling showing its contact with the first molar, and the wide-open embrasures, on account of which a narrow cavity is sufficient in this case to satisfy the demands of extension for prevention.

WHAT EXTENSION FOR PREVENTION DOES NOT MEAN. Extension for prevention does not mean deep cavities in any case. The whole intention is to prevent the beginning of decay in the surface of the enamel. It does not have any reference to caries of dentin whatever. The shallowest cavity that will give sufficient stability to a filling answers the requirement. A much shallower proximal cavity answers the purpose when the occlusal step is used. Under all circumstances in filling teeth, the object should be to make cavities only deep enough to give stability to the filling, except as deeper cavities are required by removal of the last trace of decayed material.

Cutting away frail walls to points or lines of sufficient strength, should in no case be confounded with extension for prevention. This kind of cutting unfortunately leads to the laying of cavity margins on lines less safe by the necessity of placing the line at which the cavity margin approaches or crosses the free margin of the gum on a buccal or labial surface. This is always a dangerous locality as compared with the angle of the tooth.

Further illustrations of the use of the principle of extension for prevention will be found in nearly every case presented.

EARLY DISCOVERY OF CAVITIES. The discovery of proximal cavities while they are yet very small is more difficult than any other. They are hidden away between the proximal surfaces of the teeth and can not be seen. They must be discovered at the time when the enamel rods have just begun to fall away so that the exploring tine will enter, if they are treated at the time at which the least injury will be done to the teeth. Observation of the general practice of dentistry leads to the conclusion that comparatively few of these cavities are discovered and treated so early, and yet there is no doubt whatever but that this early treatment may be done with much less actual injury to the teeth. The examination is often difficult and requires considerable education of the sense of touch in the use of the exploring tine. Many persons have much difficulty in distinguishing between the catching of the point of the explorer between the proximal surfaces of the teeth near the contact point and the entry of the point into a cavity of slight depth. Not infrequently it will be necessary to put on the rubber dam and the separator and lift the teeth slightly apart to be assured of the actual condition. After the decay has extended along the dento-enamel junction, undermining the marginal ridge until the enamel begins to break, so that the patient discovers the cavity, it will often be found

that the decay has progressed so far that the pulp of the tooth is seriously endangered; and certainly much greater harm is done. In the illustrations in Volume I, Figures 107-118, these various conditions are shown. Still, quite a large majority of the cavities in proximal surfaces can be successfully filled without seriously endangering the pulp after the marginal ridge has begun to break down. The opening of such cavities is much easier for the dentist, but the operation should never be delayed on that account.

EXTENSIONS OF CARIES GINGIVALLY. One of the most persistent and disastrous failures in the preparation of proximal cavities of the second class, is in the failure to recognize extensions of caries of the enamel to the gingival of its most common original beginning point, just to the gingival of the contact point, and the conditions under which these extensions occur. In a considerable number of cases, several illustrations of which are given in photomicrographs in the treatise on caries in the first volume, this extension occurs because of conditions which cause food to be so held between the teeth that the gum is forced away, forming a pocket in which acid fermentation becomes established farther to the gingival than the first beginning of caries.

When the enamel rods in the second beginning have not yet broken away, these extensions of decay are very difficult of discovery in the primary examination. Greater care in noting the condition of the interproximal gum tissue would correct many errors in diagnosis. A case is illustrated by the photomicrograph in Figure 164, in which this second decay has begun to the gingival of the first beginning, before the enamel rods have fallen away from the first. In cases of this character in which the penetration of the enamel at the point of original beginning is discovered early, this extension will usually not be discovered in the primary examination, unless it has been suspected because of the discovery of absorption of some of the central part of the interproximal gum tissue. If discovered at all, it will usually be during the excavation of the cavity. When this discovery is not made, the gingival wall of the cavity will most generally be cut to about the position marked *d* in Figure 164. The usual result is that the gingival margin of the filling is undermined by caries in a very short time. The only preparation that will make such a case safe against recurrence of decay, is to continue the cutting so as to lay the gingival cavity margin at the line of *c*, Figure 164. After this has been done the contact point on the finished filling must be so formed as to pre-

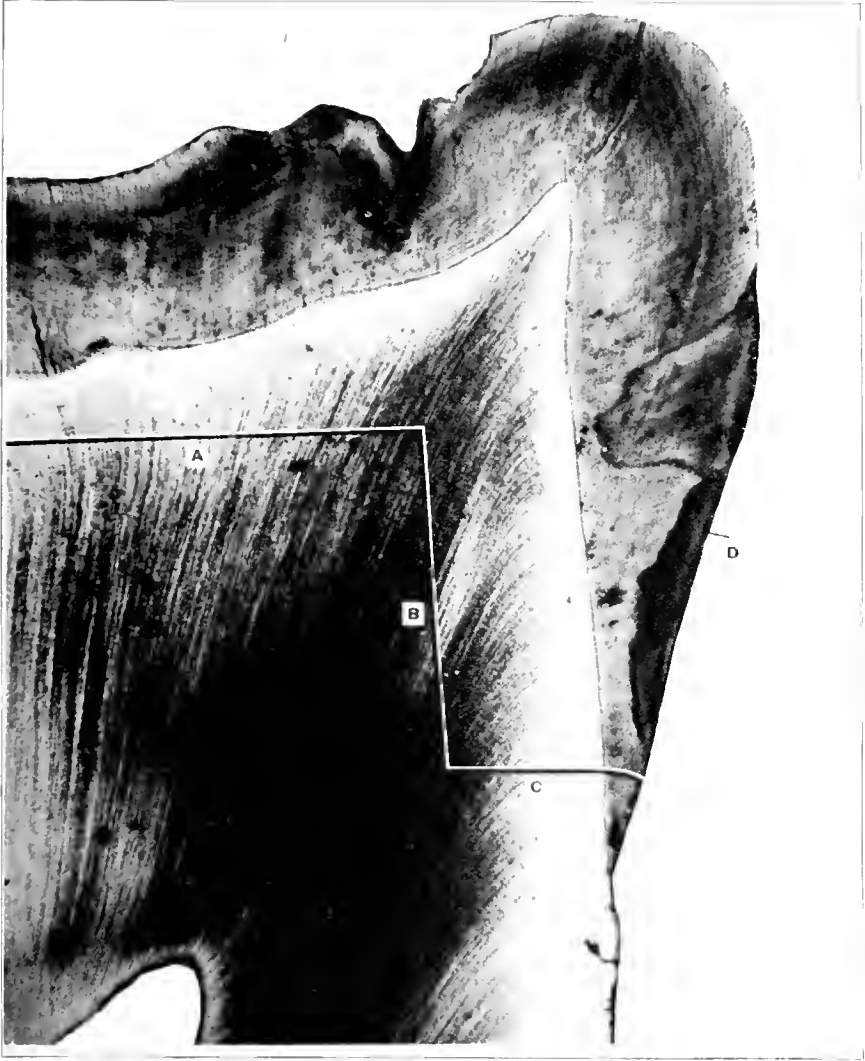

FIG. 164.

FIG. 164. Secondary extension of caries gingivally. This case represents, in a photomicrograph, a secondary extension of caries to the gingival of the first point of beginning, and the danger that it may be overlooked and the gingival wall prepared in the position of the letter *b*. The correct cavity lines would be those marked by the letter *a* for the pulpal wall; *b* for the axial wall, and *c* for the gingival wall.

vent the recurrence of similar conditions. In this case the axial wall B, and the pulpal wall of the step A, have been outlined on the photomicrograph. This figure, while showing a little less than the mesial half of the crown of the tooth, shows clearly the relation of the cavity to the pulp and the amount of cutting required to make the case safe against recurrence of caries to the gingival of the filling.

The detection of this form of extension of caries while excavating must usually be done by carefully noting the appearance of the enamel forming the gingival wall, and especially the appearance of its cavo-surface angle. If caries of enamel has extended, as shown in this illustration, the margin of the gingival wall will show a little whitish, or possibly will be quite white, distinguishing it sharply from the solid vitreous appearance of the sound enamel. In the case illustrated, this whitish portion would be slightly more than one-fourth the thickness of the enamel wall at D, which would appear as a fine whitish line on the immediate margin of the cavity wall. When excavating proximo-occlusal cavities, this should always be especially looked for, and, in cases in which it is discovered, the cutting gingivally must be continued until the whitened enamel has been removed. Then the enamel wall will show the solid vitreous appearance to its cavo-surface angle.

SIMILARITY OF THESE EXTENSIONS TO UNDERMINING OF GINGIVAL WALLS OF FILLINGS. The occurrence of this class of extensions of the beginning of caries to the gingival is very exactly similar in principle to those new beginnings of caries at the gingival margins of proximal fillings that have wrecked so many so-called contour proximal fillings in the past. In making these, the form of the contact point has not been so perfectly suited to the requirements as to prevent food from clinging between the teeth. The result has been that the food particles so held have been pushed onto the gum septum, causing a little absorption of it, and have formed a pocket in which acid fermentation has occurred. This has been sufficiently hidden away between the teeth to prevent the free dissipation of this acid in the surrounding saliva and it has acted upon the enamel, causing the beginning of caries. In the case illustrated in Figure 164, the decaying enamel just to the gingival of the original contact has become swollen, which the photomicrograph shows perfectly, broadening the contact and roughening it. This causes the contact to grasp food particles and hold them, to be finally forced deeper into the interproximal space with the result related. In this view, the two

eases, while so unlike, are precisely similar in principle, and produce similar results. The careful operator will take especial note of this in the preparation of these cavities and in the forming of the contact points of the fillings. The form of the contact point will be considered under finishing of fillings. See Figures 396-398.

PLANS OF EXCAVATING SECOND CLASS CAVITIES.

ILLUSTRATIONS: FIGURES 165-186.

DESCRIPTION OF CASE. Examination with the explorer has revealed a beginning decay in the mesial surface of an upper first molar in which the enamel rods have begun to fall away in the central area. Figure 165. The difficult point in the beginning of the preparation of such a cavity is to get the first decisive break in the enamel of the occlusal surface. This surface, as shown in Figure 166, is apparently perfect. There is no decay in the central pit. The mesial marginal ridge is firm enamel, not yet undermined by decay.

OUTLINE FORM. OPENING THE CAVITY. In this case the operator may choose between three plans of procedure. The first plan is to open the central occlusal pit with bibeveled drill 8 or 10 in the engine, cutting no deeper than to be sure the dentin has been entered. The drill is much better than the bur when there is no decay in the pit. Enlarge the opening sufficiently with a larger drill or round bur to admit inverted cone bur 10 or 12. By entering the inverted cone bur at the dento-enamel junction and pressing it toward the mesial groove and drawing it to the surface, make cut after cut, following the mesial groove until the mesial marginal ridge is cut through. Enlarge this slot by chipping the enamel from its margins with the enamel hatchets 15-8-12, then undermine the enamel by running the bur again against the buccal and then the lingual walls of the slot and again chip away the enamel. Repeat this until the slot formed is sufficient to partially uncover the area of decay in the mesial surface.

The second plan, and often the best, is to place a sharp chisel 10 slightly diagonal to the marginal ridge, engaging its angle in the enamel close onto the mesial rounding of the ridge beside the mesial groove, if it is apparent, and tap it lightly with the mallet; turn the other angle of the chisel to the other side of the mesial groove and tap it lightly and repeat this on one side and then the other several times. This will generally break away

the enamel rods in a small V-shaped space. Remove this and continue this, picking out the enamel little by little until the cavity of decay is reached and uncovered. As soon as a break has been made for a starting point, a bibeveled drill in the engine may be made to penetrate to the dentin. Then the cut into the cavity may be made with the inverted cone bur. After enlarging this opening by chipping from either side, uncovering the carious cavity, the bur may be engaged in the dentin close to the dento-enamel junction and by pressing it distally along the line of the mesial groove and drawing it slowly to the surface, cut after cut may be made until the central pit is reached.

The third plan is to place a separator in position for a moment, lifting the teeth apart sufficiently to permit the use of chisel 10, or a smaller width hoe of 6 angle, approaching the cavity from the buccal direction. The instrument may be used first to chip off small flakes of enamel from the buccal direction and its position gradually shifted more and more to the occlusal as the enamel is chipped away closer to the marginal ridge, until finally the enamel of the ridge itself may be chipped away with the instrument held in the occlusal direction. In cases in which the separator has been placed in order to determine the presence of the decay, the enamel may be broken away by this procedure at the time. An inverted cone bur may then be used for continuing the undermining of the occlusal enamel, as mentioned above. Either form of this cut should ordinarily be made in a few moments, after a little experience.

If considerable burrowing of decay in the dentin has occurred, undermining the enamel, these first cuts with the chisel are very easily made and the use of the drill is unnecessary. This will open the way to chip off the enamel forming the marginal ridge with the length of the edge of the chisel placed mesio-distally, first toward the buccal and then toward the lingual, and continue removing the marginal ridge until the enamel is found supported by sound dentin to both the buccal and the lingual. In the cutting, especially if done by hand pressure, the edge of the chisel should be set very close to the margin to be chipped and the enamel cleaved off in little flakes, the direction of the pressure and the motion being almost in the line of the length of the enamel rods, but slightly inclined in a direction to throw the chips off from the free surface into the cavity. The instrument must be very sharp to be effective. The enamel should be cut away toward the central fossa, as far as it can well be done by the chisel.

OUTLINE OF OCCLUSAL STEP. The next procedure is to cut the outline of the step in the occlusal surface, as shown in Figures 167, 168. Select an inverted cone bur 10, and, placing its shaft nearly or quite parallel with the long axis of the tooth, enter the bur sidewise into the dentin just beneath the dento-enamel junction and draw it slowly to the occlusal surface of the enamel. Repeat this motion in cut after cut, following the mesial groove distally to the pit in the central fossa. Then, with straight chisel 15 or with the enamel hatchets 15-8-12, chip away the enamel from either side of the slot formed by the bur. Pass the bur along the slot again, first pressing it strongly to the lingual, undermining the enamel in that direction and then to the buccal, and again chip away the enamel both to the buccal and to the lingual. Repeat this until the step occupies the full middle third of the occlusal surface bucco-lingually to and including the pit in the central fossa. The buccal groove and other sharp grooves should be cut out, as in the preparation of occlusal cavities. This completes the outline form of the occlusal portion.

In cutting the proximal portion to outline form, enamel hatchets 15-8-12 should be used with a few strong, vigorous strokes to trim the overhanging enamel from the buccal and lingual walls. This cutting may often be done easily with the straight and binangle chisels. Then sweep the enamel hatchets around the gingival wall with a scraping motion, cutting to sound dentin. Note particularly that the enamel hatchet of the proper bevel to cut the lingual wall should cut to the lingual in trimming the gingival wall; while the one with the proper bevel to cut the buccal wall should move to the buccal in cutting the gingival wall. If the cavity is shallow mesio-distally, this will incidentally remove most of the carious dentin; but that is immaterial. If the cavity is very deep mesio-distally, no further effort should be made at this time to remove the carious dentin.

When the buccal and lingual walls have been cut away to sound dentin, it is often necessary to extend them farther. They should be cut well into the embrasures, both buccally and lingually, so that the cavity margin will be removed from near contact with the proximating tooth. See Figure 167. The amount of this cutting must be determined by the depth of the embrasures in each case. When much sound enamel must be removed, it is easier to do it by introducing an inverted cone bur 10 into the dentin close against the dento-enamel junction, about the



FIG. 165.



FIG. 166.



FIG. 167.



FIG. 168.



FIG. 169.

FIGS. 165-169. A series for the illustration of cavity preparation in upper molars.

FIG. 165. An upper molar with a beginning decay in the mesial surface. The enamel rods have begun to fall out over a small area only; but little burrowing in the dentin has occurred. The tooth is a heavy, strong, short crowned molar. The person heavily muscled and the bite strong.

FIG. 166. A broad and rather flat, but well marked occlusal surface; a form that gives sufficient space for even a broader occlusal step than seems required for the case, without danger to the recessional lines of the pulpal horns.

FIG. 167. The prepared cavity, mesial view, showing the depth of the step, which is intended to give a strong anchorage, and the relation of the gingival wall to the gingival line.

FIG. 168. The occlusal view of the prepared cavity, showing the mesio-distal depth of the proximal portion. It is not deep.

FIG. 169. The finished filling, which shows best the wide outward inclination of the mesial portion of the buccal and lingual walls.

bucco-lingual center of the length of the gingival wall, and carry it buccally to the buccal wall with several cuts, squaring out the bucco-gingival angle. It should then be drawn along the buccal wall toward the occlusal surface, undermining the enamel along this wall also. The undermined enamel is easily cut away with the enamel hatchets, or by clipping with the chisel used from the mesio-buccal angle of the tooth through the embrasure. The linguo-gingival angle of the cavity and the gingival wall should be extended in the same way, using the same instruments. The lingual wall should be extended to a line where its margin will be in view past the proximating tooth, when looking across the central incisors at the median line. The extension of the buccal wall should be made to correspond. When the effect of this rule is carefully examined by placing the edge of a straight chisel in the embrasure of any two bicuspids, or the bicuspid and first molar, it will be seen that the effect will vary the width of cavity as the embrasures are deep and wide, or narrow and shallow. The former makes a narrow cavity, while the latter makes a broad cavity. Either places the margin of the cavity where it will be well cleaned in chewing. In some instances it will be found that after this extension has been made, a line of superficial injury to the enamel extends beyond the margin of the cavity at one or both of its gingival angles. This should be carefully looked for, and, when found, the cavity should be farther extended so as to include the injured portion.

EXTENSIONS GINGIVALLY. It must now be determined whether or not the gingival wall has been sufficiently extended gingivally for its margin and its buccal and lingual angles to be covered by the free margin of the gums when the filling is finished. If not, it must be extended farther to the gingival. An inverted cone bur 8 or 10 should be placed with its flat end against the gingival wall, and inclined sufficiently for its edge, or circumference, to engage, and a cut made within the dentin along the dento-enamel junction to the bucco-gingival angle. It should then be inclined in the opposite direction and a cut made into the linguo-gingival angle. In this cutting, the operator should be very particular that the bur follows the dento-enamel junction and that it does not cut deeply into the dentin. The object should always be to avoid very deep cavities. In this way the enamel to the gingival is undermined and may be much weakened by passing the bur a few times with pressure against its inner side. It may then be removed with the enamel hatchets and the gingival wall be made horizontal and smooth. The angle

of junction of the gingival with the buccal and lingual walls should be sharp and definite in the dentin, but should be made slightly curved in the enamel. The gingival enamel wall should be examined carefully for extension of caries of enamel gingivally. This should complete the outline form. See Figures 167, 168.

RESISTANCE FORM AND RETENTION FORM. Resistance form and retention form in this cavity require that in the step portion the pulpal wall be flat and the surrounding walls parallel, the same as these would be in a simple occlusal cavity; and that in the mesial portion the gingival wall be flat and meet the axial, buccal and lingual walls in the dentin in sharp angles and that these three walls be practically at right angles to the gingival wall, the buccal and lingual dentinal walls being parallel to each other. Wherever the form of the occlusal surface will permit, the occlusal step should be made in the form of a dovetail, which will add materially to the retention form. After outline form has been completed, the changing of the cavity to the boxlike form for resistance and retention is largely accomplished by an inverted cone or fissure bur 10 held with the flat end against the pulpal wall and carried around this wall, making sharp angles where it meets the buccal, distal and lingual walls. Centrally the depth of the pulpal wall should be little more than the thickness of the enamel at the occlusal pit, but if it is made flat, the depth will be greater to the buccal and lingual because of the rising of the cusps. Figure 168.

In the proximal portion the same bur may be held in the same position in relation to the gingival wall and carried along the junction of the gingival with the buccal, axial and lingual walls, making these angles sharp and at the same time making the gingival wall flat. The squaring out of these angles in the proximal portion may often be done with the enamel hatchets. These instruments should generally be used to square out the lines of junction of the axial with the buccal and lingual walls.

CONVENIENCE FORM. Most persons would prefer convenience points in the gingival portion of the cavity for retention in starting a gold filling, Figures 170-173. These are made, one in the axio-bucco-gingival angle, and one in the axio-linguo-gingival angle, by pressing an inverted cone bur into the dentin slightly and drawing it a short distance to the occlusal along the bucco-axial line angle and the linguo-axial line angle respectively. These give sufficient starting points and will retain the filling while the building of this part is in progress.



FIG. 170.

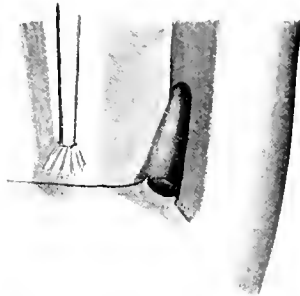

FIG. 171.



FIG. 172.

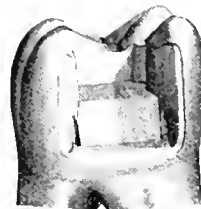

FIG. 173.

FIGS. 170-173. A series illustrating the cutting of convenience points, which, in the proximal cavities in the bicusps and molars, are intended to prevent movement of the gold in the building of the proximal portion of the filling. These are not intended for any especial service as resistance or retention anchorage for the filling in after use.

FIG. 170. The most common form of the convenience point, showing only a small portion of the bucco-axio-gingival region of the cavity as seen complete in Figure 173. When the cavity is otherwise completed, an inverted cone bur 8 or 10 is pressed into the angle, cutting mostly into the buccal wall without sinking into the gingival wall, and then drawn toward the occlusal for a short space. It is then replaced and the cut repeated a sufficient number of times to make a cut a little less than the width of the bur head in depth, which thins away and runs out toward the occlusal.

FIG. 171. In positions in which special difficulty in this first building is expected, the first pieces of gold will hold a little stronger if the bur head is sunk just a little, one-half the length of the bur head, into the gingival wall.

FIG. 172. The convenience point as prepared with a chisel. This is the best form for operators who have as much as eighteen or twenty pounds hand pressure, otherwise the cut with the bur is best.

FIG. 173. A cavity with the convenience points cut in the axio-bucco-gingival, and the axio-linguo-gingival angles.



FIG. 174.



FIG. 175.

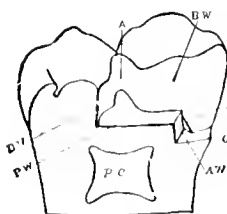

FIG. 176.

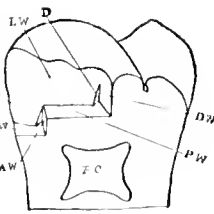

FIG. 177.

FIGS. 174, 175. A molar tooth with a prepared mesio-occlusal cavity, split mesio-distally, and opened so as to display all of the internal parts of the cavity.

FIGS. 176, 177. An outline explanation of Figures 174, 175. The cavity walls are lettered with the initial letters of the names of the walls. For those walls that are partly in both halves, the gingival, axial, pulpal and distal walls, the initial letters are given for each half. The others, the buccal and lingual walls, appear in the halves to which they belong. The convenience points, a and c, are introduced as cut with the chisel. The disto-lingual pulpal convenience point b is used only in cases in which it is desired for beginning the filling in the step, or making an independent beginning in that portion of the cavity after having built up the gingival portion. With this convenience point to work from, gold may, in mesial cavities, readily be built across along the disto-pulpal line angle into the V shaped space a, made by cutting out the buccal groove, and a very secure anchorage made for the building of the step portion of the filling.

In making these, the bur should not be sunk into the gingival wall, but the square end should be kept level with that wall, as shown in Figure 170. In some cases in which a particularly strong hold on the gold is thought to be needed in starting the filling, at the last the bur head may be sunk half its length into the gingival wall, as shown in Figure 171. This will hold the gold driven solidly into it very strongly and is the full limit of cutting into the gingival wall that should ever be done. The cutting into the gingival wall for the anchorage of fillings, either as grooves or pits, as has been practiced, is pernicious, in that it causes many checks and breaks of the enamel in a position not easily seen. They have been the cause of the loss of many otherwise excellent fillings. Figure 172 gives another form of convenience point as cut with the chisel. This latter is the best form. If the operator has a finger thrust with the pen grasp of eighteen to twenty pounds or more, he can make this form easier than that made by the bur and with much less pain to the patient. For this purpose, a chisel 15, beveled to an edge on three sides, is the best instrument. The completed convenience points as made with the bur are shown in the cavity in Figure 173. This is to be taken as the type of the convenience points in all proximal cavities, wherever they occur, including the incisors.

REMOVAL OF REMAINING CARIOUS DENTIN. Any decay remaining on the axial wall should be removed with spoons 20-9-12, or in this particular position, with the discoid. Generally, however, in decays treated in their early beginning, there will be no remaining decay.

FINISH OF ENAMEL WALL. The enamel walls are now planed to form. In all of the occlusal portion these may be parallel in the axial plane. In the mesial portion of the cavity, the buccal enamel wall must be inclined strongly to the buccal to agree with the enamel cleavage. The lingual enamel wall must be inclined similarly to the lingual. The inclination given the buccal and lingual enamel walls will depend upon their relations to the angles of the tooth. The gingival enamel wall should be inclined slightly to the gingival. Generally, the plane of the buccal or the lingual enamel wall should each be either perpendicular to the surface of the tooth at the particular point where the enamel margin is laid, or inclined more outward. The inclination will therefore vary with the position.

The cavo-surface angle of all parts of the cavity outline must now be beveled. All, except the gingival and the rounding of the bucco- and linguo-gingival angles, may be done with the

chisels. Special instruments are required for beveling the gingival cavo-surface angle, the gingival margin trimmers 20(80)-9-12, rights and lefts, for mesial cavities, and 20(95)-9-12, rights and lefts, for distal cavities. These instruments are made especially for this purpose. The relation of the edge of this instrument to the gingival cavo-surface angle of the cavity is shown in Figure 195. They have the angle of the edge cut purposely for making this bevel. A few strokes lightly made, carried across the gingival wall and around the angle, first with the right-hand instrument in the one direction and then with the left-hand instrument in the other direction, are sufficient.

In the finished cavity, the dentin walls to the buccal and lingual of the mesial portion should generally not be in the same plane with the enamel walls, but in cavities of ordinary size they should be very nearly parallel with each other and inclined outward only a little from the mesio-distal plane of the tooth. In the occluso-gingival direction, they should be parallel with the long axis of the tooth and parallel with each other.

TOILET OF CAVITY. The cavity now only requires the toilet to be made to be ready for filling. The finished filling is shown in Figure 169.

In the foregoing, the plans of doing the more important things that must be done in the great majority of cases have been presented, and may be regarded as general in their application.

VARIATIONS. The variations of procedure due to position of the teeth in the mouth and the different degrees of exposure of the parts to view and to approach, relate mostly to the second and third molars and to the lower bicuspid. The upper first bicuspid are usually so well exposed that both the mesial and distal cavities are easily reached, and, except that the smaller cutting instruments, as the 15-8-12 and 10-6-12 enamel hatchets and corresponding chisels and spoons are necessary, the instruments and the instrumentation will be the same. Neither is it often necessary to make any variation in distal cavities in the first molar or mesial cavities in the second molar above or below.

Figures 174-177 are presented as a further study of cavity forms. These are a representation of a molar tooth with a prepared cavity, split mesio-distally and opened in order to display all of its internal parts. Figures 176, 177 are outline explanations of Figures 174, 175. A study of these will give a better appreciation of cavity forms.

The cavity form in lower first molars will differ because of differences in the form of the occlusal surface, most generally

taking the form shown in the series of Figures 178-181. This also shows the form of the cutting in the treatment of a beginning decay in the lower molar similar to that shown in the upper. It will be noted that the form varies only with the outline required by the grooves to be cut out. In this the outline in the lower second molars will also differ from that of the lower first because of the difference in the number and direction of its grooves. This does not require any special differences in instrumentation. This boxlike cavity is to be taken as the typical form to be made in all bicuspid and molar proximal cavities wherever situated, and wherever there is sufficient tooth tissue remaining for its formation and to give ample strength to all of its parts.

In distal cavities in the second molar and mesial cavities in the third molar, it frequently happens that the inverted cone bur in the straight hand-piece can not be made to approach the cavity at the proper angle to square out and extend the buccal and lingual angles. In these cases the bur in the contra-angle hand-piece may be substituted, or the cutting may be done entirely with the hand instruments. However, in the greater number of cases in which distal cavities in the second molar are excavated at the same time with mesial cavities in the third, the straight hand-piece may be used for both. This is facilitated by cutting the step in the second molar first and carrying it well to the mesial. This gives additional room for the application of instruments to the distal portion of the cavity and also to the mesial cavity in the third molar.

Occasionally there is difficulty in so placing the inverted cone bur as to begin cutting the step in the occlusal portion from a distal cavity in a second molar. The approach is such that the instrument is inclined so much to the distal that the bur cuts the enamel from the surface inward instead of cutting the enamel from within outward, and for this reason it will not cut well. The proper position of the bur may be obtained with the contra-angle hand-piece, but if the enamel proves very hard, this instrument does not work well. It is better in such cases to enter the occlusal surface through the pit in the central fossa in the usual way of opening pits, or with a drill, if the pit is fully closed, and then enter the inverted cone bur at this point and cut to the distal along the line of the distal groove until the distal cavity has been entered. This slot may then be broadened to the buccal and to the lingual in the usual way to form the step.

The approach to distal cavities in the upper second molars is often somewhat from the buccal, and to facilitate this approach in building the filling, the buccal wall should be strongly inclined to the buccal, whenever this can be done without very positive detriment to the case. One should never neglect to obtain such form as will render the filling of the cavity convenient.

In the lower molars, especially those that have a strong lingual inclination, the form of the distal cavity may be made for filling with reverse pluggers. In this case the buccal wall may be cut parallel with the long axis of the tooth and the gold packed against it entirely with the reverse plugger.

The bicuspid's are much smaller teeth than the molars and deep cutting in the preparation of cavities weakens them rapidly. There is, therefore, even a greater object in treating decays in them very early when this is possible. In their treatment, the same boxlike form of cavity must be used as in the treatment of cavities in the molars. This is modified to suit the form of the tooth, while all of its main features are retained. The same instruments are used, or the smaller sizes of the same patterns. The same care is necessary in extensions for prevention, both to the buccal and to the lingual, and many of them must be cut very wide. In this, however, a greater number have very deep, wide-open embrasures which limit the extension of decay so much that rather narrow cavities may be made.

Figures 182-186 represent an ordinary case in an upper second bicuspid with what may be termed a beginning decay in which the whitening on the surface of the enamel was thought to have extended to the possible buccal and lingual limits under the conditions of the contact and near approach of area of its surface to the first molar. A little burrowing in the dentin has occurred. The occlusal surface is shown in Figure 183 to be apparently perfect, though the grooves are rather deep. In opening the cavity, smaller sizes of the same instruments as were used in the preparation of similar cavities in molars should be selected. Otherwise the opening of the cavity and the whole process of its formation is the same. Figure 184 represents the form of the cavity as seen from the distal, showing the buccal and lingual enamel walls inclined outward, and Figure 185 as seen from the occlusal. This shows the step formed for retention and strength for the resistance of the stress of hard usage and with all of the deep grooves of the occlusal surface cut away. Figure 186 illustrates the finished filling with its contact point a little more rounded and prominent than the original tooth



FIG. 178.



FIG. 179.



FIG. 180.



FIG. 181.

FIGS. 178-181. A series illustrating cavity preparation in lower first molars.

FIG. 178. The mesial surface of a lower first molar, showing a broad whitened area of beginning decay of enamel stretching bucco-lingually from angle to angle. In the central part of the area the enamel rods have begun to fall away.

FIG. 179. The form of the prepared cavity, showing the occlusal step to give the necessary rigidity to the filling, and the outward inclination of the enamel walls of the proximal portion.

FIG. 180. The occlusal surface of the tooth showing rather deep grooves and pits but no caries is apparent.

FIG. 181. The occlusal surface of the tooth after the filling has been finished, showing the outline form of the cavity from that view.



Fig. 182.



Fig. 183.



Fig. 184.



Fig. 185.



Fig. 186.

Figs. 182-186. A series illustrating the formation of cavities in the bicuspids.

Fig. 182. An ordinary cavity beginning in the mesial surface from which only a part of the enamel rods have fallen from the area of beginning decay. The spreading on the surface probably has gone as far as the cleaning by food passing through the embrasures would allow.

Fig. 183. The occlusal surface, which shows no decay in the pits.

Fig. 184. The prepared cavity as it appears from the mesial view. It is cut broad enough for the buccal and lingual margins to be placed where the rounding into the embrasures between the teeth will remove them sufficiently from the surfaces of the proximating tooth to insure cleanliness being maintained by the excursions of food in chewing.

Fig. 185. The cavity from the occlusal view, showing the shallow mesial portion and the rounding step past the buccal cusp in order to give a wide margin to the recessional line of the buccal horn of the pulp. This could safely be approached more closely in case it was thought the strength of the filling required it.

Fig. 186. The occlusal surface of the tooth after the filling has been finished.

form to assist a little in holding the buccal and lingual margins of the filling sufficiently away from near contact with the first molar, that these may be kept well cleaned by the excursions of food through the embasures. The management of this latter feature in the treatment of both bicuspid and molar cavities will be treated in more detail later.

The greatest difficulty is met with in distal cavities in lower bicuspids that have a strong distal and lingual inclination. It is in these that a contra-angle hand-piece and the reverse pluggers are most needed. These teeth are often small and the crowns long and decayed far to the gingival. They are difficult to reach with direct instruments. In such cases, at least two teeth to the distal should be included in the rubber dam. Even if the first and second molars are lost, the rubber should include the third molar to give good room for the use of the mouth mirror for light and to hold the rubber out of the way of instruments. It will then be found that the cavity is easily reached with hand-cutting instruments and the contra-angle hand-piece, and is readily filled by using the reverse pluggers. In the absence of reverse pluggers, much of the filling must be made by hand pressure. The form of the cavity should not differ materially from the forms produced in other teeth. If, however, it is decided that direct mallet force is to be employed to the greatest possible extent, the disto-buccal angle of the tooth should be cut boldly away sufficiently to give access to the gingival wall, and the greater part of the cavity walls generally, and the step carried close against the mesial marginal ridge. This will allow a direct approach from the disto-buccal direction to all of the cavity walls, except the axio-bucco-gingival angle, which must be filled by hand pressure.

RELATION OF CAVITY WALLS TO RECESSIONAL LINES OF PULPAL HORNS. If a careful study is made of the forms and extent of cavities permissible without cutting the recessional lines of the pulpal horns, it will be found that there is generally sufficient room between the recessional lines to make fillings with ample strength. The point that is most likely to give difficulty occurs in the lower first molars where broad mesial decays occur during the childhood period, i. e., before fifteen years of age. In these it will sometimes be difficult to obtain sufficient width between the recessional lines of the mesio-buccal and the mesio-lingual horns of the pulp, combined with a proper depth over the mesial marginal crest of the pulp to give enough strength to sustain the broad mesial portion of the filling. This will be

better appreciated by a careful examination of Figure 181. In this the mesial portion of the cavity is cut narrow. Very many times it must be broader bucco-lingually. In my own work for children these have pulled away a little occasionally from the margins, causing a leak by the stretching of the narrow part of the filling between the two mesial cusps. Through fear of pulp exposure, this part was not made strong enough to resist the stress of mastication. In mature persons there is generally room for sufficient depth of step over these horns, when this becomes so imperative as to call for greater risk of pulp exposure. In doing this, one will occasionally be surprised by the exposure of an extra long pulpal horn. At this age, root fillings may be made that are good and the exposure of the pulp is not so serious, but we are not justified in taking the chance of an exposure in the tooth of the child. The general rule is that when the decay may all be removed without cutting the recessional lines of the pulpal horns, the strength of the tooth will be ample. It is only after the removal of the pulp and cutting out these recessional lines that breakage of the tooth is feared. In all of this, it must be remembered that the object should be to keep the cavities as shallow in all parts as the penetration of decay will allow, and to make them no deeper than is essential for sufficient anchorage. Broad cutting is often necessary in proximal cavities to prevent recurrence of decay, but this does not necessitate deep cutting.

DANGER OF PULP EXPOSURE IN CAVITY PREPARATION.

ILLUSTRATIONS: FIGURES 187-196.

In the excavation of proximal cavities, there is always danger of pulp exposure when the decay in the dentin is deep. This danger is much increased when there is also a deep pit cavity, which seems to include the requirement of a deep step in order to obtain a flat pulpal wall. Figure 187, an upper first molar split mesio-distally for the purpose of showing the decayed areas together with the buccal half of the tooth, is the first in a series of ten illustrations designed to illustrate more definitely the positions of instruments, the steps in the progress of excavating and plans of avoiding pulp exposure in the preparation of cavities of this class.

DESCRIPTION OF CASE. The case chosen is in a young person. There is a decay in the occlusal surface and a decay in the mesial surface. The extent of these is shown in Figure 187. The pulp chamber is large and the horns of the pulp are long.

This is indicated by the prominence of the cusps of the tooth and the age of the patient. The horns of the pulp are very nearly under the highest points of the cusps, and the recessional lines of the pulpal horns converge toward the angles of the pulp chamber, usually converging a little more rapidly as the pulp is approached. These guides indicate the probable position of the horns of the pulp and the localities to be avoided in any of the cutting of sound dentin to obtain resistance form, retention form or convenience form. They also indicate the localities in which the horns of the pulp may be exposed in the removal of carious dentin. The rule should be that the recessional lines of the horns of the pulp should not be cut. Therefore, in young persons the step in the occlusal surface should be cut between the recessional lines of the pulpal horns. The carious dentin must be removed, however, even though the pulp is exposed in the process. But this should rarely come as a surprise and the instrument used and the direction of cutting should be such as will cause the least pain or do the least injury to the pulp. The illustration being a central mesio-distal section, does not show the length of the horns of the pulp, because it does not cut through them, but this is indicated on the mesial in the pictures by making the recessional line of the mesial crest of the pulp diagrammatically prominent to represent the probable length of the mesio-buccal horn, and the relation of the decayed areas to this is shown.

OUTLINE FORM. In Figure 188, the position of the chisel for the first cuts in the chipping away of the undermined enamel is shown in each of these cavities. No one should attempt to remove this with the bur in the engine, because it is more difficult and more distressing to the patient. In this case the mesial marginal ridge is undermined by decay but is still very strong. The position of the chisel shown in the mesial cavity is a favorite one for the first movement. The instrument blade is laid firmly over the crest of the marginal ridge of the bicuspid, with its bevel toward that tooth as shown. The edge is engaged in the enamel over the decay, and with strong pressure the handle raised (in the direction indicated by the small arrow) and a chip split off and thrown into the cavity. After one or several strokes in this way by hand pressure, the chisel should be turned with its bevel in the other direction, the mallet used, and the chipping continued until all of the undermined enamel is removed, uncovering the area of decay as shown in Figure 189. Next the enamel should be chipped from over the pit cavity, as shown in Figure

188, first using chisel 10 or 15 with hand pressure, and later with mallet strokes, chipping from the more convenient points as the work progresses. Mallet pressure is usually the best after the first few cuts. In the distal part of the cavity wall, it is often best to reach across and use the pulling motion, so called, in splitting away the overhanging enamel. This is illustrated in Figure 189. The edge of the chisel is engaged close to the margin of the broken edge of the enamel, and, with a downward pulling motion, chip after chip can be thrown off in rapid succession. This is continued in different directions until the cavity of decay is uncovered, as shown in Figure 189. In this case the two cavities are separated by a strong strip of enamel firmly supported by sound dentin. This is difficult to remove with chisels. For the removal of this, engage an inverted cone bur 10 in the dentin close against the dento-enamel junction and force it in toward the line of the mesial groove and draw it slowly to the surface of the enamel. Let the bur cool a moment and then repeat the movement. Make cut after cut, following the mesial groove — the weakest line in the enamel — until a slot is cut uniting the two cavities. Now run the bur along this slot, pressing first to the buccal and then to the lingual, Figure 190, undermining the enamel as far as the slope of the bur head will allow. Chip this undermined portion away with enamel hatchets 15-8-12, or the corresponding width chisels, as shown in Figure 191. Continue this by repeating the undermining and chipping until the opening is as wide as may be desired for the step. The bur, if carefully used, will have made the pulpal wall of this portion flat. In making these cuts, the bur may be entered in the pit cavity and the first cut made toward the mesial cavity if that should seem the most convenient in any particular case. The last of this cutting is shown in Figure 191.

VARIATION OF PROCEDURE WHEN PULP EXPOSURE IS FEARED. At this point the question of the possible exposure of the pulp will become important. Therefore, the enamel walls should be trimmed with the enamel hatchets and chisels and the buccal grooves cut out as in Figure 192, but not deeper at first than the dento-enamel junction, particularly in the occlusal part of the cavity. The walls of the mesial portion of the cavity should be cut to sound dentin in every direction, using the enamel hatchets, as shown in Figure 192. This will have completed roughly the outline form, except the extension that may be necessary in the mesial portion. At this point the rubber dam should

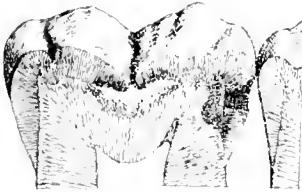

Fig. 187.

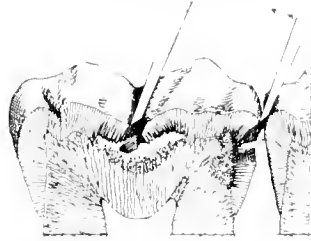

Fig. 188.

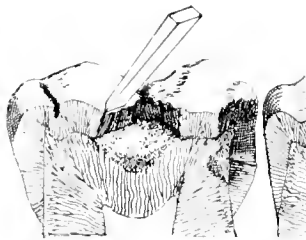

Fig. 189.



Fig. 190.

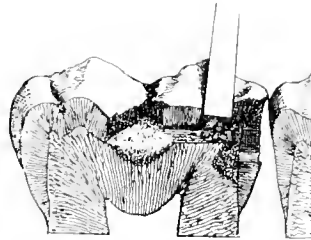

Fig. 191.

FIGS. 187-196. A series of ten pen pictures illustrating methods of excavating deep mesio-occlusal cavities and avoiding pulp exposure. The tooth is cut mesio-distally and only the buccal half is used. The deuto-enamel junction is made diagrammatically prominent. The cut is, of course, not in the line of any of the horns of the pulp, but the recessional line of the mesial crest of the margin of the pulp is darkened for a space, representing the probable length of the mesio-buccal horn of the pulp.

FIG. 187. The buccal half of a lower molar split mesio-distally, displaying a cavity in the occlusal surface and an independent cavity in the mesial surface. In the case of a young person with the large pulp chamber at that age, these cavities should be regarded as seriously endangering the pulp.

FIG. 188. The chisel in position for beginning chipping away the undermined enamel over each of the decayed areas. The first chip is represented as broken away in each.

FIG. 189. Represents the progress in chipping away the undermined enamel with the chisel in position for removing the distal portion by the pulling motion.

FIG. 190. The inverted cone bur in position for cutting a slot through the sound portion of enamel between the two cavities.

FIG. 191. The chisel or enamel hatchet removing the enamel undermined by the bur, widening the slot.

be placed and the cavity cleaned and dried. The cavity is now in condition to be immediately sealed — after appropriate treatment of the exposure — if the pulp should be exposed in the removal of carious dentin from the occlusal cavity, which is the danger point in this case.

REMOVAL OF REMAINING CARIOUS DENTIN. With spoon 20-9-12 loosen the decayed mass carefully some little way from the margins around the periphery of the cavity. Then, choosing the most favorable position, force the spoon with such direction as will follow close against the sound dentin across the cavity, the endeavor being to turn out the whole of the softened material at a single stroke. (See Figure 132.) Then scrape the remaining softened material from every part of the area.

RESISTANCE FORM AND RETENTION FORM. No pulp exposure is found in this case, but the central area of decay is found to be so deep, as shown in the remaining figures of the series, that to cut the step to the same depth and to the full width necessary would almost certainly expose the mesial horn of the pulp. Moreover, the step as first cut between the two cavities is deep enough, with the rise of its walls on the slopes of the cusps, to give the required stability. Or, in cases in which that seems to be required, the cavity may be filled fuller, and the cusps of the occluding tooth ground away to accommodate it. Therefore, instead of cutting the step to the full depth of this part of the cavity, a shelf or ledge is cut around it to the depth of the step between the two, as shown in Figure 193 and the remaining figures, which gives the filling a sufficient seat to prevent any inclination to tip or move under stress. Additional safeguarding against the cutting of the recessional line of the mesio-buccal horn of the pulp which is in greatest danger, is made by rounding the cut about the mesio-buccal cusp, as shown in Figure 196 and those preceding it.

COMPLETION OF OUTLINE FORM. The extension of the mesial portion of the cavity is to be made to the gingival, the buccal and the lingual, completing the outline form. The inverted cone bur in the straight hand-piece of the engine is placed in the deeper part of the gingival wall close against the dento-enamel junction, as shown in Figure 193. Its angle is engaged in the dentin and it is first carried out to the buccal wall and then replaced and carried to the lingual wall in a series of cuts that are supposed sufficient. In the last of these, it is well to press the edge of the bur hard against the inner surface of the enamel to weaken it so that it will be more easily broken. This is then

cut away with the enamel hatchets, used with a scraping motion. At this point a close examination of the cavo-surface angle of the gingival wall should be made to discover any appearance of an extension of superficial caries gingivally.

The requirements of extension for prevention are now to be satisfied by sufficient extension for the conditions, to the buccal and to the lingual. For this purpose, the inverted cone bur is placed in the bucco-gingival angle close to the dento-enamel junction and pressed into the buccal wall and drawn toward the occlusal, undermining the enamel, which is then trimmed away with chisel 15 or enamel hatchet 15-8-12, as shown in Figure 194. Similar cutting is done to the lingual. When this extension is found satisfactory, it completes the outline form. Often in making this extension, it will be found necessary to broaden the mesial portion of the cavity at the occlusal, flaring it more until the part of the surface of the tooth that begins to curve around into the embrasure is reached.

COMPLETION OF RESISTANCE FORM AND RETENTION FORM. The mesial portion of the cavity is now trimmed to form with the chisels and enamel hatchets, completing the resistance form and the retention form as for the cavity previously described.

CONVENIENCE FORM. Every part of the cavity should be examined with reference to convenience of placing the filling, and any necessary corrections made. Finally the convenience points should be cut in the bucco-axio-gingival and the linguo-axio-gingival angles, as previously described and shown in Figures 170-173.

FINISH OF ENAMEL WALL. The walls are now to be corrected and smoothed and the cavo-surface angle slightly beveled in every part. Figure 195 shows the position of the gingival margin trimmer 20(80)-9-12 and the special adaptation of the angle of its edge in beveling the cavo-surface angle along the gingival wall and rounding the bucco-gingival and linguo-gingival angles of the enamel margin. In beveling the cavo-surface angle, the bevel should be cut in a distinct plane and have distinct angles with the cavity wall and with the surface of the tooth. They should not be rounded. This distinct angle is necessary in order that the filling material may be finished against it definitely and not feathered out over a rounded edge. Mechanically, the only method of doing this is with hand cutting instruments. These angles should never be polished with strips, disks or any similar instruments. Now make the toilet of the cavity.

The finished cavity is shown in Figure 196. The depression in the pulpal wall may be filled with cement, if thought neces-



FIG. 197.

FIGS. 197, 198, 199. A series of low power photomicrographs showing a cross section of a bicuspid tooth with a decayed area, prepared cavity and filling.

FIG. 197. Section of a bicuspid tooth showing extensive area of decay in the distal surface (above) and a beginning of caries of the enamel in the mesial surface. The buccal horn of the pulp has been cut in making the section.



FIG. 198.

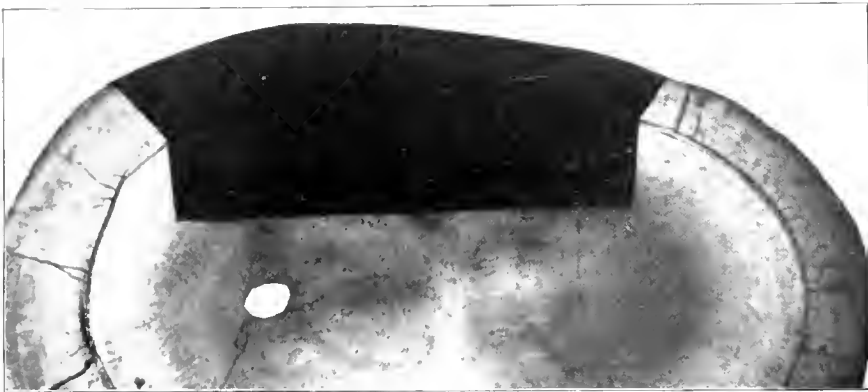

FIG. 199.

FIG. 198. The same as Figure 197, showing the proximal part of the tooth prepared for filling. The convenience points are omitted. A comparison with the previous illustration will show that the axial wall is no deeper than is necessary to remove the decayed area of dentin.

FIG. 199. Cross section of the filling in place. Notice that the fulness of its surface will hold the margins of the filling well away from a proximating tooth of similar form.

sary, as a protection against the effects of thermal changes. Notice particularly in this series of drawings the supposed approach of the mesial horn of the pulp is diagrammatically shown by a darkening of the recessional line of the mesial crest of the pulp. Cutting deeper than this supposed point has been strictly avoided except in the removal of decayed dentin in the central portion where the form of the pulp gives more room. Also the cutting of the step has been rounded about the recessional line of the mesio-buccal horn of the pulp in order to avoid cutting that line at a point even nearer the occlusal enamel. In the preparation of cavities for young people, this precaution should never be omitted unless rendered necessary in the actual removal of decay. Often the point of the mesio-buccal horn of the pulp approaches much closer to the enamel than is anticipated and an accidental exposure results. The split teeth, Figures 107, 109, Volume I, which are not very young teeth, show what one may sometimes find in the persistence of this horn of the pulp. In one of these it is not only very long, but it is also very large.

CROSS SECTIONS OF PROXIMAL CAVITIES AND FILLINGS.

ILLUSTRATIONS: FIGURES 197-205.

In order to further illustrate the form that may be given the mesial or distal portion of proximo-occlusal cavities to the gingival of the step, several photomicrographs with low powers from cross sections are introduced here. Figure 197 is from a cross section of a bicuspid, enlarging it about twelve diameters, showing extensive injury by caries in the mesial surface and a beginning decay in the enamel in the distal surface. With the low power of the lens with which this is made, the direction of the enamel rods could not be well shown, but there is enough checking from drying to give a general idea of the direction in which the enamel splits most readily and from this the direction of the enamel rods may be fairly well made out. This section shows how irregular this direction is occasionally found to be and the necessity for determining this in any given locality by watching during the chipping of the enamel. The buccal horn of the pulp penetrated this section, showing its position perfectly. The lingual horn did not penetrate the section, but its recessional line is cut across, showing imperfectly the position it occupied when the person was younger. The decayed area in the upper part of the picture, or mesial portion, is an ordinary one for bicuspids.

Figure 198 shows the form of the prepared cavity, omitting the convenience points for starting the filling, and Figure 199

shows the form — in section — of this portion of the filling. In this case the extent of the softening of the dentin is unusually well shown in Figure 197. The other two figures show that the depth of cutting is only sufficient to completely remove the carious area.

The cavity should be squared up to that depth whenever this can be done without endangering the pulp of the tooth, which is clearly permissible in this case. It is also best to have some portion, or, where the necessary extension is not too great, all of the dentin walls parallel, as shown in Figures 198, 199. The enamel walls, however, must be cut in the directions shown, varying their inclination to suit the direction of the enamel rods in each particular case. In examining these illustrations, it will be easily seen that polishing the cavo-surface angle of the enamel with disks, or in any other way in which the definite cavo-surface angle shown would be rounded, would result in a poor margin of the filling material by forming a thin edge. The form of the surface of the filling, as shown in Figure 199, is so rounded as to give a small contact with the proximating tooth and to hold its buccal and lingual margins well away from near approach to the surface of the proximating tooth in order that the excursions of food may clean them.

In Figure 200, a bicuspid is shown in cross section with injuries to both mesial and distal surfaces by decay which has penetrated the dentin but very slightly; yet the injury is as broad bucco-lingually as in the previous series. In the two following pictures, the position of the recessional lines of the horns of the pulp are well seen, but with increasing age they have become shorter and do not penetrate the section. In this the cavity (Figure 201) has been cut as deep as in the previous case in order to give stability to the filling. The pulp is not especially endangered by such a cavity, provided the step is not cut too wide and deep in the teeth of young people. These cavities are necessarily wide, as will be seen by the injury of the enamel. Therefore, considerable cutting of sound tissue in their formation is a necessity. This should be carefully examined in comparing Figure 200 with Figures 201 and 202. In Figures 201, 202, a greater bevel has been given the cavo-surface angle of the cavity, showing rather an extreme thinning of the filling material at the buccal portion. In studying Figure 202 one may note that this extreme thinning could have been avoided by cutting just a little farther so as to pass the sharply rounded portion of the surface. This would necessarily have been at the expense

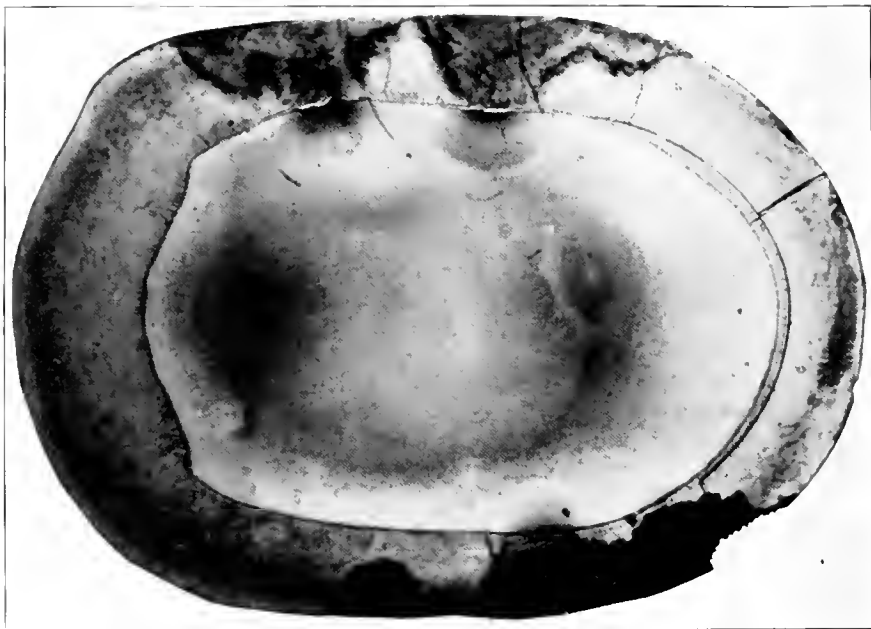

FIG. 200.

FIGS. 200, 201, 202. A series of photomicrographs of a cross section of a bicuspid, and the same with the cavity prepared, and a cross section with the filling in place.

FIG. 200. A low power photomicrograph of a cross section of a bicuspid, showing an extensive decay of the enamel of the distal surface (above) that has begun at two separate points. From each beginning the decay has penetrated the enamel and caused some solution of the dentin. No enamel rods have fallen away. In the mesial surface another decay has begun which is abnormally to the lingual because of a lingual position of the proximating tooth.

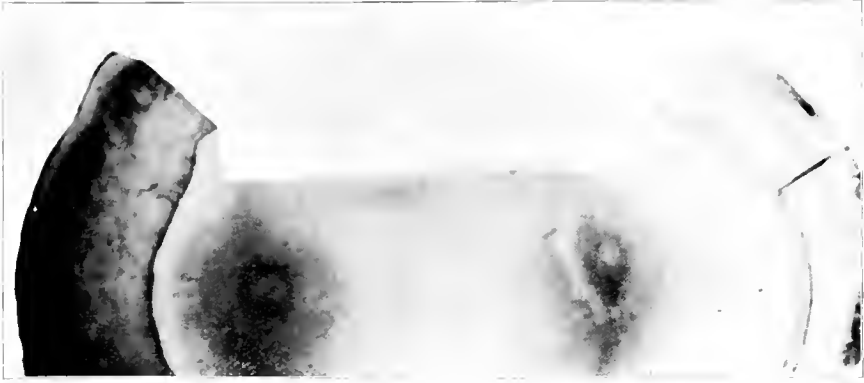

FIG. 201.

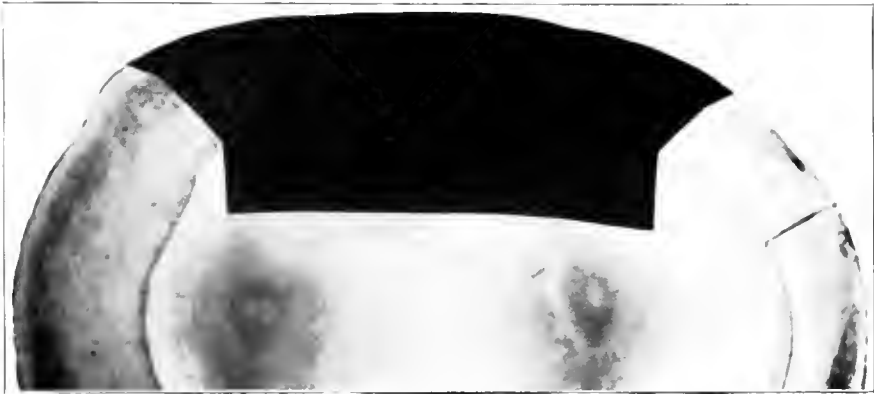

FIG. 202.

FIG. 201. The same section as Figure 200, showing the proximal part of the prepared cavity. This picture shows the recession lines of the pulp cut across above the ends of the pulpal horns.

FIG. 202. The filling in place. This shows prominently the thinning of the filling material on the level of the buccal enamel wall, and gives a warning as to the danger of too great a bevel.

of most of the portion of the buccal dentin wall that is parallel with the lingual dentin wall, but this could well be done by cutting a little deeper convenience point to hold the filling during the building of this portion. Notice particularly that if this were a filling for a person fourteen years old, the recessional lines of the pulp would have to be avoided for safety against pulp exposure when forming the step. The dentin walls would have to be converged to meet the narrower step.

Figure 203 is a cross section of an upper first molar with an injury by decay which is just penetrating the enamel in the distal surface and extending much to the buccal because of a little irregularity of its position in relation to the second molar. The greater part of the carious enamel has been lost. In this case there was also an extensive pit decay in the occlusal portion, of which the deeper part of the softened dentin is cut through and has cracked in drying. This serves to obscure the position of the recessional lines of the horns of the pulp. Notice also that a decay which is broad from buccal to lingual was starting in the enamel of the mesial surface and try to make out how broad the cavity in that surface would need to be to render it safe against further decay. Immediately this question is asked, one wishes to see the form of the contact with the next tooth, without which the question can not be definitely answered.

The decayed enamel of the distal surface, the rods of which had not fallen out in grinding, were accidentally lost in mounting. The remains of enamel in such decays are often very frail. There is practically no injury to the dentin. If all cavities of decay could be filled thus early, it would be much better for the teeth. The injury by decay of dentin to the depth of such a cavity as shown in Figure 197 is a much greater injury to the tooth than the cutting of such a cavity in sound dentin. In the latter case, examinations have shown that the dentinal fibrils generally remain alive between the filling and the dental pulp, while, if the dentin has been decayed, they generally will be found dead to the pulp chamber some years later. The form of cavity — omitting the convenience points — recommended for this case is shown in Figure 204. In all cavities of the bucco-lingual breadth shown in these series of cross sections, it is best to cut the enamel walls and the dentin walls on distinctly different planes as shown. In many of the wider extensions, this becomes impracticable; and then all or a part of the dentin wall paralleling the opposite wall must be sacrificed in order to make the extension sufficient for the purpose, and also bring the step as

narrow as it must be. In other words, both the enamel walls and the dentin walls must be boldly inclined outward and the filling held by anchorage in the step.

WIDTH OF BUCCAL AND LINGUAL EXTENSIONS.

In the series, Figures 206-210, another illustration is given of the management of proximo-occlusal cavities. A cavity that is not very broad bucco-lingually has burrowed to some depth in the dentin. There is also an occlusal pit cavity with considerable extension of decay along the dento-enamel junction. In this case, the decayed areas are uncovered by chipping away the undermined enamel, as has been described in other cases, and the cavity finished in the form shown in Figure 207, and filled as in Figure 208. It is only in some unusual form of contact and near approach of surfaces that so narrow a filling bucco-lingually will answer the purpose in the mesial surface of an upper first molar. It would be correct form for a contact made by a partially rotated second bicuspid which presented its distobuccal angle to the center of the filling in the molar, making a very narrow contact with wide open embrasures similar to that shown in Figures 159, 160. On the other hand, if the broad, flat distal surface of a second bicuspid lies close against the molar, making a broad contact bucco-lingually and a much broader area of near approach of surfaces, such a filling would be of no real value to a person in whom susceptibility to caries was at all considerable. In that case the operator must choose between a very broad filling bucco-lingually, or a wide separation of the teeth and building out a prominent contact point to hold the surfaces apart, as has been illustrated in Figures 155-160, and again in Figures 217-220. If the very broad cavity is chosen, the excavation will be similar to that shown in Figure 209. The filling in this broad cavity is shown in Figure 210. In this case, the parallel dentin walls shown in the series of Figures 197-205 must be abandoned and these walls flared out boldly and the widening extended distally well onto the step portion of the cavity. In doing this, it is unnecessary to cut any deeper into the tooth anywhere than the deepest point of the penetration of decay, all of the extensions being shallow. Even in such a case as this, it is best to be careful to round past the recessional line of the mesio-buccal horn of the pulp, as shown in this figure, in any case in which the cusps of the tooth are prominent, even though the cavity be comparatively shallow. This is especially necessary if the patient is young. Much experience in cutting

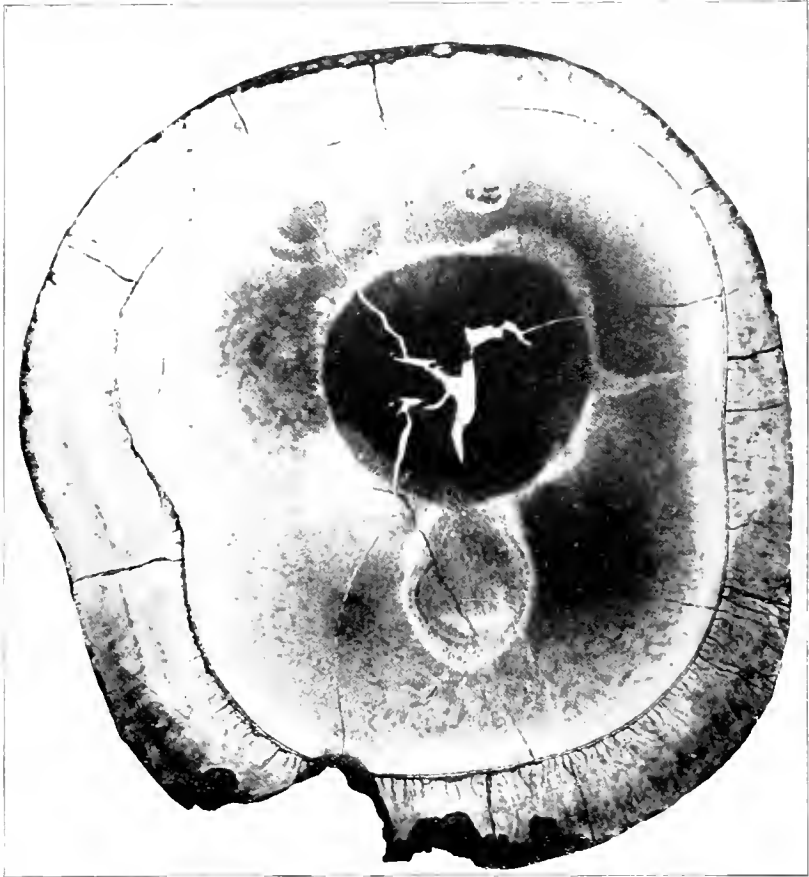

FIG. 203.

FIGS. 203, 204, 205. A series of photomicrographs of cross sections of a molar tooth showing a carious cavity, prepared cavity, and a filling, in the distal surface portion.

FIG. 203. This shows the various decays. The decay in the distal surface has passed through the enamel and entered the dentin; there is a broad beginning of decay in the enamel of the mesial surface. The section has cut across the deeper portion of a decay that has entered the dentin from the central pit of the occlusal surface. The irregular white spot in the center is the result of an injury to the photographic film.

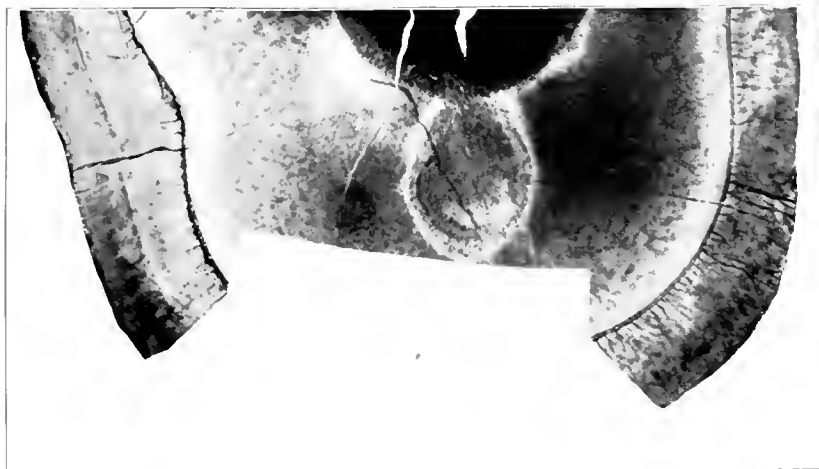

FIG. 204

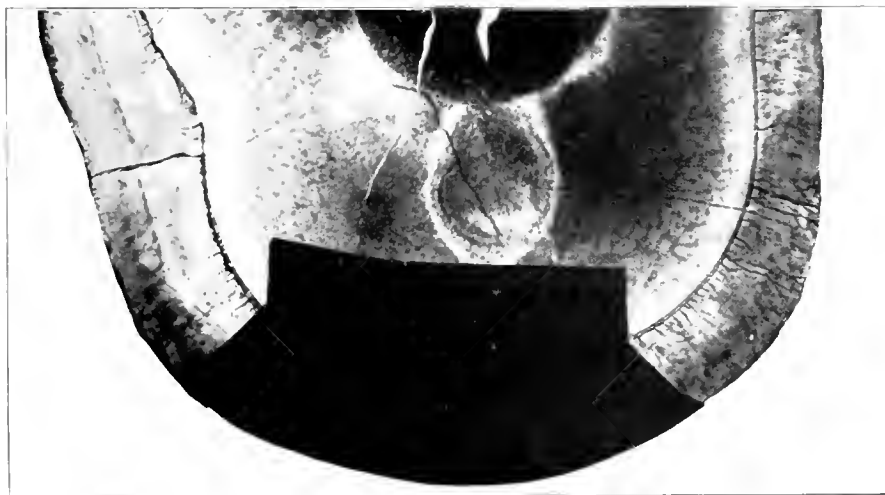

FIG. 205.

FIG. 204. The same section as Figure 203, with a cavity cut for the removal of the decay in the distal surface and entering to a sufficient depth in the dentin to make the strength sufficient. The section is through the proximal portion only of the prepared cavity.

FIG. 205. A cross section with the filling in place, showing only the cross section of the proximal portion.

such cavities and many years of observation have shown them to be very safe for the tooth's pulp and very effective in protecting against recurrence of decay.

A point of considerable value in deciding which shall be used, a very broad filling or a wide separation and prominent contact, will be the condition of the proximating surface of the next tooth. In case decay has not yet begun in this, a prominent and small contact will do much to protect it from the beginning of decay later.

MANAGEMENT OF WEAK CAVITY WALLS IN BICUSPIDS AND MOLARS.

ILLUSTRATIONS: FIGURES 211-245.

IN THE LOWER MOLARS, especially when the contacts are very broad, the proximal cavities are likely to be deepest toward the lingual, and to burrow extensively along the lingual dento-enamel junction. In these cases the lingual wall will be weak at the mesio- or disto-lingual angle of the tooth, and this not infrequently extends to the central line of the lingual surface. In all such cases the removal of the angle, including the lingual cusp, mesial or distal, is imperative. In mesial cavities this should usually be done by catching the enamel near the margin of the cavity with the sharp edge of a binangle chisel, and with a pull toward the cavity, split off the undermined enamel. This may be thrown off, chip after chip, easily until a point is found at which it is supported by sound dentin, or strong enough for a filling to be built against it and restore the lost contour with safety. Distal cavities of this class are very difficult to fill when the whole of the cusp must be removed.

DESCRIPTION OF CASE. When a prominent disto-buccal cusp on the lower first molar makes contact well to the occlusal on the second molar, the buccal cusp of the second molar is more often badly undermined. Such a cavity of the worst type is illustrated in Figures 211-213, which may be taken as a type of the preparation in such cases. In a considerable number of these, the pulp will be living and may be retained alive and the filling sufficiently anchored in the distal portion of the tooth. In the case illustrated, however, the pulp is to be removed.

OUTLINE FORM AND REMOVAL OF DECAY. The area of decay is rapidly uncovered by the chisel, using hand pressure or the mallet on the buccal portion and by the pulling motion over the lingual portion of the occlusal surface. On the lingual, the cusp is found to be supported by sound dentin, but the buccal cusp is completely undermined. The question first to be determined

is how far toward the gingival this undermining of the enamel has gone. The cutting away of the cusp should proceed at once and this point determined, for, if it reaches to the gingival line, the propriety of going farther with the case with the view of building a filling may well be questioned. In this case, however, enamel complete in thickness and strength is found mid-length of the crown with dentin supporting it just a little farther to the gingival. The rubber dam is now placed and the decay removed. The pulp is uncovered in this process. All conditions have been made ready and the pulp is immediately anesthetized by cocain under pressure, and removed with the broach. The cavity may now be sealed with gutta-percha and allowed to rest for a week with a dressing laid loosely in the root canals. At the next sitting, the root canals are filled, provided the conditions are favorable. In all such cases the rubber dam is adjusted and the field of operation made clean before the temporary filling is removed. When the root fillings are in place and have been allowed to rest for a week, if thought desirable, the excavation may again proceed. The mesial half of the buccal enamel wall is trimmed flat in the horizontal plane to the mesio-buccal angle of the tooth. In the distal portion, the buccal wall and the lingual wall are found to be abundantly strong. The distal groove is cut out to the marginal ridge and much broadened, as shown in Figure 212, and is given good retention form, but is not cut much deeper than the thickness of the enamel in the central fossa. The lingual groove is cut out upon the same level. The gingival wall, which must be at a lower level, is trimmed flat in the horizontal plane and the remainder of the mesial portion of the buccal wall rounded down to the pulp chamber, retaining the full strength of the remaining dentin. The outline form is now completed.

RESISTANCE FORM AND RETENTION FORM. For the completion of the resistance form and the retention form, the floor and walls of the pulp chamber are squared up into a box form with fairly definite angles.

CONVENIENCE FORM. No especial convenience form is required in this cavity.

FINISH OF ENAMEL WALL. The finishing of the enamel wall and beveling of the cavo-surface angle should be as previously described, the direction of the enamel rods governing the plane of the enamel wall in every position, and the bevel of the cavo-surface angle making the enamel margin safe. The toilet of the cavity should then be made.



FIG. 206.



FIG. 207.



FIG. 208.

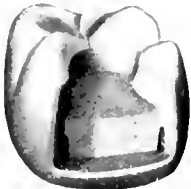

FIG. 209.



FIG. 210.

FIGS. 206-210. A series of pictures for the further illustration of cavity preparation in the first molars.

FIG. 206. An upper first molar with a cavity in the mesial surface that has burrowed in the dentin, but not sufficiently to require a very broad cavity for the complete removal of decay.

FIG. 207. A cavity prepared with the cutting as little extended as complete removal of all undermined enamel would allow.

FIG. 208. The filling placed in the narrow cavity.

FIG. 209. The same tooth with a cavity prepared with the full limit that extension for prevention could allow in any case. Only actual undermining of enamel and destruction of dentin would justify further extension. Generally so broad an extension could not be justified. A much less extension than shown is very generally sufficient. The narrow cavity, however, is too narrow to serve in the usual conditions in such a case.

FIG. 210. The filling in the extended cavity.



FIG. 211.



FIG. 212.



FIG. 213.

FIGS. 211, 212, 213. A series illustrating the management in cases of very frail walls.

FIG. 211. A mesio-occlusal cavity in a lower molar in which there is extensive undermining of the enamel and wide destruction of dentin.

FIG. 212. The prepared cavity showing the extent of the cutting. The pulp has been removed and the pulp chamber squared up to afford additional anchorage. Anchorage is also obtained in the undecayed distal portion of the tooth. The mesial half of the buccal wall is cut away to half the length of the crown.

FIG. 213. The filling restoring the shape of the crown in full, building up the lost buccal wall. This may be made of gold or amalgam, or by a slight modification of the walls a gold inlay may be used.

In a cavity so prepared, either a gold or an amalgam filling can be made that will do perfect service and be thoroughly durable, or a gold inlay may be used. In either case, the filling would appear as in Figure 213, with the mesio-buccal cusp built to the original form and made to occlude as the original cusp occluded. It is rather unnecessary labor to carve sharp grooves in such a filling.

THE LINGUAL GROOVE IN LOWER MOLARS. In occlusal cavities in these teeth, the central pit, in which decay begins, is often much nearer the lingual than the buccal surface, because of the rounding of the buccal surface toward the occlusal. Also the lingual groove is more frequently deep and imperfectly closed than the others. For these reasons, decays beginning in the central pit or lingual groove more frequently extend to the lingual enamel plate and undermine it in its central portion mesio-distally, even in cavities that are not very much extended in other directions. In these cases the lingual groove should be cut out over the crest of the marginal ridge and the marginal ridge itself removed well toward both the disto- and mesio-lingual cusps, as shown in Figures 214, 215, in a mesio-lingual view of a lower right first molar. The chipping away of the undermined enamel does not differ materially from the plans hereinbefore described and illustrated. The occlusal enamel should first be removed, exposing the whole occlusal area of the decay beneath the surface. In the effort to find supporting dentin, the undermining of the lingual wall by decay will be disclosed. Then this may be cut away until sufficient strength is found, usually with the binangle chisel reaching across the cavity and using the pulling motion. The cut in the lingual enamel plate may be trimmed to form, as shown in Figure 215, with the enamel hatchets 20-9-12, right and left, working from the buccal, or the most of it may be done with the straight and binangle chisels. This portion of the enamel wall should be cut to a right angle with the surface of the tooth in all of its parts, substantially as shown in Figure 215. When these cavities are deep, and the cusps of the teeth are long, the same care must be taken against cutting the recessional lines of the horns of the pulp and exposing them, as has been described and illustrated for both occlusal and proximo-occlusal cavities. Here attention is again called to the matter of cutting out grooves in deep cavities on a different level from the general level of the pulpal wall, as shown in Figures 140, 141. Such treatment as is here shown gives very substantial results. The gap formed in the lingual wall

may be built over and the form of the tooth restored, as seen in Figure 216.

IN THE UPPER MOLARS, the buccal wall is more often the weak wall. This does not so often occur in case of occlusal cavities, though it is not very infrequent. But oftener in mesial cavities the mesio-buccal angle is found badly undermined by decay. If the decay has spread along the dento-enamel junction until it has reached the enamel under the cusp and left it unsupported, the cusp should be cut away at once and be restored with the filling material. Often in mesial cavities, decay will have extended far to the buccal without undermining the cusp, in which case an extension of the enamel margin will not meet the requirements without the removal of the cusp. In such cases the enamel wall should be finished in the bucco-lingual plane. Here the rule that, when the enamel must be cut near to the line of a developmental groove, it should be cut to the groove or a little beyond it, should be applied in case the buccal groove is in question.

UNDERMINING OF THE DISTO-LINGUAL CUSP OF UPPER FIRST MOLARS. In upper first molars, with large disto-lingual cusps, the contact point is often toward the lingual, and caries of the distal surface is therefore likely to begin in such position as to undermine the disto-lingual cusp and weaken the lingual wall of the cavity. Also the disto-lingual groove is usually deep and sharply sulcate in these teeth, and forms a very weak line in the enamel. Therefore, unless the lingual enamel wall is found well supported by dentin, the cusp should be removed and the enamel cut away to the disto-lingual groove, and the cutting continued gingivally until good strength is found.

This is illustrated in Figures 217-220, showing the upper first and second molars, with the cavity in the distal surface of the first molar disclosed by the breaking in of the weakened distal marginal ridge. As the teeth stood in the arch at the time, the area of the contact and of near approach of surfaces is very broad bucco-lingually. This is, in part, from the loss of the prominence of the disto-lingual cusp by the breakage of the contact point and in part by the twisting or rotation of the teeth by the lingual part of the prominence of the distal cusp making contact farther to the lingual after the first breakage, which threw the pose of the teeth out of the balance with the forces tending to hold the teeth solidly in contact. Attention was first brought to this balance of pose of the contact points by the results of Dr. Robert Arthur's method of cutting V-shaped



FIG. 214.



FIG. 215.



FIG. 216.

FIGS. 214, 215, 216. Management of weak lingual walls in lower molars.

FIG. 214. A mesio-linguo-occlusal view of a lower molar with an occlusal decay which has burrowed widely in the dentin and especially along a badly fissured lingual groove.

FIG. 215. The prepared cavity. A portion of the enamel of the lingual surface was found undermined and weakened by backward decay and was cut away. The buccal grooves were not badly undermined but were so sharp and deep as to require that the cutting extend to the marginal ridge. A cavity of the depth shown would often expose the pulp in the tooth of a young person.

FIG. 216. The cavity filled, restoring the lost portion of the lingual wall.



FIG. 217.



FIG. 218.



FIG. 219.



FIG. 220.

FIGS. 217-220. A series illustrating the management of a weak disto-lingual angle in an upper molar. Also a broad contact and the use of separation and restoration with a prominent contact point.

FIG. 217. Upper first and second molars, showing a disto-occlusal cavity in the first molar. The contact is very broad and close. The teeth are large, angular and strong.

FIG. 218. In uncovering the cavity by chipping away the undermined enamel, it is found that the whole occlusal portion of the disto-lingual cusp has been undermined and the enamel much weakened by backward decay. Therefore, the cutting was continued until the cusp was removed over onto the lingual surface, as shown in this illustration. Notice particularly that the cutting includes the whole width of the linguo-distal groove, passing over onto the lingual surface.

FIG. 219. This illustration exhibits a more extended cutting of the lingual surface made necessary by deeper burrowing, which may often be treated successfully by this plan.

FIG. 220. The case after the filling is completed. After the cavity has been roughly prepared and it has been found that the pulp will not be exposed, some time is taken in separating the teeth. Notice that in Figure 218 the bucco-distal angle as prepared is in contact with the second molar, the surface of which is very flat. Then compare this with the relation of this angle to the second molar in Figure 220, which shows the separation and the use of the prominent contact point.

spaces to the lingual for food to be driven through in chewing for the prevention of recurrence of decay*. It was found that, in time, many of the teeth treated in this way would so rotate in their sockets that the flat surfaces would come together, making matters much worse than before. This was because the resistance was out of pose with the forces holding the teeth solidly together in the arch. This should be a lesson to us in making prominent contacts, that we may so place them as to properly balance the forces which tend to keep the teeth close against each other in the arch and the contacts close, which is so essential to comfort in chewing and to the health of the periodontal membranes. In the case illustrated in these figures, it was found, as the area of decay was uncovered, that the enamel of the entire occlusal portion, and a considerable part of the lingual portion of the disto-lingual cusp, had been undermined by the spread of decay along the dento-enamel junction. This occurs in a considerable number of cases that have been neglected until the distal marginal ridge is broken in by usage. When this has been discovered, the excavation should be continued and the outline form otherwise roughly completed, leaving for the time any portion of the lingual enamel plate standing that seems strong enough for temporary use. Otherwise than this, the cavity should be completed according to the plans given and illustrated, as shown in Figure 218. This will determine whether exposure of the pulp will complicate the case. It will generally be found that the disto-lingual horn of the pulp is much shorter than the others and the cutting can pass across its recessional line, as illustrated in Figure 219, farther to the gingival, or deeper in the tooth than any of the others. In these cavities the recessional lines of the other horns of the pulp are not, as a rule, seriously endangered, as will be seen by the curved lines of the cavity avoiding them in Figures 218, 219.

At this point, the separation of the teeth must be provided for. A matrix may be thrown around the distal half of the tooth and a good gutta-percha filling placed. After the removal of the matrix, the bucco-lingual center of this filling may be forced against the proximal surface of the second molar with a warm instrument. Then, if there is good occlusion of this with lower teeth, the patient may be instructed to do as much of the heavier work of chewing food on this as possible for three or four weeks. The pressure of such mastication will be continually forcing the

* "Treatment and Prevention of Decay of the Teeth," 1871.

gutta-percha more and more against the second molar. The intermittent use of the separator, in conjunction with the gutta-percha, as will be described later, may be employed.

When the teeth are sufficiently separated, the cavity may be again opened and the excavation finished (with rubber dam on) by cutting down the weakened lingual wall to the disto-lingual groove on the lingual surface and enough past it to make a good finish, as shown in Figures 218, 219. Then the walls are to be corrected for convenience form and the surfaces finished, the toilet of the cavity made, and it is ready for filling. In this case, the filling, as shown in Figure 220, has been built out to a prominent contact, increasing slightly mesio-distal breadth of the tooth to promote the excursions of food over the line of its buccal margin and to protect the as yet undecayed, broad, flat proximal surface of the second molar. The movement actually made in separating in this case was one millimeter. By taking time for the occlusion to slowly adjust itself to the changed relations of the teeth, as much as three, or even four millimeters separation, may be made in teeth, the necks of which have been allowed to drop together by loss of portions of their proximal surfaces.

This case is further illustrated in Figures 221, 222, 223, in disto-linguo-occlusal views of the first molar with its cavity and with two pictures giving differences in the cutting of the lingual surfaces. In Figures 224, 225, 226, linguo-occlusal views are given of the same case. These illustrate more clearly the cutting of the lingual wall.

The cavity as here shown is suitable to receive either a gold or an amalgam filling. For a gold inlay, it should be modified in such form only as might be found necessary to gain conditions to allow an impression to be drawn from it without distortion.

UNDERMINING OF ANGLES OF BICUSPIDS. In the upper bicuspids, the buccal angles are most likely to be undermined first because of the contact point being well toward the buccal, and the first beginning of decay occurring just to the gingival of it. When the angle, either mesial or distal, is so undermined that the enamel is unsupported by dentin, it should be cut away to the mesio-buccal or disto-buccal groove respectively. This groove, though generally so well closed on the buccal surfaces of the bicuspids as not to be very apparent, is still a weak line in the enamel, at which it is more than usually liable to break.

This undermining is most often seen in the mesio-buccal



FIG. 221.



FIG. 222.



FIG. 223.

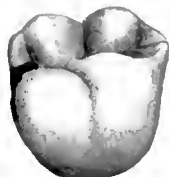

FIG. 224.



FIG. 225.



FIG. 226.

FIGS. 221-226. Two series of additional illustrations of the restoration of the disto-lingual angle.
FIG. 221. The molar tooth and cavity from the disto-linguo-occlusal view.
FIG. 222. The restoration cutting just over the marginal ridge.
FIG. 223. The restoration after removal of much more of the lingual portion.
FIGS. 224, 225, 226. Linguo-occlusal views of the same restorations.

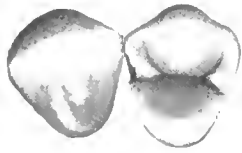

FIG. 227.



FIG. 228.



FIG. 229.



FIG. 230.



FIG. 231.



FIG. 232.

FIGS. 227-232. A series illustrating the management of weak angles of the bicuspids.

FIG. 227. The first bicuspid in contact with the cuspid, showing a decay broken through the marginal ridge.

FIG. 228. The appearance of the cavity from the mesial view.

FIG. 229. The cavity prepared by the older plan of removing some of the frailer portions of the undermined enamel and the decay without properly forming the cavity.

FIG. 230. A careful uncovering of the whole of the area of decay by chipping away until the enamel is found supported by sound dentin shows that the whole of the mesio-buccal angle must be removed to, and just past, the mesial buccal groove. The result of this and the cutting of the box form of cavity with the occlusal step gives the correct cavity preparation.

FIG. 231. The filling from the mesial view.

FIG. 232. The filling from the occlusal view.

angle of the upper first bicuspids in decays not otherwise very large, because of the very small contact made by the distal prominence of the cuspid tooth. This, and the treatment recommended, are illustrated in Figures 227-232. In Figure 227 the cuspid and bicuspid in their normal relation show the form of the contact, which is such as will, in case of decay occurring, cause a very narrow break in the enamel. Figure 228 shows the crown of the bicuspid with the opening through the enamel. In such a case we should expect considerable burrowing of decay in the dentin, and a rather widespread undermining of the enamel, because this is most likely to occur where a small opening into the dentin has existed for a considerable time.

In the older plan of preparing such cavities by cutting away the frailer edges of the undermined enamel and removing only the carious material, leaving the cavity rounded as made by decay, such a cavity as is shown in Figure 229 would be produced. In this the stronger margins of the undermined enamel remaining would be depended upon mostly for the support and the security of the filling. While many such fillings have done good service, the amount of failure by that method has caused its general abandonment.

In the first beginning of the excavation, chip away all of the undermined enamel, leaving none that may receive the impact of the occlusion in chewing food. In some positions in which the enamel does not receive the impact of the occlusion and has not been weakened materially by backward decay, as often happens on the labial surfaces of incisors, esthetic considerations demand that it be retained to diminish the apparent size of the filling. The observations of fillings made with care in these teeth show that this is justified. In the mesial surface of the upper first bicuspid, the esthetic demands are almost equally great, but experience has shown so much breakage of enamel so retained in this position, that such a course can not be recommended. In such a case, the chipping of the enamel should be carefully continued until all of the undermined enamel is removed; and if, as in this case, it approaches the developmental groove running over the marginal ridge, this should be cut away for reasons already explained, and the cavity prepared as shown in Figure 230. The steps in the preparation of such a cavity do not differ from those already given in any essential of the process, except that the burrowing of decay has required that we cut over onto the buccal surface. This is not extension for prevention. The cutting is carried beyond the safest point or line on which to

place the buccal enamel margin and is a violation of the rules for extension for prevention made necessary by extension of decay within the dentin, not on the surface of the enamel.

Figure 231 is a proximo-occlusal view of the completed filling, and Figure 232 a view of the occlusal surface in contact with the cuspid. This latter gives the best idea of its form. Although this is a large filling, the buccal cusp of the tooth is abundantly strong and the filling is well supported.

In case it should become necessary to make a filling in the distal surface of this tooth at a future time, the cavity would be cut in the ordinary way, cutting out so much of the step portion of the present filling as might be necessary to give it stability. If it was thought that the removal of the whole step portion was necessary, the separator should be placed and the first bicuspid should be pressed against the cuspid with as much force as possible in separating the bicuspids, and the filling removed to the marginal ridge so that the new filling could be anchored over it with mallet strokes in the direction of the long axis of the tooth. Under such conditions the malleting would have no tendency to disturb its mesial portion. Much experience with this operation has shown it to be safe and effective if the first filling has been well condensed.

Such a cavity as has been shown in this series may receive a porcelain filling by making such changes as will allow an impression, or a matrix, to be withdrawn. The step portion, however, would have to be cut deeper in order to give a stronger body of porcelain for greater strength. A porcelain filling would be far better from the esthetic point of view if the shade and degree of translucency is well matched. Yet, if the color or the form is off at all, or so much that it will attract the eye, or a shadowy cement line will raise a question, then from the esthetic point of view a well finished gold filling is to be preferred.

MESIO-DISTO-OCCLUSAL CAVITIES IN THE BICUSPIDS WHEN THE PULP IS ALIVE AND WHEN THE PULP IS REMOVED. In Figures 233-245, a case is presented for treatment involving several distinct conditions. In the upper first molar there is an ordinary mesial cavity, in the treatment of which there is no special difficulty. In the second bicuspid there is a decay in the distal surface and a decay in the mesial surface, both of which have burrowed deeply in the dentin. A mesio-occluso-distal filling is required. The pulp is not exposed. In the first bicuspid, the mesial and distal cavities are deeper and broader; the pulp is exposed and

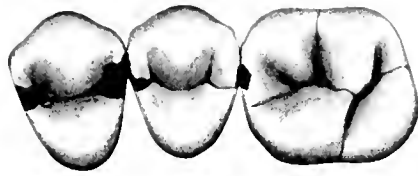

FIG. 233.



FIG. 234.



FIG. 235.



FIG. 236.



FIG. 237.



FIG. 238.

FIGS. 233-245. A series of illustrations of the management of badly decayed bicuspids. The first molar is included in the illustration, but it has only an ordinary cavity and does not need to be considered.

FIGS. 234, 235. A distal and a mesial view of the decays in the second bicuspid. Examination shows that a mesio-occluso-distal cavity must be prepared.

FIGS. 236, 237. Distal and mesial views of the prepared cavities.

FIG. 238. The filling as seen from the distal.



FIG. 239.



FIG. 240.



FIG. 241.



FIG. 242.



FIG. 243.

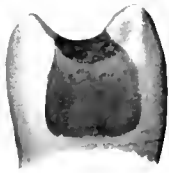

FIG. 244.



FIG. 245.

FIGS. 239, 240. Distal and mesial views of the first bicuspid, showing the decays. Examination reveals extensive exposure of the pulp, which must be removed.

FIG. 241. The prepared cavity. Notice that the enamel has been cut away just over the points of the cusps.

FIG. 242. The cavity filled. Notice that the filling material protects the entire occlusal surface so that the danger of the cusps being split off by the wedging of food between them is removed.

FIG. 243. The finished case as seen from the occlusal view.

FIG. 244. A view of the first bicuspid, as often filled, in mesio-occlusal-distal cavities after removal of the pulp, which gives the appearance of a much better tooth.

FIG. 245. This exhibits the usual result of a filling placed as shown in Figure 244, which, sooner or later, is pretty sure to occur from the wedging of food between the cusps.

must be removed. The attention will be directed only to the two bicuspid.

In Figure 234 the distal surface of the second bicuspid is shown displaying the opening through the enamel in which the undermined distal marginal ridge is not yet broken. In the mesial cavity, Figure 235, the mesial marginal ridge has broken. The undermined enamel is first chipped away from over the decayed areas with the chisels and enamel hatchets in the usual way. When this has been done, it is found that a portion of the dentin under the central groove is sound. This is cut through along the groove with bur 10 and widened by alternate undermining with the bur and chipping with the chisel until it is of sufficient width, forming a step connecting the two cavities, as shown in Figures 236, 237. For three reasons it is important to make this step as shallow as possible and still give sufficient stability to the fillings: (1.) The strength of the tooth must be conserved in the greatest possible degree. (2.) The greatest thickness of dentin possible should remain between the filling and the pulp. (3.) The recessional lines of the pulpal horns should not be cut. Therefore, the step is cut but little deeper than the thickness of the enamel at the central groove. For the distal cavity the burrowing of decay has caused rather excessive extension to the buccal, but neither proximal cavity approaches the pulp so closely as to place it in especial danger. It should always be remembered that when we place filling material on three sides of the pulp of a tooth at one time, it is in more than ordinary danger from thermal changes. Except for this, there is nothing in this case more dangerous than is often found in large cavities in either of these surfaces. The steps and the instrumentation are the same in every respect as have been described and illustrated. The completed filling, distal surface, is shown in Figure 238. It is one of the principal advantages of this system of filling teeth that the processes for each class of cavities are unified and brought into a definite plan that is abundantly flexible to cover the variations found; a plan which is employed for all of that class and is carried out with practically the same instruments for all cases. This enables an operator to work to a definite end in each different case presented. A higher degree of accuracy and better speed in operating are attained.

The first bicuspid, as represented in Figures 239, 240, is much more deeply decayed than the second. Decay is found to have extended entirely through the tooth mesio-distally so that

when the decay is uncovered by the removal of the undermined enamel, the cavity extends through from mesial to distal. When the pulp has been removed and the cavities trimmed to form, it is found that both the buccal and lingual portions remaining will be frail from the loss of tooth material. Therefore, the preparation must be on special lines in order to gain the greatest strength possible. The point of especial danger is in the breaking of the remaining parts of the cusps by the wedging of food between their central inclines in chewing. If we look at Figures 239, 240, and remember that the strong cusp of the lower first bicuspid strikes between the cusps of this tooth and that the crush of food material between these teeth tends to force these cusps apart and to break them, we will realize the danger. Therefore, when the facts are discovered, this tooth is separated well from both its neighbors to limit the cutting to the buccal and to the lingual as much as possible, the gingival walls are made flat to afford the best possible seat, or resistance form, the slopes of the cusps forming the sulcus are removed sufficiently for a strong stratum of filling material to be built over them, as shown in Figures 241, 242. Just so much of each cusp is removed and replaced with filling material as will catch the splitting stress that comes in the crushing of the food, placing it entirely upon the filling material, which is solid from buccal to lingual. This removes the splitting stress from the weakened cusps. The manner of doing this is clearly seen in the two Figures 241, 242, which explain this method of conserving the strength of the tooth much more perfectly than can be done in words. Figure 243 shows the completed case in occlusal view.

Many of these bicuspid with mesio-occluso-distal cavities have been filled with the preparation shown in Figure 244. This shows much more of the tooth retained, but leaves the central inclines of the cusps in position so that the wedging comes upon the cusps instead of the filling. Sooner or later a powerful splitting force is exerted between the inclines of these cusps and the inevitable result is depicted in Figure 245. In time, one or the other of the cusps is almost sure to be split off; sometimes it will be the buccal, as shown, and generally in almost the exact place and form shown, and sometimes it will be the lingual cusp. Therefore, whenever the pulp is removed, forming a complete separation of the cusps in case of both mesial and distal surfaces being cut through, whether the tooth is bicuspid or molar, all splitting stress between the cusps must be removed by cutting over the crest of the cusps sufficiently far to place all of the

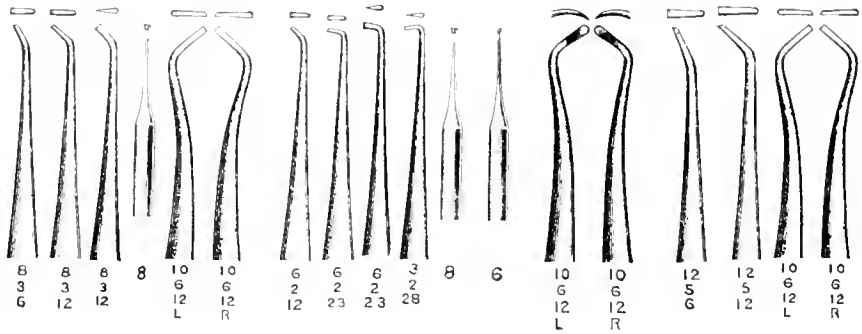

FIG. 246

FIG. 246. Instruments for the excavation of cavities of the third class. The hoe 8-3-6, hoe 8-3-12, hatchet 8-3-12, inverted cone bur 8, enamel hatchets 10-6-12 are for securing outline form; hoe 6-2-12, hoe 6-2-23, hatchet 6-2-23, hatchet 3-2-28, inverted cone bur 8 for retention form; inverted cone bur 6 for convenience form; spoons 10-6-12 for removal of remaining carious dentin; hoe 12-5-6, hoe 12-5-12, enamel hatchets 10-6-12 for finishing the enamel wall.

stress upon the filling material. In that case, except the lateral stress by the lateral motion of the lower jaw in chewing brittle foods, which is much less severe than the crushing stress, all of the heavy work in chewing will be simple up-and-down stress in its effect upon the tooth. This stress the tooth can bear without danger. The mesio-occluso-distal cavities that may be prepared with the pulps alive in the form shown in Figures 236, 237, are sufficiently strong, as has been shown by much clinical observation. Yet, in these, one should be careful not to make the step deeper than is required to make the filling material occupying it sufficiently strong to bind the proximal fillings safely together.

In addition to the special points mentioned, decay is liable to burrow in any direction, causing weak walls in other, and occasionally, in unusual positions. Any such are to be treated upon the general lines that have been indicated. It should be a rule that when a wall requires cutting away because it has been weakened by decay, and, in the cutting, a developmental groove is approached, it should be cut to or past the groove.

CLASS 3. CAVITIES IN THE PROXIMAL SURFACES OF THE INCISORS AND CUSPIDS, WHICH DO NOT REQUIRE THE REMOVAL AND RESTORATION OF THE INCISAL ANGLE.

ILLUSTRATIONS: FIGURES 246-271.

In the excavation of cavities of this class a much greater range of forms of cutting instruments may be used interchangeably and effectively than in other classes, and a greater variation of method of instrumentation is consistent with rapid and thorough operating. Therefore, much care should be exercised in forming habits of procedure that will limit the instruments used habitually to an efficient number that may be employed without confusion and delay. To these should be added a number of forms suited to special conditions or circumstances that effectively help over difficulties.

Cavity forms in incisor proximal surfaces differ from all others in that they are in surfaces of the teeth that are triangular in form and the cavities must take a similar form. Therefore, instead of the typical form being a modification of the square box as in the proximal surfaces of bicuspids and molars, the form is a triangular box, modified to suit the conditions found. In the group of illustrations of this class, Figure 252 represents the simplest typical form, while 257 represents the same form greatly extended. As these decays usually begin toward the

incisal edge, or about centrally between the gingival line and the incisal edge, where the tooth is narrow labio-lingually, the enamel of the proximo-labial and lingual angles of the tooth is very often undermined in such a way that it is necessary to cut these angles over onto the labial or lingual surfaces, as shown in Figure 249, which is cut to the lingual. This is better seen in the filling, Figure 250. Further cutting to both the labial and lingual is seen in Figure 262. In Figures 266 and 268, the cutting away of parts of both the labial and lingual surfaces show the extreme modification of the form of the prepared cavity. In these it will be noted that the principal modification is caused by more or less undermining of the enamel, requiring that portions of the lingual or the labial enamel plates, or of both, be removed in the preparation of the cavity. Otherwise than this, all the cavities of this class are, in fact, prepared on the same general lines.

In cavities of this class, the approach is through the embrasures from the labial or from the lingual in all of the cavity preparation and in the introduction of filling material, which makes them again distinct from all other cavities in the manipulative sense. This may be appreciated by the examination of the completed fillings as seen from the labial in Figure 254 and Figure 264. This calls for smaller instruments in proportion to the size of the cavity and the work undertaken, than in the other classes of decays. On this account the manipulation in these cavities has a character distinctly different from all others.

The preparation for gold fillings will be here presented and afterward the preparation for porcelain inlays, which, in this class of cavities, is markedly different in form.

DESCRIPTION OF CASE 1. The left upper central incisor has a decay in its mesial surface, just to the gingival of the contact point. Figure 247. Apparently it is small, but a curved exploring instrument, introduced from the labial or from the lingual, enters through the enamel, showing a considerable burrowing of decay in the dentin.

PRELIMINARY PREPARATION. The first procedure is to free all of the incisor teeth of debris or microorganisms and gummy material, particularly about their gingival portion, and apply the rubber dam. Dry the teeth, apply the Perry separator and get sufficient separation to pass a thin polishing tape between the teeth. In the single-rooted teeth, especial care must be taken, in using the separator, that too much pressure is not used. When these teeth seem hard to move, time should be given for the spring of the instrument to carry the teeth apart sufficiently,



FIG. 247.



FIG. 248.



FIG. 249.



FIG. 250.

Figs. 247-250. A series illustrating a common cavity form in the mesial surface of a central incisor.

FIG. 247. The mesial surface of a central incisor showing the apparent decayed area. Examination of the lateral extension shows considerable undermining of enamel, and especially that the mesio-lingual marginal ridge is undermined.

FIG. 248. A cavity preparation with rounded gingival wall. This should never be used.

FIG. 249. The correct preparation with the gingival wall horizontal and with the labio-gingival and the linguo-gingival angles widely extended. Other parts of the cavity are cut no broader. Notice that the mesio-lingual angle of the tooth is cut away in both.

FIG. 250. The cavity has been filled and finished. This shows the extension of the lingual portion better than the cavity illustration.

otherwise too much separation may be made. During this time the opening of the cavity may proceed.

OUTLINE FORM. With hoe 8-3-6, used as a chisel, begin near the labial margin of the cavity to break down the overhanging enamel, chipping from the surface into the cavity. This should generally be done by hand pressure, being careful to place the edge of the cutting instrument very near the margin of the break in the enamel in each instance and split it off in little flakes. The third finger should be very securely rested upon the adjacent teeth and the motion of the instrument so closely controlled that its edge will not be thrust into the depths of the cavity and cause pain. Continue this cutting until the enamel is found supported by sound dentin, or until the cavity of decay is well exposed. On account of the prominent position of these teeth and the esthetic demands, it will be best, when decay is extensive, to leave on the labial portion of the margin some enamel unsupported by dentin, especially when it is of about full strength, rather than expose so much filling material to view, as the complete removal of the undermined enamel would do. How much of this may be left becomes a matter of judgment in each case. The enamel of the labial surfaces of the incisors is usually thick and strong and is not exposed to the direct occlusion. It will, therefore, stand better than in other positions. But enamel that has been thinned and weakened by backward decay should be cut away, even at the expense of marring the esthetic appearance of the tooth. One should be especially careful not to leave remaining enamel that is so transparent as to show the gold through it as a discoloration. This latter is worse from the esthetic point than cutting boldly over onto the labial surface. When this wall has been chipped away sufficiently, chip away the lingual wall in the same way and with hoe 8-3-12, working from the lingual. If the cavity is small, take hatchet 8-3-12 and introduce the blade between the teeth from the labial, with the edge directed to the gingival, catch the enamel near the cavity margin and chip it away by a prying motion, using the proximating tooth as a fulcrum, removing as much enamel in this way toward the gingival as practicable. This movement must be used with care. If carelessly done, it is likely to be very painful. Only the thinner portions of weakened enamel margins should be removed by this motion; but now, with this undermined gingival enamel out of the way, a stronger instrument may be used. Generally, hatchet 12-5-6 or chisel 10 may be introduced against the labial enamel wall, with the edge directed toward the gingival, and the enamel wall

trimmed away smoothly farther toward the gingival, using strong hand pressure, and, by changing the direction, the cutting can be continued along the gingival wall to or past the labio-lingual center of the tooth. With the same instruments working from the lingual, the lingual wall is next cut down in the same way to, and somewhat past, the linguo-gingival angle of the cavity. For trimming the remainder of the gingival wall, hoe 12-5-6 will be required, or the 8-3-6 if the cavity is not opened sufficiently to admit the larger instrument. This is done with a scraping motion. Frequently hatchet 12-5-12 will do this well, working from the labial. The gingival wall should be cut to sound dentin and made as nearly flat in the horizontal plane as practicable. This is likely, however, to produce a form of cavity much like that shown in Figure 248, in which the gingival wall is curved with its convexity toward the gingival and the labio-gingival angle much rounded. In case the enamel of the mesio-lingual angle of the tooth is not undermined, as shown by its having been cut away in this case, it will be similarly rounded.

Examine carefully as to the requirements of extension for prevention. In cases in which the cavity is yet small, a line of very superficial injury to the enamel will often be found running away labio-gingivally from the labio-gingival angle of the cavity near the gum line. Another line of superficial injury leads away in similar fashion from the linguo-gingival angle. Often, also, particularly in the smaller cavities, there is superficial enamel injury to the gingival of the gingival wall. But whether these injuries are apparent in the individual case or not, the cavity must now be extended so that it will include the areas of these superficial injuries frequently apparent. To do this, place a small inverted cone bur 8 in the labio-gingival angle, introducing it from the lingual in most cavities; enter the dentin close to the enamel junction, and, swaying the hand-piece as much as the position will allow, undermine the enamel in the direction of the line of superficial injury toward the labial and gingival, sinking it at first about the depth of the bur head. Then very slowly withdraw the bur, pressing it toward the labial and incisal, thus widening the cut in this direction. The bur should be kept close against the dento-enamel junction in making this cut. With the hoe 12-5-6 or 8-3-6, the undermined enamel may be chipped away. These cuttings, first undermining and then chipping, may be repeated until the extension in this particular direction seems sufficient. If it is desirable to extend the cavity to the gingival, which should generally be done, the same bur may

be introduced as before, and drawn toward the lingual with pressure against the gingival wall, cutting the dentin close against the dento-enamel junction, and the undermined enamel chipped away with the hoes or hatchets, working from the labial. In many cases, particularly where the loss of the enamel plate has been considerable toward the labial, all of this cutting with the bur can be better done from the labial, keeping the shaft of the instrument as nearly as possible in line with the long axis of the tooth. The linguo-gingival angle should be extended with the same bur introduced from the labial and its end entered into the dentin at the dento-enamel junction in the direction to undermine the portion of enamel most subject to superficial beginnings of decay. In this position the first cut should generally be made as near to the lingual enamel plate as is desirable to cut the cavity, and the bur should be drawn back with pressure toward the gingival, extending the undermining in that direction. It is also generally desirable to again introduce the bur, and, while drawing it toward the labial, make pressure against the undermined enamel so as to weaken it. It may then be broken away with hoe 8-3-12 or 8-3-6, catching the edge of the instrument on the surface and using a pulling motion, throwing the chips into the cavity, or it may be cut away by using a scraping motion from labial to lingual with hoe 12-5-12, or with hatchets 12-5-12 or 8-3-12. In many cases, the pair of enamel hatchets 10-6-12 will be found very convenient for trimming the gingival wall and the labio-gingival and linguo-gingival angles, one of these instruments being used from the lingual direction, the other from the labial. If still more extension to the gingival is required, it is readily done by passing the square end of the bur along the gingival wall, cutting out the dentin close against the dento-enamel junction and afterward removing the enamel. In excavating and extending cavities in the proximal surfaces of the incisors and cuspids, it should be noted particularly that these surfaces are wedge-shaped or triangular, with the base of the triangle forming the gingival margin, and that the finished cavity should have that form, with its labio-gingival and linguo-gingival angles widely extended toward the angles of the surface decayed. In undermining the enamel with the bur in making extensions, care should be taken to keep the bur head against the inner surface of the enamel, and generally in the incisors the size 8 of the inverted cone bur should be used. It is an object to keep this cutting very shallow in the first instance and deepen it later if that is required. The gingival wall should be perfectly

flat mesio-distally, with the axio-gingival line angle sharp. Labiolingually it should be either straight and parallel with the horizontal plane of the tooth, or curved with its convexity to the incisal, somewhat as shown in Figure 257.

The incisal angle should next receive attention. It often happens that decay has extended along the dento-enamel junction considerably in this direction. The enamel should be chipped away with hoe S-3-6 until sound dentin has been fully reached, and in doing this very careful attention should be given to the direction of cleavage with reference to the final inclination of the finished enamel wall. This should complete the outline form as in Figure 249.

RESISTANCE FORM. Special resistance form beyond the retention form is not required in these cavities.

RETENTION FORM. When the outline form has been attained, the incisal angle should be undercut for retention. Usually this should be done before looking specially to the retention in other parts of the cavity, for the strength required of these will depend much upon the strength which may be possible in the incisal retention. The incisal retention is made by undercutting to the incisal in the form of a groove. The incisal angle is first well rounded and the dentin cut away to some depth from the dento-enamel junction directly at right angles to the axial surface of the tooth, with hoes S-3-12 and S-3-23, or equivalent hatchets, using angle 23 mostly, close against the labial wall. Then hatchet 5-3-28, or, if that blade is too long, 3-2-28, is used for cutting a groove in the incisal angle, and extending it along the labio-axial line angle. The instrument should be introduced from the labial, its edge directed to the incisal, and, beginning at the labio-axial line angle a little removed from the incisal angle, its edge should be carried toward the incisal and lingual around the angle, in part by a twist of the instrument. It is then placed well to the lingual and swept in the opposite direction, or toward the labial, all the time cutting close against or slightly into the axial wall. This cut should be fully within the dentin, leaving some dentin between it and the dento-enamel junction. One should not depend on the strength of the enamel in this position. This groove is shown in section in a distal cavity in Figure 255. The motions are repeated until the groove is of sufficient depth. It is an excellent plan to test the depth and retention form of this groove by placing in it the right angle hand-pressure plugger point, which is to be used in packing the gold in the groove. A bur should never be used to cut the incisal retention in these



FIG. 251.



FIG. 252.



FIG. 253.



FIG. 255.



FIG. 254.



FIG. 256.



FIG. 257.

FIGS. 251-257. A series illustrating the minimum and maximum cavity extension in incisor proximal cavities.

FIG. 251. The distal surface of a central incisor with a decay in which the enamel rods have just begun to fall away. There is practically no burrowing of decay in the dentin, though some softening has occurred. No matter what the extension demanded to prevent recurrence of decay, no part of this cavity needs to be cut deeper than may be required for safe anchorage.

FIG. 252. The cavity preparation, exhibiting a minimum extension, and the outline form that should generally be used.

FIG. 253. The finished filling.

FIG. 254. The finished filling as seen from the labial.

FIG. 255. Mesio-distal section of the tooth and the filling, showing the depth of cutting and the incisal anchorage.

FIG. 256. A cross section of the tooth and the filling close to the gingival wall, showing the retention in the gingival portion.

FIG. 257. A cavity preparation showing extreme extension. Practically the extension for prevention in incisor cavities should always be kept between this and that shown in Figure 252. Its amount should depend upon the conditions demanding extension in each particular case. A filling made after the cavity preparation in Figure 257 would be seen from the labial very little more than that in Figure 254.

cavities, on account of the difficulty of access and the danger of undermining the enamel.

With the 8-3-23 hoe, or, if the cavity is small, the 6-2-23, introduced from the labial and with its edge turned to the labial or the axial wall, the axio-labial line angle is made sharp and definite along the length of it well to the gingival, using a scraping motion from the gingival toward the incisal. Often the 6-2-23 hatchet will do this as well, using it with a back-and-forth scraping motion, holding the shaft of the instrument at right angles to the long axis of the tooth. The axio-lingual line angle is now made definite throughout its length, using hoe 6-2-23 near the incisal angle and hoe 8-3-12 or 6-2-12 for the remainder. This should be completed to, and into, the axio-linguo-gingival angle. Undercutting at the axio-linguo-gingival angle for retention will depend upon the strength of the incisal anchorage; if this be good, but slight retentive form — just sufficient to serve in starting the filling — is all that is needed in the gingival position. The axio-labio-gingival angle, which has been left sufficiently definite by the bur, is now slightly grooved for a short distance toward the incisal, completing the retentive form by squaring out with the hoe 6-2-12 or hatchet 6-2-23.

CONVENIENCE FORM. Convenience points should be cut in the labio-axio-gingival and linguo-axio-gingival angles, in the same way and in the same form as described for bicuspid and molar proximal cavities, using an inverted cone bur 6 or 8. Figures 170-173, inclusive, and in cross section, Figure 256.

REMOVAL OF REMAINING CARIOUS DENTIN. Any decay now remaining in the deeper parts of the central portion of the cavity is removed with spoons 10-6-12. If the cavity is large, spoons 15-8-12 may sometimes be better.

FINISH OF ENAMEL WALL. The enamel walls are planed smooth in every part and any errors in inclination corrected. If the operator has noted carefully the direction of the cleavage of the enamel at all points while chipping it away, he will be at no loss in determining the correct inclination of the enamel walls at the different points, remembering that this shall follow closely the cleavage lines. This is done with hoes 12-5-6 and 12-5-12, or with the chisels, except some portions of the gingival enamel wall and a short reach upon the lingual wall where it joins the incisal angle. The movement of the instrument should be along the length of the enamel wall, cutting very lightly. It must be very sharp to be effective. At the labio-gingival and linguo-gingival angles, the outline should form short curves, no matter

how sharp the angles of the dentin walls; sometimes it is difficult to plane the whole length of the gingival wall smoothly with a hoe or chisel, especially where it joins the curve at the linguogingival angle. Here enamel hatchets 10-6-12 may be used, one from the labial direction, the other from the lingual, or hatchet 12-5-6 or 12-5-12. These instruments will also smooth the lingual portion of the curve at the incisal angle in many cases. At the incisal angle, the inclination of the enamel wall must generally be strongly toward the incisal, especially in distal cavities, in order to follow the length of the enamel rods. When the trimming is done, note carefully whether the retentive form has been injured at any important point by trimming too deeply, and make such corrections as may be required.

Bevel the cavo-surface angle in all parts of the enamel margin, using the same instruments as were used in planing the enamel walls. The toilet of the cavity should then be made.

The foregoing description is to be taken as the general type of the instrumentation and the formation of cavities in proximal surfaces of the incisors. It must be understood, however, that other instruments than those set apart for this work in the illustration given in Figure 246 may often be conveniently used and that many variations in the detail of cavity forms may be substituted or become actually necessary. Some of these will be given in the additional series of illustrations which follow. In cutting the incisal retention it will often be well to cut the axial wall deeper, sloping it deeper into the tooth for a space toward the incisal in order to place the incisal anchorage deeper in the dentin than that shown in Figure 255.

DESCRIPTION OF CASE 2. In Figure 251, the distal surface of a central incisor is shown with an almost round whitened area of caries of enamel, the incisal margin of which is slightly to the gingival of the contact point. In the central part of this, the enamel rods are beginning to fall away. If every cavity of decay could be discovered and filled at this stage, before more serious injury is done to the dentin, it would be much better for the teeth. After placing the rubber dam, separating and drying the teeth, hoe excavator 6-2-6 is forced in near the center of the decayed area and the dentin is found considerably softened. A few strokes easily remove the greater part of the decayed area; and the decay along the dento-enamel junction is found to be already greater in extent than the decay on the surface of the enamel. Hoe 8-3-6 is substituted for the smaller one and the enamel chipped away until it is found supported by perfectly sound den-

tin, when, of course, it refuses to split away through its thickness. The outline of the prepared cavity should by this time be quite fully determined. With inverted cone bur 6 or 8, the enamel is undermined, first to the lingual and gingival and chipped away; then the bur is introduced from the lingual and the enamel to the labial undermined and chipped away, and this continues until the outline form shown in Figure 252 has been attained. The decay in the dentin, though as broad as has been mentioned, is not more than a millimeter deep at any point, and that depth, with the addition of the thickness of the enamel, should be the greatest depth given the cavity at any point. Every part should be kept very shallow, except, perhaps, in some cases, more depth might be wanted at the incisal anchorage and the convenience points. The widely spreading form given to the angles in the gingival portion of the cavity is the essential point in extension for prevention; for it is especially at these angles that caries has so often recurred and destroyed otherwise good fillings. When this form has been attained and the incisal anchorage and the convenience points have been cut, the enamel walls should be finished and the cavo-surface angle beveled as previously described. The toilet is then made, all in the same manner substantially as described in connection with the first series of illustrations of cavity preparation.

This cavity is intended to represent the minimum of extension for prevention in incisal cavities. The outline form is that which will most generally do the best service in protecting the tooth. The filling is shown in Figure 253, and the appearance in labial view in Figure 254. So small a cavity should be made only after close study of the probable coming of practical immunity to caries at an early date. In the opposite condition of extreme susceptibility to caries, the cavity should be enlarged, the gum septum pressed away and the cavity cut to the outline shown in Figure 257. This cavity should be cut no deeper than the first, except to deepen it just a little along the labial and lingual walls to obtain better ledges to lodge the filling against in building.

The forms of the convenience points are shown in Figure 256 in cross section of the tooth, with the filling, cut close to the gingival wall. The form of the incisal anchorage is shown in Figure 255 in mesio-distal section. The slope of the enamel wall to the incisal at the summit of the curve at the incisal angle is also made apparent. It must be specifically understood that the gingival wall is left flat labio-lingually in all cases, or if

curved, the convexity is to the incisal as shown in Figure 257. There should be no pits and no grooves whatever in the gingival wall. The convenience points are not cut into the gingival wall, but into the labial and lingual walls. The cavity, Figure 252, will be used to illustrate filling with gold in incisor proximal cavities.

RECURRENCE OF DECAY. The recurrence of decay so often seen at the linguo-gingival and labio-gingival angles of well-made fillings is shown in the whitened enamel and penetration beside the filling in Figure 258. It is very exactly this recurrence of decay that the form of cavity prepared under the rules of extension for prevention is made to cover. The labio-lingual breadth is spread out toward the gingival. Otherwise the cavity is not essentially broader than had been made before. This recurrence of decay is a rebeginning on the perfect surface of the enamel and is entirely different from that shown in Figure 259, which is a rebeginning of decay from leakage. The filling was imperfect. That may, and does, occur occasionally with the best possible cavity preparation. If the recurrence of decay is not observed in its incipiency, one will be unable, in most cases, to tell with certainty the nature of the fault which has caused it, except as the form of the filling may show that it had not been sufficiently extended. This is clearly shown in the photograph, Figure 260.

DESCRIPTION OF CASE 3. In the series of illustrations, Figures 261-264, the cavity of decay in the distal surface of a lateral incisor, Figure 261, is much more extensive than those illustrated before. In this, one may do the first chipping of enamel in opening the cavity with hoe 12-5-6 used as a chisel; later the 15, or even the 20 chisel, may be used and the weakened enamel rapidly trimmed away. The lingual surface is found considerably undermined, so that much of the disto-lingual angle of the tooth must be removed, as shown in Figure 262. The labial wall of the cavity must also be cut farther onto the labial surface than is necessary for extension for prevention. But even in this, some extension into sound tissue is necessary at the labio-gingival angle. The outline form of the cavity may be roughly completed ready for the finishing of the walls by this cutting before the rubber dam and separator have been placed, since separation is not necessary to the excavation. The decay is so extensive that there is serious danger of exposure of the pulp of the tooth, and the rubber dam must be placed and the tooth cleaned and dried and made sufficiently retentive, before the



FIG. 258.



FIG. 259.



FIG. 260.

FIGS. 258, 259, 260. Series illustrating recurrence of decay.

FIG. 258. In this case microorganisms have grown upon the filling and extended beyond its borders, causing recurrence of decay at the gingivo labial and gingivo lingual margins of the filling. These beginnings of decay ought to have been prevented by extensions in the cavity preparation.

FIG. 259. In this case there is recurrence of decay from leakage at the margin of the filling from a fault, either in the cavity preparation or the placing of the filling. Both of these causes of recurrence of decay are frequent. Which may have caused the difficulty can not always be told after more considerable decay has occurred.

FIG. 260. A photograph of a bicuspid in which there has been recurrence of decay after filling a cavity. When so much decay, as is shown in this, has occurred, the special marks showing the cause of the recurrence have been obliterated. Some judgment may be had from the form of the filling and the conditions presented, but this is not very reliable. For exactness of judgment as to cause, these cases must be examined very early.

remaining decay is removed, to receive a substantial temporary filling, if treatment of the pulp should become necessary. To this end the incisal anchorage should be roughly cut. The separator, as the rule, should not be placed in such a case until it is known whether or not the filling may be made at once. The remaining decay should be removed with the broadest spoon that will work well in the cavity in order that the blade may not suddenly drop into the pulp chamber and inflict unnecessary pain. When the decay has been removed, it is found that the pulp is not exposed. With care in the manipulation and caution as to shocks from thermal changes by the patient, it will be reasonably safe. A quill or a thin layer of cement may be laid over the axial wall of the cavity and the filling built against it. This will materially reduce the shock from thermal changes.

When the points mentioned above have been determined, the separator should be placed to make room for the building and the finishing of the filling. The retention form may then be completed. The incisal retention is good and strong. Only slight convenience points are necessary in the linguo-axio-gingival and labio-axio-gingival angles. The gingival wall has been cut horizontal mesio-distally. Ledges are cut along the labial wall and the lingual wall against which to build the filling, more as a convenience in packing gold than for retentive form, though these assist materially in giving resistance to movement or displacement. With this preparation, the walls may be completed and the cavo-surface angle beveled and the cavity is ready for the toilet and the filling.

In using the quill as a non-conductor in such a case, a piece of suitable size is cut from a quill toothpick and placed against the axial wall after the filling has been started in the gingival portion. The piece of quill is held in position against the axial wall with the holding instrument, while the gold is built up over its edge sufficiently to retain it. The filling is then continued without further attention to the quill, which will stand between the gold and the dentin covering the pulp. Figure 263 shows the finished filling, and Figure 264 gives the appearance from the labial view.

DESCRIPTION OF CASE 4. In Figures 265-271, a series of illustrations represent a very badly decayed mesial surface of a central incisor and its treatment. Usually one should begin the excavation in such a case, trusting to what may be developed during the progress of the work to guide him in its completion. The first thing to be done is such cutting of the frail enamel mar-

gins as will determine the outline form and the strength of the remaining parts of the tooth, strength of anchorages and the probable esthetic effect of such filling as may be placed. After this has been done and the rubber dam placed, the remaining decay is removed. In this case, the pulp is found not actually exposed, but exposure seems dangerously near. The spreading of decay along the dento-enamel junction has been excessive, as occasionally happens in cavities that are so wide open that fluids wash freely in and out; and decay of the dentin in the central portion is checked or even stopped. But where the decay is sheltered under the overhanging enamel margins, its progress continues. In such cases, the pulp of the tooth seems often to be less sensitive than normal though alive and apparently well; it seems to have become accustomed to the conditions. It will be a matter of judgment in any such case as to whether the pulp should be removed or retained. Figure 266 exhibits a form of preparation made with the retention of the pulp in view. It is found that, in order to obtain sufficient stability, or retention form for so large a filling, in which the cutting of the lingual wall will subject it to considerable stress from the lower teeth, it is necessary to cut around the pulp to the labial and to the lingual in the gingival portion of the cavity, as shown in cross section in Figure 267. While a very strong filling may be had in this way, and will succeed in well chosen cases, it is rather a dangerous expedient. In such a case occurring in a person seventeen years old or younger, the pulp of the tooth should be kept alive for several years longer by means of temporary expedients, such as filling with white gutta-percha, cement or other equally non-conducting material. A careful watch should be kept to see that the pulp does not die unawares and alveolar abscess occur. In case death of the pulp seems imminent, it should be removed. Figures 270, 271, exhibit the filling in place.

In case the patient is older, and it is decided to remove the pulp, the preparation shown in Figure 268 should be employed. The outline of the filling will not be changed. But the pulp chamber may be used as a safe, firm anchorage. The manner of cutting this is shown in Figure 269. When the pulp has been devitalized or anesthetized by cocaine and pressure, and before the pulp is removed, a small fissure bur, about 10, is placed in the pulp chamber and this cut away toward the mesial, as shown in Figure 269. It is preferable to use for this purpose a fissure bur with a smooth rounded end, in order that the opposite side of the pulp chamber (the distal side in this case) may not be



Fig. 261.



Fig. 262.



Fig. 263.

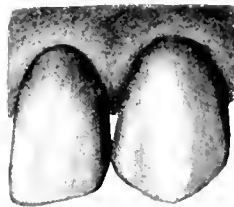

Fig. 264.

Figs. 261-264. A series of illustrations of cavity preparation in case of greater burrowing of decay in the dentin.

Fig. 261. The distal surface of a lateral incisor with a deep decay.

Fig. 262. The form of the cavity preparation. In this case considerable undermined enamel is retained on the labial surface, but the cavity is cut around on the lingual surface so as to remove much more of the lingual enamel plate.

Fig. 263. The finished filling.

Fig. 264. The labial view.



Fig. 265.



Fig. 266.



Fig. 267.



Fig. 269.



Fig. 268.



Fig. 270.



Fig. 271.

Figs. 265-271. A series representing extensive caries in the mesial surface of an incisor tooth and its treatment.

Fig. 265. An incisor tooth with extensive decay in the mesial surface showing a wide-open cavity. It happens sometimes that when the enamel has broken so as to open the cavity very wide early, that the rapidity of penetration has been checked while the decay has continued to extend along the dento-enamel junction, making extensive undermining before exposure of the pulp occurs.

Fig. 266. A preparation of the cavity retaining as much enamel as practicable on the labial surface and cutting around the pulp to prevent its exposure.

Fig. 267. A cross section of the prepared cavity close to the gingival wall, showing the plan of obtaining anchorage.

Fig. 268. The cavity as prepared after removal of the pulp.

Fig. 269. The cutting of the pulp canal in order to obtain the straightest path for the branch in removing the pulp from the canal and filling the root.

Fig. 270. The completed filling after either mode of preparation.

Fig. 271. The filling from the labial after either mode of preparation.

injured. When this cut is made before the removal of the pulp from the canal, the pulp prevents the clogging of the smaller parts with cuttings from the bur. This cutting is made to straighten the path for the broach in the removal of the deeper parts of the pulp from the canal and facilitates the filling of the canal. The canal should be filled with gutta-percha only to the beginning of the widened canal. When the tooth is ready for a gold filling, the whole of this internal portion may be solidly filled with cohesive gold. This will give an anchorage that may be depended upon to support the overhanging incisal angle and give it strength.

In case the incisal angle should be regarded as too weak to stand, it may be cut away. A strong irido-platinum post may be set in against the mesial wall of the cut made in widening the pulp chamber, cut to the right length and made tight by driving gold in about it. The first of this gold should be non-cohesive. But when the post has been made fast with this, cohesive gold should be used. In this way an angle may be built that will be sufficiently strong without a step in the incisal portion of the tooth.

GENERAL OBSERVATIONS ON THE PREPARATION OF PROXIMAL CAVITIES IN THE INCISORS AND CUSPIDS. In all cases the enamel margins should be cut sufficiently around the curves of the surface toward the labial and lingual, that the margin will be well away from the contact of the two teeth when the filling has been finished. This does not mean that the cavity wall must be cut over onto the labial surface so as to be especially conspicuous. But it should be cut out into the embrasure where the surface at the angle of the tooth begins to round away from close proximity to the surface of the proximating tooth, so that the margin of the filling may be kept clean. This should be carried fully to, or under, the free border of the gum and then curved sharply to form the gingival wall. The gingival wall must be placed far enough to the gingival to make this possible and should be convex in the incisal direction or arched from labial to lingual, if necessary, as shown in Figure 257. At the gingival, the margin should be well covered by the gum septum when this is in its normal position. The gum septum should be carefully preserved from injury in all parts of the operation, for upon the health of this tissue depends largely the health and good appearance of the tooth. The habit of tying ligatures on the incisor teeth and forcing them strongly to the gingival, can not be too strongly condemned. In doing so, the soft tissues are cut away from their

attachment to the tooth on the mesial and distal sides of the root, and often permanent injury is inflicted, which results in a loss of the normal fullness of the gum septum, and is sometimes the cause of serious disease of the peridental membrane. Toward the incisal, the cutting should always include the normal contact point in distal cavities. In mesial surfaces the contact point is sometimes so near the incisal angle that this is impracticable. In these cases, unless strictly required by the extension of decay, the original contact point of the enamel should not be removed, but a new contact should be made by a slight fullness of the filling a little to the gingival of the position of the original contact, as shown in Figures 254, 264, so that the incisal enamel margin will be held a little apart from contact with the proximating tooth. A very little space at this point is sufficient, for, in the use of the teeth, the excursions of food constantly clean that portion to the incisal of the contact, including the margin of the filling.

In medium and large cavities in which the enamel forming the labio-mesial or labio-distal angle of the tooth is already broken, or is weakened by backward decay, it is best to cut the labial wall well over onto the labial surface of the tooth, for the reason that, if cut only to the mesio-labial or disto-labial angle, the light will not reflect from the surface of the filling to the observer, and it will appear as a dark cavity. A little farther extension to the labial relieves this and gives the appearance of a filling. A little careful observation of this point will prevent mistakes that are often very annoying to sensitive patients. The appearance of sharp angles in cavity outlines that are exposed to view should be avoided. Slightly curved lines are better from the esthetic standpoint than straight lines. But the key to good appearance of operations on the incisors is perfect tooth form, including particularly the full mesio-distal breadth of the tooth. In the incisors, and especially in the laterals, the labial embrasure is usually well rounded out and open, because of the rounded form of the labio-mesial and labio-distal angles of these teeth. Upon the lingual, the embrasures are very shallow and close, because of the acuteness of the linguo-mesial and linguo-distal angles of the teeth, and the flatness or concavity of the lingual surfaces from mesial to distal. For this reason, the proximal cavities in these teeth often begin well toward the lingual and burrow much more under the enamel of the linguo-mesial or lingual-distal angles than toward the labial. The result is that the enamel to the lingual is often undermined and very

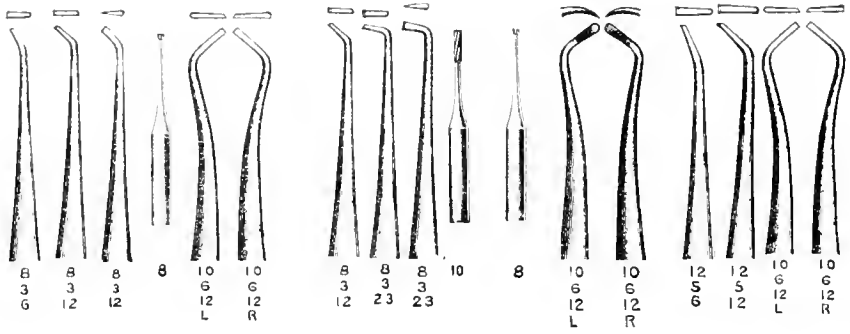

FIG. 272

FIG. 272. Instruments for the preparation of cavities of the fourth class. The hoe 8-3-6, hoe 8-3-12, hatchet 8-3-12, inverted cone bar 8, enameled hatchets 10-6-12 are for securing outline form; the hoe 8-3-12, hoe 8-3-23, hatchet 8-3-23, fish-tail bar 10 for resistance and retention form; inverted cone bar 8 for convenience form; spoons 10-6-12 for removal of remaining carious dentin; hoe 12-5-6, hoe 12-5-12, enamel hatchets 10-6-12 for finishing the enamel wall.

thin from injury to the inner half of its thickness from backward decay, or decay of its inner surface. Also the linguo-proximal marginal ridges are often quite sharp and the course of the enamel rods uncertain, so that a good margin can not certainly be made upon the sharp curves of these ridges. Therefore, when the enamel margin of the cavity must be laid against the enamel of the lingual marginal ridge, it is best to cut away the marginal ridge and lay the enamel margin of the cavity on the lingual surface of the tooth. In such cases, the lingual enamel wall will be cut parallel with the axial wall of the cavity, or in the labio-lingual plane of the tooth. Frequently this enamel wall will be level with the axial wall of the cavity, and this renders the placing of the filling more than ordinarily difficult. When the amount of tissue will allow, it is well to sink the lingual portion of the axial dentin wall sufficiently to obtain a slight ledge at the lingual. This is readily done with a few strokes of the 6-2-12 hoe for the gingival third, and with the 6-2-23 hoe for the incisal two-thirds of the lingual wall, introducing these instruments from the labial.

CLASS 4. CAVITIES IN THE PROXIMAL SURFACES OF THE INCISORS WHICH REQUIRE THE REMOVAL AND RESTORATION OF THE INCISAL ANGLE.

ILLUSTRATIONS: FIGURES 272-280.

Cases in which the angle of an incisor tooth has been lost, or has become so weakened by decay that it can not be retained safely, present considerable differences of condition. Many plans have from time to time been proposed for their mechanical repair, only a few of which can be recommended.

CONDITIONS THAT MAY PRESENT. (1.) The mesial surfaces of the central incisors may come together at a considerable angle and make contact very close to the incisal edge. Decay starting close to the gingival of this contact may involve the angle, causing it to break away while the decay is yet small, but not endangering the pulp of the tooth. (2.) The surfaces of the teeth may be in close proximation for a considerable distance from the incisal edge and the decay start farther to the gingival and yet be confined mostly to the incisal portion, or be very shallow, and still destroy the incisal angle without endangering the pulp of the tooth. (3.) Much of the mesial surface may be destroyed by decay before the angle breaks or is so weakened that it must be removed, and yet the decay may not seriously endanger the pulp. (4.) The pulp may be involved and its removal required.

In distal surfaces nearly the same conditions will occur but will be found less frequently. In these the angle is more rounded in form and the contact point is farther from the incisal edge. For this reason the incisal angle is less frequently involved; indeed, is but rarely involved in cavities that are yet small. Otherwise than these points the conditions in distal surfaces will be similar to mesial surfaces and require similar treatment. This applies to the mesial and distal surfaces of the lateral incisors in all respects, except that these are smaller teeth, which increases the difficulty of treatment in cases in which an incisal angle must be restored.

The plans of repair in these several conditions will differ with the amount of substance lost, and the opportunities offered for anchorage in the remaining parts of the tooth. In each of these the position of the pulp in relation to the incisal edge, whether it is near to or far from it, becomes important. The pulp extends farther toward the incisal edge, and is larger in young people than in older persons. In teeth with very thin incisal edges, the pulp extends proportionally nearer the incisal edge than in thick teeth, and especially it extends nearer the incisal edge of the dentin, leaving less room for anchorage in the dentin between the pulp and the incisal enamel. The longer and thinner labio-lingually the crown, the shorter proportionally the distance from the incisal edge of the pulp to the incisal edge of the dentin. The two central incisors may often be shortened by grinding the incisal edge in imitation of normal wear without material injury to their appearance. By such grinding, the remaining edge is left thicker so that a thicker and stronger angle of filing material may be built. All of these points must be considered in planning for the building of broken angles. Quite a large majority of these occur on mesial angles, seemingly because the contact point is usually nearer the incisal edge on mesial surfaces, and therefore decay begins nearer the incisal edge.

GENERAL STATEMENT OF CHOICE OF PLANS. (1.) When there is room for anchorage in the dentin between the pulp and the incisal edge without danger to the pulp, the plan of undercutting the incisal edge may be chosen. This has the merit of disfiguring the tooth less than the incisal step plan (compare Figures 275 and 278) and, in case the pulp is exposed, the cutting is in line for its removal and the use of the pulp chamber for anchorage. (2.) When there is not room to make sufficient anchorage by undercutting the incisal edge, an incisal step should be made



FIG. 273.



FIG. 274.



FIG. 275.

FIGS. 273, 274, 275. The method of restoring the incisal angle by undercutting the mesial edge.

FIG. 273. Cavity in the mesial surface of an incisor which has undermined the mesial angle of the tooth.

FIG. 274. Method of preparation by undercutting the incisal edge. A plan that may occasionally be used.

FIG. 275. The filling as it appears from the labial view.

by overcutting the incisal edge, Figure 278. (3.) When neither of the above plans can be used, the pulp must be destroyed and removed and the pulp chamber used for anchorage. If the pulp is found to be involved, the same course would be pursued. The preparation of this anchorage is shown in Figure 269.

ANCHORAGE BY UNDERCUTTING INCISAL EDGE. Figures 273, 274, 275, represent the plan of anchorage by undercutting the incisal edge. In Figure 273 a large mesial cavity in the incisor has approached the incisal edge so closely that a portion of the angle is too frail to remain, and the labial plate of the angle must be cut away as shown in Figure 275 (showing the finished filling), before enamel sufficiently strong to remain is found. More or less cutting of the lingual plate of enamel is not important in the esthetic sense. In any such case, the cavity should be cut well to the gingival, as shown in Figure 274, whether the tooth is decayed far in this direction or not. This must be done in order to obtain the broad spreading angles at the gingival portion of the cavity to assist in the anchorage and to give stability. In doing this, however, it is not necessary to cut away any portion of the labial enamel plate that is of sufficient strength. The incisal edge should be deeply undercut, as shown, sloping the cut into the tooth from the axial wall as far gingivally as practicable, or as far as safety to the pulp will allow. Anchorage in this undercut is the main dependence against tipping stress, which tends to turn the filling out of the cavity. Much additional stability can be had when moderately deep grooves can be cut along the labial and lingual walls of the proximal portion of the cavity into the dentin on either side of the pulp. The grooves must not be so deep as to endanger the strength of these walls. Finally, in finishing the walls, the lingual enamel plate near the incisal edge should be cut away more than the labial, and a notch, or zigzag, formed in the line crossing the incisal edge, as shown in Figure 274. In use the incisal edges of the teeth wear considerably, and, especially in cases in which the incisal enamel has worn away and the dentin is exposed, the wear of the tooth will be greater than the wear of the filling. This causes the filling to project beyond the incisal edge of the tooth, exposing it to unusual stress, tending to force it out of the cavity. The zigzag of the margin crossing the incisal edge gives a thin layer of gold to the lingual which protects the tooth substance to the labial, and as these two must wear down together, the wear is in the form of a slope. On account of the more rapid wear of the tooth edge, fillings made in this way

should have close attention and the filling should be dressed down level occasionally; in some cases as frequently as once or twice a year. This is the one weak point in this plan which becomes a menace to the durability of fillings restoring the lost angle. In the final finish of the walls of such a cavity, the most scrupulous attention should be given to the parts about the incisal edge to see that no short ends of enamel rods are left, and that all is smoothly cut out to a definite angle. The loss of a single enamel rod about the incisal edge is the signal of final failure of the filling.

ANCHORAGE BY FORMING A STEP IN THE INCISAL EDGE, OR OVER-cutting, is used in cases in which it is judged that there is not sufficient room to form an anchorage of sufficient strength by undercutting the incisal edge. The plan is illustrated in Figures 276, 277, 278.

In this class of cases, the proximal cavity is prepared, with the exception of its incisal angle, in the same way and with the same instruments as have been described for simple proximal cavities in these teeth, except that the anchorages in the labio-gingival and linguo-gingival angles are made deeper and stronger. That is, the axial wall is cut deeper into the dentin in the gingival portion to the lingual and to the labial of the pulp than in its central area, much the same as is shown in Figure 277, and in cross section in Figure 267.

The weak incisal angle is cut away to the labial groove, mesial or distal, as the cavity is to the mesial or distal. This groove, although not very apparent, is a weak line in the enamel at which it most often breaks, and it should always be included when the angle is so weak as to require removal. This is more necessary in connection with the preparation of an incisal step, which tends to weaken the support of the labial enamel plate. When this has been done, cut away the incisal edge of the middle lobe of the tooth, i. e., to the next labial groove, mesial or distal, with a stone in the engine, or with a small flat jeweler's file, cutting more from the lingual than the labial. The depth of this cutting should depend upon the thickness of the cutting edge of the tooth. If the cutting edge be thick and already somewhat worn, very slight cutting is sufficient. If unworn and thin, the cutting should be greater. In the average case, about one millimeter should be cut from the labial plate of enamel. In many cases this and neighboring teeth may be cut shorter and the edges thus made thicker.

A groove is then cut in the incisal edge of the tooth across



FIG. 276.



FIG. 277.



FIG. 278.



FIG. 279.



FIG. 280.

Figs. 276-280. A series of illustrations showing the method of restoring the angle of the tooth by overcutting the incisal edge, or the incisal step plan.

FIG. 276. An incisor tooth in which a decay of the mesial surface has undermined the incisal angle.

FIG. 277. The method of preparation, using the incisal step.

FIG. 278. The appearance of the tooth and finished filling as seen from the labial.

Figs. 279, 280. The lamination of gold in the building of the filling, by which the angle is given the greatest strength. In Figure 279, the diagonal lines at the gingival portion show the building of the filling against the axial and gingival walls until the gingival wall has been covered. Then the horizontal lines show the leveling up after the gingival wall has been covered. The circular lines in Figure 280 show the method of raising the central area and building continuously over from labial to lingual and from lingual to labial so as to give the immediate angle the greatest possible strength.

its middle lobe between the labial and lingual enamel plates, or as far as the edge has been shortened, as shown in Figure 277. For this purpose, the inverted cone bur 8 in the engine is best. With its shaft held parallel with the long axis of the tooth, the side of the bur is made to enter the dentin between the enamel plates a little way from the incisal edge of the tooth and drawn to the incisal edge and out. This movement is repeated in cut after cut until a groove is cut to the desired length.

In this cutting with the bur, the labial enamel plate should be left complete and the cutting done at the expense of the lingual enamel plate. After the first cut is completed, forming a groove, in which the bur should always reach fully into the dentin between the labial and lingual plates, the lingual plate should be cut away to very nearly or quite the depth of the cut by the bur. Then the bur should again be passed along the slight groove left, cutting it deeper, keeping close to the lingual rather than the labial enamel plate, forming a groove in the dentin between the enamel plates. In making this groove, it is an object to leave as much dentin as possible supporting the labial enamel plate. The depth of the cutting toward the pulp of the tooth must be guided by the judgment of the operator, care being taken not to expose the pulp. But in these cases, it is always better to expose and remove the pulp than to place a filling with an anchorage that is manifestly insufficient. The groove is the principal dependence for the incisal anchorage. This should be squared out with fissure bur 10 and its walls made parallel. No undercuts or pits are needed. Its depth below the lingual enamel margin should be fully as great as its breadth, or slightly more, but much greater depth is not desirable. A filling well condensed in a groove of this size will never slip or slide out, and if there is thickness enough of gold added over it to give the necessary strength, it will stand. A little broadening and rounding away where this step joins the proximal portion of the cavity will make the connection stronger. In the incisal enamel walls formed in making this incisal step, both labial and lingual, the enamel rods incline toward the incisal, and these walls should take that form rather than be cut at right angles with the long axis of the tooth. The cavo-surface angle must be slightly beveled in order to give it greater strength. The appearance after the filling has been made is shown in Figure 278.

Teeth with thin cutting edges are very difficult of management in making incisal steps for the restoration of a lost angle, or any other form of angle restoration, because the gold built

on them is too thin to have sufficient strength to prevent it being battered out of form. In many of these cases, the incisal edges of all of the incisors, or only the centrals, as already suggested, may be ground away in imitation of normal wear, and the incisal edge thickened without injury to the appearance. In doing this, it is well to remember that in very thin teeth the horns of the pulps are likely to be long and slender, increasing the danger of exposing them in cutting the step.

In cases where there has been such wear of the incisal edges of the teeth that the dentin is exposed, the step should include all of the exposed dentin. Very little cutting from the lingual enamel plate will be needed, and generally none from the labial.

In the management of this class of cases, it should be remembered that in such large cavities, the bulk of gold in close proximity to the pulp is liable, through its conductivity of thermal changes, to set up irritation that will destroy its vitality. If there seems to be imminent danger of this, it is better to remove the pulp at once. It is also better to remove the pulp at once than to run serious risk of losing the filling from insufficient anchorage in the effort to save the pulp alive.

In all of these cases, esthetic practice calls loudly for porcelain inlays instead of gold fillings. There is no form of filling that mars the appearance of a tooth so much as the restoration of a lost angle with gold, unless, indeed, it is the restoration of both angles of the same tooth. The fact that the incisal margins of porcelain inlays in these positions will generally chip away and eventually result in the loss of the inlay, should cause the operator to consider such cases very carefully. While at present only a few well selected cases promise good results with porcelain, it seems generally best to restore these with the lightest shade of platinum gold.

In all such restorations, it should be distinctly remembered that the good appearance of the tooth depends most directly upon the modeling of the tooth form. This is even more important than the color. Such a tooth restored with gold, giving perfect tooth form, will be better from the esthetic standpoint than a restoration with porcelain of satisfactory color but unsatisfactory in form.

ANCHORAGE IN THE PULP CHAMBER. Preparation of anchorage for restoration of the lost angle with gold after removal of the pulp of the tooth, should be on entirely different lines. The weakened angle should be cut away to the first labial groove as before, but no step should be cut along the incisal edge of the

tooth, and there should be no undercutting of the incisal edge as described above. Instead of this, the pulp chamber should be widely opened toward the incisal fully to the point of its horns, or, in most cases, extended farther to the incisal, and the cutting finished so that the incisal wall is at right angles to the long axis of the tooth, and the root canal opened for a space, as shown in Figure 269. Indeed, this figure would give very nearly a correct impression of the preparation if the incisal angle retained in that case was cut away. A little more extension of the cutting of the pulp chamber toward the incisal would be better. Generally the dentin should be cut away well to the lingual so as to give good access to this portion of the cavity for packing gold into this angle, and this should be made the retention to sustain the angle built on. The anchorage at the gingival should be cut similarly to that described for the preparation with the pulp alive, with the additional retention in the pulp chamber. This gives a more secure anchorage than either the undercutting of the incisal edge or the incisal step, and a better appearance than the incisal step.

In these cases the more rapid wear of the tooth than of the gold filling gives a similar liability to excessive stress on the filling, tending to force it out, as described in cases of anchorage by undercutting the incisal edge; and the occasional trimming down of the filling should have similar attention.

Some cases will be found in which the extension of decay in the dentin has been so great as to render even this anchorage insecure, and yet, it may seem desirable to make a restoration with gold. This may still be made secure by placing a strong irido-platinum post in the root canal for additional strength of anchorage. The preparation of the root canal should be similar to that illustrated in Figure 269, but the slope of the widened portion of the wall toward the mesial (or distal) should be such as will bring the end of the post that will project into the finished filling in the most favorable position. The cut into the canal may also be deeper. The post should be cut and fitted to this slope of the pulp canal as made in this preparation, seeing to it carefully that there is sufficient room by the side of it for the insertion of gold forcing the post solidly against the wall prepared for it. It is well in preparing the wall, or bed, for the post in the dentin, to use a fissure bur as near the exact size of the post as possible. When it has been fitted to its position, choose a slender plugger that will easily pass to the end of the post. While holding the post securely with a second instrument

placed on its end, introduce pellets or small rolls of non-cohesive gold and drive them solidly about the post, binding it against the bed prepared for it. Note particularly that the gold built in this way is on one side of the post only, the other side resting on the dentin. When just a little gold has been securely wedged in in this way, the post will be held so firmly that the holding instrument may be laid aside and the building in of gold continued without it. The building in of non-cohesive gold should be continued until a point is reached when cohesive gold can be used without danger that it may clog the space without being perfectly packed. Then the filling proper should be made of cohesive gold.

The setting of such posts with cement should not be considered, for the reason that it is too uncertain. Much malleting of gold around the post must be done in building the filling, and often the hold of the cement on the post will be loosened and the post become insecure. Careful trials of results show that by filling against a post in this way with gold, nothing less than actual breakage of the tooth, or the post itself, can move it. As between using posts in roots to secure artificial crowns when they are pushed into the cement and simply allowed to remain, and setting the post and afterward doing much malleting upon and about its protruding end, there is a wide range of difference in effectiveness and safety that should not be overlooked.

In all of this class of cases the building of gold in the full view of every observer has properly been much limited by the improvements made in recent years in placing artificial crowns and porcelain inlays. Still, the restorations with gold, if very well done, are the more reliable. This plan should still be used in many cases in which the esthetic demands are not so great as to prohibit them, because they afford a means of greatly prolonging the usefulness of the teeth so treated. After the gold filling breaks away, if it ever should, the opportunity to place an artificial crown will be as good as before. If five or ten years' longer use of the tooth can be secured by this means, it ought to be done.

Only a portion of this class of cases are, or ever can be, suitable for porcelain inlay restorations, for the reason that some change in the color of the remaining parts of the tooth is quite certain to occur. Then the esthetic effect of the porcelain inlay will be very much worse than the gold restorations. In a few well chosen cases in which the operator himself has made a clean removal of the pulp and never at any time allowed saliva or

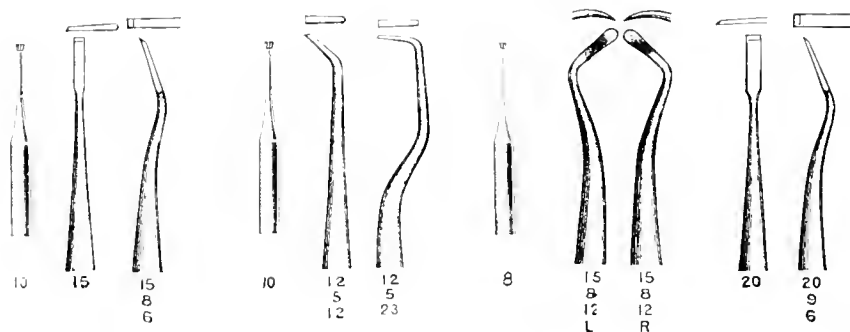

FIG. 281.

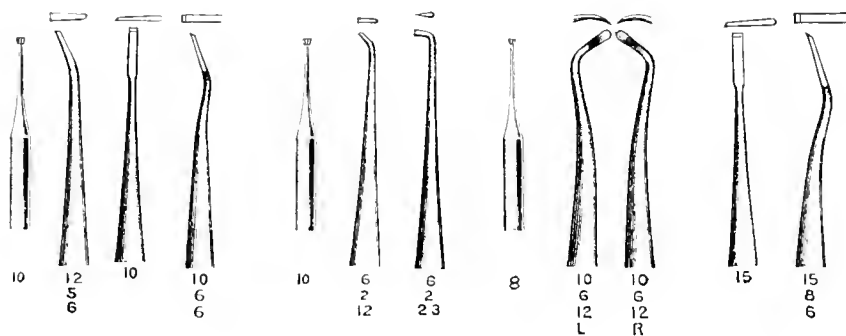

FIG. 282.

FIG. 281. Instruments for excavating gingival third buccal cavities. The inverted cone bur 10, straight chisel 15, binangle chisel 15-8-6 are for securing outline form; the inverted cone bur 10, hoe 12-5-12, hatchet 12-5-23 for retention form; inverted cone bur 8 for convenience form; the spoons 15-8-12 for removal of remaining carious dentin; the straight chisel 20, binangle chisel 20-9-6 for finishing the enamel wall.

FIG. 282. Instruments for excavating labial cavities. The inverted cone bur 10, straight chisel 10, binangle chisel 10-6-6 are for securing outline form; the inverted cone bur 10, hoe 6-2-12, hatchet 6-2-23 for retention form; inverted cone bur 8 for convenience form; spoons 10-6-12 for removal of remaining carious dentin; straight chisel 15, binangle chisel 15-8-6 for finishing the enamel wall.

other undesirable substance to enter, the tooth may retain its color sufficiently for a porcelain restoration. This, however, requires the utmost care in every detail.

CLASS 5. CAVITIES IN THE GINGIVAL THIRD — NOT PIT CAVITIES
— IN THE BUCCAL, LABIAL OR LINGUAL SURFACES
OF THE TEETH.

ILLUSTRATIONS: FIGURES 281-292.

Of these, the smooth surface cavities of the lingual surfaces of the teeth are so infrequent that mention of them seems to be all that is necessary. The differences in position call for some differences in instrumentation between these and similar cavities of the buccal and labial surfaces. While the principles of their preparation are the same, the lingual surfaces are awkwardly situated for the use of instruments and often call for differences in the particular instruments employed.

The cavities of the classes treated thus far have had their beginning in out-of-the-way places, hidden in pits or between the proximal surfaces of the teeth. Those of the fifth class are very different. These cavities are all on surfaces that are freely exposed to view and when clean are without natural covering of any kind. They begin in the enamel, close to the line of the free margin of the gum. Hence the term "gingival third cavities." All are inclined to spread on the surface of the enamel in directions along the gum margin either way from the starting point. In cases of the greatest susceptibility to caries, these are inclined to form a band of decay encircling the tooth along the gum margin by joining smooth surface decays of the proximal surfaces at the angles of the teeth. In the ordinary cases seen in practice, the tendency to spread is in the same directions, but not quite to the angles of the teeth. This fact forms the real key to the extensions necessary for the prevention of further spread of decay in all of the smooth surface cavities; the proximal as well as gingival third cavities. With this fact well fixed in the mind and finally confirmed by careful observation, one should not go wrong in the extension of cavities of this class for the prevention of further spreading of caries on any surface. Therefore, in the treatment of gingival third cavities, all principal extensions must be in a direction along the free border of the gum. In some cases extensions of lesser degree may be required in other directions, but these will not be considerable.

The gingival third cavities are much inclined to occur in

groups, cavity after cavity occurring in close succession or in numbers together in some particular part of the mouth as in the molars, the bicuspid or the incisors. They do not occur, however, in the teeth of as many persons as either of the other classes. Therefore, on the whole, these cavities are much less often met with than the proximal or the pit cavities.

In the past, this class of cavities has been the terror of practitioners on account of the rapid destruction of the teeth and the very constant disposition to recur at the mesial and distal margins of fillings which seemed good and sufficient at the time they were made. Yet, there is no other class of cavities so easy of management when the whole scheme of their causation is clear in the mind of the operator and he is able to command the intelligent assistance of his patient. These cavities are on surfaces of the teeth most easily reached and cleaned with the tooth brush. Any one noticing in good time an inclination to beginning decay in any of these positions, may stop its progress completely in all cases in which the enamel has not been penetrated, and prevent other decays of this class from beginning by cleaning the teeth well four times per day — after each meal and before retiring — with the brush and water.

BUCCAL SURFACES OF MOLARS.

DESCRIPTION OF CASE 1. Figure 283 represents the buccal surface of an upper first molar with a beginning decay in its gingival third. This is a typical representation of the conditions of the enamel at this stage, as it will appear if the rubber dam is placed and the tooth is cleaned and dried. At three points centrally to the line of injury from mesial to distal, the enamel rods are loosening and falling away. The surrounding enamel is of a whitish gray color, fading out at the margins into the normal color of the teeth. This change of color is often so faint that it will escape observation unless the tooth is cleaned and dried and the condition is especially looked for.

In many cases the line of whitening of the enamel is much narrower than the one represented in this illustration. This may be found stretching a similar distance mesio-distally before there is any sign of the falling away of enamel rods forming a cavity. Sometimes these are very white and easily seen before the teeth are cleaned and dried, and are spoken of as “chalky” enamel or chalky decay. In other cases there is a central cavity through the enamel before there is much spreading of the whitened area. These cavities are apt to be very sensitive in the first

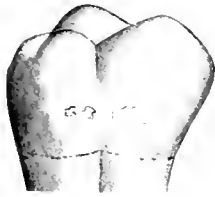

FIG. 283.

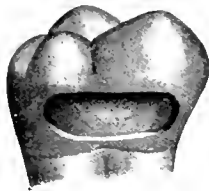

FIG. 284



FIG. 285.

FIG. 283. An upper first molar with a decay in the gingival third of the buccal surface that has penetrated the enamel at several points but has not burrowed much in the dentin.

FIG. 284. The cavity preparation, showing the extension toward the mesial and distal angles of the tooth usually necessary.

FIG. 285. The finished filling.

beginning of the excavation, particularly when this is done early, or before there has been considerable decay in the dentin.

OUTLINE FORM. In such a case as that represented in Figure 283, the first cutting may be done with chisel 15, spoon 15-8-12 or with bur 10. The hand instruments will usually do the work with less pain than the bur. Choose a position so that by one or two vigorous strokes the softened material may all be scraped out with either the chisel or the spoon, for in this case there is no undermined enamel and no chipping of overhanging enamel in opening the cavity. The first strokes will generally be the most painful part of the excavation, and the patient should expect pain and be prepared for it. If these first strokes are well and vigorously made, practically all of the softened material of the central part of decay should be removed. Inverted cone bur 10, new and the blades sharp, should be placed with its end to the axial wall of the cavity and quickly passed around its periphery, cutting only a little into the dentin, for the cavity should be kept shallow. Often it will be necessary to do this with several cuts instead of one. After these cuts, the sensitiveness will generally be much less. As there is no undermining of the enamel as yet by decay, this must be done by the bur. In first molars, and in all of the teeth in front of them, where the end of the bur can always be held perpendicular to the axial wall of the cavity, the necessary extension can easily be made by undermining the enamel with the side of the bur and chipping away the undermined portion with chisel 15. The extension should, in this case, include all of the whitened area and a little more, especially toward the mesial and the distal, and the extension to the gingival should place that margin under the free margin of the gum, as in Figure 284.

In the treatment of all gingival third and proximal cavities, it is an established fact that no decay begins, and that there is no recurrence of decay in any part of the tooth covered by a healthy free border of the gum. Therefore, in all of these cases this free border of the gum should be pressed away and the gingival wall so cut that its margin will be covered by it when it returns to its normal position. Another point of importance, frequently mentioned before, is, that in children the free border of the gum is long, covering a more or less considerable part of the enamel. As the person grows older, this free border of the gum becomes shorter, exposing more of the crown of the tooth. This calls for especial care in the treatment of this class of cavities in children and young people generally, to so place

the gingival wall of the cavity that it will be deeply covered by the free border of the gum when finished. As the general rule, only very slight extensions to the occlusal or incisal are required. The rubber dam should now be placed.

RESISTANCE FORM. No resistance form is necessary in cavities of this class.

RETENTION FORM. Retention form in such a cavity requires that the axial wall be flat and the four surrounding walls at right angles to the axial wall, the opposing walls parallel to each other, with a very slight undercut in the dentin entirely around the axial wall. This undercut should not be greater than that made by the flare of the blade of an inverted cone bur held with its flat end against the axial wall. The retention form may be made with inverted cone bur 10, or with hoe 12-5-12 or 12-5-23, or smaller sizes of the same angles, and increase the retention along both the occlusal and gingival walls, using these instruments with a scraping motion. This cutting should not be deep so as to undermine and weaken the walls, but just enough to hold when gold is packed against them. In some cases it may be more convenient to use the equivalent hatchets with the shaft perpendicular to the axial wall, with a lateral scraping motion.

CONVENIENCE FORM. Sometimes it is well to place slight convenience points in the axio-disto-gingival and axio-disto-occlusal angles in which to start the filling.

REMOVAL OF REMAINING CARIOUS DENTIN. If there should be any remaining decay in the axial wall, it should be removed with spoons 15-8-12.

FINISH OF ENAMEL WALL. The enamel wall should be planed and the cavo-surface angle lightly beveled in all parts with chisels 20. Make the toilet and fill the cavity. Figure 284 represents the prepared cavity, and Figure 285 the completed filling.

The extension to the mesial and to the distal as given above, is correct for the conditions presented in the illustrations. But an otherwise similar case in which the whitening of the enamel was practically confined to a spot in the mesio-distal center of this area at the time of operating, the extension should reach just as far toward the angles of the tooth as represented in this case. Many of these cavities in which the spread of superficial decay on the enamel is slower, will have penetrated the enamel before the spreading has reached its full extent. If the central part is cut out and filled without extension, the growth of micro-organisms will recur on the filling, and, the support of the new



FIG. 286.



FIG. 287.

FIG. 286. The upper bicuspids and first and second molars, showing buccal gingival third decays. In the second molar the decay has burrowed considerably in the dentin.

FIG. 287. The same teeth after treatment, showing the extension and the outline form of the prepared cavities. Notice that each cavity is extended gingivally so that the margin of the filling is under the free margin of the gum.

nidus of the growth being on indestructible material, it will spread beyond the filling to the mesial, or to the distal, or both, and reëstablish this chalky decay of the enamel. Nothing less than extension to the angle of the tooth in either direction can be depended upon, and nothing less should be considered sufficient. It has been the failure to realize this fact and bring it down to an everyday working basis that has made the treatment of this class of cases seem so difficult in the past.

DESCRIPTION OF CASE 2. Figures 286, 287, present what would generally be considered a very bad case of so-called "chalky" decay in the gingival thirds of the buccal surfaces of the bicuspids and molars. The number of cavities occurring together, the extreme sensitiveness, and the visions of recurrence of decay in the past, are appalling to many operators. But in this case the individual cavities in the first molar and the bicuspids present no essential differences from the foregoing case. Each of them should be treated in a similar manner. The second molar, however, has been badly neglected. It shows what will happen in these cases if they do not receive prompt attention. After the central part of the area of enamel has fallen away, forming a cavity, the spread of the decay superficially on the enamel is generally checked. The decay is established in the dentin, however, and will spread along the dento-enamel junction in every direction, the same as in decays occurring elsewhere. This will undermine the enamel toward the gingival and toward the occlusal far beyond the superficial decay of the enamel. The enamel so undermined is rapidly destroyed by backward decay and falls away, enlarging the cavity. Soon the free margin of the gum falls into this extension at the gingival, complicating the case. Often this portion of gum tissue will be inflamed and swollen from the injury inflicted by the ragged cavity margins.

The procedure in this must be different. After careful examination, it is believed that the pulp will not be exposed in excavating, but at present that is not a very essential point. The examination of the overlapping gum tissue shows that all of the gingival enamel has been destroyed and that the gingival wall of the cavity must be laid on the cementum. This is always a misfortune. The gum will lose its normal attachment at the gingival line, and the attachments rootwise of that line are never so good, nor is the gum so healthful afterward; though with careful treatment it may do fairly well.

PRELIMINARY PREPARATION. One of three things may be done.

(1.) If the gum may be readily held away from the tooth for a

little distance with a flat burnisher so that one of the special clamps, Figure 90, can be placed to the gingival of the decayed area, the preparation of the cavity may be made at once. In any such case, the special clamp should be put on before the rubber is placed, in order to have nothing in the way of placing the clamp just right. Then the rubber may be thrown over it. (2.) The cavity may be roughly excavated without the rubber dam and filled with a sufficient ball of softened base plate gutta-percha, to hold the gum away and cause its absorption within a few days. (3.) The overlapping gum may be cut away at once, and the operation proceed. Those who have learned to handle the actual cautery well may do this best with a white-hot bur-nisher. A fairly quick stroke of a white-hot instrument is practically painless and no bleeding follows it. An instrument at a dull red heat burns fearfully and should never be used.

When this preparation is done and the clamp so placed as to expose the gingival wall and surface of the tooth beyond the cavity, the principal difficulty is ended. The undermined enamel may be chipped away as far as desirable and the extensions made, completing the outline form as shown in Figure 287. The extension to the mesial and to the distal can each be made with the bur, and chipping with the chisel, the operator generally standing in the left side in front position with the patient's face turned away to the right. Sometimes it will be more convenient to make the extension distally with the end of the bur against the distal wall, the operator standing on the right side behind or the left side in front for the upper teeth of the left side, and on the right side in front for the upper teeth of the right side. With these instruments and these positions, such cavities are not very difficult of preparation. Usually in large cavities, the sensitiveness is much less than in the beginning decays shown in the first molar and bicuspid of the same figure. The detail of the outline form, except for the enlargements occluso-gingivally, and of the retention form, is completed, as has been indicated for other cavities of this class. Parallel occlusal and gingival walls or some slight undercutting give sufficient retention form. The finishing is done in the same manner as in other cavities. The toilet finally renders the cavity fit for the filling.

VARIATIONS. The forms of the cavities in the first molar and bicuspid in this case are sufficiently shown in Figure 287. The instrumentation should be in no wise different from that given for the series of illustrations 283, 284, 285, and need not be repeated. The Hatch clamp should be used to hold the rubber

and gum away to expose the gingival wall in cavities in the bicuspids, and may occasionally be used on first molars.

In case of pulp exposure in buccal cavities, the cutting should be carried toward the occlusal something in the form of a V, with its apex pointing to the buccal groove, or even over onto the occlusal surface in some cases, to give opportunity for the use of the broach in the root canals. For this purpose it is sometimes better even to cut fully into the central fossa, or make a separate opening through the occlusal surface, especially in lower molars. Remember that the value of the tooth will, in this case, depend more on the treatment of the root canals and its results, than any other one thing. One should make such room as will give the best opportunity to do this well. Then he should repair the damage to the crown the best he can.

Gingival third decays in the upper third molars in cases of even moderately severe susceptibility are so difficult, and many patients will so persistently fail to keep them clean with the brush, that it is often best to extract the teeth at once. However, when for some reason it appears especially important that these teeth be retained, the effort should be made. Or, if the position of the tooth should be favorable and the disposition to this class of cavities is not considerable, they may often be filled without much difficulty and to the considerable advantage of the patient. Third molars in the lower jaw are less difficult of management and are much oftener very useful teeth for abutments for bridges when the first and second molars are lost, or so badly decayed that their loss is feared.

Figures 288, 289, represent buccal gingival third decays in the lower bicuspids and molars. The treatment of these and the necessary instrumentation are not essentially different from that which has been given for the upper bicuspids and molars. Some differences in position will be noted as to convenience in this work. These will readily suggest themselves.

In large buccal cavities, complicated by occlusal decay and extension of decay beyond the gingival line, still another plan may be successfully used without removing the gum tissue. First excavate the cavity to the roughly formed outline form, and fill with base plate gutta-percha. When this has become full hard, trim it to form with a very sharp finishing knife. Take a bit of stiff metal plate and by carefully bending, fit this to the gingival portion of the tooth over the cavity wall, separating the gum from the neck of the tooth, if necessary. To the mesial and to the distal, this matrix should be long enough to reach

into the embrasures and rest on the enamel beyond the cavity. It should cover only the gingival portion of the cavity and be strong enough to support the pressure of the rubber dam clamp. This is now warmed, the gutta-percha filling dried as well as possible, and the matrix settled to its place while warm enough to stick to the gutta-percha filling. A little gutta-percha may be smeared on the warm matrix to assist in the adhesion, if necessary. Leave this to cool a few moments and then place the rubber dam clamp with its buccal foot on this matrix. The rubber dam may now be thrown over the bow of the clamp and be made snug. This done, remove the gutta-percha from the cavity and proceed with the preparation. In case the matrix is found not to fit snug enough to exclude moisture along the gingival wall between the matrix and the tooth, the application of carbolic acid to this particular part will coagulate sufficient albumen to seal it if a little time is given.

In general, the excavation of buccal gingival third cavities is difficult mostly because of their persistent sensitiveness. This causes patients to give the operator trouble when he most needs their aid. The best results are obtained by going regularly on with the work without bothering with obtundants, but favoring the patient as much as possible by frequent rests. A vigorous and effective cut is usually no more painful than light scraping. Every instrument used should be fully sharp so that it will cut with the least pain. Every cut should be so planned that it will do just the work intended. In this way the number of cuts will be reduced to the fewest possible, and the excavation done quickly and with the least pain.

In those most distressing cases of intense susceptibility to this class of decays occurring in young women or young mothers, with much sensitiveness and suffering, it is worth while for the dentist to make more than the usual effort for their relief. The advice in such is that the decay be simply scooped out of the shallow cavities, that all undermined enamel be broken away and that no further attempt be immediately made to excavate them. The patient should be instructed in the use of the brush and tepid water. The brush should not be very stiff. The cavities should be well washed at least four or six times per day, using an abundance of water. The object is to dilute and wash away the acid being formed in the decayed area. Soda or other alkaline remedies should not be used, as they stimulate more rapid growth of microorganisms and rapid reacidulation. If this is well done and the cavities opened more widely as occasion will



FIG. 288.



FIG. 289.

FIG. 288. The lower bicuspids and first and second molars, showing gingival third decays in the buccal surfaces. Groups of cavities such as are shown are very liable to occur together, though they may occur singly or in smaller groups.

FIG. 289. The same case as the above after treatment, showing the outline form of the prepared cavities with the extension to the angles and below the free margins of the gums.

allow, within from two to four weeks these teeth may usually be filled without abnormal sensitiveness.

LABIAL SURFACES OF INCISORS AND CUSPIDS.

The treatment of decays in the gingival third of the labial surfaces of the incisors and cuspids is essentially the same as in the buccal surfaces of the molars and bicuspid. For the most part, the same instruments are used, and in the same way, except that the smaller sizes or the ordinaries are generally called for. In this work the Hatch clamp should be used to hold the rubber dam close down to the gingival line. No ligatures whatever should be tied around the tooth operated upon, for the reason that any effort to press the gum out of the way on the labial with a ligature that has been passed over the linguo-gingival ridge to make it hold against slipping toward the incisal, will certainly cut the gums away from the tooth on the mesial and distal where the gingival line arches from labial to lingual, and do great damage to the tissue and eventually to the teeth also. This has been more fully explained in Figures 84, 85, 86, and in the text relating to them. Further, there is no possible need of ligatures in any case when the Hatch clamp, or any other clamp is used, except such use as may be necessary to cause the rubber to pass close contacts. Ligatures may be tied on the teeth included in the rubber to either side when that seems necessary.

DESCRIPTION OF CASE 3. In Figure 290 a central incisor is represented with a beginning decay in the gingival third of the labial surface. In the central area of this, the enamel rods are beginning to fall away, forming a cavity. In this particular case, the cavity happens to be mostly to the mesial of the central line of the tooth. This occurs in a good many cases, but the greater number spread about as much to the distal as to the mesial. Their form in the beginning is that of a crescent following the free border of the gum. In neglected cases the decay will burrow along the dento-enamel junction, the enamel will be destroyed by backward decay and finally a rounded cavity will be formed.

OUTLINE FORM. In the case represented in Figure 290, the partially decayed enamel in the central area may be removed almost entirely by one or two sweeps of spoon 15-8-12, or it may be cut out with the chisels 10 or 15 with a gougelike motion. Undermining the enamel has not yet occurred and for this reason we can not begin by chipping of undermined enamel. An inverted

cone bur 10 is placed with its end perpendicular to the axial wall, and, by pressing the side of the bur toward the periphery of the cavity and cutting a little into the dentin, the cavity is enlarged in every direction so far as the injured enamel gives way easily. The enamel is undercut with the side of the bur and chipped away with the chisel until the proper extensions have been made, as shown in the prepared cavity, Figure 291. In such a case as this, if a filling had previously been made in the mesial surface of this tooth, this cavity would be extended to it and its margin made one of the margins of this cavity rather than leave just a little enamel between the two fillings. In any case, the extension to the mesial and to the distal should be ample, for the reason that it is in these directions that recurrence of decay is to be expected. The extension to the gingival should reach well under the free border of the gum, but to extend fully to the gingival line where the gum is ordinarily attached, or past it, should never be done, unless, indeed, decay extending in the dentin has already undermined the tissues in this direction. No considerable extension toward the incisal is needed because there is little or no disposition for decay to recur in that direction.

Cavities that are filled with gold should be kept as shallow as possible and still furnish walls against which a filling can be substantially lodged; and especially so in young people. In the use of porcelain inlays, which are better adapted to these cavities than to any other, and are especially indicated for esthetic reasons, the cavity must be cut as deep as safety to the pulp will permit, so that sufficient body of porcelain may be had to prevent breakage in handling. The treatment with gold is much the safer course when these occur in young people. Where demanded for esthetic reasons, porcelain may be substituted later.

RESISTANCE FORM. No resistance form is required in cavities of this class.

RETENTION FORM. When the outline has been satisfactorily completed and a gold filling is to be employed, the cavity must be made retentive. This may be satisfactorily accomplished in most cases with the inverted cone bur 8 or 10 by undercutting the gingival and incisal walls slightly with the side of the bur, or it may generally be done as easily with hoe 6-2-12 used with the scraping motion along these walls close against the axial walls. Only very slight undercutting is needed.

CONVENIENCE FORM. If the operator feels that he needs convenience points for starting a gold filling, these may be cut

with the inverted cone bur 8 by pushing its square end into the axio-mesio-gingival angle and drawing it a little way along the gingival wall. This may be repeated in the axio-mesio-incisal angle, if desired. Also similar starting points may be cut in the distal end of the cavity.

REMOVAL OF REMAINING CARIOUS DENTIN. In this case decay had not penetrated the dentin. In cases in which caries had penetrated the dentin, spoons 10-6-12 or 15-8-12 should be used to remove the affected area.

FINISH OF ENAMEL WALL. It remains to finish the enamel walls, make any corrections needed and bevel the cavo-surface angle at all points. This should be done with chisels 15, or hoe 12-5-6. The beveling is best done with the chisel, working along the length of the margin. Only a slight bevel is required. This should be made with a very sharp chisel held very lightly in the fingers and used with a planing motion. Make the toilet of the cavity. Figure 291 represents the prepared cavity; Figure 292, the finished filling. This is to be taken as a type of the preparation of labial cavities for gold fillings.

VARIATIONS from this in some degree will be necessary in cavities that have been neglected until considerable burrowing in the dentin has occurred. In such, of course, the preparation will begin with chipping away the overhanging enamel with the chisel. At the proper time, remaining decay must be removed with the spoons 15-8-12. Cavities will occur in which, on account of their near approach to the pulp, a marginal ledge should be cut as has been described for occlusal and proximo-occlusal cavities in the molars, in order to shield the pulp as much as possible. If a pulp must be destroyed on account of the burrowing of a neglected labial decay, it should generally be removed through the lingual surface so that the labial surface need not be disfigured by extending the labial cavity to the incisal to make room for approach by the broach. However, if the cavity has already extended much to the incisal and room has practically been made, there is no reason why the pulp should not be removed through it. This may be assisted greatly by cutting the pulp canal much to the labial in the gingival third of its length with a 10 fissure bur.

If there are cavities in one or both proximal surfaces of the tooth, these should be filled first with gold. If the proper extension of these brings them close to the labial cavity outline, the latter should be extended to meet the proximal fillings. In the use of porcelain in such a case, a very nice thing may be done

by filling the proximal cavities with gold and then so shaping the labial cavity, cutting into the gold fillings for the purpose, as to completely hide the gold with the porcelain. This plan is available in some cases in which the decay is so bad as to otherwise cause great disfiguration of the teeth and will give much better results than can be had by the use of porcelain alone.

LABIAL OR BUCCAL CAVITIES WITH RECESSION OF THE GUMS. This subject, so far as treatment with silver nitrate is available, has been presented in Volume I, in connection with Figures 168-171. When such cavities have attained a depth that requires a filling, or in cases where the black surface produced by the silver nitrate treatment is brought into view and can not be used for esthetic reasons, the porcelain inlay should generally be used. Where the recession of the gum is considerable, the porcelain may be given a gum color and will do much to hide the resulting deformity. In any case, the treatment is likely to be unsatisfactory for the reason that the receding gum will so frequently recede more and expose more of the surface of the root in which decay will recur. This will often occur whether the filling be gold or porcelain, yet, by preventing depth of penetration, much good may be accomplished in prolonging the usefulness of such teeth.

In the preparation for gold fillings, these do not differ so essentially from the ordinary cavities as to require special description.

SENILE DECAY OF THE TEETH.

By the term "senile decay" is usually meant that form of decay that occurs in the teeth of elderly people about the gum margins when these have become very short. The decay is apt to invade the cementum soon after its beginning and for this reason is unusually difficult to treat successfully by filling. Much of it that has come under the observation of the author has actually begun in the cementum after more or less recession of the gum. Sometimes this has been on the sides of the exposed root of the tooth. Some of these have been complicated by exposure of the pulp in the root canal. Such a thing occurring in a tooth otherwise useful in mastication, is particularly ugly to meet with in practice. Fortunately, they are not very frequent.

By the use of the term "senile decay," there is no intention of conveying the idea that this is something different in the pathological sense from other classes of caries of the teeth. It is only modified in form by the general conditions under which



FIG. 290.

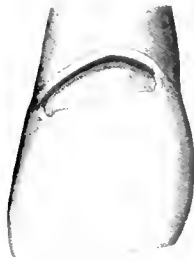

FIG. 291.



FIG. 292.

FIGS. 290, 291, 292. The treatment of labial decays in the incisors.

FIG. 290. A labial decay in which the enamel rods have fallen out over a part of the whitened area.

FIG. 291. The prepared cavity, showing the mesial and distal extensions and the extension very close to the gingival line.

FIG. 292. The same case after the filling has been finished.

it occurs. The term "senile" simply expresses a fact that this occurs under special conditions found in the mouths of old people. Generally it will be found that such persons have become negligent in their habits of cleanliness. The free margins of the gums have practically disappeared and lodgments of debris are plentiful about the necks of the teeth. Under these conditions a more or less active condition of susceptibility to caries has occurred and the decay resulting takes forms that are peculiar to the local conditions.

In the treatment of this class of cases, gutta-percha in the form known as "Hill's Stopping" has done excellent service as a filling material. Cements have not been of much value when a considerable number of cases have been considered together, though occasional cases have done well. Porcelain or metal inlays have not been sufficiently tried to determine their value. Gold fillings are impossible, except to the well trained manipulator who can so contrive to hold the rubber dam in place with an instrument in one hand, keeping the cavity dry while he makes the filling with the other. Even then, the best made filling is apt to be short-lived for the reason that a little more recession of the gum will allow decay to begin again rootwise of the filling.

Really no general rules of treatment can be recommended for this class of decays. Some of them can be well done in the ordinary methods of dealing with gingival third decays; some of them can not. In these latter, the skillful dentist will devise means as well suited to the case as possible, not expecting very satisfactory results in a considerable proportion of the cases.

INTERPROXIMAL WEAR AND ITS TREATMENT.

ILLUSTRATIONS: FIGURES 293-297.

In the use of the teeth in chewing food, cases occur in which the proximal surfaces become excessively worn by the rubbing of the teeth against each other. This rubbing is permitted by the slight motion of the teeth in their sockets. In this wear, the prominence of the proximal surface which forms the contact point is worn from each of some two, four or more teeth, and the flat surfaces come together, forming a flat contact. In some cases this contact remains very close and apparently no food particles are admitted between the teeth. In others, however, stringy material is forced between these surfaces and is held between the flattened areas, forcing the teeth apart a little, loosening the normal pressure of the contact. Then more food is

forced in and more separation occurs, so that at each meal-time the surfaces catch more food, which is forced onto the gum septum, causing its absorption. This soon forms a pocket between the teeth that is habitually filled with debris. Specimens of teeth with excessive wear of the proximal surfaces are shown in the photographs, Figures 293-297. The result is: (1.) In a considerable proportion of these, acid fermentation becomes established and it is sufficiently inclosed for the acid formed to produce caries of the enamel. Then a cavity is formed, usually very close to the gingival line, a position in which its proper treatment by filling is very difficult. (2.) In other cases, putrefactive or a similar decomposition occurs and continues. In this case there will be no decay of the tooth surfaces, but if the lodgment continues, the gum septum will be destroyed in its central area bucco-lingually. Often the alveolar process is either uncovered or the bone itself undergoes absorption, and disease of the periodontal membranes of one or both the teeth results. This will often become practically incurable without the loss of the teeth.

For these reasons, it is the duty of the dentist to look carefully for signs of interproximal wear, and to correct this condition in cases in which lodgments of food occur. With these cases should be included cases in which incorrect forms of contacts permit food lodgment. In some of these cases there is much complaint by the patient of pain in chewing food because of the pressure of the food upon the gums, which calls attention to the particular form of difficulty. No such complaint should be allowed to pass without serious attention. In other cases the patient is strangely oblivious to the difficulty and the damage being inflicted. These latter are often the worst forms seemingly, because there is little or no effort by the patient to keep the interproximal space clean. In this case it devolves upon the practitioner to find the difficulty and to correct it before irreparable damage is done.

The symptoms are: (1.) In most cases a little tumefaction or swollen condition of the festoons of the interproximal gum septum in the buccal or lingual embrasure or in both of these. (2.) In cases of longer standing, the absorption of the gum septum will have gone so far that the festoons are much shortened as compared with those in other embrasures. When these conditions are found, an accumulation of debris will probably also be found between the necks of the teeth. The finding of this completes the diagnosis. If (1) the contacts are found considerably flattened by wear, treatment by cutting a cavity and filling,

making a prominent contact in finishing, is demanded. If, however, (2) the contacts are found unworn and in fairly good form, it may be that the lodgment has been the result of accident which has strained the teeth apart and may be regarded as temporary. In that case, the space should be well cleaned and the patient instructed to be especially careful to keep the space free from lodgments. The case should be examined at frequent intervals to see that this is successful. Within a few weeks the fibers of the peridental membranes should recover their normal tone, and the teeth be held together with sufficient firmness to prevent lodgments from recurring. Where this fails after sufficient trial, a cavity should be cut and a prominent contact made. (3.) Often the examination will reveal the fact that the lodgment has occurred through the roughening of the proximal surfaces of the teeth by the beginning of caries of the enamel. This, of course, calls for fillings at once to prevent further damage of this nature.

If the form of the contact is at fault, either from (1) an abnormal form of the tooth surfaces, (2) malposition of the teeth, (3) abnormal wear of the contact points, treatment should be instituted for permanent relief. The best form of treatment in any one of these conditions is to separate the teeth sufficiently, cut a proximo-occlusal cavity and make a filling with a prominent contact, such as is shown in Figures 162, 163, or in Figure 220. In these cases interproximal wear will oftenest be the cause calling for this procedure. Generally, the cutting of a single cavity will be sufficient, unless, indeed, decay has actually begun in the proximal surfaces. These call for somewhat radical prominence of the contact point built on, for it will probably wear rapidly and become much reduced. In some cases it has seemed that the wear of the cusps has been such as to give an unusual sliding movement of the teeth upon each other in chewing food. It is well to look for this and, if discovered, correct it by a little grinding of the surfaces.

The cavity should generally include more surface than that already worn and have a good and sufficient step in the occlusal surface. There is no necessity for considerable depth; it should only be sufficient to insure stability. The whole filling should be especially well and substantially built and the contact so malleted as to make of it hard hammered gold in contra-distinction to solid annealed gold.

After the treatment, it is well, particularly if there has been much loss of interproximal gum tissue by absorption, to watch

the case for a few weeks to see that this grows up and fills the space. Often some stimulation of the tissues every two or three days by the application of stimulant remedies, such as oil of cloves, will aid in this regeneration of lost tissue.

Years ago, when the use of the separating file was common in finishing fillings, many dentists cut proximal surface fillings flat and made similar conditions to that formed by worn contacts. The separating file was a legacy, carried over from the use of that instrument in connection with non-cohesive gold filling operations before the discovery of the cohesive property of this metal; and, naturally, its use continued for a considerable time. Very many otherwise excellent fillings were lost by recurrence of decay to the gingival of fillings so made. There is yet some of this, and often dentists are careless about separating teeth and making the contacts of the proximal surfaces in correct form. When this is found and collections of food debris in the interproximal space occur, the only recourse is to remove the filling and make a new one in correct form. There is no operation done in dentistry of which patients, who have been worried in chewing food, express a higher degree of appreciation.

A caution should be expressed regarding a class of cases in which this treatment will fail. These are found when the arch has been broken by the loss of one or more teeth, leaving two or more of the molars without support against forward movement. It is well known that the constant tendency in such cases is to close the gap formed by the loss of teeth. The back teeth will move forward and to a lesser extent teeth to the mesial of the gap will move to the distal. This is often seen in the falling together of teeth that have lost their contacts by caries. This will always occur unless the teeth in the opposite jaw — the occluding teeth — have cusps in such form as to prevent the movement. Suppose the upper second bicuspid is lost; the upper first molar will move forward unless the cusps of the lower teeth so interlock with the cusps of the upper as to prevent it. This well observed fact of the tendency to movement and its method of natural prevention gives a strong hint that should be used in the treatment of some of these cases. Occasionally, this movement of the teeth after an extraction will change the relations of the proximal surfaces to each other and cause food to fill the interproximal space. Then the case should be studied with the view of so strengthening a certain cusp, or certain cusps, as to prevent the movement, or even to drive the tooth that has moved, slightly back to its normal position.



FIG. 293.



FIG. 294.



FIG. 295.



FIG. 296.



FIG. 297.

FIGS. 293-297. A series of photographs illustrating interproximal wear. These teeth were extracted because of the destruction of the peridental membranes by the crowding of food between the teeth as a result of the flattened contact points. Figures 296, 297, show the usual place of the beginning of decay when decay occurs from this cause.

In many cases, however, the occlusion of the teeth will be found to have been permanently impaired by such movement, and the building of prominent contacts that can not be maintained will be useless. Not very infrequently it has been found that the better treatment will be to widen the interproximal space enough to prevent lodgment of food. This is always a grave misfortune, as the power of mastication is permanently impaired.

ABRASION OF THE TEETH.

ILLUSTRATIONS: FIGURES 298-310.

By "abrasion" is meant such wear of the surfaces of the teeth as will occur by the normal processes of mastication. That this common statement of the case is incorrect, any one may become satisfied by the careful examination of some hundreds of individuals, from forty to sixty years old, and tabulating the condition of the teeth as to abrasion of their occlusal surfaces, and any other conditions discoverable that may be regarded as influencing it. After this has been done by a skillful observer, the verdict will certainly be that there is some unknown influence responsible for an abnormal amount of abrasion of the teeth of certain individuals. Yet, it is quite certain that the friction of mastication controls the form of the abraded surfaces of the teeth.

It seems unnecessary now to enter into a discussion of that which promises no good results, and that feature of the subject will be passed with the statement that there are great differences among persons as to the amount of wear of the teeth. Among the great majority of our people there is about a certain degree of abrasion of the teeth that is apparent in nearly all of the age of forty years or more. This is not considerable; and is insufficient to cause any disfiguration or to require any attention because of evil results. In a comparatively few individuals there is very much greater wear; so much that persons are occasionally seen, the crowns of whose teeth are worn to the level of the gums at the age of forty. A greater number will be met with, whose teeth are worn so much as to disfigure the mouth and the features also, by the closing of the lower jaw too far, interfering with the position of the lips and shortening the chin. Indeed, some persons appear almost as those who have lost their teeth, though there may be a considerable part of the crowns remaining.

In abrasions that progress rapidly, there are certain features which show that the use of the teeth in mastication has

much to do with the form of the worn surfaces. Usually in the beginning, whether the amount of the abrasion is eventually to be great or small, the cusps (or some certain cusps) are worn flat, and the developmental grooves, which were prominent features before, gradually disappear and the occlusal surface generally becomes flattened, as is seen in the molar tooth in Figure 298. When the abrasion has gone further, the dentin, under the prominence of some or all of the cusps, becomes exposed, as shown in Figures 299, 300. The dentin, being softer, wears more rapidly than the enamel, and cups out into rounded cavities of more or less considerable depth. The dentin becomes yellowish in cases that are rapidly wearing away. If the wear is slower, it becomes darker, and, in many cases, almost black. In the meantime, the remaining enamel retains its white color. If a section is made through one of these darkened areas, and this is photographed by reflected light, a cloud will appear stretching to the pulp chamber following the direction of the dentinal tubules. The pulp chamber is already undergoing changes. The horns of the pulp chamber have shortened and many of the cases show that secondary dentin is being deposited on all sides of the pulp chamber. With the greater abrasion shown in Figure 301, all of these changes will be markedly increased. Up to this time the patient is apt to have periods of sensitiveness of some of the abraded surfaces and more especially when a certain cusp first shows an exposure of the dentin. This sensitiveness comes and goes for a time and then is likely to disappear entirely and permanently. With the continuance of the abrasion, we will finally find the condition shown in Figure 302, in which the entire occlusal surface proper has disappeared. The enamel remains higher than the dentin. The dentin is cupped out in its center, sometimes very deeply, and in its center the form of the pulp chamber shows as a lighter area. The bulb of the pulp has become completely calcified. A section of this calcified area will show that true dentin was formed for a time after the pulp chamber began to diminish in size. After this had continued for a space, more or less of the dentinal tubules disappear, and in a little space farther all have disappeared, and the rest of the mass is a clear calcification showing none of the histological forms of dentin. In some cases the calcification will be incomplete; one side, angle or other part not having closed. This latter is more often seen in the incisors.

Figure 303 shows a badly worn lateral incisor, split mesio-distally, and photographed by reflected light. It will be seen



FIG. 298.



FIG. 299.



FIG. 300.



FIG. 301.

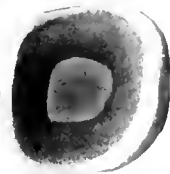

FIG. 302.

FIGS. 298-302. A series of illustrations of abrasion.

FIGS. 298, 299, 301 and 302 show progressive abrasion of a molar tooth which has worn until the calcification filling the pulp chamber is exposed.

FIG. 300. The bicuspid and first molar, the cusps of which are worn through the enamel and the dentin is cupped out.



FIG. 303.



FIG. 304.

FIG. 303. A central incisor that has been badly worn. The pulp is all calcified except a mere shred that shows as a white line.

FIG. 304. A central incisor, the greater part of the crown of which is worn away. The pulp is completely calcified far into the root.

that most of the pulp is solidly calcified and that there is no sharp line showing the original outline of the pulp chamber. But the light streak running down centrally in what was once a large pulp chamber is a minute opening which contained a filament of living pulp tissue when the tooth was extracted. This had ceased, however, to have any connection with the dentinal tubules of the crown of the tooth, and all sensation of the dentin in that part of the tooth had been lost.

Another case, a central incisor split mesio-distally and photographed by reflected light, is shown in Figure 304. The outlines of the pulp in the crown of the tooth are distinct. In studying a ground section of this, it was found that all dentinal tubules had disappeared almost at once on the border of the whitish area outlining the pulp chamber as it must have been when the calcification was only a little advanced. From that time all connection between the dentinal tubules in the tooth crown and the pulp of the tooth had been broken. The dentin of the crown of the tooth was as completely dead as if the pulp had been removed. This death of the dentinal fibrils is the usual history of the calcification of the pulps of teeth in abrasions. In incisors worn down to the gum line, the form of the pulp will usually be seen as a clear spot in the center of the worn area.

If we find a tooth in the mouth, among these badly worn teeth, that has lost its occlusion by reason of one or more teeth of the opposite jaw having been extracted early in life, it will not be worn down. An examination of its pulp chamber, however, will show the same changes as found in the pulp chambers of those that have been worn. Further, in the examination of the pulp chambers of the molars, and following the lines of contemporaneous calcification, which may generally be quite accurately made out, it will be found that the additions to the floor and axial walls of the pulp chamber have been quite as great as the additions between the pulp chamber and the worn surface. In other words, this calcification, while certainly stimulated by an impression made upon the nervous system by the wear on the surface of the exposed dentin, has been brought about by some influence through the trophic nerves, and has had its influence upon the pulps of all of the teeth, including those that happened to escape abrasion, as well as those that were actually worn away. Cases occur, however, though they are comparatively few, in which abrasion exposes the pulp of the tooth; sometimes one or two of the many that are worn away in one person's mouth. Sometimes this occurs in an individual cuspid, or an

incisor, or the lingual horn of an upper molar; in each case probably the individual horn of the pulp was unusually long and was caught early in the wear.

With the abrasion and loss of vitality in the tooth crown, there is also a loss of strength of the dentin, and the attachment of the enamel to the dentin becomes enfeebled. This fact is important in undertaking filling operations in these teeth. The same thing occurs in teeth in which the pulp has been long dead. In either case, fillings need to be more securely anchored than in living dentin.

When teeth become badly worn, the enamel margin around the worn area often has worn much less than the dentin. This enamel is then liable to split off under the force of mastication and become ragged and rough. Sometimes this will give trouble by cutting and irritating the lips, cheeks or tongue; and to remedy the evil, it should be ground with a stone, removing the rough edges, and then it should be polished with a disk.

Often the abrasion is very uneven on the different parts of the teeth. Frequently the occlusion is such that the wear comes mostly on the buccal cusps of the lower teeth and the lingual cusps of the upper teeth. Normally the upper incisors overlap the lower and the result at first is wear from the labial of the lower and the lingual of the upper incisors. If the wear of the molars allows the jaws to close more, or shortens the teeth generally, the occlusion of the front teeth tends to come directly end to end, by the movement of the lower jaw forward as it closes more. At the same time, it often happens that in the molars and bicuspid teeth the abrasion becomes more and more one-sided on the individual teeth. The lower molars and bicuspid teeth are worn on the buccal sides, while the upper are worn on their lingual sides. This will go on until the shape of the occlusal surfaces are such that the teeth slide together instead of meeting with each other squarely in occlusion. This occasionally places the patient in bad condition for mastication of food.

TREATMENT OF ABRASION. Not much can be done for this condition. It has not seemed to be very amenable to treatment. Some effort has been made, but it seems, from a review of the literature, that this has been rather spasmodic and without sufficient observation and discussion to develop reliable plans of procedure. This subject needs further study and reports of results, with models made when the work is undertaken, when it is finished, and after five, ten and fifteen years of usage, in order to arrive at satisfactory conclusions regarding the advan-

tages of this or that plan. Although I have had wide observation of these cases and the results of efforts at treatment, I have not followed it with suitable models and that completeness of records which now seem so necessary to accuracy of statement. But a few things seem to be well established. The greatest difficulty is to make a prognosis that will serve as a sufficient basis of treatment, early enough to render the best form of treatment effective. If from the conditions present one could foresee what the condition would be ten or twenty years later without treatment, it would place the whole matter in a different light. We have been too much inclined to allow these cases of abrasion to go on until the teeth are excessively shortened and otherwise in bad shape, and then undertake wholesale operations of building up with large fillings, crowns and bridges. My observation has led me to prefer more conservative treatment begun at an earlier period. In many cases, if taken early, much aid can be rendered those whose teeth are wearing away abnormally by making fillings in certain teeth that will take the weight of the occlusion for a considerable time and save much of the wear of other teeth, or, in building up certain worn cusps, that will prevent certain sliding movements. Careful selections should be made of the particular teeth to receive fillings so that the two sides of the mouth will remain fairly and equally balanced to the pressure of the occlusion. Other certain worn cusps should be built up to prevent excessive sliding of the teeth laterally. Observation of the results of efforts that have been made at the wholesale building up of worn teeth has not given sufficient confidence in this practice to recommend it very favorably. It is a long and severe undertaking for both operator and patient, and within a few years some part of this operation is pretty certain to fail and make the case worse than if it had not been done. A few well chosen fillings which will serve to limit the abrasion and excessive sliding movements seem to have given better service.

In cases of excessive wear, the general rule is that there has been a fault in the intercusping of the teeth in such a way as to permit excessive lateral motion. This is first brought to notice by the excessive wear for the time of life of certain cusps which have worn first at their points instead of upon their slopes, as should be the case if the intercusping were normal. Then the question of judiciously limiting this excessive lateral motion should be studied. It will often be found that the building up of the worn cusps will do most good. If there are several of them in opposite jaws that have slid over each other and have

been worn in the process, these should be built up at once, making the fillings as hard and substantial as possible. These fillings will take the wear for several years. If later the enamel of the points of others have worn until the dentin appears, they should be built up in the same way. In this way, hindrances to the abrasion may be continually placed which will serve to limit it and keep it within reasonable bounds.

In such a case as that shown in Figure 300, in which the cusps are worn flat and the dentin has begun to be cupped out, if the cusps had been built up earlier, or as soon as the dentin had been exposed, much of the wear on these and other teeth would have been prevented. As it stands, sufficient cavities may yet be cut and strong cusps built, which will intercusps with similar building on the lower teeth, so shaping them that the teeth will slide into full occlusion normally. The wear will thus be greatly limited upon all of the denture. This building should, of course, include both sides of the mouth. Generally, more should not be undertaken at one time. Later, other teeth may be treated as necessary, but on the same plan. To do this best, requires a careful study of the occlusion and of the motions of the lower jaw. The recent methods of obtaining models so mounted as to show the motions of the lower teeth will, as they are developed, do much toward explaining the relations of this wear to motion and assist in the development of the treatment of excessive abrasion. By this method, the building of cusps can be more methodically done than is possible by noting the motions of the jaws without measurements.

It is certain that some well chosen work with this idea in view will greatly increase the usefulness of the teeth, without burdening the patient with extensive operations done at one time. Fillings made as proposed would generally be small and easily done. They would be spread over considerable time. Some would be worn away by the friction of mastication; cutting deeper and renewing them would become necessary. The most extensive fillings in the first instance would be in the incisors, in which the cutting edges have been worn until more or less of the dentin has become exposed. One series of illustrations in which the abrasion has been allowed to become excessive will be given. As the rule, however, the wear of incisor teeth should be limited by such care of the bicuspid and molars as will relieve them of the stress of the occlusion, rather than by building fillings in them.

Figure 305 shows the abraded cutting edge of the central



Fig. 305



Fig. 306.

Figs. 305-310. A series illustrating the treatment of abrasion.

Fig. 305. The central incisors, badly worn.

Fig. 306. A labial view of the teeth. The lighter area shows the probable form of the portion removed by abrasion.



FIG. 307.



FIG. 308.



FIG. 309.

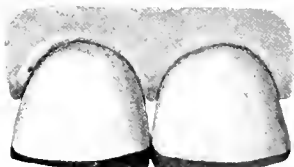

FIG. 310.

FIG. 307. The preparation of these for filling with gold.

FIG. 308. An incisal view of the teeth with the finished fillings in place.

FIG. 309. A labio-lingual section of the finished case, illustrating more fully the cavity preparation. Notice that the labial wall is much thicker and stronger than the lingual in order that it may endure the severe strain of usage. The light area to the incisal of the filling shows the portion of the normal tooth form not built up.

FIG. 310. A labial view of the finished case. Such restorations can be made without seriously disturbing the occlusion.

incisors, and Figure 306 shows the amount of tooth tissue lost beyond what would be normal wear for the age of the patient. The lighter portion in Figure 306 is that which has disappeared, and shortens the labial surfaces about one-third. These teeth are prepared for filling by cutting out considerable dentin, forming a boxlike cavity, so disposing the cutting as to give the strongest walls possible with bulk enough of the filling material to amply support the breadth of surface receiving the stress of the lower teeth. This is shown in Figure 307. With the amount of abrasion here shown, we may safely presume that considerable recession of the pulp of the tooth has occurred and may cut deeper into the crown without danger of exposure of the pulp than we could do otherwise. This fact indicates that the case would have done better if a filling had been made earlier and the present operation left to be done after the first had been worn out by the friction of mastication. A better idea of the cavity preparation will be had by examination of the labio-lingual section through the filling shown in Figure 309. Notice that the labial wall of the cavity has been made much stronger than the lingual. At the angles of the cavity, fairly strong retention points have been made so that the filling will be retained until about the last of it has been removed by friction. Otherwise the walls, after rounding in from the incisal, are about parallel. Figure 308 shows the incisal view of the teeth as filled, and Figure 310 shows the same from the labial view.

Fillings of this nature should be made with the view of standing the friction of mastication — the rubbing under pressure, and the continued heavy pounding in the striking of the lower teeth against them. Therefore, they should have the flat seat and the square angles of this with the surrounding walls, shown in Figure 309, to give them the greatest possible stability under stress. The filling should be built very solidly in every part and be made as hard as practicable by additional malleting throughout. The term "throughout" is used advisedly here, for the intention is that this filling shall be literally worn out to the last bit by the friction of mastication.

But in this there is a difficulty that may limit the amount that may be worn away. By studying the filling and the cavity walls in Figure 309, it will be noted that when this filling has worn to about a certain point, the dentin on the labial, and to a lesser extent on the lingual, will again become exposed to abrasion. This will immediately begin to cup out by wearing deeper than the exposed enamel or the filling. This wear may produce

conditions which will demand the renewal of the filling when it is only half or two-thirds worn. Then another filling should be made furnishing more material for wear and further prolonging the sustaining power and the usefulness of the tooth.

In the above treatment no effort is made toward opening the bite. The filling is built up as much as the occlusion will allow, without too much annoyance to the patient. Several such fillings will do much to sustain the occlusion and reduce the amount of abrasion. One or two together can be made in this way at considerable intervals of time, adding one or two more when indications suggest the necessity. The choice of the particular teeth to build up is of much importance. This choice can in no wise be indicated except by the study of the individual case.

One of the difficulties met with, but not yet fully appreciated by the general profession, in treating these cases by the use of artificial crowns, has been, that when the teeth are so worn as to justify such a procedure, the arch has been much shortened in a measurement from the mesial surface of the third molar upon one side around the arch to the mesial surface of the third molar on the other side, and the necks of the teeth are crowded together. Bands can not be put on the teeth and give sufficient room for a healthy gum septum, and disease of the peridental membranes soon wrecks the case. Some of these cases would do better to remove a number of the teeth and substitute moderately short bridges.

I have had considerable experience in building up badly worn teeth with gold, artificial crowns and bridges to fill gaps. In some instances, wholesale work has been made, opening the bite to the normal, requiring more than a quarter-inch of separation of the jaws. Experience shows that patients soon recover from the difficulty which occurs from the sudden additions to the length of the teeth. Some of these cases have done well for many years, but the larger number of my own, as well as those coming under my observation done by others, have met with mishaps which unexpectedly wrecked them in some important part. In one of my cases in which I had opened the bite about three-eighths of an inch, using fillings, crowns and two short bridges, the patient did nicely after recovering from the awkwardness occasioned by opening the bite. Five years later one of the bridges was found loose at one end. Examination disclosed what seemed to be complete absorption of the root to which it was attached. The bridge was extended to the next tooth. Two years later the root, supposed to have been completely absorbed,

made its appearance under bridge and proceeded to make trouble. Its removal proved an ugly operation, for, while the root was being absorbed about its middle and gingival third, the apical third had added cementum and was greatly enlarged. When this was done, no other trouble appeared and, after twenty years, all is in excellent condition. Not a single pulp was removed from any tooth in the preparation for crowns or abutments of bridges, except from the one root that was absorbed. The only gold visible is that protecting the cutting edges of the porcelain in the teeth in the front of the mouth. As the force of the bite in this case was over two hundred pounds, that protection was a necessity.

In this case the mishap did not mean ruin. But mishaps have meant ruin in too many cases for me to strongly recommend extensive building. Difficulties are particularly apt to multiply when many pulps are removed. Removal of pulps and filling roots becomes especially dangerous when much calcification has occurred in the pulp chambers and root canals. When excessive wear has occurred, it must be let alone or the heavy series of operations undertaken, if anything like a complete restoration is to be made. The case should present very favorable conditions to justify the undertaking; such is the teaching of experience. Dentists will do well to prevent such cases rather than attempt to cure them.

Physical Properties of Filling Materials and the Correlation of Forces Concerned.

FILLING MATERIALS.

THE filling materials at present in use for permanent operations are gold, which holds first place, and amalgam, which holds second place in value. Added to these, a few good men would reckon tin as holding an important place, but the general judgment of the dental profession would seem to consign tin to a very obscure position as a filling material, as, nowadays, very few make much use of it. Recently inlays of porcelain and of gold are assuming prominence as filling materials and are being pushed to the front by many skillful operators.

The filling materials for temporary operations are the cements, especially the oxyphosphate of zinc cements, and the different preparations of gutta-percha.

The qualities most desired in a filling material for permanent operations are indestructibility in the fluids of the mouth, adaptability to the walls of cavities, freedom from shrinkage or expansion after having been made into fillings, resistance to attrition and sustaining power against the force of mastication.

The qualities of secondary importance are color, or appearance, non-conductivity of thermal impressions, and convenience of manipulation.

GOLD. Of these qualities, gold seems to possess those most essential in much the greatest degree. It is perfectly indestructible in the fluids of the mouth; it is very perfectly adaptable to the walls of cavities; it is free from objectionable shrinkage or expansion; its resistance to attrition is good and it sustains the force of mastication better than amalgam.

The greatest intrinsic worth of gold as a filling material lies in the fact that it may be adapted to cavity walls with great force, and is capable of immediately and permanently sustaining that forcible adaptation. Dentin is one of the most elastic substances known. It is this elasticity that renders it so pre-eminent for billiard balls. Its range of elasticity is short as

compared with that of soft india rubber, or even with well vulcanized hard rubber, but it is much longer than the range of elasticity of hard steel. In this, it is more comparable with the range of elasticity of well tempered spring steel. Its force of elasticity is much greater than the force of elasticity of vulcanized rubber and much less than the force of the elasticity of steel. The force of elasticity in dentin is closely comparable to the sustaining power of hammered pure gold. By measurement, the elasticity of human dentin is found to be 5 per cent under a stress of 300 pounds on blocks 1-10 inch square. At 350 pounds this may be increased to from 7 per cent to 8 per cent without injury to the dentin. Blocks of the same size of hammered pure gold are compressed 2.09 per cent (average) by a stress of 300 pounds. If the blocks of gold are fully annealed, they may be compressed 13.14 per cent (average) by 300 pounds stress. The resistance of gold fillings to compression may be made anything between these figures by more or less hardening by malleting in their placement. The strength of the grip of the elastic cavity walls upon the filling will depend directly upon the force with which the gold is wedged between them. It seems from these comparative measurements that, bulk for bulk, the force of elasticity of human dentin, when put to its full limit, is capable of pushing hammered gold aside so strongly as to change the form of the gold for a partial accommodation of its elasticity, but that a large residual elasticity will remain in the walls of the cavity sustained by the gold and exerting permanently a very powerful grip on the gold wedged into it. It is this quality of gold in its relation to the quality of elasticity and strength of dentin, or the mutual relations of these qualities in the two substances, combined with the indestructibility of gold, that renders gold so preëminent as a filling material. No other known filling material can be so worked against the walls of a cavity as to make such full use of the sustaining power of the elasticity of the dentin. Any expansion of gold by thermal changes occurring in fillings is immediately and completely accommodated by this elasticity of the dentin and can be of no consequence whatever.

Of the secondary qualities gold is not so good. It conducts thermal impressions strongly, its yellow color is objectionable, and it is not very convenient of manipulation. Indeed, it may be said of this last quality that its successful manipulation requires much study and careful experience, and yet, when this study is given it and the required experience has been obtained,

it may be worked into fillings more perfectly than any other material.

AMALGAM. As alloys for amalgam are at present prepared by the best makers, it is possessed of the first qualities in a high degree, yet inferior to gold in all. It is not completely indestructible in the fluids of the mouth, but oxidizes or sulphurets slightly, just sufficient to change its color from a silvery whiteness to brown or black, and this can not be prevented. Its adaptability to the walls of cavities is not so perfect as that of gold, though apparently so easy as to be very deceptive. This is one of its greatest weaknesses. Much careful study and experience are required to work it well. Its resistance to attrition is good; its capability of resistance to the force of mastication is excellent in the material itself. But at the time it is placed in the cavity in a tooth, it is too soft and yielding to sustain any considerable degree of the elasticity of dentin, and the sustaining power this mutual relation would give is lost to amalgam. No matter with what force the condensation and wedging is made against the walls of the cavity, this material will yield, will be pushed aside and its form so changed as to accommodate this elasticity almost or quite completely; and the additional sustaining power that this mutual relation of the cavity walls and the filling material — the grip of the cavity on the filling, which is the prominent feature in gold, is lost to amalgam even with the best possible manipulation. This in itself must ever confine amalgam to an inferior place as compared with gold as a filling material.

The possible shrinkage or expansion of amalgam after the filling is made must ever be a shadow over its usefulness. Though when all due care is taken in making and testing alloys to see that the balance of the metals is exactly correct, this difficulty is eliminated. Yet the fear that this has not been perfectly done will be present.

Much of the difficulty attending the use of amalgam arises from a lack of an understanding of its qualities. It is a metallic compound in which each element entering into the alloy exerts its special influence upon the qualities of the product; and these qualities are varied with every little change in its composition. These changes of qualities and the laws controlling them, though well made out, are as yet understood by but few makers of amalgam alloys and are not generally understood by the dental profession. For these reasons, dentists are in constant danger of using amalgam alloys with which good fillings can not be made because of shrinkage or expansion of the material after being made into fillings.

In secondary qualities its color is bad, so bad, indeed, that it should never be used in the front teeth on this account. Its conductivity of thermal changes is nearly equal to that of gold. Its working qualities render it much more convenient than gold in very large and difficult cavities. It can be placed much quicker, the same expenditure of force is required, but much less time. Perfection of adaptation is less certain.

PORCELAIN AND GOLD INLAYS will be discussed later.

FORMS OF GOLD.

Gold is prepared in the form of foil for filling teeth. This foil is prepared in various thicknesses, which are rated on the basis of the number of grains in the sheet four inches square. If a sheet of this size contains two grains, it is called No. 2; if three grains, No. 3; if four grains, No. 4, and so on up to what are known as the heavy foils, such as Nos. 30, 60, 120, etc. Nowadays any thickness of gold foil above No. 10 would be regarded as heavy foil. Such numbers as 60 or 120, which were so popular some years ago, have practically gone out of use in dentistry.

Gold is also prepared for use in filling teeth in the crystalline form. These crystals are put up in various kinds of masses, with about as many names as there are makers. These forms possess certain desirable qualities, especially convenience of manipulation. In this respect, however, it is liable to be very deceptive. In any of these forms it is much less readily kept in good working condition than foil, and for this reason is not so certain in its working properties. It often fails to weld perfectly and especially it is, except for the most skilled manipulation, very unreliable in adaptation to the margins of cavities. Great effort has been made to bring this form of gold into general use, but the general judgment of the dental profession has seemed to be against it, for foil has always maintained its position as the form of gold most used.

WELDING PROPERTIES OF GOLD.

Gold prepared in the form of foil or crystals welds perfectly in the cold state when clean surfaces are pressed into contact. It is the only metal which has this property in a high degree. In order that the welding property may be successfully used, the surfaces of the gold must be clean. As this property of gold is readily lost by improper care, it is well to know intimately the conditions of the development of it, and the loss of it.

All metals, except those known as the noble metals, oxidize quite readily when exposed to the air; that is, they attract the oxygen of the air and unite with it to form a film of oxide upon the surface. This prevents the contact of clean surfaces and therefore prevents welding. Gold, silver, platinum and mercury do not oxidize in this way, and it is for this reason that they are called noble metals. Silver and platinum do, however, attract oxygen to their surfaces in the form of a transparent film of condensed gas sufficient to prevent their surfaces from coming in contact, which prevents them from welding cold. Gold does not attract oxygen nor nitrogen to its surface, and it is for this reason that it can be welded cold. Gold does, however, attract to its surface certain gases that are often present in our atmosphere. These are often condensed upon it in such quantities as to prevent its surfaces from coming in contact and destroy, temporarily or permanently, its welding property. These, however, do not unite with the gold to form any compound. They do not affect its purity. Some of these gases are such as will be removed from the surface of the gold by volatilization when heat is applied (by annealing), rendering the surface again clean, with restoration of welding property. Other gases, notably those of the sulphur and phosphorus groups, condense upon the surface of gold and refuse to volatilize by heat, and thus the welding property of the gold is permanently destroyed. In these cases it seems probable that compounds in the form of fixed salts — non-evaporable — are formed on the surface of the gold. A salt that may be completely volatilized by heat may destroy the welding property temporarily. By annealing, such a salt is removed and the welding property is restored. Two gases may condense upon a metal and, in doing so, unite to form a compound — as a salt. Hydrogen and oxygen are each condensed on platinum. When a platinum sponge (so-called) is formed by wrapping precipitated platinum in wet filtering paper, binding this together with fine platinum wire, drying slowly, and then burning out the paper, this will condense hydrogen and oxygen so rapidly that the heat developed will set a jet of hydrogen gas on fire. This forms what has been called the philosopher's lamp. In this the gases unite to form water. Gases collecting on gold will generally be met by others with which they will form a salt.

These general facts with regard to gold may readily be illustrated by a few simple experiments, which any one with a reasonable familiarity with inorganic chemistry can perform.

Ammonia is strongly attracted to gold. Place a small quantity of spirits of ammonia, or of aqua ammonia, in a large glass jar. The ammoniacal gas from this will fill the space above the liquid. Now take a rope of gold, which has been annealed and the welding property of which is perfect, and swing it by a cotton thread above the liquid in the jar and replace the cork. In fifteen minutes remove the gold and try its welding property. It will not weld any more than so much tissue paper. Another rope of gold is swung above strong chlorin water; the welding property will be completely destroyed in two minutes. Now reanneal these ropes of gold; the welding property is completely restored.

How are we to know that this effect is produced by a condensation of gas on the surface of the gold? Place a rope of gold, first in chlorin gas for ten minutes, and then transfer it to ammonia for an equal time. As these two gases unite to form a volatile salt — ammonium chlorid — which readily crystallizes upon any cold substance, place the gold thus treated in a long test tube and heat it quickly over a Bunsen burner. Immediately white fumes begin to leave the gold, and these crystallize in a white ring on the colder portion of the test tube. Chemical examination of these crystals shows them to be ammonium chlorid. This should occur only by the condensation of the gases on the gold, and the amount formed shows this condensation to be in very considerable quantity. The experiment may be varied by placing the gold first in the gaseous ammonia, and then transferring to the chlorin, but in this case, there will not be so large an amount of the ammonium chlorid formed, for the reason that the ammonia is not condensed on the gold in so large a quantity as the chlorin.

In this experiment, the salt formed is volatile, and the gold is readily cleaned by heat. But suppose the salt formed were a fixed salt that does not volatilize at the annealing temperature? Then the welding property of the gold is permanently destroyed. This is what often occurs when the gold is not well protected. One of the principal reasons why the crystalline forms of gold are more difficult to keep in good condition than foil is the fact that the crystals form a sponge which more readily takes up and holds gases.

By careful experiment it has been found that acid gases are most likely to permanently obscure the welding property of gold; hence, if the gold be kept in an atmosphere containing a liberal per cent of ammonia, ammonium salts will be formed on the gold. These salts are readily volatile; hence gold so kept

will always be readily cleaned by annealing and its welding property restored.

We may use gold, non-cohesive or cohesive, as we choose, from the same book, or the same sheet, by simply keeping it in a drawer containing a small bottle in which a bit of sponge, punk or cotton is placed, and occasionally saturated with spirits of ammonia. Used without annealing, this will be perfectly non-cohesive, or, when annealed, will be perfectly cohesive. This should be taken advantage of in keeping gold in good condition for use in either form.

ANNEALING GOLD.

Gold is annealed to develop its welding property. This annealing is not for the purpose of softening the metal, as in annealing plate, but for the purpose of cleaning the surface of the gold by volatilizing any gaseous film that may have collected upon it. The annealing of a metal plate during the process of swaging is for the purpose of softening it or restoring it to its former condition of softness which has been lost by the violence used in hammering or bending it. This meaning of annealing should be held distinct from the meaning of the word as used in its relation to annealing gold foil. This is for cleaning the gold, not for softening it. This purpose is explained sufficiently in the preceding article. The best means of accomplishing this will depend somewhat upon circumstances. For the general work of filling teeth, the annealing is very well done in the flame of the alcohol lamp or the flame of a small Bunsen burner. The element of time is important in annealing, particularly if the annealing is done at low temperatures, for the gases are not driven off at once unless a full red heat is obtained. Therefore, in annealing in the flame of an alcohol lamp or small Bunsen burner, the gold should always be brought to a glow, and so held for a moment or two. It is also necessary to the best results that every particle of the gold be brought to a glow. In taking up the gold with the pliers, that portion of it that is caught between the beaks and that very close to the beaks, will not be heated sufficiently to develop its welding property. This will introduce into the filling spots of failure to weld and greatly impair the strength of the work. For this reason great care should be exercised in annealing to see that all parts of the gold are brought fully to a glow. This is especially important when an angle is to be built up, as in the restoration of the angle of an incisor, or when a very solid surface is to be made, as upon the

occlusal surface of a molar that will receive severe wear. Pitting of the surface of fillings is in a large degree the result of the introduction of bits of gold that have not been sufficiently annealed. To prevent the possibility of this, it is well to first anneal one part and then lay down the piece and catch it at another point and anneal again.

While the gold should be heated to redness, it should not be heated to the melting point. This ruins the plasticity of the foil and makes it impossible to properly condense it. To avoid these difficulties, the gold may be annealed upon a tray over the flame of the lamp. A number of devices for this purpose can be had, most of which are convenient and effective. The tray may be made of metal, of porcelain or of mica; it does not seem to make much difference which is used. In annealing in this way, the gold may conveniently be exposed to the heat for a considerable time, and therefore a full red heat is not necessary to the complete development of the welding property. When done in this way, there is no danger of hardening the gold by melting portions of it. However, the heat must closely approach the point of redness to be effective. Another advantage is that all parts of the gold will become equally annealed.

The disadvantages of this method are the presence of such an apparatus upon the bracket, which is needed for operating instruments, and that the gold spread upon the annealing tray is liable to movement by every motion, or in the effort to lift pieces from it; and they roll together and stick to each other in such a way as to cause much annoyance and delay in handling them. Much of this annoyance can be avoided by having a tray that is so roughened as to prevent the rolling or sliding of the gold. The electric annealer is the most perfect appliance yet devised for this purpose. Its use, however, requires the electric attachments and arrangements for the control of the current. In offices in which electricity is available, the electric annealer should be employed because of its greater effectiveness, its greater convenience and its greater neatness. The apparatus is much less bulky, is not so high, and the gold is not so liable to be disturbed by shaking; the heat is more evenly distributed and is under more perfect control. It is, therefore, in every respect, more desirable.

THE SPECIFIC GRAVITY AND RESISTANCE TO CRUSHING STRESS OF
PURE GOLD IN VARYING PHYSICAL CONDITIONS
AND IN FILLINGS.

The specific gravity of substances is an expression of their weight as compared with the weight of an equal bulk of pure water. As water itself, and also the substances compared, are subject to contraction and expansion by temperature changes, it is necessary to establish a definite temperature at which this comparison shall be made. In this particular, there have been differences in the practice of scientific men. At present the most general preference is 39 degrees, or its equivalent centigrade, which is the maximum density of water. This, however, is a very difficult temperature to maintain in doing such delicate work, and many prefer a temperature of 60 degrees F. The specific gravity is found by weighing the object, such as a mass of gold, first in the air and then weighing it suspended in water.

If a mass of gold is weighed in air, and the weight is found to be 722 milligrams, and then weighed suspended in water, and the difference is found to be 38 milligrams, this difference is the exact weight of the bulk of water displaced by the bulk of gold suspended in it. As a cubic centimeter of water weighs one gram, the bulk of water displaced equals 38 thousandths of a cubic centimeter and exactly equals the bulk of gold. If we divide the weight of gold (722 milligrams) by the weight of the bulk of water displaced (38 milligrams), ($722 \div 38 = 19$) we find the gold nineteen times heavier than water. Then the specific gravity is said to be 19 for that nugget of gold. This example is close to the usual specific gravity of pure gold when cast, as in an ingot. Pure gold when annealed is a soft metal. When laid upon a slab of dentin cut from a human tooth, it may be mashed or spread by the force applied to it without injury to the dentin. By hammering, gold is made harder than when in the annealed state. It may again be reduced to its original state of softness by annealing, i. e., by heating to full redness. Therefore, by careful manipulation we are able to make use of gold in any degree of hardness between these two extremes of hardness and softness. Gold may be slightly condensed and its specific gravity increased by hammering or rolling, as in making gold plate. This makes the gold very hard, but, when it is annealed, it again becomes soft without losing its increased density.

In elasticity, gold is very deficient, so much so that, in its annealed state, it is said to be inelastic. When hammered or rolled, it attains some elasticity but not any considerable degree. It may be rendered highly elastic by alloying with other metals, notably with platinum. Such alloys are not used in filling teeth, but sheets of platinum foil are covered with gold and these again reduced to foil and then may be used in filling teeth. This is called platinum-gold foil.

The specific gravity of cast gold when cut to a close fit, but left a little too long, and compressed into a strong steel matrix, such as is shown in Figures 406, 407, with a heavy hammer, was found to be 19.4. This density was not attainable in pure gold hammered without lateral support, which would prevent it from spreading under the hammer. The greatest density obtained by filling the same steel matrix with gold foil, using a heavy hammer, will average a little more than when cast gold is driven in. The greatest specific gravity obtained in this way by the author was 19.42. The greatest density obtained by hammering gold in the ordinary way without lateral support to prevent spreading was 19.3. The cast ingot had a specific gravity of 19.20 to 19.25 in its different parts when cut into four pieces and each was examined separately.

The following tables give information as to the density and resistance to crushing stress of pure gold in varying physical conditions.

TABLE SHOWING SPECIFIC GRAVITY OF PURE GOLD, CAST, HAMMERED, AND ANNEALED, AND THE PER CENT OF SHORTENING UNDER A STRESS OF THREE HUNDRED POUNDS ON ONE-TENTH INCH CUBES.

	Specific Gravity.	Percentage of Shortening under Stress of 300 lbs.		
		Greatest.	Average.	Least.
Cast	19.22 to 19.25	12.16	10.14	8.30
Hammered	19.3	2.52	2.09	1.35
Annealed	19.3	14.41	13.14	12.70

Ten experiments in each were made. This table was from a single ingot chosen from the highest density obtained in a number of efforts. The ingot of less density could generally be brought to 19.3 with careful hammering, but did not prove as strong under stress, though the differences were not very great. The amount of softening by annealing is especially notable.

The above may be compared with fillings made of gold foil under different conditions named below.

TABLE SHOWING SPECIFIC GRAVITY OF GOLD FILLINGS, WITH THE PERCENT OF SHORTENING UNDER A STRESS OF THREE HUNDRED POUNDS. FILLINGS ONE-TENTH INCH CUBES.

	Specific Gravity.	Percent of Shortening under stress of 300 lbs.
No. 1. Gold foil. Heavy mallet used with the intention to produce maximum density	19.38	0.9
No. 2. Gold foil as in No. 1, except that hammer was used	19.42	1.0
No. 3. Gold foil No. 4 in $\frac{3}{2}$ sheet pieces. Mallet force as in building fillings exposed to unusual stress. Slab on table	19.18	1.9
No. 4. Same as No. 3, but filled more rapidly	18.61	3.7
No. 5. Gold foil No. 4 in $\frac{3}{2}$ sheet pieces with mallet force same as usual in filling teeth. Slab on cushion	17.4	6.4
No. 6. Two half sheet cylinders of No. 4 foil, non-cohesive, placed in the bottom of the cavity, filling it nearly full. Cohesive foil malleted upon them. Slab on cushion	18.0	39.8
No. 7. Cylinders, $\frac{1}{2}$ sheet each, non-cohesive foil No. 4, laid on bottom of cavity and cohesive gold malleted over. Slab on cushion	18.3	7.3
No. 8. Platinum gold—all annealed—mallet force ordinary. Slab on cushion	4.8
No. 9. Platinum gold folds used flat. Ordinary mallet force. Slab on cushion	7.0
No. 10. Platinum gold foil No. 60. Mallet force as in building fillings much exposed to wear. Size of point, 5x10 tenths millimeters. Slab on cushion	0.8

The first four fillings in this table are, of course, purely experimental fillings, made to show what may be done with gold foil as compared with cast, hammered and annealed gold, as shown in the previous table. The endeavor was to make the last six as fillings may be made in teeth in the mouth. None of these fillings would be moved or shortened by a stress of 300 pounds, while securely held from spreading by the walls of a cavity in which they might be placed. They are, however, spread and shortened when the sides are left free to spread under stress. Gold foil thoroughly welded into fillings, as shown, may be made as strong as the best cast gold without difficulty, or the use of but very little more force than may be used in filling teeth. By very special care, it may be made as rigid — indeed, more rigid than hammered gold from the ingot, because it is malleted little by little within cavity walls, which prevent free spreading laterally. In this experimental work, the walls of the steel matrix had been finished with fine emery. The gold fillings, even those

of the least density, when removed and examined with a lens, showed these emery scratches in every part as perfectly as they could be seen in the walls of the matrix. It is not very difficult to make gold fillings just as dense, with the specific gravity as great, which still have almost the softness of annealed gold, by being especially careful in laying the pieces and using only enough pressure to bring the surfaces perfectly together. Any attempt, however, to spread the gold so as to give cavity walls a solid grasp upon it, inevitably hardens it.

In the *Dental Cosmos*, Volume 37 (1895), page 746, and Volume 38 (1896) page 304, a large number of experimental fillings made by different operators from widely different localities, are tabulated. They are supposed to have been made in the same manner that these men would make fillings in the mouth. The steel matrix in which they were made is heavy enough to give considerable resistance to light, sharp blows, and, if laid on a table, this resistance is much increased. Therefore, it will be noticed that when the slab is laid on a cushion, the intention has been to reduce that resistance to something more nearly that found in filling teeth. The variations in density and in resistance to crushing stress seem almost incomprehensible to any one who has not made a long experimental study of such things. Often fillings of remarkably low specific gravity are found to be very strong. They are malleted well, and the gold is welded and made hard, but all through the filling spaces are bridged over and the adaptation to the cavity walls is strangely imperfect. It was not uncommon to find in these fillings that the central part of the mass was hammered to extreme hardness, while the metal next to the walls was full of holes and much of it loosely condensed.

In comparing experimental fillings with those made in teeth in the mouth, considerable differences in specific gravity have been noted. In the *Dental Cosmos*, Volume 38 (1896), page 304, a comparison is made between these, which gives an average of the total to that time of experimental fillings, excluding those made especially to test the highest possible density, as 16.79, while fillings made in the mouth, page 307, gave only 15.94. This is a difference of eighty-five (.85) hundredths of a volume of the possible 19.4 volumes, or 4.38 per cent. In reviewing the fuller notes later from which these figures were derived, it has been found that some of these old gold fillings were made for children under twelve years old, only one of which was then noted. In old fillings collected later, it has been found that those made

for children are generally of less specific gravity than those made for adults. When these are excluded, the difference is reduced to about forty (40) hundredths of a volume, or slightly more than two per cent. Therefore, these experimental fillings represent very closely that which is done in the mouth. Really, we can never have a test of the lightest fillings made in the mouth for the reason that they go to pieces, instead of being lost as one piece.

The fillings made in the mouth represent the same peculiarities regarding adaptation to walls of cavities as has been noted in experimental fillings. In this examination, the fact that a considerable number of practitioners never grasp the ideas necessary to close adaptation of fillings to cavity walls comes out strongly. They fail in this, even though they make a filling that is very resistant to crushing stress. Other men make fillings with close adaptation to walls of cavities very uniformly even when the total density is low and the resistance to crushing very much less. It therefore becomes apparent that resistance to crushing stress is not the best test of gold fillings, provided, of course, that reasonable strength is attained. Much hammering of gold will make a hard mass, but no amount of hammering of gold that is available in the mouth will make close adaptation to cavity walls unless the laying of the gold, stepping of the plugger point on the gold and the direction of force are correlated to this end. Some men seem to get this intuitively, even when they are unable to explain in words how they do it. Their fillings, whether experimental or practical, show this peculiarity. Their fillings are regularly wedged between the cavity walls. Other men seem never to grasp this in the manipulative sense. Their fillings are loosely and imperfectly packed against the cavity walls, no matter how resistant to stress the mass of the filling may be. Such fillings are comparatively easy to move in the cavity by heavy stress, because the cavity walls have no sufficient sustaining grasp upon them. Final failure from leakage is their characteristic. Notwithstanding this, a certain minimum density must be obtained in order for a gold filling to stand and serve its purpose. The density actually required varies greatly in different cases, but in all it must be sufficient to prevent absorption of fluids into the filling itself. This is pretty certain to occur in any filling with a specific gravity of less than 15, or any portion of which may be below that density. This is a matter of easy experiment when we have the filling fresh from the mouth. Clean its surface quickly with ether and dry it. Heat

it slowly to dry it out, then continue the heating to the point of carbonization. If the filling has absorbed fluids of the mouth for a considerable time, carbonization will occur. If not, it may be heated to redness without carbonization appearing.

It does not require a very dense filling to stand in a buccal or labial cavity, but it must be of good adaptation to the cavity walls. In occlusal surfaces, and especially in proximo-occlusal surface fillings, great strength is a necessity, and broad seating is especially required. A filling with narrow seating compared to the exposure of surface to the occlusion, may stand for the time, but, with the continued pounding by the occlusion for ten, twenty or forty years, it finally gives way and is lost. The filling may be said to have done well, but with a little more care with the seating and the strength of the filling, no failure would have occurred. It is this long-continued use under stress that we should provide for. It is not enough to make fillings that will stand in easy places, or that will stand for a few years only in places of hard usage.

THE NATURE OF BLOWS AND THE RELATION OF SIZES OF PLUGGER POINTS TO FORCE AS USED IN FILLING TEETH

ILLUSTRATIONS: FIGURES 311-319.

In the condensation of gold in filling teeth, blows of the mallet are used. It was recognized many years ago that we, as dentists, needed to know more of the physics of percussion, or of blows of the mallet. There was no source from which to draw the desired information. As early as 1870 Dr. George H. Cushing endeavored to study this subject in a scientific and practical way. He consulted books on physics and the best known physicists he could reach and found no information. He endeavored to construct apparatus that would give information, but was disappointed in the results. Physicists know the force of blows in foot pounds, foot tons, or the various forms and degrees of motion produced in the object struck, and can tell all about it from these standpoints. But when asked about the pressure between two billiard balls at the instant of contact, they tell us only of its effects in the development of motion or work. This does not answer the question we are seeking to understand.

It is the pressure between the mallet and the thing struck that interests us. It is not the motion imparted to the body struck. There are beautiful studies (and they are perfectly correct physics from the standpoint taken) with swinging billiard balls, in which the motion imparted to one ball when struck by another can be very accurately measured by the oscillation of

the ball struck. But it gives us no information regarding the stress between the balls at the instant of contact. The Ballistic pendulum affords a fine opportunity to study the force exerted by rifle balls, but this again is registered in motion produced in the pendulum and does not give the pressure between the rifle ball and the weight forming the pendulum at the instant of contact.

While a gentleman was trying a 22-caliber modern high-power rifle, he happened upon a child's house-building block about two inches square and a quarter-inch thick, made of some very light wood. He set it on a gate post and stepped off a short distance and fired at it. The effect apparent at the moment was to move the block slightly, but it remained standing on edge on the post. Upon examination, he found a hole through it near its center. To the tremendous momentum of the rifle ball, the cutting of the hole through the block was scarcely a feather's weight in retardation, and that was all that was left to disturb the inertia of the block. The ball cut the hole without communicating more than this in motion.

A man was handling a pile-driver, setting very long logs into loose sand. In letting down his steam hammer to drive one of these, he happened to let it, with its accompanying steam cylinder, fall some twenty feet and strike the end of the log. The effect of this tremendous blow was not to drive the log deep into the sand, but the whole of the upper part was broken into thousands of splinters. The force of the blow was spent in destroying the log instead of driving it into the sand. A blow has the nature of an explosion in which all the force generated by weight and velocity, meeting overpowering resistance, is discharged in an instant of time; or, a blow represents the accumulated force of weight, velocity and resistance concentrated in an explosive discharge instead of being spread over seconds of time as measured in foot pounds.

In considering the effect of blows there are four elements: (1) weight of the mallet; (2) velocity of the mallet; (3) the character of the resistance. Upon these three the pounds force of the blow is determined. (4.) Area of surface over which the effect of the blow is expended is a secondary but important factor in determining the work done by the blow upon any substance struck. In this we reckon the force per square millimeter.

In filling teeth we depend upon the force of the blow at the moment of contact. In order to produce the results desired, blows must be carefully fitted to the conditions and the work to

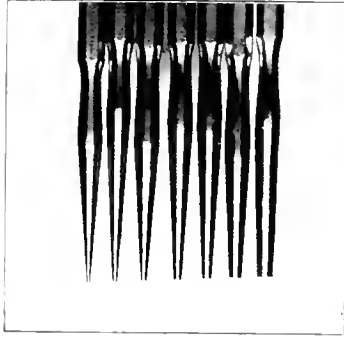

Fig. 311.



Fig. 312.

Figs. 311, 312. The instrument points used in the filling weight apparatus in experimental work on the nature of blows, photographed actual sizes to show the gradation of size. Figure 311 is a side view and Figure 312 is an end view.

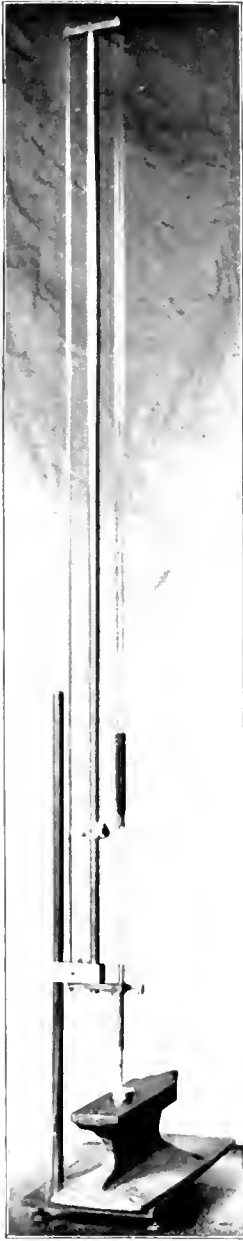

FIG. 313.

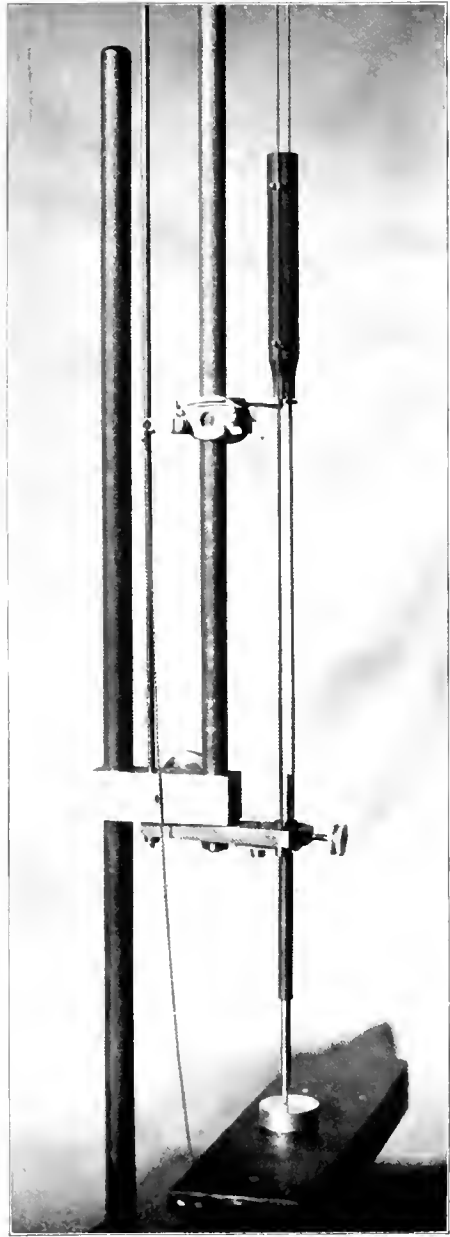

FIG. 314.

FIG. 313. Falling weight apparatus designed by the author. Full length; showing anvil with brass block, an instrument in the instrument sleeve and the mallet on the tripping table above. Observe carefully that the mallet has guide wires to confine it in its definite line of fall (seen best in Figure 314). The principal rod is 42 inches long and can be raised or lowered on its stand 20 inches. It has three scales: (1) centimeters and millimeters, (2) inches and tenth inches, (3) feet and hundredths of feet.

FIG. 314. An enlarged view of the more essential parts of Figure 313, showing the mechanism more definitely. The cord by which the tripping table is tripped is definitely seen in this. This table is fixed on the rod by a thumb screw (which is hidden in this view) by which it may be placed at any height within the length of the rod. When the tripping table is released by a slight pull on the cord, it is snapped from under the weight (mallet) very suddenly by a coiled spring, giving the weight a perfectly clear fall. The stand has a leveling arrangement by which the guide wires can be brought exactly perpendicular.

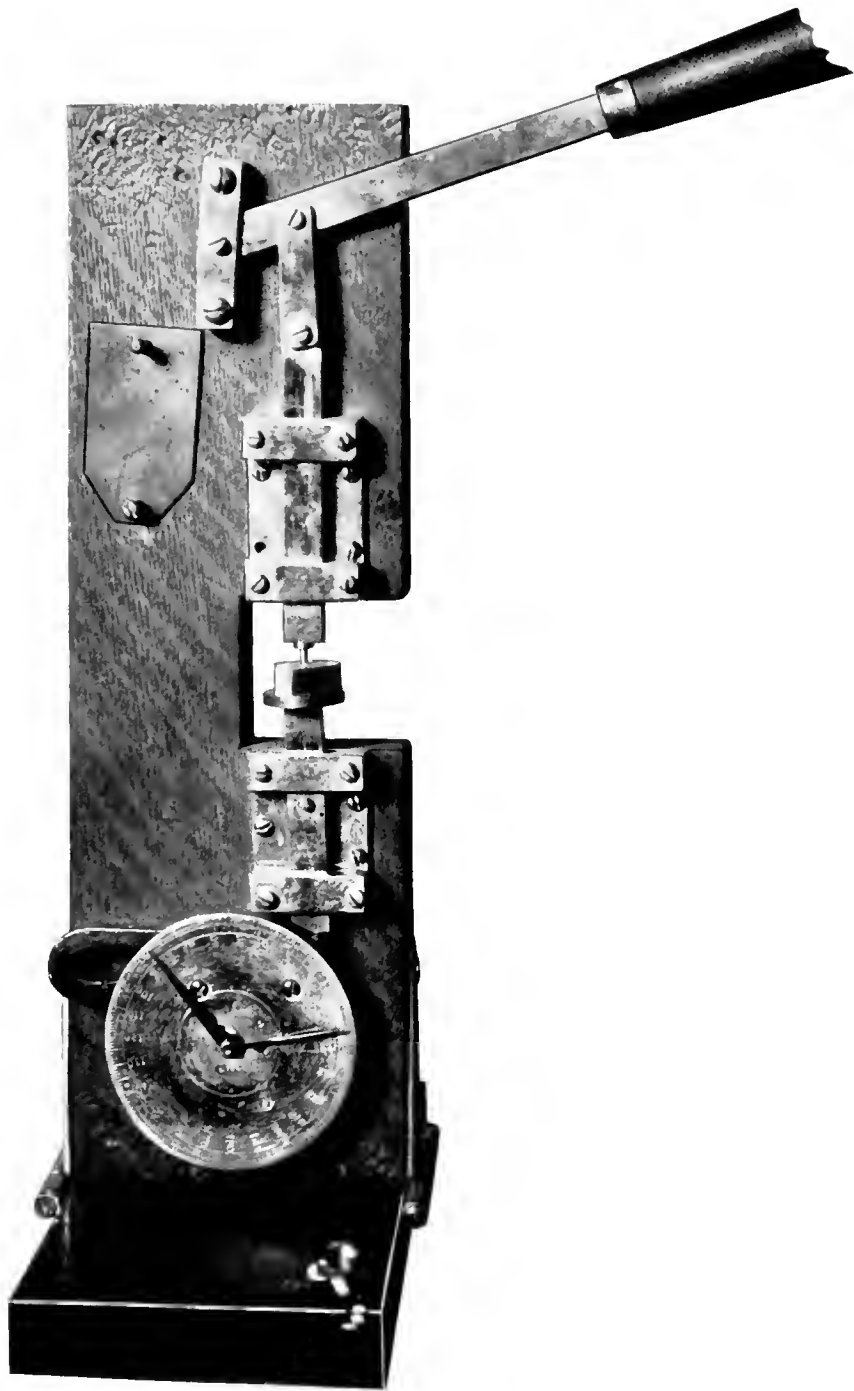

FIG. 315.

FIG. 315. The thrust dynamometer, designed by the author, by which a quick thrust of a definite number of pounds can be made. The broad hand on the dial when pushed around by the small hand, retains its position, marking the number of pounds in the thrust. There is also an attachment by the adjustment of which the lever may be stopped at any definite number of pounds determined upon for repeated thrusts, for obtaining greater exactness.

be done. They must not be too strong nor too light or they will fail to fulfill the purpose intended. In each case the area of the plugger point must be fitted to the pounds pressure of the blow. The instrument we use, and which receives and transmits the blow of the mallet, communicates the accumulated force of the mallet, less the retarding power of its own weight, to the condensation of the gold. It is the stress between the instrument point and the gold that we employ.

The impact or force with which the instrument strikes the gold may be measured in pounds or kilograms stress in several different ways. For the purpose of illustration, we may use: (1) a thrust dynamometer to measure the force of thrusts or pressure in pounds or kilograms; (2) a falling weight apparatus for obtaining a variety of uniform blows by mallets of definite weights falling from definite heights; (3) instruments with points of definite area; (4) a specified cardboard and boxwood blocks cut from one piece of the wood. This prepared wood may be placed on an anvil to furnish a definite resistance. The instruments used are turned to very nearly the size required and then tempered. After tempering, they are ground to exact size and the ends perfectly squared. The edges are made sharp. Figures 311, 312. The sizes of the points used are 0.5, 0.75, 1.0, 1.25, 1.5, 2.0, 2.5 millimeters in diameter. All are round.

The instrument measuring 2.5 millimeters in diameter is placed in the instrument sleeve of the falling weight apparatus, Figures 313, 314, and a mallet that weighs approximately three ounces (93.270 grams), let fall 85 centimeters (33.5 inches) and strike the instrument. Under the instrument point is a polished block of boxwood, the fiber of which is on end, and over this a piece of hard cardboard 1-100 inch thick. The boxwood block rests on an anvil. The effect of the blow is to cut a clean hole in the cardboard and implant the piece cut out in the wood exactly level with its surface. This blow reckoned in foot pounds, with its result spread over one second of time, would generate a force of a little more than five-tenths of a foot pound. Now transfer the same boxwood block and the same cardboard to the thrust dynamometer, Figure 315, and with a precisely similar instrument point measure the pressure necessary to produce a similar result. This is found to require 250 pounds pressure. This is the real force of the blow at the instant of contact.

Place the instrument 2 millimeters in diameter in the falling weight apparatus and let the same mallet fall from a height of 44.8 centimeters (17.5 inches) under otherwise the same con-

ditions. This also cuts a smooth round hole through the paper and buries the piece cut out in the boxwood just to a level with its surface. Try this with an exactly similar instrument point in the thrust dynamometer to find its stress in pounds. The effort shows that it requires 160 pounds pressure to cut this through and implant the piece cut out in the boxwood level with its surface. The difference in the area of the two instrument points, the one 2 millimeters in diameter and the other 2.5 millimeters in diameter, makes the difference found in the pressure required to do what seems to be so nearly similar work. This difference is also represented in the difference in height of fall of the mallet in the two cases. These differences are exactly in accord with the difference in the area of the instrument points. The smaller has an area of 3.141 square millimeters and the larger has an area of 4.908 square millimeters. A calculation will show that 0.196 square millimeters of this boxwood block will sustain one pound in pressing the paper into the block to a level with its surface.

We continue the experiments similarly with the other instrument points illustrated, and the results are such as are represented in the first six columns of the table given below. These give the diameter and area of each instrument, stress in pounds and kilograms, and height of fall in inches and centimeters. The other three columns give the height of fall required to do similar work with the lighter mallets indicated. The smaller sizes of these instrument points are the equivalent of the sizes of pluggers points used by dentists. In this table no variation in the resistance is given, except that furnished by the difference in the area of the points used. In all the boxwood block has rested on the anvil.

TABLE SHOWING DIAMETER AND AREA OF POINTS, POUNDS AND KILOGRAMS STRESS BY FALL OF MALLETS OF GIVEN WEIGHTS FALLING FROM GIVEN HEIGHTS.

Diam. mm.	Area	Pounds	Kilograms	HEIGHT OF FALL OF MALLETS.				
				Weight, 93.270 Grams.		Weight, 62.216 Grams.	Weight, 31.008 Grams.	Weight, 15.554 Grams.
				Inches	Centimeters	Centimeters	Centimeters	Centimeters
.5	.1963	10.	4.536	1.4	3.4	5.08	10.20	20.32
.75	.4417	22.5	10.205	3.00	7.64	11.44	22.88	45.75
1.00	.7854	40.	18.14	5.35	13.60	20.38	40.78	81.03
1.25	1.227	62.5	28.35	8.38	21.25	31.85	63.75	127.4
1.5	1.767	90.	40.82	12.00	30.58	46.29	92.61	185.2
2.0	3.141	160.	72.58	21.4	54.4	81.55	163.12	326.2
2.5	4.908	250.	113.4	33.56	85.	127.2	254.6	509.0

The height of fall for the heavier mallet is given in both inches and centimeters. The height of fall for the smaller mallets is given in centimeters only. All heights of fall above one meter (100 centimeters) have been calculated.

In Figure 316 the boxwood block is photographed in actual size, and in Figure 317 this is enlarged. In each, the white cardboard is shown imbedded in the boxwood. The smaller figure gives a correct view of the sizes of the instrument points for comparison with the figures as given in the table. In Figure 318 the instruments are struck into the boxwood without the paper. In Figure 319 the seven sizes of instrument points are struck into a brass block, the mallet falling from the same height on each instrument.

If we replace the instrument 2 millimeters in diameter and let the larger mallet fall from 44.8 centimeters height as before, but place a thin sheet of cork on the anvil under the boxwood block, the instrument will not penetrate the cardboard. Trial after trial with this or other sizes of points, raising the height of fall more and more, shows that the height of the fall must be a little more than doubled in order to cut the paper through as before. This increased height will depend on the quality and thickness of the cork. It requires no more force to cut through the paper; that is 160 pounds as before, but the difference in rigidity of the block on which the resistance depends has been changed by the cork so that the boxwood gives way before the instrument, lengthening the time of the explosion and diminishing its intensity, or pounds force. The velocity must be increased in the same ratio to bring the blow to the same quickness of explosion and to the same number of pounds stress in order to produce the same effect. This is just as important for us to know and be able to judge of correctly in practice as it is to know the force of the blow on a solid support. It is an essential part of the relation between the momentum and the pounds force of the blow, and if we had the measurement, it would be calculated by the rules for retarded motion. This is further illustrated by the common observation of the difficulty in driving a nail through a light board held in the hand. The force of the blow is dissipated by the movement of the board. This difference in resistance is continually changing the force of blows used in our practical operations in filling teeth. Some teeth have very thin peridental membranes, in which the teeth give way to blows very slightly. Others have thick peridental membranes, and, though strong, the teeth have much more motion

in their sockets. They give more to the blow, reducing its pounds force. In using hand pressure, these differences are of no effect.

In one sense this may be regarded as a crude form of experiment, in which one essential element, the resistance, is not accurately measured. It is a comparison between the work done by a weighed thrust and by a blow. It is intended to show the difference between pounds pressure discharged by a blow at the instant of contact, and foot pounds, or the motion produced in the thing struck. Physicists have generally regarded the measurement of this pressure at the instant of contact as practically impossible because of its very short duration. Instruments can be built, however, that will measure it very accurately.

This particular plan of measurement is used here because it may be better illustrated and therefore better understood than results detailed in figures derived from more accurate plans of experimental study. Impressions in metals made by falling weights can be measured in microns, or in ten thousandths of an inch, giving much more accurate results, but even these are not entirely free from error. So far as the main facts under which we must work are concerned, this plan of measurement declares them with sufficient accuracy to guide us in the selection of instrument points and in determining their relation to the pounds force we may employ.

An area of gold, which, in its condensation, will require fifteen pounds stress, is not more than .785 sq. mm., or the area of a plugger that is 1 mm. in diameter. It will be seen by the table given above that this instrument, 1 mm. in diameter, requires 40 pounds to bury the cardboard to a level with the surface of the block. The diameter and the area of the points are given in the table, and the pounds force developed by four mallets, each of specified weight, each falling from a specified height for each instrument.

At the ratio of 15 to 40 pounds, the pounds force required for the condensation of gold is represented in the following table:

Diameter of points in millimeters...	0.5	0.75	1.0	1.25	1.5	2.0	2.5
Area of points.....	.1963	.4417	.7854	1.227	1.767	3.141	4.907
Pounds stress	3.75	8.43	15.00	23.43	33.25	60.00	93.75

Careful trials at the chair by a number of assistants well trained in the use of the mallet in condensing gold, have shown that a blow of twenty-five pounds is seldom exceeded without an unusual effort to strike hard blows. Forty pounds was

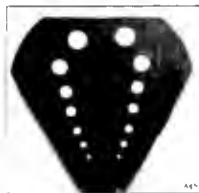

FIG. 316.



FIG. 317.

FIG. 316. A box-wood block in which cardboard has been implanted; those on the left by the thrust dynamometer and those on the right by the falling weights. The measurements of the diameter in millimeters and the stress in pounds in implanting each one is as follows, reading each side from the top downward: 2.5 mm. 250 lbs., 2 mm. 160 lbs., 1.5 mm. 90 lbs., 1.25 mm. 62.5 lbs., 1 mm. 40 lbs., .75 mm. 22.5 lbs., .5 mm. 10 lbs.

FIG. 317. An enlarged picture of Figure 316.

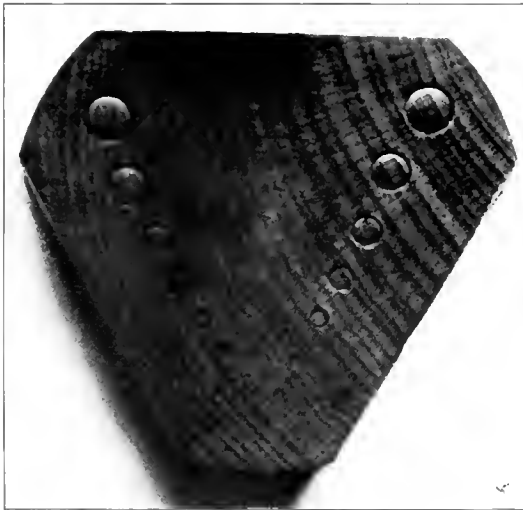

FIG. 318.

FIG. 318. An enlarged view of a block of box-wood, the left side of which received thrusts from the dynamometer and the right side strokes from the falling weights, according to the figures given under Figure 316. The rounding up of the bruised wood in the bottoms of the punctures made by the springing back of the wood is well seen in the prints of the larger instruments. The picture does not show depth very well.



FIG. 319.

FIG. 319. A brass block (enlarged) in which the seven instrument points have been struck, all with the two tenths pound mallet, falling 33.56 inches. The progressive increase in depth reading from the larger to the smaller is only moderately well shown. The depth is .14 millimeters for the largest instrument, increasing to 1.25 millimeters for the smallest.

attained by an effort that seemed to be much greater than is used in filling teeth.

Notice particularly that when the diameter of the instrument point is doubled, both the area of the point and the pounds force required are four times as great. This is seen in both of the tables in the difference between the pounds force for the 0.5 millimeter point and the 1.0 millimeter point; between the 0.75 millimeter point and the 1.5 millimeter point; between the 1.0 millimeter point and the 2.0 millimeter point, and again between the 1.25 millimeter point and the 2.5 millimeter point. Any intermediate sizes are in the same proportionate relation. This exhibits the law of the relation of the size of plugger points to the force used, and there can be no question as to its correctness.

With this fully appreciated, one should not go far astray in the selection of plugger points. Each man should know precisely how many pounds he can use with the pen grasp in filling teeth. It has been found by experiment that less than fifteen pounds on the area of a plugger point 1 millimeter in diameter can not be used successfully in condensing gold, and this is generally — that is, for most men — too large for hand-pressure work. Observation with the manodynamometer shows clearly that the man of average finger power can not use more than this regularly in his every-day work. Many can not use so much; some can use more. A plugger point larger than 1 mm. will inevitably produce a filling that will be imperfectly condensed, unless the conditions are such that the additional pressure can be used. If we use too much pressure for the area of the plugger, the gold will be chopped up instead of condensed. This may be illustrated by dropping a weight from too great a height upon a block of annealed brass.

The 1.5 mm. point will bury the paper rather deeply into annealed brass, falling three feet. With the same fall the 1 millimeter point is driven so deeply into the solid metal that the block may be swung about on the instrument point. We are limited to a very narrow range in sizes of plugger points. In practice the area of the plugger points should vary between that of .5 millimeter and 1 millimeter in diameter. The form may be anything desired. The smallest of these points should be used only by hand pressure in some particular places; as in starting fillings in very small convenience points, or some out-of-the-way place in which we will necessarily use hand pressure. The points for general use should vary between the area represented by .75 mm. and 1 mm. in diameter, and should be confined

quite strictly to that variation of size, no matter what their form may be. If we must use a foot plugger to reach in between proximal surfaces, it should be so narrow that we will not use more than this area of the toe of the plugger in condensing gold.

RULES THUS FAR DEVELOPED FOR FINDING IN SIMPLEST FORM BY EXPERIMENT THE ACTUAL POUNDS OR KILOGRAMS DELIVERED BY BLOWS. These are given, for the use of any persons who may wish to make experimental studies along this line.

(1.) With one of the larger instrument points, preferably the largest, in a thrust dynamometer, find the number of pounds or kilograms required to cut through a certain cardboard and bury the piece exactly flush with the surface of a certain block of polished boxwood, using the end of the fiber. This relation of the paper to the surface of the block should be carefully examined with the binocular microscope and corrected until it is believed to be exact.

(2.) Divide the area of the point used by the pounds, or kilograms, stress found in (1) to find the exact area of the wood (and cardboard) for one unit of force, and multiply the area of each smaller (or larger) point by this number as the primary determination of the stress required with each to produce results similar to the first; or let A represent the area of the first instrument and S the stress found, and let A^1 represent the area of the smaller instrument and S^1 the stress required. Then the following formula may be used:

$$S^1 = \frac{A^1 S}{A}$$

(3.) When these have been calculated, they should be carefully tried successively for each size of instrument in the thrust dynamometer. The result should be carefully examined with the binocular microscope to see that the papers are not left too high in the wood or that they are not thrust too far in below the surface. If irregularities are found between the larger and smaller instruments (from one millimeter up) the whole line must be modified by starting the calculation from a little higher or a little lower point until the results will be regular for all of the larger instrument points.

CAUTION.—It is important with the smaller points to scan the grain of the wood carefully with the microscope where irregularities occur, to see if the puncture has been wholly in the softer part or the harder part of the annual rings.

(4.) Place the instrument, first used in the thrust dynamometer, in the falling weight apparatus and with the larger mallet try different heights until a certain height of fall is found that will give results exactly similar to those produced by the thrust dynamometer. When this is satisfactory, proceed to find the height of fall for this mallet with the smaller points as follows:

(5.) Multiply the area A^1 of the next smaller instrument by the centimeters height H of fall of the largest, and divide by the area of the largest A , and the result

will be the height of fall for the smaller H^1 , and the equation will be: $H^1 = \frac{HA^1}{A}$

The stress found may be used instead of the area. Thus $H^1 = \frac{HS^1}{S}$ This latter

may also be used to find the height of fall for any desired number of kilograms or pounds, when these have been experimentally proven correct for the various sizes of instrument points.

(6.) The height of fall for any weights of mallets may be found thus: Let W and H represent the weight and height of fall of the larger mallet and W^1 and H^1 represent the same for the smaller, and the equation will be: $H^1 = \frac{WH}{W^1}$ in finding the height of fall for a smaller mallet. It may, of course, be reversed for finding the height of fall for a larger instrument.

In all of this, it must be understood that such a scale must be found for the particular piece of wood and the particular piece of cardboard used; no two of either of these will be exactly the same in hardness. But the rules will be the same for all, including metal blocks.

STRENGTH OF THE BITE.

The strength of the bite represents the force with which the jaws may be closed on food or other material brought between the teeth. This has been quite fully presented in the first volume. Here only an outline of the main facts need be given. This is to be considered, however, with great care by every operator, both in general and in relation to each individual operation. The strength required in fillings, bridges, crowns, etc., is very much greater than was formerly supposed. This has been developed by direct experiment in comparatively recent times. Perhaps this example will show best the ordinary range of the force of the bite. Half a dozen students were called to exhibit their power by biting upon the gnathodynamometer. The result was 155, 190, 250, 220, 225 and 150 pounds on the first molars. This fairly represents the usual results and the variations in stress persons with good teeth and of ordinary habits in their use, can exert. A few will exert a greater stress, as much as 275 or 300 pounds. Many people who habitually use their teeth delicately, will stop at 100 pounds or less. Sometimes this may be found as low as fifty or sixty pounds in persons who habitually pat their food into a bolus with their teeth and swallow it without chewing it. Such persons will bear the blows of the mallet in filling teeth very poorly. In the ordinary chewing of meats, great force is not required, but if some hard substance happens to be in the meat, as a fragment of bone, a shot in game, etc., which is caught between the teeth unawares, the result is a severe jolt upon the teeth. We actually use, habitually, very much more force than seems necessary to crush food. The habit of persons who use their teeth best is to dash them through their food. The jolt on a hard substance is as likely to be received on a filling as on the surface of the tooth and will give the filling a severe test. This is liable to occur again and again. Finally, unless the filling be very strong, it will begin to move. Then it is only a short time until it will be lost. It is for this reason that cavities are prepared in certain ways different from previous custom among dentists. A filling that is really well made ought to stand indefinitely. Therefore, cavities for fillings which must receive the stress of the occlusion, are prepared with a squarely cut horizontal seat for the filling, because that will give it the greatest strength. In those cases in which this can not be carried out in full without injury, the nearest possible approach to it should be made. As cavities are formed by caries, the pulpal wall

will usually be rounded when the decay is removed; it will be in the form of a hollow sphere. If a cavity is left with this form, it gives the opportunity for the filling to move, or to roll, when severe stress comes on any particular part of it. Then its usefulness is at an end.

In building out central incisors that have lost an angle, there is usually only about half the stress to contend with as in the molars; yet, in a few instances, as much as two hundred pounds stress has been measured upon these teeth. It is not uncommon for persons to take a hard bread crust between their teeth and put the full force of the muscles of the jaws upon it and then tear it with the hand, putting an additional stress upon them in a direction to exalt the breaking strain.

A laborer applied to the dental clinic for aid, and the central, lateral and cuspid teeth on the right side were found forced to the labial and the entire alveolar process broken. In eating his lunch he had taken a tough piece of meat in his teeth and tried to bite off a piece, aiding the process with a strong pull with the hand, with this result.

In building out angles of incisors, we do not often have such enormous pressure to deal with, but with the more ordinary stresses we must make such buildings very strong if they are to stand firm year after year. Every filling should be made with the idea that it will at some time be tried with great force, and its strength should be suited to meet that force.

FILLING WITH GOLD.

IN filling teeth, cohesive gold or non-cohesive gold may be used; the cavity may be partly filled with non-cohesive gold and finished with cohesive gold, or a certain wall of the cavity may be covered with non-cohesive gold and the rest of the filling made of cohesive gold.

FILLING WITH NON-COHESIVE GOLD.

Filling with non-cohesive gold for the entire cavity is practiced but very little nowadays, apparently for two reasons: it requires the development of a different order of skill from that required for cohesive gold, which is somewhat difficult to master, and it can not be used for contouring or in filling to form in cavities that have lost one or more of the surrounding walls. In this manner of filling, the principle of wedging the gold between the surrounding walls is depended upon to hold the gold together and to retain it in the cavity. The loss of one of the surrounding walls of a cavity practically prohibits its use. For this purpose, foil only is used, and its lamina must extend from the bottom to the surface of the cavity. Either the form of the rope or cylinders may be used. In this method of filling, the gold is not annealed. With our present ideas of preparing cavities, only occlusal and buccal or labial cavities that have complete and good surrounding walls are suitable for non-cohesive gold. The forms in which we now prepare these are as suitable for non-cohesive as for cohesive gold, only that no convenience points for starting the filling are required for non-cohesive gold. The cavities, however, must be deeper than many that we prepare for cohesive gold, particularly buccal and labial cavities.

In filling an occlusal cavity in a molar with non-cohesive gold cylinders, we should prepare the cylinders so that their length is a little greater than the depth of the cavity. Some should be large and some small, the size of the larger ones depending upon the size of the cavity. Begin with the cylinder, which, as loosely rolled, will about fill the cavity full. Set this in the cavity with one of its ends standing upon the pulpal wall and the other protruding from its orifice. With the side of a

large plugger, press the cylinder against the distal wall. Holding with a second instrument to prevent movement, set another cylinder in in the same way and condense it against the first. Repeat this by adding cylinder after cylinder until the distal half or more of the cavity is filled. Continue by condensing the cylinders against the mesial wall, and in turn the buccal and lingual walls, all the time using the lateral pressure with the side of the plugger point, not with its end. As the work progresses and the cavity room is narrowed, the cylinders introduced must be smaller and smaller. Finally, to obtain room for additional cylinders, a sharp point of a wedge form in a large handle, suitable for the full palm grasp, must be pressed to the bottom of the cavity, and, with a prying motion, the gold is wedged against the cavity walls in every direction with great force. The space thus gained is again filled with small cylinders and the wedging repeated so long as it is possible to force in another cylinder. The small cylinders last introduced should be rolled very hard. When it is no longer possible to force another cylinder into the central portion of the cavity, efforts should be made at various points to force in the sharp, wedge-shaped point and any openings made should be filled with small cylinders. When no more gold can be introduced, the whole surface should be condensed as completely as possible with the end of a finely serrated plugger. Then the surplus gold should be trimmed partially and the condensation repeated. Then again trim and condense, repeating this until the surface of the filling is brought to proper form, with its margins just flush with the cavity margins. In repeating the trimming and condensation, only the harder parts of the surface will be cut away and the softer parts will be condensed more and more. Finally the whole surface will become about equally hard. Generally these fillings should be finished with the burnisher.

Instead of the cylinders, ropes of foil may be used by carrying an end to the bottom of the cavity and folding in fold after fold, so that one end of the loop is on the pulpal wall of the cavity and the other protruding from the orifice. These loops are condensed against the walls laterally, and finally condensed by wedging, the same way as in filling with cylinders, filling the space gained by other loops. The filling is finished in a similar manner.

In filling buccal or labial cavities with non-cohesive gold, the steps of the procedure are practically the same as in filling occlusal cavities. However, the operation is generally rather

more difficult in these, for the reason that the cavities are generally of less depth in proportion to their breadth. The most convenient cavity to fill with non-cohesive gold is one in which the depth is nearly equal to the breadth.

One who has become skillful with this manner of manipulating non-cohesive gold, can make gold fillings in cavities suited to this work in much less time than they can be made with cohesive gold. This plan of filling is often very desirable for first molars for children, and in various cases that come up in practice in which it is important to shorten the time of the operation.

These non-cohesive gold fillings do not stand attrition so well as cohesive gold fillings in positions where great wear comes upon them. They are, therefore, more suitable for buccal and labial cavities. If very well done, however, they do excellent service in oclusal cavities where the wear is not extraordinary.

It is the general opinion of those who use much non-cohesive gold that water-tight margins are more certainly made with it than with cohesive gold. This is certainly correct. It seems to have been the general opinion that, with the same care and skill, more gold could be put into a cavity of a given size, using non-cohesive gold than with cohesive gold, but careful measurements have not supported this proposition.

The use of non-cohesive gold in this way is now almost a lost art, and it seems probable that it will go out of use entirely. Something of the differences of the instruments used for this purpose from the present forms has been presented in discussing instrument grasps. At present there are no suitable instruments in the market for this work, and dentists seem to be losing the art of making these for themselves when occasion requires. It is a great loss to dentistry that we do not now make use of the plan of filling with non-cohesive gold; a plan that was general before the discovery of the cohesive property of gold, and still could be used to great advantage in certain cases.

FILLING WITH COHESIVE GOLD.

ILLUSTRATIONS: FIGURES 320-337.

PREPARATION OF GOLD FOIL. Preparation of gold foil for filling requires careful attention. The sheet of foil as it comes from the dealer must be divided and formed into suitable sizes of pieces for the particular case. A very convenient form, which is the oldest in use, is to roll the sheet, or a division of it, into

a moderately close roll. The roll is usually made by rolling the sheet of gold in a napkin. For this purpose the sheet, or division of a sheet, is laid on a smooth napkin and the napkin folded over it. The part folded over the gold is then pulled over it in such a way as to roll up the sheet into a loose roll. By repeating the motion, the roll is made as much tighter as may be desired. It usually requires a number of efforts to do this well, but after a little experience it is done easily, quickly, and very smoothly. These rolls are usually cut into short lengths that are convenient to place in the cavity.

A very good and convenient form of the roll, usually called the rope, is made by crumpling the sheet, or a part of a sheet, together into a rather rough rope and then twisting it closer, being careful to have the size fairly even through its length. This rope may then be cut into suitable lengths for introduction into the cavity.

Cylinders for the ordinary use in filling are made by first folding the sheet, or division of the sheet desired, into a ribbon to the width corresponding to the length of cylinder desired. This is then rolled on a three- or four-sided broach into a cylinder. These may be made of any size. Very nicely prepared cylinders of this form are always to be had ready prepared from the supply houses. They are better made than the dentist can usually do them, and are to be preferred if this form of gold is used. For use as non-cohesive gold on the gingival walls of cavities in the bicuspid and molars, larger cylinders are usually needed. These may be made of any size, as described above. The flat cylinder, so-called, or mat, is made by rolling the folded gold on a flat instrument. A larger round instrument may be used and the cylinder flattened after rolling.

My personal preference as to form of preparation for introduction into the cavity has been the block, which I have taught my assistant to make for me. Sheets of No. 4 gold are cut into four, eight, sixteen and thirty-two pieces. Each of these is crumpled together in the fingers (chamois skin finger-tips are used unless the hands are very dry) and formed into a very loose ball. This is then caught between the blades of a pair of light flat-nose spring pliers and squared up into a block. Some of these are pressed loosely, others more closely, depending upon their particular use. It does not seem practicable to form these blocks well by machinery. If they are used, they must be formed in the office. There is no other form in which gold can be used with so much certainty and so rapidly as in this block



1 sq. mm.
15 lbs.

FIG. 320

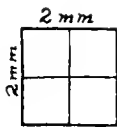

4 sq. mm.
60 lbs.

FIG. 321

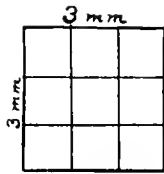

9 sq. mm. 135 lbs.

FIG. 322

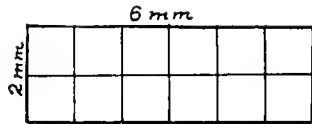

12 sq. mm.
180 lbs.

FIG. 323

FIGS. 320-323. A series of diagrams illustrating the difference in force required for application of equal condensing power with increasing areas of plunger points. The rule illustrated applies in inverse ratio in the reduction of the size below one millimeter. Figure 320 represents a 1 mm. square plunger point on which a 15 pound blow is struck; Figure 321 a 2 mm. square (4 sq. mm.) point, which requires a 60 pound blow to give the same condensation as obtained on the 1 mm. square point with a 15 pound blow; Figure 322 a 3 mm. square (9 sq. mm.) point, which requires a 135 pound blow to give the same condensation, and Figure 323 a 2x6 mm. foot plunger (12 sq. mm.), which would require a 180 pound blow to give the same condensation, if the entire face of the plunger were used.

form. There is less tendency to tear, or to ball, under the instrument than many other forms in which foil has been prepared for use.

With the rapid-stroke mallets, such as the electric and the mechanical mallets attached to the engine, many persons prefer to use gold in the form of the ribbon. This ribbon is the same as that prepared for making the cylinders. In using the ribbon, it is laid flat on the previously condensed gold and the condensing point is carried lightly over it while rapid strokes of the mallet are being made. Because of the peculiar motion, this is often spoken of as "wiping in the gold." Many modifications of the forms mentioned have, from time to time, been employed.

The forms of crystal gold have been varied greatly by those preparing them. Some are made in masses that may be pulled apart into pieces of various sizes, as wanted; others are in sheets that may be cut into strips or blocks. Nothing could be said here that would be of special value. Each maker of this form of gold prepares it in some special manner and gives it a special name. Otherwise than the outward form presented, they are all practically the same thing.

THE APPLICATION OF FORCE IN FILLING WITH COHESIVE GOLD.—

In using cohesive gold in filling teeth, all parts of the gold should be welded into one solid mass. This is accomplished by condensing the gold in small masses with the end of the plugger point, by either hand pressure or the blows of the mallet. The use of sufficient force by hand pressure to accomplish this well, or to obtain the necessary degree of solidity, becomes exceedingly tiresome to both the patient and the operator. For this reason, mallet force has come into general use. The kind of mallet used for condensing the gold seems to be of much less importance than the particular manner of handling it, and this last must be stated as being a personal equation; that is to say, one person will accomplish a given condensation of gold with much less inconvenience to the patient than another can do, and yet, the differences in the application of force are not such as permit of analysis and a determination of the precise differences of manipulation. It is, however, closely akin to the differences in touch between that regarded as very good and poor among musicians in piano-playing.

Of the different plans of applying mallet force, the hand mallet used by an assistant is by far the best, as it will produce the desired result with the least wear and tear to both patient and operator. The next best, but much inferior, method is by

the use of the automatic mallet. Of these instruments there are a variety in the market of almost equal merit. The poorest method practiced is the use of the hand mallet by the operator himself. In this use of the mallet, the operator can handle neither the plugger nor the mallet properly, and the usual result is great wear and tear upon both the patient and operator, and generally much imperfect work in condensing the gold, especially in its adaptation to margins.

In order to condense gold well and with the least pain to the patient, the mallet force should be combined with a certain degree of hand pressure. The plugger should be placed firmly in position with such force as to bring the looser portions of gold well together and to force the tooth into a stable position in which the fibers of the peridental membrane are rendered tense, and then the blow from the mallet should follow on the instant this is done, two blows following each other in close succession. Experience has, I think, sufficiently shown that the best results are obtained by this method. This is in some degree copied with the automatic mallet.

The sliding of the plugger point over the surface of the gold while blows are being rapidly applied, is very much more painful to the patient if the same results in condensation are accomplished. A number of machines have been devised for malleting that are very convenient in use, and yet they seem not to be much used, evidently for the reasons assigned. Among these are included the electric mallet and several mechanical devices attached to the dental engine. It is perfectly practicable, however, to make good gold fillings by any one of these plans of using mallet force. The main questions here are as to ease and rapidity of manipulation in the first instance, and, in the second, as to comparative ease of obtaining good results.

In many fillings, hand pressure should be used in the condensation of some particular parts to which mallet force is inapplicable. Mallet force can be applied successfully only in a direct line with the shaft of the instrument. In all cases in which it becomes necessary to apply force in lateral directions to the shaft of the instrument, hand pressure must be used, unless reverse motion with reverse pluggers can be substituted. This can be done in the more difficult positions in lower molars and bicuspids by judicious study of the capability of reverse pluggers. The filling of the incisal anchorage in incisor cavities requires almost uniformly the use of hand pressure.

The manner in which we now prepare cavities for filling

reduces the necessity for the use of hand pressure more than ever before, because of the very free access obtained. Convenience in placing the filling material should always be held strictly in mind in the preparation of a cavity.

THE RELATION OF THE SIZE OF PLUGGER POINTS TO THE APPLICATION OF FORCE.—A correct appreciation of relation of the size of the condensing area of the plugger point to the force used is of first importance in filling teeth with cohesive gold. The force that can be applied is limited by the capability of the peridental membrane to resist, and the possibilities of the use of more or less force will vary with the strength and endurance of the membrane. People who are accustomed to using their teeth very vigorously and have very strong peridental membranes, will bear much heavier blows of the mallet without inconvenience than those who habitually use their teeth more delicately, and, as a result, have weaker peridental membranes. All of this must be considered in filling operations and the force used limited accordingly. The requirements as to solidity and strength of fillings for different persons are of equal importance. Persons with strong peridental membranes, who use their teeth vigorously, require the strongest possible fillings. Persons who have weak peridental membranes and who habitually use their teeth feebly, will not require the same solidity and strength in the fillings in order that they may stand. In either case, however, the adaptation of the gold to the margins should be perfect, and in all cases, a density that will be moisture-tight is absolutely required. Because a patient can bear heavy blows of the mallet is no excuse for using a plugger of large impacting area, for the reason that such persons require very dense fillings. The consideration of the area of plugger points is presented under the heading, "Force of Blows." See also Figures 320, 321, 322, 323.

PLUGGER POINTS. With the simpler forms of cavities as more recently prepared, the plugger points may also be much simpler in the variety of forms of shanks and condensing area, Figure 324. The form of the impacting area or face of the point of pluggers may be round, square, parallelogram, or what is known as foot form. Each of these has uses in special localities. The parallelogram forms (two pairs in the illustration) are particularly suited for the wedging process in building against the walls of cavities. These pairs have the long dimension in the plane of the curve or angle of the shank (hatchet form) in one, and perpendicular to that plane (hoe form) in the other. By this arrangement, the long dimension of one or the other instru-

FORMULA NAMES OF PLUGGER POINTS AND RULES FOR THEIR MEASUREMENT.

(1) The size of the working face of the plugger is given in tenths of a millimeter as the unit, the length of the nib in millimeters, and the angle of the nib with the shaft in centigrades.

(2) If the plugger is round, the diameter is given, followed by the length of the nib, and this by the angle with the shaft, thus: 5-10-3. The name is, plugger 5-10-3.

(3) When the point has the form of a square or a parallelogram, both dimensions are given, thus: 12x6-6-10.

(4) When a pair is formed by placing the broad sides of the nibs in opposite relations to the angle of the nibs (see the first two pairs reading from right to left of figure) that dimension in the plane of the angle is placed first as 12x6-6-10 and 6x12-6-10. The first of these is the hatchet form, the second the hoe form.

(5) Foot pluggers have the working face on the distal side of the nib instead of on its end. They may be measured in the same way as others. The working face of the nib may be its full length or it may be shorter. Therefore, the working face of the plugger is given in the same way as other parallelograms. The distance of the toe of the foot plugger from the central line of the shaft is the length, and the angle of the working face with the shaft is its angle. This is illustrated by the three foot pluggers on the left in the picture. The full name will be, foot plugger 20x5-2-18, etc.

Ordinarily in naming plugger points, we may say plugger 5-10-3, plugger 10-10-3, or plugger 12x6-6-10, or for the last the term parallelogram plugger 12x6-6-10 is often used, but as the 12x6 gives the parallelogram form, this mention is unnecessary. In naming pluggers, the sub-class names may be used when necessary, as bayonet plugger 5-2, or the fuller formula would be 5-2-0, indicating that the nib is parallel with the shaft. There is generally no necessity for the mention of such sub-class names as monangle or contra-angle in speaking of pluggers, but these may be used when they seem necessary. It is, however, necessary to mention the name, foot plugger, because this form is not indicated without.

SPECIAL USES OF PLUGGER POINTS.

The round instrument, 5-10-3, in connection with the holding instrument, is used (see Figures 341, 342) for starting fillings in convenience points.

The round plugger, 7½-10-3, is used sometimes for starting fillings instead of the 5-10-3 and also for doing some portions of condensing gold.

The round plugger, 10-10-3, may be used in any position where a large condensing point is required, except in wedging against walls.

The parallelogram pluggers, 12x6-6-10, 6x12-6-10, are used especially for packing gold in mesial portion of mesio-occlusal cavities (see Figures 344, 347) and for doing the bulk of gold building in most of the proximo-occlusal cavities, including hand-pressure work in the distal portion of disto-occlusal cavities.

The parallelogram pluggers, 10x6-3-3, 6x10-3-3, may be used as smaller points in condensing against walls, as occasion may require in molars and bicuspid and for the bulk of the work in incisors.

A pair of larger parallelogram points, contra-angled, 14x8-6-10, 8x14-6-10, for use when large condensers may be used with the hand wallet, are recommended but not illustrated. Also a pair 12x6-3-3, 6x12-3-3, not illustrated.

The bayonet 5-2-0 can be of service occasionally in building against the labial wall of incisor proximal cavities, working from the labial.

The 5-3-23 and 5-2-23 are used by hand pressure only. They are intended especially for filling the incisal anchorage in incisor proximal cavities.

Foot pluggers, 20x5-2-18, 15x5-3-18, 15x5-5-12, are intended for use in reaching into the embrasures for condensation of gold along the buccal and lingual margins of cavities.

Back-action pluggers for distal cavities in lower molars and bicuspid, especially those with a lingual inclination. See Figures 325, 326, 327.

Direct quadrangle after condensers for gingival margins of proximal cavities in front teeth and of mesial cavities in back teeth. See Figures 328, 329, 330.

Reverse quadrangle after condensers for condensing gingival margins of distal fillings in back teeth. Figures 331, 332.

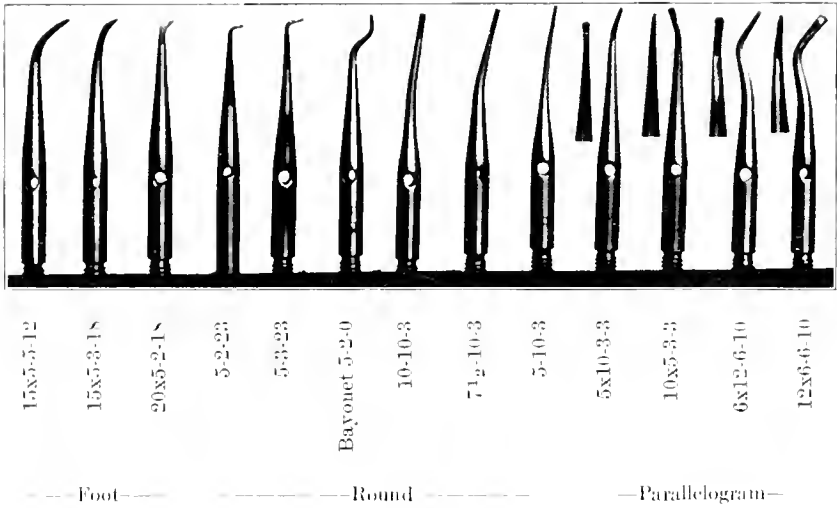

FIG. 324.

FIG. 324. The principal direct acting plunger points necessary for use in filling teeth, actual size. The figures placed below each constitute the formula name by which it is known, and give the size and form of the nib or working point.

ment of the pair can be brought parallel with the plane of any wall of a cavity. The dimensions 10x5-3-3 and 5x10-3-3, are particularly suited for use in proximal cavities of the incisors. Those of the dimensions 12x6-5-10, 6x12-5-10 have the shank contra-angled, suiting them especially to the building of gold in proximal cavities of the bicuspids and molars, which will be more fully explained later. See Figures 344, 347. Both of these pairs have the face rounded, or convex, on the longer dimension for the purpose of severe packing of gold without chopping into it. By rounding this dimension, the first impression on a fairly solid bit of metal is on a limited area of the face of the point, but immediately this gives way, a larger area is engaged which prevents it from sinking deeply into the metal. Of the three round points, the 5-10-3 is especially suited to starting fillings in small convenience points, and for special uses by hand pressure, or for any purpose when severe condensation with light pressure is desirable. The area of the point — .196 square millimeters — is too small for use in the general building of gold. The 7½-10-3 has a greater area — .44 square millimeters — and may be used in the larger convenience points. It is suited to some positions of general building of gold in the work in incisor teeth, and, occasionally, in other positions when the stepping process in building against walls is not necessary. The 10-10-3 (round) may be similarly used in general gold building in bicuspids and molar cavities in which heavy malleting may be employed. This plugger face — .78 square millimeters in area — is the largest plugger point that should be used in the automatic mallet. With the hand mallet used by an assistant, more force may be employed, and, in a few selected positions, an instrument with a larger area might be used. The area of the parallelograms 12x6 and 6x12 is .72 square millimeters. A pair of parallelograms 14x8-6-10 and 8x14-6-10, with an impacting area of 1.12 square millimeters (not included in the illustration) is desirable where much non-cohesive gold is used in proximal cavities in bicuspids and molars, especially for placing and the first slight condensation of the non-cohesive gold. In especially favorable cases, these may be used with very heavy blows of the hand mallet in gold building. The area is too large, however, for general use. Also a pair of points 12x6-3-3 and 6x12-3-3 (not illustrated) are very excellent instruments for much of the gold building on approaching margins in occlusal surfaces.

The bayonet form will sometimes allow a better angle of

blow to be used along the labial walls of incisors when working from the labial. For this purpose it is important. Elsewhere it is not of especial use. The curve of the shank gives considerable spring to blows and limits its impacting force.

The pluggers with 23 angle are used for filling the incisal retention points in incisor proximal cavities, and occasionally in positions where access with other points is impossible in other cavities. In this use, hand pressure only is employed. With their small impacting area — .196 square millimeters — a very solid filling can be placed in this rather awkward position.

The foot pluggers are especially for after-condensation. By the phrase "after-condensation" is meant that condensation of the surface of a filling which is done after the filling has been built, especially on proximal surfaces. In this position it is often best to leave these surfaces a bit ragged, with more or less gold imperfectly condensed overhanging the area proper of condensation in the work of building. This is best caught up and condensed with a foot plugger afterward. Much of this work would be difficult to reach with the other instruments. Therefore, these are made in the form shown so that with them one may reach well into the interproximal space and condense with the toe of the plugger. The shorter foot, 20x5, is often valuable for building over margins, though generally margins should be built over with the same plugger used in the general gold building. Its full area is one square millimeter when the whole area of the foot comes into play, which will occur only occasionally. Notice that the shank of this is perfectly straight. There will be no spring limiting its blow. It is, therefore, a dangerous instrument to bring in contact with an enamel margin. An ample amount of gold should always separate it from actual contact with margins over which it is used.

BACK-ACTION AND QUADRANGLE PLUGGERS. The back-action instruments for packing gold have the points recurved or bent in a half circle or equivalent angles so that the point is parallel or nearly parallel with the shaft. The opposite end is also recurved so that the mallet strikes the instrument backward, or in the opposite direction from the ordinary direct-action instruments. These are shown in Figure 325, the mallet end and the plugger end only appearing in the illustration. The total length is from twelve to thirteen inches. This extra length is to give room for the hand of the operator and also for the swing of the hand mallet alongside the shaft.

These instruments are used in packing gold in distal and



FIG. 325.

FIG. 325. Reverse pluggers, used with backward or reverse strokes of the mallet in filling distal cavities in lower molars and bicusps, especially those having a lingual inclination. The full length of the reverse pluggers is twelve to thirteen inches.

occlusal cavities in the lower molars, and in these their use is limited almost entirely to packing against the buccal and mesial or axial walls. The position of these in use is shown in Figures 326, 327. As the instrument is much longer and heavier than the ordinary direct-acting instrument, and also on account of the curve of the point, a much heavier mallet stroke is required to accomplish a like result. Most persons will find these instruments very awkward when first beginning to use them, but with a little experience in handling them and in learning their position in use, they become convenient and effective in positions that are very difficult when only direct-action instruments are used.

It is in lower molars or bicuspidis with a strong lingual inclination that their use gives the greatest relief. One is not compelled to remove so much tooth structure toward the buccal and mesial to gain convenience form, the preparation of the cavity is easier, and the packing of the gold is accomplished with greater facility. This group of instruments really takes the place of much of the hand-pressure work that is required in the cavities named, and will do the work easier for both patient and operator and do it more perfectly.

The quadrangle instruments are designed especially to relieve one of the difficulties that occur from the use of the Perry separator; or the modification known as the universal Perry separator. In the use of this separator, it is often found difficult to so place foot pluggers as to get the toe of the plugger in position for a direct stroke on the surfaces of mesial or distal fillings for the final condensation of the surface after the filling has otherwise been placed, because the bows of the separator interfere. Further, it is desirable that we become able to pass the toe of the foot plugger fully to the bucco-lingual center of the interproximal space in such form as to get a direct blow of the mallet on the gold in its final condensation. These instruments are made in both the direct-action and the back-action forms, and, although they have been used for more than twenty years by the author and a few others, they have not been long in the market.

Figure 329 shows the point and shank only of this instrument as made for the direct blow. There are four angles in the shank, hence the term "quadrangle." They are in such form that the instrument will pass around the bow of the separator and reach into the interproximal space in form to admit of a direct blow, keeping the instrument point sufficiently near the line with its shaft. The immediate point is shown in two posi-

tions in order that its form may be better understood. It is made in rights and lefts.

In Figure 328 one of these instruments is shown in action, condensing a filling in the mesial surface of the left central incisor, with the separator in position. Particular attention is called to the grasp of this instrument. Otherwise than in the form of its shank, it does not differ materially from other foot pluggers or condensers used with the hand mallet. The number of its angles, however, requires that a much heavier blow of the mallet be used than with pluggers that have less crooks and turns in their shanks. This instrument can be used upon mesial surfaces and distal surfaces in the incisor teeth, and is capable of use on all mesial surfaces in the bicuspid and molars, but not upon the distal surfaces of bicuspid and molars.

In Figure 330 the instrument is shown in action on the buccal portion of the mesial surface of a second lower molar, and incidentally an excellent illustration of a half-inverted pen grasp. The other instrument of the pair may be introduced from the lingual as well, and with the two every part of the proximal surface of the filling can be reached and condensed.

A pair of back-action quadrangle instruments — rights and lefts — are fashioned on the same plan, the points of which are shown in Figure 332 in two positions to better exhibit their forms. The shafts of these are of the same form and length as the other back-action instruments. In Figure 331 one of these is shown in position condensing the distal surface of a filling in a lower first molar, the separator being in place. It is easily applicable to all of the distal surfaces of the bicuspid and molars of both the lower and upper jaws.

These quadrangle instruments are not used at all for gold building, but only for the condensing of the proximal surfaces of fillings after they have otherwise been completed with other instruments. Their use is more particularly desirable when considerable non-cohesive gold has been used in the gingival portion of the cavity. The form of the point is such that the toe can be used effectively fully to the bucco-lingual center of a molar tooth, the one entering from the buccal and the other from the lingual. Therefore, every part of the gingival portion of any proximal filling can be reached and condensed. This does much to insure these fillings against leakage from any imperfection in the packing of the gold in the first instance.



FIG. 326.

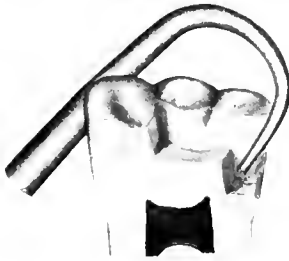

FIG. 327.

FIG. 326. A photograph showing the position of the reverse plunger in use, including the mallet and mallet hand of the assistant.

FIG. 327. A split lower molar with prepared distal cavity, showing the relation of the working point of the reverse plunger to the cavity walls.



FIG. 328.

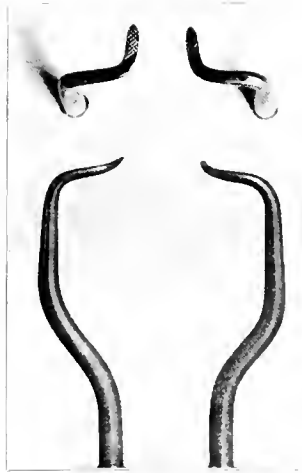

FIG. 329.

FIG. 328. The direct-stroke quadrangle plugger as shown in use by photography, including the mallet as used by an assistant. The instrument is shown in the act of condensing the gingival portion of a filling that has been placed in the mesial surface of a central incisor. The curves of the shank enable one to obtain a direct stroke on the gingival portion of the filling while the separator is in place. It is used only for after-condensation.

FIG. 329. Photographs of the points and shanks of the direct quadrangle pluggers, rights and lefts, end view and side view.



FIG. 330.

FIG. 330. A photograph of the direct quadrangle plugger in action condensing a filling in the mesial surface of a molar while the separator is in place. With this pair of instruments one is able to obtain a direct stroke over any portion of the mesial surface. The picture also gives an excellent exhibition of a half-reversal pen grasp.



FIG. 331.



FIG. 332.

FIG. 331. A photograph of the reverse quadangle plunger in action condensing the distal surface of a filling in a lower molar with the separator in place. Notice the relation of the mallet to the recurved mallet end of the shaft of the plunger.

FIG. 332. A photograph of the working points and curves of the shanks of the reverse quadangle plunger.

SEPARATING TEETH.

In filling proximal cavities in which the proximating tooth is present, provision must be made before the filling is begun for finishing the proximal surface of the filling. If the teeth originally made a close contact, it is necessary to separate them or lift them a little apart in order that we may finish the proximal surface of the filling to the full mesio-distal breadth of the tooth and restore the contact point in correct form, preserving the full breadth of the interproximal space. This is necessary to the maintenance of the health of the interproximal gingivæ, the gums, the peridental membranes and the teeth. If the contact of the filling with the proximating tooth is not made in correct form, food will be held between the teeth and will be crowded upon the interproximal gum tissue, causing inflammation and absorption, and finally injure the gums and peridental membranes, perhaps causing incurable disease of the peridental membranes and final loss of the teeth. Or, by forming a pocket in the gum tissue about the gingival margin of the filling, in which débris undergoes fermentative decomposition with acid formation, cause recurrence of decay. The manner of the recurrence of these conditions has been fully stated elsewhere. These considerations, derived from careful clinical observation, render it imperative that we make provision for finishing proximal surface fillings to very exact form by first separating them sufficiently to give room to do this work. Lack of attention to this requirement has caused the loss of many otherwise good fillings.

In all ordinary cases, the separation of teeth to gain room for finishing is done best by the use of the Perry separator. The more recent Perry general separator does equally well. This instrument simply catches the two teeth by their necks and lifts them apart by turning a screw. The separation required is done with the least pain possible, is done usually in a few minutes and without causing especial soreness of the teeth at the time or afterward. Generally, the separator should be applied before the filling is begun and the teeth separated sufficiently. Occasionally, and especially with the molar teeth, when the teeth are very firm, they are difficult to move sufficiently. If, in such cases, the separator is forced very tight, the instrument springs instead of separating the teeth. But when it is allowed to remain and the filling is proceeded with, it is found that when the filling has been built, the teeth are separated sufficiently for the finishing. The continuous spring force of the separator has

caused them to yield gradually. We should make note of this and be careful not to force the separator too hard upon the single-rooted teeth, for, if we attain the full separation required at once, we will find, when the filling is completed, that we have separated the teeth much more than was necessary. This should not be done.

The Figures 333, 334, 335, represent the general Perry separator, which at the present time is the best device for separating teeth. When properly adjusted, the slender claws shown in the center in Figure 333, closed, are placed between the necks of the teeth while the bows go over the teeth from labial to lingual, or from buccal to lingual on the back teeth. The teeth are then lifted apart by turning the separating bars, giving each two or three quarter turns alternately. The nuts on the bars which form the bows which move the claws bucco-lingually, as shown by comparison of Figures 333 and 334, will be called the adjustment nuts. They are used in fitting the claws to teeth of different sizes. For instance, when adjusted, as shown in Figure 333, the claws may be placed between the necks of small central and lateral incisors. For adjusting to large central incisors, the ends of the claws would need to be separated a little in the direction shown by comparing Figures 333 and 334, or labio-lingually. For adjusting to the molars, the movement in this direction must be considerably more. The movement necessary is never quite so much as that shown to be possible by comparison of Figures 333 and 334. This adjustment must always be made and corrected by trial on the two teeth to be separated, before beginning to separate the teeth.

The two separating bars move these claws back and forth mesio-distally, as shown by comparison of Figures 334 and 335. The separator is always to be placed on the teeth with the shorter bar to the lingual. Generally the separator is placed with the claws closed fully together by the separating bars, as seen in Figures 333, 334, but occasionally they may be separated a little before putting it on. By turning the separating bars in the direction shown by the little arrows, the claws are forced apart, separating the teeth. First one bar should be given two or three quarter turns and the other the same number. This is done with a wrench supplied with the instrument. If one bar is turned much more than the other, it causes the screws to bind and to work hard.

When the separator is applied, if the bows do not rest firmly upon the incisal or occlusal surfaces of the teeth without

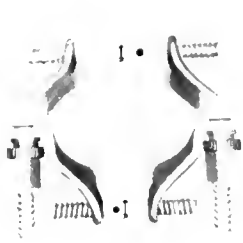

Fig. 333.

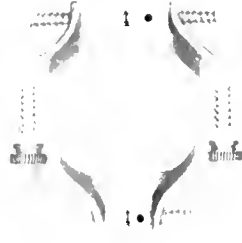

Fig. 334.

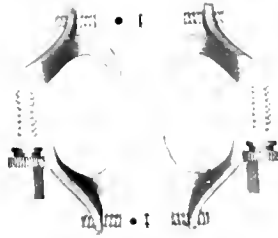

Fig. 335.



Fig. 336.

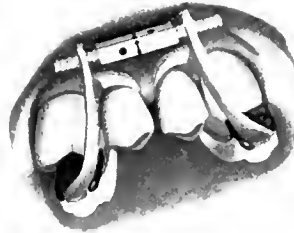

Fig. 337.

Figs. 333-337. A series of illustrations of the Universal Perry Separator.

FIG. 333. The separator as arranged for the smallest teeth, or with the points closed together in both directions.

FIG. 334. The separator opened full width bucco-lingually by turning the adjustment nuts. By means of these nuts the adjustment for the fitting of any size of tooth is made before the separator is applied.

FIG. 335. The separator opened, also, a little more than half its full width mesio-distally by turning the separating bars. After the separator has been adjusted to the teeth, these separating bars are turned until sufficient separation is made.

FIG. 336. The separator applied to the bicuspid. In this case the points or claws impinge on the soft tissues at the necks of the teeth; it must be loosened at once and the separator propped up, as shown in Figure 337.

FIG. 337. The separator is propped up with gutta percha, modeling compound or other suitable substance placed on the occlusal surfaces of the teeth under the adjustment bars, preventing the separator from slipping gingivally and injuring the gums. The teeth are shown separated.

the claws impinging on the soft tissues, as is shown in Figure 336, they should be made firm by propping them with gutta-percha, or modeling compound. To do this, the gutta-percha or modeling compound is softened by heat and placed between the bows of the separator and the incisal or occlusal surfaces of the teeth, and a little time allowed for it to harden before finishing the separation. These props are shown in Figure 337 with the teeth separated. They should be placed at once when the separator has been made just tight enough to retain its position well, for, in the after tightening of the screws, there is a tendency for the claws of the separator to slip farther to the gingival, and, coming against the attachment of the peridental membrane at the neck of the tooth, cause unnecessary pain and some injury. The props also prevent movements of the separator while operating, which, when neglected, cause the patient much pain and inconvenience. When the separator is in place and the teeth strained apart, it should be set so firmly as not to be easily moved by placing the fingers on it.

The principal objections to the Perry separator are, first, in the sets of six, as usually sold, there are not a sufficient number of forms to accurately fit all kinds of cases and twice that number are necessary to make a satisfactory set; second, they are very expensive instruments; and, third, there are many irregular cases with teeth so out of position that they can not be made to fit. This last objection will naturally attach to all mechanical devices for this purpose. The general Perry separator described above answers the purpose of the set of six very well and obviates the necessity of purchasing so many instruments. It is a little more clumsy in use than the other instruments, and, at first, its adjustment seems more awkward. However, when one has attained some skill in its use, it will be found to fit more places than the whole regular set of six. It is, therefore, the better instrument to use. Sets of twelve of the older form are made on special order and are certainly very convenient instruments. The principal point in the use of the general separator is to learn to adjust the points, or claws, to the right width for the particular case in hand. When this has been done, its use is not more difficult than the use of any one of the set of twelve. The most real difficulty with the instrument is: (1) that the crowns of some teeth are too long for the claws to reach the right point on their necks, (2) that in other cases the teeth are so short that the claws reach into the soft tissues. This makes it necessary to prop them up to prevent pain and

injury, as has been described. We need two more of these general separators; one with a longer reach by the width of the claw, and another with a shorter reach by the width of the claw. This would make the instruments almost ideal. With the single instrument now sold, its reputation is continually being marred by persons placing it without attention to propping up the bows. At first a device was attached to the instrument intended to take the place of the gutta-percha for propping it up, but it failed to work in so many cases and was so much in the way that the instrument is now sold without it.

When the teeth are very irregular in the arch, other means of separation often have to be devised. Wedges of wood may sometimes be used, or cotton can be crowded tightly between the teeth and tied over, or about, the contact point with a ligature and accomplish a sufficient separation within a few days. Slips of rubber may be drawn between the teeth and the ends cut short; this is a very effective method of slow separation, but is apt to make the teeth very sore. In using rubber for separating, great care should be had that the rubber does not press upon the gum septum. This not only creates unnecessary soreness, but is liable to do great injury to the gum septum.

A method that is excellent for very slow separation in the bicusps and molars, is to excavate the cavity roughly and moisten its surfaces with eucalyptol to make the gutta-percha adhere to the walls, and then fill it solidly with gutta-percha, filling the interproximal space solidly against the approximating tooth. In doing this, a flat instrument, such as a burnisher or gold finishing knife, should be placed firmly in the interproximal space to protect the gum septum while the gutta-percha is being packed, and afterward the instrument may be removed. This will prevent absorption of the gum septum by the continued pressure of the gutta-percha. This point should never be neglected, as a full gum septum is necessary to the health of the parts, and it should be carefully protected against injury. When the patient is discharged temporarily, he should be directed to make vigorous use of the tooth in chewing. The impact of the food will cause the gutta-percha to spread and carry the teeth apart sufficiently within a week or two. This is a very effective method of slow wedging in cases in which the teeth have dropped together from loss of the contact point, and has the merit of moving the teeth without creating soreness. But it must be remembered that the teeth are separated only by expanding the gutta-percha by heavy chewing upon it. If the patient does not

chew upon it, it will fail to separate the teeth. Obviously this plan can not be used where there is no tooth in the opposite jaw that will occlude on the gutta-percha.

In cases requiring much movement, it can be hurried a great deal by first putting on the Perry separator and lifting the teeth apart as much as practicable and making the gutta-percha filling, as indicated above, giving sufficient time for the gutta-percha to become fully hard before removing the separator. This may be repeated at intervals of two or three days until sufficient separation has been obtained to fully restore the width of the interproximal space and mesio-distal breadth of the tooth.

In cases of decay in which the contacts have been lost and the necks of the teeth allowed to drop together, the occlusion has often become adjusted to the abnormal form. Justice to patients demands that these be restored to their normal positions. It is frequently necessary to move these teeth very slowly so that the occlusion may become readjusted without violence or annoyance to the patient. In some of these cases, this is readily done with gutta-percha, as described above. In those cases in which this is not available or proves ineffective, it is readily done by the intermittent use of the separator followed by gutta-percha fillings.

It occasionally happens that a tooth has lost the greater part of its crown, and the teeth on either side have dropped together over it, so that the restoration of the form of the crown is impossible without a very considerable separation. In this case the breadth of two interproximal spaces is to be recovered by separation. If the lingual and buccal walls are still sufficiently strong, it is possible to accomplish this with gutta-percha; but when they are not, it is better to cut away most of the remaining portions of the crown and insert a piece of hard, dry, hickory wood in place of the missing crown in such a way that the length of the grain of the wood shall be from buccal to lingual. This should be cut to fit snugly between the two teeth on either side and forced into position. It will absorb moisture from the saliva and swell and slowly carry the teeth apart. The wood should be exchanged for a new piece once in two or three days and continued until space is gained for the restoration of the full mesio-distal breadth of the crown. This plan is especially useful in gaining the necessary space for restoration with artificial crowns, as well as in building up badly decayed teeth with metal. Recently a few general separators have been provided with long bars which permit them to be used to move the teeth from either side of

a tooth found in this condition. This arrangement simplifies this matter greatly and it is desirable that the manufacturers find sufficient encouragement to place these in their general list of supplies. For this purpose, two extra bars should be provided. The first one should be enough longer than the labial bar usually sold that it (the present labial bar) may be used as the lingual bar, and the new bar used as the labial bar. The change requires that the two bars be screwed out and the exchange made as stated. The second additional bar would work as the labial bar with the first additional bar as the lingual bar, making the extension so much greater. Much the better plan, however, would be to have the additional separators with the long bars complete.

FILLING CAVITIES WITH GOLD, BY CLASSES.

CLASS 2. PROXIMAL CAVITIES IN BICUSPIDS AND MOLARS.

ILLUSTRATIONS: FIGURES 338-364.

NOTE. The technic of filling cavities of the first class is largely included with that of the second class, therefore the filling of cavities of the second class is presented first.

CASE. MESIO-OCCLUSAL CAVITY. For the purpose of explaining the principles involved and the technical procedures step by step, a rather broad, squarely cut mesio-occlusal cavity has been chosen for the better opportunity of illustration. This is shown in Figure 340, and is the first of a series prepared for this purpose. With the exception that the step of the cavity has been cut broader toward the mesio-buccal cusp to facilitate illustration, it has been prepared as has been directed in the article on preparation of cavities of the second class. The rubber dam is supposed to have been placed before the cavity walls were finished, and the necessary separation made.

STARTING THE FILLING WITH COHESIVE GOLD. The gold in the form of pieces of rolls, pellets, blocks or cylinders should be ready on the tray, or on the annealing slab, if that form of annealer is used. The instruments necessary should be on the bracket. These should be: the foil pliers or carrier; the holding instrument; the plugger 5-10-3 or 7½-10-3, or both; the 12x6-5-10 and 6x12-5-10, Figures 324 and 341.

Begin the filling in the most convenient angle of the cavity. In this particular cavity this will be the linguo-axio-gingival angle. With the holding instrument in the left hand and the plugger 5-10-3 or 7½-10-3 in the right, try them together in the cavity to see that the position is right, and make any necessary corrections. (See Figure 51, finger positions.) Take up the gold with the foil carrier, place it in the cavity and catch it with the holding instrument. Then exchange the foil carrier for the round point plugger determined upon, and with the two instruments bunch the gold into the convenience point, as shown in Figure 342. Usually it will be best to begin the condensation with hand pressure, especially if the plugger 5-10-3 is used, changing to mallet blows later. Be careful in the beginning that the gold is carried before the plugger point instead of the plugger point punching through it. If this first piece seems large enough to fully fill the convenience point, condense it very thor-

oughly; if not, add more before making complete condensation. When this is done, pack a mass of gold on the first, filling the angle somewhat as shown in Figure 343. If the convenience point has been properly made, the gold built in will stay in place. Remember that if the bottom of the convenience point is round, as made with a round bur, this first piece of gold will roll and be loose; but if the bottom is well squared, and the angles with the walls are sharp, as made with an inverted cone bur, this first piece of gold will remain firm. Then the bucco-axio-gingival angle may be filled in the same way. This, however, calls for a change to a partial cross mouth position, something similar to those shown in Figures 59 and 61 (finger positions) which is usually easy enough to attain if the mouth is opened widely. Sometimes it may be found necessary to do this with a contra-angled instrument. When the gold has been packed into this angle also, the 5-10-3 or 7½-10-3 should generally be changed for the parallelogram plugger 6x12-5-10, Figures 324, 344, for building across from one point angle to the other along the axio-gingival line angle as shown in Figure 345. Sometimes it may be preferred to build along this angle to the bucco-axio-gingival angle before filling this latter convenience point, keeping the holding instrument in position on the gold while so doing. Then the immediate angle is filled, as before described. The choice in these plans will be purely a matter of convenience in the particular case.

THE ANGLE AT WHICH THE CONDENSING FORCE IS APPLIED toward the plane of the wall is very important in making perfect adaptation. The direction of force should never be perpendicular to the plane of the wall that is being covered. Whenever possible, the angle of force should be inclined as much as twelve centigrades from the perpendicular to the plane of the wall. In adapting gold to the surrounding walls in an occlusal cavity, or to the buccal and lingual walls of a proximo-occlusal cavity, the direction of force should be inclined toward the wall, if possible, as much as six centigrades. It is quite possible, however, by using the wedging principle, to secure good adaptation if the angle of force is parallel with the wall.

THE WEDGING PRINCIPLE. The stepping of the plugger should always be from the central part of the mass of gold toward the walls, and the last condensation of each individual piece of gold added should be along the wall being covered.

This rule is practically universal to filling with cohesive gold, except when condensing a piece laid upon central parts

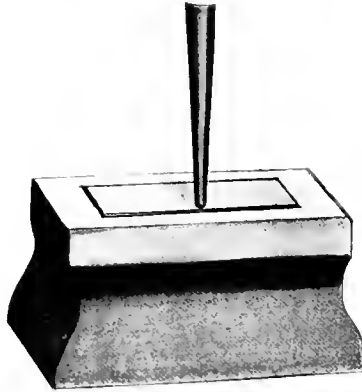

FIG. 338.

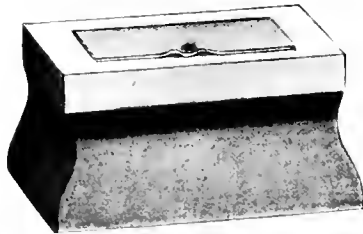

FIG. 339.

FIGS. 338, 339. A representation of the nature of the difficulty in the condensation of gold in a direction perpendicular to the wall of a cavity, with special reference to filling with cohesive gold against the gingival walls of proximal cavities in bicuspids and molars. In Figure 338, a perfectly plane piece of gold plate is laid on an anvil and an instrument placed as shown. This is struck a blow that will bruise the metal plate. In Figure 339 the metal plate is curled away from the surface of the anvil on all sides of the instrument point. No amount of hammering will bring it again to the perfect fit. This will be the result in any effort to condense a thin sheet of gold against any cavity wall by pressure perpendicular to that wall. See Figures 344, 347, for the method of avoiding this difficulty.

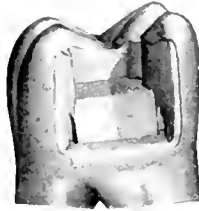

FIG. 340.

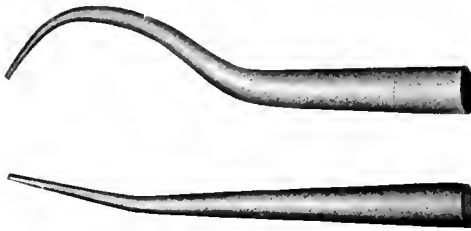

FIG. 341.

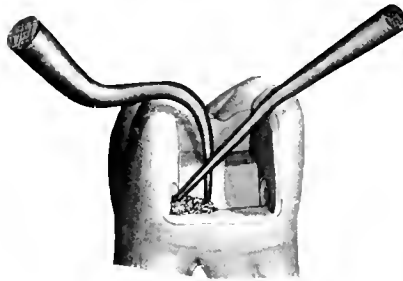

FIG. 342.

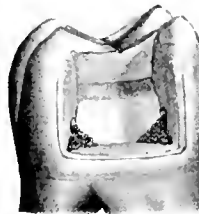

FIG. 343.

FIGS. 340-355. A series illustrating the building of all cohesive gold fillings in mesio-occlusal cavities in the bicusps and molars.

FIG. 340. An upper molar with a prepared mesio-occlusal cavity, showing the convenience points in the axio-bucco gingival and axio-linguo gingival angles.

FIG. 341. The plugger and holding instrument for the starting of gold fillings.

FIG. 342. The use of two instruments in starting cohesive gold fillings. The holding instrument has its shank in such form in relation to the axis of the shaft that its point is just enough above the center so that it will always set up in the position wanted when the shaft is laid across the finger and the point is dropped on a table. This form requires the minimum of care in holding the instrument steady in the position in which it may be placed while doing other work with the right hand. It also illustrates the beginning of the filling in the convenience point.

FIG. 343. The cavity with both convenience points filled.

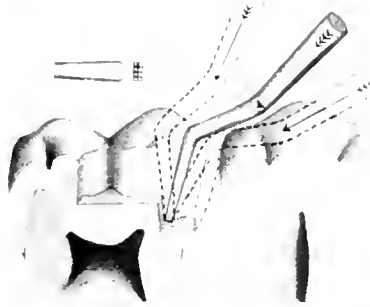

FIG. 344.

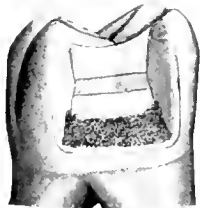

FIG. 345.

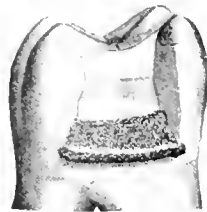

FIG. 346.

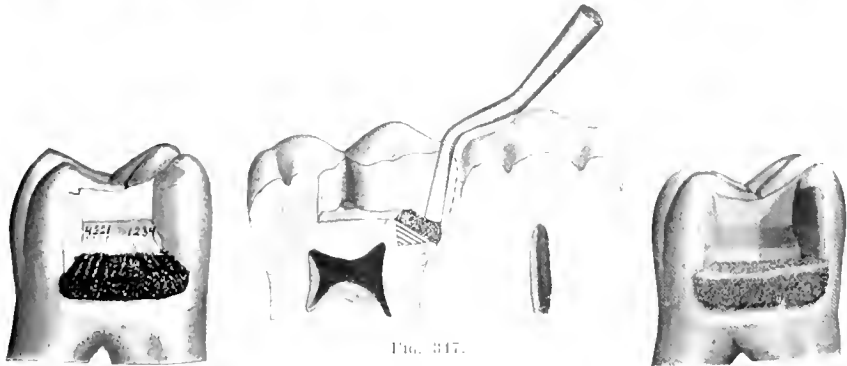

FIG. 347.

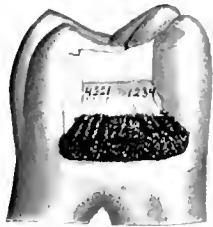

FIG. 348.

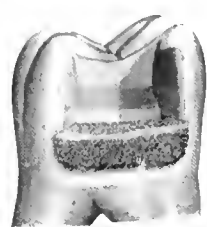

FIG. 349.

FIG. 344. The plunger 6x12 6 10 (Figure 324) in position in the mesial portion of the cavity for condensation of gold against the axial and gingival walls and building across connecting the convenience points. The arrows and the dotted outlines show the directions at which force may be applied. The broad side of the end of the plunger and an illustration of its face are shown just above the molar tooth.

FIG. 345. The gold has been built along the axio-gingival line angle connecting the beginnings in the two convenience points.

FIG. 346. The building has been continued about equally on the axial and gingival walls until the cavo-surface angle of the gingival wall has been covered. In doing this, there has been a very solid mass of gold to build against in covering the last part or margin of the gingival wall.

FIG. 347. Another view of the split cavity after the gingival wall has been covered. The diagonal lines show the order of the building of the gold by which it is progressively brought out to the margin of the cavity. The plugging instrument in place is the 12x6-6 10, Figure 324, the flat sides of which are right for building against the buccal and lingual walls, and over the cavo-surface angle of the gingival wall.

FIG. 348. Illustration of the stepping of the instrument in building against walls of cavities. Having laid a mass of gold—cylinder, block or rope—so that some portion will come against the cavity wall, form first a line of steps of the plunger point, as shown by the figure 4, i. e., on the portion of the gold farthest from the cavity wall. The next line of steps, 2, is then made, then 3; finally the last condensation of that piece of gold is along the cavity wall, as represented by the figure 4, condensing this last gold between the cavity wall and the gold already condensed.

FIG. 349. Represents the mesial portion of the filling squared up and the surface made horizontal. This should be done at once after the gingival wall has been fully covered.

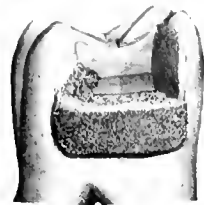

FIG. 350.

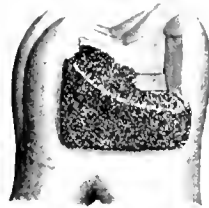

FIG. 351.

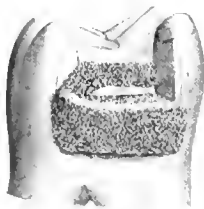

FIG. 352.

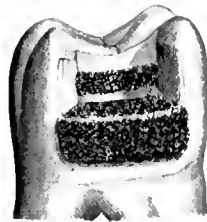

FIG. 353.

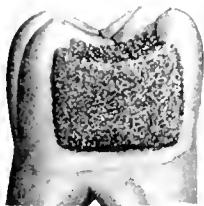

FIG. 354.



FIG. 355.

FIG. 350. A plan of building into the step by following the linguo-pulpal line angle.

FIG. 351. Continuing to build against the linguo-pulpal angle covering the lingual and pulpal walls progressively. This is sometimes a convenient method.

FIG. 352. A method of building across along the disto-pulpal angle, producing an independent anchorage in the step portion from which to build mesially.

FIG. 353. In this case a new beginning is made in the step portion, practically in the same way in which the filling was begun in the mesial portion. Any of these plans of building into the step may be used; one will be the more convenient in one case, another in another case.

FIG. 354. The building of the filling completed.

FIG. 355. An illustration of the lamination of the gold. This may be divided into sections thus: (1) The gold is constantly driven against the gingival and axial walls, filling the angle formed by these two walls until the gingival margin is fully covered. This produces the diagonal layers marked. (2) The gold is then leveled up and the surface made horizontal. (3) The building in the step, no matter by what method, produces diagonal layers, as seen on the pulpal wall. (4) The remainder of the filling is done by force perpendicular, or nearly so, to the long axis of the tooth, producing horizontal layers.

of the filling, no portion of which is condensed against a wall of the cavity. When the stepping of the instrument is toward the wall, finishing the condensation against the wall, the last of the gold is wedged between the wall and that last condensed, thus securing perfect adaptation to the wall. If, on the other hand, the condensation is begun at the wall, the tendency is to pull the gold away from the wall in moving from it in the condensation of the remaining portions; and to make imperfect adaptation.

In condensing each piece of gold added, the stepping of the plugger point should be in a regular order, moving only the width of the condensing point at each step, condensing every portion of the gold. Regular lines of movement or stepping should be formed generally parallel with the wall that is to be approached, finishing the condensation along the wall. Such an order of work, pursued with regularity, secures speed in operating, evenness of the general condensation, and accuracy of adaptation of the gold to all parts of the cavity walls and margins. This is illustrated in Figure 348. Blocks, cylinders or pellets are laid on the surface of the gold against the buccal wall and against the lingual wall. In condensing each of these, the plugger is stepped in regular lines, each step being the width of the plugger point. The next line is the width of the plugger point closer to the wall being approached and the final line of steps forces the gold between the wall and the gold that has been condensed. This is shown by the numbers 1, 2, 3, 4, placed at the ends of the lines of plugger steps in Figure 348. The beginning is on line one and the completion on line four against the wall. In this way gold may be wedged so tightly between parallel walls of a cavity as to condense the elastic dentin walls and bring a permanent and powerful grip of the cavity walls upon the filling. This should be used at all points when the building is between parallel walls, for (1) the increased perfection of the adaptation; (2) for the increased resistance to movement which the grip of the elastic dentin on the gold gives to the filling. It is not possible to use this in its full meaning and effect on a wall situated as the gingival wall of proximo-occlusal cavities, because such a line of force resisted by a directly opposing wall is not attainable.

To attain the desired results in the highest degree, the condensation along the cavity wall should be sufficiently increased to spread the condensed gold laterally with considerable force. This may be done, (1) by increasing the mallet pressure; (2) by

an additional number of blows; (3) or by repeating the line of blows with a smaller instrument point. No other means is known by which a filling can be made so rigidly secure in its seat in a cavity as by this plan of wedging between parallel walls. Undercutting or dovetails will not increase its rigidity.

When reduced to its ultimate terms, there are, in the boxlike cavities as we now form them, but three conditions in building gold against the walls of cavities: (1) Building against walls with force directed at a right angle to the plane of the wall, as one is tempted to do on pulpal and gingival walls because of the relation of their planes to the lines of approach. This is inadmissible. (2) Building between parallel walls with the direction of force in the line of the plane of the walls or slightly toward the walls. This is attained in the greatest perfection (a) in small convenience points or grooves in which driving the gold directly in will wedge it against both walls at the same time; (b) against the surrounding walls of occlusal cavities in which the gold may be continuously wedged between the walls and the body of condensed gold; (c) against the buccal and lingual walls in the step portion of proximo-occlusal cavities by wedging between these and the mass of condensed gold. (3) Building gold (a) into right-angle point angles with three walls to build against, using force at $12\frac{1}{2}$ centigrades to the plane of each of the walls, as in Figure 343; (b) building gold into right-angle line angles with two walls to build against, as shown in Figure 345, and in cross section in Figure 347. It will be sufficiently manifest that the building under the third condition is less secure than in the second condition. In all of the planning of cavities, every use consistent with other necessities should be made of building gold between parallel walls.

COVERING THE GINGIVAL WALL. In Figure 344, the position of the plugger 6x12-5-10 is shown together with the angles or directions of force that may be employed. In packing gold upon the gingival wall of any proximal cavity, it is especially important that the principal angle of force shown in this illustration be used. The contra-angle of the plugger has been formed purposely for reaching over the bicuspid, as shown, to obtain these lines of force and to avoid a line of force nearly perpendicular to the gingival wall. In building along the line angle from one point angle to the other, the gold should be kept well bunched along the angle; and particularly it should not be spread over the gingival wall toward its cavo-surface angle faster than the

gold covers equally the axial and gingival walls in a solid triangular mass, as shown by the lines in the split cavity, Figure 347.

In no case should there be any attempt to spread a thin layer of gold on the gingival wall, or any other wall of a cavity, and condense it in a thin sheet. Any such attempt insures a failure of perfect adaptation. Always secure a thick mass of gold along a line angle, in this case the axio-gingival line angle, and build out on the wall gradually. As each new piece of gold is added, most of it should be placed in contact with the mass already condensed, and only a little should be in contact with the cavity wall. By this plan there is never a thin layer of gold as the building progresses over the wall, and the margin will not curl away from the wall as it is condensed.

The management of the gingival wall in proximal cavities, especially in the bicuspid and molars, has always been the great stumbling-block in filling operations. It is confessedly the most difficult point at which to secure perfect adaptation of gold, or indeed, any other filling material. In part, this difficulty has been from imperfect preparation of this wall, but the real difficulty in securing adaptation lies in the fact that the tendency is to apply the condensing force in a line perpendicular to the plane of that wall. To make perfect adaptation, it is necessary that the angle of force be inclined as much as twelve centigrades to the plane of the wall, or directly into the angle formed by the gingival and axial walls.

In mesial cavities in bicuspid and molars, this is easily accomplished by using the contra-angled pluggers, which are made for this especial purpose (6x12-6-10 and 12x6-6-10). These instruments will reach over the proximating tooth and give the correct angle of force. The filling is begun in the convenience points, and connected along the axio-gingival angle, as has been described. Then the building proceeds with the contra-angled pluggers about equally upon the axial wall and the gingival wall, extending slowly over the gingival wall until its cavo-surface angle is reached and has been built over, always keeping a thick margin of gold to build against while covering the wall and cavo-surface angle. During this building, the plane of the surface of gold being built should be inclined about twelve centigrades toward the long axis of the tooth, one margin of this plane being upon the gingival wall and the opposite margin against the axial wall.

Any attempt to cover the gingival wall of a cavity with cohesive gold, using force perpendicular to the plane of that

wall, or very nearly so, as generally seems most convenient to do, very certainly results in failure to make close adaptation. This is illustrated in Figures 338, 339. A piece of perfectly flat plate is laid on an anvil and is seen to fit the surface perfectly, as in Figure 338. An instrument point is placed on the margin of the plate and struck a sharp blow that is sufficient to indent the metal. The result is shown in Figure 339. The portion of plate under the instrument point has been stretched, or pushed to either side, and the metal has curled up on either side and around it and is no longer in close adaptation. The more it is hammered in the effort to get it back, the more the plate is hardened, its elasticity increased and the worse the adaptation becomes. A similar thing will happen in any attempt to cover the gingival wall of a cavity with cohesive gold, using force perpendicular to that wall. Pure gold, annealed, is almost devoid of elasticity, but as soon as it is hammered between a plugger point and the cavity wall, it begins to be hardened and to acquire a degree of elasticity that will prevent perfect adaptation. The more it is hammered, the worse this will become.

COVERING THE CAVO-SURFACE ANGLE. When the gold has been built in, as shown in Figure 345, in which it will be observed that the cavo-surface angle of the gingival wall is not yet covered, the plugger point 6x12-6-10, Figure 344, should be changed for the 12x6-6-10, as shown in Figure 347. With it the building should be continued with the same angle of force, and building over the whole surface of gold previously packed until the packing has gradually extended to the cavo-surface angle of the gingival wall and has covered it with a moderately thick mass, as shown in Figure 346. This change of instruments brings the longer dimension of the parallelogram in position to build over the margin of the cavity to the best advantage.

In the approach to and the covering of margins, great care should be had not to step the instrument onto the uncovered cavo-surface angle of the cavity. If this is done, the cavo-surface angle of the enamel will be chipped and rendered imperfect. As the margin is approached, the gold should be laid over the cavo-surface angle in sufficient quantity to admit of malleting directly over it, without danger of the plugger point punching through it and coming in contact with the enamel. The gold should be built completely over the margin at every point.

When the building of gold has progressed to the point shown in Figure 346, i. e., when the gingival wall has been well and sufficiently covered, the next step is to raise the mesial por-

tion of the gold filling so that the plane of the surface becomes horizontal; and to a level with the step in the occlusal portion of the cavity, as shown in Figure 349. In doing this, the mesial surface of the filling should be regularly extended to the mesial or toward the proximating tooth to give the proper rounded form of the finished surface after the necessary trimming has been done. Any failure in this during the primary building makes necessary the addition of more gold later, when the conditions for so doing have become very unfavorable and awkward.

In the proximal portion of the filling, the building over and covering of the buccal and lingual cavo-surface angles of the cavity should have careful attention. In the final condensation against the buccal and lingual walls, the instrument should regularly be carried fully over the cavo-surface angles as they are approached and the gold well condensed against them in sufficient amount to give material for after-condensation against these margins. In general, it is preferable to leave the gold over these cavo-surface angles somewhat ragged, and condense it after the filling is completed rather than to be very frequently turning to the foot plugger or quadrangle plugger during the building.

BUILDING INTO THE OCCLUSAL STEP. The next step is the beginning of the building into the occlusal step. The location and convenience of approach will vary considerably in different cases. (1) The gold may be built along the pulpo-lingual line angle to the disto-linguo-pulpal angle, as shown in Figure 350. From this point it may be built along the disto-pulpal line angle to the disto-bucco-pulpal angle, as in Figure 352. The filling may then be built from the distal toward the mesial until the mesial portion of the filling is overlapped, as shown by the lamination in Figure 355; or, (2) convenience may require that considerable building be done on the lingual wall, as shown in Figure 351. This will occur much more frequently in the lower than in the upper molars, and oftener in the second or third than in first molars; (3) the filling in the step portion may be begun independently in the distal portion of the step by preparing suitable convenience points, or even without these when the form of the cavity is made favorable, as in Figure 353. The cutting out of the buccal groove often gives a favorable beginning point; (4) another plan is to make the first beginning of the filling in the distal portion of the step and build to the mesial over the pulpal wall to the pulpo-axial angle of the cavity. Then the building of the mesial portion is begun independently and built

up to meet the gold built into the step. By this plan, many fillings may be made without the convenience points in the mesial portion of the cavity. The holding instrument must be used until the two parts of the filling are connected. This latter, however, is in no wise necessary to this plan of procedure.

Of these various plans of beginning the filling in the step, each will have its merits in different cases. No one of them should be adopted for exclusive use. As the general rule, either the first or third should be employed in the upper molars. These plans offer the best conditions for making the strongest possible filling in the step, for the reason that the wedging between the buccal and lingual walls may be directly opposed at the same level in all of the building. In this there is decided merit in any case where unusual force is liable to come on the filling. In making the filling in this way, the principal lamination of the gold would be something like that shown in the split cavity in Figure 355. In this the lines show the lamination of the gold, and also show the order of its placement in all of the bucco-lingual center of the cavity from mesial to distal. It will be noted in examining this illustration that, first, the diagonal lines show the triangular portion first built into the gingival portion. Then comes the raising of the mesial portion to the horizontal at the height of the axio-pulpal angle. Then the building in the distal portion of the step is begun on the same lines that were employed in the mesial portion, by which the pulpal wall is covered. This gives the opportunity for the severest of wedging between the parallel buccal and lingual walls at every step of the building. This is continued from distal to mesial until the proximal portion of the filling is fairly overlapped and the two parts of the filling securely tied together. From this point to the finish, the building of the gold may be done entirely with blows parallel with the long axis of the tooth, for which the 10-10-3, round plugger, is well suited for all of the work except that along the cavity walls. This is best done with the parallelograms, with one of the flat sides parallel with the cavity wall. In case the severest wedging is desired, one may, after a row or two of blows have been struck along the wall with the 12x6-6-10, take up the 10x5-3-3 (see Figure 324) and go over it again with this smaller area of point, increasing the density and wedging it a little stronger with each piece of gold added along the walls. The fourth plan gives results quite similar to these, but beginners are much more liable to get into difficulty in building

out the mesial surface of the filling to a sufficient fullness of contour.

BUILDING THE CONTACT POINT. The mesial surface of the filling should be built strongly against the proximating tooth. The separator has, of course, been placed and the teeth strained a little apart in the beginning. During the building of the gold, the spring of the bows of the separator has been constantly pulling them apart, increasing the separation. This may be increased just a little more by wedging the gold strongly against the proximating tooth for a space that should be larger than the finished contact desired. This is done in the same manner that gold is wedged against cavity walls. At the same time another item of great importance is being accomplished. That part of the filling which shall finally form the contact point will be made very hard and resistant. Indeed, this should always receive a specially severe hammering, first with the usual gold building plugger, and then, when the gold has been hardened by that, it should be malleted again with a smaller point to still more increase its rigidity. This will prevent much of the wearing away and flattening that is liable to occur. By this method, the proper prominence of the contact point will also be assured.

COVERING THE OCCLUSAL MARGINS. Finally, in the finishing of the packing of the filling, the occlusal cavo-surface angle is approached. This should be given especial care in every part. To facilitate this in molar teeth with very deep sulci, it is often an advantage to build the central area high to have material to wedge against about the margins and cut the central portion away in finishing. The building should approach the margins and be built against them and fully over them in every part, leaving an excess of gold to be removed in finishing the filling. Then all of the occlusal part of the filling should receive a thorough final malleting for the hardening of its surface. If in this some points are found to condense down so that they may be a bit low for the final trimming, more gold should be malleted in to bring them up so that no instrument pits will be left in the final polishing.

AFTER CONDENSATION. By the phrase "after condensation" is meant such condensation of the surface and margins of the fillings as may be done after the completion of the actual building of gold has been done. Some of this after condensation may be done on proximal surfaces while the building of gold is still in progress, but it will generally be better to await the completion of the building. When sufficient experience has been had

for one to feel sure of his ground, this course will save much changing of instruments, contribute to speed and produce better results.

The after condensation of the mesial surface of the filling should be done with the foot pluggers and the quadrangles. The immediate margins should be readily reached on the buccal and on the lingual with the 5-15 foot (Varney), Figure 324, or the long foot, and thoroughly condensed.

The after condensation over most of the gingival portion should be done with the direct-acting quadrangles. Figures 328, 329, 330. (Back action quadrangles are used only on distal surface fillings.) With this pair of after condensers, right and left, every part of the gingival margin can be reached and condensed with the separator in place. Sometimes the overbuilding will be excessive. In this case, some trimming should be done and then more malleting, until this gingival portion is brought down to form with a well malleted surface. This is especially necessary and very effective when a considerable amount of non-cohesive gold has been used on the gingival wall in beginning the filling.

COMBINATION OF NON-COHESIVE AND COHESIVE GOLD IN PROXIMAL CAVITIES IN THE BICUSPIDS AND MOLARS.

ILLUSTRATIONS: FIGURES 356-364.

Combinations of non-cohesive and cohesive gold may be used effectively in many positions in filling teeth, but the greatest importance of this combination is in the beginning in the gingival portion of proximal cavities in the bicuspid and molars. The best cohesive gold workers fail, when they do fail, oftenest at this point. And so difficult is it to make perfect adaptation of cohesive gold to this wall, that a much larger per cent of success can be obtained by the combination of non-cohesive foil with the cohesive, with a saving of both time and labor. This is sufficient reason why this plan of filling should be urged for all reasonably favorable cases. It is not, however, an easy matter to learn this method. It will not be gained without careful study and effort in practice. For this reason it seems best that students should first learn to do this with cohesive gold and take up the use of non-cohesive gold later.

This combination consists of laying a large flat cylinder or mat of non-cohesive foil on the gingival wall and building cohesive gold upon this. The beginning and continuation of the build-

ing with cohesive gold is the same in every respect as if the non-cohesive gold had not been used, except that it will be necessary to continue the use of the assistant plugger for a longer time before the mass is perfectly secure in its position.

The flat cylinder or mat is made by first folding a sheet of foil, or such part of a sheet as may be required, to the right width, and then rolling the ribbon formed upon a flat steel instrument of suitable width. The length of the cylinder is controlled by the width of the ribbon, and the breadth is controlled by the width of the flat instrument. The length should be such that when placed flat upon the gingival wall with one end against the axial wall, the other end protrudes over the gingival cavo-surface angle of the cavity. The breadth should be such that it will extend fully from the buccal wall to the lingual wall and require some crowding to make it lay flat. Simply lay this in position, as shown in Figure 356, press it lightly to the cavity wall and into the convenience points, as shown in Figure 357, and begin building upon it practically as has been described for beginning with all cohesive gold.

Instead of this flat cylinder or mat, ordinary round cylinders may be used by laying the first in the linguo-gingival angle, a second in the bucco-gingival angle, and crowding a third between the two, as in Figures 358, 359. Or, two cylinders may be used that have breadth enough to fill the space from buccal to lingual. Do not condense the non-cohesive gold before beginning with the cohesive. Merely adjust it in position with gentle pressure, as in Figure 360, and condense it by building cohesive gold upon it. Then proceed as in all cohesive gold work, except that, after the filling is otherwise finished, the gingival portion should receive very thorough after condensation.

The reason that non-cohesive gold is safer in this position is that there is less disposition to curl from the margin, and if the margin is not absolutely close, it is easier to make it tight by the after condensation, because, if not tight, it moves readily under the blows of the mallet, while cohesive gold does not. Generally a considerable quantity of non-cohesive gold may be used in this way and greatly reduce the labor of making the filling. Yet, caution should be carefully exercised in the amount of non-cohesive gold used. If the gingival wall is broad, as in a deep proximal cavity, and the step in the occlusal surface is very good and reliable, much more non-cohesive gold may be used — a greater thickness — than in a case in which the proximal cavity is shallow and the gingival wall narrow. Also when a thick mass

of non-cohesive gold is used, it can not be sufficiently condensed by building cohesive gold over it, as described above. Therefore, it is necessary to condense each layer, or mat, of flattened cylinders, or of the several round cylinders, as they are placed, and make them firm before beginning with the cohesive gold.

The building of cohesive gold should begin in the convenience points, the same as if the non-cohesive gold were not present; only that the non-cohesive gold should be carried before the cohesive and the two condensed into the convenience points together. While doing this, the holding instrument should always assist by holding the gold in place. The second convenience point may then be filled, or the cohesive gold may be built along the axial wall to the second convenience point first and then the filling into the second convenience point may be done.

In building across, along the axial wall, on the non-cohesive gold, especial care must be taken to carry the non-cohesive gold before the cohesive and not allow the cohesive gold to slip between the non-cohesive gold and the axial wall and force the non-cohesive gold out of position. When cohesive gold is once built across from the one convenience point to the other in a thick mass, as shown in Figure 361, it will be reasonably secure. Notice particularly that the cohesive gold is built across exactly as in beginning with all cohesive gold, as shown in Figure 345. That is, the gingival cavo-surface angle is not yet built over with the cohesive gold, but the layers of foil, all being laid flat, are securely held. This condition should be secured before there is any cohesive gold condensed over the gingival margin of the cavity. The mass of cohesive gold should be thickened and built farther toward the cavity margin with each layer, until it is gradually built over the margin of the cavity. Figure 362 shows the cohesive gold built over the margin in the lingual half only, showing comparatively the condensation of the non-cohesive gold. In Figure 364 the progress of this work is shown by the lamination lines. The two layers of the flat cylinder of non-cohesive gold are lying on the gingival wall and the layers represented by the oblique lines are added with cohesive gold, condensing the non-cohesive gradually toward the margin as each layer is added. After this, the surface of the work is brought to the horizontal plane, as shown in Figure 363, precisely as was done in building all cohesive gold fillings. In the after condensation, the gingival portion of the filling should be especially malleted with the direct-acting quadrangle instruments, Figures 328, 329, 330.



FIG. 356.

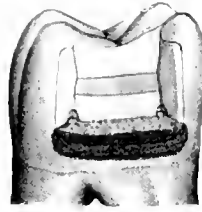

FIG. 357.

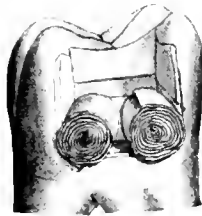

FIG. 358.



FIG. 359.

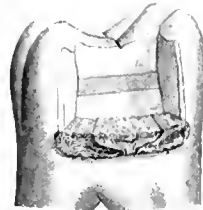

FIG. 360.

FIGS. 356-364. A series for the illustration of the use of non-cohesive gold on the gingival wall of proximo-occlusal cavities in the bicusps and molars.

FIG. 356. A mesio-occlusal cavity with a flattened cylinder or mat, laid in loosely. It is seen to be long enough to be pressed tightly between the buccal and lingual walls of the cavity.

FIG. 357. The mat or flattened cylinder is pressed well into place, but has not been severely condensed.

FIG. 358. Instead of the single flattened cylinder made for the special purpose, cylinders of suitable size and length may be used, as shown in this figure.

FIG. 359. The two cylinders shown in Figure 358 may be pressed a little to either side and a third cylinder added and the three pressed into place with a broad condensing point.

FIG. 360. Three cylinders pressed together moderately. From this point forward the cylinders and the flattened cylinder or mat would be handled similarly in building with cohesive gold. One or more additional layers of either may be used if desired, but in that case, more severe condensation would be necessary before adding cohesive gold.

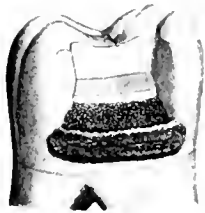

Fig. 361.



Fig. 362.

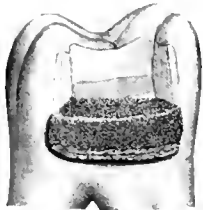

Fig. 363.



Fig. 364.

FIG. 361. Begin building cohesive gold on the non-cohesive gold in the same way that the all cohesive gold filling is begun, using the holding instrument and first driving the gold into the convenience points and then building across from angle to angle, condensing the non-cohesive gold by heavy mallet force on the cohesive gold. This figure shows the cohesive gold built across from angle to angle on the non-cohesive gold.

FIG. 362. Continue the building of cohesive gold against the axial wall and out on to the non-cohesive gold until the non-cohesive gold is all built over. This illustration shows about half the length of the gingival wall built over with cohesive gold and gives an expression of the additional condensation of the non-cohesive gold in building upon it.

FIG. 363. The non-cohesive gold has been all built over with cohesive gold and the building continued until it is nearly squared up level with the step. The completion of the filling is in every respect the same as with all cohesive gold.

FIG. 364. Shows the lamination of the gold. The only essential difference between this and the filling made entirely of cohesive gold is in the layers of non-cohesive gold on the gingival wall of the cavity.

The principal difficulties the student is liable to find in the beginning of the use of non-cohesive gold in this way, are caused by the moving of the non-cohesive gold while condensing the cohesive gold upon it, especially when a considerable mass of non-cohesive gold is used. Some help can be had in avoiding this if the cylinders of non-cohesive gold are long enough to reach across the interproximal space and abut against the proximating tooth so that this will assist in sustaining it in position. If care is not used to see that the instrument point carries the gold properly before it, it is liable to punch through the gold, or it may carry the cohesive gold between the non-cohesive gold and the axial wall of the cavity and force the non-cohesive gold out. These troubles are readily avoided after a little experience.

This plan of filling is especially adapted to proximal cavities in the bicuspid and molars. These fillings, as we prepare the cavities, are not anchored in the proximal portion of the cavity, except for the temporary purpose of holding during the building, but are anchored in the step in the occlusal portion of the tooth. The filling is supported against the force of mastication upon the flat gingival wall as a seat, and when non-cohesive gold is laid upon this in the manner indicated, with the layers of foil flat reaching from the surface to the axial wall, and condensed by packing cohesive gold over it, it has all, or very nearly all, the supporting strength of the complete cohesive gold filling; but if the gingival wall is very narrow, a considerable amount of non-cohesive gold would be weak.

This plan of using non-cohesive gold is not so well adapted to proximal cavities in the incisors and cuspids, for in these we have not the opportunity to make strong occlusal step anchorages but must depend upon the gingival wall and its angles, in part, for the strength of the anchorage. To use non-cohesive gold upon the gingival wall would materially diminish the strength of this anchorage. The use of non-cohesive gold upon the gingival wall of proximal cavities in the incisors is not so much needed, for the reason that they are in much plainer view during the progress of building the filling.

DISTAL CAVITIES IN BICUSPIDS AND MOLARS.

In distal cavities in the bicuspid and molars, it is more difficult to obtain the best angle of force, and for this reason, the building of fillings must often proceed differently. There is no difference whatever in the principles of packing gold between mesial and distal cavities, therefore, this article must relate

only to the difficulties of packing gold in these positions. The angle of force inclined directly from distal to mesial can not be obtained with direct-action instruments. Often an angle from the disto-buccal can be used, especially if the buccal wall is so cut away in the preparation as to facilitate the use of this line of force. In this case, in the beginning, a thick mass of gold should be built in the axio-linguo-gingival angle and gradually extended out to the cavo-surface angle of the cavity along the linguo-gingival angle, extending it at the same time along the axio-lingual and axio-gingival angles, forming at first a triangular mass in the point angle. The building should be continued, keeping the plane of the surface of gold built sloping occluso-gingivally from lingual to buccal, gradually covering the gingival and lingual walls and their cavo-surface angles, until the bucco-gingival angle is reached. The gold should then be wedged into the bucco-gingival angle, between the gold already built and the buccal wall, by hand pressure or the back-action plugger.

In the upper molars this can generally be done with direct-acting instruments by some special care in obtaining the correct angle. It must be distinctly remembered, however, that no attempt should be made to build against any wall using mallet force that is in the least inclined away from the surface of the wall, against which the gold is being built. A contra-angle instrument, which permits the condensing point to come readily against the wall, may properly be used by hand pressure, directed laterally to the line of its shaft; but not with mallet force when its direction inclines even a little away from the plane of the cavity wall. Therefore, when in any case a direction that is at least fully parallel with the wall can not be had, the building must be done by hand pressure. When the bucco-axio-gingival convenience point and angle have been securely filled by either plan, the lines of force for the rest of the filling will not be especially difficult to obtain. Otherwise than this difficulty, the filling is in every respect on the same principles as given for mesial proximal cavities.

In the lower molars, it is much oftener difficult to obtain suitable lines of force with direct-action instruments for filling the bucco-axio-gingival angle. The upper molars often are inclined to the buccal, while the lower molars are inclined to the lingual. This inclination is often so considerable that it becomes impracticable to so prepare the cavity that the bucco-axio-gingival angle can be filled by direct-acting mallet force, and hand pressure must be used. Or, in place of this hand pres-

sure, the back-action instruments illustrated in Figures 325, 326, 327, can be used to great advantage. The position of the working point of this instrument in its relation to the bucco-axio-gingival angle of the cavity is shown in the split distal cavity in a lower first molar in Figure 327. This point and the position of the instrument shank shown have the same relative position to the cavity walls as in the illustration, Figure 326. The line of mallet force is parallel with the shaft. In use, the shortest curve (Figure 325) that will easily reach the work to be done should be employed. These instruments are especially adapted to the building of gold against the buccal wall in lower molars that are inclined to the lingual; and often the greater part of the filling may be built with them after some facility in their use has been acquired. In all cases, however, the building against the lingual wall must be done with other instruments. The most general rule of their use should confine the back-action instruments to the wedging of the gold against the buccal wall. All parts of the filling that can be done by the direct-acting mallet pressure should be made in the usual way. In wedging the gold against the buccal wall, beginners in the use of back-action instruments are apt to fall into difficulty by striking the first blows on the gold already packed by direct pluggers. This inevitably loosens the whole mass of gold previously packed, because the line of force pulls it away from the lingual wall. The first condensing with the reverse plugger must, in this case, be actually in the bucco-axio-gingival angle and an independent mass of gold built from that onto the gold previously built, uniting the two, thus making the building complete from lingual to buccal. Once this point is made fully secure, there is no further danger from this cross direction of building.

While the use of back-action instruments is a very desirable aid in many cases in filling distal cavities in bicuspids and molars, it is doubtful if many men will arrive at that close appreciation of the relation of lines of force to the planes of cavity walls that they will attain with direct-acting instruments. *It is this close and definite appreciation of the relation of lines of force to the planes of cavity walls that brings excellence in filling teeth.* It is only the difficulty in correlating these that makes the difference between filling distal and mesial cavities. In the two cases there is no difference whatever in the principles of packing gold. Very many of the distal cavities presenting in practice may be filled just about as easily and definitely as the mesial cavities. The most difficult cases presented will be

found in distal cavities in lower bicuspid which have a very strong disto-lingual inclination. The cavities in some of these are so situated that they may be filled easiest with the back-action instruments, aided by hand pressure along the lingual wall. Otherwise they must be filled wholly by hand pressure.

In distal cavities in lower bicuspid, and occasionally in lower molars, in which access may be had with a direct-acting instrument to pack gold in the linguo-axio-gingival point angle, but access may not be had with a direct-acting instrument in the bucco-axio-gingival point angle, a slight modification of the usual cavity preparation may be made in some cases to simplify the procedure of placing the gold. The lingual end of the axio-pulpal line angle may be cut and so rounded that the linguo-axial line angle will curve to the mesial, and the linguo-pulpal line angle will curve to the gingival, the two joining to make one continuous curved line angle from the linguo-axio-gingival point angle to the linguo-pulpo-mesial point angle. The first pieces of gold should then be condensed in a convenience point in the linguo-axio-gingival angle, and the building should continue along the linguo-axial line angle in the occlusal direction and then follow the curve of this angle into the step portion of the cavity, along the linguo-pulpal line angle in the mesial direction to a convenience point at the linguo-pulpo-mesial angle. By this plan the gold may be securely anchored between the two points entirely with direct mallet force, and will be easily and quickly accomplished. The subsequent packing should be across the gingival wall from lingual to buccal, and it will be easier to fill the bucco-axio-gingival point angle on account of the fact that the mass of gold is held securely between the two convenience points already filled.

The after condensation in distal cavities is made with the back-action quadrangle instruments, Figures 331, 332, easier and more perfectly than with any other. They may be readily adapted to any distal surface in the molars and bicuspid after a little experience in their use. The rights and lefts relate to the right and left side of the individual tooth. In other words, the one fits for the buccal embrasure and the other for the lingual embrasure in distal surfaces.

CLASS 1. CAVITIES BEGINNING IN PITS AND FISSURES.

OCCUSAL CAVITIES. Filling occlusal cavities with cohesive gold is so nearly the same as filling the step portion of mesio-occlusal cavities, that little more need be said. They are the

easiest of all cavities in which to make gold fillings. Except in the third molars, the access is good. Often in the second molars, and especially in the third molars, the access may be materially improved by cutting the mesial wall and a portion of the buccal wall on a slope toward the mesial and buccal to facilitate the approach of the plugger in the proper line to parallel the line of mallet force with the plane of each of these walls. In lower molars with a strong lingual inclination, cutting to the buccal for access and for proper lines of force in packing gold is more frequently necessary. Often a very effective line of force is obtained in these positions by assuming the cross-mouth positions shown in Figures 60, 61 (finger positions).

In large and deep occlusal cavities, such as in Figures 138-146, very effective fillings may be made and much time saved by filling a considerable part of the distal portion of the cavity with non-cohesive gold cylinders. A large cylinder should be set into the cavity and flattened against the distal wall. Then another and another, wedging them so against each other and between the walls as to cause them to hold together. These may be fairly condensed with the long foot plugger, 15x5-5-12, in Figure 324, using the holding instrument to assist. When the desired amount has been placed in this way, cohesive gold should be built on it close down to and upon the pulpal wall, inclining the force as much toward the distal as practicable in the part of the work that comes upon the non-cohesive gold, so as to give it greater condensation against the distal wall. The cohesive gold should be firmly wedged between the buccal and lingual walls as soon as a solid mass can be built across from one to the other. Then the building and the wedging between walls should continue, extending the cohesive gold both upon the pulpal wall and upon the non-cohesive gold. When the mass has become sufficiently thick and firm, the building should be continued upon the pulpal wall until the mesial wall is reached and this part of the filling leveled up, wedging also against the mesial wall. From this point, the greater part of the building may be done with the direction of force in the line of the long axis of the tooth, except that directed to the distal, building upon and further condensing the non-cohesive gold.

This non-cohesive gold may be (1) in cylinders so long that they will reach fully out of the orifice of the cavity, or (2) so short that in finishing the cohesive gold may be built over them. In case the long cylinders are used, the condensation of the cohesive gold should be directed to the distal against them up

to the finishing of the packing. The final after condensation should include the ends of the cylinders. In the second case the cohesive gold should be built over the cylinders and all of the non-cohesive gold covered in making a solid cohesive gold surface. A perfectly good filling may be made by either plan. The shorter cylinders should generally be used in very deep cavities. Of course, the building out over all of the margins is the same in these as in all other cavities.

OTHER PIT AND FISSURE CAVITIES. The other cavities of this class, the buccal pit cavities in molars and the lingual pit cavities in upper incisors, require no special mention. The technic is the same as for occlusal cavities, with such modifications as are caused by the difference in the access.

CLASSES 3 AND 4. PROXIMAL CAVITIES IN THE INCISORS AND CUSPIDS.

ILLUSTRATIONS: FIGURES 365-374.

The instruments used in making gold fillings in the incisor teeth are generally smaller than those used in the bicuspids and molars. When cavities are cut into the embrasures as directed in the article on their preparation and the teeth have been separated sufficiently to finish the contact point in correct form, they are easy of approach in all parts, except the incisal anchorage. Therefore, no instruments of considerable curves of the shank are needed. With the exception of the pair of direct-acting quadrangles, Figures 328, 329, the pluggers used are included in the set illustrated in Figure 324. They are: the round points 5-10-3 or 7½-10-3 for starting the filling; the holding instrument for assisting in starting; the pair of parallelograms, 5x10-3-3, 10x5-3-3 for the principal work in building the filling; the right-angle plugger for hand pressure work in filling the incisal anchorage; the bayonet plugger for use in occasional cases for wedging against the labial wall; the Varney foot plugger for after condensation along the labial and lingual walls; the pair of direct-acting quadrangles for after condensation along the gingival wall.

CASE. A cavity in the distal surface of an incisor is prepared as shown in Figure 365. It would be possible to do the principal part of the work of making such a filling either from the lingual or from the labial approach. The most general rule should be to use the labial approach because it is most convenient.

GINGIVAL PORTION. First fill the linguo-axio-gingival convenience point, approaching from the labial with the plugger and from the lingual with the holding instrument. Select a piece of gold that seems a little large for the place, carry this into the cavity with the foil carrier and catch it with the holding instrument. Then exchange the foil carrier for the plugger 5-10-3 or $7\frac{1}{2}$ -10-3 and with the two instruments bunch the gold into the angle and begin the condensation by hand pressure. Change to mallet pressure after the gold is well started into the convenience point. This should always be filled very solidly, using rather light blows with a small condensing point. Heavy blows are too liable to check the dentin and enamel. After the immediate convenience point has been filled, build more gold about equally on the gingival, lingual and axial walls, as shown in Figure 366. Then fill the labio-axio-gingival angle in the same way, making the approach from the lingual. This is also shown in Figure 366. These convenience points are shown in Figures 170-173, and in section after the filling is placed in Figure 373. The next step is to build along the axio-gingival line angle connecting these two points, as shown in Figure 367. The greater part of this may be done from the labial approach, building against the gold built into the linguo-axio-gingival angle. In many cases it will be more convenient to vary this by building along the axio-gingival line angle to the labio-axio-gingival angle before this is filled and finishing these steps by the filling of the convenience point in this latter angle.

Up to this point, the gold has not been built over the gingival cavo-surface angle at any point. The lamination of the gold built into the linguo-gingival line angle is shown in Figure 279, in a mesio-distal section of another case. This form of building should be continued as the work progresses further until the gingival margin of the cavity is covered.

The gold should next be built up on the lingual wall of the cavity, at first in a triangular form, and gradually over the cavo-surface angle at the linguo-gingival, then along the lingual wall, at the same time adding more on the gingival wall, the gold being thoroughly wedged against the labial. The building along the lingual wall should always be in advance, farther toward the incisal, than the building along the labial wall, as shown in Figure 368. In all of this work, except that directed against the labial wall with an angle of force from the lingual, the angle of force should be directed midway between the lines of the gingival and lingual walls and inclined toward the plane of the axial wall,

all three of which are being gradually covered. The filling is extended to its full thickness and finished to its full contour as this building of gold proceeds. During the progress of this building, it will be necessary to frequently mallet the lingual portion along the lingual wall with the Varney foot plugger, often adding more gold to carry the building well over the lingual margin. The approach in doing this must be from the lingual, and the line of force in a distal cavity, as this one, should be as much toward the mesial as practicable. In a mesial cavity, the line of force should be toward the distal. This should be directed especially to wedging the gold more firmly against the lingual wall and building over the cavity margin.

INCISAL RETENTION. When the cavity has been filled in this way about to the point as shown in Figure 368, attention should be directed to filling the undercut for retention at the incisal angle. This must be done with the right angle plugger by hand pressure in practically every case in which the proximating tooth is present. In most instances, more building on the filling should be done by the mallet plugger, following and supporting the building into the retention point. This should be continued until the incisal portion is filled and the body of the filling has been built across with the incisal portion to the labial wall and thoroughly wedged in. This will bring the filling to the condition shown in Figure 369. The undercut for the incisal anchorage is shown in mesio-distal section after the filling has been placed in Figure 372. In comparing Figures 368 and 369, the filling is shown to have progressed in all of its unfinished parts during the building of the gold into the incisal anchorage, continually supporting it and enabling one to make firm work in every part. To build the gold into this anchorage without this continuous support by the gold built up with it, would be to lose that strong grip the cavity will have upon the filling in this direction, and with it much of the rigidity with which the filling is held in its position. This is a point that should have the most careful manipulative study in order that one may uniformly so contrive his work in its progress, and so correlate the advance of its several parts as to obtain the firmness of this grip of the cavity on the filling. The main difficulty observed among students in their school training, as well as in the work of practitioners, is in the correlation of this particular part of the work so that they may have the best opportunity at every point. Noticing carefully the varied directions of the angle of force required just at the point shown in Figure 368, and between it and the



FIG. 365.



FIG. 366.



FIG. 367.



FIG. 368.



FIG. 369.

Figs. 365-374. A series of illustrations of the steps in filling proximal cavities in the incisors.

FIG. 365. The prepared cavity in the distal surface of a central incisor.

FIG. 366. The convenience points filled. In filling these, the holding instrument should generally be used as illustrated in Figure 342 in starting a filling in the proximal part of a cavity in a molar tooth.

FIG. 367. The two masses of gold in the convenience points connected by building from one to the other along the axio-gingival line angle. In cases where it will be more convenient, the building along the line angle may be done before the second convenience point is filled. This building against the axial and gingival walls is continued, building about equally on each, keeping the surface diagonal to the axis of the tooth, as shown by the diagonal lines of lamination of the gold in Figure 279, until the gingival margin is fully covered.

FIG. 368. After the gingival margin of the cavity is fully covered, the surface of the gold is squared up in the horizontal plane and the building continued mostly along the lingual wall, as shown. In case the filling is done from the lingual approach, this will be reversed and the building will be done first against the labial wall.

FIG. 369. As the incisal anchorage point is approached the building into it is begun and carried on alternately with the general building in of gold, using the right angle plugger for the purpose. In this way, the gold may be solidly wedged in, in firm connection with the general mass of the filling. This anchorage should not be filled independently of the general filling of the cavity.

point shown in Figure 369, it will be seen that the building is around an arc of a circle and that the angle of force must be varied accordingly. Often three instruments will be required in frequent succession for a short time just before this point is reached; the right angle plugger used by hand pressure wedging the gold into the anchorage; the parallelogram, 5x10-3-3, for building on the mass of the filling, and the bayonet plugger for wedging against the labial wall when this can not be reached with the 5x10-3-3 parallelogram.

CONTACT POINT. While this is being done, attention must also be given to the proper building of the contact point. It will be noted, in examining the filling at this stage and comparing it with the finished filling as shown in Figure 371, that the contact point is also being built out against the proximating tooth. The gold forming the contact must be made very hard, and should receive attention with the other points of care in this critical part of the manipulative work. This gives just at this point, besides the actual gold building, three points to be made that should progress in correlation to each other: (1) the wedging of the gold in the incisal anchorage; (2) building out the contact point; (3) the wedging of the gold against the labial wall as the building on this progresses toward the incisal.

In completing the filling, the operator should be especially careful in the building against the labial wall to see that this is made secure. The completed filling is shown in Figure 371. All parts of the filling should be looked over and any malleting needed to obtain solidity along the walls of the cavity carefully done, adding a little more gold whenever it may be found necessary. However, with the proper care in the first building, such additions should not be necessary.

AFTER CONDENSATION. Finally, the gingival portion of the filling should be well condensed with the pair of direct-action quadrangle condensers, one reaching into the interproximal space from the labial and the other from the lingual. These instrument points are shown in Figure 329. The position of the instrument in use, the finger positions and mallet position are shown in Figure 328, on a filling on the mesial surface of a left central incisor. By moving the point of the instrument to the distal of the right central, it would be just similar to the position in this case. These instruments should be so placed that the condensation will be done entirely by the toe, or immediate end, of the plugger. It should be remembered that the spring of a plugger, the shank of which has so many angles, materially

reduces the effectiveness of the blows of the mallet, and the force of the malleting must be increased accordingly.

VARIATIONS OCCURRING IN INCISOR PROXIMAL CAVITIES.

In reviewing the incisor proximal cavities that have been illustrated in the article on cavity preparation, much variety in the position and form of the cavity walls will be found, and security of the work during its progress will require some changes of procedure. These, however, do not involve any new principles in packing cohesive gold.

In the series of illustrations from 247 to 250, we find in Figure 248 a cavity form unfit for filling with cohesive gold, for the reasons that, in parts, enamel is overhanging it in such form as to interfere with proper instrumentation, and there are no angles for making secure lodgments in the beginning of cohesive gold filling or securing such buildings of gold against movement during its progress. Indeed, the cavity lacks all of the elements of the triangular boxlike form required. Such cavity forms are relics of the former practice of filling with non-cohesive gold, which dentists have been slow in changing to the forms necessary to cohesive gold work. And, further, they are relics of a time when cavity formation had not been correlated to what is now known of the relation of recurrence of caries after fillings have been made, to the forms and locations of the cavity margins. In Figure 249 this is corrected by trimming away the overhanging enamel at the labio- and linguo-gingival angles to remove those bits of surface in which decay habitually recurs, and extending these to acute angles in the dentin in which cohesive gold is securely held against movement almost as soon as the packing has been begun. The gold is especially rigid in its place so soon as the two gingival angles have been connected by a solid mass of metal built along the axio-gingival line angle. This is shown in Figures 366 and 367 in the case above described. In filling such a cavity as this, no non-cohesive gold would be used because we must depend upon the rigidity of the gold built into these angles, not only for security against movement while building, but also for the permanent retention of the filling during its years of service. In this case we find one important difference from the form of the incisor proximal cavity, the filling of which has been described above. The lingual enamel wall, which had been undermined by caries, has been cut away so far that but a slight ledge could be had along the lingual margin of the axial wall. This is better seen in the filled cavity in Fig-

ure 250. If we turn to the series of illustrations in Figures 261 to 264, inclusive, we find this condition even more pronounced. It is a condition frequently met with in incisor proximal cavities that have been neglected until there has been considerable burrowing of decay in the dentin.

In these cavities the condition of the lingual wall is much less favorable to build against and to produce the form of progress illustrated in Figure 368, in order to reach and fill the incisal anchorage and wedge this securely by continuously building gold back of it to wedge it firmly against this incisal anchorage. In these conditions the operator should consider carefully the matter of changing from the use of the labial approach to the lingual approach for the principal work of gold building. In this case, the first advance in the building, after fully securing the gingival portion, would be along the labial wall instead of along the lingual wall, the approach for this work being from the lingual. This is simply a reversal of the order of the building so as to best meet existing conditions. Except for this change, the whole of the principles involved and the instrumentation will be similar and carried out by the same instruments. By this plan of building, the beginner will find rather more difficulty in building into the incisal anchorage using the right angle plugger with hand pressure, but this difficulty disappears with practice.

In cases in which the burrowing of decay along the dento-enamel junction has caused still wider cavities, as in the series, Figures 265-271, the approach becomes so easy from every direction, that the operator may choose any reasonable plan of progress that will enable him to fully secure the incisal anchorage. Whatever the forms of progress in the building or the direction of force used, the plans must be such as will render the principle of wedging the gold against all walls safe and secure by perfect adaptation and obtaining that grip of the cavity walls upon the filling that has been more fully described in the article on filling proximo-occlusal cavities in bicuspid and molars. The principle must be applied in all gold fillings.

THE LAMINATION OF GOLD IN INCISOR PROXIMAL CAVITIES, AND BUILDING OF ANGLES THAT HAVE BEEN LOST.

In the main portions of the work of filling proximal cavities in the incisors, the lamination of gold will depend upon the form of, or the order of the building of the filling. Indeed, an

expression of the lamination in lines through the filling, as was shown in Figure 355, is also an expression of the order of placing the filling. There are two points, however, in which the particular order of advance in building the gold is very important to the highest success, in making perfect adaptation and in the strength of the gold to breaking stress. These points are found in incisor proximal fillings; in building over the gingival wall, which must be used in all proximal cavities; and in building on, or restoring, angles with gold. These are illustrated in connection with the two series showing the building of angles with gold, including the Figures 273-280. The gradual building out over the gingival wall is especially shown in the diagonal lines from the gingival to the axial wall in Figure 279, each line indicating a layer of gold condensed into the angle formed by these walls, and extending out gradually, layer upon layer, until the gingival wall is fully covered. This will be seen to be precisely similar and is for the same purpose as was fully explained in the article on filling proximo-occlusal cavities in bicuspid and molars. The second purpose, i. e., the strength of the gold built on in restoring angles, is shown by the lamination in Figure 280. In this a thin angle of gold is built on, forming an angle, three sides of which are without support by cavity walls. It, therefore, depends entirely on the strength of the gold to endure the stress brought upon it in usage. Considerable difficulty has occurred from the breaking of these angles. This may be avoided by using due care in the building. First, the greatest care must be taken that the annealing is perfectly done and that the welding property of the gold used is perfectly developed, in order that no portions of gold may be introduced that do not properly weld. Second, after the walls of the cavity have been well covered for a space, the central part of the filling should begin to be raised in a ridge running from mesial to distal, looking to the formation of the restored portion of the incisal edge of the tooth. As this is raised more and more by adding most gold on the center of this ridge, gold is also being added on its labial side and its lingual side extending in layers over the raised edge and down its slopes, as shown in the illustration, Figure 280, until the building is finished. When built in this way, the restored angle will have the maximum strength, and will seldom break.

In other particulars than this one, fillings for the restoration of lost angles require no especial methods of building. In the nature of things, a filling that will be subjected to the heavy



FIG. 370.



FIG. 371.



FIG. 372.



FIG. 373.

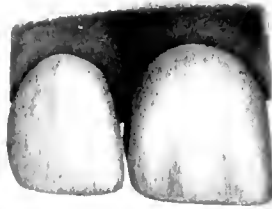

FIG. 374.

FIG. 370. The completed filling.

FIG. 371. The finished filling.

FIG. 372. The tooth and filling split mesio-distally to show the incisal anchorage.

FIG. 373. The tooth and filling cut horizontally close to the gingival wall to show the gingival anchorage.

FIG. 374. A labial view of the finished filling. Notice that the contact is on the filling and a little further to the gingival than the normal position.

usage required of these, must have good anchorage and must be well and solidly built.

Many have seemed to think the simple groove for the incisal step shown in Figure 277 insufficient to hold such a filling. The gold built into such a groove, if so inserted between the parallel walls as to make use of the full available grip of these walls upon it, will never slip out with any stress. Drilling of holes in the pulpal wall of such a groove is useless. It might be broken where it joins the proximal portion of the filling. Its strength against this breakage depends upon the gold built over it. When this has been made sufficient, there is no danger that the anchorage will fail.

CLASS 5. CAVITIES IN THE GINGIVAL THIRD — NOT PIT CAVITIES — OF THE BUCCAL AND LABIAL SURFACES OF THE TEETH.

The buccal and labial cavities are, with few exceptions, so easy of approach that the proper lines of force are easily obtained and free choice of these can be made. In general, when the cavity preparation is finished with the rubber dam in place and held by a suitable clamp, the whole cavity is exposed to plain view in all of its parts. The filling may be begun in the most convenient angle and carried over to the next by the use of the holding instrument and one of the parallelogram pluggers and thus proceeded with to completion without hindrance. It sometimes appears that this very simplicity becomes a menace to the most perfect operating, which occurs from maintaining some particularly easy position when the lines of force should be shifted for the wedging of gold against some part of a wall. While great strength is not a special requirement in this class of cavities, the most perfect adaptation to the cavity walls must be made in order that the fillings may be successful. This is to be done on the general principles of gold building that have been laid down in previous pages.

Among this class of cavities there will be a much larger proportion that are broad and shallow than in any other class. There is much building of gold over a broad axial wall. This building should be so contrived in each case in the covering of such walls that it will proceed step by step from a secure anchorage. Slight grooving of long reaches of walls assist very materially in assuring safety in such building. In all of the work, the most scrupulous care is demanded in the wedging process.

The positions in which the access to these cavities is not good are found in the second and third molars. It often hap-

pens in these that the filling must be made without much change of the line of force used, which will be directed from mesial to distal with an inclination to the lingual and gingival. If this line of force is exclusively used, there is certain to be imperfect adaptation to the occlusal wall of the cavity. The large number of cases observed showing leakage along this wall give warning of the danger of neglect in changing the line of force sufficiently often to properly wedge the gold against this wall. Another point of special care is the mesial wall of cavities of this class far back in the mouth. Occasionally, it will be necessary to use the right-angle plugger with hand pressure in these positions. A little neglect of the proper line of force in wedging is sure to bring defeat, and eventual loss of the filling.

FINISHING GOLD FILLINGS.

ILLUSTRATIONS: FIGURES 375-398.

Every filling should be finished as smoothly as the polished surface of the natural enamel covering the surface of the tooth. This finish should be so made that a sharp explorer point will, when used lightly, glide smoothly, and without catch or hitch from the enamel onto the filling, or from the filling onto the enamel at every point. There should be no overlap of the filling onto the enamel at any point. This accuracy of the finish is as necessary as any part of the adaptation of the filling to the walls of the cavity.

As the general rule, to which exceptions will be noted later, the filling should represent, in its contour, the exact form of the surface of the part of the tooth lost by decay; and, in the preparation of the cavity, to so form these fillings day by day, requires the most accurate knowledge of dental anatomy and the modeling of tooth forms that years of careful study and practical clinical experience will give. This is necessary to the highest form of success in the esthetic sense, in the general usefulness of the filling in mastication, and in the protection of the tooth against recurrence of decay. Many otherwise good fillings are left unsightly, so out of form as not to serve the purposes of mastication well, or in such form to promote, instead of prevent, lodgments of food débris, and cause, by these faults, a recurrence of decay that will defeat the object of their placement and cause the loss of the teeth.

The principal difficulties in finishing fillings occur in the proximal surface fillings. In the olden time in dentistry when the use of non-cohesive gold foil was the best filling material known, contour filling, as it is known nowadays, could not be done. For the non-cohesive fillings to stand well, required a cavity with complete surrounding walls for retention. They were prepared as nearly round as the cavity of decay would permit. The habit was to finish the surfaces of these fillings flat with the separating file. This was a thin flat file used to make room for inserting proximal fillings by cutting away the proximal surfaces; or filing between them. That is, in the treatment of proximal surface decays, the proximal surfaces were first filed flat in preparation for the filling. The cavity was then prepared and filled, after which, in finishing, the filling was filed flat with the

same instrument. This plan of finishing fillings and the instruments for it was a legacy left to us by the older operators.

After the discovery of the cohesive property of gold, the use of non-cohesive gold was rapidly abandoned for the cohesive. Although the change of plugger points to correct forms for packing cohesive gold was made rapidly, the old instruments for finishing fillings were retained. Almost immediately the effort to build fillings to restore the original contour of the tooth was begun. There had not, however, been that close study of tooth forms that enabled dentists to do this successfully; neither did they have suitable instruments with which to accomplish good results. With these conditions most dentists continued to file the proximal surface fillings flat with the separating file, as before, but, by using thinner files, left the spaces between the teeth much narrower than before. The result was much disaster caused by lodgment of food between these flat surfaces. This food material was crowded onto the gum septum and was held there as a breeding place for microorganisms, which caused acid fermentation and brought about rapid recurrence of decay at the gingival margin of the fillings. It has been a labor of many years to correct these customs and the resulting conditions, and it is yet one of the acknowledged difficult points in filling teeth. Many dentists spend more time in the endeavor to finish proximal fillings to form than in placing the fillings.

In order to present the instruments now thought best for this work, the uses of each and the form of the finished filling, the same illustration of a molar tooth with a broad mesial cavity, used to illustrate the placing of proximo-occlusal fillings, will be the basis of a series of twenty-four illustrations, Figures 375-398. Figure 354 shows the filling when the packing of gold has been completed. It is shown divested of the rubber dam and separator that the form of the tooth and filling in all parts, and the instruments to be applied, may be better seen. But in all of the illustrations, positions of instruments that may be obtained with these appliances in place have been used, or the exceptions will be carefully noted.

SEPARATION. When the cavity, such as illustrated, is filled, the proximating tooth is in position to make contact with the filling, and, although the separator is in place and the teeth separated to make room for finishing, the filling is carried out firmly against the proximating tooth in building out the part that shall serve as the contact point. This excess may be cut away as the first step in the finishing. Or, in some cases the teeth may be

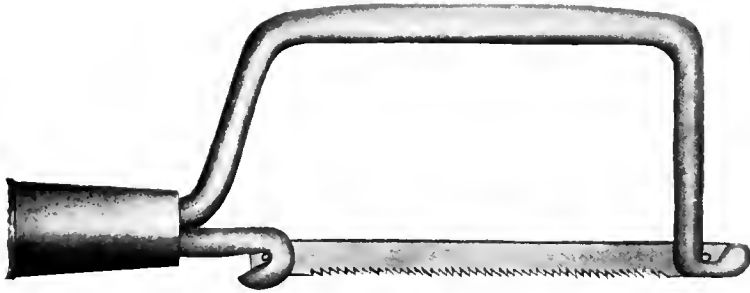

FIG. 375



FIG. 376

FIGS. 375-398. A series of illustrations of mashing instruments and of their use in mashing fillings.

FIG. 375. The saw frame and Koerber saw, much enlarged.

FIG. 376. The filling after a saw cut has been made, separating it from the proximating tooth. This cut should not be made unless the separation of the teeth has been made sufficient to justify it.

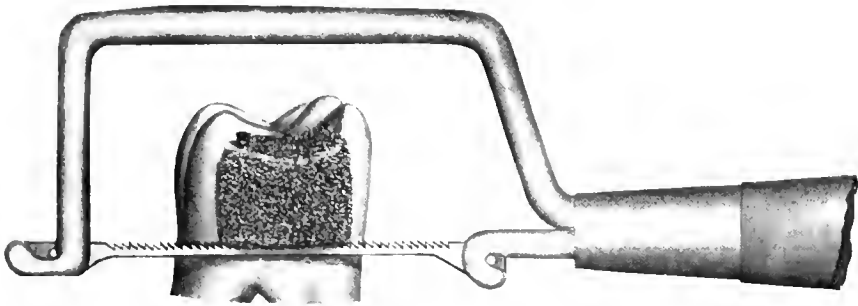

FIG. 377.

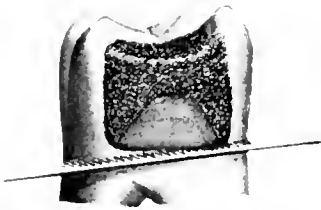

FIG. 378.



FIG. 379.

FIG. 377. The saw frame with the thread saw in position to make the first cut in trimming from the gingival margin of the filling.

FIG. 378. The filled tooth, showing the first saw cut (Figure 377) as having been made and the thread saw in position for a second cut.

FIG. 379. The filled tooth, showing the second cut (Figure 378) as having been made and the thread saw in position for a third cut. Many other than these three principal saw cuts may often be made to great advantage in trimming the gingival portion of fillings.

strained farther apart before the trimming is begun in order that a thin Koëber saw may be passed into the interproximal space without cutting the filling.

SAWS. In case the first is decided upon, the Koëber saw, set in a strong frame, the working parts of which are shown enlarged in Figure 375, is passed between the filling and the proximating tooth, cutting the least amount possible from the filling. This cut will leave the filling as it appears in Figure 376. But for the purposes of illustration, the second plan has been chosen so that the contact point may remain rough from the plugger in order that it may be better in view. Then the thread saw is placed in a similar frame, shown in Figure 377, with the cutting edge toward the frame bar in order that the cutting may be toward the occlusal instead of toward the gingival. This saw is worked past the contact point into the interproximal space and finally under the gingival overhang of the filling, as shown in the figure. This overhanging portion is then cut away. In doing this the utmost care must be had as to the direction of the cutting to see that the filling is not cut too deeply. The saw should be directed so as to run out of the gold at a little distance as is shown in Figure 378. If the saw has run out too quickly, the cut may be repeated. This cut made, the saw is so strained to one side as to cut around to the buccal embrasure as shown also in Figure 378, and another cut made, which will result in shaving off the filling as shown in Figure 379. The saw is then changed to the lingual portion of the filling, as shown also in Figure 379, and a third cut made, the result of which is shown in Figure 380. After removing the débris from this cutting, search may be made with the saw blade to see that the cutting has been sufficiently close to the enamel margin in all parts that may be reached by the saw, and any further cutting done that may be found necessary. This completes the use of the saw. That which has generally been considered the most difficult and tedious part of trimming proximal fillings has been practically completed in a few moments.

EXCEPTIONS. In a few cases in which the decay has extended far to the gingival, it will be found that the claws of the separator can not be placed far enough to the gingival for the saw to work over the separator bars. In some of these one may incline the saw so that the nib of the saw frame will pass to the gingival of the separator bar on the lingual and still do the cutting with the very short strokes that this will allow. In other cases, after placing a wedge between the teeth near the occlusal,

the separator may be removed and the Koëber saw passed between the teeth and then fastened into the saw frame and the cutting may proceed as before. After this has been done, the separator is replaced. This, while troublesome, is usually much more quickly done than the removal of the entire excess with files.

FINISHING KNIVES. The next step is to search the gingival portion of the filling for overlaps with the finishing knives, as shown in Figures 380, 381, 382. With these, all remaining overlaps are removed and such further trimming done as will fit the gingival portion of the filling for the final finish. In order that the knives may do this work well, they must be very sharp. There should be no attempt to remove thick masses of gold at a single cut with the knives. Small thin shavings should be removed in rapid succession wherever considerable amounts are to be removed. One who has attained facility in their use, can do trimming faster with the knives than with files, and model up definite forms more accurately. It is, however, in searching out and removing the last traces of overlaps of the cavity margin in these dark places along the gingival margin, that the knives are of greatest use.

FINISHING FILES. When this has been done satisfactorily, attention should be given those portions of the filling toward the occlusal portion. For this trimming, the file-cut finishing files, shown much enlarged in Figures 383, 384, are the most useful. With these, any part of the surface of any proximal filling can be reached, trimmed and shaped to the form desired. In those shown in Figure 383 the cutting sides of the blades are flat and the backs are rounded, while in those in Figure 384, the cutting sides are rounded and the backs are flat. In all, the edges should be sharp enough so that the teeth appear on the edge sufficiently for them to be used for cutting edgewise when necessary, but especially so that they may approach very closely a contact point and leave it well rounded. Each set consists of one straight and two curved; six in all. In the pairs that are curved, the cutting surfaces are on opposite sides of the blades, the one for mesial surfaces, the other for distal surfaces in positions too far back in the mouth to reach well with the straight blade. All of them cut with a pull motion. For these to cut well, the cutting edges must be sunk at right angles with the plane of the cutting surface. The edges must also be kept sharp. When dulled by use, they are readily sharpened with the knife edge Arkansas stone slips, which may be had from the jewelers' supply houses. The

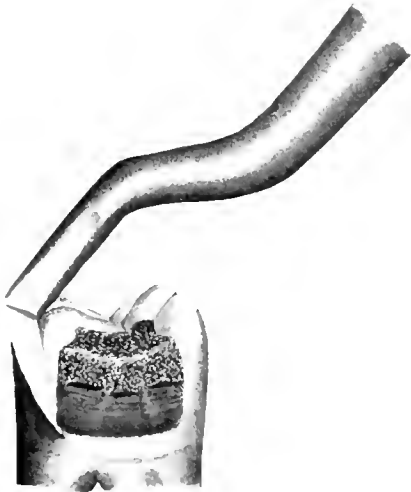

FIG. 380.

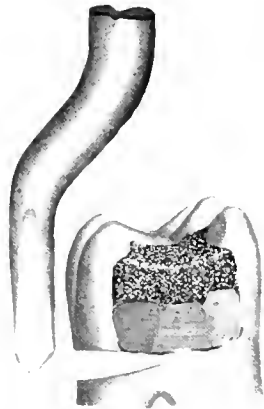

FIG. 381.

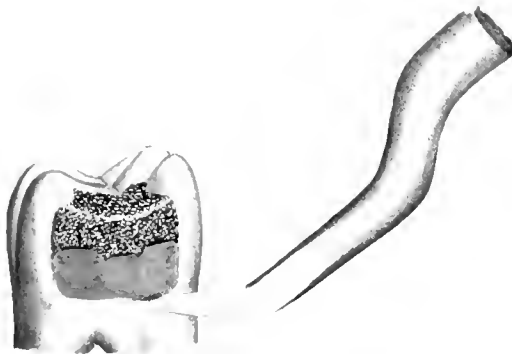

FIG. 382.

FIG. 380. The filled tooth after the saw cuts have been made, showing the position of the medium angled trimming knife in seeking out and removing the remaining overlaps of the filling.

FIG. 381. Position of the right-angled knife in seeking out and removing remaining overlaps.

FIG. 382. Position of the more obtuse-angled knife in seeking out and removing overlaps. With these three knives all overlaps about the gingival margins of cavities can be reached and removed. Much other trimming of fillings may also be done with these knives as one becomes accustomed to their use.

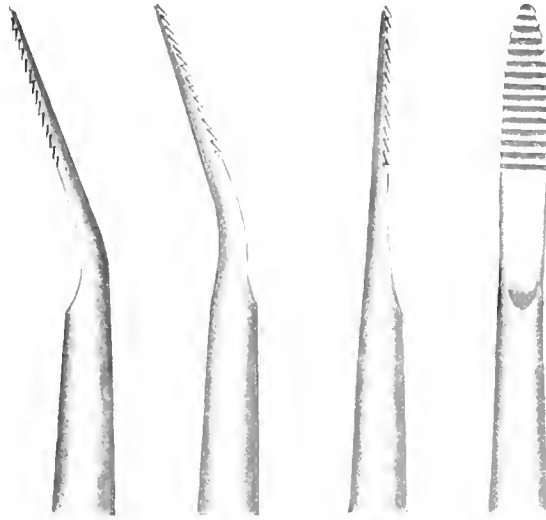

FIG. 383.

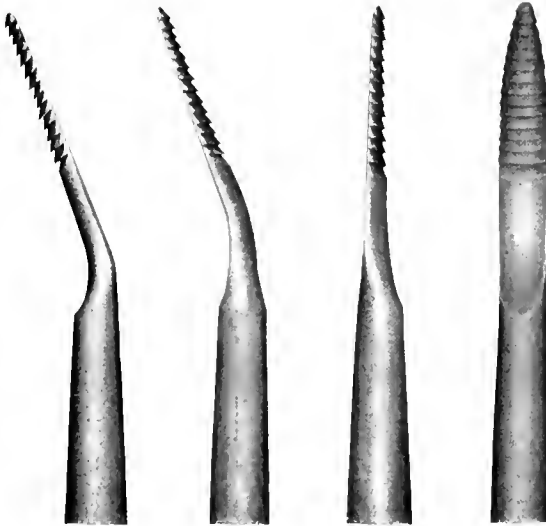

FIG. 384.

FIG. 383. Files for brushing fillings. These are all file cut files and may be sharpened with the knife-edged slips of Arkansas stone. Reading from right to left, the first picture shows the flat side of the straight file. The second shows the edge of the same file. The next two show the edges of the bent file blades with the flat file cut surface on opposite sides, one for use on mesial surfaces and the other for use on distal surfaces of the molars.

FIG. 384. The set of three files with convex cutting surfaces, but of the same form otherwise as those with flat surfaces.

dentist may do this for himself, or have the instrument-maker do it for him. The files must be frequently sharpened or they will become useless.

The first trimming is usually on the lingual and buccal margins with the flat files, as shown in Figures 385, 386. With these, the margins are trimmed and the surface is partially trimmed to form, always leaving the contact point untouched. The general rule is that the contact point should remain untouched until the last, for the reason that this should generally be left as full as it was possible to build it by malleting the gold firmly against the proximating tooth. The effect of this first trimming is fairly shown in Figure 387. The surface is then further trimmed to form and smoothed in preparation for the final polishing. In this work the flat files are used in part and the rounded files for a part. In the molars and bicuspidis it is often very desirable that the proximal surface be concave from a variable point toward the gingival line to a point near the contact point, as shown in Figures 397, 398. This form is readily obtained with the files with the rounded cutting surface. The position of the file in doing this particular part of the work is shown in Figure 388.

PROPER FORM OF PROXIMAL SURFACE FILLINGS. The shaping of proximal surface fillings to a suitably rounded contact point is one of the most important things to be attained. The usefulness of the filling depends directly upon the form given the proximal surface. There is perhaps more failure of fillings attributable to imperfect work in this than in any other one thing in the treatment of proximal surfaces. Since it has been found by careful measurements that at the age of forty years an average of about one centimeter—nearly one-third of an inch—is lost from the contact points of the teeth by interproximal wear, the measurement being made from the mesial cusp of the right third molar around the arch to the mesial cusp of the left third molar, one ought to restore some part of this with every proximal filling by making the contact a little fuller or a little more prominent than it was originally. In many of the neglected cases coming to us, there has been much loss of mesiodistal breadth of particular teeth by the loss of the contact from caries, so that these teeth have dropped together. All such losses should be restored by sufficient separation of the teeth and the building out of suitable contact points. A suitably formed contact point, including the general form given to the proximal surface, is the cure for the difficulties that arise from

food gathering between the teeth at meal time, and the discomfort and pain this produces. By so forming the contact and contour of the proximal surface that there will be very free excursions of food through the embrasures in chewing, the margins of fillings will be well cleaned and the danger of recurrence of decay greatly limited. All of these considerations call for close clinical study of the forms of proximal surfaces best suited to these ends.

FORM OF CONTACT POINT. The form of the immediate point of contact should be similar to the rounding of the surfaces of two marbles when placed in contact, and if this rounding can be continued for a space toward the gingival and then the curve reflected to form a concavity, followed by a straight line toward the gingival, as shown diagrammatically in Figure 397A, the form is improved for the purposes intended, i. e., the prevention of food lodgments. Figure 396 shows the method of testing the breadth of contacts. After a waxed floss is carried past the contact, the two ends, held parallel in the direction of the long axes of the teeth, away from the occlusal surfaces, as shown by the floss between the two bicuspid, indicate the bucco-lingual breadth of the contact. The two ends, held parallel in the buccal direction, at right angles to the long axes of the teeth, as shown by the floss between the second bicuspid and first molar, indicate the occluso-gingival breadth of the contact. The two strands should not be more than $1\frac{1}{2}$ mm. to 2 mm. apart in either position for a contact of good form. Attention is called to the position of the contact and the rounding of the occlusal surfaces, from the marginal ridges to this point in Figure 397A. Such a form causes food to pass through the embrasures and cleanse the exposed proximal surfaces of the teeth. The position of the contact shown in Figure 397B is too near the occlusal and less food will pass; that in Figure 397C is too far from the occlusal and is a very bad form, which is likely to result in the wedging of food between the teeth. In Figure 397D the contact is in the right position, but the interproximal space is too narrow. Figures 398A and 398B are diagrams illustrating about the normal relation between the mesio-distal width of the interproximal space and the distance from the crest of the alveolar process to the contact point in the upper bicuspid and incisor regions.

These observations make it desirable to imitate the forms given in Figures 397A, 398, so far as possible in forming proximal surfaces. The files for trimming these have been formed with

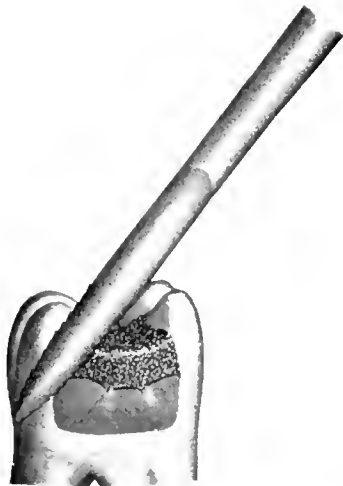

FIG. 385.

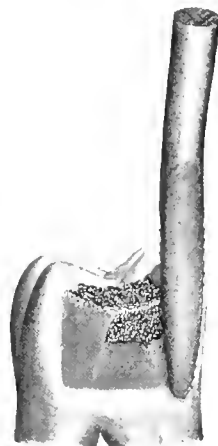

FIG. 386.



FIG. 387.



FIG. 388.

FIG. 385. The flat surface of the straight file in position trimming the lingual portion of the filling.

FIG. 386. The flat surface of one of the bent files in position for trimming the buccal portion of the filling and showing the trimming done by the file in Figure 385.

FIG. 387. The flat file smoothing the gingival portion of the filling and showing the trimming done in Figure 386.

FIG. 388. The convex side of the bent file in position rounding up to the contact point. These may be made to approach the contact point from every direction, leaving it as prominent as may be desired. After the occlusal surface has been otherwise reduced to form, this file is again used from the occlusal for rounding away the marginal ridge, which is left sharp by other instruments, to the normal tooth form.



FIG. 389.



FIG. 390.



FIG. 391.



FIG. 392.



FIG. 393.



FIG. 394.



FIG. 395.

FIG. 389. The stone finishing the occlusal surface. Much of this may be as well done by finishing bars.

FIG. 390. The disk finishing the buccal margin. It may also be used on the gingival margin in a similar way. Great care must be had in using disks not to allow them to pass over the contact point, for, becoming bound between the contact point and the proximating tooth, they will quickly cut away the prominence of the contact point and ruin the filling.

FIG. 391. Finishing the gingival portion of the cavity with the narrow strip. When the contact point is close against the proximating tooth, these strips should be introduced through the interproximal space endwise, instead of being forced past the contact point on the filling. Often the contact point will be cut too much by forcing them past it.

FIG. 392. Finishing and rounding the contact point with a broad but very thin, light tape with fine grit. This tape should be so light that it will readily cup around the contact point, rounding it in every direction. It should be used very cautiously.

FIG. 393. The finished filling with contact of ordinary prominence. This should always be just a little greater in prominence than the normal contact point.

FIG. 394. The finished filling with a specially prominent contact point.

FIG. 395. A filling with a flat contact as made by carelessly allowing a disk to run over it in finishing. The filling is ruined. Food is sure to be held by this flat contact.

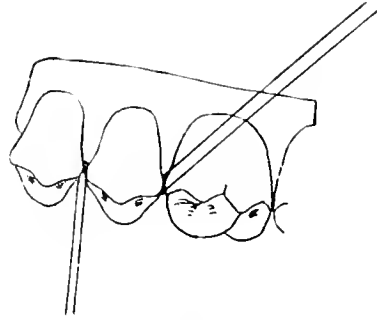

FIG. 396.

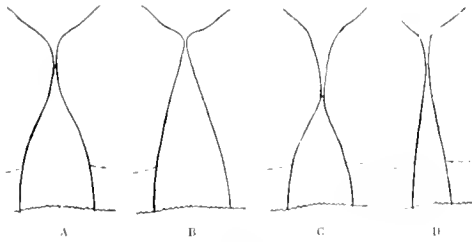

FIG. 397.

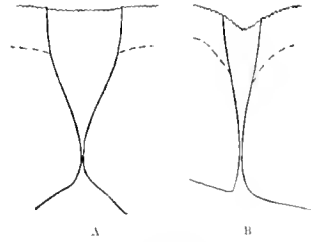

FIG. 398.

FIG. 396. In testing a contact the ligature should be first carried through from occlusal to gingival, then the two ends of the ligature should be held parallel in the occlusal direction, as shown between the two bicuspids; the distance between the strands will indicate the bucco-lingual width of the contact. The two ends should then be held parallel in the buccal direction, as shown between the second bicuspid and first molar; the distance between the strands will indicate the occluso-gingival width of the contact. In either position, if the parallel strands are more than from 1½ to 2 mm. apart, the contact is too broad.

FIG. 397. Good and bad forms of proximal contacts, buccal view. The proper position of the contact point for bicuspid and molar teeth is about as shown in A, just a little to the gingival of the marginal ridges. The convexity of both surfaces at this point should generally change to a slight concavity in the gingival direction.

The position of the contact in B is too far occlusally. With such a form of contact, less than the normal portion of food will pass through the embrasures, and the exposed portions of the proximal surfaces of the teeth will not be normally cleansed in mastication.

The position of the contact in C is too far gingivally. The long approaches from the occlusal invite the wedging of food between the teeth, with the danger of forcing the contact open.

The position of the contact in D is about right, but the teeth have not been separated to restore the normal mesio-distal width of the interproximal space.

FIG. 398. Comparison of anterior and posterior interproximal spaces, labial and buccal view. It will be noticed that the base is much wider mesio-distally between the bicuspids and molars than between the incisors. This would seem to give the more support to the septal tissue between the back teeth. It should be remembered, however, that the line of attachment of the gingivae in the incisors is very convex, extending far toward the incisal on the proximal surfaces, thus compensating for the narrower alveolar base.

this particularly in view. With the rounded cutting surfaces these forms are easily produced both on the gingival side and the occlusal side of the point of contact.

THE OCCLUSAL SURFACE. The occlusal surface of the filling is trimmed best with rotary instruments, either the stones, as shown in Figure 389, or burs. With an engine of sufficient power, large finishing burs can be used to great advantage so long as the blades are kept sharp. But the engines furnished, while excellent in the main, are not suited for the use of large burs. Stones will do the work with less pressure, and with less power, but are slower; and they do not distinguish between cutting gold and cutting enamel as do the burs. Much care should be taken to finish the filling fully to the enamel margin without cutting into the enamel. Every part of this should be made perfect so that there will be no overlaps. The discoid and the spoon excavators do the best service in trimming when little irregularities of surface prevent perfect trimming with rotary instruments.

After the trimming of the occlusal surface the rounding of the marginal ridge to the contact point is done best with the files. With the safe side of these against the proximating tooth, this form is readily obtained in condition to be polished with rotary disks.

POLISHING. All parts of the filling should be well polished. This may be done with rotary disks, wood points, leather points and polishing strips. Rotary disks, in the engine, should be used in polishing the buccal and lingual margins and as far into the embrasure as practicable without endangering the contact point, as shown in Figure 390. In no case should the disk be allowed to pass between the proximating tooth and the contact point on the filling. The narrowed space will cause the disk to press hardest on the contact point, cut it away rapidly and quickly remove its prominence and destroy its usefulness. The condition produced by this error is shown in Figure 395 in the flattened plane instead of the desired rounded contact point shown in Figures 393, 394. All scratches left by the files should be perfectly removed and the surfaces evenly rounded. Much of the rounding of the proximal surface onto the occlusal surface forming the marginal ridge, including the occlusal portion of the rounding of the contact point itself, may be done with the disks, after the rougher part of this has been done with the files.

When this part of the polishing has been completed, the gingival portion of the filling should be polished with narrow

polishing strips, that may be used in the interproximal space without reaching or passing over the contact point, as shown in Figure 391. Unless these are thin enough to pass the contact easily, and without cutting away its prominence, the end of each strip should be trimmed to a point and passed through from the buccal and caught on the lingual and pulled through to avoid injury by cutting away the contact point. Over and over again students, and dentists as well, ruin a well built contact point by failure in this precaution. If a polishing strip is allowed to be passed over the contact point, bound against it tightly by the proximating tooth, it cuts the gold very rapidly. Indeed, it produces results similar to those produced by the disk, illustrated in Figure 395. When this part of the work has been completed, the final finish of the contact point may be made. For this purpose a wide but very thin flexible tape, with fine grit, should be carefully passed over the contact point with a pull sufficient to cause it to close around it, and round it into form. The use of this should continue only long enough to produce a smooth surface. Much cutting that will materially reduce the prominence of the gold should be strictly avoided. This will finish the filling neatly and with a prominence of the contact point as it has been planned and built, as shown in Figures 393, 394.

AMALGAM.

HISTORICAL.

ILLUSTRATIONS: FIGURES 399-407.

AMALGAM is a composition of mercury with another metal, or mercury with an alloy composed of two or more metals, which is made at ordinary temperature by rubbing the mercury with finely divided particles of the metal or alloy.

Amalgam seems to have been known to chemists and has had a limited use in the arts for many years. Its use as a material for filling teeth seems to have begun early in the last century, possibly earlier. The precise date, and the person who first used it, are uncertain.

Its use at first seems to have been confined to those regarded as charlatans by persons who wrote books, and, as there were neither dental societies where such matters were discussed, nor dental journals, our knowledge of it is derived solely from some of the older books and the memory of men who were in practice at the beginning of the publication of dental journal literature about 1839. At that time, a considerable use of amalgam was being made by dentists, largely by the itinerants, or men who had no settled abode, but wandered through the country or from town to town. Some of these proved to be men of more than ordinary natural ability and developed into strong professional men. It is largely from the memory of such men that the earliest history of the use of amalgam in filling teeth is derived. The personnel of this history is now unimportant.

The first amalgam used was obtained by filing silver coins and rubbing these filings with mercury. It was very difficult to amalgamate, made a very harsh mass, and hardened very slowly, but finally became very hard. Some of the fillings made of it did enough toward protecting teeth from decay to attract the attention of many of the better men of the time. Yet most of this work was about as good as nothing, and much of it actually harmful. The result was a very sharp division on the question of the use of amalgam. Many good men regarded all who made use of it as quacks of the worst sort and refused

to admit that it had any merit whatever. Others began a study of it with the possibility of its improvement in view.

The first decisive improvement was made by adding tin to the silver and breaking up the tin foil by rubbing with the silver filings. This caused it to amalgamate much easier, formed a much more plastic mass and this mass hardened much quicker. The first amalgams the author used in filling teeth were made in these two ways. This soon led to making an alloy of silver and tin, which, so far as easy working was concerned, was a very marked improvement over the plan of simply mixing the metals in the cold state. This gave a mass that worked very much better and really gave the first decided impetus to the generalization of the use of amalgam among dentists. This was done largely through the manufacture and sale of the alloy, which was pushed as a commercial enterprise by manufacturers of dental supplies. These manufacturers soon gave stability to certain lines of amalgams used in filling teeth. Yet a large individual business has always been done in alloys by dentists, and, I am sorry to have to say, that much of this has been business of the worst sort.

That which was going on in this country was also going on in much the same way in other civilized countries of the world, and not a little of the more scientific part of the work has been done in Europe, while America has led in applied science. In the study of amalgams we must count many English, German and French writers. During all of this time there was a very strong opposition to amalgam by the better men in dentistry, which became a regular crusade against its use. Many of the most influential men seemed unable to express their condemnation of "the stuff" in language strong enough to satisfy them. Dr. McKellops, of St. Louis, never made an amalgam filling in his life and could not say enough against it. Dr. Taft, for many years Dean of the Ohio College of Dental Surgery, and later Dean of the Dental Department of the University of Michigan, would not allow amalgam used in these schools. Many other strong men were just as pronounced in their convictions of the harmfulness of the use of amalgam in filling teeth.

While this was in progress in clinical practice, a few men were making a much closer study of the essential physical qualities of amalgams, both in this country and in Europe, and endeavoring to find means of accurately determining its value. Many plans were devised for the study of its shrinkage and expansion. These may now be regarded as both wise and unwise.

But, as a matter of fact, most of them were too crude and unreliable for the study of a subject involved in so much obscurity and requiring such minuteness of inquiry to determine the controlling characters that rendered the material fit or unfit for filling teeth.

In 1874 Dr. Thomas B. Hitchcock of New York wrote one of the most memorable articles upon this subject (Transactions of the New York Odontological Society, 1874), which seems not to have been awarded the attention which it deserved. Unfortunately, Dr. Hitchcock died before his article was completed, but his unfinished paper was completed from his notes of experimental results and given to the profession by Dr. E. A. Bogue, his collaborator. As the article now stands, it is most valuable in the detailed review, with dates and accurate references, of scientific work of importance done by others along this line, and in suggesting a plan of study by which accurate results might finally be had.

The plans previously employed in this experimentation that were of real scientific merit were not so numerous but that they may readily be recounted. Most of them had for their object the determination of shrinkage and expansion of amalgam in the process of hardening, or setting, as it was generally called.

The first of these, in point of time, was by John Tomes, of London, in 1861. (Transactions of the Odontological Society of Great Britain, Vol. 3). These consisted in making holes in slips of ivory that had been cut in form similar to glass slides used for mounting microscopic objects. These were then clamped on another piece of ivory and the hole thus formed was filled as perfectly as possible with amalgam. When the amalgam was set, the margins of the filling were examined with the microscope to determine whether they remained close. Of seven amalgams tried, six showed contraction. One made of pure copper and mercury showed no contraction. (Copper amalgam does not shrink or expand, but in the mouth it wastes out of the cavity; it is not usable in filling teeth for that reason). No attempt seems to have been made to measure the amount of contraction.

The next plan was suggested by Dr. Thomas Fletcher, of Warrington, England, and was so simple that it was used later by many persons for making similar tests. This consisted in making fillings in glass tubes cut in short lengths. (In use the ends of these might be closed by melting the glass, by a tight cork at such point as seemed desirable, or the squared end of the tube could be held firmly against a table and the filling made

through the other end.) The filling was made as carefully as possible, allowed to harden and then placed in ink or some kind of colored fluid, as carmine, or Prussian blue in water or alcohol. If the colored ink penetrated around the filling, it was judged to be because of shrinkage of the amalgam. This test showed that most of the amalgams shrank. Some shrank so much that the fillings fell out of the tubes. It was found later that this was a very imperfect test, in that it might reveal poor manipulation as shrinkage and give false results.

In 1871, Charles Tomes proposed to determine shrinkage and expansion of amalgam by the specific gravity test. For this purpose, fillings were made in any kind of matrix or formed cavity which permitted the filling to be removed complete soon after it had been made. It was weighed in distilled water at a predetermined temperature immediately, and weighed again in the same manner and at the same temperature after it had set. The difference, if any, in the weight of water displaced, was determined by the differences in weight. If the amalgam should contract, it would displace less water and weigh more, showing an increase in specific gravity. If the amalgam should expand, it would displace more water and weigh less, showing a decrease in specific gravity. This process, if carefully and accurately done, gives very reliable results. But it seems from the reports that Mr. Tomes was content to form the amalgam into a mass in his fingers, which was insufficient condensation for accurate work. He found an amalgam made of palladium shrunk .037; Sullivan's amalgam (largely copper), .07; Ash, .14; a combination of tin, 55 parts, and silver, 45 parts, .35; tin and silver, equal quantities, .38. Supposing the figures given by Mr. Tomes represent shrinkage to be percentages of cubical contents of the mass, they compare favorably with shrinkages I have myself measured for alloys of about the same composition.

Kirby (Transactions of the Odontological Society of Great Britain, 1871, 1872, New Series) found that amalgams of pure silver, made either from the precipitate or from filings, expanded greatly. By the use of a V-shaped trough in which to make the fillings, and a micrometer screw for measurements, he was able to determine this expansion and also shrinkage in some of the amalgams.

Another test for expansion which was used by many, was made by filling small glass test tubes with amalgam. If the tube was of very thin glass, any considerable expansion would break the tube, usually in a lengthwise slit along one side, through

which some globules of free mercury were apt to exude. In stronger tubes the amalgam filling was more likely to be extended from the end.

These were the principal plans of experimentation and the results obtained up to the time Dr. Hitchcock wrote in 1874. After trying all of these and judging that they gave no very certain results, Dr. Hitchcock had made a steel trough an inch long, which he attached to a plate, upon which was mounted a lever or needle with a long arm and a very short arm with a pivot between, upon which the arm or needle was free to swing. The plate was graduated so as to give readings of the measurement to 1-1,000 of an inch. This needle was constantly pushed in one direction by a delicate spring. Figure 399. When the trough had been filled with amalgam, a bar attached to the short arm was held against the end of the amalgam filling in the trough by the light spring, and the movement of the long arm was designed to show the shrinkage or expansion of the mass. With this he could measure the linear changes in some of the amalgams that presented unusual movement, such as occurs in amalgams of precipitated silver or those of alloys of nearly equal parts of silver and tin. With this instrument Dr. Hitchcock had measured the shrinkage of about a dozen amalgams before his death, proving the possibility of this class of demonstration. This instrument, however, was evidently not delicate enough to measure the finer changes in bulk occurring in the amalgams.

There was also some work being done in Germany and France along lines so similar that their mention would be mere repetition. Dr. Adolph Witzel, particularly, had done much work. The best of this, perhaps, was done by obtaining teeth that had been filled with amalgam of known composition, worn in the mouth for some years, and sawing these through, polishing and examining the adaptation of the amalgam to the walls of the cavities by use of the microscope. In this work he found certain evidence of shrinkage. His principal work, "Das Füllung der Zähne mit Amalgam" was published in 1899.

Up to 1895 no materially different studies had appeared that would be regarded as developing a wider knowledge of the physical characters of amalgams. Much was written, it is true, and especially by J. Foster Flagg, but nearly all was written from the clinical standpoint and gave too little of accurate observation to be of scientific use. Although it had been clearly shown that most of the amalgams in use shrunk badly, and that this was clearly to be seen in the clinical results when used in

filling teeth, these facts failed to appeal to men practicing dentistry, and the use of "the stuff" went on just the same.

SUMMARY OF RESULTS OF EXPERIMENTAL WORK.

In studying the work done up to this time (1895), there seemed to be evidence of a lack of definite plan of study. Men had continually repeated the work of others, examining such alloys as happened to be presented, without carrying such studies to ultimate results. Indeed, the scientific work had been fitful in the extreme. A few amalgams were examined, the results reported and the matter dropped. Then another had done the same thing in a slightly different way, and this was dropped, etc.

A surprising phase of this experimental work, considering its great importance, had been the failure to follow any well defined plan of work calculated to develop an accurate knowledge of the physical characters of the various metals employed in making amalgam. Silver alone used for amalgamation had been shown to expand and this had been corroborated by a number of different men. Silver-tin amalgams had been shown to contract by as many. But these latter were alloys of nearly equal parts of the two metals in every instance. No definite line of experiment had been tried such as making and testing a definite progressive line of silver-tin alloys running from a low to a high percentage of silver, that would give a view of the properties developed by the possible variations of the proportions of these metals.

Great search had been made among the possible metals for amalgams and it had been very conclusively shown that alloys composed of silver and tin must serve as the basis of dental amalgams. Silver was the only metal found that would give the necessary rigidity and stability to amalgams, while the combination with tin alone could be depended upon to produce sufficient solubility of the silver in mercury. Other metals could only be regarded as modifiers, however important they might prove in that capacity. On this line Charles S. Tomes had reported one single series of experiments by making one definite silver-tin alloy, which he modified four times with different percentages of gold. With this his work ended. Although various tests had conclusively shown that an amalgam of pure silver would expand in setting, Mr. Tomes seems to have jumped to the conclusion that the contraction observed was due to the silver, and therefore some other metal than silver must be found that would give stability to amalgams before a reliable compound

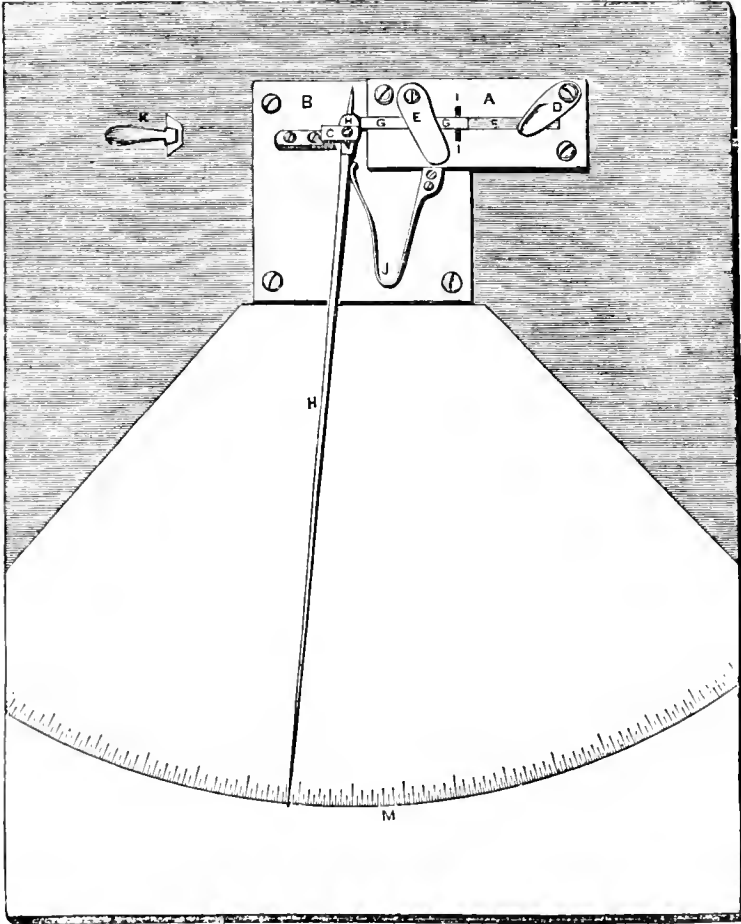

FIG. 399.

FIG. 399. Dr. Thomas B. Hitchcock's micrometer. Description of the instrument for measuring the contraction or expansion of dental amalgams.

A. A steel plate with a groove running from near *b*, at the right, to the end of the plate at the left, and being about one inch and three quarters long. *a*, *t*, a slot exactly one inch from the right-hand end of the groove for the gate *k* to rest in while a filling, *r*, is being inserted. *cd*, a bar of polished steel sliding easily in the groove, one end of which rests against the filling *r*, and the other against the circular part of the pointer *h*. Beneath this steel plate is another, *v*, on which the pointer *h* is suspended at *c*, on two points like a compass needle, that it may move freely. *a* is a light spring pressing the upper end of the pointer against the bar *cd*, so that it will follow up the filling, *r*, in case of contraction. *e* and *d* are slides to hold the filling and bar down in their places, that no upward movement might be mistaken for a contraction. This apparatus is screwed to a mahogany board, and a paper scale arranged by means of microscope glasses, so that one degree of the scale at *m* equals one thirty-six hundredths of an inch at *E*. *Transactions of the New York Odontological Society, 1871, December meeting.*

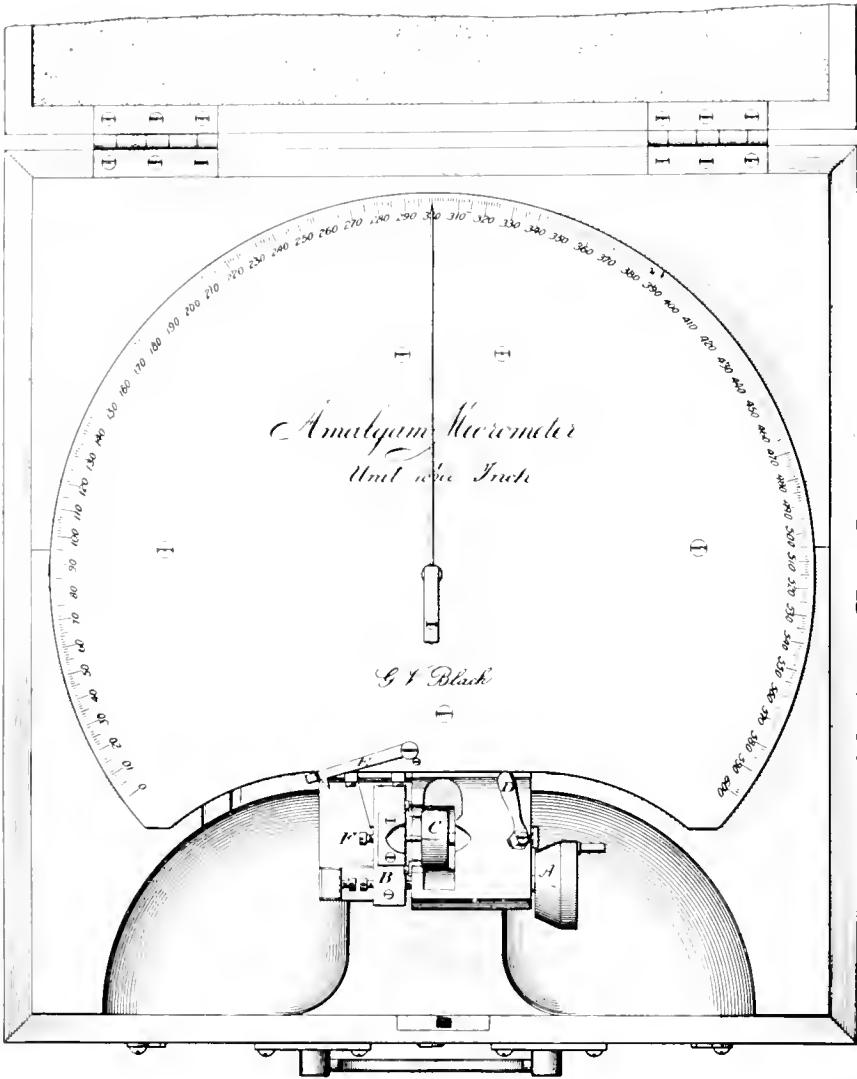

FIG. 400.

FIG. 400. The author's micrometer for the measurement of the shrinkage or expansion of amalgam, in its final form. The circle of the scale plate is twelve inches in diameter. The metals entering into its construction are so arranged as to eliminate errors from temperature changes. *A*. A wheel attached to a threaded shaft passing through a metallic block to the lever *B*. The lever *B* is pushed to the left by turning the wheel *A*. This moves the touch point *E*, which passes through the lever *B*, and the point of which impinges upon the tube *C*, away from the tube. At the same time, the needle on the dial plate is caused to swing away from the center toward the right hand. By turning the lever *B* around to the left, the grasp of a bolt held by a spiral spring against the bottom of tube *C*, is loosened and the tube may be removed, another placed or the same one returned. When in place, the lower side of this tube *C* rests on two points fixed in the bottom of the slot which receives tube *C*. There are screws arranged to take up wear of the points. The face of tube *C* is caught by three lugs when the bolt is allowed to come against it. The tube *C* must be turned so that the mark just under the letter *C* shall coincide with the point on the lever *E* when it is turned over it. Then by a backward turn of the wheel *A*, the touch point *E* comes to rest on the contents of a tube *C*, and the needle registers the measurement. When a first measurement of an amalgam filling in a tube has been registered, the tube may be removed, and returned for measurement at any future time. If at another time the needle swings to the left of the former measurement, the amalgam has shrunk. If it stops to the right, the amalgam has expanded. The amount of variation is read in gradations of one ten-thousandth of an inch. The filling is supposed to be finished so that the tube will be level full, but a variation of one or two, or even three, hundredths of an inch is unimportant. Any number of fillings may be measured and laid away, and remeasured at any time. The total movement of the lever *B*, which carries the touch point, is six hundredths of an inch, while the needle swings from 0 to 600 of the scale. A setting block, in the form of one of the tubes, is provided as a test of accuracy of measurements, and for the further purpose of correcting the instrument itself for any errors of adjustment. This is made of hardened steel and the face ground.

could be had. Great search was made for such a metal, but none other was found. Copper would do, but copper amalgam could not be made to stand in the mouth. As a filling, it will dissolve out or waste away. Palladium makes the next best amalgam, but it is less strong and the metal can not be had in sufficient quantities. Amalgams of gold or platinum are too soft. Amalgams of tin refuse to harden, and so on to the end of the list of known metals.

It was, therefore, already a settled fact that a compound of silver and tin must serve as the basis of all dental alloys. This was the condition when I undertook the work in 1895.

MEASUREMENT OF BULK CHANGES. Three plans of measurement of bulk changes have been shown to be possible: (1) by use of the microscope over fillings made for the purpose, by John Tomes; (2) by use of the specific gravity test, by Chas. S. Tomes; (3) by use of a suitable micrometer, by Thomas B. Hitchcock. All of these might easily be used in conjunction for corroboration and checking of results.

These plans of work, as they had been employed, seemed to be too far removed from what we see and experience in filling teeth to appeal to men as illustrating the failure or success of amalgam in making tight fillings when used in teeth, except that by John Tomes. In order that men may be convinced, they must be able to see open cavity margins. The micrometers used had measured to 1-1,000 of an inch. It was evident that this would have to be extended to the 1-10,000 of an inch or to the micron (1-25,000 of an inch), either of which was practicable.

The specific gravity process appeared to most men to be much more difficult to carry out when the great number of measurements necessary was contemplated, but really it is not very difficult. Its greatest insufficiency lay in the fact that it is so far removed from the plans of work used in dentistry and failed to appeal to men in a way to convince.

DEVELOPMENTS BY MY OWN EXPERIMENTAL WORK. I will now endeavor to give the additional facts developed by my own work, leaving out all unessential details of experiment. I shall not follow the order of the experimental development of these, but will adopt an order that seems now to be more logical and more readily comprehended. In all experimental research, one is "feeling in the dark," so to speak, and often finds that he has gone a long way around to develop that which finally appears as a very simple truth.

The first problem was the development of plans for the

prosecution of this experimental work on a large scale. This involved:

(1.) The designing and building of a micrometer that would register measurements accurately to at least 1-10,000 of an inch, or possibly 1-1,000 of a millimeter (one micron) if required. Figure 400. Such an instrument could not be bought, for there was none in existence. But the plans of the finest micrometers had only to be extended and adapted. The most difficult part of the work was to so arrange and intermingle the metals entering into the construction as to eliminate errors from temperature changes, and to arrange to accurately remove and replace the tubes containing test fillings. The idea of the use of a trough in which to form long bars of amalgam was dismissed, because it did not show what fillings enclosed in a cavity would do. Ivory, as used by John Tomes, would not do because of its hygroscopic quality which caused it to shrink and swell with weather changes. Finally the hardened steel tube, suggested by Dr. E. K. Wedelstaedt, was adopted as the most definite and trustworthy form of cavity. Figures 401, 402, 403, 404, 405.

(2.) A binocular microscope for the purpose of following and proving up the work of the micrometer with the stage arranged for that work. This had the further object of showing dentists shrinkages in such a way that they could really appreciate what the figures meant, which was regarded as being as important as any other portion of the work. Men are more apt to believe the things they can see with their own eyes. With these instruments I examined most of the amalgams then in the market, and sufficiently demonstrated their worthlessness for filling teeth and reported the results in the *Dental Cosmos* for May, 1895.

(3.) The next problem was to find out what manufacturers knew about amalgams, for there were many secrets in the trade. Some had hit upon important facts that no one else knew about and had kept them secret. I obtained pretty much all of these. I also obtained the formulas of all of the principal amalgams in the market for the purpose of studying them. In this the manufacturers did all that could be expected of them to help me. I also obtained from many of the manufacturers ingots of these alloys for the purpose of studying the success or failure in compounding alloys, to study the behavior of the alloys fresh cut and the effects produced by annealing. The accommodation by manufacturers was of great advantage to the investigation on these several points. I learned much as to the difficulties in

alloying metals and the directions in which failures occurred, and also the results from such failure in the qualities of the amalgam produced.

All of this was preliminary to the real work yet to be done; only finding a starting point. The work I had done only confused me the more because of various inconsistencies in the behavior of amalgams. In the effort to explain these, I was led into many errors and much labor. I found that the thing to be done was to learn to make alloys of the metals that were in fact combinations as distinguished from mixtures. This finally resulted in the use of the closed electric crucible and melting and mixing in hydrogen. I also made amalgams of chemically pure precipitated silver, and recorded their behavior, particularly their great expansion. I mixed chemically pure precipitated silver and chemically pure precipitated tin in varying proportions cold and made amalgams, and recorded their behavior. They also expanded badly. Then I melted these together, making the most perfect alloy I could in the same proportions in which the mixtures cold had been used, and recorded their behavior. These shrunk badly. The mixtures of these metals cold and the alloys made of the metals in identical proportions, were totally different in their results. The following experiment shows conclusively the result of imperfect alloying. We make a test filling in a Wedelstaedt test tube that holds eight grams of amalgam. Figures 401, 402. Take an alloy that has been carefully tested for shrinkage and expansion, say silver 65 per cent, tin 35 per cent, which will change bulk but little, if any, when used fresh cut. For another test filling take one half that needed of the alloy; for the other half take 65 per cent silver filings and 35 per cent tin filings, both fresh cut; mix these intimately with the filings of the alloy and make into an amalgam. The percentage of metal in each (the amalgam made of the mixture and the amalgam made of the alloy) are the same. Be careful to use the same amount of mercury in each. While the alloy test filling does not expand, the mixed test filling does expand badly. The balance of the metals has been destroyed by a change in their physical relation, while the relative proportions have remained the same. This experiment furnishes the reasons for the great care necessary in making alloys for amalgams, and the reason that a failure in perfect alloying will destroy the value of the product. Then for the first time in the history of the study of the metals, the importance of actual alloying as distinguished from mere

mixing of metals in making amalgams, was clearly shown. Any failure in perfect alloying produces a product different from that of the perfect alloy; i. e., a mixture of metals cold, no matter how intimate, is not an alloy and has not the effect of an alloy in amalgam making.

This did much to clear up the confusion which occurred in the measurement of shrinkages in amalgams made from the same or similar formulas for alloys used in my earlier work, and the reasons for this were confirmed by obtaining ingots from those who made them, cutting these into small pieces, taking the specific gravity of each separately and noting the uneven distribution of metals, and also the variation of the ingot as a whole from the given formula in case of possible fraud, or without intended fraud where a number of ingots were poured from the same melt of metal.

In continuing the work, it was soon discovered that the results with the best alloys became confused, and a review and careful posting of my notes established a curious line of facts. A silver-tin alloy, particularly silver 65, tin 35 (this formula will often have to be modified to obtain accurate results), made in hydrogen in the closed electric crucible, gave an amalgam that gave no expansion or contraction in setting when the amalgam was made the same day the alloy was filed. (1.) One month later this gave, with filings from the same bottle, an amalgam that shrunk badly. (2.) A change was found in the amount of mercury required to make the amalgam, less mercury being required with filings that were a month old. (3.) The mass made was distinctly softer and the setting distinctly slower. What was the cause of these changes? The change in the working property and the slowing of the setting only had been known to some of the manufacturers and different secret plans had been used to facilitate or hurry this change in order to gain the so-called improvement of the working property. (1.) The cut alloy was set away for some time before being put on sale. (2.) The cut filings were set in the sun and frequently shaken. (3.) The cut filings were washed in boiling water. These processes were known as aging the alloy. It could not be done in the ingot. It had to be done after the alloy was cut.

Experiments carefully recorded developed the following facts: (1.) The full change occurred in a few moments in boiling water. (2.) It occurred in fifteen minutes by placing the cut alloy in a test tube and placing this in boiling water. (3.) The same result was obtained by subjecting it fifteen minutes to

boiling water in a hermetically sealed tube. (4.) The same thing occurred when the tube was filled with hydrogen or nitrogen gas, oxygen being excluded. It also occurred just the same in pure oxygen gas. It was, therefore, not a change brought about by chemical agents. (5.) If in the cutting of the alloy the file or cutting machine is run so fast that the alloy is much heated, the change occurs at once. (6.) The change did not occur in hermetically sealed tubes kept on ice or in the cold brine of an ice plant that was constantly kept at a temperature as low as 17 degrees Fahr. (7.) It did occur in twelve hours at a temperature of 150 degrees. It did occur in a week at a temperature of 110 degrees. (8.) It did occur, the full effect, in six months at ordinary summer temperature, whether in hermetically sealed tubes, in closed bottles, in open bottles, or done up in paper packages.

Conclusion: The cut alloy is made abnormally hard by the violence in cutting, the same as metals are made hard by hammering. By the processes above detailed, it becomes annealed to normal. The change was produced by heat. This effects a change in the affinity for mercury and the rapidity of combination with the results named above. Why, is unknown, but the *fact* stands all tests. It is a primary physical phenomenon.

EXPERIMENTS WITH SILVER-TIN ALLOYS. The next problem was to find whether or not a silver-tin alloy could be found that would neither shrink nor expand in setting when annealed to the normal state of the metal at ordinary room temperatures. This was done as follows: A silver-tin alloy was made of 30 of silver and 70 of tin; another of 35 of silver and 65 of tin; another of 40 of silver and 60 of tin; and this progression was continued to 80 of silver and 20 of tin. These alloys were made with all possible care and tested, both fresh cut and fully annealed, as to working property, amount of mercury required to make an amalgam, the time required in setting, shrinkage or expansion in setting, strength under crushing stress, and flow under continued pressure, and every fact recorded for each. All of them were made of one batch of the metals as obtained from the refiner, for it had been learned that these would vary from about 97 to 100 per cent fine, which was enough to seriously affect results. Also double redistilled mercury was used, discarding the first and last of the distillate to insure its perfect purity. This line of work revealed the fact that annealed alloys of 70 per cent or less of silver and 30 per cent or more of tin all gave amalgams that shrank, while all containing more than 75 per cent of silver would expand when fully annealed.

From this point another short course of alloys only one-half per cent apart was necessary to find the exact balance which would produce an alloy that would absolutely lay still while hardening. When this was found, it was a good formula for that batch of metals but not for another batch, for the purity might be different, and the formula for each new batch of metals had to be found. *Therefore, no fixed formula could be good for general use.*

If it were possible to use chemically pure metals, a fixed formula would be possible, but such metals would be too expensive for use in dentistry.

EXHIBIT OF UNMODIFIED SILVER-TIN ALLOYS.

Formulae.		How Prepared	Per cent of Mercury	Shrinkage	Expansion	Flow	Crushing Stress.
Silver.	Tin.						
40	60	Fresh-cut	45.78	6	7	40.15	178
40	60	Annealed	34.14	9	3	44.60	186
45	55	Fresh-cut	49.52	4	8	25.46	188
45	55	Annealed	32.13	7-11	1	28.57	222
50	50	Fresh-cut	51.18	2	2-4	22.16	232
50	50	Annealed	37.58	10-17	0-1	21.03	245
55	45	Fresh-cut	51.62	0-2	0-2	19.66	245
55	45	Annealed	40.11	10-18	0	17.53	276
60	40	Fresh-cut	52.00	1-3	0	9.06	239
60	40	Annealed	39.80	10-17	0	14.10	297
65	35	Fresh-cut	52.00	0	1-5	3.67	290
65	35	Annealed	33.00	6-10	0	5.00	335
70	30	Fresh-cut	55.00	0	14-20	3.45	316
70	30	Annealed	40.00	5-7	0	4.67	375
72.5	27.5	Fresh-cut	55.00	0	23-42	3.92	275-350
72.5	27.5	Annealed	45.00	0-3	0-4	3.76	362-450
75	25	Fresh-cut	55.00	0	40-60	5.64	258
75	25	Annealed	50.00	0	6-8	5.40	300

The above exhibit is in the main a copy of that published in the *Dental Cosmos* for December, 1896, but has been amended by introducing variations justified by notes of alloys made since, and of tests, using the closed electric crucible filled with hydrogen in melting and alloying. These gave constant differences (though not large) from alloys made in the open crucible. Many questions may be answered by a study of this exhibit. It is a matter of much interest to note that the alloys containing 45 per cent silver and 55 per cent tin, and up to 60 per cent silver and 40 per cent tin, which were about the range of alloys then in use, lay in the center of the range of greatest shrinkage. Note particularly also the double movement — expansion, then

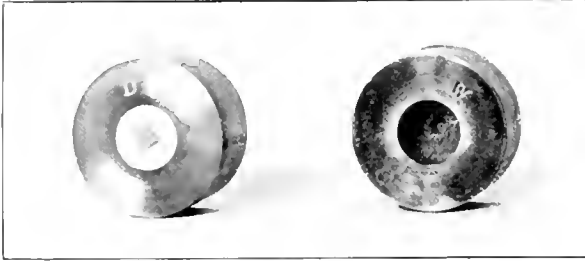

FIG. 401.

FIG. 402.



FIG. 403.

FIG. 401. A tube with an amalgam test filling. The metal in the center of the filling is a slip of steel plate, one hundredth of an inch thick, upon which the touch point makes contact in taking measurements. This steel is forced into the amalgam filling when finishing the packing.

FIG. 402. One of the steel tubes used for trial fillings. The cavity is eight millimeters in diameter. The tubes are made of tool steel as accurately as possible and a groove cut around the bottom inside the cavity. They are then hardened and the walls of the cavity and the face of the tube ground and polished.

FIG. 403. A photograph of a segment of the margin of an amalgam filling in a steel tube, with an amplification of fifty four diameters. A. The amalgam. B. The steel tube. This amalgam shows no movement whatever.

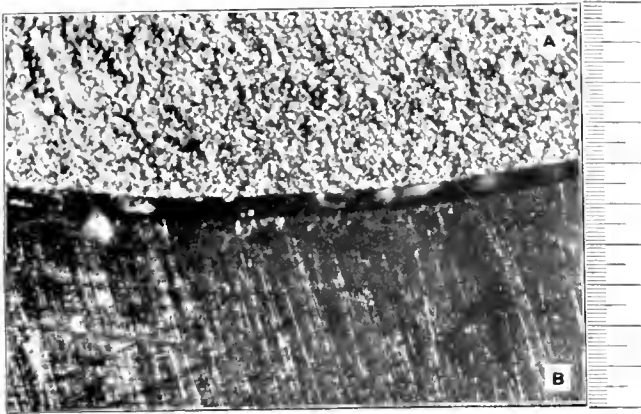

FIG. 404.

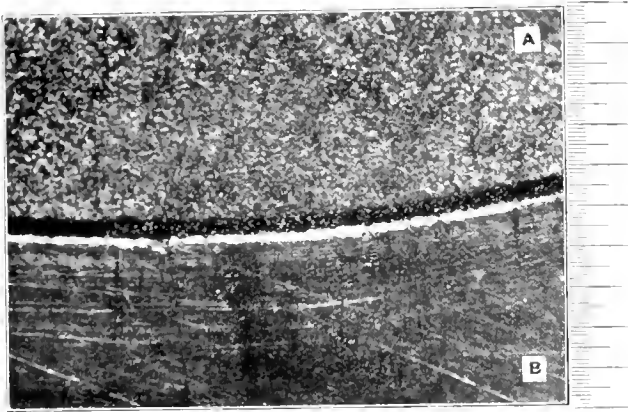

FIG. 405.

FIG. 404. Another photograph, fifty four diameters magnification, of a filling that has shrunk away from the wall of the cavity. A. The amalgam. B. The steel tube. The space between the two shows the shrinkage as it appears with a half inch lens in the microscope. The scale at the right is a micrometer scale, which divides one millimeter into one hundred parts, which was placed on the stage plate and photographed without changing the camera after photographing the amalgam in the tube.

FIG. 405. A photograph from another filling in a steel tube very similar to that shown in Figure 404. A. The amalgam. B. The steel tube. The scale is also attached. Such shrinkages as these are common to annealed amalgams composed of silver and tin, varying from fifty to sixty five per cent of silver. Adding gold, platinum or copper gives but little change in the results.

shrinkage — of the alloys from 40 silver and 60 tin on to those containing equal parts of the metals.*

No attempt was made, when this table was first published, to represent the variation of shrinkage that might occur from different samples of alloy made from the same formula. Variations must be expected. The amendment made is on account of the constant variation (which is not the same in each sample of metals obtained from the dealer) of alloys made in hydrogen gas in the closed electric crucible, an arrangement that gives the greatest facility in accurate alloy making.

Will alloys prepared for use by annealing to the normal for room temperature maintain these properties permanently? (1) as to shrinkage or expansion; (2) as to working properties; (3) as to amount of mercury required. These questions required time for their full determination, but something could be learned at once.

(1.) Annealing longer continued at the temperature of boiling water did not effect further changes in shrinkage or expansion. This gave the presumption that time would not.

(2.) Additional annealing does continue to affect the working properties in such a way as to render the amalgamation easier, reduce the amount of mercury required, and it also slows the setting. This is not very great, but it is quite marked.

Tubes of alloy were put up for time tests, some of which yet remain after twelve years, and frequent tests have been made. Shrinkage and expansion remain unaffected. The amount of mercury required diminishes, the amalgamation becomes easier, the setting becomes slower, and the strength of the amalgam is gradually reduced. An alloy that makes a crisp amalgam which sets quickly, such as should always be used in practice, will, if kept two to three years at ordinary room temperatures, come to make rather a sloppy, slow-setting mass. If the alloy is exposed to the heat of the sun or otherwise to unusually high temperatures, these changes will be rapid in proportion. If the alloy is much of the time exposed to cold, as in cold rooms in winter in northern localities, these changes will be slower.

*NOTE.— In the expansions recorded, which occurred at the beginning of the setting, the amalgam, being firmly held by the walls of the steel tube, was caused to flow upward in the tube. Therefore, the expansion recorded represents more nearly the cubical expansion. All of the shrinkages recorded, however, represent purely lineal contraction. The record of shrinkage recorded is that below the measurement at the beginning of the experiment.

MODIFICATION OF SILVER-TIN ALLOYS BY THE ADDITION OF
OTHER METALS.

The appended table shows a fairly full range of these that may be studied. Careful experiment has shown clearly that additions of more than five per cent of any of these metals will show positive injury in some direction, and a number of the metals in any proportion will cause injury. It will be noted in studying the exhibit that cadmium and aluminum are injurious in any quantity. Experiment in watching fillings for five years shows also that one-half of one per cent of zinc is inadmissible for the reason that the amalgam will continue to change bulk very slowly for that time and perhaps much longer. Though this change is not large (not more than one to one and one-half points per year with one per cent of zinc), it will finally destroy the usefulness of the filling. This effect is so subtle that it was not at first discovered.

No advantage whatever is derived from adding gold or platinum to alloys, but so long as these are used very sparingly, they do not do much harm.

Copper, not more than five per cent, if alloyed with the silver before combining with the tin, so as to insure a perfect alloy, increases the strength of the amalgam without doing injury in other ways and seems desirable. In my present view, it is the only modifying metal thus far known that is desirable.

EXHIBIT OF MODIFIED SILVER-TIN ALLOYS.

Formula.	Silver.	Tin.	How Prepared.	Per cent of Mercury	Shrinkage.	Expansion.	Flow.	Crushing Stress.
Modifying Metal.								
None	65	35	Fresh-cut . . .	52.33	0	1	3.67	290
None	65	35	Annealed . . .	33.00	10	0	5.00	335
None	66.75	33.25	Fresh-cut . . .	51.52	0	4	3.35	329
None	66.75	33.25	Annealed . . .	33.53	7	0	5.06	380
Gold 5	61.75	33.25	Fresh-cut . . .	47.56	0	1	4.62	330
Gold 5	61.75	33.25	Annealed . . .	30.35	7	0	6.07	395
Platinum 5 . . .	61.75	33.25	Fresh-cut . . .	51.87	0	9	9.68	200-273
Platinum 5 . . .	61.75	33.25	Annealed . . .	37.33	7	0	8.20	250-352
Copper 5	61.75	33.25	Fresh-cut . . .	53.65	0	23	2.38	300-343
Copper 5	61.75	33.25	Annealed . . .	35.60	5	0	3.50	416-450
Zinc 5	61.75	33.25	Fresh-cut . . .	56.65	0	63	1.83	200-290
Zinc 5	61.75	33.25	Annealed . . .	40.65	0	9	2.07	250-345
Bismuth 5 . . .	61.75	33.25	Fresh-cut . . .	46.26	0	0	4.78	250-288
Bismuth 5 . . .	61.75	33.25	Annealed . . .	23.67	6	0	5.58	308
Cadmium 5 . . .	61.75	33.25	Fresh-cut . . .	57.57	0	100	6.40	225
Cadmium 5 . . .	61.75	33.25	Annealed . . .	47.25	0	5	3.54	290
Lead 5	61.75	33.25	Fresh-cut . . .	44.17	0	1	4.88	290
Lead 5	61.75	33.25	Annealed . . .	32.76	10	0	7.18	276
Aluminum 5 . .	61.75	33.25	Fresh-cut . . .	65.00	0	445
Aluminum 1 . .	64.5	34.5	Fresh-cut . . .	46.98	0	166	12.60	198
Aluminum 1 . .	64.5	34.5	Annealed . . .	38.26	0	48	17.90	213

The above exhibit of modified silver-tin alloys has in some degree been corrected for findings made since its publication in the *Dental Cosmos*, Volume 38, 1896, page 987. The few corrections now made relate to the crushing strength of some of the alloys. It has been found that the alloys made in hydrogen in the closed electric crucible make stronger amalgams than those made in the open crucible. There are also some changes in shrinkage and expansion resulting, but these are slight and have been sufficiently noted under the exhibit of silver-tin alloys. In a general way, I may now say that no especial change of view regarding the value of modifying metals has been justified by further studies of the subject except as to zinc, which has been sufficiently noted elsewhere.

COLOR OF AMALGAMS. Can the color of amalgams be improved? This question has received more study than any other in the history of amalgams, and the answer is most decidedly, No. Zinc in very considerable proportions will produce a modification of the color in the mouth, but the proportion necessary to this will inevitably destroy the usefulness of the amalgam for filling teeth. No such combination has been found that will lay still. There is some incompatibility of chemical affinities, seemingly excited into renewed action by every slight temperature change which keeps the mass always on the move.

Any of the nobler metals added in sufficient quantity to materially affect the color, inevitably destroys the usefulness of the amalgam. This is also the conclusion of Dr. Adolph Witzel after long years of careful search on this point (*Das Füllen der Zähne mit Amalgam*, 1899, page 131).

DISCOLORATION OF THE SUBSTANCE OF THE TEETH BY AMALGAM. Dr. Adolph Witzel, in his work (page 240) has devoted an article to the examination of ("Farbung der Zahnsubstanzen durch Metallsaltze und schwefelmetalle") "coloring of tooth substance by metallic salts and sulphurets," which is perhaps the most exhaustive treatise yet written on the subject. In this he shows quite conclusively that so long as the filling excludes moisture and sulphureted hydrogen, which is so frequently formed in the mouth, there will be no discoloration of the tooth substance. Therefore, the opportunity for discoloration must come from shrinkage of the amalgam or from imperfect manipulation in placing the filling. Dr. Witzel seems to have pursued this study for many years on the plan of obtaining teeth filled with a known amalgam, and worn in the mouth for from two to eight or ten years, and sawing these through the fillings, polish-

ing and examining with the microscope. By this method of examination, any considerable failure of adaptation of the filling to the walls of the cavity may be discovered. Dr. Witzel has found that discoloration always proceeds from areas where the filling has not remained in adaptation to the cavity wall, while there is no discoloration from the areas where the adaptation to the cavity wall has remained perfect even in the same cavity. Another effective plan of studying coloration of dentin by amalgam, is to make fillings in extracted teeth and hang them in sulphureted hydrogen water for one or more months. Or they may be hung in water to which has been added some egg albumen which is allowed to decompose. By this plan one has control of his experimental work and can use and note the differences in the discoloration from different alloy compounds. This will give results very similar to those that occur in the mouth, and in very much less time.

The most important point to be noted in this, after the fact of discoloration, is the further fact that discoloration occurs only when the amalgam filling fails of being water tight. This discoloration is caused by the formation of sulphuret of silver (in case silver-tin amalgam is used), and as this sulphuret is formed, it percolates more or less into the dentinal tubules, and in the mouth, will often, in the course of years, follow these to the dento-enamel junction. This may, in pulpless teeth, discolor the whole crown. The color varies from a grayish brown to a deep black, according to its intensity. It may be any possible shade produced by the intermingling of white and black.

It should be understood that this discoloration of the tooth substance is something different and apart from the discoloration of the exposed parts of the amalgam filling. We expect these to become a grayish brown or lead color, or a deep black, but only the exposed parts can discolor if there is no leakage. The sulphuret can be deposited only where moisture impregnated with sulphureted hydrogen can come in contact with the filling and the dentin. This it can not do except on the exposed parts of the filling if the filling is moisture tight. In that case it will not discolor the dentin.

Note here particularly that a filling may exclude microorganisms and yet not be close enough to exclude moisture containing sulphureted hydrogen. Therefore, unless the leaky margin is in such a position that a colony of microorganisms may grow upon it or over it to furnish at that spot an acid of sufficient concentration to dissolve the calcium salts of the tooth,

no decay will occur. Therefore, we may have wide discoloration of tooth substance without recurrence of decay. While it is the rule that discoloration occurs with recurrence of decay from leakage, recurrence of decay does not occur from every leakage; and it is a fact long noted that many discolorations occur without recurrence of decay. This also occurs in a minor degree about gold fillings in so-called "blue margins."

If the amalgam contains other metals than silver and tin, the discoloration may be different. Copper, if added in considerable quantity, as in Sullivan's amalgam, which has been much used, green and blue-green colors are often produced. A number of the fruit acids, acid of wines, and some of the acids of fermentation produce colored salts with copper. These are soluble and the dentin is often diffusively stained by them. Still the most frequent discoloration by copper is from the sulphid which produces a deep black or blue-black.

It has been pointed out by Dr. Witzel that when a copper amalgam (silver-tin with large additions of copper) is placed in a deep cavity over a bit of leathery soft dentin left to prevent exposure to the pulp, that this softened dentin is apt to be colored green, and in case the pulp dies under these conditions, a considerable part of the dentin, or even the whole of it, including the roots, may be colored green or a bluish green. In case of smaller fillings with a thicker portion of dentin over the pulp, the cone of dentin reaching to the pulp, the canaliculi of which have been opened by the decay, is apt to be stained green. The borders of the stained area to either side are usually very sharply outlined, no stain having penetrated the dentin with living dentinal fibrils. It is doubtful if living dentin is stained by salts of copper. Certainly the border line between areas of dentin with living dentinal fibrils and areas with dead dentinal fibrils is often sharply marked by these stains. Toward the periphery of the tooth all dentinal fibrils that have been cut off from the pulp in the preparation of the cavity are, of course, dead; and these occasionally amount to considerable areas. Any such areas may become deeply stained.

Because of the danger of staining the substance of the teeth, and also because the filling itself becomes very black in some persons' mouths, amalgam should never be used for fillings in the front of the mouth, or in any place where the filling itself or the stains it is liable to produce, will be prominently seen. Its legitimate place is in the molar teeth and occasionally in the bicuspids. In the latter it should be used with great care and

it should not be used there for persons with very mobile lips that show the teeth prominently.

THE STRENGTH OF AMALGAM DEPENDS UPON SEVERAL FACTORS.

(1.) THE METALS ENTERING INTO THE ALLOY. If it is silver-tin, the strength will depend upon the proportions of the silver and tin. The greater the proportion of silver under 75 per cent, the stronger will be the amalgam. In any proportion of silver more than this, the amalgam becomes less strong, and especially it loses toughness, or becomes more brittle. An amalgam of about 72½ silver and the rest tin will make a .085 inch cube that will support three to four hundred pounds. See matrix, Figures 406, 407. In the same proportion, a block of this one inch cube will support 3529.41 to 4705.88 pounds. This is almost identical with the strength of human dentin. If five per cent of copper is introduced, displacing that amount of silver, the amalgam will be a little stronger and by careful work an .085 inch cube may be made to support four hundred and fifty to five hundred pounds.

(2.) MANNER OF MIXING AND PACKING. The strength will be greatly modified by the manner of mixing and packing the amalgam. The strongest amalgam (of about the proportion of the metals noted above) is produced when it contains just enough mercury to make a plastic mass that will take the impression of the skin markings after prolonged vigorous kneading. Any more mercury weakens it. Any less mercury weakens it. A failure of sufficient kneading weakens it. To determine just the right amount of kneading for an amalgam becomes a matter of judgment. Strength depends upon the amount of actual union of mercury with the alloy. If this is too little, the amalgam will be very brittle and lack strength. If there is too much uncombined mercury in the amalgam, it will be soft and also will lack strength. All of the higher grades of amalgam, such as neither shrink nor expand, should be kneaded as much as it is practicable to do with the least mercury that will make a plastic mass, and packed into the cavity before the mass becomes too brittle to cohere well under heavy hand pressure. This makes the strongest filling that can be made with amalgam.

(3.) THE LENGTH OF TIME THE CUT ALLOY STANDS. The strength will also be modified by the time the cut alloy stands after having been cut. The amalgams made from alloys lose strength progressively with time after their preparation, the amount depending upon the average temperature.

(4.) THE FLOW OF AMALGAM is its disposition to move con-

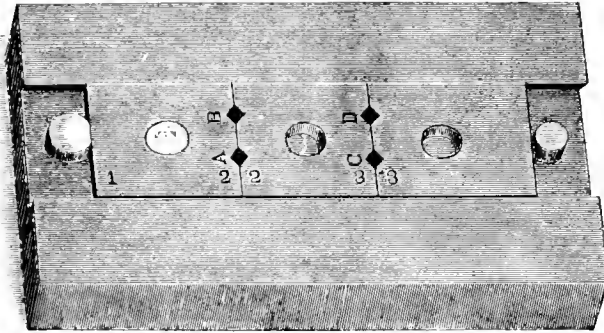

FIG. 406.

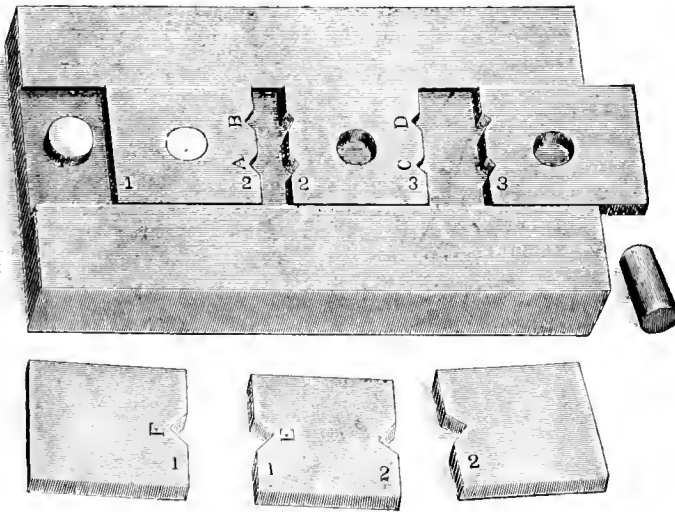

FIG. 407.

FIGS. 406, 407. A steel matrix for making experimental fillings of gold or amalgam. In this, hardened steel slides are secured in a steel holder, as shown in Figure 406, and made firm by inserting the steel pin at the right in the figure, the pin on the left being immovable. The fillings are made in the holes marked 1, 2, 3, 4. These are eight one-hundredths of an inch cubes. By removing the pin on the left, as shown in Figure 407, the slides may be separated or removed and the fillings taken out for examination. The set of slides lying below the holder in Figure 407 are for one-tenth of an inch cubes. Slides for several sizes of fillings may be used in one holder. Such an instrument should be very accurately constructed.

tinually under a given fixed pressure. If we subject pure silver, say a block 1-10 inch square, to 300 lbs., it will yield a very little almost immediately the pressure is applied. Then it will yield no more until the weight is increased. If we try a similar block of tin in the same way we find it softer. It will yield sharply at 25 pounds, and if we leave it under this pressure without increasing it, it will continue to yield until it has all crawled out from between the points or been reduced to a thin sheet. Therefore, the tin is not only a softer metal, but it has a physical property totally different from any possessed by silver, the property of continuous flow under a given pressure. An amalgam made of an alloy of tin and silver will have this property of flow in proportion to the tin it contains. The alloys containing less than 60 per cent of silver make amalgams that flow under very light pressure. This rapidly increases with the increase of tin, and diminishes with the increase of silver in the alloy. The amounts of flow for the different proportions of tin and silver are well shown in the table of physical characters of the silver-tin alloys. Any amalgam that will flow under a pressure of fifty pounds becomes unfit for filling teeth on that account. Every stress of that amount would move it a little and it would soon be destroyed.

There are a few things in the literature regarding amalgams that I have not discussed, about which questions may be asked.

THE SPHEROIDING OF AMALGAM has been much written about. The idea seems to have been that in hardening, amalgam had a strong tendency to assume the globular form. In this way, the margins of fillings were said to be opened, causing the "black ditch," so universally seen about amalgam fillings of the older sort. This black ditch occurred because of the imperfect adaptation of the amalgam to the margins of the cavity. But the cause of the imperfect margins was another question. I found that it occurred from shrinkage of the amalgam, leaving the margins open, in which decay rebegan. It occurred within one, two or three years about fillings that had been made with the utmost care, using the amalgam stiff enough to make good margins, and the loss of the filling followed. It also occurred to a much greater extent, though not less destructive in effect, about fillings because the amalgam was used so soft that it was continually on the move with every touch of the plugger, and sprung away from the walls of the cavity. The spheroiding occurred before the setting instead of during the setting. The teeth were generally stained a dark color by the amalgam.

A broad piece of amalgam, the surface of which is polished perfectly flat like a mirror, if made of an amalgam that shrinks or expands, will soon lose its perfect flatness. This is generally because of irregular contraction, which may occur from imperfect alloying or insufficient kneading. It was said to be from the tendency to spheroid. This does not occur in a well prepared amalgam made from a perfect alloy.

There may be a condition produced in mixing in which the best alloy may be made into an amalgam that will show a tendency to, in a sense, spheroid or draw into a rounded form. Whenever a very soft, sloppy amalgam is forced into a sharp angle, the mass will slightly *withdraw from the angle immediately the pressure is removed*. This it will do so long as it is soft, no matter how often it is forced close into the angle. And when the filling is removed from the matrix after hardening, all such angles will be found rounded instead of sharp. This was clearly shown by John Tomes in his experiments in 1861. It will do this when there is no shrinkage of the amalgam. When an amalgam is used while soft and jelly-like, the whole body of the filling will be moved by the touch of the plugger point, and when the pressure is removed, will draw away from the angles and some one or more of the walls of the cavity. The filling will not be tight even though the amalgam does not shrink. It is impossible to fill the angles of a cavity or even the cavity itself at all perfectly unless the amalgam is so stiff that the rigidity of the mass will hold the material where it has been placed. This could be done only in one way, and that would be to hold it under pressure until it had set.

In other words, a perfect filling can not be made with a soft amalgam, because it will spring here and there at every touch. It will spheroid when soft but will not when it becomes stiff. A considerable stiffness that will maintain form and a considerable degree of pressure between cavity walls, are absolute requisites to success in filling teeth with amalgam.

EFFECT OF WRINGING OUT MERCURY. The question of changing the qualities of an amalgam by wringing out mercury has been much discussed. A number of examinations have shown an excess of tin in the mercury wrung out. This is certainly the case whenever uncombined tin is mixed in the alloy. In rubbing mercury with an alloy, the unmixed tin will be dissolved first and any unmixed silver last. But if the alloying is a perfect combination, I have reason to believe that no one metal will be dissolved more than another. I have tried this very

thoroughly as to the effect on the amalgam, made from carefully prepared alloys, and not found a change in quality as to shrinkage or expansion by reason of wringing out mercury. This has been tried especially by mixing an over-plus of mercury, and after wringing out making test fillings, carefully weighing the mercury wrung out and ascertaining the precise amount of mercury retained in the alloy. Then another mix has been made, using the alloy from the same bottle and adding just the retained amount of mercury in the first filling. The fillings will test alike for shrinkage or expansion. Indeed, as has been said before, more or less mercury does not control shrinkage or expansion, but if tin were removed in much excess, I see no reason why the amalgam would not be made to expand just the same as if less tin had been used in making the alloy.

PRINCIPLES GOVERNING THE MANIPULATION OF AMALGAM.

ILLUSTRATIONS: FIGURES 408-410.

In the manipulation of amalgam in filling teeth, there are some fundamental propositions that should be understood and take precedence of all others.

(1.) SHRINKAGE AND EXPANSION OF THE AMALGAM USED IS NOT UNDER THE CONTROL OF MANIPULATION BY THE OPERATOR. This can be controlled only in the selection of the alloy to be used. Shrinkage or expansion is controlled by the proportions of the metals of which the alloy is formed, and their relations to each other, as alloyed or mixed. In the particular compound selected for use, shrinkage or expansion does not depend upon the proportion of mercury; further than that, wide shrinkages or wide expansions can be in some degree modified as to extent, not controlled. As these are only modifications and do not control, they are unimportant in the manipulative sense; the question of shrinkage and expansion resolves itself exclusively into that of the correct balancing of the metals in the alloy. The dentist is interested in the selection of the alloy for use. In this, the only chance is to trust the best alloy makers. Those should be selected that have prepared themselves especially for this work by experience in the use of the best instruments devised for alloying metals and testing their results, and who are known to be honest. Here the question is often asked: "Should the dentist make his own alloys?" Certainly he may do so if he will devote some years of study and time to learn alloy making and

testing, and equip himself with five or six hundred dollars' worth of necessary instruments; not otherwise.

The dental profession should unite in demanding of dealers the closest work in alloy making that is commercially possible and should willingly pay a price for the product that will justify this care. Every alloy should rest upon the reputation of the maker personally. The practice of labeling alloys with the name of the person or firm selling them to the exclusion of the maker's name, is pernicious. It should not be tolerated by the users of the product, for by it the dentist loses all opportunity of judgment as to its nature. Further, as cut alloys deteriorate with time, the date of the preparation ought to be placed on every package.

(2.) THE STRENGTH OF AMALGAM IS DIRECTLY UNDER THE CONTROL OF MANIPULATION, within its possible limits. This manipulation differs for different compositions of alloys, but it is so nearly the same for all those that neither shrink nor expand, or are very close to that line, that these only need to be considered, except for comparative purposes.

The alloys fit for use are practically all composed of tin and silver varying but little from 72½ per cent of silver to 27½ of tin, except as they may be modified by small additions of copper or other metals. These produce only very slight modifications in the manipulative qualities, so slight that they may be ignored except as they call for more or less mercury.

To make an amalgam that will be strong to breaking stress and will best resist flow under stress, about the right proportion of mercury must be used; every variation affects its strength. Too much mercury diminishes the strength very rapidly. Too little mercury also diminishes the strength, and especially renders the amalgam brittle, but in less degree than too much mercury. The first thing to be determined is the percentage of mercury to be employed. This amount will differ from two causes:

First, the modified alloys will differ from the silver-tin alloys in some degree according to the metal used to modify. For instance, if five per cent of copper is used, a little more mercury is needed and the amalgam will be a little stronger. Other metals will produce other variations.

Second, the amount of mercury required will be changed by the amount of annealing to which the alloy has been subjected. The more it is annealed, the less mercury required and the slower the setting. By long continued exposure to summer weather, the

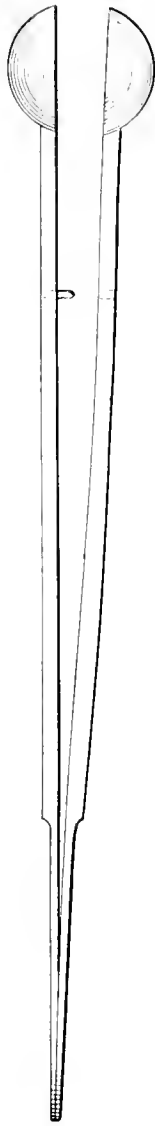

FIG. 408.

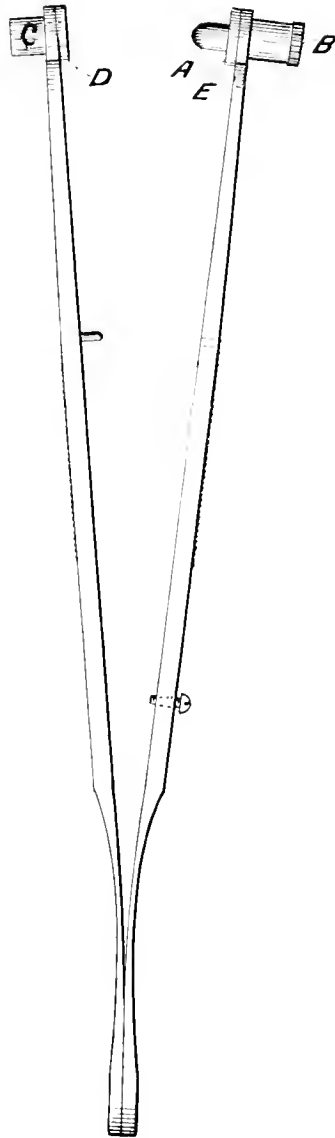

FIG. 409.

FIG. 408. The mercury spoon forceps. An instrument for handling mercury when exactness in weighing is desired. It will pick up any quantity the spoon will hold, or any separate globule large enough to be seen with the naked eye.

FIG. 409. A mercurymeter for rapidly measuring a given definite quantity of mercury in putting it up in capsules for use in filling teeth. A certain definite quantity of alloy, say fifteen grains, is weighed and placed in a capsule. A definite amount of mercury may be measured and placed in another capsule ready to mix with the alloy. A. A piston that fits into the hollow cap C. The piston A has a screw thread in the barrel on which the nut B acts as a jam nut to fix it in any position desired. The piston A may be turned by the screw backward or forward so that it will go deeper or less deep in the cap C. When C is placed in mercury and is filled, the instrument is closed, bringing remove any clinging globules. The mercury in the cap is then poured into the capsule. When the instrument is once adjusted for the right amount of mercury, the repetition of the measurement is as rapid as the mercury can be dipped and poured, and is very accurate. When the right amounts of alloy and of mercury are put up in separate capsules for use, both convenience and accuracy is obtained.

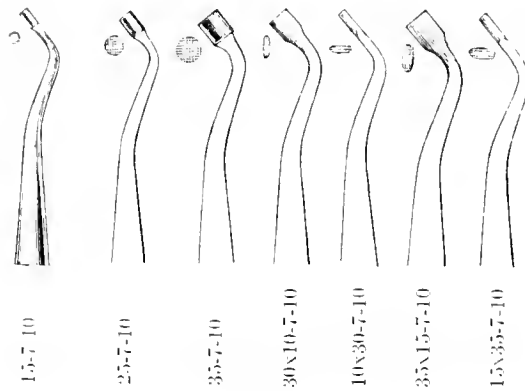

Fig. 410.

Fig. 410. The set of amalgam pluggers. The formulas attached give the size and form of each. The rules of measurement for these are the same as for other plugger points. See rules accompanying Figure 324. The first two pairs, reading from right to left, are parallelograms with rounded angles and are designed especially for proximo-occlusal cavities. The first, 15x35-7-10, is especially fitted for the proximal portion of the larger cavities, while the 35x15-7-10 is suited to the step portion of the same cavities. The smaller pair is suited for use in the smaller bicuspid proximo-occlusal cavities. The round forms are better suited for use in occlusal cavities.

amount of mercury required is reduced and the working property gradually softened; the strength of the amalgam is reduced.

The right amount of mercury must first be determined by trial. To do this most accurately, suppose we take 60 per cent of mercury and 40 per cent of alloy and make a trial mix of a definite amount. The fillings are first incorporated with the mercury in the mortar. Then the mass should be transferred to the palm of the hand, if the hand is dry, and kneaded; or, if the hand is moist, it should be placed in a rubber finger stall and kneaded. If the proportions of alloy and mercury are right, the mass should, after thorough kneading, make a smooth paste that will take good impressions of the skin markings of the fingers, without being sloppy. It should be tough enough to be rolled into a long, slender roll without much breaking. It should be stiff enough so that it will not change form perceptibly when rolled into a ball and laid on a table. To obtain these results will require considerable hard kneading with the right amount of mercury. If there is too much mercury, the mass will become sloppy, can not be rolled into a slender roll without breaking, and if rolled into a ball, will flatten out perceptibly when laid on the table. Then trials of a smaller proportion must be made. If there is not enough mercury, the mass will not cohere well and will break readily. It will not become soft enough to readily take impressions of the skin markings of the fingers. Then trials of a larger proportion must be made. These findings should be corrected by the trials of the strength of the blocks made from each trial mass. (The dentist will generally have to omit the trials of strength, unless he should happen to have access to a dynamometer, similar to the one shown in Volume I, Figures 164, 165.)

A good pair of balances should be used for weighing the proportions of alloy and mercury, and when the proper percentages have been determined, the amounts of alloy and mercury for each filling should be carefully weighed. As mercury is difficult to handle, the author has devised a pair of mercury pliers, with which the smallest globule of mercury that can be seen with the naked eye may be easily picked up. Figure 408. A mercury meter has also been devised. After the exact amount of mercury necessary for a given weight of alloy has been determined by weight, it is placed in the measure and the instrument adjusted so that it will hold exactly that amount. For subsequent mixes, the mercury meter may be used instead of the balances. Figure 409.

It is an excellent plan to determine upon a definite amount of alloy, about fifteen grains is best, to use for all fillings, and then weigh a dozen or so portions of this amount, placing each in a capsule or pill box. The proper portion of mercury for each fifteen grains of alloy may also be placed in a capsule. These will then be ready for use and avoid the delay of weighing at the time of each operation.

(3.) THE KNEADING of the mass during the incorporation of the mercury with the alloy, is of especial importance in its relation to strength. This point needs more than usual consideration at the present time by reason of the past habits of dentists in using alloys composed of nearly equal parts of silver and tin. These dissolve in mercury with far less kneading than those containing more silver now in use. The tin controls, in large degree, the solution of the silver, and the larger its amount, the quicker the solution and the softer the mass works. But all alloys with these large proportions of tin make amalgams that shrink so badly as to be unfit for filling teeth. Therefore, with our modern alloys, the kneading must be continued much longer, and be done more vigorously, in order to make a good, strong amalgam.

Any superfluous mercury apparent should be removed by wringing out as soon as it is noticed. Experience shows that an excess of mercury does not do much harm if wrung out promptly, though it is certainly best to have just the right amount. The kneading must be continued until a disposition to stiffen has just begun to be noticed. Then the packing should begin immediately and proceed as rapidly as perfect work will permit.

Before mixing the amalgam for use in filling teeth, every preparation should be made for making the filling. The cavity should be fully ready with all adjustments of rubber dam, matrix and separator. All of the instruments for use in packing the filling should be laid in convenient readiness so that no time shall be lost, for, if the amalgam is just what it should be, it will begin to stiffen at once and will soon become too stiff and brittle for packing; and if, because of dryness, it must be forced together with extraordinary pressure, in order to make it cohere, is apt to make a brittle filling.

(4.) FOUR SURROUNDING WALLS ARE NECESSARY for all cavities for amalgam fillings. Therefore, all proximal cavities in bicusps and molars must have the mesial or distal wall supplied by a matrix. This matrix should be tied on to the tooth near the gingival line and wrapped some little distance toward the

occlusal with several turns of the ligature, drawing each tightly, in order to withstand the pressure that should be used in packing the amalgam.

(5.) PLUGGERS AND PACKING. Pluggers and packing instruments should be as large as can well be used in the cavity so as to grasp and compress the amalgam as a whole as nearly as possible in the first instance, and then used with all of the power of the hand, and with just a slight shaking motion, which tends to settle the amalgam into any irregularities or angles of the cavity. The rope of amalgam should be broken in bits the size desired before beginning so that they can be handled quickly with the pliers and placed in position. This may be done by an assistant or by the operator. Then each piece is caught by the broad plugger point and immediately condensed. A small point should always be in readiness on the tray for special condensation about the walls and into angles or any points that the large instrument may not reach well. This should be done on the same principle as the stepping of the instrument in packing gold to secure perfect adaptation to walls and margins. That is, the stepping should be *from the mass of the filling already condensed toward the walls, finishing at the walls and wedging the last between the walls and the portion already packed*. In using small instruments about the walls and angles, the force should be sufficient to pack the amalgam, but not so great as to force the instrument into the already packed material and cause it to move. It requires some care to learn this and use force judiciously. In the main work with the large instrument, the whole power of the hand will not be too much, but with small points it is easy to force the previously packed material out of position.

The packing should be continued carefully and rapidly, and the filling should be built up evenly, until the cavity is full and more than full. The amalgam should be heaped up over the margins. Then, with the largest instrument possible, all the pressure the hand can give should be applied, shaking very slightly, compressing the mass as a whole as much as possible. Then the bulk of the surplus may be gradually worked off and pushed away with the large burnisher. This should be done without making any considerable pressure on the mass of the filling. A little time should then be given the amalgam to stiffen; from one to three minutes, after which it should be trimmed to form with sharp instruments at the same sitting, and polished at a subsequent sitting.

A set of amalgam pluggers is shown in Figure 410. There are three sizes of round points and two pair of parallelograms. The smaller pair of parallelograms are designed particularly for proximo-occlusal fillings in bicuspid, and the larger pair for similar fillings in molars. These may also be used for gingival fillings in buccal surfaces. It will be noticed that the ends of all of these pluggers are serrated, so that they will not slip. A burnisher, or smooth-faced plugger, should not be used in packing amalgam.

FILLING WITH AMALGAM.

ILLUSTRATIONS: FIGURES 411-418.

CAVITY PREPARATION. As the use of amalgam is contra-indicated in the front teeth on account of its color, it may be used in cavities of the first class, pits and fissures in the occlusal, buccal and lingual surfaces of the bicuspid and molars; second class, proximal cavities in the bicuspid and molars; and the fifth class, gingival third cavities in the buccal, and occasionally lingual, surfaces of the bicuspid and molars. Every detail of the cavity preparation for either class should be the same as for filling with gold, except that convenience points for starting the filling need not be made. Neither is it quite so explicitly required that convenience forms of the walls for access be so rigidly observed, though there should not be much difference. If possible, the anchorage should be stronger than for gold, and as amalgam is so much used for very badly decayed teeth, especially in teeth from which the pulps have been removed, advantage should be taken of the pulp chamber to strengthen the anchorage. In such cases the pulp chamber should be filled solidly with amalgam to the pulpal orifice of the root canals.

THE RUBBER DAM should be in place for all amalgam fillings, the same as for gold, before the enamel walls are finished and the cavo-surface angle is beveled. It is just as important that the cavity be thoroughly dry and that the walls be trimmed after they are dry, in order that no residue from the saliva will be present between the walls and the amalgam. It is as impossible to make a good amalgam filling as it is a good gold filling with any moisture present.

All cavities filled with amalgam must have continuous surrounding walls during the building of the filling. We can not build up a cusp or an angle of a tooth with amalgam and expect good adaptation to the walls, for the material is plastic, and,

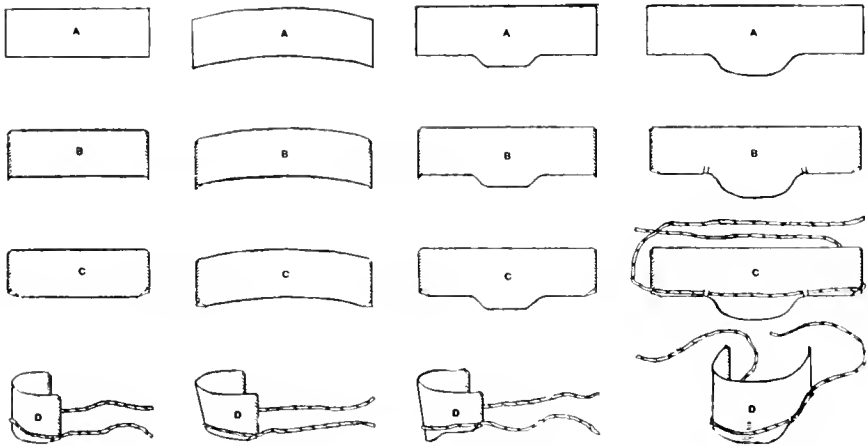

Fig. 411

Fig. 412

Fig. 413

Fig. 414

Figs. 411-414.—A series illustrating matrices cut from metal plate for use in forming the fourth surrounding wall in filling proximo-occlusal cavities with amalgam.

Fig. 411 shows the simplest form and that which may be used for the greater number of the smaller and medium cavities. *a*. The matrix as cut. *b*. The matrix with the ends bent so that the sharp edges may not cut the ligature. *c*. The corners at the gingival edge are bent to prevent the ligature slipping to the gingival of the matrix. *d*. The position of the first lap of the ligature on the matrix.

Fig. 412. In case the crown of a tooth is badly broken down, the matrix should reach nearly around the tooth to keep it in position when securely wrapped with the ligature, and must be cut on a curve to give the proper bell-crown form of many molar teeth. This can be cut to suit the case.

Figs. 413, 414.—Forms for use in decays that extend far in the gingival direction. The extension is intended to cover this extension of decay. In Figure 413, *c* shows a method of attaching the first lap of the ligature to the matrix before placing the matrix in position, by cutting two slits, turning up the piece between them, laying in the ligature, and closing the pieces on it to hold it in place. In *d*, a crimp is bent in the central part of the gingival edge to assist in catching the rubber dam and carrying it to the gingival line before the matrix. See Figures 415, 516.

when pressed upon, the whole body of the filling is liable to movement. To prevent this, complete surrounding walls are a necessity. Therefore, whenever a cavity presents that has not four surrounding walls, the missing walls must be supplied by artificial walls. This is done by the application of the matrix. It is to be used in filling all proximal cavities, and in any others in which one wall is broken down.

THE MATRIX. When a proximal cavity is otherwise ready for filling with amalgam, a slip of thin metal plate (copper, brass, German silver or steel) is cut of sufficient width to extend from the occlusal surface of the tooth to near the gingival line, or far enough to fully cover the gingival margin of the cavity, and long enough to encircle about half the tooth. The rubber dam having been applied before the excavation of the cavity was completed, this slip is passed between the teeth and roughly fitted to see that the width and length are right. Then at the corners to the gingival a little ear is turned with the pliers that will prevent a ligature from slipping off to the gingival, when it is drawn tightly around the tooth. Also the cut ends of the metal should be so bent that the sharp angles will not cut the ligature. Several plans of preparing matrices are shown in Figures 411, 412, 413, 414. The matrix is passed between the teeth so as to cover the proximal portion of the cavity. Then a ligature is thrown two or three times around the tooth, including the matrix, tightly drawn and tied. Figures 415, 416. This is often a difficult operation for the beginner, but after a little experience the manipulation becomes easy enough in most cases. A few cases occur where the conditions are unfavorable and try one's wits, but these can be successfully done by a little effort.

It will sometimes be difficult, in cavities extending far to the gingival, to slip the edge of the matrix between the proximal surface of the tooth and the rubber; a fold of the rubber will be caught between the matrix and the tooth. In such cases the central part, bucco-lingually, of the gingival edge of the matrix should be bent convex toward the cavity, so that it will catch on the gingival wall as the matrix is slipped to place. Figure 414, *n*. With the smooth flat burnisher, placed in the cavity, the edge of the matrix may be pushed over the margin of the gingival wall and the rubber will be carried before it. In cases in which very large restorations are to be made with amalgam, the ligature will be inclined to slip toward the occlusal and not hold the matrix tight at the gingival. In such cases, the matrix should be prepared as shown in Figure 414. Two little cuts should be

made on either side of the widest part of the matrix, as shown in Figure 414, B. These little pieces may then be raised and the ligature placed under them, as shown in Figure 414, c, and it can not slip occlusally.

I have tried all kinds of ready-prepared matrices, but have found none of them so satisfactory as those prepared by the operator for each case. Whatever form of matrix is used, it should be secured very firmly in place to withstand heavy pressure on the amalgam.

SEPARATION. When the matrix has been placed, the Perry separator should be applied over the matrix, or in many cases, the matrix may be held with the separator without the ligature. It is just as important to separate the teeth for amalgam fillings as for gold fillings, and on no account should this be neglected in proximal fillings where there is a proximating tooth. After the desired separation has been secured, the matrix should be formed to the shape that the proximal surface of the filling should be when finished. Figure 417. If a soft matrix material is used, it may be formed with a burnisher. If a stiff material, such as steel, is used, it will not remain against the proximating tooth if forced there, but will spring back. It may easily be made to stay by using two instruments at the same time, forcing the matrix against the proximating tooth with one, while pressure is made first from the buccal and then from the lingual with the other, forcing the buccal and lingual portions of the occlusal edge of the matrix tightly against the buccal and lingual surfaces of the tooth over which it is applied. After the preparation is otherwise complete, a careful examination of the gingival margin of the cavity should be made to see that the matrix is close at that point, and if it is not, it should be brought close, by inserting a small, soft wood wedge from the lingual side with just sufficient force to bring the matrix close. This is most likely to be needed in molars that have broad, flat, proximal surfaces.

PLACING THE FILLING. When everything is in readiness, the alloy and mercury, which have been previously measured, are mixed, kneaded and packed, as has been described. The importance of the best form of instrument for packing amalgam can hardly be overestimated. Until I had examined this over and over again, experimentally, under conditions which enabled me to determine results, I had no idea of the importance of the instrument forms for this purpose. The one thing needful in packing amalgam is to grasp the mass as a whole as nearly

as possible, and compress it into the cavity. The whole principle of making perfect work is contained in the one word, *compression*. Therefore, the cavity must be a simple one with complete surrounding walls, or must be converted into a simple cavity by supplying any missing walls with the matrix. Then the instrument point should be flat and as large as the cavity will conveniently admit, and, when practicable, its form should be such as to fit the cavity as nearly as possible. With it and the walls of the cavity the mass of amalgam should be grasped as perfectly as possible and powerfully compressed, so as to force the amalgam into all parts of the cavity. About all the force the hand is capable of should be brought upon it and maintained for an instant. Then more of the mass is added and again pressure applied. This should be done as rapidly as perfect work will admit, until the cavity is full and much more than full. As previously stated, the pressure should be heavy and direct. There should be no burnishing. If a burnisher is passed over the surface of the amalgam, from one side of the cavity to the other, before it is at least partially set, the amalgam will be drawn away from the wall on one side as it is pressed against the wall on the other. If the burnisher is passed over the surface in the opposite direction, the crevice previously made on the one side will be closed and the amalgam will be drawn away on the other. This may be readily observed with an ordinary magnifying glass.

TRIMMING. After the amalgam has been packed into the cavity, it should be allowed to set for from one to three minutes undisturbed. The excess may then be removed with a flat burnisher, but without making pressure on the mass of the filling. The burnisher may at this time be used about the edges of the filling to press the amalgam against the margins, but it should not be carried from one side of the surface of the filling to the other. The amalgam should then be trimmed to form with sharp instruments. In proximo-occlusal fillings, the occlusal portion should be trimmed first, to give the proximal portion more time to harden before removing the separator. The spoons, discoids and chisels should be used for trimming occlusal surface fillings; the chisels for the margins, a part of the edge of the blade extending over the surface of the enamel, while the remainder trims the filling even with the surface. The chisels and finishing knives may be used in the same manner for trimming gingival third fillings in buccal surfaces.

In proximo-occlusal fillings, when time enough has been

given, cut away the ligature that holds the matrix and pull away the separate threads. Then if the separator has not been placed on the matrix, strain the teeth apart a little to loosen the matrix from the grasp between the filling and the proximating tooth, and remove it. In most instances, the separator should be set on the matrix, Figure 417, and should be removed first. The ends of the matrix should be straightened to the buccal and lingual. If the teeth had not previously dropped together and the amount of separation was not excessive, the matrix may generally be easily removed by placing a finger under either end and gradually working it out occlusally. Or the lingual end may be cut off close to the tooth and the matrix drawn out to the buccal. In either case, one must learn to judge the force that may be used without danger of breaking the filling. If the matrix is held too tightly between the amalgam and the proximating tooth, both the buccal and lingual ends of the matrix should be cut off and the separator replaced with the ends of the matrix between the mesial and distal half of the separator, or between the separator claws that grasp the distal tooth and the claws that grasp the mesial tooth. Figure 418. The separator should then be tightened until the matrix is loosened so that it can be removed from between the teeth. If the separator is replaced for this purpose, it should remain while the proximal portion of the filling is trimmed to form. By carelessly pulling out the matrix from between the filling and the proximating tooth, the filling is liable to be broken.

All overlapping amalgam should be removed from the margins with the finishing knives (Figures 380, 381, 382) at this time, while it is comparatively easy to cut, for, in twenty-four hours it will be very hard. A very narrow polishing strip of medium grit may be passed through from buccal to lingual, to the gingival of the contact point, and the gingival portion of the filling smoothed by drawing the strip back and forth a few times. This done, the dam should be removed, the gums carefully washed and kneaded, and the patient discharged until a later day.

POLISHING. At the next sitting the filling is to be polished. This polishing is done in the same way and with the same instruments as the polishing of gold fillings. It should be done with the same care, and just as perfectly in every part. Also the same care should be taken in separating the teeth, in the formation of the contact point, and for the same reasons. Nothing less will be doing justice to the material. Nothing less will be doing justice to the operator, the patient, or to the public. For the public



FIG. 415.



FIG. 416.

FIGS. 415, 416. Tying on the matrix.

FIG. 415. A buccal view of the matrix tied in place on a molar tooth, showing the several laps of the ligature tied with the surgeon's knot.

FIG. 416. An occlusal view of the same tooth with the matrix in place and showing the occlusal view of the cavity. A little earnestness in gaining facility in placing this form of matrix soon removes the principal difficulties. It is then done easily, quickly and gives the most perfect fitting matrix yet devised.

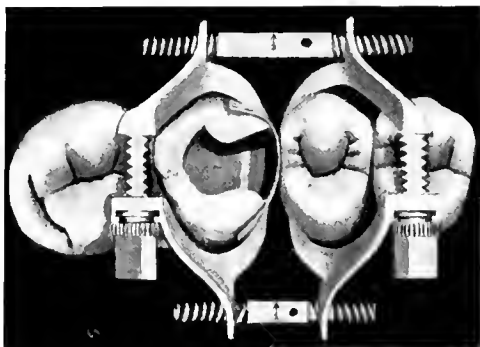

FIG. 417.

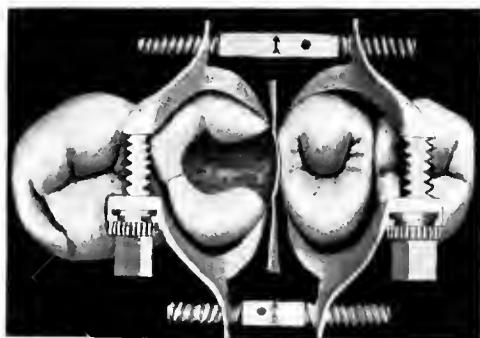

FIG. 418.

FIG. 417 shows the matrix held in position by the separator. This form, which is quite fully explained by the illustration, is a good and efficient method of using the combination of the two instruments. When the separator has been placed on the teeth and tightened just enough to stay well in place, the matrix is easily forced between the tooth and the claws of the separator and is then firmly held and tightened against the tooth. Or the matrix may be tied in place and the separator applied later.

FIG. 418. When the filling has been placed and the occlusal surface trimmed to form, and some time has been given for the amalgam filling to become hard, the separator is loosened and removed; then the ends of the matrix are straightened out to the buccal and lingual, as shown. The separator is then replaced and tightened until the grasp of the two teeth on the matrix is loosened. The matrix is then removed and the proximal portion of the filling trimmed to form. Finally the separator is removed.

whom we serve has the right to expect the best service professional men can give.

A FINAL WORD REGARDING AMALGAM. The idea that amalgam is a cheap filling, to be done quickly in "any old way" should be discarded forever. The dentist should have the same pay for time in making amalgam fillings as in making gold fillings, and take the time to do it well. If he does his duty as well, the service to his patient in proportion to the time employed, will be just as valuable.

Fillings properly made of the modern amalgams are a close second to gold in their durability and in their protection against the recurrence of caries. The difference is that the amalgam filling is the more difficult to make perfectly. It is more difficult to learn the manipulation, and, even then, it is more difficult to secure perfect results regularly, filling after filling. With the modern amalgams, there should never be any discoloration of the cavity walls. Any such discoloration is, in every case, an evidence of leakage, just as much so as in gold fillings. The exposed surface of the filling turns black or brown, but the tissues of the tooth should not discolor any more than with gold fillings. This has been abundantly demonstrated. Any discoloration of the tissues of the tooth shows a fault, either in the manipulation or in the amalgam.

PORCELAIN AND GOLD INLAYS.

AT the present time porcelain and gold inlays are in the developmental stage and discussion is more suited to the general journal literature than to books. The probabilities are that anything written now, will, within a very few years, become obsolete by reason of improvements and changes of methods of procedure. The importance of the subject may become much greater than now by reason of important discoveries or improvement of methods, or with further experience may become much less than now appears probable. The usefulness of inlays may possibly prove to be confined to a very narrow field. At present, however, there are indications that they will continue to command wide attention. The inlay is being developed by quite a liberal number of enthusiastic men who believe there is a great future for inlays of the various types. More time, however, is necessary to determine the actual usefulness of the inlay to our people, particularly as to whether this will become general or be confined to a few special lines, such as for the desirable esthetic effects of porcelain in exposed positions. For these reasons an exhaustive treatment of the subject will not be undertaken in this book. General statements only will be made.

Inlay work must, as yet, be regarded as in its infancy. It has not yet reached its full development as to the best plans of prosecuting the work, nor has its power of controlling recurrence of decay been fully determined. While this remains true, anything that may be said regarding the selection of cases for inlay work must be regarded as tentative and subject to such modification as future developments may require. The indications at the present time seem to be that the power of the inlay to control caries will be much less than well planned and well made gold fillings. For the most part, those who have made inlays, whether of gold or porcelain, have indulged in very wide cutting, which has had the effect of laying the cavity margins in lines in which caries does not occur, and have compared the results with gold fillings made without proper care in the laying of cavity margins in lines of immune areas. The inlay is not capable of the same quality and kind of anchorage, and in

most instances is less securely placed than a correctly made metallic filling. The cement used in securing the inlay in position is often very unreliable, and even when it holds well, it is subject to waste about its margins, which gives rise to roughness and lodgment of débris. The enamel margins of the cavity can not be prepared in the best form to stand when porcelain is used, and both these and the margins of the inlay are liable to become chipped and roughened, all of which tend to invite recurrence of decay. This can, to some extent, be modified by placing the cavity margins near the axial angles of the teeth, where they will be best cleaned by the excursions of food in chewing. The same thing can and should always be done in the cavity preparation for gold and amalgam fillings. But whatever the usefulness of the inlay may be in the future, time will be required for its determination. Therefore, for the present, great care should be exercised in the selection of cases.

SELECTION OF CASES FOR PORCELAIN AND GOLD INLAYS.

FIRST. Those cases most prominently demanding esthetic consideration. Porcelain should be used. We should confine our selection to cavities, which, if filled with gold, would show so much gold as to materially injure the facial expression of the individual. This may again be defined as any showing of gold that will call prominently the attention of associates, or in public singers and speakers the attention of an audience. Many persons will prefer the more esthetic appearance of neatly made inlays for the time, running the risk of greater mutilation of the teeth by decay in the future. For the most part, these will be young adults or those not long past maturity.

SECOND. Those cases in which the apparent immunity to decay is such as to give the greatest promise of permanence. Porcelain should be used when prominently exposed to view, but cast gold should be preferred in all other positions. There are many, especially among those of mature age, if we know how to select them, for whom inlays may be made with much certainty of success so far as danger of recurrence of decay is concerned.

THIRD. Cases in which gold filling is contra-indicated on account of injury to the peridental membranes through disease that renders the malleting required for the condensation of gold unusually painful or positively injurious. These conditions occur in both the front and the back teeth. Porcelain should be used when prominently exposed to view, otherwise gold inlays. Recurrence of decay is not to be expected, as the general condi-

tion of body in which disease of the peridental membrane occurs and in which the teeth decay are rarely seen together, or at the same period of life. Therefore, as the weakened membranes should not be tortured by the malleting of gold, the inlay should be chosen on all proper occasions.

FOURTH. Cases in the back teeth in which there is great loss of tooth substance, in which crowns or very large amalgam fillings have formerly been used, but in which inlays may be anchored. Metallic inlays should be used. Cases are continually occurring in any considerable practice, usually where fillings placed years before have broken away and in which very much of the crown of the tooth is gone, making a large filling necessary. A gold filling is practically prohibited, because of the malleting, and yet, anchorage for an inlay may be had. In many of these cases a well constructed inlay may be used instead of a large amalgam filling or a crown.

The first and principal objection to gold filling is the unsightly appearance of large fillings in the front teeth, particularly of young adults, who are much in social life, and those who are much before the public as singers or speakers. Notwithstanding this, gold fillings have done excellent service in the past in saving teeth that were badly decayed, and we may rest assured that our communities will give up little of the more substantial benefits derived from gold for the more esthetic appearance offered by porcelain. Porcelain must prove itself the equal of gold in saving teeth from decay, or it will speedily be consigned to a few special uses, or to use in a few selected classes of cases.

Whether or not a porcelain inlay will give a better appearance than a gold filling in any particular case, will depend upon the comparative neatness of the adaptation to esthetic conditions in the two cases. A gold filling in view always declares itself without question and is a decided blemish if not neatly done. When well done and in good form, it gives an expression of neatness and good taste that does much to obliterate the very unesthetic sensation of "a patch." On the other hand, a porcelain inlay that is ever so little out of form, or off color, or shows a dark cement line, so that it is noticed as something wrong, is a blemish undefined and questioned by every observer. Nothing violates esthetic principles more radically than this condition of question. Therefore, the porcelain inlay, to be successful from the esthetic standpoint, must be unseen. It must be practically perfect work, or the well made gold filling is better from

the esthetic point of view. It is for this reason, very largely, that the porcelain inlay is not to be used in teeth from which the pulps have been removed. If the inlay be adjusted ever so nicely and the tooth becomes opaque later, the inlay will be off color and become a blemish that will be worse than the showing of a gold filling. When the pulp has been removed from a tooth and the root canal filled under favorable conditions, I should not hesitate to place a porcelain inlay, for I should not expect an amount of discoloration that would be noticeable. If, however, the tooth had come to me with a dead and decomposing pulp, with abscess, or with the root canal open to the saliva, I should expect discoloration that would prohibit the use of porcelain.

PREPARATION OF CAVITIES FOR INLAYS.

In the preparation of cavities for inlays, the general principles of procedure are the same as described and illustrated in this volume for other fillings in securing outline form, resistance form, removal of decay, and in the use of instruments for all of these purposes. The retention form is different. No convenience form is necessary other than wall inclinations that are absolutely necessary for the removal of the matrix or model. The finish of the enamel wall is different for porcelain. In the main, the cavities should be of the same outward form, except when certain extensions and enlargements must be made in case porcelain inlays are to be used, in order to obtain a greater bulk of porcelain for strength. The preparation for retention is different in that the inlays are cemented in place and the cavity walls must be so cut that a perfect impression may be drawn from them without in any wise marring its form. This is necessary in order that the inlay may be correctly made and placed in the cavity. Other changes are not necessary.

Many devotees of porcelain inlay work quickly forgot all of their previous conservatism in cutting away valuable tooth material and swung to greater width of cutting than the most enthusiastic of those practicing extension for prevention had ever done, and with much less regard for correct cavity outline. This extravagance needs correction and toning down to reasonable and correct lines that will have more regard for the structure of the enamel and the direction of its rods in the different positions on the surfaces of the teeth. This is necessary in order that there may be less clipping of the margins of both the enamel and the inlay when porcelain is used. In the bicuspids and molars, all proximal cavities involve the occlusal surface, and in

the few cases in which porcelain should be used in such cavities, the margins should be cut squarely outward over the marginal ridges, from a central point chosen in the occlusal portion. They should then follow the long axis of the tooth on all of the occlusal half or two-thirds of the length of its crown. It is on these lines that the enamel margin prepared at right angles to its surface can nearest meet right angles in the margins of the porcelain inlay, and yet be cut in the line of the length of the enamel rods. This will give the enamel a stronger margin. Also, in that case, the excursions of food under stress in chewing will be along the length of the joints, and will keep them cleaner with the least tendency to chipping. When the margins are laid diagonal to, or across, these lines, excursions of food under more or less stress cross them and there is increased chipping with less cleanliness.

In preparing cavities for gold inlays, there seems to be no reason for changing the cavity outlines materially from the forms illustrated in this volume, except as this may be required to remove the impression and set the inlay. They will need modification only in the matter of retention. In this it must not be forgotten that the inlay depends only on the cement for retention. No grasp of the cavity walls, such as may be had on gold fillings, can be had upon the inlay. To make amends as far as possible for this difference in rigidity of placement, the cavities should be as deep as practicable to increase their stability.

CLASS 1. CAVITIES BEGINNING IN PITS AND FISSURES. PORCELAIN AND GOLD INLAYS. There does not seem to be much indication for inlays in occlusal surfaces, yet there are some conditions which have been noted in which they are desirable. The rule is, that cavities in occlusal surfaces are easily and quickly filled with gold foil or amalgam, and that these fillings are very effective. Further, they are so much out of sight that there is no special reason for using porcelain. If inlays are used in occlusal surfaces, they should generally be gold inlays, seldom porcelain. The only other cavities of this class, in which porcelain might be indicated, are the buccal pits in molars. For these, however, gold foil is generally to be preferred.

There seems to be a serious objection to the use of porcelain inlays in these surfaces for people in whom there is still a strong tendency to caries, especially those who use their teeth vigorously, because of chipping of the margins and a reproduction of the conditions for the beginning of decay.

In order to make porcelain inlays, the margins of which will stand best, the cavo-surface angle of the margins of both the cavity wall and of the porcelain inlay must be right angles, never acute angles. This requires that in the preparation of the cavity, the dentin and enamel walls be cut at right angles with the surface of the tooth and that these shall not be beveled. This is a condition very difficult and often impossible to obtain upon the very irregular forms of the occlusal surfaces. If we bevel the cavo-surface angle, or leave it obtuse in cutting the cavity wall, which must generally be done on the slopes of the central fossa, it must be joined by an acute angle of porcelain. This acute angle of porcelain is very liable to break away under the stress of mastication, even if the inlay can be set without chipping it. In positions in which both may be finished at right angles, both are still liable to chip at any point, unless there should be no occluding tooth. First, the cement will wear away a little, then the angle of the enamel wall or porcelain wall, or both, will chip a little, thus exposing more cement, and so the process goes on until the conditions for the recurrence of decay are produced.

With the metallic inlay, there is no objection to beveling the cavo-surface angle, as the margins of cast gold are very strong, can be more closely fitted and can be depended upon to stand the stress of mastication. They are, therefore, to be preferred to porcelain in these positions.

In preparing occlusal surface cavities for gold inlays, the walls must be so cut that they will flare out a little from the pulpal wall to the orifice of the cavity, just enough so that a matrix or impression fitted to every part of the cavity walls will be easily withdrawn. Otherwise than this, there should be but little change from the preparation for gold fillings.

As porcelain in small masses is frail and very liable to breakage, the cavities prepared for porcelain inlays should be as deep as the conditions will allow, in order to give more strength to the inlay. We should not simply follow deep grooves to a point that will make a good finish and fill these with little arms of filling material, as we may do with metal, for, with porcelain, these will break. We must, therefore, cut the occlusal surface boldly away to include such grooves. For the cast inlay, this depth of cavity is not required because of lack of strength of the inlay, but it is required to reduce the danger of displacement.

CLASS 2. CAVITIES IN THE PROXIMAL SURFACES OF BICUSPIDS AND MOLARS. PORCELAIN INLAYS. With the experience thus far

had with porcelain inlays, it may be said that the general rule should be that cavities occurring in the proximal surfaces of the bicuspids and molars should be filled with metal — gold or amalgam. But some cases occur, especially in the upper bicuspids and less frequently in the upper first molars, in which decay has so undermined the mesial portion of the buccal cusp, and the prominence of the teeth is such that a gold filling will be unsightly when the undermined enamel wall has been properly cut away in the preparation of the cavity. These cases seem to call for porcelain inlays for the better esthetic effect. The general rules for the preparation of such cavities for porcelain inlays will be almost the same as for gold, including the same form of step, except that there must be no beveling of the cavo-surface angle in any of its parts, except along the gingival. Neither should there be any undercuts or convenience points, such as are made for starting gold fillings. Margins running from the occlusal surface over the marginal ridges should extend outward from a central point, being cut at right angles with the surface of the tooth at every point, for, in this case, they will be parallel with the length of the enamel rods. See Figures 105-107. In the mesial portion of the cavity, the buccal and lingual dentin walls should be cut in a line with the long axis of the tooth or flared only enough toward the occlusal so that a matrix or impression may be easily removed to the occlusal. The gingival dentin wall should be perfectly flat, in the horizontal plane, and as broad as the conditions will allow, in order to give the firmest possible seat to support the inlay. The occlusal portion of the cavity and the step should be prepared on the general principles laid down in the preparation for inlays in occlusal surfaces. In this case, however, it becomes especially important that the step in the occlusal portion of the tooth be so prepared that a slightly dovetailed form be made to better support the inlay from being displaced toward the proximating tooth. This step should be as broad and deep as the conditions will allow, in order to give the greatest possible strength to the inlay, and the dovetail should be so cut that a matrix, snugly fitted to its walls, will readily slip out to the occlusal.

In case the cusp of the tooth has been so weakened by decay as to be in serious danger of being broken by the force of the occlusion, it should be cut away at once. In some cases, this cutting may extend only just over the point of the cusp enough to give a good body of porcelain on the cusp. At this point the enamel rods are so inclined toward the cusp that the cleavage will

allow of a somewhat acute cavo-surface angle that will be strong and safe. See Figures 105-107. In that case, the porcelain, after rounding over the cusp, may have a strong obtuse angle against the enamel. Other cases will not be favorable for this and will require that more of the cusp be cut away in order to give sufficient strength, possibly to one-third or one-half the length of the tooth. In this latter case, unless the pulp of the tooth has been removed, it will become very difficult to obtain sufficient anchorage in bicuspids because of the lack of sufficient tooth substance. It will sometimes be better to remove the pulp in order to use the pulp chamber for additional anchorage. Then the horns of the pulp chamber may be cut out to the occlusal for the purpose of forming the anchorage, and the whole length used to a level with the gingival wall.

If there is a mesio-occluso-distal cavity in a bicuspid from which the pulp has been removed, both cusps may be cut away about one-third the length of the tooth and a porcelain inlay built up that will replace the entire occlusal surface. In such a case, the greatest care must be exercised in forming the anchorage, and also in so arranging the detail of the cavity form that the body of the porcelain inlay will be particularly thick and strong.

In these cases it is supposed that the operator has destroyed and removed the pulp of the tooth himself under conditions that will certainly prevent the future discoloration of the remaining parts of the tooth; or under conditions in which no products of decomposition have found their way into the dentin. In any case where there has been abscess, or in which the pulp chamber has been open to the fluids of the mouth, we may expect that products of decomposition have been absorbed into the dentin which will cause more or less discoloration and destroy the esthetic effect of a nicely fitted inlay. With the condition last mentioned, it is better to cut away the crown and replace it with a porcelain crown. This will be stronger, if well done, and will not be subject to discoloration. As a general principle, it is wrong to place porcelain in any pulpless tooth, because of the liability of the tooth changing color. A gold filling or gold inlay is better. It is a principle, as has been stated above, in esthetic appearance that a thing off the normal that declares its true character at once is better than one that places the observer in doubt. This is just what a porcelain restoration a little off color always does.

GOLD INLAYS. The preparation of proximal cavities in the

bicuspid and molars for gold inlays should be the same as for porcelain, with the exception that the cavo-surface angle should be beveled the same as for a gold filling. There should be good depth in the step portion and also a dovetail to give the best retention form.

Gold inlays are much oftener indicated than porcelain in cavities of this class, principally on account of the fact that the gold inlay permits of a strong and safe cavo-surface angle of the enamel wall, and the inlay itself presents a margin which will not be injured by the occlusion of the teeth of the opposite jaw.

CLASS 3. CAVITIES IN THE PROXIMAL SURFACES OF THE INCISORS AND CUSPIDS, WHICH DO NOT REQUIRE THE REMOVAL AND RESTORATION OF THE INCISAL ANGLE. PORCELAIN INLAYS. In this case the preparation for placing the rubber dam will be the same as for gold fillings. Generally the separation for gaining space between the teeth will be the same, and about the same amount of room will be required. But there will be many cases occurring where the cavities are large and extend far to the gingival, in which the claws of the separator will be in the way of the margins of the matrix that must be fitted to the walls of the cavity and also to all parts of the surface of the tooth about its borders. In such cases, the Perry separator should be placed and a part of the preparation of the cavity made at the first sitting. The space gained by the separator should be as great as is consistent with safety to the membranes of the teeth. Then the cavity formed should be filled temporarily with gutta-percha, extending firmly against the proximating tooth in such form as to maintain, after the removal of the separator, the full separation that has been gained. This should remain in place several days, when, at the next sitting, the gutta-percha may be removed and the teeth will remain apart, without the separator, long enough to complete the operation. In a few cases it may be required that this be done the second time to gain sufficient space.

This separation may also be obtained by the older methods of separation with rubber wedges or other means of slow wedging, but these cause so much more soreness of the teeth, and so much more pain and trouble to the patient, that the more convenient Perry separator should generally be employed.

The first thing to be considered in the preparation of proximal cavities in the front teeth for porcelain inlays, is the fact that the inlay must be inserted in one piece, and as the teeth can not be separated sufficiently for the inlay to be inserted in the direction of the orifice of the cavity as prepared for gold

filling, the cavity must be so cut that it may be inserted from either the labial or the lingual. This requires that one of these walls be cut away to, or almost to, a level labio-lingually with the axial wall, less the room the opening of the embrasures between the teeth will give for slipping the inlay in at an angle, which will be of value in a certain proportion of cases. Therefore, in each case a choice must first be made as to which of these walls must be removed. Generally, this will depend upon the direction and extent of the decayed area. If the decay has burrowed mostly to the labial, leaving a large portion of the labial enamel plate unsupported and much weakened, this wall should be removed boldly to a level with the axial wall, or to such an extent that the opening of the labial embrasure will allow the inlay to slip into place. As much of the lingual wall should be retained as is consistent with good strength and a sufficient extension to make the case good against recurrence of decay. If the lingual wall is decayed most and much the weaker, this wall should be removed and the preparation made for the insertion of the inlay from the lingual, retaining as much of the labial wall as is consistent with proper strength. At this point I should warn the student that a porcelain inlay must not be cemented against unsupported enamel in any position exposed to view, because the cement is opaque, and this opacity, showing through the transparent enamel on the labial surface, will destroy the harmony of color that we depend upon for a good esthetic effect. In either case the gingival dentin wall and the incisal dentin wall should be cut about parallel with each other, though a very slight undercut of the incisal wall may give better retention when the handling of the matrix, described later, can be managed. If the inlay is to be inserted from the labial, the gingival and the incisal walls should be so cut that they will open in the labial direction just enough so that, in pushing the inlay into place, it will tend to close upon the cement between it and both of these walls in such a way as to secure the perfect cementing of these joints. In these cavities the greatest difficulty is found in adapting the platinum matrix to the walls of the cavity and to the surface of the tooth about the cavity margins and to have space in which this may be removed from the cavity without danger of so bending it as to change its form. This will often require more separation than that required for the insertion of the inlay and will occasionally call for excessive separation or excessive cutting in the opening of the cavity. The rule should be that the matrix, after being loosened from the cavity walls, should read-

ily slip out to the labial, or to the lingual, and that the overlaps upon the surface of the tooth that interfere with this movement should be cut as short as practicable.

For convenience in all parts of this operation, the labial opening of the cavity is much the preferable one, and should be chosen whenever the final results can be made as good. The manipulation in this preparation becomes especially easy when the work is done from the labial, on account of the broad and direct approach to all parts of the cavity. Very much of the work of preparation may be conveniently done with chisels and burs. This must be so managed that the cavo-surface angle of the cavity shall be a right angle in all of its parts, or as near an approach to this as the direction of the enamel rods will allow and at the same time subserve other requirements.

It should always be made a special object to so cut the cavity wall that its marginal edge shall be presented directly toward the observer at the most important position of observation, for, in this position, the cement shows least. If it is not so placed, the seam of the opaque cement will show through either the porcelain or the tooth tissue, both of which are translucent, and destroy that harmony of color which goes to make up a good esthetic effect.

The cavity wall forming this angle should be trimmed perfectly smooth with keen-edged chisels, used with a very light planing motion as nearly parallel with the length of the margin as possible, being careful that the angle is perfectly sharp. Often, especially in the incisal portion of the cavity, this enamel margin, if finished at right angles with the tooth's surface, will be exceedingly frail and easily chipped, and requires the most delicate handling, both in its final preparation and in the fitting of the matrix. In this case it is better to incline it in the direction of the length of the enamel rods and run the risk of chipping the sharper edge of the inlay.

GOLD INLAYS are not indicated in cavities of this class, except in cases in which the condition of the periodontal membrane is such as to interfere with malleting foil.

CLASS 4. CAVITIES IN THE PROXIMAL SURFACES OF INCISORS WHICH DO REQUIRE THE REMOVAL AND RESTORATION OF THE INCISAL ANGLE. PORCELAIN INLAYS. There is no other place in operative dentistry in which esthetic considerations call more loudly for restorations with porcelain than in the building up of lost angles of the incisors. However desirable this may be, the success thus far in retaining porcelain restorations continues to be disap-

pointing. While this expresses an estimate of the general result, a considerable number of cases have been successful for a sufficient length of time to show that some that are especially favorable to this class of restoration should be undertaken. But it must be distinctly understood that the strength of anchorage that may be had in restorations with gold foil can not be had with porcelain. The cases must be chosen from those giving the greatest opportunity for such anchorage as is fitted for the special forms of anchorage best adapted to secure porcelain in position. Much trial has been made to determine this, but it is yet doubtful if the best plan possible has been developed. Generally the choice should be between a porcelain restoration and an artificial crown. Therefore, with patients who are old enough for root fillings to be thoroughly good, if the porcelain fails, there is no actual loss to the tooth by the trial, for the artificial crown can be placed just as well afterward as in the first instance. In many cases a gold foil restoration is to be preferred to the artificial crown. The gold restoration has a much better prospect of years of usefulness, and, as with the porcelain, an artificial crown can be as well placed after its failure as in the first instance.

GOLD INLAYS are generally not indicated in cavities of this class, except in cases in which the condition of the peridental membrane is such as to interfere with malleting foil.

CLASS 5. CAVITIES IN THE GINGIVAL THIRD — NOT PIT CAVITIES — IN THE BUCCAL, LABIAL OR LINGUAL SURFACES OF THE TEETH. PORCELAIN INLAYS. Cavities of this class, particularly those occurring in the front teeth, when they are much exposed to view, are especially suitable for porcelain inlays, and for esthetic reasons the inlay is very desirable.

For the reception of the inlay, the preparation of the cavity should be different from that prepared for gold foil in several important particulars. Instead of being as shallow as the penetration of decay will permit, it should be cut as deep as safety to the pulp will allow, so as to give as much body of porcelain as practicable to give greater strength. All of the extensions should be the same as when gold is to be used, and the general outline should be the same. This part of the work should be done in the same way as described in the preparation of cavities for gold fillings. But there should be no undercuts in any part of the cavity nor should the angles with the axial wall be so exactly squared out, for the reason that it is more difficult to force an excess of cement past square angles in setting the

inlay. It is better that these angles be left somewhat rounded, as would be done with a round bur about one millimeter in diameter, or with a 12-5-12 or 12-5-23 hoe, the cutting edge of which is rounded like that of a spoon. From this the walls should be finished perpendicular to the surface of the tooth at all points. So finished, the incisal and gingival walls will be very nearly parallel, but not quite, or in such form that they will flare out just a little toward the orifice of the cavity. This should be just enough so that a matrix burnished perfectly to the walls of the cavity in every part will be easily withdrawn. Generally there should be no beveling of the enamel margins, for it usually happens in the cavities of this class that the directions of the enamel rods where the margins are laid are very nearly perpendicular to the surface of the tooth, except at the gingival, where there is the least danger of chipping. When the rods are found inclined much to the gingival, it will be best to make something of a bevel of the cavo-surface angle to strengthen the gingival margin. Also, in any case in which the inlay may extend much to the incisal, a moderate inclination of the enamel wall toward the incisal will be safer than to cut this perpendicular with the surface of the tooth. In placing an inlay, we do not incur the same liability to fracture frail enamel margins as in malleting gold over them, but to leave unsupported short ends of enamel rods on the margins is to invite chipping. The general rule should be to cut the enamel wall, distinguishing this part from the dentin wall, in the line of the enamel rods without bevel of the cavo-surface angle and to take great care to so lay the cavity margin that this preparation will give the least bevel practicable: We can not make a very acute edge of porcelain that will not be liable to chip and become rough, if indeed we can set it in the cavity without chipping. It should be made as nearly a right angle as possible.

CASE. Left upper central incisor with labial decay. Cavity open and occupying the gingival third of the central mesio-distal three-fifths of the labial surface. When the tooth is dried, it is seen that there is a line of injury to the enamel that extends from the open cavity a slight distance mesially and distally. These lines show a chalky whitening of the enamel only; but as yet there is no loss of substance.

PROCEDURE. All overhanging enamel is chipped away from the incisal portion with chisel 10, using the palm-and-thumb grasp, and the dentin wall squared up to a sufficient depth. Then with the same chisel the gingival wall is cut away to sound den-

tin, again using the palm-and-thumb grasp and cutting from mesial to distal. This wall is found solid and clean when the cutting has approached very close to the gingival line, leaving but a slight band of enamel — enough, however, to prevent any wounding of the attachment of the peridental membrane. To the mesial and distal, the cutting is also carried to sound dentin. But the superficial injury to the enamel extends much farther than the decay along the dento-enamel junction, and this must be cut differently. A one millimeter inverted cone bur is started into the dentin close to the free margin of the gum, and, with cut after cut, a slot is formed along the free margin of the gum to the mesio-gingival angle of the tooth and the enamel chipped away to the incisal of the slot. This undermining and chipping to the incisal is continued until the incisal wall of the cavity forms a continuous curve of an arc of a circle a little larger than the curve of the free margin of the gum. The cutting to the distal is extended in the same way. On removing the remaining decay, from the deeper part of the cavity with the spoons 15-8-12, the pulp is found protected by sound dentin. The whole cavity is now deepened from angle to angle as much as seems safe to the pulp of the tooth. The axial wall is made flat in order that the greatest depth of wall to the incisal and gingival can be had to sustain the inlay, and also to give the inlay the greatest possible thickness and strength. The axio-gingival and axio-incisal angles of the cavity are not, however, squared up with the inverted cone but are prepared with a one-millimeter round bur, so as to give a slight curve to the angle to facilitate the passing of cement in removing the excess in setting the inlay. Then the walls are cautiously trimmed to form with the chisel, cutting them perpendicular to the surface. Both the incisal and gingival walls being so cut, the rounding of the tooth surface gives sufficient divergence to allow a well-fitted matrix to be easily withdrawn.

Before the enamel wall is finished, the rubber dam should be in position, and the gingivæ should be pushed and held well back with the Hatch clamp. The enamel wall to the incisal, as distinguished from the dentin wall, should be trimmed with a little more slope outward to remove short ends of enamel rods, causing a slightly acute margin in the porcelain inlay in preference to the almost certain falling away of exposed short ends of the enamel rods. The gingival enamel wall should be trimmed in the same way, and the entire enamel wall should be made smooth with a chisel used with a planing motion.

GOLD INLAYS may generally be used in buccal gingival third

cavities in the bicuspids and molars, instead of porcelain, if inlays are to be used. To this, however, the upper first bicuspids, and often the second also, are exceptions. In persons with very mobile features, the bicuspids come almost as prominently into view as the incisors and cuspids, and similar esthetic consideration is demanded. These cavities are prepared for inlays on similar lines to those described and illustrated for gold fillings, observing the rules for so forming the walls that the matrix, or impression, for the inlay may be withdrawn.

THE PORCELAIN INLAY.

The porcelain inlay having been determined upon and the cavity having been prepared to receive it, the steps in its production are divided into three distinct parts: The production of the matrix in which to form the inlay; forming and baking the inlay, and setting the inlay in the cavity.

THE MATRIX.

The matrix may be formed by any one of several methods, depending partly on the porcelain used and partly upon the previous experience of the operator. As to the porcelain, it is prepared in the form of powders of various colors and shades, called bodies, the ingredients being mixed in different proportions by the different makers, producing varieties. These different varieties fuse at different temperatures. By common consent, the products from these are divided into high fusing porcelains and low fusing porcelains. All of those that fuse at a lower temperature than pure gold are called low fusing bodies, while those that fuse at a higher temperature than pure gold are called high fusing bodies. The choice of low fusing or of high fusing bodies or porcelains for the particular case controls the choice of the material for the matrix. With the low fusing body, gold may be used; with the high fusing body, platinum must be used. Gold foil of the weight or number of 60 is much easier to burnish or swedge to the cavity walls than platinum of similar weight, because of the greater pliability of the gold.

If one has learned to use the platinum matrix, he should have no special difficulty in using gold later. As this is regarded as one of the difficult steps in the process, it should be practiced on extracted teeth until one has obtained facility in handling the material. Cavities on the axial surfaces of the teeth being the easier of management in this part of the work, these should

be selected first. The object to be attained is to fit the thin platinum perfectly to the walls of the cavity in every part and to the surface of the tooth immediately adjacent. This is intended to give a perfect copy of the cavity, and in this cavity formed in platinum the porcelain inlay is formed and baked. This must be so perfectly done that the inlay thus molded will fit the cavity in every part when the platinum has been stripped off. This may be done by burnishing the platinum to the walls of the cavity in the tooth itself, or by taking an impression of the cavity and forming a model upon which the matrix is swedged. Most operators seem to prefer the former method, except in cases where large restorations are to be made. For these the greatest accuracy may be obtained by first swaging and afterward burnishing the matrix in the cavity.

The platinum prepared for this purpose by the dealers is reduced to 1-1,000 of an inch in thickness, and some is prepared thinner. A scrap of this platinum is cut that will not only cover the cavity well, but will also so extend beyond the cavity margins as to cover some portion of the tooth surface surrounding the cavity, giving room for the "drawing in" that will occur in forming the platinum to the cavity walls. This, having been *freshly annealed at a white heat*, is laid with its central part over the cavity, and while held in this position, this central portion is pressed down into the cavity with a little ball of cotton held in the pliers. This should be done gently and cautiously to prevent tearing the platinum by too great a strain in some particular part. In doing this, press the cotton ball about in different directions, allowing the edges of the platinum to tip up some to facilitate the sliding of the platinum down into the cavity, but not so much as to form folds in the material that will be difficult to smooth out later. When some considerable change in the form of the platinum has been produced, it should be removed from the cavity and again annealed at a white heat to restore its former softness. In forming platinum, this annealing is very important, and should be repeated at frequent intervals during the progress of the work. The platinum is stiffened at every bend that is made and its liability to tear greatly increased. The annealing brings it back to its former state of softness, and if the annealing is repeated sufficiently often, and the work proceeds very gently, it may be worked into almost any form without tearing.

After the annealing it is to be returned to the cavity in exactly the same position it previously occupied and the work

with the ball of cotton repeated, pressing the platinum more and more closely to the cavity walls at each annealing until the cavity can be forced full of cotton over the matrix. Then the margins lying on the surface of the tooth should be smoothed down to the surface of the tooth with a steel burnisher used lightly, being careful to smooth out all tendency to the formation of folds.

An examination will show that while generally the platinum is fitted to the cavity walls, it has not been forced perfectly into the angles. It should again be annealed and returned to the cavity, and while held in position it should be gradually forced into all angles with a smooth steel burnisher. Burnishers for this work are provided by the dealers in a suitable variety of forms. The burnishing may be facilitated by cutting a small band from rubber dam and placing this over the tooth so as to cover the matrix and hold it firmly in position. A small hole should have been cut in this rubber and placed immediately over the cavity to work through. This rubber will prevent any tipping of the matrix while burnishing. When this is apparently complete, reanneal and return the matrix to the cavity, and when it is well settled into position, touch it at different points with the point of the burnisher and look carefully for any springing or tilting. If there is any, the part where this occurs is not perfectly fitted and must be burnished down.

Before this burnishing is finally completed, that portion overlapping the surface of the tooth should be trimmed fairly close and yet left sufficiently long to show very plainly the cavity margins and form of the surrounding surface; for this is the guide to the fullness of the inlay. It is often well to leave one convenient point a little long to facilitate handling with the pliers. When the finished matrix is finally removed from the cavity, it should be done with the greatest care not to bend it in any of its parts. To this end, it should be very carefully teased out until well loosened from its bed, when it may be carefully lifted away with the pliers. The pliers for this purpose should have a locking device, so that when once the matrix is taken up it is permanently held. The matrix is now ready to receive the porcelain body for baking.

There are a number of processes in which the impressions of the cavities are taken and the inlays swedged over these as models, or in which a reverse of the impression is made and the inlay formed in that.

An impression of the cavity may be taken in modeling com-

pound or hard wax by coating the walls of the cavity with vaselin to prevent sticking, and may be removed in very perfect condition if allowed to first become fully hard. Either of these, when reinforced with plaster, may be used to swedge upon by the water bag or similar swedging devices of which there are many forms in the market. Or they may be used for making reverse dies by carefully building over them with a good amalgam and allowing this to become hard. For this purpose the impression is usually set in a form with plaster of paris, which gives a cup in which to pack the amalgam. The impression may also be taken in cement either by oiling the cavity, or better by forming the stiffening cement into a globule and rolling it in pulverized soapstone to prevent its sticking. This makes a very hard impression which, when reinforced with plaster, serves well to swedge over with the water bag swedging device. Nearly every man who uses these devices introduces some particular methods of his own to facilitate the work, so that there are almost as many processes as workers, each one doing fairly well with his particular plan of work which he has learned to handle with accuracy. With time, some one of these plans, or one yet to be developed, will prove itself best and become generally used.

There is a serious objection to the oiling of the cavity for the reason that it is impossible by any washing with ether or alcohol to get the walls as clean as they would have been if no oil had been used, and to that extent the hold of the cement upon the cavity walls will be impaired. In this work, cavity walls can not be trimmed after the inlay is made in order to have them perfectly fresh cut and clean, as is done in preparing for filling with gold or amalgam, but deposits from the saliva may be removed by scraping the walls with sharp chisels just previous to setting the inlay, being careful not to cut the walls.

MAKING THE INLAY.

In making the inlay, the great esthetic points are to get the proper translucence and color. Of these translucence should be placed first because it is of even greater importance, if possible, than the exact color. Extracted teeth quickly lose this translucence and become more uniformly grayish white. Therefore, no amount of work on extracted teeth will give a certain guide to obtaining the proper translucence in the mouth. But this work will give facility in handling the material and in obtaining the desired shades, and should be carefully practiced before undertaking work in the mouth. To facilitate the production of

the varying shades of color of the natural teeth dealers have prepared the bodies in a sufficient variety of shades. The tooth operated upon and those in the immediate neighborhood should be carefully cleaned as a first step, and the translucence and color carefully examined, compared with specimens of porcelain made from the bodies at the operator's command, and the color and gradations for translucence determined. This should be done prior to the completion of the preparation of the cavity and before the rubber dam is put on. It is not the appearance of the dried tooth that one is to copy in the porcelain, but the appearance of the clean moist tooth. A tooth well dried with the rubber dam on becomes opaque. One of the principal points in obtaining the proper translucence is to use the more opaque color first, bake or biscuit this separately, then add the more translucent colors in one or more layers, finishing with the enamel body; or in those preparations in which no enamel body is provided, with that shade which is more nearly transparent. This plan of building up the inlay is found to be of great importance in obtaining esthetic effects, and will do much to hide the effects of the opaque cement, which must be used later to fix the inlay in position. Often a prepared inlay will appear as perfection itself when laid in the cavity without cement, but when cemented in place will look very badly because the opaque cement shows through the porcelain and completely changes its tone of color and translucence. In this regard very much may be done by a judicious arrangement of the cavity walls and margins, especially by such an arrangement as will place the edge of the cement line toward the observer. No fixed rules can yet be given in words that will give much valuable information in this building-up process in making porcelain inlays. It must be obtained by practice.

The powdered body is first mixed with water to form a creamy paste of even consistence, using an orangewood stick in preference to a steel spatula for the reason that the smallest particle of iron will cause discoloration of the fused porcelain. Then a portion of the body chosen for the first layer is flowed into the bottom of the matrix, shaken down, and the superfluous water taken up with a little pledget of soft absorbent cotton or blotting paper. For this work, cotton is not so likely to leave filaments in the mass as punk and should be preferred. Indeed, every part of this work must be done in the most cleanly manner possible, as any fiber or mote that will carbonize in baking is liable to destroy the good appearance of the inlay. The shaking-

down process is very important in the matter of gaining solid, strong porcelain, and in preventing shrinkage in baking. Its object is to obtain the greatest possible solidity of the body. It is done by holding the pliers, with the inlay, in the hand and drawing a roughened instrument, such as the edge of a coarse cut eighth round file across an angle of the blade of the pliers. This gives to the body in the matrix a very quick, short vibration which settles it to the bottom, while the water comes to the top and can be absorbed away. This should be repeated until no more water will come to the surface. In this way enough of the body is placed for the first layer and then baked. In baking inlays of considerable size, the first porcelain baked in the matrix should fuse at a considerably higher temperature than that baked on subsequently. If the matrix containing the first bake is returned to the cavity and found to fit, there will be little danger of warpage in subsequent baking of the porcelain which fuses at a lower temperature, as the porcelain constituting the first bake will not be softened. In baking small inlays in which only porcelain fusing at one temperature is used, the first baking need not come quite to a full fuse, but should be very near to it for the best results. The matrix with this portion of the inlay may now be returned to the cavity to see if any bending has occurred, and corrections made if necessary. After this, other layers of more translucent body are added as desired for the particular case, filling the matrix nearly full, but not quite, and baked in one or several layers as may seem most desirable.

At this point especially, it is desirable to return the matrix and inlay to the cavity and carefully reburnish the margins of the matrix to the cavity margins to correct any possible "drawing in" of the inlay margins by the shrinkage of the porcelain in baking, and to observe very particularly the fullness desired in the finished piece. When it is determined no further additions of the principal body are required, the inlay must be finished by the addition of the enamel body, or the final shade when no enamel body is used, in which the rounding out to the proper fullness should be looked to with especial care. With the same care, also, it should be seen that the margins are filled exactly flush at every point, and also that there is no overplus about the margins which will form thin edges that will break away in setting and leave a roughness of the margins. In this final work a magnifying-glass should be used to insure the utmost degree of accuracy. The margins of the inlay should be sharp and definite angles at every point. When this has been accomplished,

the whole is to be returned to the furnace and baked, and in this bake a full fuse to a glaze of the surface should be obtained, taking great care not to heat too much, for this is likely to burn out the color and the translucence, leaving the inlay an opaque gray unsuited to the case. Facility in baking can be acquired only by careful practice. The eye and the fingers must be trained to the work by doing it, as in any other technical process that requires especial skill.

FURNACES FOR INLAY WORK. There are a number of different forms of furnaces on the market for inlay work. Generally a small furnace made especially for this work, or at least one made for very small pieces, should be used. It may be electric or some one of the devices for the use of gasoline or gas. The electric oven is the best, the neatest and most compact. With it there is no perceptible heat, noise or dirt, and it may be used beside the chair. But it requires the electric connections and rheostat for the control of the heat. A considerable variety of forms of these are also on the market. Any arrangement by which sufficient heat can be produced with reasonable regularity of control will do. It may be done over the flame of a good Bunsen gas burner or in the flame of a gasoline blast by having a small muffle of platinum to protect the porcelain from the direct blast.

SETTING THE INLAY.

When the inlay has been completed, the platinum matrix is stripped off. Generally this may be pulled away with the pliers. Occasionally, however, this gives trouble. If the last traces of it can not be removed by picking it away, it may readily be removed by placing it in aqua regia and heating a little.

The inlay should now be placed in the cavity and closely examined to see that the fit, color and all are satisfactory. The method of handling the inlay deserves some attention. It may be taken up in a pair of light tweezers and placed in the cavity, or it may be stuck to the end of some instrument with a little sticky wax. Whatever the arrangement, the handling should be done very lightly and accurately, for there is considerable danger of chipping either the sharp margins of the inlay or the equally sharp margins of the cavity. Both are very hard and also very brittle. The inlay is to be secured in the cavity by cementing with oxyphosphate cement.

In selecting the cement for this purpose, the following points should be observed: The cement should be as impenetrable to

moisture as possible. The adhesive property should be the strongest possible. It should be very finely ground. These points are discussed under the head of "Cements" and need only mention here.

As the inlay is held in position by the adhesion of the cement, this may be increased by etching all of that portion of its surface that is to lay in contact with the walls of the cavity. This roughens the surface slightly so that the cement has a better hold. This is readily done by covering with wax to protect that which is to be the exposed surface of the inlay when set, and then exposing the rest of its surface to the action of hydrofluoric acid for five minutes; then washing off with ammonia, followed by water. The wax may be dissolved away by chloroform. Some operators cut grooves in the inlay, but that seems unnecessary. Scratching the dentin walls of the cavity with a fine-pointed instrument may serve to strengthen the hold of the cement.

When all arrangements for handling the inlay in setting have been made, the cement should be mixed to a creamy consistence and spatulated until it is very smooth and evenly mixed. Then a very small amount should be taken on the point of a small spatula and placed in the cavity and so worked about, either with this or a smaller instrument, that it is seen to take to every part of the cavity walls and displace all air bubbles. In the same way the under surface of the inlay should be covered. A small, flat end toothpick, when cut to proper length and placed into a light steel handle, the end of which is bored and filled with hard wax, makes an excellent spatula for this purpose. A new point can be had for each operation. The cavity should be filled sufficiently to insure that, in the introduction of the inlay, no air will be included between it and the cement at any point.

The inlay should then be placed in the cavity, displacing the superfluous cement by pressure. This is best done by a light zigzag, or very short up-and-down movement, going continually deeper into the cavity until the inlay has settled firmly into position. The adhesion of the cement to both the inlay and the cavity wall will be much increased by this vibratory motion. Then a very considerable pressure should be made and some of the redundant cement removed from about the margins to see that the inlay has gone properly to place. This pressure should now be kept up for some minutes — the longer the better, or until the cement has firmly set. Generally it will be seen, as this pressure is being kept up, that more and more

cement is gradually oozing from the margins, so that really the inlay is sinking into the cavity, thinning out the cement between it and the cavity walls. If the pressure is removed too quickly, and a margin closely watched with a hand magnifier, it can usually be seen that the inlay rises just a little out from its bed; hence this sustained pressure is important. This pressure should not be with steel instruments, for these are too liable to chip the inlay, especially if any slip should occur. Some kind of wood point, as the toothpick mentioned above, is perhaps best for this purpose.

When the cement has become fully hard, the redundant cement should be removed and the operation is complete. It should, however, be protected from saliva by keeping the rubber dam in place for half an hour longer, in order that the cement may become as hard as possible. The qualities of the cement should determine whether it should be kept dry or kept wet while setting. The very hard cements usually shrink badly while setting. This is favorably modified by moistening the cement with water as soon as it is ready to be left to harden. This will make the better joint. Other cements do not require this, but are much softer. The practice of setting porcelain inlays in cavities wet with saliva, is, to say the least, obnoxious. If, with the cement used, it is best to have the cavity wet, let it be wet with clean water.

THE GOLD INLAY.

Originally the gold inlay was made much after the fashion of making the porcelain inlay, the difference being that the gold was flowed into the formed matrix instead of baking porcelain in it. In this it was an outgrowth of the plans for making porcelain inlays. It was intended for use in positions where the esthetic requirements did not demand porcelain, and especially in molars and bicuspid. With the view of cheapening this, gold shell inlays have also been made instead of solid gold, in which the walls and exposed surface only were of gold. In the setting of these in place, the shell was filled with cement.

Recently, however, these forms of gold inlay have been rather suddenly displaced by the demonstration by Dr. W. H. Taggart of plans for casting solid gold inlays under pressure in such a way that they will fit cavity walls much closer than those made by the matrix plan. This casting may be done under pressure of compressed air, nitrous oxide gas, steam or by a vacuum, by which the liquid gold is forced into a heated mold so as to

fill all of its parts perfectly. The process is divided into three distinct parts: (1) an impression made by filling the prepared cavity with a wax specially prepared; (2) forming the mold in which to cast the gold; (3) the process of casting. Each of these has its special devices and at the present time these are in the stage of development. The form they will finally take can not now be stated, but the general ideas of the requirement for practical work in each may now be made out with a fair degree of clearness.

The cavity is first prepared, as has been described in the articles on cavity preparation. (1.) The prepared cavity is then moistened with clean water to prevent the wax from sticking to its walls. Then the cavity is solidly filled with the prepared wax, and a finished filling made in the form of the desired inlay. A metallic pin prepared for the purpose, called a sprue by molders, is attached to this filling by warming and inserting its end into the wax and maintaining it in position until cold. With this, the wax filling is cautiously removed from the cavity. From this wax filling, and its sprue, the mold is made for casting the inlay.

(2.) The wax filling held by its sprue is covered carefully, to see that no air bubbles are included, with a mixture of fine plaster and silex, and buried in a mass of the same mixture placed in a metallic ring, which forms a part of the casting outfit. The base of this ring is convex in its central portion, so that the investing material necessarily takes the form of a small crucible with the end of the sprue protruding into its center. When the investment has become hard, the base and the sprue are removed and the ring is turned over, with the crucible formed in the investment, up; it is then dried by heat and the heat is increased until the wax model has melted and become dissipated in the investment. In order that this may be complete, the wax must have been perfectly cleaned by filtration while melted.

(3.) The apparatus for casting consists of the metallic ring with its contained mold, a blow-pipe for melting the gold and bringing it to a very high degree of heat, and an arrangement for suddenly covering the metallic ring and at the same instant turning on the pressure of condensed air, nitrous oxide gas, or steam. The hole left connecting the mold with the little crucible by the removal of the sprue is too small for even the very highly heated gold to run through by its own weight, but it is forced through it readily by the increased pressure and fills the mold completely and very solidly in its minutest angles, making

a cast that is as sharp as the original wax filling. As the shrinkage of the gold in cooling is less than the shrinkage of porcelain in baking, and also as there is no matrix to be stripped off, the cast gold inlay fits the cavity more perfectly than the porcelain inlay can be made to do. This is a distinct advantage for the cast gold inlay. The sprue having been set in the exposed part of the wax filling, the cast gold representing it is only to be cut away in finishing the inlay to form. Neither is there any objection to casting the inlay from a wax filling that has been finished a little overfull and finishing this perfectly to the margins in every part after it has been set, as any other gold filling.

For the original practice work by students in learning this manipulation, there seems to be no objection to using silver or a more fusible compound of silver and tin. Silver expands at the moment of congealing in cooling from a high melting temperature, and in large masses is liable to "spouting," which is complained of by smelters in forming silver ingots. On the other hand, tin contracts. By making an alloy of 73 to 75 per cent of silver to 27 to 25 parts of tin, this may be equalized by a little careful experiment so that the cast will exactly represent the mold. Such a cast inlay ought to do good service in the mouth as well as good practice service.

The cast gold inlay is particularly adapted to all of those positions in the teeth in which there is no considerable objection from the esthetic point of view, and therefore, as heretofore indicated, is the proper inlay for bicuspid and molars when an inlay is called for. Some exceptions have been noted.

THE CEMENTS.

The cements at present available for use in filling operations are the oxychlorid of zinc, the oxyphosphate of zinc, and the oxyphosphate of copper. Formerly the oxychlorid of zinc cement was much used, but since the introduction of the oxyphosphate, it has fallen into disuse on account of the very irritating qualities of its fluid portion. The oxyphosphate of zinc cement is very much less irritating and is generally preferred for this reason. The cements are received from the dealer in two separate bottles, the one containing the powdered oxid of zinc, or oxid of copper, and the other the prepared phosphoric acid. In use, a small portion of the powder is placed upon a porcelain or glass slab, and a drop or two of fluid is placed beside it. The two are then drawn together and thoroughly mixed by rubbing them together with a spatula. This spatulation should be continued until a very smooth, creamy mass has been formed. The mixture of the oxyphosphate should be much thicker and stiffer than the mixture of the oxychlorid to obtain the best results with the respective cements. Indeed, the oxychlorid may be mixed so thin and soft as almost to flow, and yet become very hard and firm; while the oxyphosphate, to produce the best mass, should be rather stiff, yet it may be quite plastic. The oxyphosphate of copper is handled in the same way as the oxyphosphate of zinc.

As yet there has been very little careful examination of the physical properties of these cements. We do not know accurately the proportions of powder and fluid required to produce the best results. It is probable that these vary with the different makes of these cements, and also with the age of the preparation, for the fluids seem to be inconstant in their properties, and are liable to changes, especially if exposed to the air. It has been the constant habit of dentists to mix them without any rule, simply observing the plasticity of the mass produced, being governed entirely by the eye and observation of results. This must be regarded as a very inaccurate method of using this material, but so long as we are without more accurate knowledge of it than this gives, we can only follow it. Very recently some work has been done on the physical properties of the cements, and it has been shown that most of the cements are readily permeated by moisture, while some are not, and also that some of the cements will shrink badly while hardening.

In mixing the oxyphosphate, it seems to be best to draw the powder into the fluid and incorporate it little by little until the required stiffness of the mass has been acquired. Just what this should be, can not, in the absence of carefully conducted experiments, be definitely stated. In practice it has not been found possible to handle the fluid and the powder in definite proportions. This is usually varied with the particular use to be made of the particular mix. If for setting crowns in which great plasticity is required, the consistency of very thick cream is usually used, and this very thoroughly spatulated and used quickly, or before it has begun to stiffen. If for filling cavities in teeth, more of the powder is added and the mix made stiffer, and the spatulation continued somewhat longer, so that the mass assumes a putty-like consistence. It seems to be the general notion that when mixed in this way a much stronger mass is formed. This idea is strongly supported by some recent physical experiments, yet these have not been in sufficient number nor have they been sufficiently varied as to conditions to give certain working data.

These cements are not impervious to moisture. Some experiments have recently been made as to the qualities of the cements with regard to exclusion of moisture, and it has been found that none of them are actually impermeable. It is true that some admit colored fluid very slowly, while many of those on the market admit moisture readily. As yet, we do not know with any degree of certainty upon what these differences depend. They are, however, very important. Other things being equal, the cement that is nearest moisture-tight is the best for use. Any one may try cements by making experimental fillings and placing them for a day, or two or three, in a solution of anilin dye, and then breaking them open and observing the penetration of the color into the mass of the material. Some of the cements will be penetrated through and through in a very short time, while others will resist for a longer time.

It has also been determined that those which expand in setting are very readily penetrated by moisture, while those that shrink while hardening are less penetrated by moisture. Those that shrink most seem, thus far, the hardest and most impenetrable by moisture; and conversely, the hard, impenetrable cements shrink badly. This shrinkage renders them useless in filling teeth. At present, therefore, we seem compelled to use the medium hard cements for filling operations and for the setting of crowns. In setting inlays where there is so thin a film

of cement, shrinkage may be less important, and their impenetrability to moisture renders their adhesive properties, which are so important in this work, much more permanent. When the harder cements are exposed to moisture while setting, the shrinkage will be reduced and they will be softer. The softer cements are made still softer and still more permeable by being exposed to water while setting.

When made into fillings in teeth the cements do not resist perfectly the solvent action of the oral secretions. They are slowly dissolved, or waste away. They are, therefore, not very permanent fillings. In this regard great differences are observed. In a few cases cement fillings have done excellent service for many years, seemingly resisting the action of the oral secretions perfectly. In the majority of cases, however, they dissolve away within two or three years, and in many instances within a few months. We have not yet such a knowledge of the conditions of these variations as will enable us to control them, and must therefore regard cement fillings as temporary in their nature and qualities, expecting to renew them at frequent intervals. In these respects the oxyphosphate of copper cement is showing better results; however, its black color confines its use to the back teeth.

USE OF THE CEMENTS.

The cements are used for setting crowns and bridges, for temporary fillings, and for preserving for a time teeth that are very badly broken down, or in other conditions which seem to render the use of metallic fillings or inlays undesirable at the time. They may also be used for temporary fillings in cases of very sensitive dentin for the purpose of allaying the extreme sensitiveness, which is generally found to disappear, in large part at least, within a few weeks or months. They may also be used for temporary fillings in cases of hyperemia of the dental pulp with marked advantage, for the reason that their conductivity of thermal impressions is less than that of the metals, though in this respect gutta-percha is much better than the cements; also they may be used in capping exposed pulps.

The cements are also much used for sealing treatments in pulp chambers and root canals. This use of the cements is not good practice. They do not perfectly exclude moisture, and in this work the perfect exclusion of moisture is of first importance. Gutta-percha is much better for this purpose for the reasons, first, that it is impermeable to fluids and moisture-tight

fillings can be made with it; second, it is much more easily removed from the cavity in opening it for changes of the applications. It is very painful to cut out a cement filling when the peridental membrane of the tooth is sore, while gutta-percha may be softened by a heated burnisher and removed with very little pain.

FILLING WITH CEMENT.

In filling cavities with cement the preparation should be well made, all of the walls being cleaned by perfectly removing all carious dentin to sound tooth structure, and the walls and margins trimmed smooth. Some degree of retention should also be given to the cavity form, but this is not so imperative as with metal fillings.

The cavity should be perfectly dry at every part, for in this case we may expect that the cement will adhere strongly to the cavity walls and in part sustain the filling in position. The cement should be mixed with as much of the powder as will work into a plastic mass and spatulated vigorously until it has begun to stiffen, and, when at the consistence of putty, should be packed into the cavity in moderately small masses, using as much force as the consistence will allow, adding piece after piece, until all parts of the cavity are full and overfull. Then a few moments should be allowed for the cement to stiffen a little more, after which the filling may be trimmed to form with the finishing knives. In this trimming the cement should be so stiff that the stickiness shall have disappeared, for it is only just at this time that it can be cut smoothly without dragging. After trimming, it may be burnished lightly, and, if necessary, smoothed with polishing strips. The oxyphosphate of copper cement makes a harder mass and is not subject to the great shrinkage that occurs in the harder qualities of oxyphosphate of zinc. It is therefore much better for filling the occlusal surfaces of the teeth of children or any other fillings for children where its jet black color is not particularly objectionable. It becomes hard enough to wear quite well in occlusal surfaces. It, therefore, serves an excellent purpose in these positions at a time of life when it is especially difficult to make fillings of metal.

After the filling is completed, if the softer or more penetrable cements have been used, it should be protected from moisture for some minutes, the longer the better, as the cement will become harder. It seems that when moisture is admitted early, a part of the phosphoric acid is dissolved out of the cement,

robbing it of a part that is necessary for the most complete hardening of the mass. If, however, the harder cements have been used, the shrinkage will be much greater if the filling be kept dry. The adding of water to the surface soon after the cement begins to harden limits the shrinkage very materially, therefore moisture should be added soon after the cement begins to stiffen enough for a good finish to be made. The rubber dam should be in place and pure water added for wetting the filling. The salts in the saliva seem to form some injurious combinations when admitted to the filling before the setting is well advanced. From what is now known it would seem that for setting inlays, the hardest and most impenetrable cements should be used. With the very thin film remaining between the inlay and the walls of the cavity, the shrinkage can not be of much importance. The more important point is that the adhesive property of the cement, which is depended upon to retain the inlay, is lost if the cement is penetrated by moisture. The cement which will retain this property longest is the best for this purpose. The stickiness of the cements has, however, been very disappointing. Every dental student soon learns that the cement that hardens on his glass mixing slab is easily removed after soaking for a short time in water. The same loosening from the walls of cavities is the general rule. This loosening occurs with the most impenetrable cements. Therefore, after all has been said, the adaptation to the cavity walls, which is in a large degree perfected by the cement, is the chief dependence in holding the inlay.

These general principles should be observed in all uses of cements. Softer masses must be used in setting crowns and some other operations requiring a plasticity approaching a fluid condition, but it should be remembered that this renders the cement less strong and more soluble, and is to be avoided whenever the conditions of the case in hand will allow.

GUTTA-PERCHA.

Gutta-percha is used for various purposes in connection with filling operations. The best forms for this purpose are the ordinary base plate gutta-percha and that known as Hill's stopping. Besides this, however, a multitude of makes for the purpose of filling teeth are found in the market. None of these are superior to the ordinary base plate, and generally they are very inferior. Many of them seem to be mixtures of gutta-percha and wax that soften very readily by heat. These are especially to be avoided. For filling cavities in front teeth, Hill's stopping is the best form of gutta-percha, because of its good color, which is maintained, and because it will wear better. It is much more expensive, however.

Base plate gutta-percha is the best material we have for root filling, for sealing dressings in root canals, and for most of the temporary stoppings used in connection with treatment cases. Under certain conditions it is also an excellent material for more or less permanent fillings in cavities in the teeth.

FILLING WITH GUTTA-PERCHA.

In filling cavities in teeth with gutta-percha, the cavity should be prepared almost as for gold or amalgam, but, generally, convenience points for starting may be dispensed with. The cavity should, however, be made as strongly retentive as possible. When otherwise ready for filling, every portion of the cavity walls should be moistened with eucalyptol or oil of cajuput. These oils take strongly to the cavity walls and also dissolve slightly the surface of the gutta-percha. The oil then diffuses through the mass of the gutta-percha and is lost, apparently, leaving the gutta-percha adhering firmly to the cavity walls. Therefore, for this purpose, the cavity walls should be only well moistened. No considerable excess of the oil should be allowed to remain in the cavity, as the effect will be to soften the whole mass of the filling.

Prepare the gutta-percha by gently warming it over the flame, or upon a warm tray. Care should be had not to heat the gutta-percha too hot. This will develop an inordinate stickiness of the mass and it will not again become fully hard; the quality of the material is permanently injured.

When it is made just plastic by heat, convey it to the cavity in small pieces and build the filling up from the most con-

venient angle or wall of the cavity, piece by piece, sticking the warm pieces to the mass in the cavity with a considerable pressure, and condensing well against all walls and margins. In this work, it is well, if possible, to add no more of the material than will just fill the cavity, having none to remove in trimming. If, however, a surplus has been added, warm a small flat burnisher sufficiently to quickly soften the gutta-percha upon contact, and with this cut away the surplus and immediately condense and adjust the surface of the filling with a cold burnisher that has been laid ready. The finish should generally be made entirely with the burnisher, as we can not polish the surface of the filling by any of the usual means. By waiting until the filling is fully hard, it may be trimmed with a sharp knife, but the edge must be very sharp to cut smoothly. This is the best instrument for removing overlaps and making a good finish of margins.

Another plan of filling with gutta-percha that is useful in many cases, especially in cavities of easy access, is to form a mass that will just fill the cavity and warm it only sufficiently to obtain the necessary plasticity, and insert the whole filling in one piece, condensing with a broad, cold instrument, afterward finishing as before described.

Much experience is required to handle gutta-percha well, but when once the manipulation has been learned, it is not difficult, and requires but little time. It should be the only material used for sealing in dressings, and for the temporary stoppings in connection with treatments.

In the author's practice, careful notes were made on the matter of the discoloration of teeth after removal of pulps, and especially with reference to the discoloration of the teeth as time elapsed. The practice was in families where results could be followed to the best advantage, and in this it was shown distinctly that to prevent discoloration it was absolutely necessary to prevent admission of any saliva or other decomposable material whatever to the dentin after the pulp was destroyed. This was distinctly shown by the fact that when the living pulp was destroyed and the dentin absolutely protected from saliva and other decomposable material, no discoloration occurred. This condition could not be attained in any case where the pulp was found in a condition of suppuration, where it was decomposed or where alveolar abscess had occurred. The amount of discoloration, however, could be made very much less by great care in mechanical cleaning, and especially by rigid care in perfectly sealing the cavity in the intervals between treatments.

The results of this rigid care have been so marked that any other course seems almost criminal.

For this purpose ordinary base plate gutta-percha has proven to be by far the most reliable sealing agent. In this use of it, stickiness is more important than hardness. Therefore, the cavity should be flooded with eucalyptol and every part washed with it to remove all moisture by substitution and then the excess should be removed. Any cotton in the root canal that has become heavily saturated with the oil should be removed and fresh cotton, saturated with the medicament wanted and squeezed dry with a clean napkin, substituted. Then each piece of gutta-percha used against the cavity walls should be touched to the eucalyptol after warming, and before placing in the cavity in order to develop its sticky quality in highest degree. Filled carefully in this way, the gutta-percha will be a little softer because of the amount of eucalyptol that becomes diffused through the mass, but moisture will be perfectly excluded. It is, therefore, worth much to learn this manipulation well. The trial that has been made of gutta-percha for the exclusion of moisture for long periods of time from ocean cables has shown its absolute impenetrability.

Gutta-percha is too soft for permanent fillings in positions that are exposed to the stress or friction of mastication. In some cavities where it will not be exposed to wear, it will do most excellent service. It is especially to be recommended for filling cavities in the buccal surfaces of the teeth of old people, especially those that are in large part in the cementum and extend beneath the free margin of the gum.

It is often useful as fillings in the temporary teeth for children. By renewing it from time to time, these teeth may be made useful until removed in the shedding process. However, children often wear it out of cavities rapidly and it needs to be very frequently renewed.

Gutta-percha is also very useful in the treatment of sensitive dentin, and in cavities of teeth with hyperemia of the pulp. It is tolerated in both of these conditions better than any other filling material, and, if well put in, will generally stand long enough to accomplish good results. But to do well in either of these classes of cases, it must be made to adhere to the walls of the cavity. Otherwise it is liable on account of its softness to slight movement in the cavity and to admit moisture. In that case the condition, especially of sensitive dentin, is liable to be made worse instead of better.

Exposure and Removal of Dental Pulp, and Filling of Root Canals.

EXPOSURE OF THE DENTAL PULP.

ILLUSTRATIONS: FIGURES 419-447.

THE pulp of a tooth (1) may be found exposed by caries so that it lies naked and in view; (2) it may have been reached by the extension of caries but remain covered by a softened carious mass of dentin; (3) it may become exposed by accident during the preparation of a carious cavity; (4) the conditions may require that an intentional exposure be made through a carious cavity that has nearly reached the pulp, or that an intentional exposure be made, there being no carious cavity.

The first and second cases are so similar that they may be treated of together, only noticing differences of manipulation as they occur. In both, the supposition is that the pulp is to be destroyed and removed. In the first procedure, the problem is the preparation of the cavity for the treatment of the exposed pulp, with the least pain and inconvenience to the patient. In this writing we will not inquire into the conditions of the dental pulp from the pathological standpoint, but will consider only the technical procedures in pulp treatment.

The requirement is that the cavity be opened by the removal of all overhanging enamel and that the surrounding walls be freed from carious material, perfectly cleaned to solid dentin and cut to a form that will certainly retain a temporary filling for the purpose of sealing in applications that may be required in the treatment of the pulp. It is not required here that the cavity be cut to the full outline form, as it will be prepared to receive the permanent filling later, nor that permanent anchorages be provided; but it is required that good and sufficient anchorage be provided for a temporary gutta-percha filling against good, clean surrounding walls in every part. It should be opened sufficiently wide to admit of the free and easy application of instruments for the exposure of the pulp. In doing this, especial care should be taken that the instruments used

be not directed toward the pulp of the tooth and that it be not interfered with in any way until after the surrounding walls are clean and solid in every direction. This excavation should be done upon the principles already laid down for the excavation of cavities in the class to which the case in hand belongs. It must be understood that the pulp is not to be exposed or the pulp chamber entered at any time, either primarily or secondarily, without the protection of the rubber dam. If the rubber dam has not been placed at the beginning, it should be placed after the cavity is well opened, and every preparation made for the best possible view of the deeper parts of the cavity. The carious material should then be removed from the deeper parts of the cavity, and from about the exposure. In case the exposure is large and the pulp is already laid bare, this need not be very perfectly done at first, the necessity being that applications can be laid directly upon the pulp tissue and perfectly sealed in place by a temporary filling. It must be done, however, before any part of the pulp is removed in order to be sure that no infectious material be carried from the cavity into the root canals. In case the pulp is covered with carious material, only, this should be removed and the tissue of the pulp laid bare. In every case this should be done with the broadest cutting instrument that is applicable to the position, usually with the spoons 20-9-12. One should never undertake to remove softened material from over a pulp with an instrument so small that it is liable to pass through the opening into the pulp chamber, lacerate the pulp tissue, and inflict unnecessary pain. This should be taken as a principle controlling every procedure in this class of cases, and the operator should see to it particularly that the cavity be so opened and prepared that broad points may be used with facility.

When these preparations have been made, take the spoon, and, having determined the best direction in which to make a sweeping cut, start its edge carefully under the carious mass close against one of the walls of the cavity, and with a strong thrust in a curved direction carry it across to the other side, cutting at once to the full depth of the softened dentin. If possible, remove the whole mass at the single cut, laying the pulp bare. The position of the spoon for making such a cut is shown in Figure 132. This should be carefully planned and firmly executed. If the cut should be through the superficial portions of the pulp, excising a portion of the tissue, it is just as well, for when the hemorrhage has ceased, we are sure of the best

condition for the absorption of remedies for destroying it, whether this be done by the application of the arsenic or by use of cocain under pressure. In some broad cavities in which it may seem that the carious mass is too broad to be removed at a single cut, one or more preparatory cuts may be made to either side, avoiding the pulp, before making the principal cut for its exposure. An exposure of the pulp made in this way is usually not very painful, and, even if it be very sensitive, the duration of the pain is reduced to the shortest limit of time.

In proximal cavities in the incisors, the spoons 20-9-12 generally can not be used for want of room. Much oftener the spoons 15-8-12 or the discoid are applicable. In these cavities the most desirable direction for the final cut for exposing the pulp is from the gingival toward the incisal, directly over the pulp. In these cases the opening into the pulp is apt to be long gingivo-incisally, and if the broad cutting edge can be placed at right angles to this, it is much safer against dropping into the pulp chamber and producing unnecessary laceration of the sensitive tissues. By proceeding carefully, this position, or an angle closely proximating it, can often be obtained, and then the exposure is made with safety. A discoid is really the best instrument for the purpose in this position. The exposure may be made with spoons 10-6-12, but with more danger of inflicting pain.

DESTROYING THE DENTAL PULP WITH ARSENIC.

When the pulp has been fully exposed, the cavity should be ready for the application to the pulp without further preparation. If it is to be destroyed by arsenic, cut a piece of ordinary writing-paper, of heavy grade, of such size and form that it may be easily so laid in the cavity as to cover the exposure; try it in place. The walls of the cavity should be moistened with eucalyptol, or oil of cajuput, to prepare them for receiving a gutta-percha filling. Any excess of oil should be removed. A small amount of arsenical paste may be placed upon the piece of paper and applied directly to the exposure, with the arsenical paste turned against the pulp. The paper should be pressed gently to place. Care should be taken not to use so much of the paste that it will run out around the margins of the paper and be in danger of smearing the walls of the cavity, and possibly getting out toward the gingival margin of proximal cavities, for, in this case, there will be danger of arsenical poisoning of the gum tissues. This is sometimes a serious accident, endan-

gering several teeth by destroying the gum tissue and alveolar process. Place a gutta-percha filling over the paper, using especial care not to make unnecessary pressure over the exposure of the pulp that will cause compression and pain. This gutta-percha filling should be as perfect in its adaptation to the cavity walls as it is possible to make it, in order that there may be no leakage of the arsenic to poison the surrounding tissues, or of moisture from without inward to interfere with the action of the drug and infect the pulp. Unless the cavity is so shallow that there is lack of room, a further protection of the pulp against pressure may be provided by cutting another piece of paper or cardboard and fitting it over the first. Some cement may be mixed rather thin and a globule placed on this second paper, and the second paper inverted over the first and tapped gently to place. The cement should be given time to stiffen, which will give opportunity for the use of any reasonable force in making the gutta-percha filling for sealing the cavity. Another important care should be that in proximal cavities no overplus of gutta-percha be allowed to infringe upon the gum septum and cause absorption. Overplus in this direction is readily avoided by placing any suitable instrument between the teeth at the gingival margin of the cavity, such as the tapering shank of hoe 8-3-6, or the blade of a finishing knife, and making the gutta-percha filling against it, afterward removing the instrument. This gives room for the gum septum, and yet allows the temporary filling to be placed firmly against the proximating tooth in the region of the normal contact. Finally the filling must be so trimmed as not to give the patient annoyance, after which the patient may be discharged for forty-eight hours, or until the arsenic has acted.

ANESTHETIZING THE DENTAL PULP WITH COCAIN.

If it has been decided to anesthetize the pulp with cocain under pressure, the opening into the pulp must be free, and the position such that the after-manipulation can be readily done. The surrounding walls must be sufficient so that the drug may be readily confined under pressure, and the access should be fairly direct. Otherwise arsenic should be used. When a pulp is to be anesthetized by cocain, one should always look carefully to the rubber dam to see that it is watertight at all points so that there shall be no risk of the cocain solution reaching the saliva.

When the cavity has been fully prepared — an occlusal

cavity in an upper first molar, for example — a sufficient amount of cocain crystals should be dissolved in a drop of water (always made fresh for each case) and a small pellet of cotton saturated with this placed in the cavity upon the exposed pulp. Over this should be placed a pellet of soft, or unvulcanized rubber (used for making vulcanite plates), that will completely fill the orifice of the cavity and prevent the escape of the solution. Pressure should be made upon this with a broad-faced amalgam plugger. The pressure should be gentle at first and be gradually increased as the pain subsides, watching for evidence of pain in the countenance of the patient, until very heavy pressure can be made. Then, if all has gone well, the vulcanizable rubber and the cotton may be removed and the pulp will be found insensible, and its removal may be proceeded with.

In anesthetizing the pulp in this way, notice particularly that the cavity must be so stopped with the soft rubber as to prevent the escape of the solution along the cavity walls, otherwise the pressure will fail to force the drug into the pulp tissue and the anesthesia will fail. This is fairly easy of accomplishment in the cavity named above and those of similar form and situation. But in proximal cavities it is often much more difficult to so place the vulcanizable rubber that it will successfully stop the orifice of the cavity and prevent the escape of the fluid. In the molars and bicuspidis this may be successfully done by first placing a properly formed piece of rubber against the proximating surface of the adjacent tooth and forcing it against the gingival wall of the cavity and then doubling it over the occlusal portion so as to close that also, afterward applying pressure with a broad instrument point selected to fit the cavity to the best advantage. As one becomes expert in this, most cavities may be so handled as to successfully produce anesthesia of the pulp.

In those cases in which the pulp is not actually exposed, so that it is necessary to cut through considerable dentin to expose it, better results will usually be obtained in the use of cocain anesthesia by cutting a small hole in the dentin, about 1 mm. in diameter, with a bibeveled drill, and placing a minute pledget of cotton, saturated with the cocain solution, in this hole. A small piece of vulcanizable rubber should be applied over the hole and pressure made with an instrument that will just fit in the hole. It should be remembered that the effect of the pressure applied will be in inverse proportion to the area of the end of the instrument used, and much better penetration will be obtained

with a small instrument if the solution can be confined in a small hole so that it will be forced directly forward and not spread laterally, as it would do if the small instrument were used in a large cavity.

The best penetration of the dentin is obtained in cases in which the cocain solution is forced into normal dentinal tubules. For this reason, it is often an advantage to disregard the cavity of decay and drill into the dentin and apply the cocain to normal tubules in some other portion of the crown of the tooth. For example, in cases of distal surface cavities in molars, an opening may be made through the occlusal surface in the area which must be included in the cavity anyhow, and the cocain applied to normal tubules.

OPENING THE PULP CHAMBER PREPARATORY TO REMOVAL OF THE PULP. When the pulp has been destroyed by arsenic, the first procedure, when the patient has returned for the second sitting, is to adjust the rubber dam. In proximal cavities in which the gutta-percha filling has been placed firmly against the proximating tooth, the filling must first be cut through with a Koerber saw, or trimmed away with a sharp finishing knife, in order to allow the rubber dam to pass. A single, quick cut with a hot flat burnisher will accomplish the same result. When the dam is in position, sterilize the field of operation by mopping the teeth included, also their interproximal spaces and the adjacent rubber with "1-2-3" or oil of cloves, and then dry them off with absorbent cotton. The gutta-percha filling may then be softened by warming a burnisher and passing the point into it and holding it for a moment, when the gutta-percha may be lifted out.

The cavity should next be freed from the arsenic paste and washed out with an antiseptic and dried. The next procedure is the opening of the pulp chamber. In case the pulp has been anesthetized with cocain, the rubber dam will be in place and ready for the opening of the pulp chamber, so that from this point the procedures in the two cases will be similar. In either case, the pulp should first be pricked cautiously with a very fine broach, to be sure that it has lost its sensibility, for sometimes there is a failure in either way of operating. It is very bad practice to attempt to pull out any part of the pulp tissue through a small opening. In the bicuspid and molars, the opening of the pulp chamber consists in the removal of the entire roof, or dentinal covering, and the manner of doing this will depend much upon the extent and location of the decay.

In the occlusal cavities in the molars in which the decay is large, often hoe 6-2-23 can be slipped into the opening, and, using it as a hook, the entire roof of the pulp chamber may be pulled away, uncovering the pulp. But when the dentinal covering is strong, as is usually the case when the opening is only the exposure of one of the horns of the pulp, the better way is to enlarge the opening with a small fissure bur. This is passed into the pulp chamber through the orifice of the exposure, and when the operator is sufficiently sure in his knowledge of the anatomy, he may cut around the pulp chamber parallel with its axial walls and remove the covering in a single piece. Otherwise the opening may be enlarged by carrying the bur laterally toward the central portion of the covering of the chamber and then carrying it around in a circle. Then hoe 6-2-23 may be passed into the opening and its blade turned under the roof covering the pulp, the overhang determined, and the cutting directed, until the whole extent of the chamber is uncovered. No overhang should be left at any point. In this cutting, the greatest care should be taken that the bur be not pressed into the floor of the chamber and its form marred by cutting into it. It is best to prepare a number of small fissure burs especially for this work by grinding the ends smooth on a stone while rapidly rotating in the engine. With these there will be no danger of marring the floor of the pulp chamber. When the whole of the roof has been removed, it is generally best to enlarge somewhat toward the mesio-buccal angle in order to remove the mesio-buccal horn of the pulp and to give better access to the mesio-buccal root canal. This may be done most readily and in the best form by a scraping movement with the cleoid excavator. The case is now ready for the removal of the pulp. Incidentally much of the tissue of the bulb of the pulp, possibly all of it, will have been removed in doing this cutting, but no attempt should be made to remove the pulp from the canals until this cutting is satisfactorily completed and the cavity cleared of all dentin chips and cuttings. If this is neglected, it will often happen that these cuttings will get into the smaller root canals and stop them up so that they can not again be opened. For this reason all cutting in opening the pulp chamber, especially in bicuspid and molars in which some of the canals are often very small, should be fully completed before any effort is made to remove the pulp from the canals. When in any case it is found that more cutting for access to some one root canal must be made, a bit of cotton should be placed loosely in the root canals that

have been opened, to remain while the cutting is being done, and until the cavity is again freed from cuttings. Then with the removal of this cotton the last of the cuttings will be removed.

In many cases after the first opening has been made, the roof of the pulp chamber can be cut away quicker and much more satisfactorily with the chisel and mallet.

If the exposure is from a mesial cavity, the cutting will be, of course, to the distal and often will involve the removal of the middle third of the occlusal surface with the whole of the dentin intervening between it and the pulp. If a distal cavity, the middle third bucco-lingually of the occlusal surface with the intervening dentin should at once be removed to a point well toward the mesial marginal ridge.

In the bicuspid the exposures are almost uniformly from cavities in the proximal surfaces, and the pulp chambers are broad bucco-lingually. The cutting for the opening of the chambers must be directed first to the central part of the crown, but later broadened from buccal to lingual; for the horns of the pulp, when long, in these teeth, spread out toward the points of the cusps, as in Figure 419. These horns should be fully opened so that they may be cleaned and solidly filled. The root canals in these teeth, especially in the upper first bicuspid, are given off from the extreme buccal and extreme lingual portions of the chamber, as shown in Figure 419, and unless the cutting is broad in these directions, the broach will not have direct entrance into them.

In the incisors and cuspids, exposures are generally from proximal cavities. In opening these for the removal of the pulp, the orifice of the exposure should be first extended to the gingival wall of the cavity and to the full breadth of the chamber. The approach should be carefully considered. Generally a broach will not readily slide into the canal without being bent more or less. See Figure 420. This is unfavorable, and a better approach must be made. Generally when a cavity is so large that the pulp has been reached, the lingual wall should be cut away, and this will improve the approach, the instrument being passed to the lingual of the incisal edge of the tooth; rarely the labial wall should be cut away. The approach may be improved still more by taking a small fissure bur in the engine, and, approaching the canal from the direction in which a broach would be introduced, passing it into the canal and cutting by lateral pressure, broaden the canal in a direction to straighten the approach, as shown in Figure 421. This cutting will be



FIG. 419.

FIG. 419. A photograph of a second bicuspid split bucco-lingually to show the form of the pulp chamber. This patient was about fifteen years of age and the illustration shows about the extreme bucco-lingual breadth of the pulp chamber in young persons. In this case, the horns of the pulp are rounded, but they are often pointed. This case illustrates the cutting bucco-lingually that is often necessary to fully expose and clean these pulp chambers. Every part of the pulpal horns should be exposed. The dentin was tinged with eosin to sharply distinguish the enamel cap.

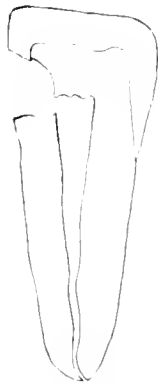

Fig. 420.

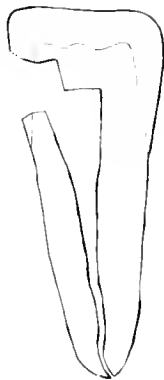

Fig. 421.

Fig. 420. An outline drawing of a central incisor, with an excavated cavity exposing the pulp, split mesiodistally to show the relations to the pulp chamber and canal to the cavity. The canal and chamber are of such breadth as is usually found in young persons. It will be seen that it would be difficult to pass a broach to the apex of the root canal because of the short bend that would be required in entering the pulp chamber.

Fig. 421. A fissure bar is entered into the opening into the pulp chamber and the canal enlarged, as shown, in such direction as to make the use of the broach easy. The canal is then cleaned with much more ease and certainty of perfect work.

toward the disto-lingual if a distal cavity, or mesio-lingual if a mesial cavity, if the approach is to the lingual of the incisal edge. From whatever the direction of the approach, the cutting is to be so directed to the broadening of the coronal portion of the canal that the broach will reach the apex of the tooth with the least bending. In this cutting, special care should be taken that the end of the bur does not cut the opposite side of the canal and roughen it, for, if it should, the point of the broach will catch in the rough points at every effort to introduce it into the canal. By this cutting, the curve of the instruments introduced into the canal for the removal of the pulp, or for filling the canal, will be much less abrupt and these operations can be done more perfectly.

REMOVAL OF THE PULP.

The instruments used for removing the pulp from the canals are the barbed broach and the smooth broach. Generally the barbed broach should be used first. Usually the bulb of the pulp will have been removed during the opening of the pulp chamber, and the broach selected should be suited in size to the canal. Each broach should be tested before using it by placing the end on the thumb nail of the left hand and bending it. It should bend in a regular curve. Occasionally in cutting the barbs, the shaft is cut too deeply at some point, which will cause it to break easily; such a broach should be discarded. The broach should be held in a light handle, but may be used without. Just before introducing the broach, it should be dipped into a good antiseptic, preferably "1-2-3," or oil of cloves. There should be enough of the medicament so that the working part of the broach can be effectively washed. This should never be neglected, for the broaches are liable to carry microorganisms into the canal and infect it. It is not meant that this dipping of a broach in the medicaments mentioned is sufficient sterilization for a broach which has been used previously. I would, however, consider this procedure safe for a new broach or one that had been sterilized and laid aside in a bottle after having been used.

The broach should be passed into the canal, the point being directed against one of the walls so that it will pass in beside the pulp tissue rather than through it. Generally the point should be pushed to the apical foramen and then, if it is felt to be held tightly in the apical end of the canal, withdrawn until it is felt to be loose. The broach should then be rotated lightly, moving it slightly back and forth to be sure that the whole length

is rotating and not being held in some curved part of the canal which would be liable to break the broach. The rotation should not exceed one turn; it should then be withdrawn. In a good many cases the entire contents of the canal will be brought away with the first effort. If not, the movement should be repeated. Often the tissue of the pulp will break up into shreds and be but partially removed. In such cases, the smooth broach with cotton should be used. For preparing this, the fingers should be disinfected and a bit of absorbent cotton should be pulled between the fingers of the two hands until a small shred is formed containing but a few parallel fibers. One end of these should be held between the forefinger and thumb of the right hand and with it the broach should be grasped at mid-length, or with the cotton wisp extending slightly past its point. With the left hand the other end of the cotton wisp and the point of the broach should be grasped together, and the broach rotated in the fingers of the right hand until the cotton is wrapped firmly upon its shaft. When this is properly done, the cotton will cling firmly to the broach and is not likely to be lost in the canal. With the broach thus armed, dip it first in the antiseptic, press out the surplus with absorbent cotton and then pass it into the canal, slightly rotating back and forth. When the full depth has been reached, turn the broach fully upon its axis and withdraw it while in rotation. Generally the shreds of the pulp will become entangled in the cotton and be brought away. This should be repeated until all tissue has been removed from the canal to its apex.

Students often have difficulty in finding the canals in the molar teeth. This should not occur except in abnormal cases. The difficulty generally occurs because the floors of the pulp chambers have been mutilated with burs and the openings of the canals filled with chips. This should never be done; burs should not be used in the floor of the pulp chamber.

The floor of the pulp chamber is rounded or arched in the center and falls away toward the mouths of the canals. In upper molars the canals are situated in the position of the angles of a triangle (the molar triangle), Figures 422, 423, the mesial line of which is the longest, the buccal the shortest, and the distal the intermediate length. For the first molar, this triangle is well shown in the illustrations representing sections a little rootwise from the floor of the pulp chamber. This is best seen in the specimen itself; and the position and the direction of the canals, with relation to the walls of the pulp chamber and the

main points of the surface of the crown, should be carefully studied.

The opening into the lingual root is the simplest and most direct. Generally, it begins in a funnel-shaped opening inclining to the lingual, as in Figure 425, which quickly narrows to the dimensions of a moderately small canal and continues to taper to the apical foramen. It is usually straight, or but slightly curved. The approach to the canal with the broach is from the buccal, with a lingual inclination. The broach should be placed against the lingual wall and slid forward and it will glide into the canal.

The opening of the mesio-buccal canal is under the mesio-buccal cusp, close against the mesio-buccal angle of the pulp chamber. It often happens that this canal opens in a groove in the angle of the chamber, Figures 422, 423, making this the thinnest point in the dentinal walls surrounding it. In young teeth, the mouth of the canal is of a flattened funnel shape, which is quickly contracted into a very fine canal; but in the adult, it often begins as a fine canal. Its course at first is to the buccal and mesial and then to the distal. It is usually distinctly flattened and often has a thin edge to the lingual. It is often a very difficult canal to clean with a broach. To find this canal, the point of the broach should be directed into the mesio-buccal angle of the pulp chamber, and, while held against the wall within this angle, should be slid toward the root. It will rarely fail to glide into the canal.

The disto-buccal canal usually begins abruptly as a fine opening, situated at the disto-buccal angle of the floor of the pulp chamber, Figures 422, 423, so that a broach pressed into that angle will easily glide into it. But in some instances, especially in the upper second molars, the opening is in the floor of the pulp chamber at a little distance from the immediate angle toward the center of the floor, and then, in positions which limit vision, it is often difficult to find. In teeth much flattened at the neck, the opening of this canal may begin very close to the mouth of the mesial canal, Figure 424, or close against the distal wall of the chamber, half way from the buccal to the lingual wall, or, anywhere between this point and the disto-buccal angle. The first direction of the canal will vary according to its position. If it is found in a fairly well defined disto-buccal angle of the chamber, its direction will be a little inclined to the distal and the broach will penetrate it easily; if in the floor of the chamber, it will sometimes be straight, as in the former case;

but, more generally, the first direction will be to the distal and buccal, with considerable curve afterward. If found close to the mesial canal, its course is usually first sharply to the distal, when it curves rather abruptly toward the apex of root. If found along a smooth or curved distal wall, the course will generally be to the distal and buccal with but little curve. This canal is usually very fine from its beginning, and almost or quite round.

While the canals are similar in all of the upper molars, there are differences in the form of the floor of the pulp chamber that may be briefly generalized. The pulp chamber of the upper second molar, Figure 428, is usually much more flattened mesio-distally than that of the first molar. This changes the relation of the openings of the canals somewhat, rendering the distal angle of the triangle formed by them more obtuse and brings the opening of the distal canal nearer the mesial line of the triangle, so that it seems to be found along the distal wall of the narrowed chamber. In others, it is found in the extreme buccal portion crowded close against the mouth of the mesial canal.

The position of the openings of the canals in the upper third molar, Figures 430, 431, is usually much the same as in the first and second, varying so as to resemble either. Occasionally there are more than the usual number; occasionally only one or two canals. When there is but one, it is commonly quite large. Four, five, or even seven or eight, are sometimes found.

The pulp chambers of the lower molars, Figures 432-442, have the same general form as the surface of the crowns, but are generally rather more angular. The wall of the chamber toward the occlusal surface is convex toward the pulp; the horns extend from the extreme angles toward the apex of each cusp. The floor, through the central portion, is arched or convex from mesial to distal, and concave from buccal to lingual. The mesial wall of the cavity is flat and longer than the distal, which is rounded or concave. The mesio-buccal and mesio-lingual angles are sharp and projecting, while the distal angles are rounded, Figure 435. The size of the chamber varies much. In youth, its diameter is often as much as two-fifths of the crown and seldom less than one-third. This diminishes as age advances, and in old age, it is often very small; especially where there has been considerable abrasion of the teeth, the pulp chamber may be almost or quite obliterated.

The root canals of the lower molars proceed from the mesial



FIG. 422.

FIG. 423.



FIG. 424.



FIG. 425.



FIG. 426.



FIG. 427.



FIG. 428.



FIG. 429.



FIG. 430.



FIG. 431.

FIGS. 422, 423. Each of these represent three horizontal sections across the neck and root of an upper first molar. The first in each, reading from left to right, is through the central part of the pulp chamber. The second is at the point where the canals are dividing from the chamber. The third section is a little rootwise from the pulp chamber and shows the molar triangle, formed by the relative position of the canals, to advantage. This exhibits the relation of the root canals to the pulp chamber.

FIGS. 424-427. Lengthwise sections of upper first molars exhibiting the relation of the root canals to the pulp chambers.

FIG. 424. A section exposing the pulp chamber and the canals in the mesio- and disto-buccal roots.

FIG. 425. A section exposing the pulp chamber and mesio-buccal and lingual pulp canals.

FIG. 426. Another section exposing the two buccal root canals.

FIG. 427. A section exposing the pulp chamber and the canals in the disto-buccal root and the lingual root.

FIG. 428. A perpendicular section of an upper second molar, exposing the pulp chamber and the canals in the mesio- and disto-buccal roots.

FIG. 429. A perpendicular section of an upper second molar, exposing the pulp chamber and the canals in the disto-buccal and lingual roots.

FIGS. 430, 431. The pulp chamber and root canals in upper third molars. Figure 430 is a bucco-lingual section showing the canals in the mesio-buccal and lingual roots. Figure 431 is a mesio-distal section showing the divided buccal canals in a tooth with a single root.



FIG. 432.



FIG. 433.



FIG. 434.



FIG. 435.



FIG. 436.



FIG. 437.



FIG. 438.



FIG. 439.



FIG. 440.



FIG. 441.



FIG. 442.

FIGS. 432, 433. Mesio-distal sections of lower first molars, exposing the pulp chamber and root canals.

FIG. 434. A bucco-lingual section through the mesial root of a lower first molar, showing the pulp chamber and the two canals in the mesial root. Not very infrequently these end in a common apical foramen.

FIG. 435. Cross-sections through the central part of the pulp chambers of two lower molar teeth in the figures one above the other on the left. The second cut is just below the pulp chamber in each. The third cut is about the mid-length of the roots. In the upper series, the mesial root has one broad canal. In the lower series this is divided into two very small canals, widely separated.

FIG. 436. A mesio-distal section of a lower second molar with a single root, showing the pulp chamber and a mesial and distal root canal.

FIG. 437. A bucco-lingual section of a lower second molar with one root and one large pulp canal.

FIG. 438. A mesio-distal section of a lower second molar with two roots, showing the root canals.

FIG. 439. A bucco-lingual section of the crown and mesial root of a lower second molar, with two root canals which join in the apical third of their length and again separate, ending in separate apical foramina. This is unusual.

FIGS. 440, 441, 442. Mesio-distal sections of lower third molars, showing the form of the pulp chambers and root canals. Figure 441 shows the single root with one large canal. This is not very uncommon in these teeth.

and distal portions of the pulp chamber, Figures 432, 433, 435, 438, 440, 442. The mesial canal, at its mouth, is usually about as broad from buccal to lingual as the whole breadth of the chamber, including its angular projections. Either at, or a little rootwise from, the floor of the pulp chamber, it is usually divided into two very small canals which diverge at first, and approach each other afterward, but usually remain distinct, each ending in its own apical foramen, Figure 434. Occasionally, however, they are united in the apical third of the root, and end in a common apical foramen. Again, there may be a communication between them in the apical portion of the root, each canal remaining otherwise complete in itself, Figure 439. A few have one broad flattened canal, Figure 435. These canals are usually minute and very difficult to thoroughly clean with the broach, though the mesio-buccal canal is usually easily found if the pulp chamber is thoroughly opened. By placing the point of the broach in the mesio-buccal angle of the chamber and pushing it gently on, it will generally glide into the canal. The first direction inclines to the mesial and buccal, after which it curves to the distal and lingual. Generally, these curves are easy, without short bends. The broach glides into the mesio-lingual canal by placing the point in the mesio-lingual angle of the pulp chamber and sliding it toward the root. The first inclination is to the mesial, but occasionally to the lingual, after which it curves to the distal and buccal.

The distal canal is approached by a funnel-shaped opening, of which the central part of the distal wall of the pulp chamber becomes a portion. Its direction is a little to the distal, and is generally very nearly straight to the apex. At first it is flattened with the long diameter from buccal to lingual, and progressively becomes rounded and tapers regularly to the apical foramen. It is generally much larger than the canals of the mesial root and is easily cleaned with the broach. If the mouth of the patient is wide open and the handle of the broach brought against the upper central incisors with the point directed against the posterior wall of the pulp chamber, it will easily glide into the canal and pass to the apical foramen. This position is shown in the photograph, Figure 443. This particular position for easily entering the distal canal is important, for all the lower molars. Occasionally, the lower third molar has but one root canal, Figure 441, which is generally very large. More rarely only a single canal will be found in the lower second molar, but generally, the canals of the second and third lower molars are

similar to those of the first. The pulp chambers are usually smaller and oftener irregular in outline. The lower third molar has, occasionally, a very large pulp chamber.

VARIATIONS OF THE FORMS OF PULP CHAMBERS. Many variations of form occur in the pulp chambers and root canals. The roots of the teeth may be abnormally crooked. In many instances, the pulp chamber will have in it secondary formations, called nodules, which may be adherent to the walls or block the openings of the canals and prevent a broach from gliding into them. These also occur, occasionally, within the canals, partially blocking the way of the broach. Sometimes the pulp chamber will be filled with nodular deposits so completely that there seems to be no room for the tissues of the pulp. These deposits must be removed before the root canals can be reached and entered, after which the canals will generally be found open. Such deposits occur within the pulp chambers of any of the teeth, but they cause annoyance most frequently in the molars.

Occasionally lateral openings occur from the root canals to the surface of the root. More of these have been seen from the canals of the lower molars than any other teeth. Generally they follow the course of the dentinal tubules and open on the side of the root. They may diverge to one side and curve toward the apex of the root. These can not often be detected, except in dissections of the root, and occur so rarely they may be ignored in practice.

Sometimes the horns of the pulp approach abnormally near the points of the cusps of some of the teeth, as in the upper first bicuspid, and in the mesio-buccal cusp of the upper first molar. Then the pulp is more liable to exposure in excavating carious cavities.

No specific directions can be given for abnormal cases. When the pulp chamber is filled with secondary deposits, the effort should be directed to the removal of these, preserving the outlines of the pulp chamber. When the pulp chamber is much narrowed by secondary dentin deposited upon its walls, the openings into the canals should be found before any cutting is done, and then the cutting carefully directed to straightening them. In most instances this is done best with the barbed broach. All small tortuous canals should be enlarged and straightened with the barbed broach. To do this, the broach should be passed into the canal as far as possible and withdrawn. The barbs will impinge upon the walls and cut away the dentin from the prominent parts of the crooks and straighten them. This should be



FIG. 443.

FIG. 443. A photograph showing the position for passing a broach into the canal of the distal root of any one of the lower molars. All of the work of removing the pulp, cleaning and filling this particular canal is done best from about this position.



FIG. 444.



FIG. 445.



FIG. 446.



FIG. 447.

FIGS. 444-447. Outline drawings explaining the opening of the pulp chamber and canals in the incisor teeth when this is done through the lingual surface.

FIG. 444. The opening to the pulp chamber from the lingual surface as first made with the drill.

FIG. 445. The opening as modified by a fissure bur, which is placed in the drill hole and inclined so as to cut to the incisal, straightening the approach to the pulp canal.

FIG. 446. The fissure bur is turned to the deeper portion and a cut made lingually, straightening the approach of the broach to the apical portion of the canal.

FIG. 447. Finally the incisal point or edge of the pulp chamber is exposed by a fissure bur, or a 12-5-12 hoe, as shown in this figure. This part of the pulp chamber can then be perfectly cleaned and filled. Generally in the incisor teeth of young persons the drill will strike the pulp some distance from its incisal end, as shown in Figure 444, and any neglect to expose, clean and fill this portion is certain to result in a discoloration of the crown of the tooth sooner or later.

repeated again and again, pressing the broach in a direction during its withdrawal that will tend most to straighten the canal. By repetitions of the movement, a canal that can be entered by the smallest broach can soon be enlarged sufficiently for filling. Generally, partial occlusions of canals are confined to or near their pulpal ends, and when these have been enlarged, the broach will pass to the apex. In elderly people certain canals are often too small for successful cleaning and filling. In cases in which there has been much wearing away of the teeth, the pulp chambers and the pulpal ends of the root canals are apt to be much narrowed by secondary dentin. This applies to all of the teeth in the mouth, i. e., to any that have, from any cause, not been worn away, the same as those that are worn.

When the root canals have been cleaned, it is generally necessary that a dressing be laid in the canals and the cavity sealed with a gutta-percha filling until a future time. For this purpose a wisp of cotton should be formed with its fibers mostly parallel, and the end of this caught with the point of the broach with the thumb and finger of the left hand and the broach rotated with the right hand, while the fingers of the left roll the cotton on its end. In this way the cotton is rolled on the broach in such a way that it will not slip backward on the broach and can be carried to the apical end of the canal; and when the broach is withdrawn, the cotton will remain in the canal. This should be saturated with the dressing, or drug indicated, before being placed in the canal. One end of the cotton wisp should project into the pulp chamber in order that it may readily be removed at another sitting. The cavity should be sealed with a gutta-percha filling.

RULE: *In no case should the saliva be allowed to enter a root canal after the pulp has been removed.* At any future sitting, the rubber dam must be applied and the included region disinfected before the gutta-percha filling is removed. Any neglect of this precaution is apt to result in alveolar abscess.

In cases of dead pulps, pulps in a state of decomposition, empty root canals, alveolar abscess, etc., the technical processes of cleaning the canals will be described later. They may require radically different medicinal treatment. This latter is not within the province of this book.

OPENING PULP CHAMBERS IN SOUND TEETH. Frequently it is necessary to open the pulp chambers of teeth that are sound, or that have fillings previously inserted, the removal of which is not indicated. The pulp may be dead or in such a condition of

disease that it should be removed. In these cases, it becomes necessary to cut from the surface of the tooth or through the filling.

In case of the incisors or cuspids, the best place to enter the pulp chamber is through the central portion of the lingual surface. For this purpose, a bibeveled drill, one millimeter in diameter, should be first used. Its cutting edges should be very sharp. With this the enamel should be penetrated and the drill forced a little distance into the dentin. This opening should be considerably enlarged by a larger drill or a round bur. Then the small drill should be forced carefully into the pulp chamber by frequent changes of these instruments so that the point of the small drill is never very deep in the small hole. Neglect of this precaution is liable to cause unnecessary pain, or to break the point of the small drill by some quick movement of the patient. If the pulp is alive and sensitive, it should now be destroyed. Afterward the complete opening of the chamber may be proceeded with. If the pulp is dead, the further opening of the chamber may be done at once.

In cutting into the pulp chamber through the lingual surface of incisors, the drill has entered from the lingual at a considerable inclination, as shown in Figure 444, and it is necessary to make the opening as nearly parallel with the length of the pulp canal as practicable. To do this, a fissure bur should be used. Its end should be passed into the pulp chamber and the hand-piece brought slowly parallel with the long axis of the tooth, cutting from the incisal wall of the opening first made, as shown in Figure 445; then with the same instrument passed farther in, the lingual wall of the pulp chamber should be cut away, going deeper into the root canal carefully, so as not to mar the labial side, until the form shown in Figure 446 is obtained. This cutting should be sufficient to admit a broach to the full length of the canal, with very little bending. Unless there is some reason for delay, as on account of soreness of the tooth, the incisal end of the pulp chamber, which, as left in 446, can not be reached for cleaning or filling, should be opened by cutting away the tissue, as shown in Figure 447. This should always be done before a filling is made. Otherwise a little tissue or débris will be left, which will decompose later and discolor the tooth. It is also necessary that this be opened so that it may be solidly filled. When this has been completed, the cleaning and treatment of the canal can be proceeded with.

Generally, when incisors have proximal fillings that are

good, the opening into the pulp should be made from the lingual, as above described, without disturbing the fillings. If, however, there is reason for removing a proximal filling, the pulp chamber should be opened through the cavity.

The different teeth of each class show much variation in form and position, which makes considerable differences in the cutting necessary to so straighten the line of approach that the broach and the root canal plugger will go easily to the apex of the root canal, or canals, without so much bending as to interfere with their effective use. Some are of such form, and the line of approach is such, that this is easily obtained, while others are very much more difficult. But in almost every case fairly free working of these instruments can be obtained by judicious cutting, which will not be excessive in lines that will materially injure the strength of the teeth. As the future usefulness of the teeth will depend upon the effectiveness of the treatment of the root canals, one should not be satisfied to undertake this without the best access for these instruments that can reasonably be attained.

In bicusps and molars, the opening should be made through the occlusal surface. In bicusps the mesial pit should be chosen. In molars it is generally much easier to penetrate the enamel through the pit in the central fossa. In this case, as soon as the dentin has been entered, it is best to introduce a small inverted cone bur and cut a slot to the mesial, inclining to the buccal, and chip the enamel from its margins. The length of this toward the mesial will depend on the position of the tooth and the inclination of the hand-piece in drilling through the dentin. In this, the object is to gain a position from which the drill can be directed into the pulp chamber centrally or toward its mesial portion. The dentin is thick, and, in passing through it from the central pit, this inclination will often carry the hole considerably to the distal. Therefore, in beginning again with the drill, it should be set sufficiently to the mesial so that it will strike the pulp chamber centrally, or to the mesial of its center, as stated. In drilling through the dentin, a small drill, one millimeter in diameter, should first be made to penetrate a little, and then the hole enlarged, then drilled deeper and enlarged, continuing this exchange of instruments until the dentin has been cut through. It should be recognized that there is always danger that a small drill is liable to clog with its chips and to heat, or that it may be broken and the end remain fast in the hole. Or some sudden movement of the patient may break it.

For these reasons, a small drill should not be sunk very deeply into dentin at any time without having enlarged the opening through which it works. The opening should not be made with a large drill in the first instance, because this requires too much force. If the pulp is alive and sensitive, it should be destroyed; if dead, the opening may at once be so enlarged as to remove the entire roof of the pulp chamber, and the treatment of the canals proceeded with. Treatment of pulp canals should never be undertaken through a small opening.

In a considerable number of cases it is necessary to open the pulp chambers of bicuspid and molar teeth that have been filled. If the fillings are good, proceed as if the tooth was sound, cutting through the filling, or through the dentin, as the case demands. If there is reason for removing the filling, do so at once, and open the pulp chamber through the cavity.

CLEANING ROOT CANALS. When the pulp must be reached by cutting into the tooth instead of approaching it through a decayed cavity, it is generally because of disease of the dental pulp that has rendered its removal necessary, because of the death of the pulp, or because of the necessity for removal of the pulp to use the tooth as an abutment for a bridge. Therefore, the condition of the pulp may be, (1) diseased, but uninfected; (2) dead and in a condition of decomposition and consequently infected, or (3) in a healthy state. In the first and third of these, the pulp is to be removed and the canals cleaned as has heretofore been described for ordinary cases. Here we need to deal only with those cases in which decomposition has occurred within the pulp chamber and root canals. With these may be included also those which are found open because of a cavity of decay; for all of these are infected cases.

CLEANING INFECTED PULP CANALS. There are three varieties. (1) Those in which there is no disease of the soft tissues about the apex of the root; (2) those in which there is inflammation about the apex of the root or abscess without external opening (blind abscess), and (3) those in which there is chronic abscess discharging on the gums. The treatment of these conditions as varying forms of disease might require further division, but the limitations of this book confines the consideration to the safe preparation and cleaning of the pulp chambers and root canals. Necessary after-treatment is excluded.

The first proposition here is that the pulp chambers and root canals in each of these cases are infected districts which are to be cleaned and made aseptic. There seems to be a senti-

ment that there is no need of aseptic or antiseptic precautions in approaching these, since they are already infected. This is distinctly wrong. In the great majority of cases, the infections are with the mildly pathogenic microorganisms. Root canals that open into a cavity of decay may contain saproplitic microorganisms only, which are incapable of spreading into the living soft tissues by growth and producing disease in that way. Their products of decomposition in the root canals may, however, be very irritating and cause a temporary inflammation when passed through the apical foramen. In any of these cases there is always the danger of introducing more virulent pathogenic microorganisms during the treatment, unless diligent aseptic, or antiseptic, precautions are employed in the approach, as in aseptic cases. There should be no difference in this respect whatever in the two classes of cases.

The instruments used in cleaning the canals are the barbed broach and the smooth broach with absorbent cotton; the same instruments as used in aseptic cases. The rubber dam must protect the parts and the field of operation must be cleaned as in other cases. Then if the canals contain fluid, this should be carefully absorbed away as the first procedure by slight wisps of absorbent cotton wound upon the smooth broach. This should not be done by thrusting in as much cotton as the root canals will hold, for the reason that there will be danger of pushing this fluid beyond the apical foramen and causing unnecessary inflammation of the peridental membrane. Very small amounts of cotton should be used, frequently repeated, and the fluid lightly absorbed into these and drawn away without pressure. When the canal is reasonably dry, a barbed broach that enters the canal loosely should be washed in "1-2-3," oil of cloves, or other of the sedative essential oils (it is important that no irritating drug be used), and introduced carefully some little distance into the canal and withdrawn. The barbs are so cut that they hold débris or shreds of decomposing tissue *on the pull* and bring away any such material with which they come in contact. This broaching should be continued, washing the broach repeatedly in the medicament (of which there should be a sufficient amount for effective washing) until the canal is cleaned to its apex. During this process the broach should be inclined this way and that in its withdrawal so as to effectively scrape all parts of the walls of the canal with the barbs, loosening and removing all adhering particles. Finally, the canal should be flooded with the medicament and the broaching repeated. The

medicament should then be absorbed away. This should be repeated a number of times until the canal is judged to be well cleaned. Then it should be dried with frequent introduction of very loosely fitting bits of cotton wound upon the smooth broach and so rotated as to entangle and remove any particles that may possibly have been left.

In all of this work especial care should be taken that the cotton on the smooth broach shall not be in such quantity as to form a piston that will push material from the canal through the apex of the root into the tissues beyond; also that the barbed broach be not used in such a way as to gather shreds of material before it and push some of the contents into the tissue beyond the apex of the tooth. This pushing of material through the apex of the canal, which is liable to produce inflammation, is the one great danger in cleaning root canals. It is to be especially guarded against. With the proper sealing of the cavity, the pulp chamber and root canals are a sealed box, the disinfection of which is easily commanded. There is no reason whatever for the use of irritating germicides in its disinfection.

When the cleaning has been completed, a wisp of cotton, saturated with the desired medicament and the surplus fluid pressed out, should be placed loosely in the root canal, or in each root canal, when there are more than one. This should be covered with a pellet of cotton similarly treated and the cavity sealed with gutta-percha as heretofore described. In no case should wisps of cotton be introduced into such canals carrying the full amount of liquid they will take up, for some of it is apt to be forced through the apical foramen and do harm.

FILLING ROOT CANALS.

When it is decided that the conditions are right for filling the root canal, or canals, of a tooth, the rubber dam must be placed and the included region disinfected. Then if a treatment has been in the canal, the gutta-percha filling and the dressing should be removed and a critical examination made as to its condition. One principal point is that the canal should be reasonably dry.

The size of the apical foramen should be ascertained by trying several sizes of root canal pluggers in the canal, first washing the point of each in an antiseptic. Those that are smaller than the foramen will pass through and will be felt by the patient. By beginning with a small point, and trying larger points in graded sizes, one will be found that will pass nearly,

but not quite to the apical foramen. The length of the root may be ascertained by sticking the point of a smooth broach through a little piece of rubber dam and holding the piece of rubber even with the incisal end, occlusal surface, or any convenient landmark on the tooth, while the broach passes to the apical foramen and is felt by the patient. When the broach is withdrawn, the distance from the rubber to the point will be the length of the tooth. In large canals a broach with a small hook on the end may be passed through the foramen and will catch on the end of the root, thus giving the length.

The canal should be flooded with eucalyptol or oil of cajuput, liberally applied upon a wisp of cotton wrapped upon a broach, and the excess dried out with a fresh wisp of cotton that has first been dipped in the oil and well squeezed out with another wisp of cotton. A gutta-percha cone should be selected and a portion of it about three or four millimeters long should be cut off. This piece should be of a size which, from the information gained of the size of the apical end of the canal, will be sufficient to fully fill the opening and not be forced through it. The point of the root plugger selected should be warmed, and while holding the piece of gutta-percha cone in the thumb and finger of the left hand, its point should be brought quickly in contact with the large end of the cone and held a moment, or until the gutta-percha has stuck to the end of the instrument. After the gutta-percha has had time to become cold and hard, it should be dipped into eucalyptol, which will soften the surface of the gutta-percha slightly. It should then be conveyed to the root canal, starting in carefully and carried firmly in to its apical end. On withdrawing the root plugger, the gutta-percha cone will remain, closing the apical end of the root. This should be repeated with other bits of gutta-percha cones, cut from larger parts of the cones as the canal is filled to its larger portion, using the larger root canal plugger. After the first two or three pieces, the subsequent ones may be slightly softened by passing them quickly over the flame of the annealing lamp and directly into the canal. This should be continued until the canal is full.

This plan of filling root canals is applicable to all except the very smallest, and to all positions. In some of the smaller ones it is necessary to make a special root canal plugger for the case by cutting off the barbed portion of a broach of a suitable size and squaring its end on a stone. In the daily use of broaches a large number of these may be collected with which

to handle root dressings and for filling canals that are too small for the ordinary root pluggers.

RATIONALE OF THIS PROCEDURE. By flooding the root canal with eucalyptol or oil of cajuput, the moisture is effectually removed. The oils have a greater affinity, or attraction, for the dentin than has the moisture and therefore displace it. In practice this is a much better method than drying with hot air or hot instruments. The drying is done much more perfectly and more easily. In this work the cotton wrapped on the broach should never be in such quantity as to force the oil through the apical foramen. Any such action should be strictly avoided. These oils dissolve gutta-percha slightly, and the little oil remaining serves to stick the gutta-percha firmly to the walls of the canal. By putting in the gutta-percha in small pieces, an opportunity is given to pack every portion of the canal and all of its irregularities full.

In filling root canals that are very large at the apical end, as in young persons, care must be exercised that the first cone selected is not so small that it could be forced through into the apical space. In very small canals, in which there is much doubt of being able to reach the apical end, chloro-percha (gutta-percha dissolved in chloroform) should be pumped into them, filling them as completely as possible, and then a small solid cone forced in. This pumping in of chloro-percha is done by wrapping three or four fibers of cotton firmly on a small broach, dipping this in the chloro-percha and conveying it into the canal and pumping it back and forth, repeating the operation until the canal seems to be well filled. A root canal plugger of suitable size may then be thrust into it and some of the chloro-percha forced from the pulpal end. A suitable gutta-percha cone, previously prepared, may be thrust as far into the canal as possible. Such canals may not always be perfectly filled by this plan, nor by any other, but in each case the best effort should be made. The pulp chamber should not be filled with gutta-percha. This material is much too soft to serve as a seat for a metallic filling. In any case in which it is not desirable to fill the pulp chamber with the material with which the cavity is to be filled, oxyphosphate of zinc should be used.

The evaporation of chloroform from chloro-percha may be prevented, in large measure, by keeping the bottle containing the solution upside down. By standing the bottle on its cork, a little of the chloro-percha will pass in between the cork and the opening of the bottle, and as the chloroform evaporates from this

portion, the remaining gutta-percha will seal the opening so that no more chloroform may evaporate. The contents of the bottle will therefore remain in a plastic state, ready for use at any time.

HORNS OF PULP CHAMBERS. Attention to the horns of pulp chambers is most urgently demanded in the incisors, cuspids and bicuspid. In incisors particularly, exposures of the pulp, whether made primarily by caries, or by cutting into them, are usually at some distance from the incisal end of the pulp, leaving an end protruding into the incisal end of the crown of the tooth. This has been especially noted and illustrated in Figures 444, 445, 446, 447. It is also true that in cutting into the pulp chambers of bicuspids, one is liable to leave one or both of the horns of the pulp chamber uncleaned and unfilled. Before filling the cavity, this must be looked for and these openings so exposed that every part of them may be cleaned and filled. Any neglect in this will result in discoloration of the tooth by the decomposition of the débris left in this neglected portion of the pulp chamber. In cuspids and bicuspids, the horns of the pulp are often long and slender, and penetrate far toward the ends of the cusps. Unless these are thought of and especially looked for and cut out, so that they may be perfectly filled, discoloration of the tooth in some degree is sure to occur. This may occur in the molars as well, especially in young persons whose teeth have long cusps. Nothing of this kind should escape notice and correction. A study of these points in practice will soon bring such a knowledge of the positions of the horns of the pulp that their exposure will be but a matter of a few strokes of an instrument at the right points.

INDEX OF VOLUME II.

- Abrasion of the teeth, 215.
attachment of enamel to dentin weakened, 218.
calcification of pulps as result of, 216.
of teeth which have escaped abrasion, 217.
changes in tooth structure as result of, 216.
disappearance of sensitiveness of teeth as result of, 216.
early conservative treatment best, 219.
fillings in treatment of, in incisors, 220.
great differences in amount of wear of teeth, 215.
loss of strength of dentin, 218.
loss of vitality of teeth with, 216.
not due to normal wear, 215.
pulp exposed by, 217.
secondary dentin built in pulp chamber, 216.
sensitiveness of teeth as result of, 216.
treatment of, 218.
unevenness of, on different parts of the teeth, 218.
- Accidental exposures of horns of pulp, 103.
- Accurate measurements, value of, in manual training, 26.
- Adaptation of gold to cavity walls, importance of, 236.
- Adjustment of chair for operating, 56.
- Adverbial forms of words indicate direction, 16.
- After-condensation, 273, 280, 285.
- Aids in adjusting rubber dam, 79.
- Amalgam, 299.
author's experimental work, development of, 305.
author's micrometer for measuring shrinkage and expansion, 306.
Bogue, E. A., re, 301.
cavity preparation for, 324.
closed electric crucible for making alloys, 307.
color of, 313.
compression in packing, 327.
discoloration of the substance of the teeth by, 313.
only when a filling fails to be watertight, 314.
expansion and contraction of test fillings, note re measurements of, 311.
expansion and shrinkage not under control of operator, 319.
experimental work, summary of results of, 304.
filling with, 324.
cavity preparation, 324.
compression in packing, 327.
four surrounding walls necessary, 322.
manipulation, principles governing, 319.
matrix for, 325.
placing, 326.
pluggers and packing, 323.
polishing, 328.
rubber dam for, 324.
separation for, 326, 328.
trimming, 327.
- filling material, as a, 224, 226.
final word, re, 329.
Flagg, J. Foster, re, 303.
Fletcher, Thos., re, 301.
formula for general use, no fixed, 310.
four surrounding walls necessary, 322.
historical, 299.
Hiteheek, Thomas B., re, 301, 303, 305.
- Kirby, re, 302.
kneading, 322.
manipulation of, principles governing, 319.
matrix for, 325.
McKellops, J. H., re, 300.
mercury, amount required in, 321.
metals mixed or alloyed, differences in results, 307.
micrometer for measuring shrinkage and expansion, 306.
placing, 326.
pluggers and packing, 323.
polishing, 328.
rubber dam for, 324.
separation for, 326, 328.
should not be used for fillings in front teeth, 315.
shrinkage and expansion not under control of operator, 319.
silver-tin alloys, exhibit of, modified by addition of other metals, 312.
exhibit of, unmodified, 310.
experiments with, 309.
modification by addition of other metals, 312.

- Amalgam (continued).
 spheroiding, 317.
 steel tubes for testing, 306.
 strength of, depends on several factors, 316.
 directly under control of manipulation, 320.
 Taft, J., re, 300.
 time, effect of, on cut alloys, 308.
 conclusions, re, 309.
 Tomes, Charles, re, 302, 304, 305.
 Tomes, John, re, 301, 305, 306.
 trimming, 327.
 working properties, changes in, with time, 311.
 Witzel, Adolph, re, 303, 313, 315.
 wringing out mercury, effect of, 318.
 Anchorage for iridio-platinum post for proximal filling in incisor, 189.
 for proximo-incisal filling, 197.
 post should not be set with cement, 198.
 Anesthetizing pulp with cocain, 366.
 Angle at which condensing force should be applied in filling with cohesive gold, 266.
 Angles, axial, of teeth generally immune, 107.
 Angles of cavities, rules for naming, 9.
 Angles, squaring out with bur, 46.
 Annealing gold, 230.
 Annealing tray, 231.
 Applying rubber dam over special clamp, 83.
 Areas of plugger points, 255, 256.
 Arkansas stone for sharpening instruments, 34.
 Arrangement of instruments in operating case, 43.
 Arsenic in destroying pulp, 365.
 Author's experimental work with amalgam, 305.
 Author's experiments as to density and resistance to crushing stress of pure gold, 233.
 of gold fillings, 234.
 Author's experiments as to nature of blows and relation of sizes of plugger points as used in filling teeth, 237.
 Author's falling weight apparatus, 239.
 Author's micrometer for measuring shrinkage and expansion of amalgams, 306.
 Author's thrust dynamometer for measuring force of thrusts, or pressure, 239.
 Axial angles of teeth generally immune, 107, 141.
 Axial surface cavities, definition, 3.
 Axial wall, rule for naming, 7.
 Axio-bucco-lingual plane, 15.
 Axio-incisal angle, note re, 13.
 Axio-labio-lingual plane, 15.
 Axio-mesio-distal plane, 15.
- Back-action plugger points, special uses of, 254, 256.
 Bastard square knot, 88.
 Bastard surgeon's knot, 88.
 Bayonet plugger points, special uses of, 254, 255.
 Bevel for cutting instruments, 34.
 Bevel of cavo-surface angle, reckoned how, 15.
 Beveled rights and lefts, cutting instruments, 32.
 Bibeveled cutting instruments, 31.
 Bicuspid, abrasion of, see Abrasion.
 adjusting ligatures on, 87.
 cavity preparation and filling, see Gingival third cavities, Management of weak walls in bicuspids and molars. Pit and fissure cavities. Proximal cavities in bicuspids and molars.
 pulp treatment, see Pulp treatment.
 Binangle chisel, definition, 20.
 forms and uses, 41, 42.
 sharpening, 36.
 Binangle contra-angle, definition, 21.
 Bite, strength of, 245.
 Blade, of instruments, definition, 18.
 Blows, nature of and relation of sizes of plugger points to force as used in filling teeth, see Gold, nature of blows, etc.
 Bogue, E. A., re amalgam, 301.
 Boley gauge, 25.
 Broaches in pulp treatment, 371, 372, 381.
 Buccal cavities, see Gingival third cavities.
 angles of, 10.
 definition, 3.
 walls of, 6.
 Bucco-lingual plane, 15.
 Burs, measurement of, 24, 121.
 sharpening, 37.
 uses of, 44.
 Calcification of pulps in cases of abrasion, 216.
 of teeth which have escaped abrasion, 217.
 Calculus, use of water while removing, 50.
 Caries, dental, see Vol. 1.
 area of enamel involved in pit and fissure decays, 106.
 area of enamel involved in smooth-surface decays, 107.
 as result of interproximal wear, 212.
 backward decay, case in which enamel under free margin of gum has been undermined, 203.
 differential diagnosis from white spots, 101.
 gingival extensions of proximal decays, 146.
 detection of while excavating, 147.
 similarity of, to undermining of gingival walls of fillings, 147.

- Caries, dental (continued).
 injuries to teeth caused by, in relation to cavity preparation, 105, 120, 140.
 recurrence of, at angles of proximal fillings, 186.
 review of injuries to teeth by, 105.
 systemic susceptibility and immunity to, 110.
 uniformity of particular spot in each surface in which decay begins, 112.
- Carious dentin, method of removing in exposing pulp, 364.
 removal of, see Removal of remaining carious dentin.
- Casting apparatus for gold inlays, 353.
- Caution regarding the tying of ligatures on incisor teeth, 86.
- Cavities, classification of into artificial groups, 5, 117.
 groups of, 2.
 nomenclature of angles of, 9.
 enamel margins, 14.
 internal parts, 6.
 walls, 6.
- Cavity description, use of divisions of surfaces of teeth in, 15.
- Cavity nomenclature, 2.
- Cavity preparation, 105.
 by classes, 117.
 tabulated instrumentation of, 118, 119.
 convenience points for starting gold, cutting with bur, 47.
 definition, 105.
 for amalgam fillings, 324.
 cement fillings, 358.
 gold fillings, 117.
 gutta-percha fillings, 360.
 inlays, 333.
 general principles of, 110.
 histological structure of teeth in relation to, 93.
 injuries to teeth by caries in relation to, 105.
 pit and fissure, 105, 120.
 smooth-surface, 107, 140.
 instrumentation of, tabulated, 118, 119.
 management of weak walls in bicuspid and molars, 167.
 order of procedure in, 110.
 starting points for packing gold, cutting with bur, 47.
 walls, inclination of, 14.
 rules for naming, 2.
 rule regarding moisture on, 116.
 water, use of, in, 50.
- Cavo-surface angle, 14.
 bevel reckoned how, 15.
- Cement, 355.
 dissolution of in oral secretions, 357.
 filling with, 358.
 cavity preparation for, 358.
 for sealing treatments, 357.
 for setting inlays, 350.
 for treatment of senile decay, 211.
 mixing, 355, 356, 358.
 non-conductor of, in deep cavities, 133.
 oxychlorid of zinc, 355.
 oxyphosphate of copper, 355, 358.
 oxyphosphate of zinc, 355.
 physical properties of, 355.
 porosity of, 355, 356.
 shrinkage and expansion of, 355, 356.
 use of, 357.
- Cementing substance of enamel, 94.
- Cementum, decay of, 210.
- Centigrade circle, 24.
- Chair, adjustments of, for operating, 56.
- Chewing food, force used in, 245.
- Chisels, definition, 20.
 forms and uses, 41, 42.
 sharpening, 36.
- Chloro-percha for filling root canals, 384.
 to prevent evaporation of chloroform from, 384.
- Clamps, see Rubber dam clamps.
- Class 1 Cavities, see Pit and fissure cavities.
- Class 2 cavities, see Proximal cavities in bicuspid and molars.
- Class 3 cavities, see Proximal cavities in incisors and cuspids which do not require the removal and restoration of the incisal angle.
- Class 4 cavities, see Proximal cavities in incisors which require the removal and restoration of the incisal angle.
- Class 5 cavities, see Gingival third cavities.
- Class names of excavators, 19.
 of instruments, 19.
- Classification of cavities into artificial groups, 5, 117.
 of instruments, 26.
- Cleaning teeth preparatory to operating, water for, 50.
- Cleoid, definition, 20.
 form and use of, 42.
- Cocain in anesthetizing the dental pulp, 366.
- Cohesive gold, filling with, see Gold, filling with.
- Color of amalgams, 313.
 of porcelain inlays, 347.
- Combination of cohesive and non-cohesive gold, see Gold, filling with.
- Complex cavities, definition, 3.
 rules for naming, 7.
- Compression in placing amalgam fillings, 327.
- Compression of gold under stress, 225.
- Construction of instruments, 29.
- Contact point, building with gold, 273.
 building in incisor proximal cavities, 285.
 form of, 296.

- Contact point (continued).
 on mesial surfaces of incisors, may build new, closer to gingival than original, 190.
- Contra-angle, definition, 21.
- Contra-angle hand-piece, description and uses, 48.
 in distal cavities in upper second molar and mesial cavities in upper third molar, 155.
- Contra-angles, instruments, 32.
 rules for forming, 22.
- Contra-angle pluggers, see *Plugger points*.
- Convenience form, in cavity preparation, 113.
 in deep occlusal cavities in molars, 133.
 in gingival third cavity in buccal surface of molar, 202.
 in labial surface of incisor, 208.
 in large pit cavity in upper first molar, 127.
 in occlusal cavities in lower molars, 137.
 in upper second and third molars, 135.
 in mesial cavity in upper central incisor, 183.
 in mesio-occlusal cavity in lower second molar, 168.
 in upper first molar, 152, 162.
 in small pit cavity in upper first molar, 123.
- Convenience points, cutting with bur, 47, 152.
 cutting with chisel, 153.
- Cotton for separating teeth, 262.
- Cross-mouth finger positions, 66.
- Cross sections of proximal cavities and fillings, 163.
- Crystal gold, 227, 251.
- Curled enamel, 95.
- Cuspid teeth, see *Incisors and cuspids*.
- Cutting holes in the rubber dam, 70.
- Cutting instruments, 17.
 classification of, 17.
 nomenclature of, 17.
- Cutting out grooves with bur, 46.
- Cutting steps for anchorage with bur, 45.
- Decrease in finger power among dentists, 55.
- Density necessary in gold fillings, 236
- Dental instrument gauge, 23.
- Dental nomenclature, definition, 2.
- Dentin, area involved in pit and fissure decays, 106.
 in smooth-surface decays, 110.
- Dentin elasticity of, 224.
 loss of strength of, in teeth with abrasion, 218.
 secondary, built in pulp chamber as result of abrasion, 216.
 wall, definition, 14.
 walls not cut parallel for greater strength, 134.
- Dentists' manudynamometer, 53.
- Dento-enamel junction, definition, 14.
- Direct-acting quadrangle plugger points, special uses of, 254, 256.
- Diseoid, definition, 20.
 form and use, 42.
 sharpening, 37.
- Discoloration of the substance of the teeth by amalgam, 313.
 only when filling fails of being water-tight, 314.
- Dissolution of cements in oral secretions, 357.
- Distal cavities, definition, 3.
 in bicuspids and molars, see *Proximal cavities in bicuspids and molars*.
 angles of, 10.
 walls of, 7.
 in incisors and cuspids, see *Proximal cavities in incisors and cuspids*.
 angles of, 12.
 walls of, 8.
- Disto-incisal cavities, see *Proximal cavities in incisors*.
 angles of, 13.
 walls of, 8.
- Disto-occlusal cavities, see *Proximal cavities in bicuspids and molars*.
 angles of, 11.
 walls of, 7.
- Divisions of surfaces of teeth, use of, in cavity description, 15.
- Double plane instruments, 31.
- Drills, measurements of, 24.
 uses of, 48.
- Dynamometer for measuring force of thrusts, or pressure, 239.
- Elasticity of dentin, 224.
- Elasticity of gold, 233.
- Electric annealer, 231.
- Electric crucible for making alloys, 307.
- Electric mallet for condensing gold, 252.
- Enamel, attachment of, to dentin, weakened in teeth with abrasion, 218.
 caries of, see *Caries*.
 cementing substance of, 94.
 curled, 95.
 grooves of, weak lines, 101.
 histological structure of, in relation to cavity preparation, 93.
 rods of, 94.
 how to study directions and inclinations of, 96, 100.
 parallel near surface, 95.
 statements of directions of in different parts of the crowns of the teeth, 96.
 variations in the inclinations of, from a right angle to the surface, 97.
 straight, 94.
 wall, definition, 14.
 wall, finishing of, see *Finishing of enamel wall*.
 white spots in, 101.

- Enamel hatchets, definition, 20.
 forms and uses, 41, 42.
 sharpening, 36.
- Enamel margins, nomenclature of, 14.
- Engine, dental, use of, 44.
- Enlarging root canals with drill, 48.
- Essential oils, see Oils.
- Excavation of cavities, see Cavity preparation.
- Excavators, see Instruments, cutting.
- Expansion and contraction of test amalgam fillings, note re, 311.
- Exposure of dental pulp, see Pulp.
- Extension for prevention, see Caries, dental.
 a definite requirement, 142.
 ease illustrating meaning of, 143.
 cavities in incisors representing minimum and maximum, 185.
 conditions upon which extensions should be based, 109.
 cutting, with bur, 46.
 effect of wide separation on width of extensions to buccal and lingual, 166.
 in gingival third cavities, 109, 202.
 in proximal cavities in incisors and cuspids, 189.
 limited by extent of separation of the teeth, 144.
 what it does not mean, 145.
 what it means, 142.
- Extensions of caries gingivally, 146.
 detection of while operating, 147.
- Face of pluggers, definition, 18.
- Falling weight apparatus, for measuring force of blows, 239.
- Fifth grasp in applying rubber dam, 73, 78.
- Files in finishing gold fillings, 294.
 sharpening same, 37.
- Filling cavities with amalgam, see Amalgam.
 cement, see Cement.
 cohesive gold, see Gold.
 gutta-percha, see Gutta-percha.
 non-cohesive gold, see Gold.
- Filling materials, physical properties of, 224.
 amalgam, see Amalgam.
 cement, 355.
 desirable qualities, 224.
 gold, see Gold.
 tin, 224.
- Fillings, solidity and strength required of, different for different persons, 253.
 strength required in, 245.
- Final word re amalgam, 329.
- Finger positions, 60.
- Finger power, 53.
 training to develop, 54.
 decrease in, among dentists, 55.
- Finger rests in operating, 60.
- Finish of enamel wall, in cavity preparation, 100, 115.
 for gold inlays, 335.
 for porcelain inlays, 335, 340.
 in gingival third cavity in buccal surface of molar, 202.
 in labial surface of incisor, 209.
 in large pit cavity in upper first molar, 127.
 in mesial cavity in upper central incisor, 183.
 in mesio-occlusal cavity in lower second molar, 168.
 in upper first molar, 153, 162.
 in small pit cavity in upper first molar, 123.
 when walls approach crests of marginal ridges, 136.
- Finishing files, for gold fillings, 294.
 sharpening same, 37.
- Finishing knives, for gold fillings, 294.
- Finishing gold fillings, see Gold fillings, finishing.
- First grasp in applying rubber dam, 73, 75.
- Fissure bur, uses of, 45.
- Fissure cavities, see Pit and fissure cavities.
- Flagg, J. Foster, re amalgam, 303.
- Fletcher, Thomas, re amalgam, 301.
- Foil, gold, 227.
- Food, force used in chewing, 245.
- Fool's knot, 88.
- Foot pluggers, special uses of, 254, 256.
- Force, application of, in filling with cohesive gold, 251.
 different plans of applying, 251.
 limit to force that can be applied, 253.
 relation of size of plugger points to, 253.
 table showing force required to condense gold with pluggers of different sizes, 242.
- Force used in chewing food, 245.
- Forms of cutting instruments, studies of, 38.
- Forms of plugger points, 253.
- Formula for amalgam alloy, no fixed.
 good for general use, 310.
- Formula names of instruments, 22.
 of plugger points, 254.
- Formulas of cutting instruments, studies of, 38.
- Fourth grasp in applying the rubber dam, 73, 77.
- Furnaces for inlay work, 350.
- General susceptibility and immunity to dental caries, 110.
- Gingival extensions of proximal decays, 146.
 detection of while operating, 147.
 similarity of undermining of gingival walls of fillings, 147.
- Gingival line, note re term, 138.

- Gingival margin trimmers, definition, 20.
forms and uses, 41, 42.
sharpening, 37.
- Gingival third cavities in the buccal and labial surfaces of the teeth (Class 5), filling, 289.
cohesive gold, 289.
gold inlays, 343.
non-cohesive gold, 248.
porcelain, 341.
 case, labial surface of upper central incisor, 342.
 preparation of cavities, 341.
 rubber dam on for, 343.
- Gingival third cavities in the buccal and labial surfaces of the teeth (Class 5), preparation of, 199.
buccal surfaces of molars, 200.
 case, buccal surface of upper first molar, 200.
 case, buccal surfaces of lower bicuspids and molars, 205.
 case, buccal surfaces of upper bicuspids and molars, 203.
 cases in which pulp is exposed, 205.
 in upper third molars, 205.
 large buccal cavities, complicated by occlusal decays, 205.
 variations, 204.
 case in which backward decay has undermined enamel under free margin of gum, 203.
 preliminary preparation to keep cavity dry, 203.
 cases in which pulp is exposed, 205, 209.
 complicated by occlusal decays, 205.
 complicated with proximal surface cavities, 209.
 difference in depth of cutting for gold and porcelain, 208.
 excavation difficult on account of sensitiveness, 206.
 extension for prevention, 202.
 general considerations, 199.
 gold inlays, preparation for, 343.
 gum, change in position of free border of, on buccal surfaces with advancing age, 201.
 in cases of intense susceptibility, 206.
 in labial surfaces of incisors and cuspids, 207.
 case, labial surface of upper central incisor, 207.
 cases in which pulp must be removed, 209.
 complicated with proximal surface cavities, 209.
 in neglected cases, 209.
 variations, 209.
 in young women or young mothers, cases of intense susceptibility, 206.
porcelain inlays, preparation for, 341.
senile decay, 210.
tabulated instrumentation, 119.
with recession of gums, 210.
- Gingival wall, covering with gold, 268, 274.
- Gingival walls of proximal fillings, undermining of, by caries, similar to gingival extensions of proximal decays, 147.
- Glossary, see Vol. 1, 279.
- Gnathodynamometer tests, 245.
- Gold, as a filling material, physical properties of, 234.
adaptation to cavity walls, importance of, 236.
annealing, 230.
compression of, under stress, 225.
density, minimum necessary in fillings, 236.
elasticity of, 233.
experimental fillings, by different operators, 235.
 compared with those made in teeth, 235.
experiments as to welding property, 228.
 to keep gold so that welding property will be fully developed when annealed, 229.
force used in filling, see Gold, nature of blows, etc.
forms of, 227.
importance of proper adaptation of, to cavity walls, 236.
methods of annealing, 230.
minimum density necessary in fillings, 236.
resistance to crushing stress, 232, 233, 234.
specific gravity under varying physical conditions, 232, 233, 234.
strength required in fillings, 245.
strength required of fillings, different in different positions, 237.
welding property, 227.
 to keep gold so that welding property will be fully developed when annealed, 229.
- Gold, filling cavities with by classes, 265.
see Gingival third cavities, Pit and fissure cavities, Proximal cavities in bicuspids and molars, Proximal cavities in incisors and cuspids.
- Gold, filling with, 247.
cohesive, 249.
 adaptation impossible with force perpendicular to wall, 269.
 after-condensation, 273.
 angle at which condensing force should be applied, 266.
 application of force in filling, 251.
 cavities, see Gold, filling cavities by classes.
 cavo-surface angle, covering, 270.

- Gold, filling with (continued).
 contact point, building, 273.
 crystal, 227, 251.
 electric mallet for condensing, 252.
 foil, preparation of, 249.
 force, application of, in filling, 251.
 force used in filling, see Gold, nature of blows, etc.
 gingival wall, covering, 268.
 hand pressure, 251, 252.
 limit to force that can be applied in filling teeth, 253.
 mallet force, 251.
 margins, covering, 273.
 mechanical mallet for condensing, 252.
 necessity of close and definite appreciation of relation of lines of force to planes of cavity walls, 279.
 occlusal margins, covering, 273.
 occlusal step, building into, 271.
 plugger points, 253.
 preparation of foil, 249.
 relation of size of plugger points to the application of force, 253.
 solidity and strength of fillings different for different persons, 253.
 starting the filling, 265.
 stepping the plugger point, 266.
 thin layer of gold should not be spread on gingival wall, 269.
 walls of cavities, conditions in building gold against, 268.
 wedging principle in packing gold, 266.
 combination of cohesive and non-cohesive in large and deep occlusal cavities, 281.
 in proximal cavities in bicuspid and molars, 274.
 non-cohesive, 247.
 almost a lost art, 249.
 buccal cavities, 248.
 does not stand attrition so well as cohesive, 249.
 fillings made in less time than with cohesive, 249.
 instrument grasp for, 55.
 labial cavities, 248.
 limited to cavities having four surrounding walls, 247.
 method of procedure, 247.
 occlusal cavities, 247.
 watertight margins more certain than with the cohesive, 249.
- Gold fillings, finishing, 291.
 contact point, form of, 296.
 exceptions, 293.
 files for, 294.
 form of, proper, 295.
 knives for, 294.
 occlusal surface fillings, 297.
 polishing, 297.
 proximal surface fillings, 291.
 saws for, 293.
 separation, 292.
- Gold inlays, 330.
 apparatus for casting, 353.
 forming the mold, 353.
 impression of the cavity, 353.
 in gingival third cavities in buccal and labial surfaces, 343.
 in pit and fissure cavities, 334.
 in proximal cavities in bicuspid and molars, 337.
 in proximal cavities in incisors and cuspids, 340, 341.
 practice work, 354.
 preparation of cavities for, 333.
 selection of cases, 331.
 Taggart, W. H., re, 352.
- Gold, nature of blows and relation of sizes of plugger points to force used in filling teeth, 237.
 author's experiments in measuring the force of blows, 239.
 effect of blows, elements in considering the, 238.
 force with which plugger strikes the gold, measurement of, 239.
 personal application by dentists of knowledge of force of blows, 243.
 rules for finding actual pounds or kilograms delivered by blows, 244.
 strength required in fillings, 245.
 table showing diameter and area of points, pounds and kilograms stress by fall of mallets, 240.
 table showing force required to condense gold with pluggers of different sizes, 242.
- Grasps, of instruments, 52.
- Grooves, cutting out with bur, 46.
 not cut to depth of principal part of pulpal wall, 134.
 weak lines in enamel, 101.
- Gum, change in position of free border of on buccal surface with advancing age, 201.
- Gum margin, note re term, 138.
- Gum septum, destruction of as result of interproximal wear, 212.
 protection of, interproximal, 189.
- Gums, recession of, in connection with gingival third cavities, 210.
- Gutta-percha, 360.
 filling deciduous teeth with, 362.
 permanent teeth with, 360.
 root canals with, 383.
 sealing treatments with, 357, 361, 366.
 no discoloration of teeth if treatments are sealed with, 361.
 prevention of pressure, 366.
 senile decay, treatment of, with, 211.

- Gutta-percha (continued).
 sensitive dentin, treatment of, with, 362.
 separation with, 262, 263.
- Hand-piece, contra-angle, 48.
- Hand pressure in filling with gold, 251, 252.
- Hand pressure plunger points, special uses of, 254, 256.
- Hatch clamp, for gingival third cavities, 90.
 application of, 90.
- Hatchet excavators, definition, 19.
 forms and uses, 38.
 sharpening, 35.
- Hill's stopping, see Gutta-percha.
- Histological characters of the enamel in relation to cavity preparation, 94.
- Histological structure of the teeth in relation to cavity preparation, 93.
- Historical, amalgam, 299.
- Hitchcock, Thomas B., re amalgam, 301, 303, 305.
- Hoe excavators, definition, 19.
 forms and uses, 38.
 sharpening, 35.
- Horizontal plane, definition, 14.
- Horns of pulp chambers, filling, 385.
- Immunity, systemic, to dental caries, 110.
- Impressions for gold inlays, 353.
- Inceisal angle, note re, 13.
- Incisor lingual cavities, definition, 3.
- Incisors and cuspids, abrasion of, see Abrasion.
 adjusting ligatures on, 86.
 cavity preparation and filling, see Gingival third cavities, Pit and fissure cavities, Proximal cavities in incisors and cuspids.
 pulp treatment, see Pulp treatment.
 root canal filling, see Root filling.
- Inclination of cavity walls, definition, 14.
- Inclination of walls for convenience in placing filling in occlusal cavities in upper second and third molars, 135.
 in lower molars, 137.
- Injuries to the teeth by caries in relation to cavity preparation, 105, 120, 140.
- Inlays, 330. See Gold inlays, Porcelain inlays.
 gold inlay, technic of making, 352.
 in gingival third cavities in buccal and labial surfaces, 341.
 in pit and fissure cavities, 334.
 in proximal cavities in bicuspids and molars, 335.
 in proximal cavities in incisors and cuspids, 338, 340.
 porcelain inlay, technic of making, 344.
 preparation of cavities for, 333.
 selection of cases, 331.
- Instrumentation, tabulated, for preparation of cavities by classes, 118, 119.
- Instrument grasps, 52.
- Instruments, angles of shanks of, 21.
 binangle, 21.
 contra-angle, 21.
 mon-angle, 21.
 rules for forming contra-angles, 22.
 triple-angle contra-angle, 21.
- cutting, see Instruments, cutting.
 excavators, see Instruments, cutting.
 measurement, rules for, 23.
 nomenclature of, 17.
 angles of shank, 20.
 class names, 19.
 formula names, 22.
 gauge for measuring, 23.
 metric system of measurement, 23.
 order names, 18.
 sub-class names, 19, 20.
 sub-order names, 18.
 pluggers, see Pluggers.
- Instruments, cutting, 17.
 arrangement of, in the operating case, 43.
 class names of, 19.
 chisel, binangle, 20.
 chisel, straight, 20.
 cleoid, 20.
 discoid, 20.
 enamel hatchets, 20.
 gingival margin trimmers, 20.
 hatchet, 19.
 hoe, 19.
 spoons, 20.
 classification of, 26.
 construction of, 29.
 beveled rights and lefts, 32.
 bibeveled, 31.
 contra-angles, 32.
 double plane, 31.
 rights and lefts, 31.
 single plane, 31.
 forms and formula, with outline of uses, 38.
 chisels, binangle, 41, 42.
 chisels, straight, 41, 42.
 cleoid, 42.
 discoid, 42.
 enamel hatchets, 41, 42.
 gingival margin trimmers, 41, 42.
 hatchets, 38.
 hoes, 38.
 ordinaries, 38.
 side instruments, 42.
 specials, 40.
 spoons, 41, 42.
 points, how to learn to read, 39.
 rules for measurement, 23.
 sets of, 27.
 complete set, 27.
 long set, 27.
 short set, 28.
 university set, 28.
- Interproximal gum septum, protection of, 189.

- Interproximal wear, 211.
 artificial crowns, difficulty in placing
 in cases of, 222.
 diagnosis, 212.
 results of, 212.
 caries of teeth, 212.
 destruction of gum septum, 212.
 treatment of, 212.
 cases in which treatment will fail,
 214.
- Introduction, 1.
- Inverted cone bur, uses of, 45.
- Iridio-platinum post for anchorage for
 proximal fillings in incisors, 189.
 in proximo-incisal fillings, 197.
 should not be set with cement, 198.
- Kirby, re amalgam, 302.
- Kneading amalgam, 322.
- Kuives, for finishing proximal gold fill-
 ings, 294.
- Knots,
 bastard square, 88.
 bastard surgeon's, 88.
 fool's, 88.
 square, 88.
 surgeon's, 85, 87.
- Labial cavities, see Gingival third cavi-
 ties.
 angles of, 12.
 definition, 3.
 walls of, 9.
- Labial margin of proximal cavities in in-
 cisors and cuspids, 189.
- Labio-lingual plane, 15.
- Labio-mesial and labio-distal angles of
 incisors and cuspids, cases in which
 same should be cut away, 190.
- Lamination of gold in proximal cavities,
 in bicuspid and molars, 272, 276.
 in incisors, 283, 287.
- Left side behind finger position for
 lower teeth, 65.
 for upper teeth, 65.
- Left side behind position at the chair,
 58, 59.
- Left side in front finger position for
 lower teeth, 66.
 for upper teeth, 65.
- Left side in front position at the chair,
 58, 59.
- Ligature, as an aid in adjusting rubber
 dam, 79, 85.
 adjusting on bicuspid and molars, 87.
 adjusting on incisors and cuspids, 86.
 danger of injury to periodontal mem-
 brane, 86.
 how to tie about the teeth, 87.
 passing the contact with, 85.
 removal of, 92.
 should not be tied on teeth on which a
 clamp, matrix or separator is to
 be placed, 87.
 tying under a clamp, 82.
- Line angles of cavities, nomenclature
 of, 9.
- Lingual cavities, see Gingival third cavi-
 ties, Pit and fissure cavities.
 angles of, 10, 12.
 definition, 3.
 walls of, 6, 9.
- Lingual incisor cavities, see Pit and fis-
 sure cavities.
 angles of, 12.
 definition, 3.
 walls of, 9.
- Lingual margin of proximal cavities in
 incisors and cuspids, 189.
- Lingual pit cavities in incisors, see Pit
 and fissure cavities.
- Linguo-mesial and linguo-distal angles of
 incisors and cuspids, cases in which
 same should not be cut away, 190.
 direction of enamel rods uncertain, 191.
- Long set of cutting instruments, 27.
- Mallet, electric, for condensing gold, 252.
 mechanical, for condensing gold, 252.
- Management of weak walls in bicuspid
 and molars, 167.
 bicuspid, undermining of angles, 172.
 buccal wall more often weak in upper
 molars, 170.
 disto-lingual cusp of upper first molar,
 undermining of, 170.
 disto-occlusal cavity in bicuspid in
 which mesio-occlusal filling had
 been previously made, 174.
 lingual groove in lower molars, 169.
 mesio-disto-occlusal cavity in bicuspid
 when pulp is alive and when pulp
 is removed, 174.
 incorrect preparation as result of
 which cusp is apt to split off,
 176.
 mesio-occlusal cavity in lower second
 molar, 167.
 separation with gutta-percha, 171.
- Manipulation of amalgam, see Amalgam.
- Manudynamometer, dentists', 53.
- Matrix for amalgam fillings, 325.
 for porcelain inlays, 344.
 annealing, 345.
 burnishing, 345.
 other methods, 346.
 reburnishing, 349.
 to hold rubber dam in place, 91.
 use of, in large buccal cavities, compli-
 cated by occlusal decays, 205.
- McKellops, H. J., re amalgam, 300.
- Measurements of burs and drills, rules
 for, 24.
- Measurement of cutting edges of exca-
 vators, sizes of plugger points and
 diameter of burs, length of milli-
 meter, unit of, 121.
- Measurement of instruments, rules for,
 23.

- Mechanical mallet for condensing gold, 252.
- Mercury, amount of, required in amalgam, 320.
to determine right amount of, 321.
- Mesial cavities, see Proximal cavities in bicuspid and molars, Proximal cavities in incisors and cuspids.
angles of, 10, 12.
definition, 3.
walls of, 7, 8.
- Mesio-disto-occlusal cavities, see Proximal cavities in bicuspid and molars.
- Mesio-distal plane, 15.
- Mesio-incisal cavities in incisors, see Proximal cavities in incisors.
angles of, 13.
walls of, 8.
- Mesio-occlusal cavities, see Proximal cavities in bicuspid and molars.
angles of, 11.
walls of, 7.
- Metals, noble, 228.
- Metric system of measurement, 23.
- Micrometer, amalgam, for measuring shrinkage and expansion, 306.
- Mixing cements, 355, 356, 358.
- Modification of silver-tin alloys by the addition of other metals, 312.
- Moisture on cavity walls, rule re, 116.
- Molar teeth, abrasion of, see Abrasion, adjusting ligatures on, 87.
cavity preparation and filling, see Gingival third cavities, Management of weak walls in bicuspid and molars, Pit and fissure cavities, Proximal cavities in bicuspid and molars.
pulp treatment, see Pulp treatment.
- Mold for gold inlays, 353.
- Mon-angle, definition, 21.
- Names of operating instruments, 18.
- Names of parts of instruments, 17.
- Nib of pluggers, definition, 18.
- Noble metals, 228.
- Nomenclature, definition, 2.
dental, 2.
of angles of cavities, 9.
of cavities, 2.
of enamel margins, 14.
of finger positions in operating, 60.
of instruments, 17.
of internal parts of cavities, 6.
of positions at the chair, 56.
of walls of cavities, 6.
- Non-cohesive gold, see Gold.
- Non-conductor of cement in deep occlusal cavities, 133.
of quill in proximal cavities, 187.
- Occlusal step in proximal cavities in bicuspid and molars, 143.
filling same with gold, 271.
- Occlusal surface cavities, see Management of weak walls in bicuspid and molars, Pit and fissure cavities.
angles of, 10.
definition, 3.
walls of, 6.
- Oils, essential, note re, 128.
to remove a fixed oil from a cavity, 128.
- Opening pulp chamber, see Pulp treatment.
- Operative dentistry, definition, 1.
- Order names of instruments, definition, 18.
- Order of procedure in cavity preparation, 110.
- Ordinaries, forms and uses, 38.
- Outline form, in cavity preparation, 111.
in deep occlusal cavity in upper molar, 130, 132.
in gingival third cavity in buccal surface of molar, 201.
in labial surface of incisor, 207.
in large pit cavity in upper first molar, 125.
in mesial cavity in upper central incisor, 179.
in mesio-occlusal cavity in lower second molar, 167.
in upper first molar, 148, 150, 151, 159, 161.
in occlusal cavity in lower molar, 137.
in pit and fissure cavities, 111.
in small pit cavity in upper first molar, 121.
in smooth-surface cavities, 111.
- Oxychlorid of zinc cement, 355.
- Oxyphosphate of copper cement, 355.
- Oxyphosphate of zinc cement, 355.
- Packing amalgam, 323.
- Palm-and-thumb grasp, 52.
- Palm-thrust grasp, 53.
- Parallelogram pluggers, special uses of, 253, 254.
- Passing the contact with ligature, 85.
- Pen grasp, 52.
- Peridental membrane, danger of injury to by tying ligatures on incisor teeth, 86.
- Perry separator, see Separators.
- Personal application by dentists of knowledge of force of blows, 243.
- Physical properties of cements, 355.
- Pit and fissure cavities, causes of, 120.
conditions presenting, 121.
definition of, 4.
- Pit and fissure cavities (Class 1), filling, 280.
cohesive gold, 280, 282.
covering occlusal margins, 273.
gold inlays, 334.
non-cohesive gold, 247.
in large and deep occlusal cavities, 281.
porcelain, 334.

- Pit and fissure cavities, injuries by caries in relation to cavity preparation, 105, 120.
positions of occurrence, 5.
- Pit and fissure cavities (Class 1), preparation of, 120.
buccal surfaces of molars, 138.
case, deep occlusal cavity in upper molar, 130.
non-conductor of cement in, 133.
variations, 133.
case, large pit cavity in central fossa of upper first molar, 125.
case, small pit cavity in central fossa of upper first molar, 121.
variations, 124.
dentin walls not cut parallel for greater strength, 134.
distal pit in occlusal surface of upper molars, 136.
gold inlays, preparation for, 334.
grooves not cut to depth of principal part of pulpal wall, 134.
inclination of mesial wall and mesio-buccal angle in occlusal cavities in lower molars, 137.
in upper second and third molars, 135.
lingual groove in lower molars, 169.
lingual of upper incisors, 139.
non-conductor of cement in, 133.
occlusal cavities in lower bicuspid, 137.
in lower molars, 136.
in upper bicuspids, 137.
in upper second and third molars, 135.
outline form in occlusal cavities in lower molars, 137.
porcelain inlays, preparation for, 334.
tabulated instrumentation, 118.
walls of occlusal cavities that approach crests of marginal ridges, 136.
- Planes of the teeth, definition, 14.
- Plugger points, 253.
for amalgam, 323.
set of, 324.
for gold, areas of, 255, 256.
set of, 254.
size of and relation of nature of blows to force as used in filling, 237.
sizes of in relation to application of force, 253.
special uses of, 254.
formula names of, 254.
nomenclature of, 18.
rules for measurement, 254.
unit of measurement, 121.
- Point angles of cavities, nomenclature of, 9.
- Polishing fillings, amalgam, 328.
gold, 297.
use of water in, 51.
- Porcelain inlays, 330.
appearance of, as compared with gold, 332.
cement for setting, 350.
color of, 347.
furnaces for baking, 350.
in gingival third cavities in buccal and labial surfaces, 341.
case, labial cavity in upper incisor, 342.
difference in depth of cutting for porcelain and gold, 208.
in pit and fissure cavities, 334.
in proximal cavities in bicuspids and molars, 335.
in mesio-disto-occlusal cavities in bicuspids, 337.
in mesio-occlusal cavities in upper bicuspids and first molars, 336.
in proximal cavities in incisors and cuspids which do not require the restoration of the incisal angle, 338.
approach from labial or lingual, 338, 340.
cavity walls, finish of, 340.
marginal edge of cavity toward observer, 340.
must not be cemented against unsupported enamel exposed to view, 339.
separation for, 338, 339.
in proximal cavities in incisors which do require the restoration of the incisal angle, 196, 198, 340.
preparation of cavities for, 333.
matrix for, 344.
making the inlay, 347.
selection of cases, 331.
setting the inlay, 350.
translucence of, 347.
- Porosity of cements, 355, 356.
- Positions at the chair, 56.
- Positions of holes in the rubber dam, 70.
- Positions of occurrence of pit and fissure cavities, 5.
of smooth-surface cavities, 5.
- Post of iridio-platinum for anchorage for proximal fillings in incisors, 188.
in proximo-incisal fillings, 197.
should not be set with cement, 198.
- Preparation of cavities, see Cavity preparation.
- Preparation of gold foil, 249.
- Proximal cavities in bicuspids and molars, angles of, 10, 11.
definition, 3.
early discovery, importance of, 145.
walls of, 7.
- Proximal cavities in bicuspids and molars (Class 2), filling, 265.
cohesive gold, 265.
adaptation impossible with force perpendicular to wall, 269.
after-condensation, 273, 280.

- Proximal cavities in bicuspid and molars, filling (continued).
 angle at which condensing force should be applied, 266.
 back-action instruments, use of, 279.
 bicuspid, lower, distal cavities, 280.
 case, mesio-occlusal cavity in upper first molar, 265.
 cavo-surface angle, covering, 270.
 contact point, building, 273.
 contact point, proper form of, 295.
 contra-angle plugger for building along cavity walls, 272.
 contra-angle plugger for condensing gold on gingival wall, 268, 269.
 contra-angle plugger for covering cavo-surface angle, 270.
 distal cavities, 277.
 finishing, 291.
 gingival wall, covering, 268.
 instruments for, 265.
 lamination of gold in, 272.
 mesial cavities, 265.
 molars, distal cavities, 277.
 molars, mesial cavities, 265.
 occlusal margins, covering, 273.
 occlusal step, building into, 271.
 polishing, 297.
 separation, 259.
 starting the filling, 265.
 stepping the plugger point, 266.
 thin layer of gold should not be spread on gingival wall, 269.
 walls of cavities, conditions in building gold against, 268.
 wedging principle in packing gold, 266.
- combination of non-cohesive and cohesive gold, 274.
 difficulties in using, 277.
 gingival wall, covering with non-cohesive gold, 274.
 lamination of gold in, 276.
 non-cohesive safer than cohesive on gingival wall, 275.
 gold inlays, 337.
 porcelain, 335.
- Proximal cavities in bicuspid and molars (Class 2), preparation of, 143.
 approach to distal cavities in upper second molars, 156.
 bicuspid, cavities of this class in, 156.
 disto-occlusal cavity in case in which mesio-occlusal filling had been previously made, 174.
 mesio-disto-occlusal cavity when pulp is alive and when pulp is removed, 174.
 undermining of angles of, 172.
 buccal and lingual extensions, width of, 166.
 buccal wall often weak in upper molars, 170.
 case, mesio-disto-occlusal cavity in bicuspid when pulp is alive and when pulp is removed, 174.
 case, mesio-occlusal cavity in lower molar, with weak walls, 167.
 case, mesio-occlusal cavity in upper first molar, 148.
 variations, 154.
 case, mesio-occlusal cavity in upper first molar, 158.
 variation of procedure when pulp exposure is feared, 160.
 cavity walls, relation of, to recessional lines of pulpal horns, 157.
 cross sections of cavities and fillings, 163.
 danger of pulp exposure, 158.
 distal cavity in second molar and mesial cavity in third molar, 155.
 distal cavities, 155.
 in lower bicuspid, 157.
 in lower molars, 156.
 in upper second molars, approach to, 156.
 occlusal step, cutting in, 155.
 disto-lingual cusp in upper molars, undermining of, 170.
 disto-occlusal cavity in case in which mesio-occlusal filling had been previously made, 174.
 extension for prevention, to buccal and lingual, 166.
 extensions of decay gingivally, 151.
 lingual and buccal extensions, width of, 166.
 lower first molars, cavity form in, 154.
 mesio-disto-occlusal cavity in bicuspid when pulp is alive and when pulp is removed, 174.
 incorrect preparation as a result of which cusp is apt to be split off, 176.
 mesio-occlusal cavity in lower molar, with weak walls, 167.
 mesio-occlusal cavity in upper first molar, case, 148.
 variations, 154.
 mesio-occlusal cavity in upper first molar, case, 158.
 variation in procedure when pulp exposure is feared, 160.
 molars, buccal wall often weak in upper, 170.
 distal cavities in, 155.
 lower first, cavity form in, 154.
 mesial cavities in, see Mesio-occlusal.
 weak walls in, management of, 167.
 occlusal step, cutting, in distal cavities, 155.
 occlusal step, outline of, 150.
 opening the cavity, 148.
 plans of excavating, 148.
 variations, 154.
 pulp exposure, danger of, 158.

- Proximal cavities in bicuspid and molars, preparation of (continued).
 pulp exposure feared, variation in procedure when, 160.
 pulpal horns, relation of recessional lines of, to cavity walls, 157.
 recessional lines of pulpal horns, relation of, to cavity walls, 157.
 separation, 171, 259.
 effect of wide, on buccal and lingual extensions, 166, 172.
 tabulated instrumentation, 118.
 weak walls in bicuspid and molars, management of, 167.
- Proximal cavities in incisors and cuspids, angles of, 12.
 definition, 3.
 early discovery, importance of, 145.
 walls of, 8.
- Proximal cavities in incisors and cuspids which do not require the restoration of the incisal angle (Class 3), filling, 282.
 cohesive gold, 282.
 after-condensation, 285.
 case, distal cavity in incisor, 282.
 contact point, 285.
 contact, proper form of, 295.
 distal cavity in incisor, case, 282.
 finishing, 291.
 gingival portion, 283.
 incisal retention, 284.
 instruments for, 282.
 lamination of gold, 283, 287.
 lingual wall, covering, 283.
 polishing, 297.
 variations, 286.
 gold inlays, 340.
 porcelain inlays, 338.
 approach from labial or lingual, 338, 340.
 cavity walls, finish of, 340.
 marginal edge of cavity toward observer, 340.
 must not be cemented against unsupported enamel exposed to view, 339.
 separation for, 338, 339.
- Proximal cavities in incisors and cuspids which do not require the restoration of the incisal angle (Class 3), preparation of, 177.
 avoid appearance of sharp angles in cavity outlines, 190.
 case, distal cavity in upper central incisor, 184.
 case, distal cavity in upper lateral incisor, 186.
 case, mesial cavity in upper central incisor, 178.
 case, mesial cavity in upper central incisor, badly decayed, 187.
 with pulp alive, 188.
 with pulp removed, 188.
- cases in which labio-mesial or labio-distal angle should be cut away, 190.
 contact, sometimes build new closer to gingival than original, on mesial surface, 190.
 decay, recurrence of, 186.
 distal cavity in upper central incisor, case, 184.
 distal cavity in upper lateral incisor, case, 186.
 extension for prevention, case representing minimum, 185.
 general observations on, 189.
 gingival margin, 189.
 gold inlays, preparation for, 340.
 interproximal gum septum, protection of, 189.
 iridio-platinum post for retention, 188.
 should not be set with cement, 198.
 labio-proximal angles, cases in which same should be cut away, 190.
 lingual marginal ridge, cases in which same should be cut away, 191.
 linguo-proximal marginal ridges often sharp and direction of enamel rods uncertain, 191.
 margins, position of, 189.
 mesial cavity in upper central incisor, case, 178.
 mesial cavity in upper central incisor badly decayed, case, 187.
 with pulp alive, 188.
 with pulp removed, 188.
 non-conductor of quill, 187.
 outline, avoid appearance of sharp angles in, 190.
 porcelain inlays, preparation for, 338.
 preliminary preparation, 178.
 quill, as a non-conductor, 187.
 recurrence of decay, 186.
 separation, 259.
 tabulated instrumentation, 119.
- Proximal cavities in incisors and cuspids which require the restoration of the incisal angle (Class 4), filling, 282.
 cohesive gold, 282.
 after-condensation, 285.
 angles, building of, 287.
 appearance depends most on good tooth form, 196.
 contact point, 285.
 contact, proper form of, 295.
 finishing, 291.
 gingival portion, 283.
 instruments for, 282.
 lamination of gold, 283, 287.
 lingual wall, covering, 283.
 polishing, 297.
 strength required of, 246.
 variations, 286.
 gold inlays, 341.
 porcelain inlays, 196, 198, 340.

- Proximal cavities in incisors and cuspids which do require the restoration of the incisal angle (Class 4), preparation of, 191.
- anchorage by forming a step in incisal edge, 194.
- by undercutting incisal edge, 193.
- in the pulp chamber, 196.
- iridio-platinum post in root canal, 197.
- avoid appearance of sharp angles in cavity outlines, 190.
- choice of plans, general statement of, 192.
- conditions that may present, 191.
- danger of death of pulp on account of thermal changes, 196.
- decay, recurrence of, 186.
- general observations on, 189.
- gingival margin, 189.
- gold inlays, preparation for, 341.
- incisal margin should be zigzag across incisal edge, 193.
- incisal step for anchorage, 194.
- interproximal gum septum, protection of, 189.
- iridio-platinum post in root canal for anchorage, 197.
- should not be set with cement, 198.
- non-conductor of quill, 187.
- plans of repair, 192.
- porcelain inlays, preparation for, 340.
- pulp chamber, anchorage in, 196.
- pulp, danger of death of on account of thermal changes, 196.
- quill, non-conductor of, 187.
- recurrence of decay, 186.
- separation, 259.
- tabulated instrumentation, 119.
- teeth with thin cutting edges, 195.
- undercutting incisal edge for anchorage, 193.
- wear of incisal edges has exposed dentin, cases in which, 196.
- Proximo-occlusal cavities, angles of, 11.
- walls of, 7.
- Pulp, dental, 363.
- abrasion, exposure by, 217.
- accidental exposure of horns of, 103.
- anesthetizing with cocain, 366.
- cases in which pulp is exposed, 366.
- cases in which pulp is not exposed, 367.
- arsenic, destroying with, 365.
- application of arsenic, 365.
- prevention of pressure, 366.
- sealing with gutta-percha, 366.
- calcification of, in cases of abrasion, 216.
- canals, cleaning, 380.
- canals, dressing in, after removal of pulp, 377, 382.
- canals, lateral openings in, 376.
- canals, location of, in molar teeth, 372.
- chamber, opening of, preparatory to removal of, 368.
- in bicuspids and molars, 370, 379.
- in incisors and cuspids, 370, 378.
- in mesial cavities in molars, 370.
- in occlusal cavities in molars, 369.
- in sound teeth, 48, 377.
- means of studying forms of, 104.
- variations in forms of, 376.
- cleaning canals, 380.
- cleaning infected canals, 380.
- cocain, anesthetizing with, 366.
- cases in which pulp is exposed, 366.
- cases in which pulp is not exposed, 367.
- danger of death of, from thermal changes, in proximo-incisal fillings, 196.
- destroying with arsenic, 365.
- application of arsenic, 365.
- prevention of pressure, 366.
- sealing with gutta-percha, 366.
- dressing in canals after removal of pulp, 377, 382.
- enlarging canals with drill, 48.
- exposure of, 363.
- accidental exposure of horns of, 103.
- by abrasion, 217.
- by gingival third decay, 205.
- carious dentin, method of removing in, 364.
- conditions that may present, 363.
- danger of, in excavating proximo-occlusal cavities, 158.
- method of removing carious dentin in, 114, 364.
- gutta-percha in sealing treatments, 366.
- horns of, accidental exposures of, 103.
- horns of, recessional lines of, in relation to cavity preparation, 102, 104, 157.
- infected canals, cleaning, 380.
- lateral openings in root canals, 376.
- location of canals in molar teeth, 372.
- loss of vitality of teeth with abrasion, 216.
- pressure, prevention of, in sealing treatments, 366.
- removal of, 371.
- barbed broach for, 371, 381.
- location of canals in molar teeth, 372.
- smooth broach for, 372, 381.
- root canals, cleaning, 380.
- dressing in, after removal of pulp, 377, 382.
- enlarging with drill, 48.
- filling, 382.
- location of, in molar teeth, 372.
- rubber dam for treatments, 364, 377, 381.
- saliva, protection of root canals against entrance of, 377.

- Pulp, dental (continued).
 sealing treatments with gutta-percha, 357, 361, 366.
 no discoloration of teeth, 361.
 sterilization of broaches, 371, 381.
 thermal changes, danger of death of pulp from, in proximo-incisal fillings, 196.
 variations in forms of pulp chambers, 376.
- Pulpal horns, recessional lines of, 102.
 in relation to cavity preparation, 104, 157.
- Pulpal wall, rule for naming, 6.
- Quadrangle pluggers, special uses of, 254, 256.
- Quill as non-conductor in proximal cavities, 187.
- Reading instrument points, 39.
- Recession of gums, in connection with gingival third decays, 210.
- Recessional lines of crests of pulps, 103.
- Recessional lines of pulp horns, 102.
 in relation to cavity preparation, 104, 157.
- Recurrence of decay at angles of proximal fillings, 186.
- Removal of carious dentin in exposing pulp, 364.
- Removal of dental pulp, see Pulp.
- Removal of ligatures and rubber dam, 73, 92.
- Removal of remaining carious dentin, in cavity preparation, 114.
 in cases in which pulp exposure is required, 114.
 in deep oclusal cavities in molars, 131.
 in gingival third cavity in buccal surface of molar, 202.
 in labial surface of incisor, 209.
 in large pit cavity in upper first molar, 127.
 in mesial cavity in upper central incisor, 183.
 in mesio-occlusal cavity in lower second molar, 167.
 in upper first molar, 153, 161.
 in small pit cavity in upper first molar, 123.
- Resistance form, in cavity preparation, 112.
 in deep oclusal cavities in molars, 132.
 in distal cavities in upper second molars, 155.
 in gingival third cavity in buccal surface of molar, 202.
 in labial surface of incisor, 208.
 in large pit cavity in upper first molar, 126.
 in mesial cavity in upper central incisor, 182.
 in upper third molars, 155.
 in mesio-occlusal cavity in lower second molar, 168.
- in mesio-occlusal cavity in upper first molar, 152, 161, 162.
 in small pit cavity in upper first molar, 123.
 relation to force used in chewing foods, 245.
- Rests for fingers in operating, 60.
- Retention form, in cavity preparation, 113.
 in deep oclusal cavities in molars, 132.
 in gingival third cavity in buccal surface of molar, 202.
 in labial surface of incisor, 208.
 in large pit cavity in upper first molar, 126.
 in mesial cavity in upper central incisor, 182.
 in upper third molars, 155.
 in mesio-incisal cavities, 192.
 in mesio-occlusal cavity in lower second molar, 168.
 in upper first molar, 152, 161, 162.
 in small pit cavity in upper first molar, 123.
 oclusal step in proximal cavities in bicuspsids and molars, 143.
- Reverse quadrangle pluggers, special uses of, 254, 256.
- Right side behind finger position for lower teeth, 63.
 for upper teeth, 62.
- Right side behind position at the chair, 58, 59.
- Right side in front finger position for lower teeth, 61.
 for upper teeth, 61.
- Right side in front position at chair, 58, 59.
- Rights and lefts, direct-cutting instruments, 31.
 lateral cutting instruments, 31.
- Root canals, filling, 382.
 apical foramen, determining size of, 382.
 canals with large apical foramen, 384.
 chloro-percha for, 384.
 to prevent evaporation of chloroform from, 384.
 cleaning and treatment, see Pulp.
 enlarging canals with drill, 48.
 foramen, apical, determining size of, 382.
 gutta-percha for, 383.
 horns of pulp chambers, 385.
 length of root, determining, 383.
 location of canals in molar teeth, 372.
 root, determining length of, 383.
 small canals, 383, 384.
 treatment, see Pulp.
- Root clamps for rubber dam, 89, 91.
- Round burs, uses of, 45.
- Round plugger point in condensing central portion of filling, 272.
 special uses of, 254, 255.

- Rubber dam, 69.
 adjusting over bow of clamp before placing clamp on tooth, 85.
 aids in adjusting, 79.
 clamps, 80.
 ligature, 79, 85, 86.
 matrix, 91.
 applying over special clamp, 83.
 buccal cavities, clamps for, 90.
 clamps, as aid in adjusting, 80.
 bicuspid, 89.
 for buccal cavities, 90.
 Hatch, 90.
 molar, 89.
 placing after placing dam, 81.
 root, 89, 91.
 special, 83, 89, 90.
 tooth on which to place, 89.
 cutting holes in, 70.
 extensive gingival third cavity, preliminary preparation for placing, 203.
 grasps, 73.
 tabulation of, 73.
 Hatch clamp for buccal and labial cavities, 90.
 application of, 90.
 holes in, position of, 70.
 instrument for holding, in difficult cases, 91.
 ligature as aid in adjusting, 79, 85, 86.
 removal of, 73, 92.
 tying under a clamp, 82.
 matrix as aid in adjusting, 91.
 molar and bicuspid clamps, 89.
 placing clamp after placing rubber, 81.
 preparation for placing, 69, 73.
 preparing the, 70.
 pulp treatments, 364, 377, 381.
 removal of, 73, 92.
 root clamps, 89, 91.
 special clamps, 83, 89, 90.
 teeth on which to place, 89.
 teeth which should be included, 72.
 tying a ligature under a clamp, 82.
 water, use of, before placing and after removing, 51.
 Rubber for separating teeth, 262.
 Rule for cutting cavity margin when a groove is approached, 101.
 Rule for finding actual pounds or kilograms delivered by blows, 244.
 Rule for forming contra-angles, 22.
 Rule for naming axial wall, 7.
 angles of cavities, 9.
 cavities, 2.
 complex cavities, 7.
 line angles, 9.
 point angles, 9.
 pulpal wall, 6.
 sub-pulpal wall, 6.
 surrounding walls, 6.
 Rule regarding moisture on cavity walls, 116.
 Rule regarding protection of root canals against entrance of saliva, 377.
 Saws in finishing gold fillings, 293.
 Sealing treatments with gutta-percha, 357, 361, 366.
 no discoloration of teeth, 361.
 Second grasp in applying the rubber dam, 73, 76.
 Secondary dentin built in pulp chamber as result of abrasion, 216.
 Selection of cases for inlays, 331.
 Senile decay of the teeth, 210.
 definition, 210.
 treatment, 211.
 Sensitiveness of gingival third cavities, 206.
 Sensitiveness of teeth as result of abrasion, 216.
 disappearance of, 216.
 Separating teeth, 259.
 cotton for, 262.
 extension for prevention limited by, 144.
 for amalgam, 326, 328.
 for finishing proximal gold fillings, 292.
 for inlays in proximal surfaces of incisors and cuspids, 338, 339.
 gutta-percha for, 262, 263.
 in combination with Perry separator, 263.
 necessary for health of interproximal gingivæ and periodontal membranes, 259.
 Perry separator, 259.
 adjustment of, 260.
 gutta-percha in combination with, 263.
 long bars for, 263.
 objections to, 261.
 rubber for, 262.
 when necks of teeth have dropped together, 263.
 when tooth has lost greater part of its crown and teeth on either side have dropped together over it, 263.
 wooden wedges for, 262, 263.
 Setting inlays, 350.
 Shank of instruments, definition, 17.
 Sharpening instruments, 33.
 Short set of cutting instruments, 28.
 Shrinkage and expansion of amalgam, see Amalgam.
 of cements, 355, 356.
 Side instruments, forms and uses, 42.
 Silver-tin alloys, see Amalgam.
 Single plane instruments, 31.
 Smooth-surface cavities, see Gingival third cavities. Proximal cavities in bicuspids and molars, Proximal cavities in incisors and cuspids.
 brief review of injuries by caries in relation to cavity preparation, 107, 140.
 positions of occurrence, 5.

- Smooth-surface cavities (continued).
 preparation of, 140.
 tendency to spread on surface more in direction of axial angles than occlusally or gingivally, 107.
- Specials, cutting instruments, forms and uses, 40.
- Special rubber dam clamps, 83, 89.
- Special uses of plugger points, 254.
- Specific gravity, 232.
 of gold, 232, 233.
- Specific gravity and resistance to crushing stress of pure gold in varying physical conditions and in fillings, 232.
- Spheroiding of amalgam, 317.
- Spoons, definition, 20.
 forms and uses, 41, 42.
 sharpening, 37.
- Square knot, 88.
- Squaring out angles with bur, 46.
- Starting points for cohesive gold, making with bur, 47, 152.
 making with chisel, 153.
- Step, occlusal, in proximal cavities in bicuspids and molars, 143.
- Stepping of plugger point in condensing gold, 266.
- Sterilization of broaches, 371, 381.
- Straight chisels, definition, 20.
 forms and uses, 41, 42.
 sharpening, 36.
- Straight enamel, 94.
- Strength of amalgam under control of manipulation, 316.
- Strength of the bite, 245.
- Strength required in fillings, 245.
 different in different positions, 237.
- Structure of enamel in relation to cavity preparation, 93.
- Structure of teeth, changes in, as result of abrasion, 216.
- Sub-class names of instruments, 19, 20.
- Sub-order names of instruments, 18.
- Sub-pulpal wall, rule for naming, 6.
- Surgeon's knot, 85, 87.
- Surrounding walls of cavities, rule for naming, 6.
- Susceptibility, area of greatest, in buccal surfaces, 109.
 cases of intense, in young women and young mothers, 206.
 line of greatest, near free border of gum, 108.
 systemic, to dental caries, 110.
- Systemic susceptibility and immunity to dental caries, 110.
- Tabulated instrumentation for preparation of cavities by classes, 118, 119.
- Tabulation of rubber dam grasps, 73.
- Taft, J., re amalgam, 300.
- Taggart, W. H., re gold inlays, 352.
- Teeth which should be included in the rubber dam, 72.
- Thermal changes, danger of death of pulp from, in proximo-incisal fillings, 196.
- Third grasp in applying the rubber dam, 73, 77.
- Time, effect of, on cut alloys, 308.
- Tin, as a filling material, 224.
- Toilet of cavity, 115.
 if a fixed oil has been used, 128.
 if a leak in rubber dam has occurred, 129.
 if cavity is dry and freshly cut, 128.
 in cases in which cavity has been prepared and filling delayed until another sitting, 129.
 in deep occlusal cavities in molars, 133.
 in large pit cavity in upper first molar, 128.
 in mesio-occlusal cavity in upper first molar, 154.
- Tomes, Charles, re amalgam, 302, 304, 305.
- Tomes, John, re amalgam, 301, 305, 306.
- Training to develop finger power, 54.
- Translucence of teeth and of porcelain inlays, 347.
- Trimming amalgam fillings, 327.
- Triple-angle contra-angle, definition, 21.
- University set of cutting instruments, 28.
- Vernier, use of, on Boley gauge, 25.
- Walls of cavities, rules for naming, 6.
- Walls that approach crests of marginal ridges, preparation of, 136.
- Water, uses of, in dental practice, 49.
- Weak cusp, preparation for porcelain inlays, 336.
- Weak walls in bicuspids and molars, see Management of weak walls.
- Wear, interproximal, 211.
 results of, 212.
- Wear of incisal edges, preparation of cavities in cases in which dentin is exposed, 196.
- Wear of teeth by use, see Abrasion.
- Wedelstaedt, E. K., re steel tubes for testing amalgam fillings, 306.
- Wedging principle in packing gold, 266.
 to attain best results by, 267.
- Welding properties of gold, 227.
 experiments re, 228.
 to keep gold so that welding property will be fully developed when annealed, 229.
- White spots in the enamel, 101.
- Wholesale building up of abraded teeth not recommended, 219, 223.
- Witzel, Adolph, re amalgam, 303, 313, 315.
- Wooden wedges for separating teeth, 262, 263.
- Working properties of alloy, changes in, with time, 311.
- Wringing out mercury from amalgam, effect of, 318.



THE LIBRARY
UNIVERSITY OF CALIFORNIA
Santa Barbara

THIS BOOK IS DUE ON THE LAST DATE
STAMPED BELOW.

Series 9482



3 1205 00689 1277

D 000 717 207 5

