

A PRACTICAL TREATISE
ON
BRIDGE-CONSTRUCTION.

By **W. J. MACQUORN RANKINE, C.E., LL.D., F.R.S.**,
Late Regius Professor of Civil Engineering in the University of Glasgow.

In Crown 8vo, cloth, with Numerous Tables and Diagrams.

- I. APPLIED MECHANICS. *Eleventh Edition.* 12s. 6d.
- II. CIVIL ENGINEERING. *Sixteenth Edition.* 16s.
- III. THE STEAM ENGINE. *Eleventh Edition.* 12s. 6d.
- IV. MACHINERY AND MILL-WORK. *Fifth Edition.* 12s. 6d.
- V. USEFUL RULES AND TABLES. *Sixth Edition.* 10s. 6d.
- VI. A MECHANICAL TEXT-BOOK. *Third Edition.* 9s.
- VII. PROFESSOR RANKINE'S MISCELLANEOUS SCIENTIFIC PAPERS.
With Memoir by Professor TAIT, M.A., and Fine Portrait on Steel.
Royal 8vo, handsome cloth, 31s. 6d.

Medium 8vo, with 43 Lithographic Plates and Numerous other Illustrations, 25s.

HYDRAULIC POWER AND HYDRAULIC MACHINERY,

FOR THE USE OF PRACTICAL ENGINEERS AND STUDENTS.

By **H. ROBINSON, M. INST. C.E.**,

Professor of Surveying and Civil Engineering, King's College, London.

Royal 8vo, with Numerous Tables and Diagrams, 25s.

THE STABILITY OF SHIPS:

A TREATISE FOR THE USE OF NAVAL CONSTRUCTORS, BUILDERS, AND
OTHERS.

By **Sir E. J. REED, K.C.B., F.R.S., M.P.**

Sixth Edition, 18s.

MARINE ENGINEERING:

THE DESIGNING, CONSTRUCTION, AND WORKING OF MARINE MACHINERY.

By **A. E. SEATON, M.I.N.A.**,

Lecturer, Royal Naval College, Greenwich, &c.

With Numerous Tables and Illustrations reduced from Working Drawings.

Medium 8vo, with Numerous Illustrations and Two Folding Plates, 36s.

ELEMENTS OF METALLURGY:

A PRACTICAL TREATISE ON THE ART OF EXTRACTING METALS
FROM THEIR ORES.

By **J. ARTHUR PHILLIPS, C.E., F.C.S., F.G.S.**,

Ancien Elève de l'École des Mines, Paris.

Re-Written and Edited by the Author, and by **H. BAUERMAN, F.G.S.**

"The value of this work is almost inestimable."—*Mining Journal.*

LONDON: CHARLES GRIFFIN & CO., EXETER STREET, STRAND.

A PRACTICAL TREATISE
ON
BRIDGE-CONSTRUCTION:

BEING A
TEXT-BOOK
ON THE
DESIGN AND CONSTRUCTION OF BRIDGES IN
IRON AND STEEL.

FOR THE USE OF STUDENTS, DRAUGHTSMEN, AND ENGINEERS.

BY
T. CLAXTON FIDLER, M. INST. C. E.

With Numerous Illustrations and Lithographic Plates.

LONDON:
CHARLES GRIFFIN AND COMPANY,
EXETER STREET, STRAND.

1887.

[*All rights reserved.*]

Ballantyne Press
BALLANTYNE, HANSON AND CO.
EDINBURGH AND LONDON

22482

624946

SP

• F44

P R E F A C E .



WITHIN the last few years, the art of bridge-construction has undergone many important changes. Engineers have been called upon to construct bridges of unprecedented magnitude, whose design and execution have presented a number of new problems, or have invested old ones with an importance which they did not before possess. At the same time, new points of interest have arisen in connection with the introduction of steel, the adoption of new forms of construction, and the employment of new methods of research ; while the constant accumulation of experimental facts has, in the meantime, added largely to our stock of practical knowledge in regard to such subjects as the strength of materials and the effects of wind-pressure.

The object of this book is to describe the modern practice of Bridge-construction, and to set forth in the simplest language the mechanical principles and experimental facts on which it is based.

The design and arrangement of the work have been dictated by a desire to render it as useful as possible, not only to engineers or draughtsmen who may be engaged in the work of bridge-calculations and bridge-construction, but also to students. With this object, the earlier chapters of the work are devoted to a simple demonstration of those mechanical principles which must of necessity form the beginning of any study of the subject ; and which are more fully developed and applied in later portions of the book. As the result of practical experience, I have found many advantages in employing a *geometrical* method of investigation ; and I have here applied it—not as a mere translation from the language of algebra, but as a parallel and independent method

TO
N
C
T

22482

which is capable in itself of affording positive demonstrations, and of yielding direct solutions for most of the problems that arise in bridge-construction.

The First Part of the work contains a detailed application of this method to the graphic determination of those bending-stresses which take effect in all bridges; and this method of treatment leads to a consequent classification of bridges, which is the subject first treated in the Second Section.

In the next following chapters, the geometric method is applied, first to the calculation of the weight of bridges, and then to the construction of a graphic theory of deflection, by which the curve of the bended girder is geometrically traced. This construction of the deflection curve is then employed as the basis of a graphic theory of continuous girders, and afterwards as the foundation of a graphic theory of columns, which is treated at length in Chapter X.

This brings us to the Third Section of the work, which is devoted to the practical question of the Strength of Materials, and its application to the design and construction of tension members and compression members.

The theoretical strength of columns, in cast iron, wrought iron, and steel, having been compared with the results of known experiments (including the most recent tests), the next chapter treats of the application of these results to the actual design of struts; and takes into consideration, not only the liability to flexure in struts of small diameter, but also those practical conditions which limit the diameter of the strut or the thickness of the constituent plates or members.

Here I have endeavoured to supply a want which has long been felt by practical men; and instead of calculating the *strength* of a strut from its assumed radius of gyration (which cannot be ascertained beforehand), I have given for each of the most common forms of cross-section, the required sectional area of the strut for given loads and given lengths. These results are presented in tables and diagrams, which in addition to their more immediate purpose, afford also the means of estimating the weights and the relative economy of rolled sections, built sections, and braced

struts ; so that the student can appreciate at a glance the conditions which render it advantageous or otherwise to employ secondary bracing.

The strength of tension members, and their practical construction, are treated in Chapter XII., which contains a great number of recent experimental data in regard to the employment of steel, and the strength and proportions of steel rivetted joints, as well as other forms of connection.

The practical application of all such experimental data, however, depends upon the view that may be taken of the *working* strength of iron and steel, and the proper working stress in bridges. On this fundamental question a great deal has been said of late years, and some advance has certainly been made towards its determination upon a reasonable basis. Whatever may be thought of the somewhat conflicting theories which have been advanced by German and other writers, it is certain that the subject demands the attention of all bridge engineers ; and there can be little doubt that the rules which have hitherto governed the practice of bridge-construction must receive some important modification in this direction. The subject is discussed at some length in Chapter XIII. from a purely practical point of view. A complete solution of the question cannot be expected until some definite conclusions shall have been reached in regard to the intrinsic nature of that change which is known as the "fatigue" of metals ; and the objects aimed at are chiefly to set in order the facts and principles affecting the question, and to deduce such reasonable and safe rules as may serve for present purposes.

The facts, rules, and principles which have thus far been collated and exhibited, are applied in the Fourth Part to the practical work of designing bridges of various types of construction ; and in every case the calculations are so arranged and tabulated that the required sectional areas of the various members can be readily determined by the old rule, or by *either* of the newer methods for fixing the working stress.

The various types of parallel girder are considered in Chapters XXI. and XXII., together with a direct method of calculating their weight as part of the dead load ; while the ensuing chapters

deal in a similar manner with bowstring girders, bow-and-chain bridges, arched ribs, suspension bridges, and cantilever bridges.

The concluding chapter of the work is devoted to the question of wind-pressure,—a subject whose importance has only recently been fully realised. It is well known that, on this question, further experiments are urgently needed, and it is to be hoped that they will in time be forthcoming; but in the meantime engineers are obliged to carry on their work with such materials as they possess, and the most that can be done is to take the experimental facts that have been actually ascertained, and to study their real bearing upon the questions at issue.

Throughout the work, I have of course consulted on all occasions the most recent experiments and deductions, and have endeavoured, to the best of my knowledge, to mention in their proper places the authors of recent discoveries or improvements, and to refer to scientific papers which have furnished sources of information.

T. C. F.

WESTMINSTER, *October* 1887.

CONTENTS.



INTRODUCTION	PAGE 1
------------------------	-----------

PART I.—ELEMENTARY STATICS.

CHAPTER I.

DEFINITIONS.

ART.		
1.	Force	6
2.	Balanced forces	8
3.	Equilibrium of structures	8
4.	Strain	9
5.	Stress	9
6.	Elasticity	9
7.	Measurement of strain and stress	10
8.	Strength	11

CHAPTER II.

ON THE OPPOSITION AND BALANCE OF FORCES.

9.	Measurement and graphic representation of forces	13
10.	Direct opposition of forces	13
11.	Moment of a force about an axis—forces compared by the common scale-beam	13
12.	Inclined forces compared by means of a bent lever or a single-armed lever	14
13.	Theorem of the parallelogram of forces	16
14.	Resolution of inclined forces into their vertical and horizontal components	18
15.	Moment of distributed forces—moment of an area—position of the centre of gravity	19

CHAPTER III.

ON BENDING STRAIN.

ART.	PAGE
16. Transverse bending of the simple beam	22
17. Straining of the different fibres, and their relative stresses—neutral axis—moment of resistance—theoretic stress in the extreme fibre	22
18. Results of theory inconsistent with experiment—explanations attempted—failure of the theory of lateral adhesion	26
19. Girder of I. section—moment of resistance represented by a solid cut from the girder—radius of gyration and moment of inertia—discrepancy between theory and experiment diminishes with the thickness of web	27
20. Thin-webbed girder—flange-stress determined by the method of moments—vertical shearing force	30
21. Uses of the diagram of moments, or diagram of stress—varying value of the flange-stress—flange-stress produced entirely by resistance to the horizontal shearing force or “lateral adhesion”	32
22. Equilibrium of the web-plate—vertical and horizontal shearing forces—diagonal stress and strain	34
23. Shearing force in the solid beam—its distribution as compared with that which takes place in a plate web	36
24. Conclusion	37

CHAPTER IV.

THE GRAPHIC REPRESENTATION OF BENDING MOMENTS.

25. The diagram of moments—purposes to which it may be applied—distributions of load to be considered	38
26. Diagram of moments for a single force—cantilever loaded at the end—meaning of the diagram	39
27. Graphic summation of the moments of two or more parallel forces—cantilever loaded with several weights—determination of the centre of gravity by means of the diagram	40
28. Moment of a uniformly distributed load—parabolic diagram of moments	41
29. Diagram for any irregular distribution of load	43
30. Graphic summation of the moments of contrary forces—balanced cantilever	44
31. Beam supported at each end, and loaded with a single weight	45
32. Diagrams for different positions of the weight—beam under a rolling weight	46
33. Beam loaded with several weights	47
34. Beam supported at both ends, and uniformly loaded—uniform load divided into panels—polygonal diagram of moments	48
35. Effect of dividing the span into panels	50

ART.	PAGE
36. Beam loaded with a single weight, and strained over one pier	52
37. Beam loaded with a single weight, and strained over both piers	54
38. Beam uniformly loaded, and strained over one pier	55
39. Beam uniformly loaded, and strained over both piers	57

PART II.—THE GENERAL PRINCIPLES OF BRIDGE-CONSTRUCTION.

CHAPTER V.

THE COMPARATIVE ANATOMY OF BRIDGES.

40. The bridge considered as a means to an end—the common duty of resisting the “bending moment”—bridges classified according to their manner of performing this duty for the uniform load	59
41. The family of girders—two principal groups—girders of uniform depth—girders of uniform horizontal stress—stereographic illustration	60
42. Division A. First group—parallel girders—the diagram of moments forms the stress diagram—detached spans—cantilever bridges—cantilever and girder bridges	61
43. Second group—parabolic girders—the diagram of moments forms a diagram of depth—bowstrings—parabolic cantilevers—parabolic cantilever and bowstring bridges	63
44. The shearing force—resisted by the web in girders of the first group—resisted by the flanges in girders of the second group	64
45. Third group—arches—the curve of moments forms the curve of the equilibrated arch—the linear arch derived from each type of girder in the second group	65
46. Division B. Inverted forms of bridge-construction—inversion of the diagram for parallel girders	67
47. Second group. Inverted bowstrings—inverted parabolic cantilevers—inverted cantilever and bowstring bridges	68
48. Third group. Suspension bridges—curve of moments represents the curve of the equilibrated chain	68
49. Division C. Panel bridges—first group—polygonal diagram of stress for parallel girders—second group—polygonal trusses—third group—polygonal arches	69
50. Division D. Panel bridges inverted—second group—inverted polygonal trusses—third group—straight-link suspension bridges	71
51. General remarks—the “sickle” girder—the bow-and-chain or “Salt-ash” girder—forms of girder intermediate between the first and second groups	71

CHAPTER VI.

COMPARATIVE ANATOMY, ETC. (*continued*)—COMBINED OR COMPOSITE BRIDGES.

ART.	PAGE
52. Composite structures and combined structures	74
53. Series of triangles—the Bollman truss	74
54. Series of trapezoids—the composite trapezoidal truss—the stresses compared with those of the “Bollman” system	76
55. Straight-link suspension bridges derived from the “Bollman” and the trapezoidal systems—their stresses compared	77
56. Triangles within triangles—the “Fink” truss—primary, secondary, and tertiary systems	77
57. Inversion of the secondary system	79
58. Trapezoids within trapezoids—the “Pratt” or the “Linville” truss and the “Warren” girder—parallel girders considered as composite structures	79
59. Parallel girder, “Linville” type, even number of bays	80
60. Parallel girder, “Linville” type, odd number of bays—combination of systems, double bracing—Linville truss terminated by inclined struts	82
61. Warren girder	85
62. Double Warren, or single lattice girder	87
63. General value of the mean stress in the flanges of parallel girders—compared with the stress in the boom of the “Bollman” and “Fink” trusses	89
64. Girders considered as single or as composite structures—English and American practice	89

CHAPTER VII.

THE THEORETICAL WEIGHT OF BRIDGES.

65. Purposes for which an estimate of the weight of metal is required—economy of construction—weight of metal necessary for carrying the dead load	91
66. Uniform intensity of working-stress—diagram of stress used as a diagram of metal	91
67. Weight of metal in terms of stress—sources of waste—expression for practical weight of a bar under unit stress	92
68. Stress and weight of an inclined bar in terms of the vertical and horizontal components	93
69. Example of the general method of summing the weights of the different members	94
70. General law—theoretic weight of all the struts equal to the theoretic weight of all the ties—corrections required in special cases	95
71. General expression for the mass of metal required in each class of bridge, for the support of the uniform load	97

ART.	PAGE
72. Metal in flanges of all parallel girders	97
73. Metal in Pratt or Linville girders	98
74. Metal in Warren girders	98
75. Metal in lattice girder	99
76. Metal in the "Fink" truss	99
77. Metal in the "Bollman" truss	99
78. Metal in trapezoidal truss, and straight link suspension or cantilever bridges	100
79. Metal in parabolic bowstrings, linear arches and suspension bridges	101
80. General remarks—application of the tables—modifications required for the rolling load	102
81. Example of the use of tables	103
81A. Broad view of the relative economy of girders, arches, and suspension bridges	112

CHAPTER VIII.

ON DEFLECTION, OR THE CURVE OF A BENDED GIRDER.

82. Uses and abuses of the calculated deflection of girders—deflection no test of strength	113
83. Deflection of parallel girders—general law—the curve of the bended girder is the curve of moments for an imaginary load whose intensity is proportional to the actual intensity of flange-stress	114
84. Deflection of girder under uniform working-stress	117
85. Deflection of beams or girders of uniform section	119
86. Deflection-curve for cantilever loaded at the end	119
87. Deflection-curve for cantilever under a uniform load	121
88. Deflection-curve for balanced cantilever	121
89. Deflection of balanced cantilever under the uniform load—horizontal deflection of cantilever bridge under wind-pressure	124
90. Deflection-curve for girder loaded in the middle	125
91. Deflection-curve for girder uniformly loaded	127
92. Deflection-curve for girder uniformly loaded and strained over one pier	128
93. Deflection-curve for girder uniformly loaded and strained over both piers	129
94. Deflection-curve for beam of uniform section—small value of the shearing distortion—recent experiments of Professor Kennedy	131
95. Deflection-curve for a girder with varying section of flange—method exemplified in the case of a swing-bridge	132
96. Adjustment of initial camber	132

CHAPTER IX.

CONTINUOUS GIRDERS.

97. Nature of the problem—external forces unknown—solution depends upon the flexibility of the girder—conditions of the problem illustrated	134
---	-----

ART.	PAGE
98. Measurement of deflection by means of the stress-diagram—employment of a movable datum-line for this purpose	137
99. Geometric measurement of the "slope" by means of a pair of "characteristic points" in the stress-diagram	138
100. Continuous girder of any number of equal spans—graphic solution of the stresses	139
101. Continuous girder of unequal spans—graphic solution of the stresses	141
102. Effect of irregular loading upon any span	143
103. Effect of settlement in the piers	144
104. Designed variation in the level of supports	147
105. Expansion and contraction of iron piers due to changes of temperature—resulting changes of stress in a continuous girder	147
106. Solution of the general problem by direct geometrical construction of the diagram of moments	148
107. Continuous girders with varying sectional area of flange	151

PART III.—THE STRENGTH OF MATERIALS.

CHAPTER X.

THE THEORETICAL STRENGTH OF COLUMNS.

108. Definition of "ultimate strength" and "failure"—different appearances of failure by crushing, upsetting, bulging, or buckling	153
109. Flexure of long columns illustrated—two principal cases to be distinguished	154
110. Flexure and equilibrium of the "ideal column"	154
111. Approximate value of the equilibrated load	156
112. Curve of the elastic column—exact determination of the equilibrated load	156
113. Theoretic deflection of the "ideal column"	157
114. Theoretic strength of the "ideal column"	160
115. The practical deflection of columns—effect of initial curvature or permanent set—effect of unequal elasticity—the cause of deflection in a perfectly straight column—graphic illustration of the deflection as depending on the load in the case of the practical column	161
116. The practical strength of columns—stress due to bending moment—relation between the apparent direct stress and the maximum local stress on the concave side—strength of columns as limited by the ultimate strength of material—strength not to be defined by a hard and fast line, but by an area, and dependent upon unknown variations of modulus	166
117. Observed variations in the elasticity of iron and steel—value of ϕ for columns of any section	167
118. Wrought-iron columns—modulus of elasticity—diagram for strength of ideal column—variations of modulus—diagram for lower limit of strength in practical columns—results of experiment	169

ART.	PAGE
119. Columns with fixed ends—effective length for flexure	170
120. Cast-iron columns—crushing strength—diagram for failure by crushing—tensile strength—diagram for failure by tension	171
121. Steel columns—variations of strength in different qualities of steel—diagrams for mild and hard steel of certain qualities	173
122. Tables of the lower limit, or the reliable strength of columns, in cast-iron, wrought iron and steel, as deduced by theory	174
123. Mr. Hodgkinson's rules for cast iron	175
124. Gordon's rules, and other proposed formulæ	176
125. Summary of results for cast iron	177
126. Summary of results for wrought iron	178
127. Steel columns—Mr. Christie's experiments	179

CHAPTER XI.

THE DESIGN AND CONSTRUCTION OF STRUTS.

128. Safe working load—Government regulations—modification for long columns, and for variations or alternations of stress—factor of safety assumed provisionally	181
129. Short compression members—working load and required sectional area	182
130. Long struts liable to buckling—the safe working-stress can be found when all the dimensions have been determined, but is wanted beforehand in order to determine cross section	183
131. Process of designing a strut—diameter depends upon sectional area and upon a third dimension which is limited by practical requirements	183
132. The third dimension—coefficient ζ —application of Rankine's formula to determine the sectional area directly in terms of the load and the length	184
133. Table of formulæ for moment of inertia, radius of gyration, and coefficient ζ	185
134. Wrought-iron struts—general formula for sectional area	187
135. Solid square or rectangular bars—example	187
136. Struts of L section	190
137. Struts of \perp and $+$ section	190
138. Struts composed of two tees rivetted back to back	192
139. Struts of H section	192
140. Struts of channel or double-channel section	193
141. American Bridge Company's columns	196
142. American box-section—limit to the thinness of the sides	197
143. Hollow cylindrical struts—Hodgkinson's experiments—"Phoenix" columns—large tubular members	201
144. Braced struts constructed as lattice girders—direct and shearing stresses—secondary flexure—secondary bracing	203
145. Strut liable to lateral forces—when used as a stiffener—when constructed with hinged ends—allowance for stresses due to the weight of the strut, or to wind-pressure	207

ART.	PAGE
146. The practical weight of struts—waste metal in construction—comparative economy of different forms varies in different situations—diagram of the gross weight for different loads and lengths	208
147. The compression-flange of girders—ordinary forms of section—buckling tendency sometimes disregarded—conditions under which this becomes unsafe—examples of the collapse of bridges—inadequacy of the deflection test for the strength of bridges	209
148. Effective length for flexure—rivetted connections—transverse and longitudinal flexure of girder struts—pin connections—friction of joints—Mr. Christie's experiments with hinged struts—flexure of braced piers	210

CHAPTER XII.

THE STRENGTH AND CONSTRUCTION OF TIES.

149. Tensile strength—experimental results for wrought-iron and for steel	213
150. Tensile strength and ductility of wrought-iron bars and plates—Mr. Kircaldy's tests—values obtainable in ordinary practice	213
151. Tensile strength of iron wire	214
152. Tensile strength of cast iron	215
153. Tensile strength and ductility of steel—character of strong and of mild steel—toughness—work required to break a tie-bar—rules of the English and French Admiralties, of Lloyd's, and other authorities—uncertain behaviour of steel—experiments at Duisberg—general remarks	215
154. Working strength of iron and steel in tension—iron plates, eye-bars, iron wire cables—working strength of steel—Board of Trade rules—steel eye-bars	218
155. Joints and connections—eye-bars—plate-built members—other forms of connection—general observations in regard to economy in the arrangement of joints	220
156. Eye-bars and pin connections—arrangement of bars in a tension member	221
157. Proportions of eye-bars—diameter of pin—proportions of head, rules of Mr. Berkley and Sir C. Fox—American practice, Mr. Shaler Smith's results	222
158. Steel eye-bars—practice of Canadian engineers, and of the Edge Moor Iron Co.	226
159. Rivetted joints—object to be aimed at in their design—resistance of rivets and of plates	227
160. Shearing stress on the rivets—rivets in "single" and in "double shear"	227
161. Shearing strength of iron rivet—allowance for unequal distribution of load—table of rivet resistance	228
162. Shearing strength of steel rivets—table of rivet resistance—shearing strength affected by intensity of bearing pressure	229

ART.	PAGE
163. Strength of the plate across rivet-holes—ordinary practice in iron-work—greater caution required in dealing with steel—strength of the plate influenced by three or four specified sources of gain or loss	230
164. Injury caused by punching—Mr. Parker's results—injury avoided by drilling the holes, and remedied by annealing or rimering the holes after punching	231
165. Effect of perforation—gain of strength discovered by Professor Kennedy, its value for different widths of pitch—net loss or gain in the case of punched holes	232
166. Effect of unequal distribution of stress—pull of the rivets, their bearing pressure, and tendency to concentrate the stress—ascertained effects—probable effect in large joints	233
167. Working-stress on oblique line of fracture	234
168. Arrangement of rivetted joints—examples—construction of tension flange in girders	235
169. The practical weight of tension members—table of examples	236

CHAPTER XIII.

THE WORKING STRENGTH OF IRON AND STEEL, AND THE WORKING STRESS IN BRIDGES.

170. Present state of the question—inadequacy of a constant rule for all cases	238
171. Effects producible by the rolling load—"impact"—fluctuations of stress—centrifugal force or force of acceleration—dynamic action of a load suddenly applied—"fatigue"	239
172. Supposed causes of the effects observed in Fairbairn's and Wöhler's experiments	242
173. Wöhler's experiments—results for different cases of load-variation	242
174. Vibrations of an elastic body—stress produced by a load suddenly applied or suddenly varied—distinction between the internal stress and the external straining force or load	244
175. Comparison between the effects of dynamic action and the supposed effects of "fatigue"—objections to the dynamic theory in the case of an imperfectly elastic bar	247
176. Dynamic action beyond the elastic limit—ultimate destruction of the bar by repetitions of a load equal to half the static breaking load	249
177. Conclusions—dilemma, fatigue or no fatigue	253
178. Different methods of determining the working load—1st. the old rule of uniform working stress—2nd. two different values of the working stress—3d. two different values of the factor of safety—4th. Wöhler's facts applied by Launhardt and Weyrauch—5th. a separate allowance for fatigue and another for "impact" or dynamic action	254

ART.	PAGE
179. Alternative (dynamic) method of determining the required sectional area—dynamic theory—instantaneous changes of load—slow changes—intermediate cases—provisional estimate of a coefficient γ	257
180. The factor of safety—the real factor of safety secured by the old and by the new methods	260
181. Comparative results of the different methods—the old rule—See- fehlner's formula—Weyrauch's formula—the dynamic method— American practice—results graphically illustrated	260

PART IV.—THE DESIGN OF BRIDGES IN DETAIL.

CHAPTER XIV.

THE LOAD ON BRIDGES.

182. Composition of the load—dead and live load	263
183. The dead load—including weight of platform, wind-bracing, and main structure	263
184. Weight of materials—weight of platform in railway bridges	264
185. Live load upon public road bridges—distributed weight of a crowd of people—concentrated load of vehicles	265
186. Live load on railway bridges—weight of early engines and carrying stock—Mr. Stoney's table of live loads—heavy modern engines—Mr. Baker's data and table of weights	265
187. Distribution and incidence of the train-load—as regards the flanges of main-girders, the web-bracing or diagonals, the cross-girders, and intermediate girders—different methods of calculation—alternative methods adopted	268
188. Fluctuations in the weight of the rolling load—oscillation of bearing springs—causes of the observed fluctuations—conclusion as regards the load on the whole bridge, the stress in the lattice bars, and the load on the cross-girders	270
188A. Recent experiments upon the vibration of bridges, and their momentary deflection under a rolling load	271

CHAPTER XV.

CALCULATION OF STRESSES DUE TO THE MOVABLE LOAD.

189. General method of treatment applicable to all types of construction—conditions to be kept in view in making the calculations—order of proceeding	273
190. Tabulated analysis of the bending moments—example for the case of a girder of ten panels—maxima and minima	274

CHAPTER XVI.

PARALLEL GIRDERS.

ART.	PAGE
191. Different types of parallel girder—girders with a single system of bracing	279
192. Horizontal stress at each joint of the flanges—application to the dead and live load	279
193. Horizontal shearing stress in each panel of the web—tables for a girder of ten panels—maxima and minima	280
194. Exact method of finding the maximum shearing-stress	282
195. Practical maxima and minima—tables of horizontal and vertical stress in girders of four to sixteen panels	283
196. Girders braced with inclined struts and vertical ties	289
197. Girder braced with vertical posts and inclined ties—table of stresses—example	289
198. Girder with inclined ties and counterbraces—stress in counterbraces— —influence of initial adjustment and elastic strain	293
199. Girder with inclined terminal struts—table of stresses	294
200. Warren girder with vertical suspenders or vertical posts—tables of stress	295
201. Warren girder without verticals	296
202. Single lattice or double Warren girder—girder with vertical ties— example—behaviour of the ties in Charing Cross Bridge	298
203. Linville truss	301
204. Double lattice girder	303
205. Plate girder—general remarks	304

CHAPTER XVII.

PARALLEL GIRDERS (*continued*)—DIRECT CALCULATION OF THE WEIGHT OF METAL.

206. Usual method of computing the weight of girders by trial and error, to ascertain the total dead load	306
207. Theoretical and practical determination of the sectional areas of members—the old rule—arbitrary modifications—the Weyrauch method—Seefehlner's rule—the alternative "dynamic" method—examples of the area of tension members and compression members	306
208. Practical weight of girders—the unknown quantity determined by use of the "dynamic" method—tables of the weight of parallel girders of various types, as depending on the dead and live loads	310
209. Examples of the weight of parallel girders—application of the formula, and comparison with the actual weights of English, American, and Continental bridges of various spans	321
210. Limiting span	325

ART.	PAGE
211. Economy in details—example	326
212. Economy in choice of material—comparative advantages of wrought iron and steel in ties and in struts	326
213. Economy in design—different types of bracing—proportions of girder—conclusions in regard to the economic depth of parallel girders, and the reason of the economy attained in American practice	328

CHAPTER XVIII.

PARABOLIC GIRDERS, POLYGONAL TRUSSES, AND CURVED GIRDERS.

214. Different forms of parabolic girder—second group of bridge structures—common method of treatment	333
215. Horizontal stress in the flanges	333
216. Horizontal stress in the diagonals of the web—maxima and minima—tabulated results and exact formula for a uniform live load	334
217. Graphic method of determining the greatest stress in each member of any parabolic girder—the stresses scaled off from the general elevation—examples of upright and inverted bowstrings, and bow-and-chain bridges	336
218. Determination of the sectional areas—by the old rule and by newer methods—excess of area in stiffeners	340
219. The weight of parabolic girders—employment of the general formula—tables of the weight of upright bowstrings, inverted bowstrings, and of bow-and-chain bridges—example—relative economy of parabolic and parallel girders	343
220. Limiting span	346
221. Economic construction	347
222. Economic proportions—advantage of increased depth in the parabolic girder—depth limited in practice by considerations of wind-pressure	347
223. Curved girders—their stress and weight—the Kuilemburg girders compared with the Ohio Bridge—other forms of curved girder	348

CHAPTER XIX.

SUSPENSION BRIDGES AND ARCHES—FLEXIBLE CONSTRUCTION.

224. Curve of equilibrium—its coincidence with the curve of moments its changes under the passing load—stable equilibrium of the suspension bridge—unstable equilibrium of the arch	350
225. The common chain bridge—the parabolic and the catenary forms of chain—the horizontal stress in the chain	352
226. Determination of sectional areas	353
227. Weight of the chain bridge—table—general formula	353

ART.	PAGE
228. Changes of temperature—elongation of the chain—increased depression—motion of the saddles upon the towers	353
229. Limiting span of the chain bridge	354
230. Economic proportions—proportions adopted in practice—oscillations—general economic advantages of the chain bridge	355

CHAPTER XX.

SUSPENSION BRIDGES AND ARCHES—RIGID CONSTRUCTION.

231. Conditions to be fulfilled—rigidity to be obtained by the same means as those employed in girder bridges—and to be regarded as demanding the same conditions—different forms of rigid construction	357
232. Flexible arch or chain with a rigid roadway—continuous roadway girder hinged at the ends, its strain under changes of temperature	358
233. Roadway girder fixed at the ends—effects of a change of temperature in the girder or in the arched rib with fixed ends	359
234. Roadway girder hinged in the centre—temperature difficulties avoided—bending stress under an unequal distribution of the load—greatest bending moment—want of economy in the suspension bridge with stiffened roadway	359
235. Arched rib or suspension rib hinged at the centre—greater economy of the design—different forms of hinged rib—the parabolic form and its stress under an unequal load—its weight as compared with a parabolic girder	361
235A. Other forms of hinged rib—excentric position of the hinge	363

CHAPTER XXI

BOWSTRING GIRDERS USED AS ARCHES OR AS SUSPENSION BRIDGES.

236. Application of an exterior horizontal force—bowstring converted into an arch by relieving the stress in the lower chord	365
237. Series of relieved bowstrings—viaduct of several spans consisting of bowstring arches	365
238. Single span crossed by a suspended bowstring—stresses in the straight upper chord or boom—table of horizontal stress at each joint of a suspended bowstring of ten panels—maxima and minima	366
239. Changes of temperature—their effect upon the structure	368

CHAPTER XXII.

RIGID ARCHED RIBS OR SUSPENSION RIBS.

ART.	PAGE
240. Origin of the masonry arch and of the flexible suspension bridge—the defect of flexibility to be avoided in iron suspension bridges—construction of an inflexible bridge	370
241. Hinged rib of any arbitrary form—graphic method of determining the exterior forces	371
241A. Hinged rib having a parabolic curve as its neutral axis—graphic method of finding the bending moments, and the position of the load that produces the greatest bending moment	373
242. Maximum stress in the flanges of a hinged rib—graphic method of finding the stress in either flange, and the position of the load that produces the greatest stress—application of the method to parallel arched ribs, and to suspension ribs of parabolic form	375
243. Rigid suspension bridge with parabolic ribs—determination of the stresses by the previous method, general results—alternative determination—tabulated stresses—required sectional areas of the several members	377
244. Weight of the rigid suspension bridge—table of coefficients—examples of the calculation for wrought iron bridges of 500 and 1000 feet span—relative economy of the girder bridge and the rigid suspension bridge	379
245. Weight of rigid suspension bridge in steel—examples of the calculation for spans of 1500 to 3000 feet—general remarks	384
246. Deflection of the arched rib or rigid suspension bridge—their rigidity as compared with girder bridges	387
247. Limiting span and economic proportions	388

CHAPTER XXIII.

CONTINUOUS GIRDERS AND CANTILEVER BRIDGES.

248. Continuous girder bridges—calculation of the stresses—the points of contrary flexure determined by the elastic deflection	389
249. Mechanical adjustment of the points of contrary flexure—continuous girder of three spans hinged in the central span—alternative location of the hinges in the side spans	390
250. Cantilever bridge hinged in the side spans—bending moments—pier moments determined by the load on the side spans—motion of the points of contrary flexure in the central span—Kentucky bridge	391
251. Cantilever and girder bridge—central span hinged at two points—pier-moments determined by the load on central span—motion of the points of contrary flexure in the side spans—reversed bending stress	392

ART.	PAGE
252. Different forms of cantilever bridge—the St. John's River Bridge—the Niagara and Fraser River Bridges—the proposed Quebec Bridge—the Forth Bridge	394
253. Distribution of the weight and calculation of the stresses	396
254. Weight of the cantilever bridge—economic advantage obtained by the distribution of metal in the girder	397
255. Deflection of the cantilever bridge	399
256. Relative economy of different forms of bridge construction—influence of local conditions	400

CHAPTER XXIV.

ON WIND-PRESSURE AND WIND-BRACING.

257. Importance of calculating the stresses due to wind-pressure—the prevailing uncertainty as to its value and effects—division of the subject—different classes of experimental facts	402
258. Pressure and velocity of the wind—Smeaton's rule and its application	404
259. Pressure upon surfaces of different areas—ancient experiments—modern experiments at the Forth Bridge	404
260. Pressure upon curved surfaces—observations of De Borda and Didion—inferences therefrom	405
261. Pressure upon solid bodies—effect upon front and rear surfaces—results of Du Buat and Thibault for cubes and prisms—inferences to be drawn as to the wind-action upon tubular bridges, railway carriages, and buildings	406
262. Pressure of wind upon a grating	408
263. Pressure of the wind upon bodies sheltered by a grating	408
264. Pressure of the wind upon bodies partially sheltered—results obtained by Thibault at variance with recent experiments by Mr. Baker—probable explanation—mutual shelter afforded by the windward and leeward bodies	409
265. Dynamic effect of sudden gusts—augmented stress and augmented deflection—effect upon the indications recorded by dynamometers—dynamic stress recorded by wind-gauges	411
266. Observations of wind-pressure—measurements of velocity and of pressure—different classes of measurement reduced to one common standard—pressure required to overturn railway carriages—wind-pressure calculated by this means and compared with the records of wind-gauges—apparent disagreement reconciled	414
267. Existing rules and practice—earlier practice in England—present practice in America—recent recommendations of the Wind Committee of the Board of Trade	415
268. Calculation of the wind-stresses—members of the wind-girder—stresses in the web-members—wind-pressure considered as a rolling load—stress in the flanges due to a combination of load and wind	416
269. Conclusion	417

LIST OF PLATES.

PLATE							
A. COMPARATIVE ANATOMY OF BRIDGES	<i>to face page</i>		72
B. COMPARATIVE ANATOMY OF BRIDGES	"		72
C. COMPARATIVE ANATOMY OF BRIDGES	"		72
D. COMPARATIVE ANATOMY OF BRIDGES	"		72
E. COMBINED OR COMPOSITE BRIDGES	"		90
F. THE STRENGTH OF COLUMNS, IN CAST IRON, WROUGHT							
IRON, AND STEEL	"	180
G. THE PRACTICAL WEIGHT OF STRUTS	"	212
H. THE SAFE WORKING STRESS IN BRIDGES AS DETERMINED							
BY DIFFERENT METHODS	"	262
I. PARALLEL GIRDERS	"	304
J. PARABOLIC GIRDERS	"	348
K. ARCHES AND SUSPENSION BRIDGES	"	388
L. CANTILEVER BRIDGES	"	400

CONSTRUCTION OF BRIDGES.

INTRODUCTION.

LINES of communication are among the first necessities of civilisation, and it is therefore probable that the art of bridge-construction has, in some elementary form, been practised from the earliest ages.

Within historic times, the art has assumed a number of different forms, which appear to have been determined chiefly by the nature of the materials that have been available for its purposes. The beam, the suspension-bridge, and the arch, have long ago been developed as distinct types of construction, resulting naturally from the employment of timber, of flexible ropes, and of masonry, as materials of construction.

The greatest road-makers and bridge-builders of the old world were certainly the Romans, and the numerous remains of their bridges and aqueducts afford abundant evidence of the great practical skill evinced by these early architects in dealing with such materials as were at their disposal.

The permanent bridges of antiquity, as distinguished from boat-bridges, were for the most part built either of masonry or of timber.

In the former class of work, it is worthy of notice that the construction of semi-circular arches was so well understood by the Romans, that very little change has been made, since their time, in this particular form of bridge-construction. Indeed, if we take the Cabin John Bridge as illustrating the most recent American practice, we shall hardly find any feature of real structural importance by which this modern arch of masonry can be distinguished from the great bridges of the Emperor Trajan, some of which are still in existence.

The timber bridges of antiquity have of course disappeared; but if we may credit the description of the great bridge erected by the same Emperor across the Danube, and consisting of laminated timber arches, it must be admitted that, in this material also, the Romans were accustomed to the execution of works upon a scale that has hardly been surpassed at any later time.

But since the introduction of iron and steel, the art of bridge-con-

struction has attained proportions that were unknown to the ancients, and has moreover undergone an essential change in its character. It is, perhaps, not surprising that with these superior building materials engineers have succeeded in constructing spans of much greater width than any that had been previously attempted, and have thus carried their lines of communication across rivers and estuaries which could never be spanned by any bridge of stone or timber. These results, however, have not been accomplished by the mere substitution of one material in place of another; but they have been achieved by the adoption of new forms of construction, adapted to the capacities of the new materials, and conceived in accordance with the indications of Mechanical Theory.

It is true that, in one sense, the girders of the Forth Bridge and the arched rib of the Douro Viaduct may be regarded as the direct lineal descendants of the simple beam and the masonry arch; but the modern structures which have been developed from these primitive types are examples of a higher organisation. The essential functions of the structure, which may at first sight appear to be very simple, have been duly analysed into their component parts or elements; and these elementary functions have been allotted to separate members, each of which is specially adapted to the particular duty it has to perform. Thus the general course of progress has been from simplicity to complexity of structure, and from an unknown complexity to a defined simplicity of function.

This "development of species" has in fact proceeded by a course of "natural selection," and the variation from the parent type has been continually widening. At the first transition from an architecture of wood and stone, the ideas of designers were naturally moulded in the familiar forms of the older styles—the iron girder was merely an improved beam, and in some cases iron arches were built of radiating blocks or voussoirs, in close imitation of their masonry prototypes; and so long as experience or precedent was wholly relied upon, it is difficult to see how any other result could be expected. But more suitable forms of construction were gradually adopted as men began to perceive the inadequacy of past experience, and to apply in practice the carefully tested reasoning of Mechanical Theory.

In the practice of iron-bridge construction, and still more in its future development, theory must always be regarded as an indispensable guide, if only for the reason that there is always a point beyond which experience will not carry us. At the present moment the trustworthiness of theory is so fully recognised, that no one would think of determining the proportions and details of an iron bridge without reference to theoretical calculations, or by the mere exercise of that indefinable quality which is known as the "judgment" of practical men. The time has therefore gone by when it was necessary to protest against that unreasoning objection to theory which can only have arisen from a mistaken notion as to the real meaning of the word. In fact theory, in its broadest and truest

sense, is universally employed in all mechanical designs and operations ; and the so-called " practical " man who will have nothing to do with it, is unconsciously in the position of the bourgeois, in Molière's comedy, who would not believe that he had been all his lifetime speaking and writing *in prose*.

For example, a London builder may perhaps find by experience that a timber prop 6 ins. \times 3 ins. is strong enough to carry a certain weight. This discovery would constitute one of those experimental facts on which all theory and all practice must necessarily be based. But if now he has to provide a support for a load of double that weight, his facts are of no use to him until he calls in the aid of reasoning. Proceeding, then, in a rough and ready fashion, he may perhaps decide to use for his purpose a prop 6 ins. \times 6 ins. ; but in doing so he acts upon theory. The theory which he unconsciously employs is no doubt a crude and imperfect one, but still it is theory. In the same way every mechanical operation that demands the exercise of reason is conducted upon theory of some sort ; and therefore all constructive practice (except that of the lower animals) is necessarily directed by theory—just as all useful theory is based upon practical experiment.

It will be seen, therefore, that in attempting to study this question of bridge-construction, the choice does not lie between a " theoretical " and a " practical " method of examination, as neither of them can be employed without making use of the other ; but the only questions will be as to the limits within which theory may be rightly and profitably used, and as to the form of theory to be chosen for the purpose.

And in regard to these more important questions it may be remarked that theory does not consist in the employment of algebraical symbols, but in the employment of *reason* ; and therefore the best kind of theory is that which is most clearly understood by the person engaged in it, and the worst possible kind of theory is that which is not understood at all.

It is really a matter of no consequence whether the reasoning is carried on by the use of words and figures, or by the aid of diagrams or algebraical symbols,—so long as the operator knows what he means by the terms or symbols he is working with. But on the other hand there is no form of theory that can be safely *accepted* ; and the most unsafe and unreasonable proceeding that can be adopted is that which consists in taking a formula on the authority of some engineering text-book, and proceeding to make use of it without examining the reasoning by which it is arrived at, or the assumption in which it begins, or the limits within which it is intended to be applied.

But even when theory is rightly applied, it is certain that engineering calculations can at the best be only approximately correct, and therefore there are certain common-sense limits to the degree of accuracy that should be aimed at. For example, we know that the ratio of the circumference of a circle to its diameter cannot be correctly expressed by any finite number of figures ; but most people think that when the quantity is

given in four places of decimals, it is near enough to the truth for all ordinary purposes. Science is measurement, and measurement should be accurate, but there is no practical advantage in a refinement of calculation which costs more than it is worth. One of the chief objects of bridge-theory is economy of construction, or the art of applying materials in the most scientific manner, so as to obtain the requisite strength of the structure with the least expenditure of material; and *when* the only object to be gained is the saving of a small quantity of material, it would certainly seem that the amount of labour bestowed on such calculation should bear some reasonable proportion to the value of the objects to be gained.

This very practical view of the matter is, however, sometimes apt to lead to a habit of mind which may be described as the philosophy of erring on the safe side, and which consists in using as little theory as possible, and relying chiefly on a broad margin of safety; but in designing bridges upon a large scale such a habit may very easily be carried so far as to defeat its own objects; for it is necessary to consider not only the costliness of iron and steel, but also their great weight; and if such materials are lavishly employed, they will not only weigh heavily upon the finances of the undertaking, but what is sometimes of more importance, they will weigh heavily upon the bridge itself. Even with the strictest economy it will generally be found that, in very large spans, the weight of the material forms the chief portion of the total load, and therefore every ton of iron that is injudiciously employed, or employed in the wrong place, contributes not to the strength, but to the weakness of the bridge.

In such a case, the ill-considered notion of "erring on the safe side" might in reality be a dangerous error. Broadly speaking, its effect may perhaps be described as follows: In a bridge of 50 feet span it would *perhaps* be harmless; in a span of 500 feet it would be ruinously expensive, without adding to the durability of the structure; and in a span 1500 feet it would probably be fatal.

This illustrates the practical value of *accuracy* in the detailed calculations as applied to bridges of different spans; and the same remarks will apply with still greater force to that wider employment of theory by which the economy of different forms of bridge-construction may be examined and compared. The relative value of two designs, of which one is more economical than the other, depends upon the magnitude of the bridge—if the span is a small one, the superior economy of one design means only that it would be a little *cheaper* than the other; but in bridges of the largest span, it means that the one is a safe and practicable design, while the other could never be safely carried out with *any* possible expenditure of money and material.

"Economy" in bridge-construction is therefore something very different from a mere saving of cost, and has nothing in common with that sort of economy which consists in reducing expenditure at a corresponding sacrifice of efficiency, or strength, or fitness. On the contrary, it insures

the highest possible efficiency by making the best use of the given material, and without it the safe construction of very large bridges would be impossible.

Thus, the value of theory increases with the magnitude of the work. The larger the bridge, the more difficult does it become to find any experience that is applicable to the case, and at the same time the greater is the commercial value of correct theory and of accurate calculation.

In such works theory must of necessity be consulted in every line of the design; and every member, joint, and connection must be adapted to the particular duty which theory assigns to it. At the same time all this has to be done with due regard to the practical processes by which iron and steel are manufactured, and by which plates, bars, and castings can be produced in forms more or less suited to the required purposes; while the actual erection of the bridge, and the preparation of its foundations, will present a number of practical questions, varying in each individual case, and calling for the exercise of skill and ingenuity as well as theoretical knowledge.

The object aimed at in the following chapters will be to examine the practice of bridge-construction, and the experimental facts on which it is based, in the light of reasonable theory—and to state the theory of bridge-construction in such a practical form as will be most useful for the purposes for which it is employed; regarding the theory simply as a means to a practical end, and not as a field for the employment of mathematical research.

PART I.

ELEMENTARY STATICS.

CHAPTER I.

DEFINITIONS OF FORCE, EQUILIBRIUM, STRAIN, STRESS, AND STRENGTH.

1. **Force.**—In considering the theory of bridge-construction, we shall very often be engaged in measuring the forces which act upon different parts of the bridge; but the word “force,” as applied in Mechanics, has been defined in two or three different ways, and has been used in as many different senses; and it may be well to define the sense in which it will be employed in the following pages.

It is generally agreed that the presence of force is to be inferred from the effects which it produces; and also that force produces three recognisable effects by which its presence may be inferred and its magnitude determined, viz :—

1. By accelerating, or changing in some way, the motion of bodies;
2. By opposing and balancing other known forces; and
3. By producing a visible and measurable strain or deflection in elastic bodies.

Each one of these effects is used every day as a means by which force may be measured; and each one of them is manifested in an iron bridge under the action of the rolling load; but for most practical purposes we shall be chiefly concerned with the opposition of balanced forces, and with the strain which they produce in an elastic body, while it will seldom be necessary to refer to the motion which may be produced by an unbalanced force.

The tendency to cause motion, or change of motion, is sometimes regarded as the distinguishing characteristic of force; but when forces are engaged only in opposing each other, or in producing strain, it is not necessary that all of them should possess this tendency, and it is often doubtful whether they really do possess it. Thus the equilibrium of

every bridge may be said to depend upon the balancing of the upward and downward forces, and amongst these the upward pressure of the foundations must evidently be included. It must not be understood that this supporting pressure, or reaction, has any tendency to produce an upward motion—it *may* have such a tendency if the foundation is elastic, or if the bridge is carried upon the head of a hydraulic ram—but whether the foundations are elastic or not, their upward pressure will have the same effect in opposing the downward forces, in maintaining the equilibrium of the bridge, and in producing strain throughout its structure.

Therefore, when we are considering the opposition of balanced forces, it will be unnecessary to enter upon the delicate inquiry as to whether this “tendency to cause motion” exists in every case; and we may conveniently regard the upward pressure of the foundations, or any such reaction or resistance, as a *force* exerting a definite action upon the body in question, and producing the effects which have been mentioned as the second and third in the list.

On the other hand, when we are considering the first effect of force, there can never be any doubt about the “*tendency*” to cause motion; for when a force is *not* opposed in its action by any contrary forces it immediately begins to produce a visible effect upon bodies by urging them forward in the line of its action, and with an accelerating velocity,—or if the body is already moving in a contrary direction, by retarding that motion—or if the body is moving across its line of action, by changing the direction of that motion. In either case, the velocity, measured in the line of the force’s action, is changed; but to produce this change, force requires *time* for its action. The change is only effected at a certain rate, which is proportional to the magnitude of the force; and in order to produce a certain acceleration in a given time, the force must also be proportional to the mass of the body to be moved.

“Momentum” is the mass of the body multiplied by its velocity, and therefore the magnitude of the force must always be proportional to the *time-rate of the change of momentum*.

Force can only act upon *matter*—and we know nothing of force that does not *act*—so that in speaking of any individual force, it is always necessary to connect it with *the body on which it acts*. At the same time, every force is an action between *two* bodies, and it is necessary to distinguish between them; for the action upon one of these bodies is exactly opposite to the action or reaction upon the other. Thus, if we call the bodies *A* and *B* respectively, the force which *A* exerts upon *B* is always accompanied by an equal and opposite force which is exerted upon *A* by *B*.

This necessary equality between action and reaction has nothing whatever to do with the “balance of forces,” which is a totally different question relating to the comparison of the several forces acting upon any given body. Thus, the body *B* may perhaps be subjected to no

other force except a direct pressure exerted upon it by A ; and the effect of this "unbalanced" force will be to change the motion of B , either by increasing its velocity in the direction $A-B$, or by retarding its velocity in the direction $B-A$. For example, the momentum of an approaching railway-waggon may be gradually checked and its motion ultimately reversed by the spring of a fixed buffer-stop. Here the change of momentum goes on continuously, not only during the retardation, but also during the subsequent acceleration of the waggon's motion, and at every moment is the exact measure of the force acting upon the railway-waggon, and also of the contrary force acting upon the spring.

In this case the change of motion may be regarded either as the *effect* of the force exerted by the spring, or as the *cause* of the force exerted upon the spring.

However, we have chiefly to deal with the *effects* of force; and, to prevent confusion, it will always be well to consider the action of force upon one body at a time, and to keep steadily in view the particular body whose condition and behaviour are the subject of examination for the time being. We shall therefore regard change of motion, or the commencement of motion, in any body, as the direct *effect* of some unbalanced force *acting upon that body*, and as the visible evidence of the presence of such a force.

2. Balanced Forces.—A body, while remaining at rest, may be pressed or pulled in different directions at the same time by two or more forces, which may be so evenly matched that neither of them produces any motion, or commencement of motion, in the body. In this case, the mutually opposing forces are said to be "balanced," and the body itself is said to be in "equilibrium." The visible proof of its being in equilibrium lies in the fact that it does not begin to move, which demonstrates the entire absence of any unbalanced surplus of force in any direction; and this fact will enable us to calculate the value of some of the unknown forces when the magnitude and direction of the remaining forces are known.

Thus the second effect of force, viz., that of balancing other forces, affords another means of measuring its magnitude, and one which is independent of any change of motion, so that in this case the "tendency" to cause motion does not really affect the question. If the body is in equilibrium, the forces acting upon it cannot actually exhibit their power of producing motion, and we may think what we please of their "tendency" to do so. Every one of the mutually opposed forces may have this tendency, and it would appear that one of them at least must possess it; but if the remainder should happen to be nothing more than the reaction of dead resistances, their opposition would be none the less effective.

3. Equilibrium of Structures.—From the previous definitions it follows, without argument, that the equilibrium of a framed structure demands the fulfilment of the following conditions, viz.:

1. The forces exerted on the whole structure by external bodies must balance each other, or else the whole structure will begin to move.¹

2. If any part of the structure be separately considered, the external forces acting upon it must balance each other,—no matter whether the part in question be a large or a small portion of the structure, or a single bar of the framework, or a single particle of the bar. If the forces acting upon any bar of the frame do not balance each other, the bar will move and distort the figure of the frame; and if the forces acting upon any particles of a bar are not balanced, the particles will move and alter the form of the bar.

4. **Strain.**—When a bar of iron, or any other material, is acted upon by two equal and opposite forces in the direction of its length, their effect *upon the bar* is to strain it, and the bar is accordingly strained; *i.e.*, if the forces are a pair of equal and opposite pressures, the bar is compressed; or if they are a pair of equal and opposite pulls, the bar is stretched or extended. “Strain,” therefore, is an alteration of length or of form, which has been produced by the application of force, and it is to be measured, not in tons, but as a geometrical quantity.²

5. **Stress** is the name properly given to that internal force which is exerted by the material in resisting strain. It follows that when every portion of the strained bar is in equilibrium, the internal stress exerted at any imaginary section taken through the bar, is equal and opposite to the straining force. Thus, if the bar is compressed by a pair of equal and opposite external forces, the strained material is exerting at any section a stress, which is itself a force acting upon either half of the bar, and resisting and balancing the external force which acts upon that half. Such a stress, although it may be due to a repulsion between the particles of the bar, is termed a “compressive stress,” because it acts upon either half of the bar as a compressive force, balancing one of the external compressive forces.

6. **Elasticity.**—Every substance in nature yields in some degree to the impress of force, and therefore suffers strain, and this property is sometimes called “elasticity;” but, strictly speaking, elasticity is the property of recovering from strain, and its existence can only be proved by removing the straining forces, and then watching the recovery of the body to its original form and dimensions. If that recovery is perfect, the body is said to be perfectly elastic, but the elasticity is imperfect if there remains any “permanent set” or permanent strain from which it does not recover. In this sense it is said that no solid bodies are perfectly elastic, but the elasticity of wrought iron and steel may be regarded as practically perfect, so long as they are not strained beyond the so-called “limit of elasticity.”

¹ Among the downward forces, we must of course include the weight of the structure itself, or the force of the earth’s attraction.

² The word “strain” is very often used to express the same meaning as “stress,” and the words “tension” and “compression” are often appropriated for the same purpose; but some economy of words appears to be really necessary, and we shall endeavour to confine the use of the word to the sense above defined.

Of course, this elastic recovery is motion, and therefore its commencement must be regarded as the visible effect of some unbalanced force acting upon the moving parts or particles. That force is to be found in the internal *stress* which, at any section, is exerted by the strained material, and which becomes an unbalanced force at the moment when the external load is suddenly removed.

In the same way, when the external force is suddenly applied, it is at first an unbalanced force, for there can be no stress without strain; but when equilibrium has been established by the compression of the elastic body, the resisting stress is, of course, equal and opposite to the straining force.

7. Measurement of Strain and Stress.—Each kind of stress is attended by its own particular kind of strain, and although these effects are really somewhat complex, yet for practical purposes the different kinds of stress and their accompanying strains may be distinguished as follows, viz. :—

<i>Straining Force or Stress.</i>	<i>Strain.</i>
1. A direct pull or a tensile stress,	Producing extension or elongation.
2. A direct thrust or a compressive stress,	} Producing compression or shortening.
3. A shearing force or a shearing stress,	

A direct stress will be measured in pounds, or in tons; but a direct strain, in inches and parts of an inch.

If the stress is evenly distributed over the whole sectional area of the bar, the "intensity of stress" will be uniform, and will be expressed in pounds per square inch of sectional area. And if the stress is unevenly distributed, the stress-intensity may be considered as having a certain definite value for each fibre or layer of the bar, although it may be different in the different fibres.

In measuring direct strain, regard must be had to the length of the strained bar. If a bar is subjected to a moderate tensile stress acting through the whole of its length, every part of its length will be strained to the same degree; *i.e.*, every lineal foot of its original length will be extended by a certain fraction of a foot, and every lineal inch by the same fraction of an inch. This fractional ratio, or the extent of the strain per unit of length, is commonly called the "unit strain."

Within certain limits to be hereafter discussed, it is found that the direct strain in a bar of iron or steel is very nearly proportional to the stress; *i.e.*, the "unit strain" is always proportional to the "intensity of stress," whatever may be the dimensions of the bar. Thus, if a vertical tie-rod of wrought iron, 10 feet in length and one square inch in section, is loaded with a suspended weight of one ton, it will be elongated by about $\frac{1}{160}$ th of an inch, or $\frac{1}{13000}$ th part of its original length. A load of two tons would produce an elongation of twice that amount, and so

on ; and whatever may be the value of the load, the length of the bar, or its sectional area, each ton-per-square-inch of tensile stress will stretch the bar by $\frac{1}{13000}$ th of its original length.

This proportionality between stress and strain affords another means of measuring the magnitude of force, and one which is in fact employed every day in the spring-balance, the pressure-gauge, and the aneroid barometer ; and in the theory of bridge-construction it is sometimes necessary to use the very small elongations and compressions of the different members in the same way, as affording a visible and mensurable indication of the intensity of stress.

The proportionality between stress and strain is only true within the so-called "elastic limit," or "limit of elasticity ;" but if it were universally true, it is evident that a stress-intensity of 12,000 tons per square inch would stretch the wrought iron tie-bar to double its original length ; *i.e.*, the strain would then be equal to the original length of the bar ; and this imaginary and impossible intensity of stress is termed the "Modulus of Elasticity" for the given material. Thus, to find the stress intensity in a bar of any material, it is only necessary to multiply the modulus (for the given material) by the fraction which represents the observed "unit strain ;" and the result will be sufficiently correct for all strains within the elastic limit.

8. Strength.—The strength of any material is commonly understood to mean the measure of its capacity to endure stress, or to exert stress in resistance to strain. The "ultimate strength" is, of course, the ultimate or extreme capacity of the material in this sense. The ultimate strength of a structure must mean the greatest load, or the greatest force of any specified nature, that can be applied to the structure without causing *failure* of some kind in any of its parts. The strength of a structure is, therefore, defined by the strength of its weakest part, considered in relation to the stress produced in that part by the given load upon the structure. But it is necessary to define what is meant by "failure," as otherwise it will be impossible to specify the magnitude of the load or stress that would produce it.

Elastic deformation cannot be regarded as failure—or if it is, the ultimate strength of any and every structure will be nothing. The absolute failure of a tie-bar takes place when the bar is torn in two, but the failure of a strut cannot be so simply defined. A long column may probably be regarded as a structure, whose strength is determined by the strength of its weakest or most heavily strained part. Its failure will generally take place by a lateral flexure and ultimate crippling, which may perhaps produce fracture or disintegration in a cast-iron column, but not so in columns of a semi-plastic material, such as wrought iron or steel. In such columns, failure can only be regarded as consisting in a certain flexure or local crippling which is something more than mere elastic deformation.

But when the proportions of the strut are reduced to those of a cube,

or a short cylinder or wafer, there can be no such lateral flexure of the whole strut, and it becomes still more indispensable to define what is meant by failure. If it is to consist in the annihilation of the wafer, or its disappearance from between the squeezing surfaces, then the strength of a short strut will be almost infinite, and cannot be determined by either theory or experiment. But no such phenomenon can be produced in a column of any proportions; and it would appear that the ultimate strength of a cube or short strut must rather be regarded as the greatest weight that it will carry without exhibiting either a splitting of the edges or a bulging or crippling of the sides; for between that and absolute reduction to nothingness, there seems to be no intermediate phenomenon sufficiently marked to be regarded as the failure of the cube.

CHAPTER II.

ON THE OPPOSITION AND BALANCE OF FORCES.

9. Force is commonly measured in units of weight because our ideas of force are most frequently associated with the weight of heavy bodies; and we usually compare these familiar forces by *weighing* the bodies, one against the other. To ascertain the load resting upon the bridge, we weigh the locomotive, the carriages, the permanent way, &c.; and in the same manner we shall *weigh* the other external forces acting upon the bridge, and also the internal stresses which take effect in its members, by using the bridge itself as the scale-beam or steelyard.

The balance of a number of forces, when referred to three rectangular axes of co-ordinates, forms a problem which is treated at considerable length in mathematical works; but in bridge-building the forces acting in different planes are in most cases provided for separately in the design of the structure, and it will be sufficient to consider the balance of forces acting in one plane. All these cases may be referred to a few simple principles, and in discussing them it will be easy to illustrate the action of the various forces by a geometrical diagram upon the plane of the paper.

A force becomes defined in every particular as soon as we have determined its magnitude, the direction of its action, and the point at which it is applied; and all these may be illustrated at one time if we represent an individual force by a straight line, and suppose the length of the line to be a measure of the magnitude of the force, upon a scale of so many tons to the inch.

10. Thus in Fig. 1, the body *A* is subjected to the action of a direct pull represented by the line *bc*, and at the same time to the action of an equal and opposite pull represented by *de*, the forces being applied at the points *b* and *d* respectively.

By this *direct* opposition of equal forces, the body is evidently held in equilibrium, and the same result would follow if the forces were applied at any other points situated in the straight line *ec*; but if one of the forces were applied at a point situated on either side of that line, the equilibrium would be destroyed, for there would then be a tendency to turn the body round in a right-handed or left-handed direction.

11. The tendency of any force to rotate the body about a given axis



or centre of motion, is measured by the "*Moment*" of the force about that axis—*i.e.*, the magnitude of the force multiplied by its effective leverage; the effective leverage or arm of the moment being the perpendicular distance from the assumed centre of motion to the line of action of the force. In order that a body may be in equilibrium, it is necessary that any "moments" tending to turn it in a right-handed direction should be balanced by equal moments acting in the opposite or left-handed direction.

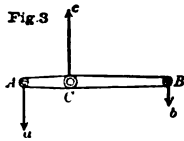
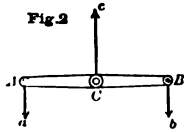

A familiar example of this opposition of moments is illustrated in Fig. 2, which represents the common scale-beam, with two equal arms, AC and BC , hung upon a delicate centre at C . Suppose C to be the centre of motion—then the moment of the force or weight Bb acting about the arm BC in a clockwise direction, is balanced by the contrary moment of the equal force Aa acting about the equal arm AC .

In the case of the steel-yard illustrated in Fig. 3, the arms of the beam are of unequal length, and consequently the weights are unequal; for in order to preserve the balance the contrary "moments" must be equal, *i.e.*,—

$$\text{Force } Aa \times \text{arm } AC = \text{force } Bb \times \text{arm } BC, \text{ or Force } Aa = Bb \times \frac{BC}{AC}$$

With regard to the upward and supporting force Cc , it may perhaps be sufficiently evident that, in each of these cases, its magnitude must be equal to the sum of the two downward forces; but this will be demonstrated if we suppose the centre of motion to be shifted (as it may be) to some other point in the beam, such as A , but leaving the upward force still applied at the point C . For in order that the beam may not turn about the centre A , it is necessary that the moment $Cc \times CA$ should be equal to the contrary moment $Bb \times BA$, therefore

$$Bb = Cc \times \frac{AC}{AB}, \text{ and in the same way}$$

$$Aa = Cc \times \frac{CB}{AB}, \text{ therefore}$$

$$Aa + Bb = Cc \times \left(\frac{AC + CB}{AB} \right) = Cc.$$

If the diagram is regarded as a ground-plan, so that all the forces act in a horizontal plane while the lever is pivoted upon a vertical axis, it is evident that the weight of the lever will not affect the balance of forces; but when forces acting in a *vertical* plane are under consideration, the weight of the lever must of course be considered as a distributed force acting upon the lever like any other forces; but it will be more convenient to take this into account at a later stage, and for the present to assume that the weight of the lever is nothing.

12. The "law of the lever," which has just been stated, may be

demonstrated by reference to the Conservation of Energy, or the equality between energy expended and work performed; but the principle is so familiar that any demonstration is unnecessary, and we shall therefore proceed to make use of the scale-beam in comparing the magnitude of balanced forces. The form of lever above illustrated will be sufficient for the comparison of parallel forces, and we have only to refer to one or two other alternative forms which may be used in comparing forces that act at right angles, or in any oblique directions.

Fig. 4 represents a bent lever in which the centre of motion is at *C*, and the arms *AC* and *BC* are at right angles to each other, and perpen-

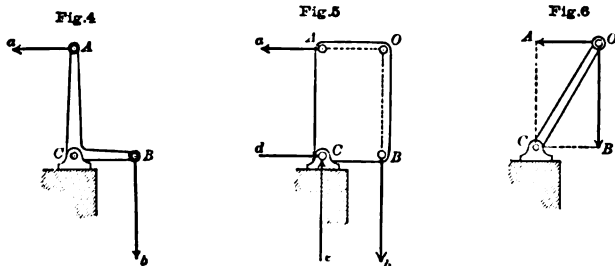

dicular to the lines of action of the respective forces. The contrary moments about the axis at *C* are of course equal, so that

$$Bb \times BC = Aa \times AC, \text{ as before.}$$

Instead of a bent lever, we may employ a rectangular plate *AOCB*, as illustrated in Fig. 5, and if we continue the lines of action *aA* and *bB* until they intersect in the point *O*, it will be evident that, so long as the plate does not change its angular position, the respective forces may be applied at any point along these lines of action without affecting the balance. Therefore we may, if we please, apply both the forces at the point *O*, and in this case the rectangular plate of Fig. 5 may be replaced by a straight diagonal bar *OC*.

This alternative is shown in Fig. 6, in which the balanced forces are represented by the lines *OA* and *OB*. In this modification the balance-lever has only one physical arm; but it will be remembered that the effective arm or leverage of each force is, not the length of the lever *OC*, but the perpendicular distance *CA* or *CB* from the centre of motion to the line of action of each force. The moments therefore remain the same as before, and $OA \times AC = OB \times BC$; so that if we know the inclination of the lever *OC* or the rectangular co-ordinates *CA* and *CB*, we can find the value of a force *OA* which will balance a given force *OB*, as these forces must be proportional to the sides of the rectangle *AOCB*; and conversely if we know the ratio of the forces we can find the inclination at which the lever will be in equilibrium, for if the two forces are

represented by the sides of any rectangle $AOBC$, the diagonal OC represents the angular position of the lever.

Referring now to the forces which hold the plummer block in position at C , we may revert for a moment to the rectangular plate of Fig. 5, and suppose that the point A , at the upper corner of the plate, is the centre of a possible rotary motion—then to prevent the plummer block from sliding back, the moment of Bb about the arm OA must be balanced by the contrary moment of a force dC about the arm CA , and it will be seen that $dC = Aa$. In the same way if B is taken as a centre of motion, a vertical force eC must be applied at C to support the axis, and $eC = Bb$. The axis at C requires, therefore, the support of both these forces, but it will presently be shown that their action may be replaced by the action of a single inclined force which would have the same effect and is called the “*resultant*” of the two rectangular forces.

It only remains to notice that when the two forces Aa and Bb act at an acute or obtuse angle, they may be weighed upon a bent lever by making the arms of the lever perpendicular to the lines of action of the respective forces, as in Fig. 7; but whatever their inclination may be they can always be weighed upon the single-armed lever already described and again illustrated in Fig. 8. In this case the moments of the two forces are found by continuing their lines of action OA and OB , and drawing Cf and Cg perpendicular to the lines of action produced; then the right-handed moment will be $OB \times Cg$, and the left-handed moment will be $OA \times Cf$.

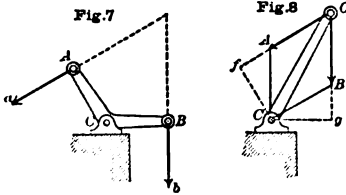

It was found in Fig. 6 that the forces balanced one another when they were proportional to the sides of the rectangle of which the lever formed the diagonal, and in Fig. 8 it will be found that the forces are balanced only when they are proportional to the sides of the parallelogram $AOBC$, in which the lever OC forms the diagonal; for the moments $OB \times Cg$ and $OA \times Cf$ are then each of them represented by the area of the parallelogram $AOBC$, and are, therefore, equal to one another.

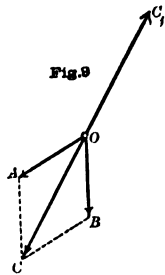

13. We have hitherto considered the equilibrium of forces balanced upon a lever or scale-beam, and this method of comparing them is really sufficient, but it is sometimes more convenient to make use of the theorem known as the “*parallelogram of forces*” for the resolution and composition of inclined forces acting through the same point. This theorem states that if any two inclined forces are represented in magnitude and direction by the sides OA and OB of the parallelogram $AOBC$ in Fig. 9, their “*resultant*” will be represented by the diagonal OC ; *i.e.*, their combined action upon the point O is equivalent to the action of a

single force OC , and would be balanced by the application of a force OC_1 , directly opposite and equal to the resultant. To demonstrate this important theorem several different methods have been proposed, but it will be seen that the theorem is almost demonstrated by the results already obtained with the single-armed lever illustrated in Figs. 6 and 8, and we may easily complete the proof of its accuracy by the aid of this weighing instrument; for the law of the lever really *includes* the theorem of the parallelogram of forces.

The manner in which this theorem is most commonly applied in questions of bridge-construction may be illustrated by referring to the case of the triangular brackets shown in Figs. 10 and 11. Fig. 10 represents a bracket consisting of a horizontal tie-rod, AO , and an inclined strut or jib, CO , supporting at O a load or a downward force represented by the vertical line OB . In Fig. 11 the same letters indicate similar parts, the only difference being that the tie-rod is here inclined. In such mechanical structures it is commonly assumed that the tie and the jib (especially if they are jointed at the ends) are only capable of exerting a direct pull or a direct thrust along the lines of their respective lengths, so that the action of the vertical force OB upon the pin O must be balanced by a force of some unknown magnitude in the direction OA , and another force of unknown magnitude in the direction CO . The direction of these two forces being thus fixed, or assumed, their magnitudes are found by completing the parallelogram of forces

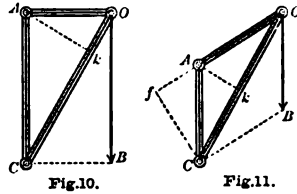

$AOBC$, drawing BC parallel to OA , and CA parallel to BO . Then by the theorem of the parallelogram, if the side OB represents on a certain scale the load carried by the crane at O , the pull of the tie-rod will be represented by length of the side OA , and the thrust of the jib by the length of the diagonal CO , the resultant of the forces OA and OB being the diagonal force OC equal and opposite to the thrust CO .¹

This is the solution as given by the theorem, and to demonstrate its accuracy we have only to consider the jib CO as a single-armed lever capable of turning upon the centre C , but held in equilibrium by the contrary moments of the forces OB and OA ; and we have already found that (whether the tie-rod is horizontal or inclined at any angle) these balanced forces are proportional to the sides OB and OA of the parallelogram $AOBC$, which at once proves the correctness of the theorem as regards the value of the force OA . Again, if we consider the rod AO as a single-armed lever centred at A , the thrust of the jib on the line CO will be determined in the same manner by the fact that its moment

¹ In the same way the force OB is equal and opposite to the resultant of the two forces OA and CO ; either one of the three balanced forces is of course sufficient to exactly balance the other two, and is equal and opposite to their resultant; and either one of the three coincides in length and direction with the diagonal of a parallelogram whose sides are represented by the two remaining forces.

about A must be equal and opposite to the moment of the force OB , which latter moment is represented by the area of the parallelogram $AOBC$; the thrust of the jib must therefore be equal to that area divided by the perpendicular arm Ak , and must therefore be equal to the length of the diagonal CO .

14. The principles of equilibrium are chiefly useful in determining the unknown magnitude of certain forces which must be exerted in order to balance certain other forces which are known to be in action. So far as results are concerned it matters nothing whether, for this purpose, we weigh the forces against one another by the method of moments, or whether we determine them by applying the theorem of the parallelogram, which, as we have seen, is only a particular example of the general law of the lever; and in any given case we may choose the method which seems to offer the readiest means of coming at the desired result.

One of the most useful applications of the parallelogram is in resolving an inclined force into its vertical and horizontal components. For

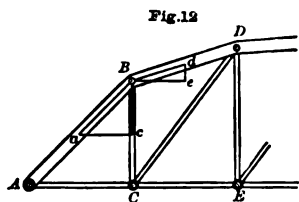

example, let Fig. 12 represent the first few bars of an open truss or girder, and suppose that in this diagram aB represents the direct thrust of the strut AB ; then if from a we draw the horizontal line ac intersecting the vertical line Bc in the point c , we may consider the inclined thrust as being composed of a horizontal force ac proportional to the horizontal base of the triangle aBc , and a vertical force cB proportional to the vertical height of the triangle.

These are called the horizontal and vertical components of the inclined force, and in trigonometrical language their values are expressed as follows:—

Let S = the inclined force aB ,
 V = its vertical component cB ,
 H = its horizontal component ac ,

and let θ = the angle caB :

$$\text{then } V = S \sin. \theta = H \tan. \theta = \sqrt{S^2 - H^2}$$

$$H = S \cos. \theta = V \cotan. \theta = \sqrt{S^2 - V^2}$$

$$S = H \sec. \theta = V \operatorname{cosec}. \theta = \sqrt{H^2 + V^2}.$$

In the figure, the strut AB is connected by a pin at A with the horizontal tie AC , and also with a shoe by which this end of the truss is carried upon its abutment. If the shoe is carried upon frictionless rollers upon a horizontal bedplate, it can offer no resistance in a horizontal direction, but only a vertical support; the horizontal component ac must therefore be borne by the tie AC , and represents the value of the tensile stress in that member; while the vertical component BC represents the load carried upon the shoe at A , and the equal and opposite upward force exerted upon the truss by the abutment. Again, the

strut AB is connected by a pin at B with a vertical tie, BC , and also with an inclined strut, BD ; the forces acting upon the pin B must balance each other, and it needs no demonstration to show that the sum of the forces acting vertically downwards upon it must be equal to those acting vertically upwards, and in the same way that the contrary horizontal forces acting on opposite sides of the pin must also be equal to one another. The vertical tie BC can exert no horizontal pressure upon the pin, and therefore the inclined force dB must have a horizontal component eB equal to the horizontal component ac .

In the same way if any number of bars meet at one joint, the algebraical sum of their horizontal components of stress (reckoning opposite directions as positive and negative) must always be $= 0$, and the sum of the vertical components acting downwards must also be equal to the sum of the vertical components acting upwards. This consideration will often enable us to obtain the horizontal and vertical components of the stresses acting in the adjacent members of a truss by simple addition and subtraction, and the direct stresses are then easily determined.

It is hardly necessary to show that the results we have just obtained by the resolution of inclined forces might have been obtained, and may easily be verified, by the law of the lever. If we consider the bar BC as a single-armed lever centred at C , the moment of the force aB about this centre must be equal to the contrary moment of the force dB . The perpendicular distance from C to the line of action of the force aB is equal to $BC \times \cos. \theta$, and the moment of this force is therefore equal to $S \cos. \theta \times BC$; but $S \cos. \theta$ represents the value of the horizontal component ac , so that the moment of the inclined force aB about the point C is equivalent to the moment of its horizontal component acting with the full leverage of the vertical arm BC . In the same way, it will be seen that the contrary moment of the inclined force dB is equal to the moment of its horizontal component eB acting with the same leverage BC ; therefore the horizontal components ac and eB are equal.

Thus the bar BC may serve as a lever on which the thrust of the bars AB and DB may be weighed against each other; and by taking some other bar as an equilibrated lever, the other forces named in the last article may be successively ascertained in the same manner; and whether the process be conducted in this way or by the theorem of the parallelogram, it will generally consist in a multiplication by the same or equivalent ratios in either case.

15. Hitherto we have only considered the balance of moments produced by the action of single forces; but it is obvious that if we apply on one arm of the scale-beam a number of weights or parallel vertical forces as indicated in Fig. 13, the weight that must be put in the opposite scale

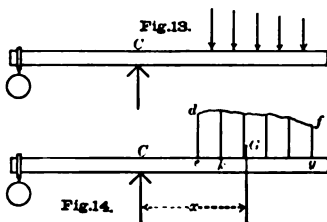

will be the sum of the weights which would be required to balance each of the forces separately; in other words, the moment at *C* produced by the whole group of forces upon the right arm, will be the sum of the moments due to each force separately.

When a distributed load of varying intensity is applied to the beam, as illustrated in Fig. 14 by the irregular mass *defg*, we may divide the irregular figure into a number of narrow vertical strips of equal width, and consider the weight of each strip separately. Thus if the ordinates *de*, &c., represent the intensity of load per unit of length, the area of each strip *de* × *ek*, &c., will represent its weight, which, if the strip is very narrow, may be considered as a force acting at the centre of the strip; and having calculated the moment of each strip about the fulcrum *C*, we can find the moment of the whole distributed load.

The moment of the distributed load about any axis *C* is the same as though the whole load were concentrated at its "centre of gravity;" the position of the centre of gravity *G* of the load is therefore found by adding together the separate moments of its constituent parts (or strips), and dividing the total moment by the total weight of the load, which gives the length of arm, *x*, about which the load must act in order to produce that moment. For this purpose it is of no consequence what position may be chosen for the axis *C*; for whatever position may be taken, the length *x* being measured from that position, will always terminate at the same point in the figure *defg*, viz., at the centre of gravity of the figure.

By analytical methods which are practically equivalent to that above described, the position of the centre of gravity has been found for a great number of regular geometrical figures, of which the most useful for our purposes will perhaps be the triangle, and the spaces bounded by a parabolic curve and its chord, or its tangent.

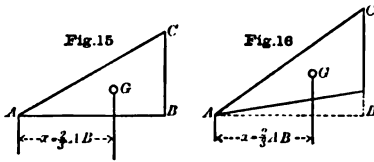

In the right-angled triangle *ABC* of Fig. 15, the horizontal distance of the centre of gravity *G* from the apex *A* is $x = \frac{2}{3} AB$.

Also in the scalene triangle *ACD* of Fig. 16, which is simply an oblique projection of Fig. 15; the side *DC* being vertical, the horizontal distance of the centre of gravity *G* from the apex *A* is again two-thirds of the horizontal length *AB*.

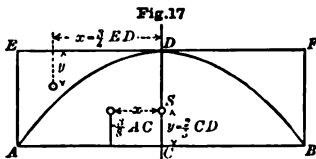

In Fig. 17, the area enclosed between the parabolic curve *ADB* and its chord *AB* is equal to two-thirds of the rectangle *AB* × *CD*. The figure being symmetrical, the centre of gravity, *S*, of the

whole area is situated in the axis *CD*, and at a height above the chord = $CS = y = \frac{3}{8} CD$.

The area of the half segment ACD is of course two-thirds of the rectangle $AC \times CD$; the centre of gravity S_1 is at the same height above the chord, viz., $y = \frac{2}{3} CD$; and its horizontal distance from the axis is $x = \frac{3}{8} AC = \frac{3}{16} AB$. The supplementary area ADE contained between the curve and its tangent ED , is of course one-third of the rectangle $ACED$; the centre of gravity S_2 is situated at a depth below the tangent $= y = \frac{2}{3} CD$, and its horizontal distance from the axis is $x = \frac{3}{4} ED = \frac{3}{8} AB$. The centre of gravity of a rectangle is of course in the centre of its length and of its height; and with the aid of the figures here given it will generally be easy to find by calculation the moment and the centre of gravity of any complex figure or irregular load.

CHAPTER III.

ON BENDING STRAIN.

16. Perhaps the oldest form of bridge is that very elementary one, which consists simply of a beam of timber thrown across the opening to be spanned. Thus a primæval savage, seeking for some means of crossing a ravine, might easily establish the desired line of communication by making use of the trunk of some fallen tree; and he would probably regard the structure, when completed, as a very simple one, calling for no special exercise of thought to understand its principles. But the modern engineer looks at the same structure in a different light, and from his point of view there are few forms of bridge-construction which are so hard to understand.

The stresses that take effect in a large and complex lattice girder may be easily measured, but if we try to discover the stresses and strains in this log of timber, we shall find the problem to be very difficult—indeed, it is one which has not yet been solved in a manner that reasonably accords with the known strength of the beam as found by actual experiment.

But if we cannot arrive at a complete analysis of the strains, it will nevertheless be useful to obtain some idea of what takes place in a beam when it is bent under transverse forces, as, for instance, when the beam is supported at each end, and carries a load in the middle, as shown in Fig. 18, or when it is supported in the middle, and loaded at each end as in Fig. 19.

In order that the beam may be balanced in the latter case, it must of course be loaded with the same weight at each end, and the supporting force in the middle will be equal to the sum of the two loads (leaving the weight of the beam itself out of account). It is also obvious that the central load in Fig. 18 will be equally divided between the two supports *A* and *C*, and that the supporting force at each end will be equal to half the central load, so that the two cases shown in Fig. 18 and Fig. 19 are the exact converse of each other. Moreover, it is obvious that the two halves of the beam situated respectively to the right and left of the centre, are placed under precisely similar conditions, and either half may be considered separately, as though it were fixed at *BD*, and loaded at its extreme end, as shown in Fig. 21.

17. When the beam is bent under the application of these transverse forces, we perceive at once, and without much reasoning upon the subject,

that the fibres on the convex surface of the beam are stretched, and those on the concave surface are compressed ; so that in Figs. 20 and 21 the fibres in the upper part of the beam are undergoing a tensile strain, while the fibres in the lower part are suffering compression.

We have already seen that the direct stress or resisting force exerted by a strained rod, or by any strained fibre, is nearly proportional to the lineal extent of the strain ; *i.e.*, proportional to the degree to which the rod or fibre is extended or compressed ; so that strain is a kind of pressure-gauge indicating visibly the intensity of the internal stress. In order, therefore, to find the relative intensity of *stress* in different parts of the beam, we may first examine the relative *strains*, and for this purpose it is usual to make the following assumption :—Suppose that

Fig. 18.

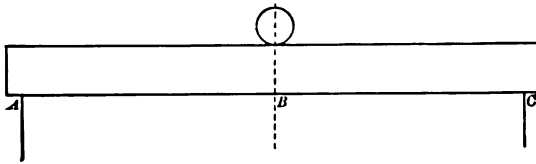

Fig. 19.

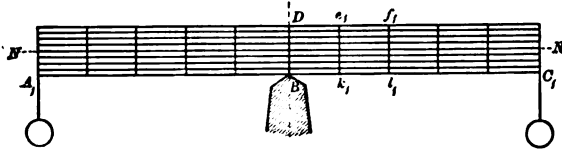
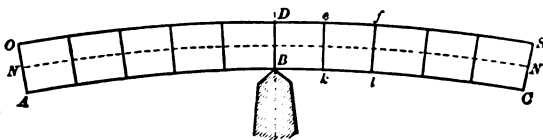

Fig. 20.



before the beam was bent, we had drawn upon its side a number of parallel horizontal lines dividing the beam into so many imaginary layers, and also at right angles to these a number of vertical lines dividing the beam into so many rectangular compartments, as shown at e_1k_1, f_1l_1 , &c., in Fig. 19—then it is commonly assumed that when the beam is bent these latter lines will remain straight and at right angles to the beam, forming in the bended beam a series of radial lines like the joints of an arch, as shown at ek, fl , &c., in Figs. 20 and 21. If this assumption is correct, it is easy to see that the length of the several curved layers of the beam decreases in regular arithmetical proportion from the top to the bottom ; but the gradation will be effected partly by extension and partly by compression ; the topmost layer will be the most severely

extended, while the lowest layer will be most severely compressed ; and at some intermediate point there will be a layer or line NN which retains its original length unaltered.

This line, which suffers neither extension nor compression, is the so-called "neutral-axis ;" and whatever may be its exact position in the beam, the several layers which lie above and below it will be extended or compressed in proportion to the distance of each layer from the neutral axis.

To make this quite clear, consider the compartment De_1k_1B in Fig. 19, which assumes the form $DekB$ in Fig. 21 when the beam is bent. The length of the neutral axis Nn , in the latter figure, will represent the original length of every layer ; and if we set off De_1 and Bk_1 each equal to Nn , the line e_1k_1 , parallel to DB , will serve to measure the original

Fig. 21a.

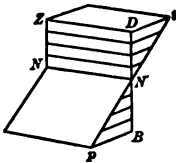

Fig. 21.

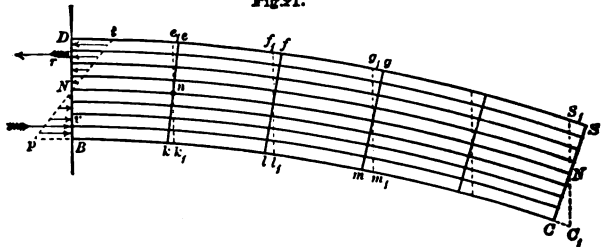
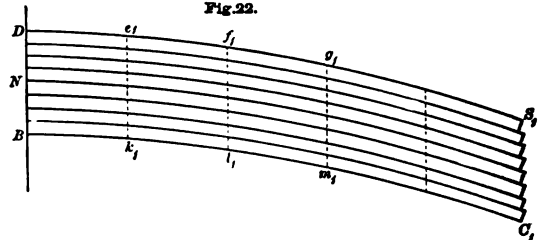

Fig. 22.



length of each layer ; so that the space intercepted between the lines e_1k_1 and ek will represent the elongation or compression that has taken place in the length of each layer. The topmost layer is extended by the amount ee_1 , and so on with the other layers ; and as the lines cross each other at n , it is evident that each layer is strained to an extent which is proportional to its distance above or below the neutral axis ; and the intensity of stress being in the same proportion, these several intensities may be represented by the arrows contained in the triangles DNt and BNp .

But the total stress upon each layer of the beam will be equal to the sectional area of the layer multiplied by the intensity of stress upon that area ; and this distribution of force may be represented by the wedge-

shaped solids shown in Fig. 21A, in which DB is the depth, and DZ the breadth of the beam; so that the surface $DZNN$ is the area on which the tensile forces are acting with an intensity which varies as the horizontal length of each layer in the triangle DNt . Therefore the *solid contents* of each layer in the wedge will represent the total stress acting in that layer, and the solid contents of the whole wedge DNt will represent the sum of the tensile stresses, while the compressive stresses will be represented in like manner by the lower wedge BNp . Also if the stress due to a given strain is the same in tension as in compression, the triangles DNt and BNp will be similar triangles.

Thus far, the relative stresses have been considered as depending upon the relative strains; but now consider the half-beam $DBSC$ as a body in equilibrium under the several forces acting upon it, including of course the stresses which are exerted upon it at the section DB by the other half of the beam. And first it will be seen that there are no *horizontal* forces acting upon the body anywhere except at the section DB , so that the horizontal forces acting at this section must balance each other, *i.e.*, the total thrust must be equal to the total pull. It follows then, that the solid contents of the two wedges DNt and BNp must be equal, so that if the beam is rectangular in section the triangles DNt and BNp must be of equal area; and as they are assumed to be similar triangles, the sides ND and NB must be equal, and the sides Dt and Bp must be equal. Therefore, in the rectangular beam, the neutral axis is in the centre of its depth, and the maximum tensile stress has the same intensity as the maximum compressive stress.

Again, the unequal distribution of stresses represented by each of the wedges may be considered as equivalent (in each wedge) to a concentrated force of the same total magnitude, acting at the respective centres of action r and v , whose vertical distance from the neutral axis will in each case be equal to two-thirds the height of the triangle, so that the vertical distance rv between their lines of action is equal to two-thirds the total depth of the beam.

Each of these opposite forces, or elastic resistances, acting about N as an axis, exerts a moment in an anti-clockwise direction, and the *sum* of their moments about N must balance the clockwise moment of the weight W . But the sum of their moments about N will be the same thing as the moment of either force about the whole vertical arm rv , which is equal to two-thirds the depth of the beam.

Let l = the horizontal length of the half-beam BC ;

d = the depth DB ;

b = the breadth DZ ;

f = the maximum intensity of tensile stress in the topmost fibre (represented by Dt).

Then the *average* intensity of tensile stress in the upper half of the section will be $\frac{f}{2}$, and the sum of the distributed tensile stresses, repre-

sented by the wedge $ZDNt$, will be $\frac{f}{2} \times \frac{bd}{2} = \frac{fbd}{4}$; and their moment about the point v will be the "moment of resistance," or—

$$M = \frac{fbd}{4} \times \frac{2}{3} \bar{d} = \frac{fbd^2}{6} \dots \dots \dots (1)$$

On the other hand, we have the "bending moment," produced by the weight W acting with the leverage $BC=l$, and the bending moment Wl must be balanced by the moment of resistance, or $M = Wl = \frac{fbd^2}{6}$.

Therefore to find the maximum intensity of tensile stress due to any load W , we have—

$$f = \frac{6Wl}{bd^2} \dots \dots \dots (2)$$

and to find the load that the beam will carry with any given maximum intensity of stress f , we have—

$$W = \frac{fbd^2}{6l} \dots \dots \dots (3)$$

If L denotes the total length of the beam AC in fig. 18, and W_0 the weight of the central load, the "bending moment" at the centre of the beam will be—

$$M = \frac{W_0}{2} \times \frac{L}{2} = \frac{W_0L}{4},$$

which, as before, must be balanced by the moment of resistance, or $\frac{W_0L}{4} = \frac{fbd^2}{6}$, therefore in this case we have—

$$f = \frac{3}{2} \cdot \frac{W_0L}{bd^2} \dots \dots \dots (2a)$$

$$\text{or, } W_0 = \frac{2}{3} \cdot \frac{fbd^2}{L} \dots \dots \dots (3a)$$

18. The simplicity of this theory would be very satisfactory if it could be regarded as a true and complete statement of the facts; for nothing could be easier than to calculate by the last formula the weight required to produce any given tensile stress; and if we know the ultimate tensile strength of the material, it would seem that we ought to be able, by this means, to find exactly the load that will break the beam. But if we take a rectangular beam of cast-iron and put the calculated breaking load upon it, the beam will show no symptoms of tearing at the stretched fibres, and no inclination to yield in any way; and as a matter of fact it will not break until we have increased the load to about $2\frac{1}{2}$ times the amount calculated.

To account for this disappointing result, numerous explanations have been offered from time to time ; but most of them appear to be either inconsistent with known mechanical principles or contrary to experimental facts. Some writers have supposed that the extreme stress in the topmost layer of the beam is in some way relieved, and a portion of it taken up by the less severely strained layers below, by means of the *lateral adhesion* between the layers. This view, however, appears upon examination to be quite untenable ; we shall see that the lateral adhesion does indeed play an important part in the resistance of the beam, but its action is exactly opposite to that which is implied in the terms of this supposition ; and so far from tending to alleviate the stress in the outer fibres, it is the very agency which is instrumental in causing the great stress that takes effect in those fibres. If there were no adhesion between the layers, there would be no longitudinal stress at all in any of them ; and this may be seen at once if we suppose the beam to be composed of separate layers, like a pack of cards, without any adhesion between them ; in which case we know that the flexure will take place in the manner shown in Fig. 22—not by extending or compressing the individual cards, but by a small sliding motion of each card over the other. This is sufficient to show that without lateral adhesion there would be no longitudinal strain, and therefore no longitudinal stress ; but the exact effect of lateral adhesion in producing the great stress in the extreme fibres of the beam will be still more clearly seen when we come to consider the equilibrated forces acting upon separate layers and separate particles of the beam.

This lateral adhesion is in fact only one way of regarding the resistance offered by the solid material of the beam to a certain “*shearing force*,” which we shall find to be in operation in every description of girder—for without its agency the *vertical* forces, impressed upon the beam by the load and by the supports, could not be transformed into *horizontal* stresses.

19. The theory of flexure described in the preceding articles, although it cannot be regarded as an entirely correct and complete statement of the facts, is yet sufficient to show that, in the solid rectangular beam, a great deal of the material is doing very little work in comparison with what it is capable of doing, and even that little is done to a great disadvantage. The only fibres that are acting up to their full capacity are the extreme topmost fibres, while those layers which are situated near the neutral axis are almost idle, and the feeble stress which they exert is exerted at such a short leverage that their efficiency in resisting the bending moment of the load is almost nothing—the relative efficiency of the several layers for this purpose varies, in fact, as the square of their distance from the neutral axis.

The solid beam is therefore an extremely bad form of girder, and in bridge-construction it is very seldom used except for such subsidiary parts of the structure as the planking and joists of a timber platform ; and if we want to get the greatest possible strength with a given amount of

material, it is already evident that we must first adopt a liberal depth of girder, and then we must place the chief portion of the material at the points where it will act to the greatest advantage, namely, at the upper and lower edges. Such a girder is illustrated, for example, in Fig. 24, which represents the cross section of a cast-iron or a rolled wrought-iron girder, composed of an upper and lower "flange" ab and cd , united by a central "web"; or, again, the girder may be built up of separate plates and angle-bars, as shown in Fig. 23, and rivetted together. In girders of this section, the metal which is intended to resist the direct longitudinal strain is placed in the flanges, where it acts with the greatest leverage. The depth of the flange-plate being small, all the fibres in the flange are practically at one distance from the neutral axis, and the intensity of stress may be considered as being uniform throughout the whole section of each flange, and practically equivalent to the maximum stress of the extreme fibres; while the web, unless it is unusually thick, will render very little assistance to the flanges in the way of sharing the direct stress. If the web is thin, it is the usual practice of English engineers to assume that the flanges (including the angle-bars) have to bear the whole of the direct horizontal stress; but if the thickness of the web is considerable, it is usual to calculate the moment of resistance of the whole section

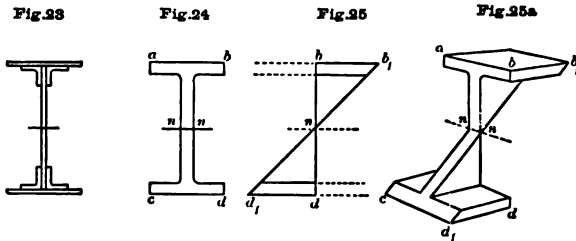

(web and flanges) by means of the theory of relative strain which we have just applied to the rectangular beam, and by which it was shown that the intensity of stress in each fibre is proportional to its distance from the neutral axis.

Let the girder be sawn through transversely by a vertical section bnd in Fig. 25, and again by an inclined section b_1nd_1 intersecting the first section at the neutral axis n ; then we shall obtain a pair of wedges, or solid bodies, of the forms sketched in Fig. 25a, and in these bodies the horizontal length of any fibre (such as dd_1) will represent the *intensity* of stress in that fibre, while the actual value of the stress in any fibre, or the intensity multiplied by the sectional area of the fibre, will be represented by the solid contents of that fibre intercepted between the two inclined sections. Thus the whole sum of the tensile and compressive stresses acting at right angles to the vertical plane bd will be represented by the contents of the two wedges.

Again we may use the illustration still further, for if we lay the upper solid flat upon its face, abn , the moment of its *weight* about the point n will represent, on a certain scale, the moment of the tensile stresses about the neutral axis; and treating the lower solid in the same way, we have a similar representation of the moment of the compressive stresses, and the *sum* of these two moments will represent the moment of resistance of the girder.

In order to effect the calculation, however, we must first find the position of the neutral axis. As before stated, the neutral axis must be so situated that the tensile and compressive stresses are equal to one another, or in other words, the contents of the two triangular solids in Fig. 25 must be equal; and this consideration fixes the position of the neutral axis at once as being coincident with the centre of gravity nn of the entire cross-section in Fig. 24; for whatever may be the figure of the cross section, if the moments about nn of the two areas above and below that line are equal to each other, the solid contents of the two wedges in Fig. 25 must also be equal. The centre of gravity of the entire *section* indicates therefore the position of the neutral axis; while the centre of gravity of each triangular *solid* indicates the centre of action of the distributed tensile and compressive stresses.

The calculation of the Moment of Resistance for a beam of any section will then resolve itself into a computation of the solid contents and centre of gravity of a pair of wedges. In making this calculation it is evident that the solid contents of each wedge, and also its moment about the axis nn , will be proportional to the inclination that may be arbitrarily chosen for the inclined section b_1d_1 , or to the ratio $\frac{bb_1}{bn}$. This ratio represents the rate at which the stress-intensity increases with increased distance from the neutral axis, and is equivalent to the ratio $\frac{f}{y}$, in which f is the intensity of stress in the extreme fibre and y the vertical distance of that fibre from the neutral axis.

Suppose the inclined section b_1d_1 to be taken at an angle of 45° ; then $bb_1 = bn$, and as the intensity of stress in any fibre will then be measured directly by its distance from the neutral axis, the *moment* of the stress in any fibre will be measured by the sectional area of the fibre multiplied by *the square* of its distance from the neutral axis. The sum of these products (for all the fibres) is the so-called "*Moment of Inertia*" of the beam, and will be represented by the aggregate moments of the two wedges whose surfaces are inclined at the supposed angle of 45° .

The Moment of Inertia is therefore a quantity depending only on the form of cross section, and the calculation of this quantity is a step towards finding the moment of resistance: thus assuming provisionally that the ratio $\frac{bb_1}{bn}$ or $\frac{f}{y}$ is equal to unity, we may first calculate the "Moment of

Inertia" (I) for any given form of cross-section, without reference to any known or unknown value of the stresses; and then to find the moment of resistance, M , we have only to multiply the moment of inertia by the actual value of the ratio $\frac{f}{y}$, or—

$$M = I \cdot \frac{f}{y} \dots \dots \dots (4)$$

Therefore if it is known that the external forces exert a certain bending moment, M , we may find the maximum intensity of stress in the extreme fibre by the expression—

$$f = \frac{My}{I} \dots \dots \dots (5)$$

If we assume that the girder will break when the tensile stress in the extreme fibre is equal to the ultimate strength of the material, and if on this assumption we calculate the breaking weight by means of the above formula, we shall find the result to disagree with experiment exactly as in the case of the rectangular beam. But the extent of the disagreement will depend upon the thickness of the web. The thicker the web the greater is the error; but if the web is made very thin the error becomes very slight, and it vanishes altogether when the girder is made without any web, as it may be if lattice bracing is used in the place of it.

20. Proceeding now to the case of a plate-webbed girder of I section, let it be assumed that the web is so thin that it bears no appreciable share of the horizontal stresses, so that the flanges have to bear the whole of those stresses. This assumption will greatly simplify the question of bending strain, and the distinct functions of the web and of the flanges will then be clearly defined.

In Fig. 26, let $DBSC$ represent a thin-webbed cantilever girder fixed in a wall at DB , and loaded at its extreme end with a given weight W . The opposite horizontal stresses or forces acting at the section DB must, as before, be of equal magnitude; but instead of being distributed over the whole height of the section, they will now be confined to the flanges; and as the thickness or depth of the flanges is very small in comparison with the depth of the girder, the tensile and compressive stresses may be assumed to act in single lines Dr and Bv , at the centre of each flange; and the several forces must then be balanced in the same way as in the right-angled lever of Fig. 4 or the rectangular plate of Fig. 5. Thus, if the point B is taken as an assumed fulcrum or axis of motion, the moment of the weight W about that axis must be balanced by the moment of the tensile stress Dr ; or if the point D is taken as a fulcrum, the moment of W must be balanced by the moment of the compressive stress Bv .

Let l = the length of the cantilever (BC).

d = the depth (DB) measured from centre to centre of the flanges.

$\pm H$ = the horizontal stress in either flange, being a compressive stress in the lower and a tensile stress in the upper flange.

Then the bending moment at the section DB will be $M_0 = Wl$; and dividing this moment by the depth $DB = d$, we have the compressive stress at B or the tensile stress at D , which is required to balance the moment of the weight, or $\pm H_0 = \frac{M_0}{d} = \frac{Wl}{d}$. The *total* horizontal stress is the same in both flanges, and to find the *intensity* of stress in either flange we have only to divide the stress H by the sectional area of the flange in question.

In the same way we may go on to consider the equilibrium of any arbitrary portion of the girder, such as the portion $egSC$ lying to the right of a vertical section eg , whose horizontal distance from the weight W is expressed by the variable quantity x .

The moment of the weight W , either about the point e , or about the point g , will be expressed by the general equation $M = Wx$, and this moment must be balanced by the moment of the tensile stress in the upper flange acting about g as a fulcrum, and must also be balanced by the compressive stress in the lower flange acting about e as a fulcrum; so that the horizontal stress in either flange will be expressed by the general equation $\pm H = \frac{Wx}{d}$, in which x represents the horizontal distance of *any*

point in either flange, measured from the point where the weight W is applied. This equation gives the *horizontal* forces, or flange-stresses, which are required at each point for the equilibrium of the structure, and it will be noticed that the flange-stress increases gradually from S to D , and from C to B . The varying value of the flange-stress may be conveniently represented by a diagram as shown in Fig. 27, but before considering this diagram, it will be well to refer to the *vertical* forces concerned in the equilibrium of the cantilever.

Leaving out of account the weight of the girder, the equilibrium of the whole cantilever requires that it shall be supported by an upward vertical force equal and opposite to the downward force W , and this upward force must, of course, be applied to it at B by the masonry of the abutment. The equilibrium of the portion $egSC$ demands in like manner that it shall be supported by an upward force equal and opposite to W , and the only external body that can apply this force is the contiguous portion of the girder $DBeg$. Therefore at any vertical section eg there is a downward shearing force acting upon the surface to the left of the section, and an upward shearing force acting upon the surface to the right of the section. This action and reaction of the vertical force may, perhaps, be more clearly seen if we suppose the girder to be actually cut

through at *eg*, as shown in Fig. 28. The flanges may be connected by hinged links as shown in the figure, and the transmission of the *horizontal* stresses will then be left unimpaired; but the horizontal action of the flanges will not be sufficient alone to support the weight *W*, unless at the same time an upward force is applied to the body *egSC*, and this force can only be applied by the "lateral adhesion" of the web-plate taking effect somewhere along the vertical plane *eg*.

It will be seen, therefore, that while the horizontal flange-stress increases regularly from *C* to *B*, the vertical shearing-stress has the same value at every section between those points.

21. For many purposes it is very convenient to represent the varying bending moments, or the varying stress in different parts of a girder, by means of a geometrical diagram. Such a diagram, illustrating the variations of stress from point to point of our cantilever, is shown in Fig. 27, which may be taken in the first place as the "Diagram of

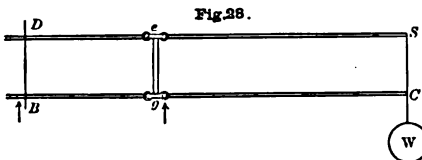
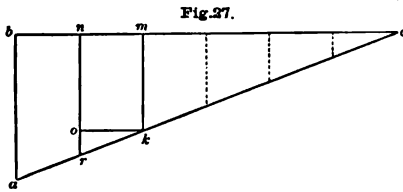
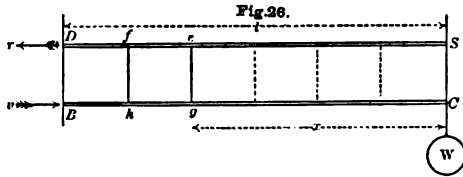

Moments" for the load in question. The horizontal line *bc* represents, on a convenient scale of feet, the length (*BC*) of the cantilever; while the bending moments at the various sections *DB*, *fh*, *eg*, &c., are represented by the corresponding ordinates *ab*, *rn*, *km*, &c. In the present case we have only to deal with a single weight *W*, and the bending moment being simply proportional to the horizontal distance *x*, the diagram will obviously consist of a triangle *abc*, in which the vertical height is everywhere proportional to *x*.

Thus the ordinate *ab* will be drawn to represent on a certain scale of foot-tons the moment $M_0 = Wl$, and by drawing the straight line *ac* the diagram will be completed, and the height of any ordinate *km* will then represent, on the same scale, the bending moment $M = Wx$.

The triangle *abc* will thus be the "Diagram of Moments" for the load in question, irrespective of the depth or figure of the girder. But to find the horizontal flange-stress at any point, we have only to divide the bending moment by the depth of the girder, and in Fig. 26 the depth is uniform throughout. Therefore the flange-stress will vary exactly as the ordinates in the triangle *abc*. Thus, if *ab* is drawn to represent, on a

certain scale of tons, the maximum flange-stress $H_0 = \frac{Wl}{d}$, the height of any other ordinate km will represent on the same scale the flange-stress $H = \frac{Wx}{d}$, which will be a tensile stress in the upper flange e and a compressive stress in the lower flange g .

Making use of the diagram in this sense, consider now the equilibrium of the short piece of upper flange ef , contained between the two sections fh and eg . At e the tensile stress will be represented by the ordinate km , while at f the stress will have the greater value rn . The bar fe is therefore pulled towards the left at f by a *greater* force than that which acts at e pulling it in the contrary direction; and the difference *must* be made up by some other force pulling, or pushing, or dragging it towards the right. The only body which can possibly exert such a force upon the bar fe is the web to which it is attached, and it follows that a horizontal force equivalent to the ordinate ro , or the difference between the ordinates rn and km , must be applied to the bar fe by the lateral adhesion between the upper margin of the web and the contiguous metal of the flange.

Again, if we subdivide the length fe into any number of equal parts, and find (by the same rule) the force which must be applied upon each fractional part, we shall see at once that the force ro does not act upon the flange at any one point, but is uniformly distributed along the whole length fe ; so that equal increments of tensile stress are added to the top flange at each unit of its length.

The tendency of this force between the web and the flange is evidently to shear the one from the other; and the amount of this "shearing force" per unit of length of the upper flange will be measured by the force ro divided by the length fe , and will therefore be proportional to the fraction $\frac{ro}{ok}$, or the tangent of the angle of inclination of the line ac in the stress-diagram. In most cases that occur in bridge-construction, the line of the stress-diagram is a curve, so that the ratio $\frac{ro}{ok}$ varies from point to point; but whatever may be its curvature, the slope of its tangent at any point in the curve, or the trigonometrical tangent of its angle of inclination, will always be a measure of the shearing force exerted per unit of length at that particular point in the girder; and if we take the shearing force exerted per lineal inch, and divide it by the thickness of the web in inches, we shall obtain the intensity of the shearing stress per square inch of horizontal section at the upper margin of the web.

In the case before us, however, the line ac of the stress-diagram is a straight line, so that its inclination is the same throughout, and therefore the shearing force is uniformly distributed along the whole length of the upper margin of the web, while its total amount is evidently equal to the total flange-stress at D ; for at this point we have a force (namely the

maximum flange-stress $\frac{Wl}{d}$) pulling the flange DS towards the left, while at the opposite end S we have no force whatever pulling it towards the right; but from this point the web begins to apply its lateral dragging force, and in each successive unit of length (towards D) adds a corresponding increment to the tensile stress, which thus accumulates by the addition of these successive increments, until at D it reaches the maximum value of $\frac{Wl}{d}$. Thus the whole of the tensile stress in the upper flange is due to the force brought upon it by the web, by means of its lateral adhesion with the flange; and if we examine the equilibrium of the lower flange in the same manner, we shall find precisely the same result, the compression of the flange being entirely due to the force which the web exerts upon it in a direction opposite to that which was found in the case of the upper flange.

22. Consider now the equilibrium of any panel of the web-plate, such as $fehg$ in Fig. 26. The forces exerted by the web upon the upper and lower flanges in the manner above described, are of course accompanied by equal and opposite reactions upon the web itself; thus the panel, at its upper edge, is pulled towards the left by the upper flange with a force which is uniformly applied along the margin fe ; while its lower edge is thrust towards the right by the lower flange with an equal force applied uniformly along the margin hg , as represented by the arrows in Fig. 29.

This "couple," or pair of contrary forces, if acting alone, would exert upon the panel a rotating tendency; and the turning moment of the couple would be measured by the value of either single force multiplied by the depth d , which is the perpendicular distance between their lines of action; and this moment must be balanced by an equal moment tending to turn the panel in the contrary or clockwise direction. Or to put the case in other words—the fact that the web-plate is pulling the top flange towards the right, and thrusting the lower flange towards the left, indicates that it must itself be operated upon by some other forces tending to give it a rotation in a clockwise direction.

We have already seen that, at the vertical section fh , the portion of girder to the left of the section is applying to the left side of the panel a supporting force equal to the weight W , and also that the panel itself must apply at its right side eg a similar supporting force to the remaining portion $egSC$; which means the same thing as saying that the right edge of the panel is subjected to a downward force equal to the weight W . These opposite vertical forces may again be represented by the vertical arrows in Fig. 29, and they will constitute exactly the pair of forces that is required to balance the turning moment of the horizontal forces applied by the flanges.

For if we use the symbol Δx to express the horizontal length of any panel or piece of web fe , the moment of the vertical shearing

forces will evidently be $W \times \Delta x$; and, on the other hand, we shall have the value of each horizontal force, or the stress-ordinate ro in Fig. 27 = $rn - km = W \left\{ \frac{x + \Delta x}{d} - \frac{x}{d} \right\} = W \frac{\Delta x}{d}$, and multiplying this force by the perpendicular arm d , we have the turning moment of the horizontal forces = $W \Delta x$, as before.

This example will serve to show the general character of the so-called "shearing" force. It will be seen that, in the web of a girder, there is no such thing as a shearing force acting in one direction only; on the contrary, any opposite tangential stresses acting along the *vertical* edges of a rectangular plate must be balanced by the contrary moment of a pair of tangential stresses acting along the *horizontal* edges; and these forces will in all cases be proportional to the respective sides of the rectangle—the horizontal shearing force acting along ef , will be to the vertical shearing force acting along eg , as the side ef is to the side eg .

This necessary condition of equilibrium applies also to *every portion* of the plate; and if we divide the panel $fehg$ into any number of square or rectangular compartments, as in Fig. 31, each individual rectangle will be subjected on every side to a shearing force proportional to the length of that side. It follows that the *intensity* of shearing stress is exactly the same along each one of the four sides ef , eg , hf , and hg ; and in the case before us the intensity is the same at every horizontal or vertical section that can be taken through the web anywhere between the weight W and the fixed end of the girder.

As regards the *straining effect* produced upon the rectangular plate $fehg$ by these opposite shearing forces, their tendency is to distort its rectangular figure in the manner shown in Fig. 30, and the extent of the angular distortion, or the fraction $\frac{ee'}{ef}$ is taken as the measure of the shearing strain. Thus the diagonal eh will be shortened, and the diagonal fg will be extended; the shearing stress will produce no extension or compression of the horizontal or of the vertical fibres, but all fibres sloping in the direction eh will be shortened, and all fibres sloping in the contrary direction will be stretched.

It is perhaps permissible to conceive that the resistance which a solid body offers to such a distorting strain, is really due to the direct resistance of its particles to tensile and compressive strains in diagonal directions; at all events it is easy to see that the special function of the web, in transforming vertical forces into horizontal stresses, can be just as well performed by a series of diagonal bars uniting the two flanges and crossing

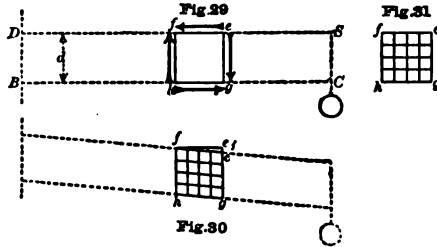

each other, and that in this case each bar would have to exert merely a direct tensile or a direct compressive stress.

23. We may now revert for a moment to the solid rectangular beam illustrated in Figs. 20 and 21; and applying the same reasoning in regard to the equilibrated condition of each portion and each layer of the beam, we shall find the same shearing force in operation but distributed in a very different manner from what we have seen in the case of the thin-webbed girder. Of course, the bending moment in each case is proportional to the distance x , so that the direct stress in the topmost layer of the beam, as in the top flange of the girder, must theoretically increase regularly from S towards D ; and as there is no force at S pulling the layer towards the right, the whole of the tensile stress or straining force at D must be due entirely to the lateral adhesion between this layer and the one below it, whose action at every point between S and D is to drag the top layer towards the right, or to prevent it from sliding back in the manner shown in Fig. 22. This proves in the most conclusive manner that the lateral adhesion does not *alleviate* the tensile stress at D in the manner erroneously supposed by some writers; for its action is evidently exerted in doing exactly the opposite thing.

Again, if we consider the equilibrium of the *two* topmost layers taken together, we find in the same way that the lateral adhesion, or the shearing force between the second and third layers, is answerable for the whole of the tensile stress in the two topmost layers at D , and will, therefore, be nearly twice as great as between the first and second layer—but not *quite* twice as great, because the tensile stress in the second layer is somewhat less than in the first. Thus at each successive horizontal division, from the top of the beam down to the neutral axis, the shearing force will be greater than in the division above it, but greater by a difference which is constantly diminishing.

At the fixed end of the beam, let the varying stresses in the different layers be represented by the horizontal ordinates in Fig. 32;

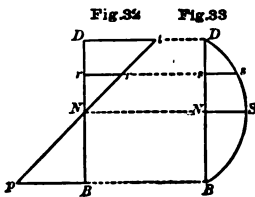

then the shearing force between the several layers will be represented by the corresponding ordinates in Fig. 33, in which every ordinate ss is proportional to the area $Dtrr$ in Fig. 32. Thus if DNt and BNp are similar triangles, the diagram in Fig. 33 will be a parabolic curve; the shearing force will be greatest at the neutral axis (where the direct stress is zero);

and at the top and bottom of the beam, where the direct stress is greatest, the shearing force will be nothing; while its *average* value throughout the depth of the beam will be two-thirds of its maximum value NS . At every vertical section of the beam, the total vertical shearing force must, as in the case of the girder, be equal to the weight W ; its average intensity will, therefore, be $\frac{W}{ab}$, and as its intensity at any

point in that section must be the same as that of the horizontal shearing force, it will have at the neutral axis a maximum intensity of $\frac{3}{2} \frac{W}{ab}$, which will also be the intensity of the horizontal shearing force along the neutral axis.

24. In conclusion, this elementary examination has shown that bending strain takes place in the simple beam, not by a simple but by a complex operation. The direct longitudinal strains illustrated in Fig. 21 do not by any means represent the real condition of internal stress in the beam; on the contrary, these strains could not be produced by the vertical external forces, except through the intervention of that shearing force whose action was most clearly to be seen in the case of the thin-webbed girder. In that girder, the flanges and the web perform two nearly distinct functions, the chief function of the web being to change the direction of the vertical shearing forces. But in the solid beam, every particle combines in itself the separate functions of web and flange, and it is perhaps not surprising that the material behaves in a different manner from that which is observed under a single and direct straining force.

The difference between the actual breaking weight of a beam, and that which theoretically produces the ultimate tensile stress, may perhaps be partly explained by a certain shifting of the neutral axis, which probably takes place to a small extent when the stress exceeds the elastic limit; but this can never account for more than a small part of the discrepancy which is observed in practice, and which has never yet been explained.

The true explanation may perhaps be obtained at some future time; but in the meantime we can only determine the strength of a beam of any given material by direct experiments upon cross-breaking. These experiments seem to show that the ultimate tensile stress on the extreme fibre, at the moment of fracture, varies to some extent according to the figure of the cross-section, being greatest in beams which are very thick at and near the neutral axis. But in beams of similar cross-section the ultimate fibre-stress is nearly the same for all dimensions of beam.

It is satisfactory to know that the ambiguity which we have here noticed, exists only in the case of the simple beam, and that it disappears entirely in the more efficient forms of construction which are now generally adopted for bridge-work.

CHAPTER IV.

THE GRAPHIC REPRESENTATION OF BENDING MOMENTS.

25. Every conceivable form of bridge-construction must possess at least one feature which is common to all bridges alike, viz., that while the load is distributed along the whole length of the bridge, the supports will occur only at certain fixed intervals; so that in all bridges, the vertical lines of action of the several weights and of the contrary supporting forces are separated by considerable horizontal distances, and consequently these forces exert upon the structure certain turning or "bending moments."

The moments of these vertical forces may be conveniently represented by diagrams, and the geometrical figures thus produced will be well worthy of our careful study. They will illustrate very clearly the leading principles of every class of design, whether the structure be a girder, an arch, a suspension-bridge, or any kind of truss; and they will throw some useful light upon the comparative economy of these various types of construction. They will indicate the figure which is given to the bridge itself in certain types and classes of construction; or if the bridge is to consist of straight parallel girders, these diagrams will indicate the *stress* that must be provided for at different points in the girder. Again, if the girder is to be made of uniform *strength* at all points, the diagrams will exhibit the sectional area required at each point, and the mass of metal required in the several members; or, if the girder is made of uniform *section*, they will measure the varying intensity of stress. In the last-named capacity the diagrams will virtually form the groundwork of the theory of deflection, and therefore also of the theory of continuous girders; and in all ordinary cases they present the most valuable information that the engineer can have at his hand for the practical work of designing the outlines and structural details of the bridge.

The diagram representing the moments of the contrary vertical forces, will of course depend only upon the magnitude and distribution of those forces, and will be quite independent of the structural character of the bridge; so that when the distribution of the load and of the supporting forces is known, the diagram of moments will be applicable to any possible form of bridge that can be designed or proposed for the purpose of carrying the given load.

The load will in general consist of two parts—the dead weight of the

structure itself, and the weight of the rolling load or other traffic which the bridge may be intended to carry. But in addition to the actual dead and live load, we must also include, among the downward forces, any artificial load which may be induced at any point in the structure by anchoring it down to a fixed abutment.

The actual amount and distribution of the load must, of course, be carefully estimated in each individual case; but there are certain elementary distributions of load which are most generally taken into account, and the most important cases are—first, when a single concentrated weight is applied at any arbitrary point in the structure, and secondly, when the bridge is covered for the whole of its length, or for any arbitrary portion of its length, by a distributed load of uniform intensity; and these cases will afford a solution for any other case that can arise in practice.

26. CASE I. Diagram of Moments for a Single Force.—In Fig. 34 let *BC* represent a cantilever fixed in a horizontal position by being built into a wall at *B*, and let the cantilever be subjected at *C* to the action of a vertical force *P*. This case has already been considered in Art. 21; and the bending moment which takes effect at any point in the beam is simply the moment (at that point) of the force *P*.

Let *l* denote the length of the cantilever *BC*, and let a vertical section *eg* be taken at any point whose horizontal distance from *C* is denoted by *x*. Then the bending moment at the section *eg* will be

$$-M = Px \dots \dots \dots (1)$$

and the greatest bending moment will of course occur at *B*, where

$$-M_b = Pl \dots \dots \dots (1a)$$

To construct the diagram of moments, Fig. 35, let *bc* represent the length of the cantilever, and at *b* set off the ordinate *bd* to represent, on any convenient scale of foot-tons, the moment $-M_b = Pl$; and draw the straight line *dc*.

Then at any other section *eg* the bending moment $-M = Px$ will be represented by the corresponding ordinate *mk*.

This triangular diagram represents the moments produced by any single force at different horizontal distances (*x*) from its own vertical line of action; and the diagram for every other case may be constructed by

simply superposing the elementary triangular diagrams proper to each of the forces, in such a position that the vertical ordinates can be geometrically added or subtracted, according as the force in question acts in a downward or an upward direction. In the case illustrated the force *P* is a load or downward force, and the ordinates *mk*, *bd*, &c., are accordingly set off downwards below the base line; and in the same way

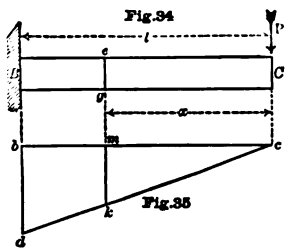

when we have to deal with an upward force acting on the right-hand side of the section *eg* we shall represent its moment by an ordinate measured upwards.

In all cases it will only be necessary to consider the moments of those forces which are applied on one side of the section, because the moments of the remaining forces must necessarily be equal and opposite. We may therefore imagine that the portion of the beam lying to the left of any section is held as a fixture, and we may then consider the moments of the upward and downward forces which are applied on the right-hand side of the section, treating the moments of upward forces as positive, and the moments of downward forces as negative.

27. CASE II. Graphic Summation of the Moments of Parallel Forces.—Let the cantilever *BC* in Fig. 36 be fixed at *B* as before, and subjected to the action of any number of parallel vertical forces applied respectively at the distances $X_1, X_2, X_3,$ &c., from the fixed point *B*. Then the bending moment at *B* will be the sum of the moments due to each force separately; or if the forces are so many loads $P_1, P_2, P_3,$ &c., the moment will be

$$-M^b = \Sigma PX = P_1X_1 + P_2X_2 + P_3X_3 + \&c. \quad (3)$$

To find the moment at any other section *eg* we have first to measure the distances $x_1, x_2,$ &c., from the section in question to each of the weights lying to the right of that section, and the moment will be

$$-M = \Sigma Px = P_1x_1 + P_2x_2 + \&c. \quad (4)$$

and at each new section these quantities will have new values.

But the diagram, Fig. 37, will exhibit at once the bending moments at any and every section; and may be constructed by superposing the triangles proper to each force, as follows:—

Let the verticals $P_1c, P_2p, P_3s,$ be drawn at the line of action of each force, and let the triangular diagram *bdc* be drawn to represent the moments of the force $P_1,$ as in the last example, making *db* equal to the moment $P_1X_1.$ Also set off *df* equal to the moment $P_2X_2,$ and *fr* equal to $P_3X_3;$ and draw the straight lines *fp* and *rs.* Then the polygonal line *rspc* will be the line or diagram of moments for the whole load, and the bending moment at any section *eg* will be given by the corresponding ordinate *mn.* The triangles *frs* and

fdp will be the diagrams for the forces P_3 and P_2 respectively; and in the latter triangle it is evident that the ordinate *kn* (parallel to *df*) will

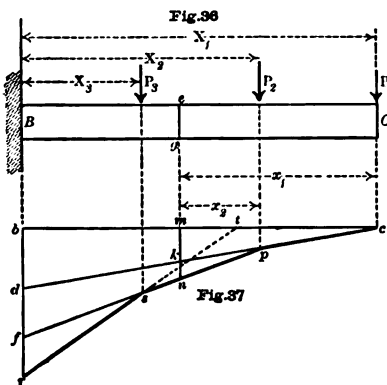

represent the moment P_2x_2 ; while mk represents as in the last example the moment P_1x_1 . Therefore $mn = mk + kn = P_1x_1 + P_2x_2$.

It has already been mentioned that the *inclination* of the line of moments is a measure of the shearing force, and in this diagram it will be noticed that the inclination at any point n is a measure of the total load lying to the right of that point, which is of course equal to the shearing force at the section *eg*. That is to say, if θ denotes the angular inclination of the line with the horizontal, then $\tan. \theta$ is equal to the shearing force. Thus at any point between p and c , the shearing force is equal to the load P_1 , and $P_1 \triangleq \frac{bd}{X_1} = \tan. \theta$; again at any point between s and p , the shearing force is $P_1 + P_2 \triangleq \left(\frac{bd}{X_1} + \frac{df}{X_2}\right) = \tan. \theta$.

Therefore at r the inclination of the line of moments must always be a measure of the whole load upon the cantilever; and if the line rs is continued until it intersects the base-line bc , the point of intersection t will indicate the position of the centre of gravity of the whole load; so that if the whole load were concentrated at its centre of gravity, the triangle brt would be the diagram of moments.

For $br = \Sigma PX$, and $\frac{br}{bt} = \tan. \theta = \Sigma P$; therefore bt is the distance from b to the centre of gravity of the whole system of weights, and represents the algebraic fraction $\frac{\Sigma PX}{\Sigma P}$.

28. CASE III. Moment of a Uniformly Distributed Load.—A load uniformly distributed may be considered as equivalent to a number of equal weights placed along the cantilever at equal and very short intervals, so that this is only a particular example of the last case, and may be treated in the same way.

In practice, the distributed weight of the bridge-platform is very generally conveyed to the girder by cross-girders fixed at uniform intervals, as shown in Fig. 38 at S_1, S_2, S_3 , &c. The weight (P) of each panel of the floor may be supposed to be carried by short intermediate detached bearers, which will transfer one half of the panel-weight to each end of the panel. Thus the load on the

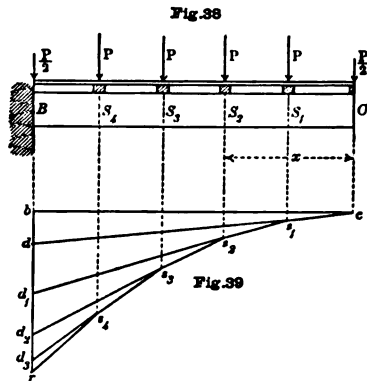

extreme cross-girders at B and C will be equal to $\frac{P}{2}$, but on each of the intermediate cross-girders the load will be equal to the panel-weight P .

The value of the several forces being thus determined, the diagram of moments, Fig. 39, may be constructed in the same way as in the last

example, and will form a polygonal line $c, s_1, s_2, s_3 \dots r$, as shown in the figure; and it will be found that every one of the points, $s^1, s^2, \&c.$, is situated in a parabolic curve whose vertex is at c ; so that the line of moments is a polygon inscribed in that parabolic curve. In fact, the method of constructing the diagram of moments for this case is one of

the methods by which any number of points in a parabolic curve may be traced.

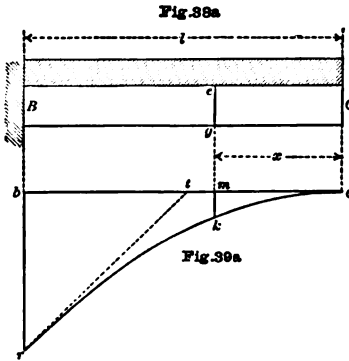

If we now suppose the cross-girders to be fixed at much shorter intervals, thus subdividing the load into proportionately smaller elements, it is not difficult to see that the polygonal line of moments will approximate still more closely to the true parabolic curve cr , as in Fig. 39A, which is the diagram of moments for a load uniformly distributed along the cantilever.

If a tangent rt is drawn to the parabolic curve at r , it will intersect the base-line bc in the middle of its length, which point coincides, of course, with the centre of gravity of the whole distributed load.

Let p denote the intensity of the load per foot lineal, or per unit of length, so that pl is the weight of the whole distributed load. The distance (bt) to the centre of gravity of that load is $\frac{l}{2}$; and therefore the moment at B is

$$- M_b = \frac{pl^2}{2} \dots \dots \dots (5)$$

In the same way, if x denotes the horizontal distance of any section from the extreme end C of the loaded cantilever, the moment at that section will be given by the general expression—

$$- M = \frac{px^2}{2} \dots \dots \dots (6)$$

It is evident that this expression will also give the value of the bending moment at any section taken at the point of attachment of either cross-girder in Fig. 38.

In either case the shearing force at any point in the cantilever will be the sum of the weights lying to the right of the section. In Fig. 38 this force receives a certain increment at each cross-girder, as shown by the sudden alteration of slope at each angle of the polygon in Fig. 39. But in Fig. 38A, the shearing force will be simply denoted by px ; and according to the well-known property of the parabola, this quantity will

be represented by the slope of the curve in Fig. 39A, or $\tan. \theta$. Thus at *B* the shearing force will be $pl \triangleq \frac{br}{bt} = \tan. \theta$.

There are several geometrical methods of describing the parabolic curve of Fig. 39A, but in practice there is nothing simpler than to set off a convenient number of ordinates below the tangent *bc*, making *mk* equal to $\frac{px^2}{2}$ in each case.

29. Any irregular load upon the cantilever may be treated in the same way by superposing the diagrams proper to each portion of the load.

CASE IV.—Let the cantilever in Fig. 40 be covered with a uniform load of intensity *p*, and at the same time weighted at the extreme end by a concentrated load *P*. Then to construct the diagram of moments, Fig. 41, make the triangle *dbc* to represent the moments of the force *P* as before, and treating *dc* as a new base-line, set off below that tangent the

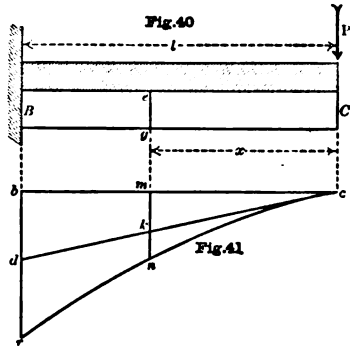

ordinates *kn* equal to $\frac{px^2}{2}$. The parabolic segment *cnr* will then be the curve of moments, and at any section *eg* the bending moment will be

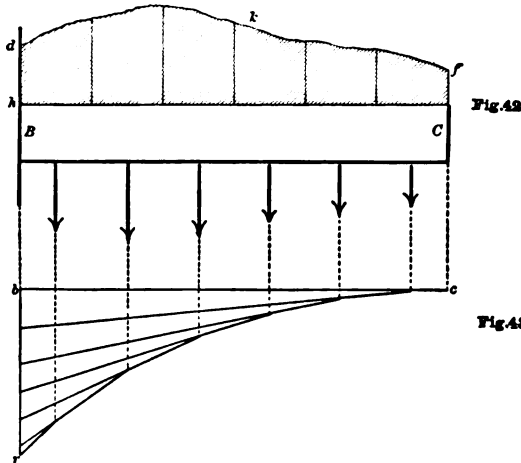

given by the ordinate $mn = mk + kn$; or expressing the same thing algebraically, we have generally

$$-M = Px + \frac{px^2}{2} \dots \dots \dots (7)$$

and at *B* the moment will be

$$- M_b = Pl + \frac{pl^2}{2} \dots \dots \dots (8)$$

The shearing force is represented in the diagram as before, and is algebraically expressed by $P + px$.

CASE V.—If the cantilever is loaded with any irregular mass, as indicated by the figure *dkfh* in Fig. 42, the case may be treated on the same principles if we divide the mass into thin vertical slices. The weight of each slice will be represented by its area in the figure, and its centre of gravity may be taken as coinciding sensibly with the centre of the slice. The diagram Fig. 43 being then constructed as before, the polygonal line *cr* will form a series of tangents to the actual curve, and will practically coincide with that curve if the slices are taken sufficiently thin.

30. **Graphic Summation of the Moments of Contrary Forces.**—The diagram of moments has hitherto been traced only as far as the abutment wall in which the cantilever is supposed to be fixed; but it is evident that beyond this point there must be other forces and bending moments in operation; for if we regard the beam as a lever in equilibrium, it must evidently be held down at the “tail-end” by a weight sufficient to counter-balance the load upon the projecting arm, and it must be supported by a force equal to the sum of all the downward forces. In all cases the diagram is correct as far as it goes, but it is necessary now to complete the diagram to the left of the point *B*.

CASE VI.—Let the cantilever be supported at *B* as in Fig. 44, and held down at the point *A* by an anchorage fixed in the masonry. The downward force P_a , applied by the anchorage, may be found algebraically by equating the moments about the fulcrum *B*, which must of course balance each other; thus if the external load is a single weight P_c , the anchorage-force will be $P_a = P_c \times \frac{l_2}{l_1}$; and the bending moment at the section *eg* will then be given by $-M = P_a z$, the distances l_1 , l_2 , and z being measured as shown in the figure.

But the geometrical method is simpler, and the diagram of moments may be completed without calculating the unknown force P_a . In Fig. 45 let *bdc* represent the diagram for the external load (whatever it may be), and continuing the base-line, make *ba* to represent the length of the arm *BA*, and join *ad*. The diagram will then be complete for the whole length of the balanced cantilever, and the bending moment at any section *eg* will be given by the ordinate *mk*. For it is evident that if *bd* represents the moment exerted at *B* by the forces applied to the right of that point, it must also represent the contrary moment of the force P_a , whatever may be its unknown magnitude, and therefore the triangle *abd* must be the diagram of moments for that unknown force.

But it will be noticed that this method of calculation or construction reverses the previous order; for we have considered the arm AB as a cantilever fixed at B , and loaded at its *left* extremity; and it will be more consistent to adhere to the general rule, and to determine, at every section throughout the beam, the moments of all forces applied *on the right-hand side* of the section.

At the section eg , therefore, we have the moment of the weight P_c acting at the horizontal distance x_1 , and from this we have to subtract the moment of the upward force P_b acting at the distance x_2 .

The supporting force P_b may be found by equating the moments about A as a fulcrum; or algebraically, $P_b = P_c \cdot \frac{L}{l_1}$, and then the bending moment at eg will be expressed by $-M = P_c x_1 - P_b x_2$.

But the diagram of moments may be constructed on the same principle, and without calculating the unknown force P_b . For if the

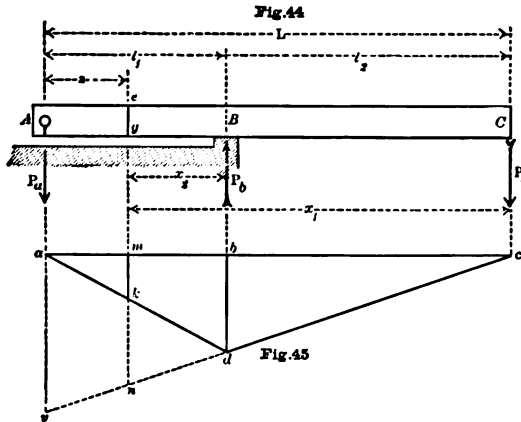

straight line cd is continued to v , the triangle avc will be the entire diagram of moments for the force P_c , and the moment av must be balanced by the moment of the force P_b ; therefore joining ad , the triangle vad will be the diagram of moments for the upward force P_b , the ordinates nk , &c., being measured upwards from vd , and subtracted from the ordinates mn , &c.

Thus the bending moment at eg will be given by the ordinate $mk = mn - nk$, or $-M = P_c x_1 - P_b x_2$. The bending moments are of the same negative character throughout the entire length of the beam, and their tendency is everywhere to produce a hogging curvature.

31. CASE VII. Beam supported at each End and Loaded with a Single Weight.—If the beam AC is now supported at A and C , as in Fig. 46, and loaded at B with the single weight P_b , the case will be the exact converse of that which has just been considered. For if we disregard the merely instinctive ideas connected with gravitation, and look at the

diagrams, Figs. 44 and 46, as ground-plans of a beam under the action of lateral forces P_a , P_b , and P_c , we shall see at once that the two cases are really identical.

If the forces are merely reversed in direction, and unaltered in magnitude, the bending moments must, of course, have the same value as before, but will be of the opposite character; i.e., they will tend to produce a curvature of the beam which (in the elevation) would be described as a sagging curvature.

The diagram of bending moments, Fig. 47, will therefore be precisely similar to Fig. 45, and would be constructed in the same way as before if the force P_c were known; but in practice the weight of the load P_b is generally the only force known, and the value of P_c is found

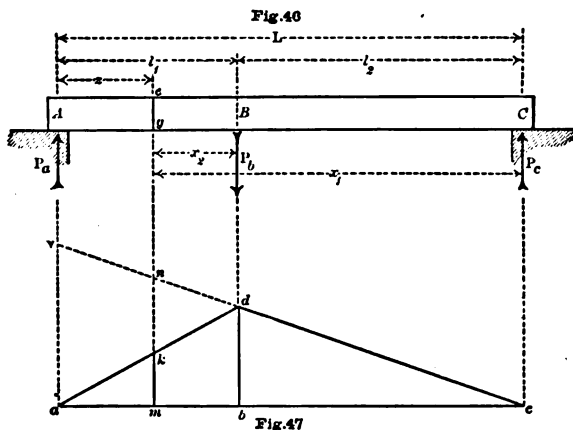

algebraically by equating the moments about A as a fulcrum. Thus $P_c L = P_b l_1$, and $P_c = P_b \frac{l_1}{L}$. In Fig. 47 let the verticals Aa , Bb , Cc , represent the lines of action of the three forces; and at a set off the upward ordinate av to represent the positive moment of the upward force P_c ; making av equal to $P_c L = P_b l_1$. Draw vc intersecting the vertical Bb in d , and join ad . Then the triangle adc will be the diagram of moments, and the bending moment at eg will be given by the ordinate $mk = mn - nk$,

$$\text{or } M = P_c x_1 - P_b x_2 \dots \dots \dots (9)$$

The greatest bending moment takes place at B ,

$$\text{where } M_b = P_c l_2 = P_b \cdot \frac{l_1 l_2}{L} \dots \dots \dots (10)$$

32. If the weight P_b , in the last example, is placed successively at different points b_1 , b_2 , b_3 &c., along the beam, the diagram of moments will assume successively the form of the several triangles ad_1c , ad_2c , &c., in Fig. 48. Each triangle is constructed by setting up the ordinates av_1 , av_2 ,

&c., proportional to the distances ab_1 , ab_2 &c., *i.e.*, proportional to the moment $P_b l_1$. Then completing the triangles as before described, it will be seen that the apex d is always situated in a parabolic curve ad_3c , whose vertex is at the centre of the beam. In fact the method of construction is one of the known geometric methods by which that curve may be described.

It will be seen that at any given point in the beam, the greatest bending moment occurs when the weight is placed at that point; and if

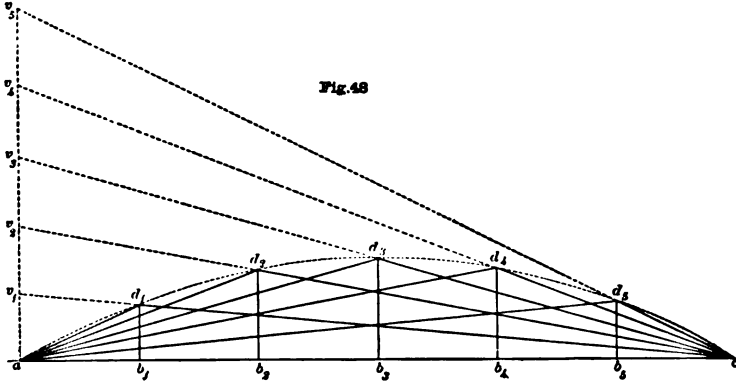

the beam is intended to carry a single weight rolling across it, the greatest bending moment will take place at the centre, where we have—

$$M_o = P_c \cdot \frac{L}{2} = P_b \cdot \frac{L}{4} \quad \dots \dots \dots (11)$$

At any other point, the greatest bending moment will be—

$$M = P_c l_2 = P_b \cdot \frac{l_1 l_2}{L} \quad \dots \dots \dots (12)$$

33. CASE VIII. Beam Loaded with two or more Weights and supported at each End.—Let the beam AC in Fig. 49 be loaded with two or more weights P_1 , P_2 &c., placed at the distances X_1 , X_2 &c., from the left abutment.

Then at each section eg the bending moment will be the algebraical sum of the moments of all forces applied to the right of that section, or—

$$M = P_c x - (P_1 x_1 + P_2 x_2) \quad \dots \dots \dots (13)$$

The supporting force P_c is found as before by balancing its moment at A against the moments of the downward forces, or—

$$P_c L = P_1 X_1 + P_2 X_2$$

Draw the verticals Aa , $B_1 b_1$, &c., as before, and in the diagram of moments, Fig. 50, set off the upward ordinate av to represent the moment of the upward force P_c , making $av = P_c L = P_1 X_1 + P_2 X_2$; also make

$vf = P_1X_1$ and $fa = P_2X_2$. Then drawing vc , we have the triangle avc denoting the moments of the upward force P_c , and giving at the section eg the moment mn due to that force. Join fp and as ; and the polygonal figure $aspc$ will be the diagram of moments.

The triangles vfp and fas will represent the moments of the downward forces P_1 and P_2 respectively, and their ordinates being measured

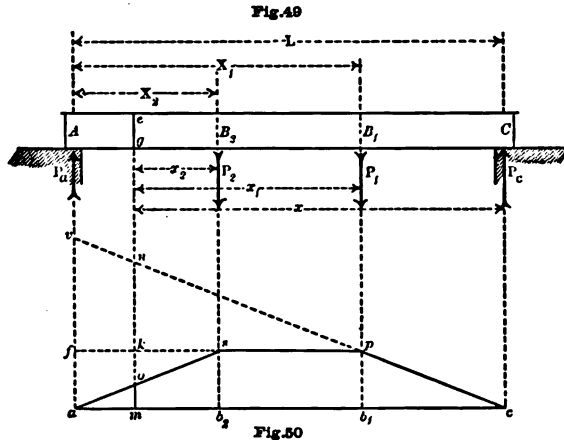

downwards or subtracted from the positive moments $P_c x$, the bending moment at any section eg will be given by the ordinate $mo = mn - (nk + ko)$ or $M = P_c x - (P_1 x_1 + P_2 x_2)$.

The same method may evidently be extended to any number of weights placed between A and C .

34 CASE IX. Beam covered with a uniform Load and supported at each End.—This important case may be treated by an extension of the method last described.

In the first place let the uniform load be conveyed to the main girders by cross-girders fixed at uniform intervals, as shown in Fig. 51 at S_1, S_2 , &c. Then, P being the weight or distributed load on each panel, the load on the extreme points A and C will be $\frac{P}{2}$, but the downward force at each intermediate point (or cross-girder) will be equal to the panel-weight P .

The upward supporting force P_c will be found as before by balancing the moment of all the downward forces about A , against the moment $P_c L$; and it is evident that P_c will be equal to half the entire load.

In the diagram of moments, Fig. 52, make $av (= P_c L)$ to represent the moment of the upward force P_c ; and drawing vc , the triangle avc will be the diagram of moments due to that force alone.

Then subtract the moments of the downward forces, by setting off the

triangles vd_c , dd_1s_1 , &c., in the manner already described in Art. 28, and the polygonal line $cs_1s_2 \dots a$ will be the line of moments.

The first triangle vd_c will represent the moments of the load $\frac{P}{2}$ applied to the girder at C ; but if that load is carried directly by the masonry abutment and not by the main-girder, the supporting force P_c , acting upon the underside of the girder, will of course be reduced by the same amount; and in that case the triangle adc will be the diagram for the upward force P_c and the first triangle of moments to be subtracted will then be the triangle dd_1s_1 for the load at S_1 . It is evident, therefore, that whether the extreme load $\frac{P}{2}$ is carried at C by the main girder or by the abutment itself, the diagram of moments will be the same in either case.

All the angles of the polygon will be situated in a parabolic curve as_1c , whose vertex is at the centre of the beam; and the shorter we make the intervals between the cross-girders, the more closely will the polygonal line of moments approximate to that curve.

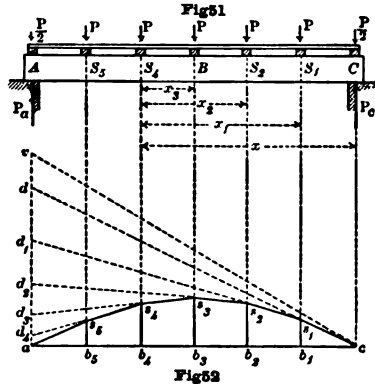

Let the cross-girders be now placed close together, so that the beam AC is uniformly loaded along its whole length, as in Fig. 51A; and let the intensity of load per unit of length (or per foot lineal) be denoted by p , so that the weight of the whole load is pL . Then it is evident that one-half of this load will be carried by each abutment; and the supporting force P_c is therefore equal to $\frac{pL}{2}$, while its moment at A will be

$$P_c L = \frac{pL^2}{2}.$$

At any section eg whose distance from C is denoted by x , the moment of this upward force will be $P_c x = \frac{PLx}{2}$; but the weight of the distributed load lying to the right of this section will be px , and the horizontal distance to its centre of gravity will be $\frac{x}{2}$, so that the moment of that distributed load will be $\frac{px^2}{2}$. Therefore the bending moment at the section eg will be—

$$M = P_c x - \frac{px^2}{2} = p \frac{x(L-x)}{2} \dots \dots \dots (14)$$

The greatest bending moment takes place at the centre of the span, where $x = \frac{L}{2}$, and where

$$M_b = \frac{pL^2}{8} \dots \dots \dots (15)$$

At *A* the bending moment is of course nothing, for at this point the moments of the upward and downward forces are balanced.

In the diagram of moments, Fig. 52*A*, draw *av* to represent the moment of the upward force P_c , making $av = P_c L = \frac{pL^2}{2}$; and drawing *vc* the triangle *avc* will be the diagram due to the single force P_c acting upon a cantilever fixed at *A*. Then subtract the contrary moments of the

uniform load acting upon the same cantilever, as described in Art. 28, i.e., below the tangent *vc* set off the parabolic diagram of downward moments *vasc*, making every ordinate *nk* equal to the moment $\frac{px^2}{2}$

(as in Fig. 39*A*). The parabolic segment *ascb* will be the required diagram of moments; and the bending moment at any section *eg* will be given by the ordinate $mk = mn - nk$; or $M = P_c x - \frac{px^2}{2}$.

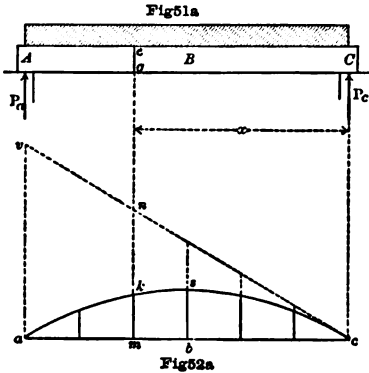

The shearing force is indicated, as in every diagram, by the slope of the curve. At each section the vertical shearing force acts in an upward direction on one side of the section, and a downward direction upon the other side; the two opposite actions being, in fact, the action and the reaction of the same dragging force exerted between the meeting edges of the web-plate. The upward or downward inclination of the curve towards the left indicates the upward or downward force acting, at any section, upon the vertical edge of web-plate to the left of the section; and vice versa. Thus at *C* the shearing force is equal to the upward force $P_c = \frac{av}{ac} = \tan. \theta$. At any other section the shearing force (upwards on the left edge) is given by $P_c - px$; thus at the centre of the span the shearing force is nothing, and beyond this point it reverses its direction, as shown by the inclination of the curve of moments.

35. If a section is taken at any one of the panel-points such as S_1 in Fig. 51, it will be seen that the bending moment at that section is not at all affected by the manner in which the length *x* may be subdivided by the intervening cross-girders. With a uniform load of given intensity *p*, the supporting force P_c must always have the same value; and whatever

may be the number and position of the cross-girders between S_1 and C , the moments of the downward forces to the right of S_1 must always have the value $\frac{Px^2}{2}$. For the weight P of any entire panel S_1S_2 will be equally divided between the points S_1 and S_2 , and the sum of the moments of the two halves will always be equal to the moment of the whole load P distributed over the panel.

It follows that we may divide the span AC into any number of equal or unequal panels, and in every case the diagram of moments will be a polygon, having a corresponding number of sides, and inscribed in the same parabolic curve.

Thus the bridge may be constructed by dividing the span into two equal panels, AB and BC , the floor being carried by detached bearers resting upon a central cross-girder at B .¹ Then if the curve asc , in Fig. 53, represents the parabolic diagram of moments for the uniform load, the diagram for the panelled bridge will be the triangle asc , inscribed in that curve; and the bending moment bs , in the centre of the span, will be exactly the same as though the uniform load were spread along the main-girders, although the actual load carried by the girders will be only one-half of the total distributed load.

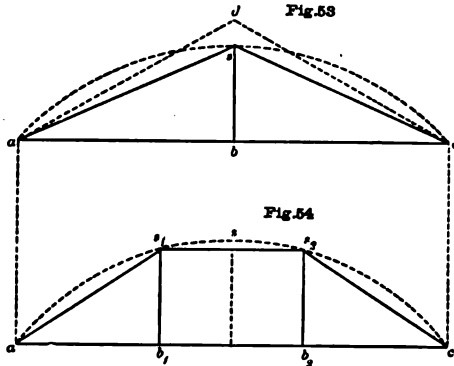

In the same way, if the bridge is divided into three equal panels, the diagram of moments will be the polygonal figure as_1s_2c of Fig. 54, inscribed in the same parabolic curve, asc .

It appears, then, that this method of dividing the span into wide panels, although it reduces the load on the main-girders, does not really alleviate the bending stress, except to a small extent between the panel-points; and even here, it may be remarked, that if we have to carry a given uniform load, the bending stress represented by the parabolic curve, must at every point be resisted in some way, if not by the main-girders. Thus the segmental diagrams s_1s_2 , &c., contained between the curve and the sides of the inscribed polygon, represent in the panel-bridge the respective diagrams of bending moments for the several intermediate longitudinal bearers b_1b_2 , &c., considered as detached beams.²

¹ It will be remembered that we are considering only the moments due to some external load (in this case a uniformly distributed load) placed upon the floor of the bridge; and not the moments due to the weight of the bridge itself.

² If the intermediate longitudinals are formed as continuous girders, they will bring upon the central cross-girder (in the case represented in Fig. 53) a load greater than half the entire load. The diagram of moments for the main-girders will then be the triangle

36. CASE X. Beam strained over one of the Supports.—If the beam *AC* is not merely supported at the ends, but is strained over one of the piers, as shown in Fig. 55, the action of the external load or force at *D* may be considered separately, and the moments due to its separate action may be added to or subtracted from the moments produced by any load upon the span *AC*.

Suppose the beam to be prolonged beyond the pier *C*, and in the first place let the projecting arm or cantilever *CD* be loaded at the extreme end with a single weight P_d . It has already been shown in Art. 30 that if there is no other load placed upon the beam, the diagram of moments will be the triangle *agd* in Fig. 56, in which the ordinate *cg* represents the moment of the right-hand force P_d , and also the counterbalancing moment of the downward force which must, in that case, be applied by the anchorage at *A*.

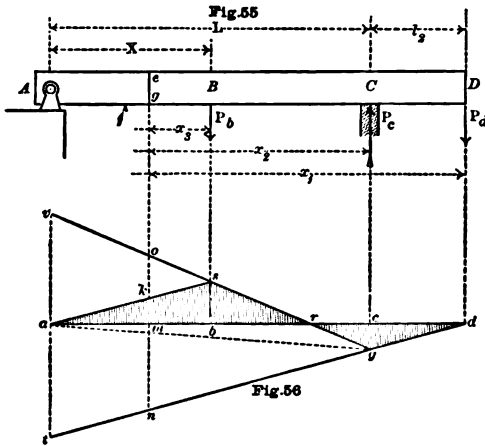

The beam being in this condition, if the span *AC* is now loaded with a single weight, or with any system of weights, the diagram of moments due to that system of weights upon the detached span *AC* may be superposed upon the line *ag* as a new base-line, and the curve of

moments being thus constructed, the bending moment at any point will be given by the ordinate measured above or below the original base-line *acd*.

If the span is loaded with a single weight P_b , as in the figure, the diagram for the detached span will be the triangle *asg* in Fig. 56, and the bending moments for the actual case of the strained beam will be given by the ordinates in the shaded diagram.

To treat the case algebraically we must first find the value of the supporting force P_c . At the fulcrum *A*, the moments of the three forces must balance each other; *i.e.*, $P_c L - (P_d [L + l_2] + P_b X) = 0$, or $P_c L = P_d (L + l_2) + P_b X$; and P_c being thus determined, the bending moment at the section *eg* will be

$$M = P_c x_2 - (P_d x_1 + P_b x_3) \dots \dots (16)$$

In the diagram of moments, considering first the balance of moments at *A*, the ordinate *at* represents the moment $P_d (L + l_2)$, while *va* represents *adc*, and the spaces contained between the sides of that triangle and the parabolic curve will represent the positive and negative moments in the continuous intermediate bearers.

sents, as before shown, the moment $P_b X$. Therefore tv must be the moment $P_c L$ of the unknown supporting force at C ; and joining vg and as , the line $asrgd$ will be the line of moments, and the bending moment at eg will be given by $mk = no - (mn + ok)$.

From a to r the moments are positive or sagging moments, and from r to d they are negative or hogging moments, r being the point of contrary flexure of the beam. But in some cases the diagram may lie wholly below the base-line, so that the beam may be subject to a negative bending moment at every point. This question will depend upon the direction of the force applied to the beam at A , which again will depend upon the relative magnitude of the loads P_b and P_c . If P_c is an upward force, the line as will have an upward inclination towards the right, and some portion of the span AC must then be subject

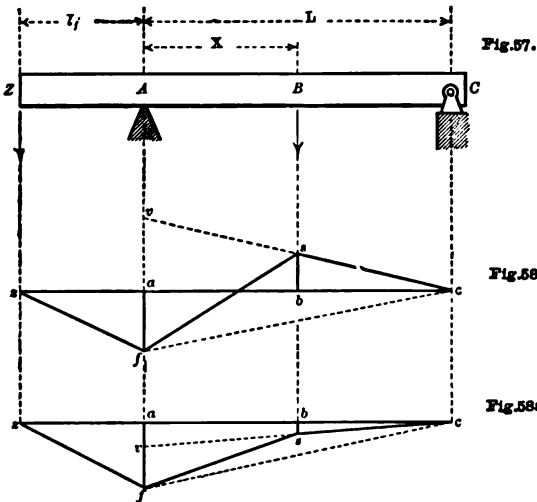

to a positive moment; but if P_c is a downward force, the whole length of the beam will be subject to a negative bending moment.

This will be easily seen if we turn the beam end for end, as shown in the diagrams, Figs. 57 and 58. Referring to these diagrams, it will be seen that the unknown forces cannot be found by equating the moments about Z ; but if we consider the beam as a lever balanced upon the fulcrum A , and weighted on each side by the loads P_a and P_b , it will be evident that to preserve the equilibrium of the lever, the vertical force at C must either be an upward or a downward force, as may be required in order to redress the balance.

In Fig. 58, let the triangle afz represent the moments due to the weight P_a upon the left-handed cantilever AZ , making af equal to the moment $P_a l_1$. Then if vf represents the moment $P_b X$, the ordinate av

will be the moment of the unknown force that must be applied at *C* to redress the balance ; and joining *vc* and *fs*, the line *zfs* will be the line of moments.

If *vf* is greater than *af*, or if $P_b X$ is greater than $P_c l_1$, as in Fig. 58, the ordinate *av* will be an upward or positive ordinate, and the force P_c will be an upward force ; its value being $P_c = \frac{P_b X - P_c l_1}{L}$; but if *vf* is less than *af*, or $P_b X$ less than $P_c l_1$ the ordinate *av* will be measured downwards as in Fig. 58A, and the force P_c will be a downward force, which must be applied by an anchorage ; its value being $P_c = \frac{P_c l_1 - P_b X}{L}$.

In the latter case it is evident that the bending moments will be negative throughout the beam.

In either case, the upward or downward inclination of the line *cv* will represent the shearing force P_c ; and in either case the diagram might have been constructed by erecting upon the base-line *fc* the triangular diagram of moments *jsc* for the beam *AC*, considered as a detached span.

37. CASE XI. Beam strained over both Piers.—If the beam is prolonged on each side beyond the piers *A* and *C*, and if the projecting arms *AZ* and *CD* are each loaded at their extreme ends, as in Fig. 59, the supporting force P_c must be determined, as in the last case, by balancing the contrary moments at the fulcrum *A*. At this point, we know that the negative bending moment will be $-M_a = P_c l_1$; and the sum of the

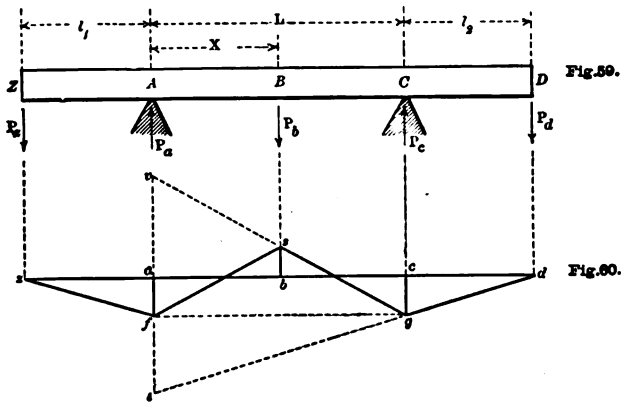

moments of the three forces to the right must have the same value, or $P_a(L + l_2) - P_c L + P_b X = P_c l_1$.

In Fig. 60, let *afz* be the triangular diagram of moments for the left-handed cantilever *AZ*, so that *af* represents the negative bending moment $P_c l_1$, and let *at* represent as before the moment $P_a(L + l_2)$. The next force is the supporting force P_c , whose value is not known ;

but above the point *f*, set off *vf*, equal to the known moment $P_b X$; then *tv* must be the moment of the force P_c . For as above,

$$P_c L = P_a (L + l_2) + P_b X - P_l l_1,$$

$$\text{or } tv = at + vf - af.$$

Therefore draw *vg* to complete the triangle of moments *tv**g* for the upward force P_c ; and draw *fs* to complete the triangle *vfs* for the downward force P_b . The line *zfs**gd* will then be the line of moments.

If there had been no load upon the span *AC*, the diagram of moments for the two external loads would have been the line *zfgd*, and the diagram for the actual case may be constructed by erecting upon the line *fg* the triangular diagram of moments *fs**g* for the loaded beam *AC*, considered as a detached span.

38. CASE XII. Beam uniformly Loaded, and Strained over one Pier.—Let the beam *ZAC* in Fig. 61 be loaded at the left extremity with the weight P_a , so that the triangle *zfc* is the diagram of moments

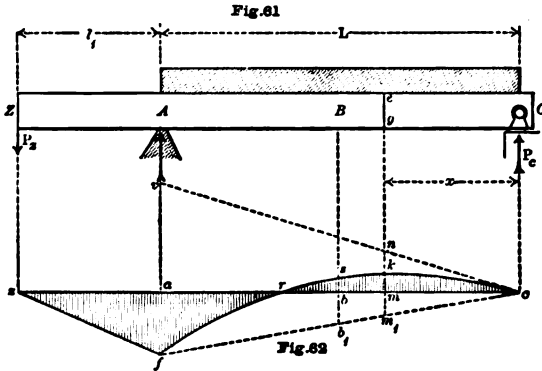

due to that load when counterbalanced at *C* by an anchorage; and if now the span *AC* is covered with a uniform load of intensity *p*, the moments will be determined upon the same principle as before, and the diagram of moments, Fig. 62, may be constructed by erecting upon the line *fc* the parabolic segment *fsc* as for a detached span, making the central ordinate $b_1 s$ equal to the moment $\frac{pL^2}{8}$, and generally making $m_1 k$ equal to

$p \cdot \frac{x(L-x)}{2}$. The bending moments for the actual case will then be given by the ordinates in the shaded diagram, measured above or below the horizontal base-line *zac*.

Considering the beam as a lever balanced upon the fulcrum *A*, the equation of moments will be expressed algebraically by—

$$-M_a = P_l l_1 = \frac{pL^2}{2} - P_c L.$$

In the diagram, vf represents the moment $\frac{pL^2}{2}$ of the uniform load lying to the right of A , and therefore av represents the moment of the unknown vertical force applied at C .

$$\text{For } P_c L = \frac{pL^2}{2} - P_z J_1,$$

$$\text{or } av = vf - af.$$

The vertical force at C will be either an upward or a downward force, according as vf is greater or less than af ; in the first case, the bending moments will be partly negative and partly positive, as shown in the figure; but in the second case the parabola will lie wholly below the base-line ac , and the moments will everywhere be negative.

The triangle avc represents, of course, the moments of the upward force P_c ; and subtracting the downward ordinate nk , &c., equal to $\frac{px^2}{2}$, the remainder, mk , is the bending moment at the section eg . That is $mk = mn - nk$, or $M = P_c x - \frac{px^2}{2}$. This last algebraical formula must be true in any case, whatever load may be applied at Z ; but the value of the force P_c will depend upon the load P_z .

The diagram shows how the bending moment at any point in the beam may be made to vary by applying a variable weight at Z , the moment of that weight (at the pier A) being represented by any variable ordinate such as af or vf .

Thus, first, if $P_z = 0$, the beam will be merely supported at A , and the bending moment will be $m_1 k$ measured above the line fc .

Again, if P_z is great enough to exert the moment vf , balancing the whole distributed load, the beam will be a balanced cantilever, and the bending moment will be nk measured below the line vc .

But if P_z has some intermediate value producing the pier moment af , the bending moment at any other point will be mk , measured above or below the line ac .

In the first case the supporting force P_c will be equal to half the entire load, or $\frac{pL}{2}$; in the second case it will be nothing; and generally

the upward force P_c will be less than $\frac{pL}{2}$ by the amount of the anchorage force which would have to be applied at C to counterbalance the weight P_z ; i.e., the upward force will be $P_c = \frac{pL}{2} - \frac{M_a}{L}$. The bending moment at any section eg may, therefore, be expressed by

$$M = P_c x - \frac{px^2}{2} = \frac{pLx}{2} - M_a \frac{x}{L} - \frac{px^2}{2} = p \frac{x(L-x)}{2} - M_a \frac{x}{L} \quad (17)$$

$$\text{or } mk = mn - nk = m_1 n - mm_1 - nk = m_1 k - mm_1.$$

39. CASE XIII. Beam uniformly Loaded and Strained over both Piers.—This case, which is illustrated in Figs. 63 and 64, may also be treated by adding or subtracting the moments due to the several forces, or summing the moments due to the several loads and their reflex actions at the two supports, and the summation may be effected by different algebraic or geometric methods.

If the extreme loads P_a and P_d are considered first, the diagram of moments for the beam under this load will be the figure $zfgd$; and then whatever may be the distribution of load upon the span AC , if we erect upon the base fg the corresponding diagram of moments fsq , as for a

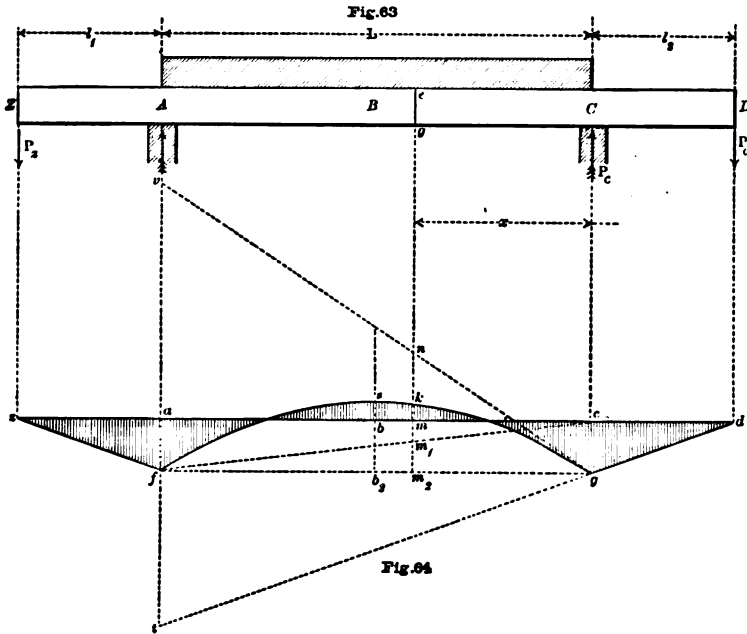

detached span, the moments for the whole system of weights will be given by the ordinates in the shaded diagram.

For the uniform load upon AC , we may, therefore, make the central ordinate b_2s equal to $\frac{pL^2}{8}$, and each remaining ordinate m_2k equal to

$p \frac{x(L-x)}{2}$, and the parabola fsq will be the required line of moments.

This is perhaps the simplest method, but we may arrive at the same result by other means.

Considering the balance of moments at A , we have—

$$-M_a = P_a l_1 = P_d(L + l_2) - P_c L + \frac{pL^2}{2}.$$

In Fig. 64, af is the moment $P_a l_1$, and at is the moment $P_a(L + l_2)$. Then making vf equal to the known moment $\frac{pL^2}{2}$, the ordinate tv will represent the moment of the unknown force P_c , as already demonstrated in Art. 36. Therefore draw vg to complete the triangle of moments $tv g$ for the upward force P_c ; and below vg set off the ordinates nk , &c., equal to $\frac{px^2}{2}$. The parabolic curve fg will be the required line of moments.

In this diagram cg represents, of course, the pier moment at C due to the external load P_a ; and if we join fc as in the last example, we shall have $m_1 m = M_a \frac{x}{L}$; and in precisely the same way we have $m_1 m_2 = M_c \frac{L-x}{L}$; in fact, the latter ordinate represents the negative moment superadded by the imposition of the weight at D , just as the former represents a similar moment caused by the weight at Z . Therefore if we know the value of the pier moments af and cg , we may measure the bending moment at any section eg by the ordinate

$$mk = m_2 k - m m_1 - m_1 m_2$$

$$\text{or } M = p \frac{x(L-x)}{2} - M_a \frac{x}{L} - M_c \frac{L-x}{L} \quad \dots (18)$$

So far as the span AC is concerned, it matters nothing whether the pier moments M_a and M_c are really produced by single weights, as shown in the figure, or whether they are caused by any other loads or forces external to the span.

PART II.

THE GENERAL PRINCIPLES OF BRIDGE- CONSTRUCTION.

CHAPTER V.

THE COMPARATIVE ANATOMY OF BRIDGES.

40. The art of bridge-building, like other branches of architecture, has assumed from age to age a great variety of forms which have been successively evolved or modified under the influence of new conditions; and it would no doubt be interesting to trace the history and progress of their development. However, we have to regard these structures, not merely as examples of different styles or ages of architecture, but rather as means employed for the attainment of a definite end, and more or less perfectly adapted to their purpose. Therefore, if we attempt to classify, in some sort of order, the various forms of bridge-construction, we must divide them into groups, genera and species, according to the distinctive mechanical features of their structure, considered as means for the accomplishment of a *definite object*.

In designing a bridge there are, of course, many practical objects to be kept in view, and some of these will vary according to the local conditions of each case; but supposing the number and width of the spans to have been determined by reference to such local conditions, we may say, broadly, that the duty which every bridge has to fulfil is that of carrying a certain load across a span or spans of certain defined width.

If we accept this as a general statement of the problem, we may still more closely define its terms by saying that the function which every bridge has to perform is, to resist the "bending moments" due to the given load. In the last chapter we examined the moments which are produced by certain dispositions of the contrary vertical forces acting upon the bridge, viz, the weights acting vertically downwards and the supporting forces acting vertically upwards; and it was remarked that these moments are quantities which depend only upon the magnitude and disposition of the forces themselves, and not upon the structural

character of the bridge. Therefore, whether the bridge is to have the form of a girder, an arch, or a suspension-bridge, or to be constructed on any principle yet unknown, the moments will have the values that have been already found, and the bridge will have to resist these moments by one means or another. In the case of a beam or girder, the "moment of resistance" at every vertical section, must be equal to the bending moment; and we have only to consider in what way the necessary "moment of resistance" can be made up by varying either of its component factors, viz., depth of girder and stress of flange. On the other hand, if the bridge is to have any other form than that of a girder, we must inquire by what forces or internal stresses the same moments are to be resisted.

For the purpose of this classification, we shall consider only the moments due to a uniform load; leaving the variable rolling load to be dealt with later. In bridges of moderate dimensions, the dead-weight of the structure itself, and of the roadway or railway which it supports, may generally be taken as uniformly distributed; therefore, the results now to be found may be taken as applying to the dead load only, or to the *total* dead and live load uniformly distributed.

41. Girders.—Taking first the large and well-known family of girders, we can hardly omit to mention the solid beam, which appears to be the oldest representative of the family. In the solid beam, the "moment of resistance" is made up of the separate moments produced by the stress of each individual fibre acting at its own distance from the neutral axis; but this fact renders it such a very inefficient structure that we can hardly include the solid beam in our catalogue of bridges. In every modern girder, the resisting fibres (at each vertical section) are concentrated as far as possible in a pair of thin flanges at the extreme top and bottom of the section, so that in each flange all the fibres are acting practically at one distance from the neutral axis. The horizontal stress in the two flanges will then have the same total value in each, and the "moment of resistance" will be simply the horizontal stress of either flange multiplied by the vertical depth of the girder.¹ Therefore, if we divide the bending moment at any vertical section by the depth of the girder, we have the horizontal component of the stress in either flange.

Looking now at the diagram of moments for any given distribution of load, it will be seen that the moment varies at different points in the span, and the varying moment of resistance may be provided by either of two opposite methods—we may have a uniform depth of girder and a varying strength of flange, or we may have a varying depth of girder and a uniform horizontal stress at every point in each flange.

1. If the girder is formed with straight parallel flanges, or if the

¹ This is a broad statement of a general rule, which is modified in some cases owing to the fact that the web or bracing will sometimes take a share in resisting the bending moment. The rule, however, is practically correct when the web consists of thin plate, or of numerous lattice bars inclined at equal angles in opposite directions.

depth of the girder is uniform, the flange-stress will be everywhere proportional to the bending moment, and we may take the diagram of moments as representing, on a certain scale, a diagram of flange-stress.

2. On the other hand, if we take the diagram of moments as indicating on a certain scale the varying depth of the girder, or in other words if we make the depth of girder everywhere proportional to the bending moment, the horizontal stress in each flange will be uniform throughout the length of the girder.

By way of illustration, let Fig. 66 be a parabola representing the diagram of moments for the uniform load, drawn to any convenient scale; and let this figure be cut out of a board of uniform thickness, thus producing a solid of the shape sketched in Fig. 66A, whose elevation and plan are shown in Figs. 65 and 66.

Every transverse section of the model (like that shown in dotted lines) will be a rectangle, whose area may be understood to represent the bending moment, while the height and breadth of the rectangle represent respectively depth of girder and stress of flange; and whichever way we turn the model, we may take its vertical side to represent the outline elevation of the girder, and its ground plan to

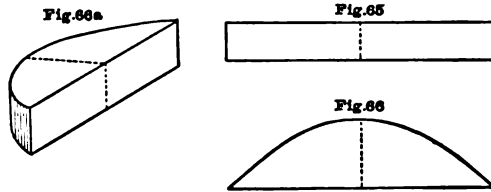

represent the diagram of stress. As it stands in Fig. 66A, the vertical side represents the elevation of a straight parallel girder, and the varying flange-stress is represented (on a certain scale) by the varying width of the model; but we can turn it up the other way, and its vertical side will then represent either a parabolic bowstring or an inverted bowstring, and the uniform width of the solid will measure (on the same scale as before) the uniform horizontal stress in the flange.

We may do the same for any other distribution of load, and for any other distribution of the supporting forces, and it follows that all the diagrams traced in the last chapter will represent so many bridges, cantilevers, or trusses; and generally *every diagram of moments represents the outline of a framed structure which will carry the given load with a uniform horizontal stress in the principal members.*

We shall first divide the family of girders into two principal groups in accordance with these distinguishing features.

42. Division A. First Group. Parallel Girders.—In the first instance we shall suppose the uniform load to be *continuously* supported by the main structure of the bridge. The several forms of construction which may be employed for this purpose, together with their corresponding diagrams of flange-stress, will be found illustrated in tabular form in Plates *A* and *B* at the end of this chapter, and will constitute the bridges of Divisions *A* and *B*.

In every Division the First Group will consist of parallel girders with a thin plate web.

Referring now to Plate *A*, we have in Example No. 1 the case of a detached girder of uniform depth, supported at each end. The stress-diagram for this case will be a parabolic curve similar to the diagram of moments found in Art. 34. The moment at the centre of the span was found to be $M_s = \frac{pL^2}{8}$, in which p is the intensity of the uniform load, and L the width between the supports. Therefore, if d represents the depth of the girder, we have the maximum flange-stress $\pm H_s = \frac{pL^2}{8d}$; and at any other point in the span, the stress will be $\pm H = \frac{px(L-x)}{2d}$; being a compressive stress in the upper flange, and a tensile stress in the lower flange. These stresses are represented by the parabolic diagram of stress, which, as in every example, is drawn immediately below the elevation of the girder.

In Example No. 2, we have a parallel girder of the same depth, carrying the load across the same span AC , but under very different conditions of stress, owing to the fact that the girder is not merely supported at A and C , but is also held down at I and J , or counterbalanced by the weight of the side spans; so that each half of the bridge is balanced upon the pier, and becomes a cantilever projecting out from the pier to the centre of the opening. The girder may, indeed, be actually divided at the centre, each cantilever being entirely independent of the other.

The moments for each cantilever were found in Art. 28; and the stress-diagram for the whole span AC will consist of the same parabolic curve as that employed in Example No. 1; but the curve will be wholly below the base-line, the vertex of the parabola touching the base-line at the centre of the span. At the centre, therefore, the stress will be nothing, but at the supports A and C it will have the maximum value $\mp H_a = \mp H_c = \frac{pL^2}{8d}$, being a tensile stress in the upper flange, and a compressive stress in the lower flange.

Example No. 3 represents another class of cantilever-bridge, in which the cantilevers project from each pier *towards* the centre of the opening, but do not quite meet; the gap left between them being crossed by a detached girder resting upon the ends of the cantilevers. If the bridge is constructed throughout with girders of one uniform depth, it will still belong to the First Group in which the stress-diagram is a reproduction of the diagram of moments. As explained in Art. 39, the diagram will again consist of the same parabolic curve as in the two previous examples; but instead of being wholly above or wholly below the base-line, the curve will be cut through by that line at the two points of contrary flexure TT' , and at these points the stress will, of course, be nothing. The central detached span TT' may be treated as in Example

No. 1; and if l represents the length TT' , the flange-stress at the centre will be $\pm H_b = \frac{pl^2}{8d}$; and then we shall have the stress at either of the

piers A or C , $\mp H_a = \mp H_c = \frac{pL^2}{8d} - H_b$.

The stress at either pier added to the stress at the centre must always make up the same sum, their united value being represented by the total height of the parabola. Thus, if we make the central detached girder longer or shorter, the effect will merely be that the straight datum-line of the diagram must be drawn at a lower or a higher level; and in this way the stress-diagram may be made to take any form intermediate between those of Example No. 1 and Example No. 2. Again, if the girder is continuous across the three spans, we may produce the same variations of stress, if we arbitrarily increase or diminish the "pier moments" by increasing or diminishing the load upon the ends I and J . In fact, the example here illustrated, may be taken as the type of several kinds of bridge in which these variations of stress are produced—either arbitrarily or in accordance with the laws of elasticity, as in the case of continuous girder-bridges.

43. Second Group. Parabolic Girders.—The bridge-structures forming the Second Group of our classification will be derived from the girder-bridges of the First Group by the simple process of conversion referred to in the earlier part of this chapter. That is to say, in each example of the parallel girders we shall take the stress-diagram for the new elevation, and the rectangle which formed the elevation of the parallel girder will then be the new stress-diagram.

The resulting forms of bridge-construction are those illustrated upon the second line in each of the Plates A , B , C , and D .

It will be seen that this group includes a number of structures of widely different forms; but in Plate A , which we are now considering, all the girders of this group will have a parabolic outline.

Turning to the first column of Plate A , we have immediately below No. 1, the derived form illustrated in Example No. 4, which represents the well-known parabolic bowstring. The girder corresponds in figure with the stress-diagram of No. 1, and consists of a curved upper member or "bow" erected upon a straight chord or tie. Under the uniform load, the horizontal stress in either member of the parabolic bowstring will be the same at every point in the girder, and the stress-diagram will therefore be a rectangle as shown in the Plate; it being understood that the height of this rectangle represents the direct stress in the lower flange, or the *horizontal component* of the inclined stress at any point in the curved bow. If D denotes the maximum depth of the girder, the uniform horizontal stress will be $\pm H = \frac{pL^2}{8D}$.

If we proceed to treat the cantilever-bridge (No. 2) in the same way, we shall obtain a pair of parabolic cantilevers meeting at the centre of

the span, as shown in example No. 5, in which the figure of the bridge corresponds with the stress-diagram immediately above it. Therefore, as the depth of the cantilevers is everywhere proportional to the bending moment, the horizontal stress in each flange will be uniform throughout, and will have the value $\mp H = \frac{pL^2}{8D}$, in which D represents the maximum depth of the cantilever, or the height of the parabolic curve.

Referring now to girder-bridge No. 3, consisting of a continuous girder with two points of contrary flexure, or consisting of two cantilevers with a detached girder between them, we may again take the stress-diagram as the outline elevation of a bridge, which we may call a continuous girder of varying depth, or a cantilever-bridge with a central bowstring. This form of construction is illustrated in Example No. 6; and as the depth of girder or cantilever is everywhere proportional to the bending moment, the horizontal stress throughout each flange of the whole structure will be uniform.

Now if D represents as before the total height of the parabola, or in this case the sum of the heights of the cantilever and of the bowstring, the horizontal stress in each flange will again be represented by the same formula, or $\pm H = \frac{pL^2}{8D}$, being of uniform value throughout the span;

but in this case the *straight member* will be everywhere in tension, and the *curved member* everywhere in compression. In this parabolic form of design it will be seen that the stress does not depend upon the width which may be adopted for the intermediate bowstring; we may make the central bowstring as narrow as we please until it vanishes (as in No. 5); or as wide as we please until it covers the whole span (as in No. 4); but if we adhere to the same total height of parabola, the uniform horizontal stress in the curved member, and the uniform stress in the straight member will always have the same value.

44. The two groups of girder-bridges are broadly distinguished from each other by the different way in which the stress is distributed along the flanges; but they are perhaps even more clearly distinguished by the very different manner in which the shearing force is resisted. In straight parallel girders the stress of the flanges is exerted in a *horizontal* direction, so that the *vertical* shearing force can only be resisted by the vertical component of the diagonal stresses in the lattice bars or web; and it is the horizontal components of these same diagonal stresses which produce the difference between the successive values of the flange-stress at two different points along the flange. Therefore, without the lattice bracing or web, these parallel girders would be quite incomplete, and totally unable to carry their own weight or any load whatever. The flanges could suffer no horizontal stress, and could offer no resistance to the vertical forces, except through the intervention of the diagonal bars. In other words, the compressive and tensile stresses which are shown in the stress-diagram are *entirely due* to the horizontal pull or push of the lattice bars, or of the

plate web ; for it will be observed that the stress is not carried through the flanges from end to end, as in a strut or tie, but is picked up gradually on the way from each end towards the centre, being derived from the force which is applied continuously, at each step of the way, by the web.

But in parabolic girders, and in all girders or trusses of the Second Group, these conditions are reversed. It has been [shown that *in all bridges* the vertical shearing force is measured by the *inclination* of the curve of moments at each point in the span. In structures of the Second Group, *the inclination of the curved member* is everywhere equal or proportional to that of the curve of moments ; and the consequence is that the vertical shearing force is exactly met and resisted by the vertical component of the stress in that curved member, so that none of it remains to be borne by the diagonal bracing.

Again, we have seen that the horizontal stress in each flange runs right through from end to end, and is uniform along the whole length ; therefore none of it is due to any local action of the bracing, but the whole of it is derived from the horizontal force which, at each end of the flange, is exerted upon it by the other flange. Thus, referring to the bowstring girder in the first column of Plate A, the uniform tension throughout the tie is due entirely to the horizontal force exerted upon it at each end by the thrust of the bow ; or we may say that the horizontal compression of the bow is due entirely to the force exerted upon it by the pull of the tie.

The same remarks apply also to the parabolic cantilever bridge, and the cantilever-and-bowstring bridge, illustrated in the second and third columns of the Plate.

It follows, therefore, that in structures of the Second Group, under the uniform load, all the essential functions are performed by the two flanges of the girder without the aid of any web or lattice bracing. The two principal members really form the complete structure, with the exception that if the roadway is to be carried across at a uniform level, it must of course be suspended from or supported upon the curved member by vertical rods or pillars. Under the uniform load, the diagonal bracing has no function to perform, and might in fact be dispensed with if the load were subject to no variations.

45. Third Group. Arches.—We have just said that in the parabolic bowstring girder, the diagonal bracing might really be dispensed with so far as the uniform load is concerned, and we may now add that the horizontal tie may also just as well be dispensed with, if in place of its action we substitute the horizontal resistance of a pair of solid abutments. In fact, the essential function of the tie is to receive the horizontal thrust of the bow at each end ; and if we make the ends of the bow to abut against the masonry, the thrust will be received by the abutments, instead of by the tie. Thus, if we slide the bowstring girder down between two vertical walls, as shown in example No. 7, we may safely proceed to disconnect one end of the tie from its attachment to

the bow, and its office will then be just as well performed by the resistance of the abutment-walls; the tie will be doing nothing and may be removed, and the structure will then become an "*equilibrated linear arch.*"

No demonstration is needed to prove that the parabolic arch will be in equilibrium under the uniform load; for we have seen that the parabolic *bow* of the bowstring will support that load without the aid of any tie or any diagonal bracing, and therefore will be in equilibrium under the forces impressed upon it by the abutments and the vertical suspending rods, and this is exactly *what is meant* by an equilibrated arch. We may note, however, that the reason why the arch is in equilibrium is because it corresponds in figure with the curve of moments for the given load; the parabolic bowstring was made to conform in figure with the diagram of moments, and the result was that the horizontal stress in the bow was uniform throughout, and this uniformity of horizontal stress is the necessary condition of any equilibrated arch or "*funicular polygon.*" The same result will follow if any other distribution of load is treated in the same way; and generally *the curve of moments, for any given load, represents the figure of a linear arch which would be in equilibrium under that load.*

It will be noticed that in the arch of No. 7 nothing has been done to affect in any way the *vertical* forces acting upon the bridge; the disposition of the load and of the supporting forces remain unaltered, and at every point in the span the moment which we have called the "*bending moment*" has to be resisted as before; but in the arch the resisting couple consists, not of a pair of opposite stresses, but of the horizontal stress of the arch and a *horizontal force* acting along the line of an imaginary straight member, *i.e.*, along the dotted chord line joining the two ends of the bow. In fact the only difference is that the latter force, instead of being exerted at each point by the tensile stress of a strong and heavy tie, is invisibly carried across the span in thin air, and without the employment of any metal whatever.

The arched structures forming the Third Group of our classification will therefore be derived from the girders of the Second Group, by simply taking away, in each case, the straight horizontal member of the girder. The resulting forms are illustrated upon the third line of Plates *A* and *C*.

We have already discussed the transmutation of the bowstring No. 4 into the single arch of No. 7; and referring briefly to the parabolic cantilever bridges Nos. 5 and 6, it may be remarked that in each case the curved member is perfectly adapted to carry the uniform load alone, as an equilibrated arch, if it is only abutted against solid masonry piers at the springing, or is in some way subjected at each end to the necessary horizontal compressive force; and the straight member then ceases to be of any use. In the purely cantilever bridge (No. 5) the straight member acts simply as a tie between the crowns of the two semi-arches which spring in opposite directions from each pier; but if the semi-arches are allowed to come together in the centre of the span, the horizontal com-

pressive stress at the crown of the arch will take the place of the force exerted by the tie ; and a series of such equal-armed cantilevers may therefore be transformed into a series of arches, as shown in No. 8, by simply taking away the straight member. The load will then be carried by the curved member, as an arch, without altering the stress in that member ; the opposite thrusts of the semi-arches will balance each other at the crown without the aid of the straight tie, and the opposite thrusts at the piers *A* and *C* will also balance each other, so that under the uniform load these piers will only have to afford a vertical support to the superstructure ; but of course the necessary horizontal compressive force will have to be supplied by the reaction of the extreme abutments at each end of the series of arches.

Again, the parabolic cantilever-and-bowstring illustrated in No. 6 may in like manner be transformed into an arched bridge, as shown in No. 9, provided that the thrust of the arch be taken up by the horizontal resistance of solid abutments.

The tensile stress of the straight member, acting on the line *IJ*, may, if we wish, be exactly reproduced by a horizontal force acting *in the same line*, and produced by the reaction of fixed abutments at *I* and *J* ; for, under the supposed uniform load, the thrust of the side arches will be the same as that of the central arch. However, so far as the central span *AC* is concerned, it is evident that the same object may just as well be attained by applying the reaction at the springing of the arch ; *i.e.*, by making the piers *A* and *C* as fixed abutments.

Looking at the three examples, Nos. 7, 8, and 9, it will be seen that the structure which carries the load across the span *AC* is the same in each example, and the arch is in each case subjected to the same stress, although the three examples have been derived from three different types of girder-bridge, by employing in each case the curved member of the girder alone, and dispensing with the horizontal tie. The roadway may in each case be carried at the level of the dotted line representing the position of the original straight member ; and if this is done the straight member may remain as a portion of the suspended roadway platform ; but it will have no direct stress under the uniform load ; and it is obvious that the roadway may be carried at any higher or lower level as may be most convenient.

46. Division B.—If we invert all the bridge-structures which have been described in Division *A*, we shall obtain another series of designs possessing very similar features, except that the inversion of form is accompanied by a corresponding reversal in the character of the stress. Thus turning once more the imaginary model upon its opposite side, we have the several forms of structure illustrated in Plate *B*, together with the corresponding stress-diagrams for each case.

The parallel girders of Group 1, which are shown at the top of each column, remain of course unaltered in form, and the stresses have the same value as before ; but the stress-diagrams are drawn in their inverted

form; and if the diagrams of Plate *A* are taken to represent the stress in the *upper* flange, the inverted diagrams of Plate *B* may be understood as representing the opposite stresses in the *lower* flange of the parallel girders.

47. Passing on to the parabolic girders of Group 2, we have in No. 10 an inverted parabolic bowstring, in which the straight horizontal member is subjected to a uniform compressive stress (under the uniform load), while the curved member suffers a tensile stress whose horizontal component is uniform throughout the span, the value of the stress in each member being exactly the same as in the upright bowstring of No. 4, but of the opposite kind.

Again, in No. 11, we have the diagrammatic representation of a pair of parabolic cantilevers meeting in the centre of the span, in which the depth of girder is everywhere proportional to the bending moment, the figure of the bridge being derived from the stress-diagram above: and of course the horizontal stress in each member is again uniform throughout, and has the same value as in the cantilevers of No. 5.

Referring now to the cantilever-and-bowstring of No. 12, it will be seen that if we make the elevation to correspond exactly with the stress-diagram of the continuous girder above, the central girder will be an *inverted* bowstring; but if we wish to preserve a uniform height of clear headway under the bridge, we may erect the central bowstring in an upright position, and if we do not alter its depth the stresses will still have the same value; and the depth of girder being everywhere proportional to the bending moment, the horizontal stress in each flange will again be uniform throughout the span, and will have the same value as in the upright form of No. 6.

In all the upright parabolic girders of Plate *A*, without exception, the straight member was everywhere in tension and the curved member in compression; and in the inverted bridges of Plate *B* the reverse will be found to take place throughout every example, if in the case of No. 12 the central girder is an inverted and not an upright bowstring.

48. Continuing the classification upon the same principle, the Third Group of Plate *B* will naturally consist of Suspension Bridges; and these forms will be derived from the several examples of Group 2, by simply removing the straight horizontal member of the girder.

In the inverted bowstring of No. 10, the straight member only performs the function of a strut, and if the two ends of the curved tie or chain are made fast to the masonry abutment, or tied back to a heavy and solid anchorage, the strut may be removed and the curved tie will become a suspension chain which is in perfect equilibrium under the uniform load. The chain will be in equilibrium *because* its figure corresponds with the inverted curve of moments for that distribution of load; and generally *the inverted curve of moments, for any given load, represents the figure which would be assumed by an equilibrated flexible chain under that load.*

In the same way the curved tension member of the Cantilever Bridge, No. 11, is perfectly capable of supporting the load without the assistance of the lower compression member, if the curved members are only coupled together at the centre of the span, and at each abutment are tied back to a solid anchorage; and the bridge then becomes the ordinary suspension bridge of No. 14.

Referring, lastly, to the cantilever-and-bowstring of No. 12, it will be easily seen that if the central portion is an *inverted* bowstring, and if the curved member of that bowstring is coupled at each end to the tension member of the cantilever, the whole will form a continuous parabolic chain, which, without undergoing any change of stress, would carry the load across the whole span as a suspension bridge. Therefore if at each abutment we tie back the tension member of the cantilever, as in example No. 15, the straight member will be relieved of the whole of its stress, and may be dispensed with, or employed only as a portion of the roadway platform.

It may here be remarked that, in this and in every example of Group 3, the straight member, if retained in the position shown, may be connected to the curved member by diagonal bracing exactly as in the corresponding girders of Group 2; and if this is done, the bracing will have the same function to perform, namely, that of securing the rigidity of the bridge under the rolling load, and will perform that function in the same manner as in the girders of Group 2. This need not affect the general character of the structures as arches or suspension-bridges, *provided that certain conditions are observed in their construction*; but these we shall have to consider further, when dealing with changes of load and changes of temperature.

49. Division C.—The primary object of the bridge (from our present point of view) is to support a uniformly distributed load, but this load, instead of being attached directly to the main structure, as in the previous examples, may be carried upon short bearers, which in their turn are supported by the main structure; so that the load actually carried by the latter consists of a number of concentrated weights applied at certain intervals.

It has been pointed out in Art. 35, that if the subsidiary bearers are so many detached spans (and not continuous beams), the effect of this subdivision will be to change the diagram of moments from a parabolic curve to a polygon inscribed in that curve. It follows, of course, that in the parallel girders of Group 1, the stress-diagrams will be correspondingly changed, as illustrated in Plate C.

In this Plate, the examples shown in Nos. 16, 17, and 18 represent parallel girders of the same span and depth, in which the length is divided respectively into two, three, and four panels or subdivisions, by cross-bearers; the load being carried by subsidiary longitudinal beams resting upon the cross-bearers. The diagrams of flange-stress will then become polygons of two, three, and four sides respectively, inscribed in

the same parabolic curve; and at each cross-bearer, the flange-stress will have the same value as though the load were supported continuously by the main girder,¹ because each angle of the polygonal diagram exactly touches the parabolic curve.

Again, adhering to the method of classification before described, we may use these stress-diagrams as the outline elevations of a series of bridge-trusses forming the girders of Group 2; while the rectangular elevation of each parallel girder will become the stress-diagram for the principal members of the truss. Thus, in the examples of Group 2, shown in this Plate, we have in Nos. 20, 21, and 22, illustrations of polygonal trusses consisting of two, three, and four panels respectively. In each of these trusses or girders, the principal members are a horizontal tie and an upper compression member of polygonal form, whose angles or joints, in each case, touch the circumscribing parabolic curve; and if D is the height of that curve, the horizontal stress throughout each flange or principal member will again be expressed by the formula $\pm H = \frac{pL^2}{8D}$.

If the span is divided into an *even* number of equal panels, D will represent the central depth of the truss or polygon; but if the number is *odd*, the central panel will of course be somewhat less in height than the vertex of the parabola, because the upper member will form a chord to that segment of the curve. Thus, for example, in the three-panelled truss² of No. 21, the height of the truss is evidently less than the height D of the parabola.

It is obvious that the larger we make the number of panels, the more closely will the polygon approach to the parabolic curve, and even in the four-panelled truss of No. 22 we have a girder which differs but slightly from the parabolic bowstring of No. 4. It is worthy of notice, however, that when the parabolic bowstring is constructed with open panels or bays of diagonal bracing, the load is not really applied uniformly along the bow, but, on the contrary, the entire load (except the mere weight of the bow) is concentrated at the joints of the bracing; and strictly speaking, therefore, the proper form of the bow or arch is *not* the parabolic curve but the inscribed polygon.³ Thus all the curves of the several examples in Tables *A* and *B* will have to be changed into polygons if the uniform load is really subdivided and concentrated at the joints.

¹ This is not strictly true unless the bearers are detached beams; if they form continuous beams, the effect of continuity will be to *increase* the load carried by some of the cross-bearers, and to *diminish* that portion of the load which is transferred directly to the abutments.

² The three-panelled truss is included here in the classification consistently with the general rule; but in practice the stresses in such a truss may be found by other methods more conveniently, than by the formula above given, in which D represents no real dimension of the truss; and the same remark applies also to the derived forms, Nos. 25, 29, and 33.

³ If the load is uniformly distributed along the lower flange, the subdivision of the load and its concentration at the panel-points, are effected by the lower flange itself, acting as a series of continuous bearers, or discontinuous bearers, according to the form of the flange.

In very large bridges, however, the weight of the bow becomes a considerable item, and when the panels are wide it becomes necessary to go to a still greater refinement of calculation, treating the weight of the bow itself as a uniform load, and the remaining weight of the structure and roadway as a load concentrated at the joints. In this case, it is not difficult to see that the proper line for the bow (or chain or arch) will lie between the polygon and the circumscribing curve, forming a series of flat curves instead of a series of straight chords.

Amongst the panelled or subdivided bridge-structures of the present division, the Third Group will naturally consist of polygonal arches, which are derived from the trusses of Group 2 by leaving out the straight tension member. These are shown on the third line of Plate *C*, in examples Nos. 24, 25, 26, and 27; but it will be unnecessary to discuss these forms in detail, as they are all derived in the same way as the parabolic arches of Plate *A*, and *mutatis mutandis* the same principles will apply to both divisions alike.

50. Division D.—For the reason just stated it will be sufficient to glance briefly at the examples of Plate *D*, which are simply inverted repetitions of the structures last considered. The arrangement of the groups is carried out on the same principle as before. In the First Group of parallel girders, the stress-diagrams are drawn in their inverted form; these diagrams are then used as elevations of the inverted polygonal trusses of Group 2; and lastly, by removing the straight horizontal member, these several trusses are transformed into so many straight-link suspension bridges, and constitute, in that form, the Third Group of the Division.

51. The list of bridge-structures is already tolerably extensive, and so far as we have yet gone, it will be noticed that all these forms of construction are connected by a sort of family relationship, so that they can all claim to be descended from the simple girder of No. 1 and its diagram of stress. In fact we have really sketched the genealogical tree. Some of the examples here shown are merely ideal forms, or structures in their embryonic stage; and every one of them must be taken as representing no more than a single type of a class which is capable of many variations in detail.

Thus we may take the First Group as including all the different varieties of parallel girder, which will severally be distinguished according to the arrangement of the web or bracing. It has been shown how, with a plate web, the stress-diagram was modified by the subdivision of the load, or spacing of the cross-bearers; and when we abandon the continuous plate web, the diagram will receive another modification depending upon the special arrangement of the diagonal bracing which takes its place.

The Second Group will include all girders or trusses in which the depth is made proportional to the bending moment under the uniform

load; and therefore, in addition to the forms shown in the tables, it will also include such structures as the "sickle" girder shown in Fig. 67, and the "Saltash" type, or bow-and-chain bridge, sketched in Fig. 68. In each of these figures, the two principal members are supposed to form parabolic curves, and therefore, the depth being everywhere proportional to the bending moment, the horizontal stress will be uniform, and will be expressed by the same general formula as before, the depth D being understood to be the maximum depth of the girder.

Again, the two curved members of the "Saltash" bridge may be set back to back as shown in Fig. 69, or made to intersect each other as in

Fig. 70, thus producing in the one case a pair of cantilevers and in the other a cantilever-and-girder bridge; but if the same curved members are used in each case without altering their form, the stress under the same uniform load will be the same (in each case) as in the "Saltash" bridge.

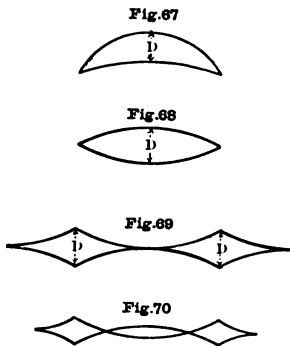

We shall also have another class of girders of varying depth, coming between Groups 1 and 2. Thus, in the case of a detached span, the girder may have a "hog-backed" form, as in Fig. 71, intermediate between the rectangle and the parabola, which are shown in dotted lines, and which represent a parallel girder and a bow-string of the same maximum depth. In the same way cantilevers may be formed as shown in Figs. 72 and 73; so that the depth is somewhat reduced at the points where there is no bending moment, but is not reduced at those points to absolutely nothing—as it would be if the depth were made proportional to the bending moment.

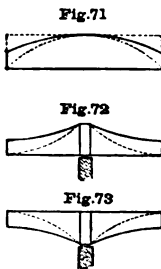

If we compare either of these forms with a parallel girder of the same maximum depth, it will be seen that the flange-stress in the centre is exactly the same, but near the ends it is *greater* than in the parallel girder, and as a natural consequence the stress throughout the bracing will on the whole be *less* than in the parallel girder. On the other hand, if we compare them with the parabolic girder of the same maximum depth, the flange-stress in the centre will be the same, but near the ends it will be *less* than in the parabolic girders, and consequently the stress in the bracing will be *greater*.

Throughout all the parabolic and polygonal girders of Group 2, the stress in the bracing is *nothing* under the uniform load; but in this intermediate group of girders and cantilevers, the uniform load will produce stress in the diagonal bracing.

These local variations of depth are of considerable importance in the

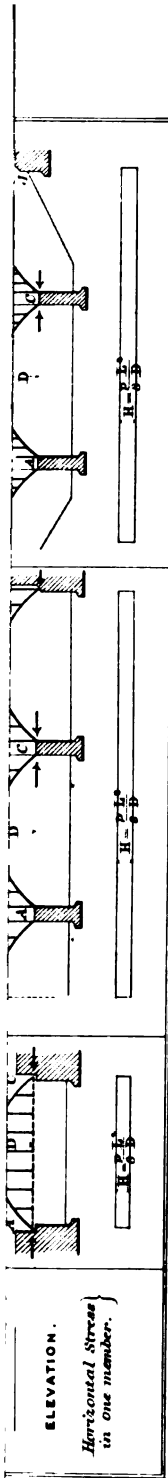
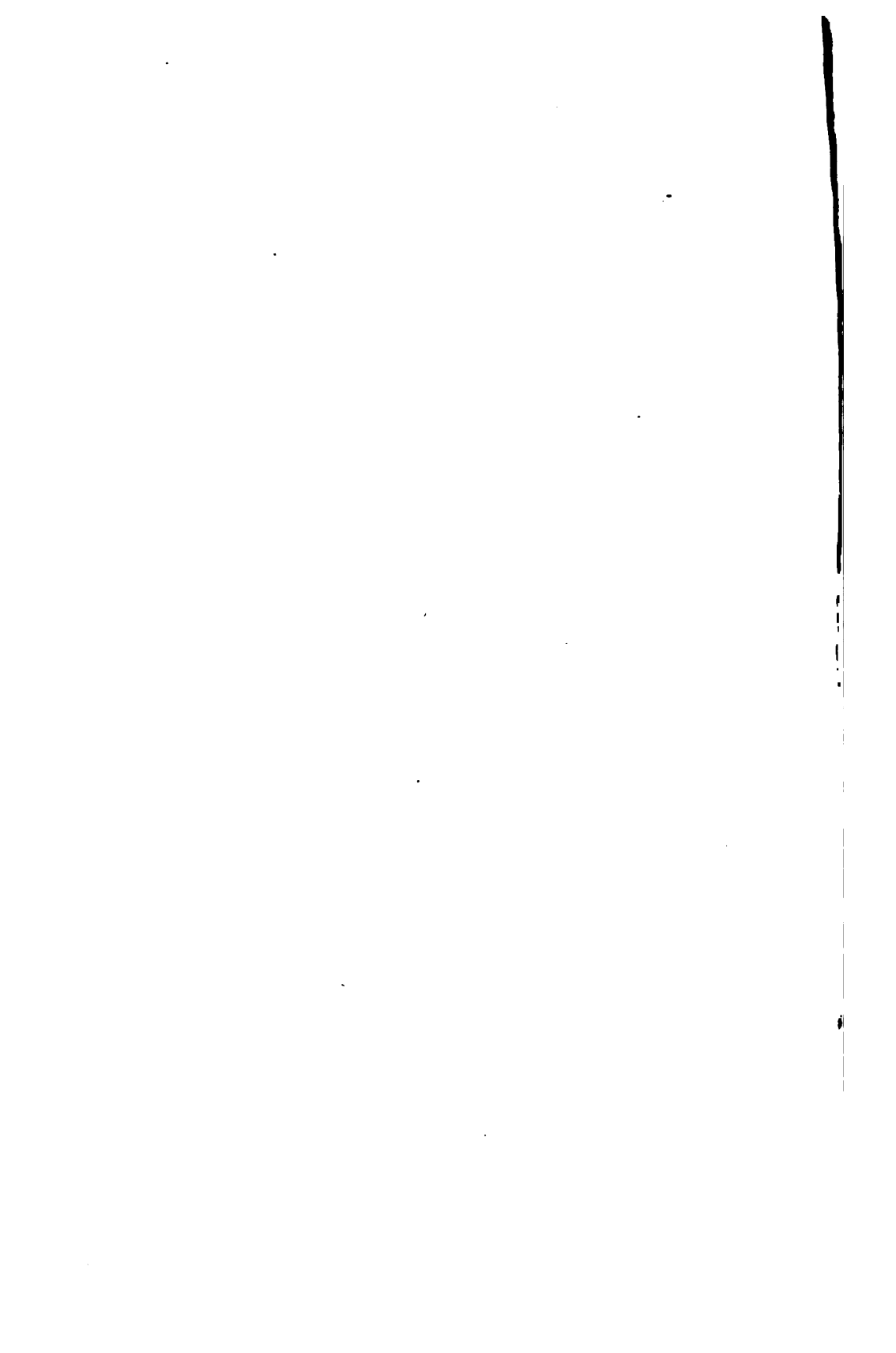
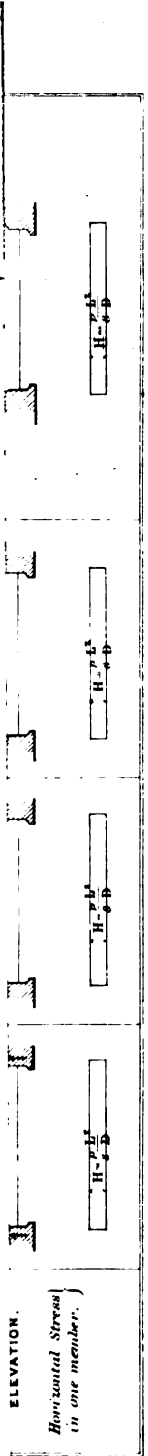

Fig. 241. — *Contd.*





ELEVATION.
Horizontal Stress
in one member.

Fig. 11. 11. 11. 11. 11.

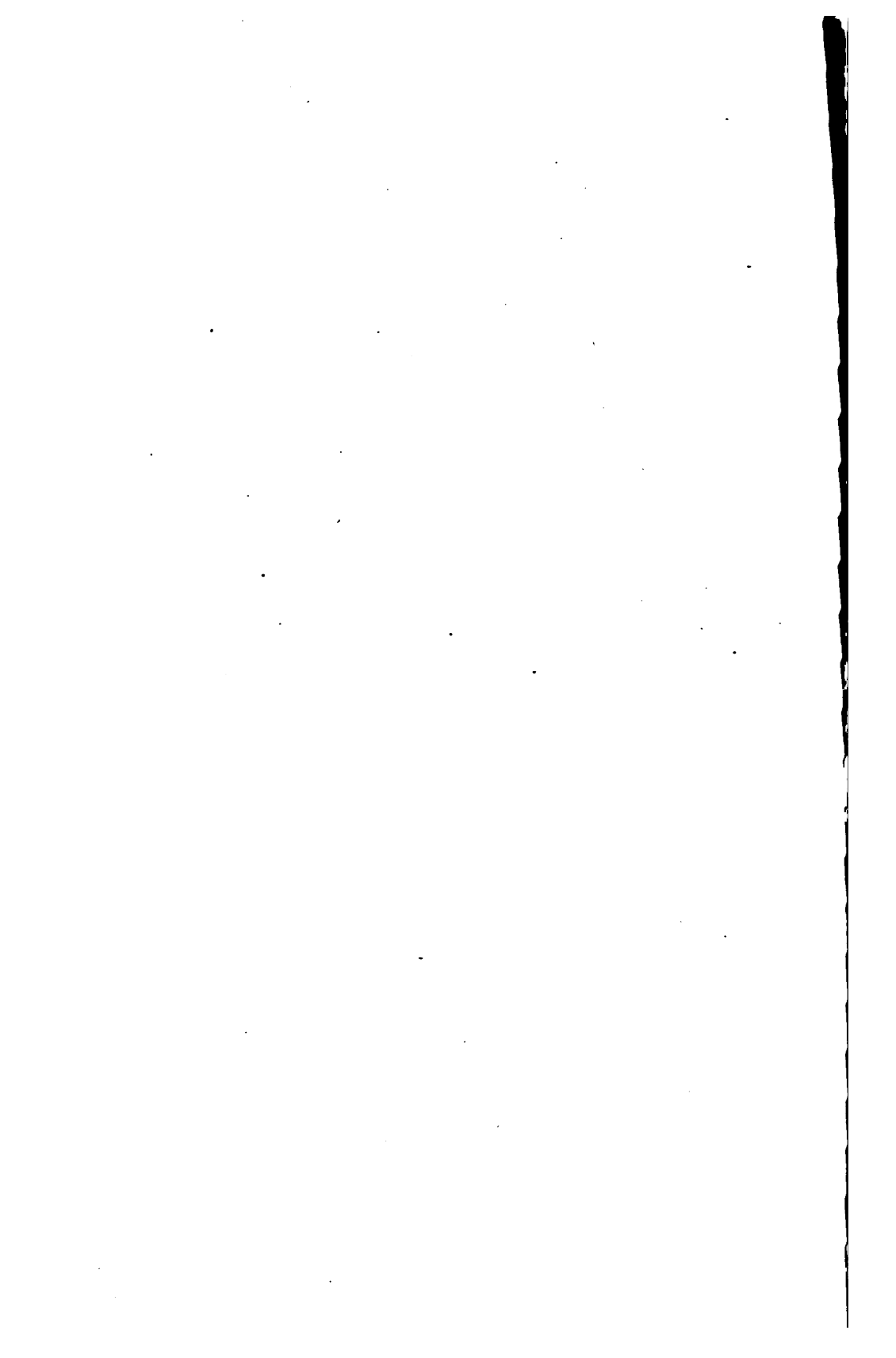

case of cantilever bridges. Near the ends of the cantilever, the bending moment is very small, and in the parallel girder the depth at this point is out of all proportion to the vanishing sectional area of flange, while in the parabolic girder the same disproportion exists in the opposite direction; and it may readily be imagined that a *via media* may be found which offers greater advantages than either of the extreme types.

CHAPTER VI.

THE COMPARATIVE ANATOMY OF BRIDGES (*continued*)—
COMBINED OR COMPOSITE BRIDGES.

52. In addition to the forms of construction enumerated in the last chapter, we still have to notice a certain class of bridges whose design appears to have been based upon a different idea. In these bridges, the duty of carrying the whole distributed load, or of carrying the series of panel-weights into which the load may be divided, is not performed by a single main structure, but by a combination of structures or systems, each of which is designed to perform a certain *portion* of the duty.

When the functions of each system are clearly distinct, there is no difficulty in finding the stress and the necessary strength of each member; but sometimes the systems are so combined together, that two or more of them offer their support to the same element of the load; and in this case a doubt arises as to which of them is to carry it, or in what proportion they will divide it between them; and generally the question can only be decided by reference to the laws of elasticity.

We may designate as "Composite" structures those which are composed of separate systems, each carrying its own portion of the load; and "Combined" structures will be those in which two or more systems offer their combined support to the same element of the load. Referring to the former class, we may again distinguish between bridges which are composed of independent parallel systems, and those which consist of a number of systems superposed one upon the other. Some examples of each kind are illustrated in Plate *E*, and it may be remarked that in each case the structure illustrated may be inverted without altering the *value* of the stress in any member, but only reversing its character.

53. **Division E.**—In the first example (No. 36) the span is divided into any arbitrary number of equal panels, and the load at each panel-point is supported by a separate triangular truss extending the whole length of the span. This construction is seldom employed in the upright form, but the inverted figure represents in principle the American "Bollman" truss. The straight horizontal member *AC*, which forms the tie in the upright form, and the compression boom in the Bollman truss, is common to all the triangles; and the stress in this member is the sum of the horizontal stresses due to each triangle separately. The

stresses may easily be found by the method of moments. In Fig. 74 let AbC represent any one of the triangular trusses, and let P represent the load upon the panel-point whose distance from A is denoted by x . Then the upward reaction at A will be $P \frac{L-x}{L}$, and the moment at the section eb will be $P \frac{x(L-x)}{L}$. Therefore if D is the depth eb , we have the horizontal stress $\pm H_s = P \frac{x(L-x)}{LD}$; which represents the direct compressive stress in the upper member due to this particular element of the load, and also the horizontal component of the tensile stress in the bars Ab and bC . But in the case of such trusses we shall arrive at the result still more simply by the resolution of forces; for the vertical reaction at A or the force $P \frac{L-x}{L}$ represents the vertical component of the stress in the bar Ab , and the horizontal stress in the same bar must be equal to that quantity multiplied by $\frac{x}{D}$; or again, if we multiply the vertical force at C by the ratio $\frac{eC}{eb} = \frac{L-x}{D}$, we arrive at the same value for the horizontal stress of the bar Cb ; viz., $-H = P \frac{x(L-x)}{LD}$.

If N represents the number of panels, or bays of equal width, into which the span is divided, the weight on each panel-point will be $P = \frac{pL}{N}$, in which p is the intensity of the uniform load. Therefore the horizontal stress in any one of the triangular trusses will be—

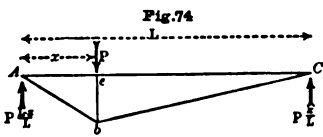

$$\pm H_s = \frac{px(L-x)}{ND} \dots \dots \dots (1)$$

while the number of trusses will be $N - 1$.

The compressive stress in the boom AC will be the sum of all these horizontal stresses, or—

$$H = \sum \frac{px(L-x)}{ND} \dots \dots \dots (2)$$

This formula gives the following values of H for the given number of bays or panels.

- For $N = 2$, $H = \frac{1}{8} \cdot \frac{pL^2}{D}$
- $N = 3$, $H = \frac{4}{27} \dots$
- $N = 4$, $H = \frac{5}{32} \dots$
- $N = 6$, $H = \frac{35}{216} \dots$
- $N = 8$, $H = \frac{31}{128} \dots$
- $N = \infty$, $H = \frac{1}{6} \dots$

and generally, the compressive stress in the boom AC will be—

$$H = \frac{pL^2}{6D} \left(1 - \frac{1}{N^2} \right) \dots \dots (3)$$

54. Instead of a series of triangles, the bridge may be composed of a series of trapezoids, as in example No. 37, which represents an old-fashioned truss often used in carpentry. Each pair of panel-points right and left of the centre is carried by a trapezoidal truss; but if there is an even number of panels, the central point is carried by a triangular truss as in the figure.

Let Fig. 75 represent any one of the symmetric trapezoidal trusses, and let P denote the panel-load imposed upon each of the two joints b and f , whose horizontal distance from the nearest abutment is in each case denoted by x . Then P will represent the vertical reaction at each abutment, and also the vertical component of the stress in the inclined ties Ab and Cf , while the horizontal stress in those bars will be $P \frac{x}{D}$; and this will be the value of the direct compressive stress in the boom AC (due to the pair of weights), and also the value of the tensile stress in the bar bf .

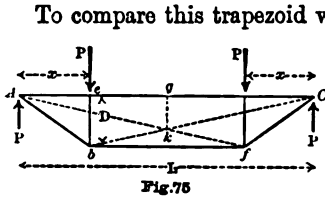

To compare this trapezoid with the two triangles which are employed in the Bollman truss to carry the same pair of weights, we may draw the dotted lines Af and Cb crossing each other at k , and representing the two bars of the "Bollman" truss which take the place of the single bar bf ; then referring to

the formulæ above given, it will be seen that the stress in the bar bf is less than the sum of the horizontal stresses in Af and Cb , in the proportion of $\frac{L}{2}$ to $(L - x)$; i.e., in the proportion $\frac{Cg}{Ce} = \frac{gk}{ek}$. Of course the compressive stress in the boom AC is also less in the trapezoidal than in the "Bollman" truss, and in the same proportion.

If N denotes, as before, the number of equal bays, the panel load will again be $P = \frac{pL}{N}$, and the horizontal stress in each trapezoid will be

$$\pm H_s = \frac{pxL}{ND} \dots \dots \dots (1)$$

The stress in the boom AC will be the sum of all the horizontal stresses. If the number of bays is even, there will be a central triangle, and the stress in the main boom will be—

$$\text{For } N = \text{any even number, } H = \frac{pL^2}{8D} \dots \dots (2)$$

On the other hand, if N is an odd number, the systems will be all trapezoids, and

$$H = \Sigma \frac{pxL}{ND} \dots \dots \dots (3)$$

This formula gives the following values for the stress in the main boom:—

$$\begin{aligned} \text{For } N = 3, \quad H &= \frac{1}{9} \cdot \frac{pL^2}{D} \\ N = 5, \quad H &= \frac{3}{25} \cdot \text{,,} \\ N = 7, \quad H &= \frac{4}{49} \cdot \text{,,} \\ N = \infty, \quad H &= \frac{1}{8} \cdot \text{,,} \end{aligned}$$

and generally—

$$H = \frac{pL^2}{8D} \cdot \left(1 - \frac{1}{N^2}\right) \dots \dots \dots (4)$$

Comparing this value with the formula (3) given in the last Article, it will be seen that under the same *uniform load*, the horizontal stress in the combination of triangles is greater than in the trapezoidal systems in the proportion of 4 to 3.

55. Each of the two forms of truss that have been considered above may be transformed into a corresponding straight-link suspension bridge, by simply removing the boom *AC*, and substituting in its place the horizontal pull of a pair of backstays which are taken over the towers and secured to an anchorage at each abutment. Example No. 38 illustrates the suspension bridge derived from the “Bollman” truss; while No. 39, which represents in principle the “Ordish” suspension bridge, may in like manner be derived from the trapezoidal truss. In each case the stress in the inclined ties is the same as in the corresponding members of the truss; while the horizontal stress in each backstay has the same value as the compressive stress in the boom of the parent truss.

These values have already been given in the two preceding articles, and the formulæ show that the backstays and abutments of No. 38 would require to be 33 per cent. stronger than those of No. 39, in order to carry the same uniform load.

56. The practical object of combining together a series of triangular or trapezoidal trusses, is to support the roadway at a convenient number of points at sufficiently short intervals; but the same thing may be done by employing secondary trusses to carry the wide panels of the primary truss, and the panels of the secondary system may be subdivided in the same manner. This method is illustrated in example No. 40, which represents the American “Fink” truss, consisting of primary, secondary, and tertiary systems. The primary truss is an inverted triangle which only supports the roadway at one point in the centre of the span, thus dividing it into two equal bays. Each of these bays is in like manner crossed by an inverted triangle dividing it into two secondary panels, and so on. The boom *AC* serves as the upper member of *all* the triangular trusses; its compressive stress under the uniform load will be uniform throughout its whole length, and will be the sum of the horizontal stresses due to each of the three systems.

By this method of subdivision, the ultimate number of panels must always be some power of 2, and is generally $N = 2^3 = 8$. The several

triangles are generally made of equal depth (D), and the load is applied upon the upper member.

If $N = 2$, the bridge is a simple triangular truss, and under the uniform load, the weight on the central post (No. 4) is then $\frac{pL}{2}$, and the horizontal stress in the boom AC or in the two inclined ties is—

$$\pm H_1 = \frac{pL^2}{8D} \dots \dots \dots (1)$$

The subdivision of the two panels by the secondary and tertiary trusses does not alter the load upon the central post, and the stresses in the primary truss will, therefore, always have the value above given, whatever may be the number of subdivisions.

If $N = 4$, we have only to consider the stress in the two secondary triangles, each of which will have a span of $l_1 = \frac{L}{2}$, and a central load equal to $\frac{pl_1}{2}$; therefore, the horizontal stress in each of the secondary triangles will be—

$$\pm H_2 = \frac{pl_1^2}{8D} = \frac{1}{4} \cdot \frac{pL^2}{8D} \dots \dots \dots (2)$$

This will represent the horizontal component of the stress in each of the inclined ties attached to the foot of post No. 2 and of post No. 6, and will also represent the *additional* compressive stress inflicted upon the boom AC by the employment of the secondary trusses.

The further subdivision of the secondary panels will not affect the stresses produced by the uniform load in the members of the secondary trusses, as given in formula (2).

Therefore, if $N = 8$, we have only to consider the third series of triangles shown in dotted lines in the figure. Each of the four triangles will have a span of $l_2 = \frac{l_1}{2}$, and the horizontal stress will evidently be—

$$\pm H_3 = \frac{pl_2^2}{8D} = \frac{1}{16} \cdot \frac{pL^2}{8D} \dots \dots \dots (3)$$

For the different values of N, therefore, the compressive stress in the boom AC will be as follows—

$$\text{For } N = 2, H = H_1 = \frac{pL^2}{8D}$$

$$N = 4, H = H_1 + H_2 = \frac{pL^2}{8D} \left(1 + \frac{1}{4}\right)$$

$$N = 8, H = H_1 + H_2 + H_3 = \frac{pL^2}{8D} \left(1 + \frac{1}{4} + \frac{1}{16}\right)$$

In each case the stress is exactly the same as in the boom of the "Bollman" truss, considered in Art. 53.

The value of the vertical compressive stress in the several posts will be—

$$\text{In post No. 4, } V_1 = \frac{pL}{2}$$

$$\text{In posts Nos. 2 and 6, } V_2 = \frac{pL}{4}$$

$$\text{In posts Nos. 1, 3, 5, and 7, } V_3 = \frac{pL}{8}$$

and in each case one-half of this vertical force will be the vertical component of the tensile stress in each of the two inclined ties attached to the foot of the post in question.

57. The boom of the "Fink" truss acting as compression member for both primary and secondary systems, its stress is the *sum* of the stresses due to its position in each system; and this fact suggests at once that the principle might with advantage be reversed. Thus if we make the primary system an *upright* truss of any kind, and the secondary systems *inverted* trusses, or *vice versa*, the member *AC* will form the tie of the one system and the compression member of the other, as shown diagrammatically in Figs. 76 and 77. The stress in the member *AC* will then be *diminished* by the application of the secondary system instead of being increased; and its value will now become $H = (H_1 - H_2)$.

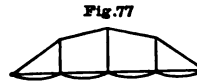

58. Instead of subdividing the span by triangles within triangles, we may have trapezoids within trapezoids, as illustrated in examples Nos. 41 and 43. In each case, the central system is a triangular truss *I, I*, whose ends are supported upon the joints of a trapezoidal truss *2, 2*, which in its turn is carried at each end upon the joints of a wider trapezoid *3, 3*, and so on.

In the first example the trapezoids are all *inverted* trusses with vertical posts, and the combination represents in principle the "Pratt" or the "Linville" truss;¹ while in No. 43, the trusses are alternately *upright* and *inverted* trapezoids, and the structure becomes a "Warren" girder.

In either case the bridge is simply a parallel girder with a particular arrangement of lattice bracing, and therefore the bending moments and the varying values of the flange-stress may be found by the methods described in the two previous chapters. But it has already been mentioned that in applying those methods, the arrangement of the lattice bracing will modify to a certain extent the stress in the flanges, and this effect will be clearly illustrated if we proceed to consider the parallel lattice girder as a composite structure, when the stresses under the uniform load can be at once obtained by simple addition of the vertical and of the horizontal forces.

¹ Girders in which the web-bracing consists of vertical posts and inclined braces, are known in America under various names, such as the "Linville," "Pratt," "Murphy," or "Whipple-Murphy" trusses, according to some variations of detail which are not always to be easily distinguished.

59. In the first place, suppose the span to be divided into an even number of bays as in Fig. 78, which represents a girder of the Linville type, consisting of eight equal panels. Let the width of each panel be denoted by $b = \frac{L}{N}$; and if θ represents the angle which each inclined tie makes with the horizontal, let the ratio $\frac{b}{d} = \cotan. \theta$ be denoted by r .

The external force or load on each panel-point will be $P = \frac{pL}{N}$; and we shall first suppose these loads to be applied on the *tops* of the vertical posts. As the number of bays is even, the central panel-point B , carrying the load P , will be supported by a triangular truss $A_1b_1C_1$, which will transfer one-half of that load to each of the points A_1 and C_1 , so that the vertical component in the first brace b_1c_1 will be $-\frac{1}{2}P$. Adding the panel load P which is imposed at C_1 , the sum of the downward forces must be balanced by the compressive stress $1\frac{1}{2}P$ in the post C_1c_2 , while a similar load will of course be carried by the post A_1a_2 . This pair of weights being carried by the second system or trapezoidal truss $A_2a_2c_2C_2$, the vertical component of stress in the brace c_2C_2 will be $-1\frac{1}{2}P$; and again adding the panel load at C_2 we have the stress in the post $C_2c_3 = 2\frac{1}{2}P$. Proceeding in the same way, we obtain, by simple addition, the vertical stresses or components written against each member in the right half of the figure,—noting that the panel load upon the extreme point C_4 is only $\frac{P}{2}$; thus bringing up the total load upon the end pillar C_4C , to the value $4P$, or half the total load upon the girder.

The horizontal component of stress in each brace will be to the vertical component as $b:d$. Therefore multiplying in each case by the ratio r , we obtain the series of horizontal components written against each brace on the left half of the figure; and these values will represent the horizontal compressive or tensile stress $\pm H$ throughout the upper and lower members of *each trapezoidal system*.

Let V_n represent the vertical reaction at either end of any system due to its contained load, and $-V_n$ the vertical stress in the inclined ties of that system.

Then in the 1st system, A_1C_1 , we have $\pm V_1 = \frac{1}{2}P$, $\pm H_1 = \frac{1}{2}Pr$
 $2d$ „ A_2C_2 , „ $\pm V_2 = 1\frac{1}{2}P$, $\pm H_2 = 1\frac{1}{2}Pr$
 $3d$ „ A_3C_3 , „ $\pm V_3 = 2\frac{1}{2}P$, $\pm H_3 = 2\frac{1}{2}Pr$, &c.

And generally—

In the n th system, $\pm V_n = (n - \frac{1}{2})P$, $\pm H_n = (n - \frac{1}{2})Pr$.

Now if the upper chords of the several systems are welded into one member, and the lower chords welded into another member, we have only to summate the values of $\pm H$, and we obtain the values of the flange-stresses written against each portion in the left half of the diagram, Fig. 78, and again represented in the diagram of horizontal flange-stress, Fig. 79. In the latter diagram, the stepped outline, above the base-line

AC, represents the positive or compressive stresses; while the negative stresses are represented below the base-line, the dotted stepped line being the diagram of tensile stress for the lower flange, and the shaded rectangles being the diagrams of horizontal stress in the inclined ties or braces. If we include the shaded rectangles at the ends of each horizontal layer or strip of the diagram, it will be seen that the successive strips are the diagrams of $-H$ for the several component systems, and form together a diagram similar to the positive diagram. But the shaded rectangles represent, as before mentioned, the horizontal stress in the *inclined ties*, and have no reference to the horizontal *flanges* of the girder; and if we exclude them from the diagram it is evident that, in each bay of the girder, the compressive stress in the upper flange is greater than the tensile stress in the lower flange.

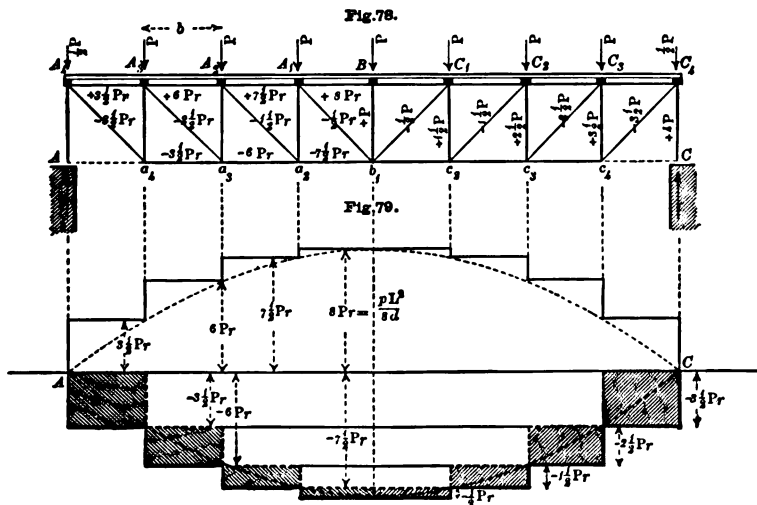

We may now compare these results with the diagram of flange-stress which has been constructed (in the previous chapter) for the case of a panelled plate-webbed girder, and which is reproduced in Fig. 79 by the dotted polygonal line touching the corners of all the successive steps of the diagram. Taking a vertical section at any panel point whose distance from *A* is denoted by x , we have seen that the flange-stress, by the method of moments, is given by $\pm H = \frac{px(L-x)}{2d}$. Thus, for instance, at the

section A_3a_4 , the flange-stress will be $\pm H = p \cdot \frac{b \times 7b}{2d} = p \frac{3\frac{1}{2}b^2}{d} = 3\frac{1}{2}Pr$. In

the same way the flange-stress at the next section A_2a_3 will be $\pm H = 6Pr$; at the section A_1a_2 it will be $\pm H = 7\frac{1}{2}Pr$; and at the central section it will be $\pm H = 8Pr$. Thus at all the panel points the angles of the polygonal diagram coincide with the corners of the stepped diagram; but if the

flange-stress is calculated by the method of moments for each panel point of the Linville girder, it is evidently necessary to inquire whether the value thus found is to be taken as applying to the panel on the right hand, or to the panel on the left hand of the vertical section. An inspection of the stress-diagram shows that, in the upper flange, the stress $p \cdot \frac{x(L-x)}{2d}$

applies to the bar extending towards the nearest abutment; but in the lower flange the same stress applies to the bar extending from the joint in question towards the centre of the girder. Thus at the section A_2a_3 the flange-stress $\pm 6Pr$ represents the compressive stress in the bar A_2A_3 , and the tensile stress in the bar a_3a_2 ; and in the same way the flange-stress $\pm 3\frac{1}{2}Pr$ will apply to the bars A_3A_4 , and a_4a_3 respectively.

In any given arrangement of diagonals, a little consideration will show to which bar the theoretic flange-stress at any joint really applies: and it is obvious that in the present case it must be taken as applying to the bars above-mentioned. For if we take the flange-stress at any section, such as the stress $\pm 6Pr$ at the section A_2a_3 , and if we consider the forces acting to the right and to the left of the pin a_3 , it will be evident that, on the right hand, the stress $6Pr$ must be borne wholly by the bar a_3a_2 ; but on the left hand this horizontal pull will be resisted partly by the direct stress in the bar a_3a_4 , and partly by the horizontal component of the tensile stress in the diagonal a_3A_3 . In this way all the horizontal stresses may be found by the method of moments, if sections are taken successively at each vertical post; and having written in the stress in each bar of the flanges, the horizontal components in the diagonal ties may then be found by simple subtraction.¹

In regard to the vertical posts, the compressive stresses written in the diagram are those which take place when the load is applied *at the top* of each vertical. If the entire load is attached at the foot of each post, the compressive stress in each case will be reduced by the amount P ; but the stresses in the remaining members of the girder will be unaltered.

60. If the span is divided into an odd number of panels as in Fig. 80, all the systems will be trapezoids, and the stresses will be somewhat modified. The first or central trapezoid A_1C_1 will carry a load P on each of the two verticals B_1a_1 and B_1c_1 , so that the vertical stress in the diagonals A_1a_1 and C_1c_1 will be equal to P , and therefore greater than in the first system of the last example by the amount $\frac{P}{2}$; and the same difference is carried on through all the other systems. Thus we have the vertical and horizontal stresses—

$$\begin{array}{l} \text{In the 1st system, } A_1C_1, \quad \pm V_1 = P, \quad \pm H_1 = Pr \\ 2d \quad \text{,,} \quad A_2C_2, \quad \pm V_2 = 2P, \quad \pm H_2 = 2Pr. \end{array}$$

¹ It may be observed also that at every vertical section the *bending moment* is represented by the polygonal diagram; but if intermediate sections are taken between the posts, it must be remembered that the diagonal ties take a share in the moment of resistance, and must be considered as forming a part of the tension flange of the girder.

And generally—

$$\text{In the } n\text{th system, } \pm V_n = nP, \quad \pm H_n = nPr.$$

The vertical and horizontal stresses in the various members are written against each bar in the diagram.

The "Linville" truss is generally constructed by combining together the odd and the even systems of panelling, in the manner represented in Fig. 81, thus doubling the number of bays in a span of given width. Let N represent the *total* number of bays in the span, and b the width of each bay; then $r = \cotan. \theta = \frac{2b}{d}$. But at each end of the truss there

will be one diagonal tie in which $r_1 = \cotan. \theta_1 = \frac{b}{d}$; because the two systems are united at the extreme points A_8 and C_8 by the employment of diagonals A_8a_9 and C_8c_9 , inclined at a greater angle, as shown in the diagram.

The truss shown in Fig. 81 is constructed by simply combining together the trusses of Figs. 78 and 80, and adding at each end of Fig.

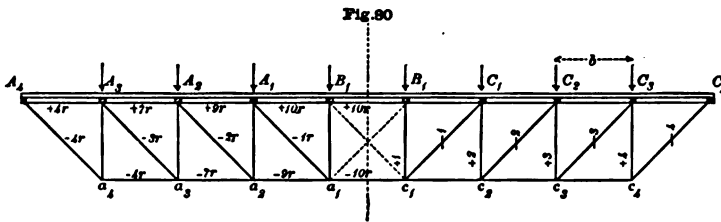

78, the extreme triangles $A_7A_8a_9$. In the combined truss, the width of panel b is reduced to half its former value, and under the same uniform load, the panel-weight pb is reduced in the same proportion. But whatever its value, let P represent the load on each panel point; then the vertical and horizontal stresses in each separate system will be expressed by the same multiples of P as those already found in the previous figures; and these values are written against each of the diagonals.

We may, however, number the successive systems in the order shown in Fig. 81, making the primary *triangular* truss A_1C_1 the first system, and the primary *trapezoidal* truss A_2C_2 the second system, and so on.

$$\begin{aligned} \text{Then in the 1st system, } A_1C_1, \text{ we have } \pm V_1 &= \frac{1}{2}P, & \pm H_1 &= \frac{1}{2}Pr \\ 2d \text{ ,, } A_2C_2, \text{ ,, } \pm V_2 &= 1P, & \pm H_2 &= 1Pr \\ 3d \text{ ,, } A_3C_3, \text{ ,, } \pm V_3 &= 1\frac{1}{2}P, & \pm H_3 &= 1\frac{1}{2}Pr. \end{aligned}$$

And generally—

$$\text{In the } n\text{th system, } \pm V_n = \frac{n}{2} \cdot P, \quad \pm H_n = \frac{n}{2} \cdot Pr.$$

The stresses in the upper and lower flanges are found by simply

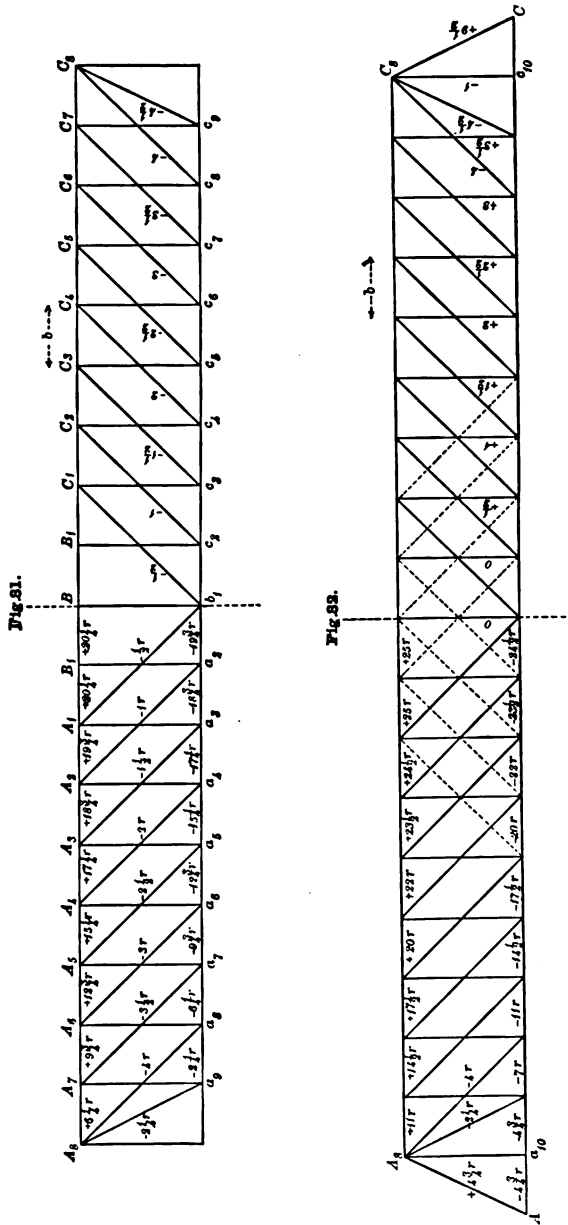

summing the values of $\pm H$ in the same manner as before, and are written against each bar in the diagram.

When the "Linville" truss is used as a "through" bridge, or when the roadway is carried upon the lower flange and between the two main girders, the truss is generally terminated at each end by the inclined struts AA_8 and CC_8 , as shown in Fig. 82, which represents in outline the elevation of the Ohio River Bridge of 415 feet span, erected in 1871. Between the joints A_8 and C_8 this girder is exactly similar to that shown in Fig. 81, and we may say that the bridge consists of that truss suspended at the joints A_8 and C_8 by the upright trapezoidal truss AA_8C_8C . The total load suspended at each of those joints will be $P(4 + 4\frac{1}{2} + 1) = 9\frac{1}{2}P$, as shown at the right end of the diagram; and the horizontal stress throughout the final system or truss AA_8C_8C will therefore be $\pm H = 9\frac{1}{2}Pr_1 = 4\frac{3}{4}Pr$. Adding this quantity to the stress in each bar of the flanges, we obtain the stresses written upon the diagram. The dotted lines represent the counter-braces which are necessary for the support of the rolling load, but have no stress under the uniform load. Lastly, in regard to the vertical posts, if we suppose the uniform load to be carried *entirely* at the lower joints, the stresses will have the values written in the diagram; but it is obvious that, in practice, the weight of the upper flange and of the posts themselves must be duly considered and added to the compressive stresses due to the floor-load.

61. Referring now to the Warren girder, we will first suppose that every joint is loaded with the same weight P , as illustrated for example

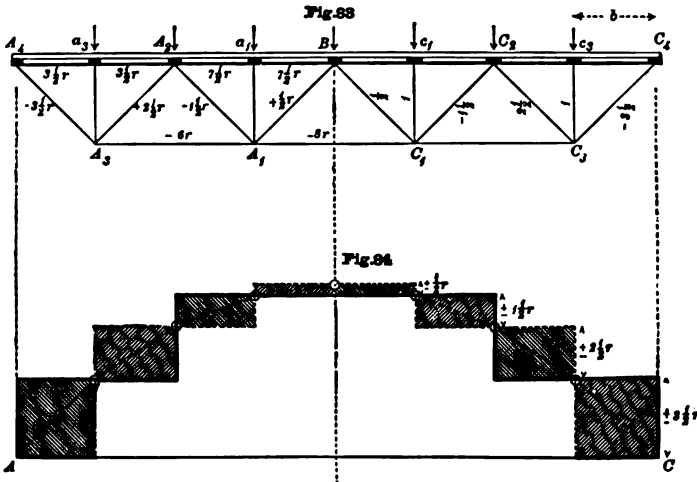

in the case of Fig. 83. In this truss the roadway is carried upon the upper flange, which is divided into eight panels. Between the upper joints or apices of the triangles, vertical posts are introduced by which the intermediate panel-points a_3, a_1, c_1 and c_3 are carried upon the lower joints of the truss.

In the case illustrated, the first system A_1C_1 is an upright triangle,

and the succeeding systems $A_2C_2, A_3C_3, \&c.$, are alternately inverted and upright trapezoids, and we have —

$$\begin{aligned} \pm V_1 &= \frac{1}{2}P, & \pm H_1 &= \frac{1}{2}Pr \\ \pm V_2 &= 1\frac{1}{2}P, & \pm H_2 &= 1\frac{1}{2}Pr \\ \pm V_n &= (n - \frac{1}{2})P, & \pm H_n &= (n - \frac{1}{2}) Pr. \end{aligned}$$

These vertical and horizontal components are written against each brace, and summing the horizontal stresses we have the values of flange-stress shown in the figure.

In the diagram of horizontal stresses, Fig. 84, the compressive and tensile stresses are both shown on the upper side of the base-line AC . The full line is the stepped diagram of stress for the upper flange, and the dotted line, which is the stepped diagram for the lower flange, is erected above instead of below the datum. The shaded rectangles are the diagrams of horizontal stress for the braces, and the dotted polygonal line crossing these rectangles diagonally is the diagram of flange-stress for the plate-webbed girder.

It is obvious that by using the method of moments, we may obtain the same values of flange-stress by taking sections at each successive joint of the girder. Sections at A_2 and at A_1 will give us the stresses in the upper flange represented by the corresponding ordinates of the polygonal line; while sections taken at A_2 and at B will give the stresses of the lower flange.

The diagram shows also that in each bay, the *mean* of the two flange-

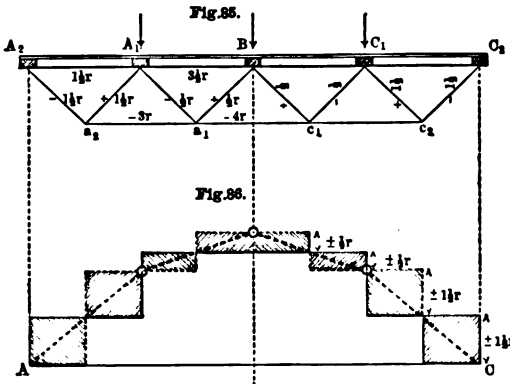

stresses is equal to the *average* stress in the flanges of the plate-girder; and it may be observed that the same remark holds good in the case of the "Linville" truss.

The Warren girder is often constructed, as shown in Fig. 85, without the intervening vertical posts which were introduced in the

last example. In this case the load is entirely carried upon the upper joints; the width of unsupported panel b will now be twice as great as before, and the panel load pb will be twice as great. But let P represent the panel load $= pb$, and let the slope of the braces be denoted as before by $r = \cotan. \theta = \frac{b}{2d}$. The central load at B will be carried across the space

A_1C_1 , by the first system consisting of *two* trusses; viz., the triangle a_1Bc_1 , and the inverted trapezoid $A_1a_1c_1C_1$. The second system will, in

like manner, consist of the two remaining trapezoids, which carry the pair of weights at A_1 and C_1 , across the span A_2C_2 .

The vertical and horizontal stresses in *each* truss of the several systems will be as follows—

$$\begin{array}{lll} \text{Trusses of 1st system, } A_1C_1, & \pm V_1 = \frac{1}{2}P, & \pm H_1 = \frac{1}{2}Pr \\ \text{,, } 2d \text{ ,, } A_2C_2, & \pm V_2 = 1\frac{1}{2}P, & \pm H_2 = 1\frac{1}{2}Pr \\ \text{,, } nth \text{ ,, } & \pm V_n = (n - \frac{1}{2})P, & \pm H_n = (n - \frac{1}{2})Pr. \end{array}$$

Summating the flange-stresses in *each* truss of the several systems, we have the values given numerically in the figure, and represented geometrically in the diagram, Fig. 86. The latter diagram is drawn in the same way as Fig. 84, and may be compared with it.

Each of the bridges shown in Figs. 83 and 85 may be turned upside down, and the roadway being in that case attached to the lower flange, the stresses in the various bars will be unaltered in value but reversed in character.

62. If we combine together the upright and the inverted forms of the Warren girder, we obtain the lattice girders illustrated in Fig. 87 and Fig. 89. In the case of Fig. 87, the two systems are united by vertical posts or ties at each panel-point, and a question then arises as to how much of the panel load will be carried by those verticals; for it will be observed that we have here a combination of two systems, each offering to carry the same element of the load.

Take for example the simple case illustrated in Fig. 91; in which the girder consists of two bays only, and is loaded with a central weight suspended as in the figure. It is obvious that this weight *may* be carried by the triangle aBc , but the inverted triangle AbC is equally capable of carrying it. If we begin to inquire in what proportions the load will be divided between these two trusses, the first thing that we notice is that the upright triangle can receive no load at all except through the tension of the tie Bb ; and the strain or stretching of that tie will be the measure of its stress, and, therefore, of the load suspended upon the apex B . But the strain of each of the vertical members is bound up with the relative deflections of the two trusses.

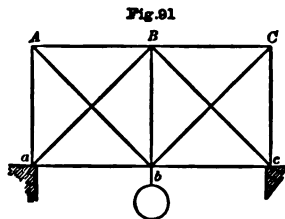

Leaving the question of elastic deflection for the present, we may first suppose that, in Fig. 87, the panel-weights are attached in such a manner that one half of each is carried by the upper joint of the truss and the other half transmitted by the post to the lower joint. Then, if we regard the lattice girder as composed of two Warren girders similar to Fig. 83 (one upright and the other inverted), the load on each joint, and the stress in each diagonal brace, will be exactly half the value given in Fig. 83; and summating the horizontal components, as before,

we obtain the flange-stresses written against each bar in Fig. 87 and again represented in the diagram, Fig. 88. In the latter diagram, the

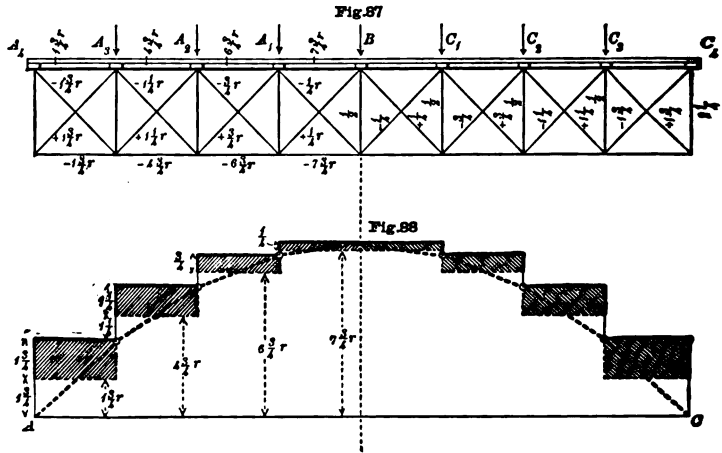

dotted lines of the stepped figure represent the diagram of compressive stress in the upper flange, and the shaded rectangles are the diagrams of

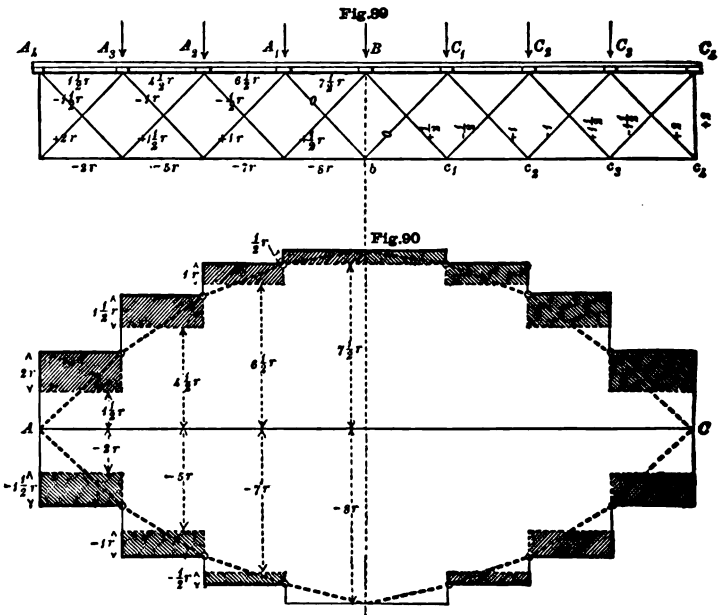

horizontal stress in the diagonal struts. The negative or tension diagram is exactly similar. Comparing this diagram with the polygonal line, it

will be noticed that in every bay of this girder, the stress in *each* flange is equal to the average stress in the flange of the plate girder.

We will now suppose that the vertical connecting members are totally ineffective, or that they are omitted from the structure, as in the case of the girder shown in Fig. 89. The system $Bc_1C_2c_3C_4$ will be situated under the same conditions as the girder of Fig. 85, and the stresses in those diagonals may be written in accordingly. But the remaining system $BC_1c_2C_3c_4$ will be similar to Fig. 85 inverted and loaded at the upper joints. The bars A_1b and C_1b will have no stress; and the system will commence with the trapezoid BC_1c_2 . The vertical components in the remaining diagonals being written in accordingly, and the horizontal components summated in the manner before described, we obtain the stresses given in the figure. The diagram of horizontal stress, Fig. 90, may be compared with that given in Fig. 88. The entire diagram (including the shaded rectangles) is the same on the positive and negative sides, as it must always be; but the stress in the lower flange is greater than in the upper, although the mean value of the stress in the two flanges is the same as before.

63. The same methods may be applied to other cases, in which the span is divided into an odd number of bays, or to others in which the bracing is reduplicated. The results obtained will vary a little in each case, but in every instance the *mean value* of the stress in the two flanges will, in each bay, be the same as that indicated by the polygonal line inscribed in the parabolic curve. The mean height of the parabola being two-thirds of its maximum height, the mean stress in the flanges of the plate girder (continuously loaded) will be $\frac{pL^2}{12d}$; and if N is the number of panels (determined by the points of imposition of the load), the mean height of the polygonal diagram (having N sides) will be $\frac{pL^2}{12d}\left(1 - \frac{1}{N^2}\right)$. This value, therefore, represents the *average stress in the flanges of every parallel lattice girder*, and is exactly one half of the stress in the boom of the "Bollman" or "Fink" truss, and exactly two-thirds of the stress in the trapezoidal truss illustrated in No. 37.

64. In the foregoing survey and classification of bridge-structures, it will be observed that we have completed a sort of circular tour, beginning and ending with the parallel girder. In the first instance the girder was considered as a simple structure or beam, carrying the whole uniform load by its resistance to transverse bending; but in the present chapter it has been regarded as a composite structure or truss. These two aspects represent the ideas which have formed the basis of English and American practice respectively. In England the simple beam was refined into a plate girder, and the plate web was improved by the substitution of diagonal bracing. But in America, bridge-construction was at first very largely carried out in timber, or in combinations of timber and wrought iron; and these materials were framed together in various forms of truss,

from which the wrought-iron trusses of the Linville, Whipple, and other types have been developed.

The forms of lattice girder which have been reached by these two opposite lines of progress, are practically identical in principle ; but the same difference of fundamental ideas still marks the character of girder-construction as carried out in the two countries. In American girders (or trusses, as they are still called), each member is treated as having a separate and simple function to perform ; but in England, although the subdivision of function is allowed in theory, yet in practice all the members are rivetted up together so as to make the girder, as far as possible, a rigid whole, resembling in some degree the solid beam from which it is derived.

DIVISION E.

Plate. E.

COMPOSITE BRIDGES, INCLUDING THE UPRIGHT AND THE INVERTED FORM.

	<i>Triangles.</i>	<i>Trapezoids.</i>
SITE TRUSSES INVERTED TRUSSES.	<p>N^o 36.</p>	<p>N^o 37.</p>
RIGHT LINK SUSPENSION BRIDGES.	<p>N^o 38.</p>	<p>N^o 39.</p>
	<i>Triangles, upon Triangles.</i>	<i>Trapezoids, upon Trapezoids.</i>
SITE TRUSSES PARALLEL GIRDERS.	<p>N^o 40.</p>	<p>N^o 41.</p>
SITE TRUSSES PARALLEL GIRDERS.	<p>N^o 42.</p>	<p>N^o 43.</p>

BRIDGES COMPOSED OF
TRUSS AND LEVER, OR
TRUSS AND SUSPENSION.

N^o 44.

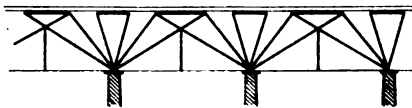

N^o 46.



N^o 45.





CHAPTER VII.

THE THEORETICAL WEIGHT OF BRIDGES.

65. For many purposes it is useful to have at our command some means of estimating approximately the weight of metal that will be required in the construction of a bridge of any given design, in which the span and the total load are known or assumed beforehand. In any case such a calculation may be used as the basis of an approximate estimate of *cost*; but in the case of large bridges the calculation must be made for the purpose of ascertaining what is the actual dead-weight to be carried; for in addition to the "useful" load (or the weight of train and roadway)¹ we have also to consider the weight of the girder itself as part of its gross load. In the case of *very* large bridges the weight of the structure itself becomes so great in comparison with the useful load, that the calculation is of still greater importance as indicating the comparative economy² of different designs, and determining the question whether the bridge can be built at all.

It is obvious that the weight, or the cubic quantity of metal, in any prismatic member will depend only on its length and the area of its cross section; the length of each member is given in the design itself, while the sectional area is generally made nearly proportional to the *stress* which each particular member has to bear, subject to certain limitations to be presently mentioned. We shall here consider only the duty of carrying the uniform *dead* load, for which the stresses have been already found; but the same method of calculation will be applicable to the other distributions of load that remain to be dealt with.

66. **Diagram of Metal.**—In the last division of our subject, the bending moment was analysed into its two factors—depth of girder and stress of flange; and now we have to analyse in the same way the flange-stress, which is the product of two quantities, viz., sectional area of flange and intensity of "working stress." Here again there are two opposite cases to consider.

First, We may have (in a parallel girder) a uniform section of flange

¹ By a curious, but very common, inversion of terms, the adjective "useful" is applied to that portion of the gross load which renders no assistance to the main girders in the performance of their function. The use of the word indicates—not that the *load* is especially *useful*, but that the carrying of this load is the useful function of the bridge.

² The sense in which "economy" is here meant, and its value in bridge-construction, were referred to in the Introduction.

throughout, and a varying intensity of stress; in this case the diagram of flange-stress will represent, on a certain scale, a *diagram of stress-intensity*; but the uses of the diagram in this capacity will be treated in the next chapter.

Secondly, We may adopt a uniform standard intensity of working stress, giving to the flange therefore a varying sectional area; and in this case the diagram of flange-stress will become a *diagram of metal*. This is the purpose for which we now have to employ the diagrams that have been traced in the last chapter and in Chapter IV.

67. Weight of Metal in terms of Stress.—

Let S represent the actual stress in any bar, in tons.

t , the working intensity of tensile stress, in tons per square inch,

c , the working intensity of compressive stress, in tons per square inch;

then the sectional area that we must adopt for the bar will be at least $\frac{S}{t}$

in the case of a tie, and $\frac{S}{c}$ in the case of a strut.

In well-designed ironwork the areas will be made to approximate to these values as closely as possible; but there will always be some waste which cannot be avoided, and we must therefore make allowance for the following items, viz.—

1st. The loss of effective area by rivet-holes.

2d. The weight of the rivet-heads.

3d. The weight of cover-plates for the joints.

4th. The unavoidable excess of the actual section, in some places, above the theoretic area, owing either to the impracticable thinness of the theoretic section, or to the difficulty of producing in practice a member of tapering form. This allowance may perhaps be extended so as to include the weight of connections between the members.

We may allow for all these items of waste by adding a certain percentage, or by multiplying the net theoretic sectional area by a coefficient κ to be derived from actual examples.¹

A bar of wrought iron, one foot in length, with a sectional area of one square inch, weighs 3·34 lbs., or 0·03 cwt., or 0·0015 ton.² If a bar has to bear a tensile stress of 1 ton, its net sectional area in square inches will be $\frac{1}{t}$, and its gross sectional area in square inches, including waste,

will be equivalent to $\frac{\kappa}{t}$; its weight per lineal foot will therefore be

$\gamma_t = 0015 \frac{\kappa}{t}$; and in like manner, if the bar is a strut adapted to bear a

compressive stress of 1 ton, its weight per foot lineal will be expressed

by $\gamma_c = 0015 \frac{\kappa}{c}$.

¹ The value of κ will vary according to the construction of the member, and will be considered hereafter.

² For steel, an addition of about 2 per cent. may be made.

We shall use the symbols γ_c and γ_t for the practical weight of all tension and compression members per foot lineal, and per ton of stress, reserving for future consideration the proper values of the working stresses c and t ; and we shall keep separate the calculated weights of the flanges and those of the web or bracing, so that a special working stress may be taken for the bracing, if that should appear desirable. Therefore if s represents the length of any member in feet, and S the direct stress, the weight of the member will be $Ss\gamma_c$ or $Ss\gamma_t$, for struts and ties respectively.

68. Stress and Weight of an Inclined Bar.—We have already found, in each class of bridge-construction, the horizontal and vertical components of the stress in the various members, and the values thus found will apply to any girder or structure of the specified type, whatever may be the angle of the inclined bars, or the proportion of length to depth of girder; but we have not worked out the actual numerical value of the *direct* stresses in the inclined bars for two reasons—1st, because the values so found would only be applicable to one particular case, and will vary with every arbitrary variation in the proportions of the design; and 2dly, because it is a very simple matter to find the direct stress in any given case, when the horizontal or the vertical component is known.

In Fig. 92 let BC represent the inclined tie in any American truss, or in the bracing of a girder, or in the chain of a suspension bridge; and let AC and AB be horizontal and vertical lines drawn from its extremities. In the usual order of designing the structure, AC and AB are first determined, and to find the length of the inclined tie we have $s^2 = h^2 + v^2$. Also let Fig. 93 be a precisely similar triangle representing the direct stress S and the horizontal and vertical components H and V . Then to find the direct stress, we have $S^2 = H^2 + V^2$, or—

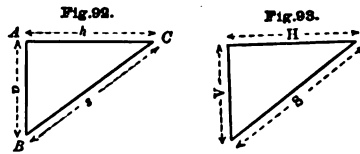

$$S = \sqrt{H^2 + V^2} = H \cdot \frac{s}{h} = V \cdot \frac{s}{v}$$

Now if these two diagrams are drawn to the same dimensions, it will be obvious, without any lengthy demonstration, that $Ss = Hh + Vv$.

Therefore, we have at once the weight of any inclined bar in terms of its horizontal and vertical components (of stress and length) $Ss\gamma_t = \gamma_t(Hh + Vv)$; and adding together the weights of the different members as found by this formula, we may easily obtain the total theoretical weight of any bridge structure.

The products Hh are represented by the areas of the several diagrams of horizontal stress which were considered in the last chapter; and it would not be difficult to construct also diagrams of the vertical height

and vertical stress, whose area should indicate in like manner the second term of the above equation, or the products Vv .

69. **Example.**—To illustrate the general method of calculation, we may take the girder shown in Fig. 78, in which the stresses have already been considered. The horizontal length of every bar is $h = b = \frac{L}{N}$, excepting the vertical posts in which $h = 0$. The vertical height of every bar is $v = D$, excepting the flanges in which $v = 0$. Then commencing with

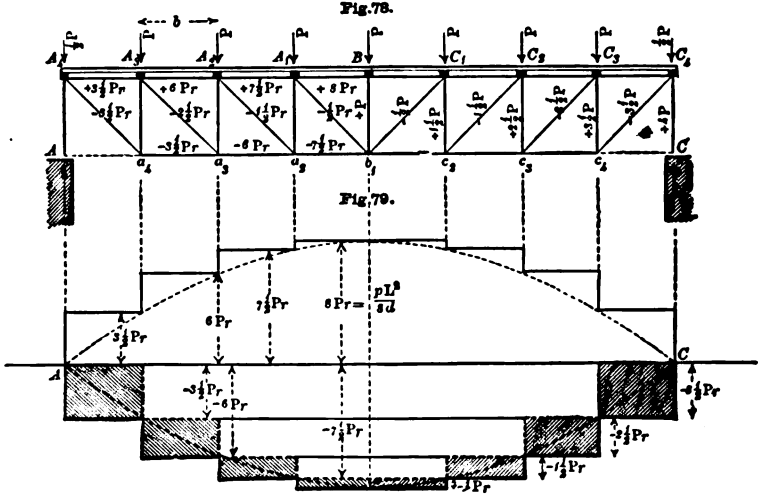

the tension members, and reading off from the diagram the horizontal and vertical stresses, we have the following values for either half of the girder, viz:—

Tension members.

$$\text{Inclined Ties } \Sigma \cdot Hh = Prb(\frac{1}{2} + 1\frac{1}{2} + 2\frac{1}{2} + 3\frac{1}{2}) = 8Prb$$

$$\Sigma \cdot Vv = PD(\frac{1}{2} + 1\frac{1}{2} + 2\frac{1}{2} + 3\frac{1}{2}) = 8PD$$

$$\text{Weight} = \gamma_r P(8rb + 8D)$$

$$\text{Lower Chord } \Sigma \cdot Hh = Prb(7\frac{1}{2} + 6 + 3\frac{1}{2}) = 17Prb$$

$$\Sigma \cdot Vv = 0$$

$$\text{Weight} = \gamma_r P(17rb)$$

In estimating the weight of the compression members, we shall omit the end-pillar A_4A , supposing the abutments to be carried up and the girder to be supported at the upper joint upon a bed-plate; then halving the central post, we have for the half-girder A_4B :—

Compression members—

$$\text{Vertical posts } \Sigma \cdot Hh = 0$$

$$\Sigma \cdot Vv = PD(\frac{1}{2} + 1\frac{1}{2} + 2\frac{1}{2} + 3\frac{1}{2}) = 8PD$$

$$\text{Weight} = \gamma_c P(8D)$$

$$\begin{aligned}\text{Upper chord } \Sigma \cdot Hh &= Prb(8 + 7\frac{1}{2} + 6 + 3\frac{1}{2}) = 25Prb \\ \Sigma \cdot Vv &= 0 \\ \text{Weight} &= \gamma_c P(25rb).\end{aligned}$$

It will be more convenient, however, to express the several weights in terms of the whole dead load pL , the span L , and the depth D , or the ratio of span to depth, viz., $R = \frac{L}{D}$; and if N is the number of panels, we have in the case before us, $P = \frac{pL}{N}$, $r = \frac{R}{N}$, $b = \frac{L}{N}$; therefore—

$$Prb = pL \cdot \frac{RL}{N^3}; \text{ and } PD = pL \cdot \frac{D}{N}.$$

Then taking both halves of the girder together, the weights will be as follows:—

Tension members—

$$\begin{aligned}\text{Inclined ties, weight} &= \gamma_c pL \left(\frac{16}{8^3} RL + 2D \right) \\ \text{Lower chord, } &,, = &,, \left(\frac{34}{8^3} RL + 0 \right) \\ \hline \text{Total weight of ties,} &= \gamma_c pL \left(\frac{50}{8^3} RL + 2D \right)\end{aligned}$$

Compression members—

$$\begin{aligned}\text{Vertical posts, weight} &= \gamma_c pL (0 + 2D) \\ \text{Upper chord, } &,, = &,, \left(\frac{50}{8^3} RL + 0 \right) \\ \hline \text{Total weight of struts} &= \gamma_c pL \left(\frac{50}{8^3} RL + 2D \right)\end{aligned}$$

These values will apply to any girder of the type given, *i.e.*, a parallel girder of eight equal bays, with a single web-system of vertical posts and inclined ties, whatever may be the ratio of length to depth.

70. It will be noticed that in the last example the total weight of all the ties is expressed by the same numerical coefficients as those which give the total weight of all the struts, and this is only one example of a general rule which we may now briefly consider, as it will serve to simplify the calculations.

Let all compressive stresses be taken as positive, and all tensile stresses as negative, and proceed to consider their algebraical sum. At any vertical section through the girder, $\Sigma \cdot H = 0$; and as this must be true at any and every vertical section, it follows that for any slice of girder contained between two vertical sections, $\Sigma \cdot Hh = 0$; and therefore for the whole girder $\Sigma \cdot Hh = 0$. This means that the entire positive and negative diagrams of horizontal stress must have the same figure and the

same area—which indeed we have seen to be the case in each example. Next imagine a *horizontal* section to be taken through the whole girder, and consider the vertical forces. If the load pL is on the top of the girder, while the supports are at the base, we shall have $\Sigma \cdot V = pL$; but suppose the entire load (as well as the supporting forces) to be applied at the lower horizontal flange of the girder, then $\Sigma \cdot V = 0$, and $\Sigma \cdot Vv = 0$, and consequently $\Sigma \cdot Ss = 0$. In this case, therefore, the sum of the products Ss for all the struts must necessarily be equal to the sum of the negative products $-Ss$ for all the ties. The same thing will be true if the entire load *and* the supporting forces are applied at the joints of the upper horizontal flange, as supposed in the calculation of Art. 69 for the bridge shown in Fig. 78.

It may be worth while to notice here that economy of construction is often sought to be obtained by reducing the length and the stress of the compression members; and it is perhaps sometimes imagined that this may be done by some skilful *arrangement of the parts* of a girder; but the rule above pointed out, and exemplified throughout the following calculations, shows that it is impossible, by any arrangement of the parts of a girder, to make the sum $\Sigma \cdot Ss$ for the struts less than the sum $-\Sigma \cdot Ss$ for the ties. This can only be done by subjecting the structure *as a whole* to a pair of external opposite pulls, as in the case of a suspension bridge, or in the case of a girder supported at the upper flange and loaded at the lower flange. If the structure is *not* subjected to such external pulls, the theoretical weight of all the struts *must* be equal to that of the ties, whatever may be the arrangement of the component members.

Referring now to the vertical forces, it is obvious that the statement $\Sigma \cdot V = 0$ will only be true if the *entire* load is applied at those joints which are at the same level as the bed plates. If the entire load is applied at the top and the supporting forces at the base, the whole girder is subjected to a pair of compressive forces, and $\Sigma \cdot V = pL$; therefore we have to add to the calculated weight of the vertical posts or compression members the quantity $\gamma \cdot pLD$; which, in the case of Fig. 78, represents the weight of the two terminal posts A_4A and C_4C ; and generally when the load is applied in this manner, its effect will be to add 1 to the numerical coefficient of D in the expression for the vertical compression members or vertical components; while the expression for the metal of the horizontal flanges will remain unaltered.

Again, if we wish to be very accurate in this calculation, it will perhaps be hardly sufficient to assume that the *whole* load is applied at one line of joints; thus in the case of a "through" bridge, although the weight of the roadway together with that of the lower flange and wind-bracing and about half the weight of the web, are actually applied at the lower joints, yet there remains about half the weight of the girder itself, which must be taken as a separate load applied at the upper joints. In very large bridges it will be necessary to make this detailed calculation for

each case; but in bridges of moderate dimensions the load may be treated as applied wholly at the line of joints corresponding with the level of the roadway, as this assumption will not sensibly affect the estimate for the weight of metal.

71. Following the method described in Art. 69, the theoretic weight of metal in any other type of bridge may be expressed in terms of its load and its leading dimensions; and, as in the example already worked out, the expression for the weight of the ties will have the general form—

$$W_t = \gamma_t pL(\alpha RL + \beta D)$$

and for the struts—

$$W_c = \gamma_c pL(\alpha RL + \beta D)$$

in which α and β are numerical coefficients depending upon the type of bridge-construction. The value of these numerical coefficients for the different forms of bridge are given in detail in Tables 1 to 16. In each Table the span is supposed to be successively divided into the number of panels N , as indicated at the head of each column; and the coefficients will apply to any bridge of the type specified and consisting of N panels, whatever may be the angle of the inclined bars.

As regards many of these designs, it will not be difficult to express the weight of metal by a general formula which shall be applicable for any arbitrary value of N ; although in some cases the formula would be somewhat cumbersome, and, therefore, less useful than the Tables. We shall briefly refer to a few of the most important cases.

72. In the case of a parallel girder, with a plate web, and with a load uniformly distributed, the average stress in each flange according to the parabolic diagram is $\frac{2}{3} \times \frac{pL^2}{8D} = pL \cdot \frac{R}{12}$; and therefore for each flange the coefficient will be—

$$\alpha = \frac{1}{12} \dots \dots \dots (1)$$

If, however, the load is divided between cross-bearers spaced at equal intervals and dividing the span into N equal bays, the diagram becomes an inscribed polygon of N sides, whose area is equal to that of the parabola multiplied by $(1 - \frac{1}{N^2})$. Therefore, for each flange, the coefficient will be—

$$\alpha = \frac{1}{12} \left(1 - \frac{1}{N^2}\right) \dots \dots \dots (2)$$

In every parallel girder, the above formula (2) will give the mean value of the coefficients for the two flanges; but when the ties of the lattice-web are inclined at a different angle from that of the struts, the coefficient for one flange is increased, and the coefficient for the other flange diminished.

73. Table 1 refers to parallel girders with a single bracing of inclined ties and vertical struts, and the coefficients will apply either to through bridges or deck bridges, supposing the latter to be supported at the ends of the upper chord. If the span is divided into an *even* number of panels, the coefficient for the vertical posts is—

$$\beta = \frac{N}{4} \dots \dots \dots (3)$$

and the coefficients for the inclined ties will be—

$$\alpha = \frac{1}{4N}, \text{ and } \beta = \frac{N}{4} \dots \dots \dots (4)$$

The coefficient for the upper flange will then be—

$$\alpha = \frac{1}{12} \left(1 - \frac{1}{N^2} \right) + \frac{1}{8N} \dots \dots \dots (5)$$

and for the lower flange—

$$\alpha = \frac{1}{12} \left(1 - \frac{1}{N^2} \right) - \frac{1}{8N} \dots \dots \dots (6)$$

On the other hand, if *N* is an odd number, the values are slightly altered, as shown in Table 1A. The formulæ for this case are not difficult to deduce, but the Table will probably suffice.

Table 2 gives the weight of metal in a Linville girder, with double bracing; while Table 3 refers to a Linville girder of the same general type, but terminated at each end by an inclined strut instead of a vertical post.

74. Table 4 relates to the Warren girder, used as a deck bridge. Each *main* panel is subdivided by a vertical post, and *N* represents the *total* number of subdivisions.

For the vertical posts—

$$\beta = \frac{1}{2} \dots \dots \dots (7)$$

For the diagonal struts the coefficients will be—

$$\alpha = \frac{N-2}{8N^2}, \text{ and } \beta = \frac{N-2}{8} \dots \dots \dots (8)$$

On the other hand, the values for the diagonal ties will be—

$$\alpha = \frac{N+2}{8N^2}, \text{ and } \beta = \frac{N+2}{8} \dots \dots \dots (9)$$

The coefficients for the flanges will be—

$$\text{Upper flange} \dots \dots \alpha = \frac{1}{12} \left(1 - \frac{1}{N^2} \right) + \frac{1}{4N^2} \dots \dots (10)$$

$$\text{Lower flange} \dots \dots \alpha = \frac{1}{12} \left(1 - \frac{1}{N^2} \right) - \frac{1}{4N^2} \dots \dots (11)$$

Table 4A gives the values for the same girder when inverted and used as a through bridge; the stresses being exactly reversed, the coefficient for each member in its inverted position remains the same.

Table 5 refers to the Warren girder without verticals; and whether this girder is used as a deck bridge, or in its inverted form as a through bridge, the coefficients for the struts and for the ties have the same value. If N is any *even* number, we shall have, for each flange—

$$\alpha = \frac{1}{12} \left(1 - \frac{1}{N^2} \right) \dots \dots \dots (12)$$

and for the diagonal struts or diagonal ties the coefficients will be—

$$\alpha = \frac{1}{16N}, \text{ and } \beta = \frac{N}{4} \dots \dots \dots (13)$$

75. Table 6 refers to the lattice-girder with single intersections, and the given values are calculated upon the assumption mentioned in Art. 62, viz., that half the load at each panel-point is transmitted through the vertical member, so that the whole load is by this means equally divided between the upper and lower joints; and it is also assumed that the load is attached to the girder at the same level as the supporting forces, which may be either at the top or bottom of the girder or at any intermediate level. It follows that the coefficient for the whole series of vertical posts (including the end-pillars) will be—

$$\beta = \frac{N-1}{2N} \dots \dots \dots (14)$$

and the same for the vertical ties.

For each flange we shall have again—

$$\alpha = \frac{1}{12} \left(1 - \frac{1}{N^2} \right) \dots \dots \dots (15)$$

and if N is an even number, the coefficients for the diagonal struts or diagonal ties, will be—

$$\alpha = \frac{1}{8N}, \text{ and } \beta = \frac{N}{8} \dots \dots \dots (16)$$

76. Turning to the "Fink" truss (Table 7) we have for the main boom—

$$\alpha = \frac{1}{4} \left(1 - \frac{1}{N^2} \right) \dots \dots \dots (17)$$

The coefficient α will also have the same value for the whole group of inclined ties as already shown in Art. 56; while the coefficient β for both ties and posts will have the values given in the Tables.

77. In the case of the Bollman truss (Table 8) and the straight link

suspension bridge (Table 9), the coefficient for the inclined ties, as shown in Art. 53, are—

$$\alpha = \frac{1}{6} \left(1 - \frac{1}{N^2} \right), \text{ and } \beta = \frac{N-1}{N} \quad \dots \quad (18)$$

and the same values will apply respectively to the horizontal boom and the vertical posts of the Bollman truss. In the suspension bridge there is no boom, but we have to consider the metal of the end pillars or towers; and in every such case we shall only calculate the metal required to carry the load of the central span, or the load $pL \cdot \frac{N-1}{N}$, which is suspended from the towers by the group of inclined ties. If the suspension bridge consists of two side spans in addition to the central span, the total load on the towers will be nearly double this amount because the towers will have to support, in addition, the vertical component of the stress in the backstays; but whatever vertical force may be impressed upon the towers by the inclined backstays or chains of the side spans, we shall suppose it to be carried by a separate column, or pillar, as shown in the skeleton illustrations of No. 11 and No. 12 in Plate B; and the metal of this separate column will be treated as belonging to the side span and not to the central span.

78. Referring now to Tables 10, 11, and 12, we may remark that the coefficients for the inclined struts or ties have the same value in each of the three structures therein referred to. Table 10 gives the calculation for the members of an upright trapezoidal truss; while Table 11 refers to the corresponding form of straight link suspension bridge, and Table 12 refers to the same type of structure when used as a purely cantilever bridge; the structure being supposed, in the last case, to be divided at the centre into two halves, each of which forms an independent cantilever.

The coefficients for the inclined members in each of these three designs will have the values—

$$\alpha = \frac{1}{12} + \frac{1}{6N^2} \text{ and } \beta = \frac{N-1}{N} \quad \dots \quad (19)$$

For the boom of the cantilever bridge (Table 12) the value of α is same as above given; but for the upper boom of the trapezoidal truss (Table 10), and the horizontal tie of the suspension bridge (Table 11), that coefficient will have the value—

$$\alpha = \frac{1}{24} - \frac{1}{6N^2} \quad \dots \quad (20)$$

It will be noticed that the coefficient for the horizontal tie of the trapezoidal truss has the constant value—

$$\alpha = \frac{1}{8} \quad \dots \quad (21)$$

In each example given in the Tables, N is always an even number, the central system being a triangle. If the span is divided into an odd

number of bays the formulæ become slightly altered. The stresses in these types of bridge were considered in Arts. 54 and 55.

79. Lastly, we may turn to the parabolic bowstring, and the equilibrated arch and suspension bridge, forming the Second and Third Groups illustrated in Tables *A* and *B* in Chapter V; and to the series of polygonal trusses and funicular polygons comprised in the same groups and illustrated in Tables *C* and *D*.

Let *N* represent the number of equal bays into which the span is divided; then if *N* = 2, the truss or polygon becomes a triangle; if *N* = 3, it becomes a single trapezoid; and these forms of truss having already been considered under different groups, it remains only to deal with polygonal trusses of four or more sides.

In every case the horizontal stress in the several bars of the polygon has the same value throughout, while the vertical stress in each bar is proportional to the vertical height subtended by the bar, and summing these vertical stresses and vertical heights, we obtain the values of β given in Table 13, which refers to polygonal bowstring girders. If *N* is an even number, the depth of the truss *D* at the central joint will be equal to the depth of the circumscribing parabola; and the horizontal stress being $H = \frac{pL^2}{8D} = pL \cdot \frac{R}{8}$, the coefficient will be—

$$\alpha = \frac{1}{8} (22)$$

which will apply to the horizontal tie as well as to the polygonal bow.

The total load carried by the vertical rods at the joints of the polygon will be $pL \cdot \frac{N-1}{N}$, and their average height will be $\frac{2}{3}D \times \frac{N+1}{N}$. Therefore the coefficient for the whole series of verticals will be—

$$\beta = \frac{2}{3} \left(1 - \frac{1}{N^2} \right) (23)$$

and the coefficient β for the inclined bars of the polygon will have the same value.

On the other hand, if *N* is any odd number, the coefficient will be—

$$\alpha = \frac{1}{8} \left(1 - \frac{1}{N^2} \right) \text{ and } \beta = \frac{2}{3} (24)$$

The above values will apply not only to the bow of the bowstring, but also to the polygonal arch, and the chain of the polygonal suspension bridge, as shown in Tables 14 and 16.

In the case of the arch, if the roadway is carried at the level of the crown, the coefficient for the vertical spandril pillars, including the terminal pillars as shown in No. 8 of Plate *A*, will be—

$$\text{For } N = \text{any even number, } \beta = \frac{1}{3} \left(1 + \frac{2}{N^2} \right) . . (25)$$

$$\text{For } N = \text{any odd number, } \beta = \frac{1}{3} (26)$$

and in either case the coefficients for the arch and spandrils together will be—

$$\alpha = \frac{1}{8} \text{ and } \beta = 1 \dots \dots \dots (27)$$

In the case of the suspension bridge the values for the chain are precisely the same as those given for the linear arch; and the vertical suspending rods take the place of the spandril pillars; the extreme verticals at each end are, however, no part of the suspension system, but are towers or columns bearing the whole suspended load. For the vertical towers, therefore—

$$\beta = \frac{N - 1}{N_1} \dots \dots \dots (28)$$

Finally, we may consider the *parabolic curve* of an arch or suspension chain as being equivalent to a polygon having a very large number of sides, each side of the polygon subtending the very short horizontal length $b = \frac{L}{N}$; and making N a very large number, or $N = \infty$, we have for the weight of metal in the parabolic linear arch, or the parabolic suspension chain, the coefficients—

$$\alpha = \frac{1}{8} \text{ and } \beta = \frac{2}{3} \dots \dots \dots (29)$$

Also if $N = \infty$, the coefficient for the vertical spandril pillars of the arch, or the vertical suspenders of the chain bridge, will be—

$$\beta = \frac{1}{3} \dots \dots \dots (30)$$

80. It may be well to remark that the foregoing Formulæ and Tables must be taken only as representing the quantity which they profess to give, viz., a summation of the lengths of the several members multiplied by a theoretic sectional area proportional to the direct stress in each member. We have traced out a simple and convenient method of making this summation for each type of bridge, and in such a form that the coefficients in each case are applicable to any arbitrary ratio of depth to span. The quantities thus found must of necessity form the first foundation of any study of economics in bridge-construction; but it is quite obvious that before they can be applied to such a purpose, or to the detailed computation of the weight of any proposed structure, there are a number of questions that still remain to be considered.

In the first place the value of γ_c and γ_n , or the specific weight of members per ton of stress, has yet to be considered; and it will be found that these are not always constant quantities for a whole set of members, and this will be especially noticeable in the case of long struts carrying a comparatively light load, as, for instance, in the central portion of the web-bracing of any parallel girder.

Again, the quantities that have been determined in this chapter relate only to the mass of metal required to carry a uniform load, and when the rolling load is considered it will be found that a somewhat different set of stresses will have to be provided for. In some types of bridge, as, for instance, in the Warren and single lattice girder, the new stresses will necessitate only a certain alteration in the relative sectional areas of some of the members; but in the Linville girder it will be necessary to introduce, for the support of the rolling load, certain counterbraces which are not required for the uniform load; while the parabolic bow-string will then require a whole system of diagonal bracing which is theoretically useless for the uniform load, and has therefore not been included hitherto in the estimated weight of metal.

In the same way the linear arch, which in theory is equilibrated under the uniform load, must be regarded as merely an ideal structure whose form and construction will have to be materially altered before it can be adapted to the purpose of carrying a rolling load. On the other hand, the common flexible suspension bridge may be considered as being fully represented, for all practical purposes, by the parabolic chain and vertical suspenders of Table 16, so far at least as these essential members of the structure are concerned; and the same may be said of the Fink truss and the Bollman truss, illustrated in Tables 7 and 8, and also of the derived straight link suspension bridge of Table 9; but the forms of straight link bridge treated in Tables 11 and 12 will require some special consideration in regard to the effect of the rolling load.

It will of course be understood that, in every case, the Tables and Formulæ refer only to the main girders or the principal longitudinal superstructure of the bridge, and do not include any metal that may be required for the cross-girders, stringers, or distributing girders, forming the platform of the bridge. These details, as well as the construction of the necessary windbracing, and the transverse stiffening of the structure, must be considered separately for each type and variety of bridge; and it will also be necessary to treat separately each type of bridge-construction as regards the effect of the rolling load and the structural provision that must be made for its support.

81. We may here illustrate the application of the Tables by taking the case of a common suspension bridge having a span of 700 feet and a versine of 70 feet, or $\frac{1}{10}$ th of the span, corresponding nearly with the actual dimensions of the Clifton suspension bridge. Assuming, for the sake of example, that the working stress is 5 tons per square inch in the main chains, and 4 tons in the vertical suspenders, we may take it that the percentage of "waste metal" in a chain composed of edge-links with swelled ends will amount to about 20 per cent. including the connecting pins; so that for the main chains we may estimate that $\kappa = 1.20$ and $\gamma_1 = \frac{1.20 \times .0015}{5} = .00036$; while for the vertical rods we

may perhaps take the same percentage of waste to include end connections, and $\gamma = \frac{1.20 \times .0015}{4} = .00045$.

Then if we have to provide for a total dead and live load of $2\frac{1}{2}$ tons per foot lin., or a gross load of $2\frac{1}{2} \times 700 = 1750$ tons *uniformly distributed*, the curve of the equilibrated chain will be a parabola, and the weight of the whole chains from tower to tower will be—

$$.00036 \times 1750 \left\{ \left(\frac{1^0}{8} \times 700 \right) + \left(\frac{2}{3} \times 70 \right) \right\} = 581 \text{ tons,}$$

or say 16.6 cwt. per foot of span.

At the centre of the span the tensile stress will be $1750 \times \frac{1^0}{8} = 2187.5$ tons, requiring a sectional area of 437.5 square inches; and adding 20 per cent. for waste metal, the weight of the chain at this point will be $525 \times 0.03 = 15.75$ cwt. per foot. But as we proceed from the centre towards each tower, the direct stress increases with the increasing secant of the angle of inclination, while the length of chain subtended by one foot of horizontal length increases in the same proportion; and if the sectional area of the chain is at all points proportional to the direct stress, its weight will be given by the above calculation.

If the roadway is carried in a horizontal line forming a tangent with the parabolic chain, the average length of the vertical suspenders will be $\frac{1}{3} \times 70 = 23.33$ feet, and the weight of the whole series will be—

$$.00045 \times 1750 \times \frac{1}{3} \times 70 = 18.375 \text{ tons.}$$

This brings the total weight of chain and suspenders to 600 tons; but it will be observed that we have taken the *entire* load as attached to the lower ends of the verticals, whereas the weight of the main chains will, of course, form no part of their load; and if we reduce the load on the verticals by 581 tons, we may perhaps make a corresponding reduction of about 6 tons in the estimated weight of the verticals; which only amounts, however, to 1 per cent. upon the total estimate.

TABLES OF THE THEORETIC WEIGHT OF METAL, FOR THE DEAD LOAD ONLY.

$$\text{Weight} = W = \Sigma \gamma p L (\alpha RL + \beta D).$$

TABLE 1.—*Parallel Girders, with Vertical Posts and Inclined Ties of the Type shown in Fig. 201, Plate I.*

	N=4.		N=6.		N=8.		N=10.	
	α	β	α	β	α	β	α	β
STRUTS—								
<i>Upper flange</i>	$\frac{7}{4^3}$...	$\frac{22}{6^3}$...	$\frac{50}{8^3}$...	$\frac{95}{10^3}$...
<i>Vertical posts</i>	1	...	$1\frac{1}{2}$...	2	...	$2\frac{1}{2}$
Total	$\frac{7}{4^3}$	1	$\frac{22}{6^3}$	$1\frac{1}{2}$	$\frac{50}{8^3}$	2	$\frac{95}{10^3}$	$2\frac{1}{2}$
TIES—								
<i>Lower flange</i>	$\frac{3}{4^3}$...	$\frac{13}{6^3}$...	$\frac{34}{8^3}$...	$\frac{70}{10^3}$...
<i>Diagonal braces</i>	$\frac{4}{4^3}$	1	$\frac{9}{6^3}$	$1\frac{1}{2}$	$\frac{16}{8^3}$	2	$\frac{25}{10^3}$	$2\frac{1}{2}$
Total	$\frac{7}{4^3}$	1	$\frac{22}{6^3}$	$1\frac{1}{2}$	$\frac{50}{8^3}$	2	$\frac{95}{10^3}$	$2\frac{1}{2}$

TABLE 1A.—*Parallel Girders, with Vertical Posts and Inclined Ties, divided into an odd Number of Panels.*

	N=3.		N=5.		N=7.		N=9.	
	α	β	α	β	α	β	α	β
STRUTS—								
<i>Upper flange</i>	$\frac{3}{3^3}$...	$\frac{13}{5^3}$...	$\frac{34}{7^3}$...	$\frac{70}{9^3}$...
<i>Vertical posts</i>	$\frac{2}{3}$...	$\frac{6}{5}$...	$\frac{12}{7}$...	$\frac{20}{9}$
Total	$\frac{3}{3^3}$	$\frac{2}{3}$	$\frac{13}{5^3}$	$\frac{6}{5}$	$\frac{34}{7^3}$	$\frac{12}{7}$	$\frac{70}{9^3}$	$\frac{20}{9}$
TIES—								
<i>Lower flange</i>	$\frac{1}{3^3}$...	$\frac{7}{5^3}$...	$\frac{22}{7^3}$...	$\frac{50}{9^3}$...
<i>Diagonal braces</i>	$\frac{2}{3^3}$	$\frac{2}{3}$	$\frac{6}{5^3}$	$\frac{6}{5}$	$\frac{12}{7^3}$	$\frac{12}{7}$	$\frac{20}{9^3}$	$\frac{20}{9}$
Total	$\frac{3}{3^3}$	$\frac{2}{3}$	$\frac{13}{5^3}$	$\frac{6}{5}$	$\frac{34}{7^3}$	$\frac{12}{7}$	$\frac{70}{9^3}$	$\frac{20}{9}$

TABLE 2.—*Parallel Girders, Linville Type, Double Bracing.*
Plate I, Fig. 208.

	N=14.		N=16.		N=18.		N=20.	
	α	β	α	β	α	β	α	β
STRUTS—								
<i>Upper flange</i>	$\frac{273}{14^3}$...	$\frac{400}{16^3}$...	$\frac{561}{18^3}$...	$\frac{760}{20^3}$...
<i>Vertical posts</i>	2	...	$2\frac{1}{4}$...	$2\frac{1}{2}$...	$2\frac{3}{4}$
Total	$\frac{273}{14^3}$	2	$\frac{400}{16^3}$	$2\frac{1}{4}$	$\frac{561}{18^3}$	$2\frac{1}{2}$	$\frac{760}{20^3}$	$2\frac{3}{4}$
TIES—								
<i>Lower flange</i>	$\frac{182}{14^3}$...	$\frac{280}{16^3}$...	$\frac{408}{18^3}$...	$\frac{570}{20^3}$...
<i>Diagonal braces</i>	$\frac{91}{14^3}$	2	$\frac{120}{16^3}$	$2\frac{1}{4}$	$\frac{153}{18^3}$	$2\frac{1}{2}$	$\frac{190}{20^3}$	$2\frac{3}{4}$
Total	$\frac{273}{14^3}$	2	$\frac{400}{16^3}$	$2\frac{1}{4}$	$\frac{561}{18^3}$	$2\frac{1}{2}$	$\frac{760}{20^3}$	$2\frac{3}{4}$

TABLE 3.—*Linville Girders, with Inclined Terminal Struts.*
Plate I, Fig. 213.

	N=14.		N=16.		N=18.		N=20.	
	α	β	α	β	α	β	α	β
STRUTS—								
<i>Upper flange</i>	$\frac{254}{14^3}$...	$\frac{378}{16^3}$...	$\frac{536}{18^3}$...	$\frac{732}{20^3}$...
<i>Inclined struts</i>	$\frac{13}{14^3}$	$\frac{13}{14}$	$\frac{15}{16^3}$	$\frac{15}{16}$	$\frac{17}{18^3}$	$\frac{17}{18}$	$\frac{19}{20^3}$	$\frac{19}{20}$
<i>Vertical posts</i>	$\frac{10}{14}$...	$\frac{15}{16}$...	$\frac{21}{18}$...	$\frac{28}{20}$
Total	$\frac{267}{14^3}$	$\frac{23}{14}$	$\frac{393}{16^3}$	$\frac{30}{16}$	$\frac{553}{18^3}$	$\frac{38}{18}$	$\frac{751}{20^3}$	$\frac{47}{20}$
TIES—								
<i>Lower flange</i>	$\frac{201}{14^3}$...	$\frac{302}{16^3}$...	$\frac{438}{18^3}$...	$\frac{598}{20^3}$...
<i>Diagonal braces</i>	$\frac{66}{14^3}$	$\frac{21}{14}$	$\frac{91}{16^3}$	$\frac{28}{16}$	$\frac{120}{18^3}$	$\frac{36}{18}$	$\frac{153}{20^3}$	$\frac{45}{20}$
<i>Vertical ties</i>	$\frac{2}{14}$...	$\frac{2}{16}$...	$\frac{2}{18}$...	$\frac{2}{20}$
Total	$\frac{267}{14^3}$	$\frac{23}{14}$	$\frac{393}{16^3}$	$\frac{30}{16}$	$\frac{553}{18^3}$	$\frac{38}{18}$	$\frac{751}{20^3}$	$\frac{47}{20}$

TABLE 4.—*Warren Girders, with Intermediate Verticals. Deck Bridge.*
 Plate I, Fig. 203A.

	N=8.		N=12.		N=16.		N=20.	
	α	β	α	β	α	β	α	β
STRUTS—								
<i>Upper flange</i>	$\frac{44}{8^2}$...	$\frac{146}{12^2}$...	$\frac{344}{16^2}$...	$\frac{670}{20^2}$...
<i>Diagonal struts</i>	$\frac{6}{8^2}$	$\frac{6}{8}$	$\frac{15}{12^2}$	$\frac{15}{12}$	$\frac{28}{16^2}$	$\frac{28}{16}$	$\frac{45}{20^2}$	$\frac{45}{20}$
<i>Vertical posts</i>	$\frac{4}{8}$...	$\frac{6}{12}$...	$\frac{8}{16}$...	$\frac{10}{20}$
Total	$\frac{50}{8^2}$	$1\frac{1}{4}$	$\frac{161}{12^2}$	$1\frac{3}{4}$	$\frac{372}{16^2}$	$2\frac{1}{4}$	$\frac{715}{20^2}$	$2\frac{3}{4}$
TIES—								
<i>Lower flange</i>	$\frac{40}{8^2}$...	$\frac{140}{12^2}$...	$\frac{336}{16^2}$...	$\frac{660}{20^2}$...
<i>Diagonal ties</i>	$\frac{10}{8^2}$	$\frac{10}{8}$	$\frac{21}{12^2}$	$\frac{21}{12}$	$\frac{36}{16^2}$	$\frac{36}{16}$	$\frac{55}{20^2}$	$\frac{55}{20}$
Total	$\frac{50}{8^2}$	$1\frac{1}{4}$	$\frac{161}{12^2}$	$1\frac{3}{4}$	$\frac{372}{16^2}$	$2\frac{1}{4}$	$\frac{715}{20^2}$	$2\frac{3}{4}$

TABLE 4A.—*Warren Girder, with Intermediate Verticals. Through Bridge.* Plate I, Fig. 203.

	N=8.		N=12.		N=16.		N=20.	
	α	β	α	β	α	β	α	β
STRUTS—								
<i>Upper flange</i>	$\frac{40}{8^2}$...	$\frac{140}{12^2}$...	$\frac{336}{16^2}$...	$\frac{660}{20^2}$...
<i>Diagonal struts</i>	$\frac{10}{8^2}$	$\frac{10}{8}$	$\frac{21}{12^2}$	$\frac{21}{12}$	$\frac{36}{16^2}$	$\frac{36}{16}$	$\frac{55}{20^2}$	$\frac{55}{20}$
Total	$\frac{50}{8^2}$	$1\frac{1}{4}$	$\frac{161}{12^2}$	$1\frac{3}{4}$	$\frac{372}{16^2}$	$2\frac{1}{4}$	$\frac{715}{20^2}$	$2\frac{3}{4}$
TIES—								
<i>Lower flange</i>	$\frac{44}{8^2}$...	$\frac{146}{12^2}$...	$\frac{344}{16^2}$...	$\frac{670}{20^2}$...
<i>Diagonal braces</i>	$\frac{6}{8^2}$	$\frac{6}{8}$	$\frac{15}{12^2}$	$\frac{15}{12}$	$\frac{28}{16^2}$	$\frac{28}{16}$	$\frac{45}{20^2}$	$\frac{45}{20}$
<i>Vertical ties</i>	$\frac{4}{8}$...	$\frac{6}{12}$...	$\frac{8}{16}$...	$\frac{10}{20}$
Total	$\frac{50}{8^2}$	$1\frac{1}{4}$	$\frac{161}{12^2}$	$1\frac{3}{4}$	$\frac{372}{16^2}$	$2\frac{1}{4}$	$\frac{715}{20^2}$	$2\frac{3}{4}$

TABLE 5.—*Warren Girder, without Verticals. Deck Bridge or Through Bridge. Plate I, Fig. 204.*

	N=4		N=6		N=8		N=10	
	α	β	α	β	α	β	α	β
STRUTS—								
<i>Upper flange</i>	$\frac{40}{8^2}$...	$\frac{140}{12^2}$...	$\frac{336}{16^2}$...	$\frac{660}{20^2}$...
<i>Diagonals</i>	$\frac{8}{8^2}$	1	$\frac{18}{12^2}$	$1\frac{1}{2}$	$\frac{32}{16^2}$	2	$\frac{50}{20^2}$	$2\frac{1}{2}$
Total	$\frac{48}{8^2}$	1	$\frac{158}{12^2}$	$1\frac{1}{2}$	$\frac{368}{16^2}$	2	$\frac{710}{20^2}$	$2\frac{1}{2}$
TIES—								
<i>Lower flange</i>	$\frac{40}{8^2}$...	$\frac{140}{12^2}$...	$\frac{336}{16^2}$...	$\frac{660}{20^2}$...
<i>Diagonals</i>	$\frac{8}{8^2}$	1	$\frac{18}{12^2}$	$1\frac{1}{2}$	$\frac{32}{16^2}$	2	$\frac{50}{20^2}$	$2\frac{1}{2}$
Total	$\frac{48}{8^2}$	1	$\frac{158}{12^2}$	$1\frac{1}{2}$	$\frac{368}{16^2}$	2	$\frac{710}{20^2}$	$2\frac{1}{2}$

TABLE 6.—*Single Lattice Girder (or Double Warren Bracing), Load equally divided between Upper and Lower Joints by means of Vertical Posts or Ties. Plate I, Fig. 206.*

	N=4		N=6		N=8		N=10	
	α	β	α	β	α	β	α	β
STRUTS—								
<i>Upper flange</i>	$\frac{40}{8^2}$...	$\frac{140}{12^2}$...	$\frac{336}{16^2}$...	$\frac{660}{20^2}$...
<i>Diagonal struts</i>	$\frac{16}{8^2}$	$\frac{4}{8}$	$\frac{36}{12^2}$	$\frac{9}{12}$	$\frac{64}{16^2}$	1	$\frac{100}{20^2}$	$\frac{25}{20}$
<i>Vertical posts</i>	$\frac{3}{8}$...	$\frac{5}{12}$...	$\frac{7}{16}$...	$\frac{9}{20}$
Total	$\frac{56}{8^2}$	$\frac{7}{8}$	$\frac{176}{12^2}$	$\frac{14}{12}$	$\frac{400}{16^2}$	$\frac{23}{16}$	$\frac{760}{20^2}$	$\frac{34}{20}$
TIES—								
<i>Lower flange</i>	$\frac{40}{8^2}$...	$\frac{140}{12^2}$...	$\frac{336}{16^2}$...	$\frac{660}{20^2}$...
<i>Diagonal braces</i>	$\frac{16}{8^2}$	$\frac{4}{8}$	$\frac{36}{12^2}$	$\frac{9}{12}$	$\frac{64}{16^2}$	1	$\frac{100}{20^2}$	$\frac{25}{20}$
<i>Vertical ties</i>	$\frac{3}{8}$...	$\frac{5}{12}$...	$\frac{7}{16}$...	$\frac{9}{20}$
Total	$\frac{56}{8^2}$	$\frac{7}{8}$	$\frac{176}{12^2}$	$\frac{14}{12}$	$\frac{400}{16^2}$	$\frac{23}{16}$	$\frac{760}{20^2}$	$\frac{34}{20}$

TABLE 7.—*Fink Truss.* Plate *E*, Type No. 40.

	N=2.		N=4.		N=8.		N=16.	
	α	β	α	β	α	β	α	β
STRUTS—								
<i>Upper boom</i>	$\frac{1}{2^2}$...	$\frac{10}{4^2}$...	$\frac{84}{8^2}$...	$\frac{688}{16^2}$...
<i>Vertical posts</i>	$\frac{1}{2}$...	1	...	$1\frac{1}{2}$...	2
Total	$\frac{1}{2^2}$	$\frac{1}{2}$	$\frac{10}{4^2}$	1	$\frac{84}{8^2}$	$1\frac{1}{2}$	$\frac{688}{16^2}$	2
TIES—								
<i>Inclined ties</i>	$\frac{1}{2^2}$	$\frac{1}{2}$	$\frac{10}{4^2}$	1	$\frac{84}{8^2}$	$1\frac{1}{2}$	$\frac{688}{16^2}$	2

TABLE 8.—*Bollman Truss.* Plate *E*, Type No. 36.

	N=4.		N=6.		N=8.		N=10.	
	α	β	α	β	α	α	α	β
STRUTS—								
<i>Upper boom</i>	$\frac{10}{4^2}$...	$\frac{35}{6^2}$...	$\frac{84}{8^2}$..	$\frac{165}{10^2}$...
<i>Vertical posts</i>	$\frac{3}{4}$...	$\frac{5}{6}$...	$\frac{7}{8}$...	$\frac{9}{10}$
Total	$\frac{10}{4^2}$	$\frac{3}{4}$	$\frac{35}{6^2}$	$\frac{5}{6}$	$\frac{84}{8^2}$	$\frac{7}{8}$	$\frac{165}{10^2}$	$\frac{9}{10}$
TIES—								
<i>Inclined ties</i>	$\frac{10}{4^2}$	$\frac{3}{4}$	$\frac{35}{6^2}$	$\frac{5}{6}$	$\frac{84}{8^2}$	$\frac{7}{8}$	$\frac{165}{10^2}$	$\frac{9}{10}$

TABLE 9.—*Straight Link Suspension Bridge, Weight for Single Span, exclusive of Backstays.* Plate *E*, Type No. 38.

	N=4.		N=6.		N=8.		N=10.	
	α	β	α	β	α	β	β	β
STRUTS—								
<i>Vertical towers</i> ¹	0	$\frac{3}{4}$	0	$\frac{5}{6}$	0	$\frac{7}{8}$	0	$\frac{9}{10}$
TIES—								
<i>Inclined ties</i>	$\frac{10}{4^2}$	$\frac{3}{4}$	$\frac{35}{6^2}$	$\frac{5}{6}$	$\frac{84}{8^2}$	$\frac{7}{8}$	$\frac{165}{10^2}$	$\frac{9}{10}$

¹ Towers only reckoned for the load of the single span, exclusive of side spans, or load due to backstays.

TABLE 10.—*Trapezoidal Truss. Plate E, Type No. 37.*

	N=4.		N=6.		N=8.		N=10.	
	α	β	α	β	α	β	α	β
STRUTS—								
<i>Upper boom</i>	$\frac{1}{32}$...	$\frac{8}{6^2}$...	$\frac{20}{8^2}$...	$\frac{40}{10^2}$...
<i>Inclined struts</i>	$\frac{3}{32}$	$\frac{3}{4}$	$\frac{19}{6^2}$	$\frac{5}{6}$	$\frac{44}{8^2}$	$\frac{7}{8}$	$\frac{85}{10^2}$	$\frac{9}{10}$
Total	$\frac{1}{8}$	$\frac{3}{4}$	$\frac{1}{8}$	$\frac{5}{6}$	$\frac{1}{8}$	$\frac{7}{8}$	$\frac{1}{8}$	$\frac{9}{10}$
TIES—								
<i>Horizontal tie</i>	$\frac{1}{8}$...	$\frac{1}{8}$...	$\frac{1}{8}$...	$\frac{1}{8}$...
<i>Vertical ties</i>	$\frac{3}{4}$...	$\frac{5}{6}$...	$\frac{7}{8}$...	$\frac{9}{10}$
Total	$\frac{1}{8}$	$\frac{3}{4}$	$\frac{1}{8}$	$\frac{5}{6}$	$\frac{1}{8}$	$\frac{7}{8}$	$\frac{1}{8}$	$\frac{9}{10}$

TABLE 11.—*Straight Link Suspension Bridge. Metal for Single Span, exclusive of Backstays. Plate E, Type No. 39.*

	N=4.		N=6.		N=8.		N=10.	
	α	β	α	β	α	β	α	β
STRUTS—								
<i>Vertical towers</i>	0	$\frac{3}{4}$	0	$\frac{5}{6}$	0	$\frac{7}{8}$	0	$\frac{9}{10}$
TIES—								
<i>Horizontal tie</i>	$\frac{1}{32}$...	$\frac{8}{6^2}$...	$\frac{20}{8^2}$...	$\frac{40}{10^2}$...
<i>Inclined links</i>	$\frac{3}{32}$	$\frac{3}{4}$	$\frac{19}{6^2}$	$\frac{5}{6}$	$\frac{44}{8^2}$	$\frac{7}{8}$	$\frac{85}{10^2}$	$\frac{9}{10}$
Total	$\frac{1}{8}$	$\frac{3}{4}$	$\frac{1}{8}$	$\frac{5}{6}$	$\frac{1}{8}$	$\frac{7}{8}$	$\frac{1}{8}$	$\frac{9}{10}$

TABLE 12.—*Straight Link Cantilever Bridge, divided in the centre. Metal for Central Span, or for one Double Cantilever. Plate E, Type 45.*

	N=4.		N=6.		N=8.		N=10.	
	α	β	α	β	α	β	α	β
STRUTS—								
<i>Lower boom</i>	$\frac{3}{32}$...	$\frac{19}{6^2}$...	$\frac{44}{8^2}$...	$\frac{85}{10^2}$...
<i>Vertical towers</i>	$\frac{3}{4}$...	$\frac{5}{6}$...	$\frac{7}{8}$...	$\frac{9}{10}$
Total	$\frac{3}{32}$	$\frac{3}{4}$	$\frac{19}{6^2}$	$\frac{5}{6}$	$\frac{44}{8^2}$	$\frac{7}{8}$	$\frac{85}{10^2}$	$\frac{9}{10}$
<i>Inclined ties</i>	$\frac{3}{32}$	$\frac{3}{4}$	$\frac{19}{6^2}$	$\frac{5}{6}$	$\frac{44}{8^2}$	$\frac{7}{8}$	$\frac{85}{10^2}$	$\frac{9}{10}$

TABLE 13.—*Parabolic (Polygonal) Bowstrings.*
Plate C, Type No. 22.

	N=4.		N=6.		N=8.		N=10.	
	α	β	α	β	α	β	α	β
STRUTS—								
<i>Polygonal bow</i>	$\frac{1}{8}$	$\frac{5}{8}$	$\frac{1}{8}$	$\frac{35}{54}$	$\frac{1}{8}$	$\frac{21}{32}$	$\frac{1}{8}$	$\frac{33}{50}$
TIES—								
<i>Horizontal string</i>	$\frac{1}{8}$...	$\frac{1}{8}$...	$\frac{1}{8}$...	$\frac{1}{8}$...
<i>Vertical ties</i>	$\frac{5}{8}$...	$\frac{35}{54}$...	$\frac{21}{32}$...	$\frac{33}{50}$
Total	$\frac{1}{8}$	$\frac{5}{8}$	$\frac{1}{8}$	$\frac{35}{54}$	$\frac{1}{8}$	$\frac{21}{32}$	$\frac{1}{8}$	$\frac{33}{50}$

TABLE 14.—*Parabolic (Polygonal) Linear Arch, with Roadway carried at level of Crown; Weight includes End Spandril Pillars.* Plate C, Type No. 27, and Plate A, Type No. 8.

	N=4.		N=6.		N=8.		N= ∞ .	
	α	β	α	β	α	β	α	β
STRUTS—								
<i>Polygonal arch</i>	$\frac{1}{8}$	$\frac{5}{8}$	$\frac{1}{8}$	$\frac{35}{44}$	$\frac{1}{8}$	$\frac{21}{32}$	$\frac{1}{8}$	$\frac{2}{3}$
<i>Spandril posts</i>	$\frac{3}{8}$...	$\frac{19}{54}$...	$\frac{11}{32}$...	$\frac{1}{3}$
Total	$\frac{1}{8}$	1	$\frac{1}{8}$	1	$\frac{1}{8}$	1	$\frac{1}{8}$	1

TIES—None.

TABLE 15.—*Inverted Parabolic (Polygonal) Trusses.* Deck Bridge.
Plate B, Type No. 10.

	N=4.		N=6.		N=8.		N=10.	
	α	β	α	β	α	β	α	β
STRUTS—								
<i>Upper boom</i>	$\frac{1}{8}$...	$\frac{1}{8}$...	$\frac{1}{8}$...	$\frac{1}{8}$...
<i>Vertical posts</i>	$\frac{5}{8}$...	$\frac{35}{54}$...	$\frac{21}{32}$...	$\frac{33}{50}$
Total	$\frac{1}{8}$	$\frac{5}{8}$	$\frac{1}{8}$	$\frac{35}{54}$	$\frac{1}{8}$	$\frac{21}{32}$	$\frac{1}{8}$	$\frac{33}{50}$
TIES—								
<i>Polygonal chain or tie</i>	$\frac{1}{8}$	$\frac{5}{8}$	$\frac{1}{8}$	$\frac{35}{54}$	$\frac{1}{8}$	$\frac{21}{32}$	$\frac{1}{8}$	$\frac{33}{50}$

TABLE 16.—*Suspension Bridges, of Parabolic or Polygonal Form; Weight of Single Span AC, including one half of each Tower. Plate B, Type No. 14.*

	N=4.		N=6.		N=8.		N=∞.	
	α	β	α	β	α	β	α	β
STRUTS—								
<i>Vertical towers</i>	0	$\frac{3}{4}$	0	$\frac{5}{6}$	0	$\frac{7}{8}$	0	1
TIES—								
<i>Chain</i>	$\frac{1}{8}$	$\frac{5}{8}$	$\frac{1}{8}$	$\frac{35}{54}$	$\frac{1}{8}$	$\frac{21}{32}$	$\frac{1}{8}$	$\frac{2}{3}$
<i>Vertical rods</i>	$\frac{1}{8}$...	$\frac{10}{54}$...	$\frac{7}{32}$...	$\frac{1}{3}$
Total	$\frac{1}{8}$	$\frac{3}{4}$	$\frac{1}{8}$	$\frac{5}{6}$	$\frac{1}{8}$	$\frac{7}{8}$	$\frac{1}{8}$	1

81A. These tables will serve to show *approximately* the comparative weight of metal required in different forms of bridge-construction, in order to carry the same uniform load across the same width of span. As might be expected from their mechanical principles, it will be seen that the arch and the suspension bridge possess a very great economic advantage (in theory) over other forms of bridge; because, in these designs, we are enabled to dispense altogether with one of the two principal members of the structure. This advantage will have to be discounted to some extent, when we come to provide for the effects of unequal loading; but it constitutes, at all events, an enormous start to begin with.

CHAPTER VIII.

ON DEFLECTION, OR THE CURVE OF A BENDED GIRDER.

82. The elastic deflection of a girder, or the way in which it bends under its load, is a subject which, for many reasons, deserves careful consideration; and it must be remarked that the purposes for which the study is chiefly useful are quite different from the mere calculation of the quantity which is commonly termed the "deflection" of a beam or girder. The calculated "deflection" of girders, as given in the text-books, is indeed liable to be seriously misapplied. It is not an uncommon practice to "test" a newly erected bridge by observing its deflection under the passage of a heavy load; and it may be well to state at once that such a test affords no reliable indication of the *strength* of the bridge. If it should so happen that the structure is seriously or even dangerously deficient in strength, owing to any fault of design, of workmanship, or of material, it does not by any means follow that the bridge would exhibit any unusual deflection under the test load. On the contrary, it is quite possible that while the inspector is noting with inward satisfaction the moderate extent of the deflection, the bridge may be undergoing, at some critical part, a stress which is almost within "the last straw" of the breaking point.¹

But although deflection may not be used in this way as a *test* of the strength of bridges, yet there are many other purposes for which a study of this question will be extremely useful; and its importance must not by any means be measured by the smallness of the quantities that it deals with. It is true that the change of form which accompanies a given stress is a very small quantity; but for that very reason a minute change of form is in certain cases accompanied by a great alteration of stress. The Britannia bridge carries its load safely across the Menai Straits; but it is only enabled to do so because these microscopic changes of form take place in obedience to the laws of elastic deflection.

In studying these laws we shall chiefly keep in view their application to the strength of continuous girders and the strength of long columns; and consistently with these purposes our object will be, not merely to find the deflection at one point, but rather to trace out the actual curve

¹ In a later chapter some instances are recorded, in which bridges have actually collapsed immediately after their deflection under the test load had been measured, and had been found to amount only to a moderate and quite satisfactory quantity.

of the bended girder, and to examine the relation that exists between the bending stress and the bended form of a beam.

It will presently be shown that this relation may generally be expressed by saying that the curve of deflection is derived from the diagram of bending moments in precisely the same way that the curve of moments is derived from a diagram of the load.¹

83. Deflection of Parallel Girders.—The curvature of a bent girder is almost entirely due to the stretching of one flange and the compression of the other under the horizontal flange-stress. It is true that the strain or deformation of the web contributes to the deflection; but its effect is so small in comparison that it may generally be disregarded.²

The curvature of the bent girder may, therefore, be determined solely by reference to the flange-stress, no matter what may be the particular load or external forces by which that stress is produced; but to fix the ideas we may suppose that, in the first example, the girder is fixed at one end as a cantilever, and loaded at the other end by a single weight, as represented in Fig. 95.

Before the weight is applied, let the straight unstrained girder be divided into a number of rectangular panels *Acac*, &c., by parallel vertical lines as shown in the figure. On applying the weight, the upper horizontal bar of each panel will be stretched, while the lower bar will be compressed, so that each panel will assume a tapered form, like the voussoir of an arch; and if we put the voussoirs together we may construct on paper the figure of the bended cantilever as indicated in Fig. 97.

In all cases we shall assume that the girder is not strained beyond the elastic limit; and it has been already mentioned that within those limits the linear extension or compression of a bar of wrought iron is proportional to the *intensity of stress*, and for every ton per square inch amounts to $\frac{1}{12000}$ th part of the length of the bar. Therefore, to calculate the altered lengths of the upper and lower member of each voussoir, it is necessary to know the intensity of flange-stress at each panel. To find that intensity we have only to divide the flange-stress at any point by the sectional area of the flange; and this being done, the varying stress-intensity may be represented by a diagram, such as Fig. 96, which we will suppose to represent the stress-intensity in *each* flange of the cantilever, so that *ag*, for example, represents the intensity of stress in the first panel, in tons per square inch.³ Then the upper bar of that panel will be elongated by an amount which is expressed by the length *ac* multiplied by the stress-intensity *ag* and divided by the modulus of

¹ The method here adopted was first described by the author, in abbreviated form, in a paper on "Continuous Girder Bridges," contained in the *Proceedings of the Institution of Civil Engineers*, vol. lxxiv.

² Professor Rankine has shown that in a girder of ordinary proportions the deflection due to the web-strains does not exceed $\frac{1}{8}$ th of the whole.

³ The diagram will have the stepped outline, as shown in the figure, if the cantilever is a single lattice girder with flanges of uniform section.

elasticity E (or 12,000 tons per square inch). Let G_1 denote the area of

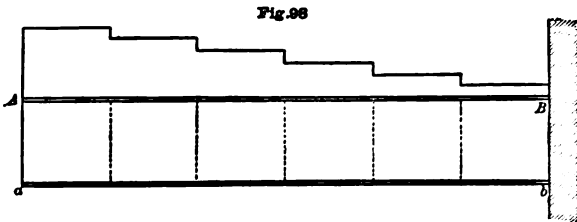
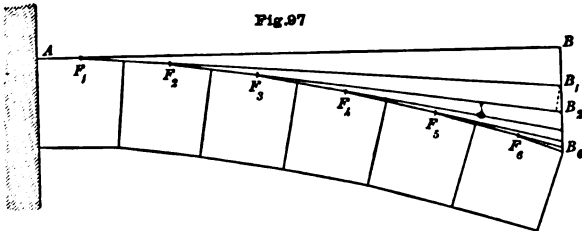
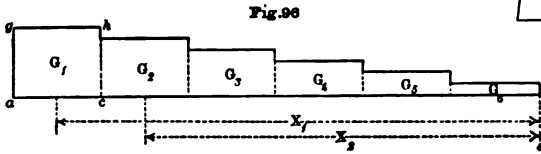
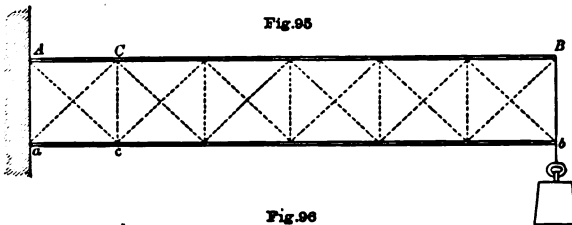
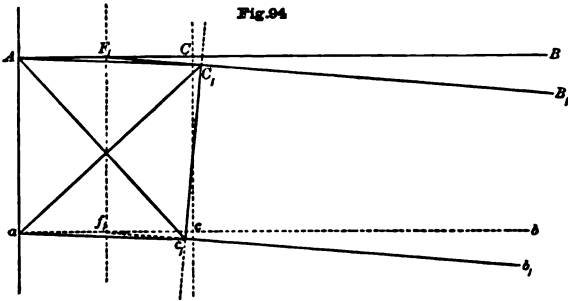

the strip $aghc$; then $\frac{G_1}{E}$ will express the elongation of the upper bar AC , or the compression of the lower bar ac .

The altered form of the panel is represented in Fig. 94, by the tapered figure AC_1ac_1 ; and the inclination of the line C_1c_1 (which was originally vertical) will be measured by the linear extension of the upper bar AC divided by half the depth of the girder, or it will be measured by the ratio $\frac{\text{extension of } AC + \text{compression of } ac}{\text{depth of girder}}$, and it may, therefore, be expressed by $i_1 = \frac{2G_1}{ED}$.

Now if the remainder of the girder were not subject to any further strain, this tapering of the first voussoir would in itself have the effect of giving a downward inclination to the whole girder beyond the first panel, as indicated by the lines C_1B_1 , and c_1b_1 which in Fig. 94 are drawn at right angles to C_1c_1 , and as indicated again by the line F_1B_1 in Fig. 97. The slope of that line will in fact be equal to the inclination of the line C_1c_1 as above given; in other words $\frac{BB_1}{F_1B} = \frac{2G_1}{ED} = i_1$; so that to find the offset or fall BB_1 we have only to multiply the gradient i_1 by the horizontal distance F_1B measured from the point of intersection F_1 . It has already been mentioned that the effect of the web strain is really inconsiderable,¹ and therefore neglecting any oblique distortion of the voussoir AC_1ac_1 , such as would be produced by strain in the diagonals, it is evident that the point of intersection F_1 will occur at the centre of the length AC_1 , while the point f_1 will occur at the centre of ac_1 , the line F_1f_1 being the axis of the tapered voussoir. Therefore the offset BB_1 will be proportional to the area G_1 , multiplied by the distance from its centre to the point B , or, in other words, proportional to the *moment* of that area about the point B ; and if X_1 denotes the horizontal distance F_1B , we have $BB_1 = \frac{2G_1X_1}{ED}$.

Proceeding now to deal with the second panel in the same manner, we may denote the area of the corresponding strip in the diagram by G_2 ; then the second voussoir will have a taper expressed by $\frac{2G_2}{ED}$; and from this panel forwards the girder will receive an *additional* downward inclination represented by the line F_2B_2 in Fig. 97. Therefore at B the girder will be depressed by an additional² quantity $B_1B_2 = \frac{2G_2X_2}{ED}$.

Repeating the process for each panel in succession, we obtain the

¹ The actual effect of the web-strain in the first voussoir, or the shortening of the diagonal ac_1 and extension of the diagonal AC_1 , will be to throw the point of intersection F_1 a little to the left of the centre; but the effect is so small that it is generally neglected, and may here be left out of account.

² It may perhaps be objected that the depression B_1B_2 ought to have been set off at right angles to the line F_1B_1 , as shown by the dotted line; but it must be remembered that the diagram is necessarily drawn to a very exaggerated vertical scale. In practice the slope of the girder is so small that the difference between the vertical and the inclined offset is inappreciable, being seldom greater than $\frac{1}{100000}$ th, or $\frac{1}{100000}$ th per cent.

curve of the bended cantilever AB_6 . The inclination of the girder at B_6 will be the sum of all the inclinations, and will be proportional to the entire area of the stress-diagram; while the deflection at B will be the sum of all the deflections, and proportional to the moment of the whole diagram about the point B ; i.e. $BB_6 = \frac{2}{ED} \left\{ G_1X_1 + G_2X_2 + \&c. \right\}$

If we conceive the diagram of stress-intensity, Fig. 96, to represent *an imaginary load*, it will be evident that the curve of the bended girder is nothing more than the curve of moments for that imaginary load. In fact if the cantilever were loaded in that manner and fixed at B , as shown in Fig. 98, the construction of the curve of moments, as described in Art. 27, would follow step by step the same process by which the curve of Fig. 97 has been constructed.

Thus if G denotes the entire area of the diagram, and X the distance of its centre of gravity from the point B , the deflection will be $BB_6 = GX \times \frac{2}{ED}$.

In the same way, it hardly needs any demonstration to show that whatever may be the figure of the diagram of stress-intensity, the deflection BB_6 at the extreme end of the cantilever, *measured from the tangent AB* , must always be proportional to the moment of the area of that diagram: If the diagram has any irregular form, as it may have in the case of a plate-webbed girder, we may suppose the girder to be divided into a large number of narrow panels, and the diagram into a corresponding number of narrow strips. The area G_1 of the first strip (whatever may be the irregular form of its upper edge) will be an accurate measure of the extension of the first bar in the upper flange; and the element of deflection BB_1 , *due to that extension*, will be measured by the moment G_1X_1 , or $BB_1 = \frac{2G_1X_1}{ED}$.

Therefore, in the case of any parallel girder, we have the simple rule that *the curve of the bended girder is the curve of moments for an imaginary load, whose varying intensity is represented by the actual intensity of stress in the flanges of the girder.*

We have hitherto assumed that the two flanges have the same sectional area, so that the stress-diagram is the same for each flange, and we have taken the $\frac{\text{area of diagram}}{\text{half depth of girder}}$ as the measure of the slope; but if the flanges are unequal and the diagrams consequently unequal, the slope will still be measured by the united area of both diagrams divided by the *whole* depth of the girder. Therefore if we make the diagram to represent the *mean* stress-intensity for the two flanges, we shall in every case have the slope equal to $\frac{2G}{ED}$, and the extreme deflection $BB_6 = GX \times \frac{2}{ED}$.

84. Deflection of Girder under Uniform Working Stress.—By means of the rule above given we may describe the deflection of *any* parallel girder,

whatever may be the arbitrary variation of flange-section at different points; but we may now consider two principal cases, viz., first, when the flanges of the girder are proportioned to one standard working stress throughout; and, secondly, when the flanges are made of one uniform section throughout.

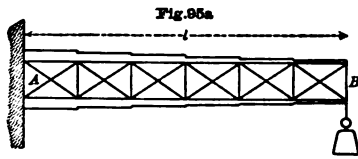

In the first case it must be assumed that the section of each flange is everywhere proportional to the bending moment; thus, for example, the flanges of the cantilever, Fig. 95A, may be formed with a different thickness of plate for each panel, increasing regularly from B towards A, and we may then represent the stress-intensity by a rectangle, as in Fig. 96A, in which the height f represents the uniform working stress in tons per square inch.

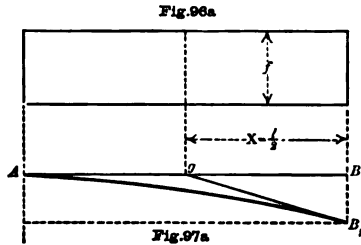

If for a moment we regard this rectangle as representing an imaginary uniform load, it will be evident that the corresponding curve of moments, or the actual deflection curve, will be a parabola,¹ as in Fig. 97A.

In that figure the horizontal line AB represents the original line of

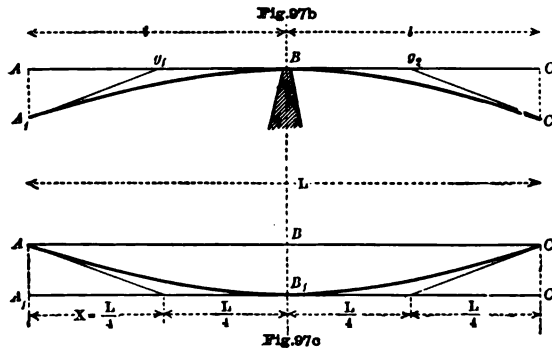

the straight girder, and AB_1 is the deflection curve. The tangent gB_1 will intersect AB at the centre, and the inclination of that tangent will be expressed by

$$\tan. \psi = \frac{BB_1}{Bg} = \frac{2G}{ED} = \frac{2fl}{ED} \dots \dots (1)$$

¹ The deflection being in all cases very small, "the parabolic curve" and "the circular curve" are practically synonymous terms; in the circle the tangent Ag is equal to gB_1 , and in the parabola $Ag = gB$; and for all practical purposes $gB = gB_1$.

while the deflection BB_1 will be equal to the length Bg multiplied by that gradient, or

$$\text{Deflection, } BB_1 = \frac{2GX}{ED} = \frac{fL^2}{ED} \dots \dots (2)$$

In the same way, if the girder is supported in the middle and loaded at each end, we have the parabolic deflection curve of Fig. 97B, each half of the curve being similar to Fig. 97A; and if the girder is supported at each end, as in Fig. 97c, and loaded by a central weight, or by any other distribution of load, the deflection curve will always have the same parabolic form, provided that in every case the sectional area of flange is made proportional to the bending moment, so that the stress-intensity f is made uniform throughout. Therefore if L denotes the total length of the girder, we have for the downward deflections AA_1 and CC_1 in Fig. 97B, or the depression BB_1 in Fig. 97c, the value—

$$\text{Deflection, } AA_1 = BB_1 = CC_1 = \frac{fL^2}{ED} = \frac{fL^2}{4ED} \dots \dots (2A)$$

85. Deflection of Beams or Girders of Uniform Section.—In girders of uniform depth, the diagram of moments may always be taken to represent, on a certain scale, the diagram of flange-stress for each of the two flanges; and if the sectional area of each flange is uniform throughout the length of the girder, the same diagram will represent on another scale the diagram of stress-intensity.

Therefore, in all girders of uniform section we have the following rule for constructing the deflection curve for any given distribution of load, viz.: *Let the varying intensity of load be represented by a diagram (a), and construct the diagram of moments (b); then treat diagram (b) as representing the intensity of an imaginary load, and construct the corresponding curve of moments (c) for that imaginary load. The curve (c) will be the curve of the bended girder.*

The diagram of moments for each of the most important cases has already been described in Chapter IV.; and treating it as a diagram of stress-intensity we may at once proceed to trace the deflection curve for girders of uniform section; but in doing so we need not stop to fill in all the details, because in every case the most essential features of the curve will be defined by merely laying out the tangents and their points of intersection; and the details of the curve may easily be filled in afterwards as occasion may require.

86. Deflection of Cantilever Loaded at the End.—This case is represented in Fig. 99, while the diagram of moments, or rather the diagram of stress-intensity, is represented by the triangle abf in Fig. 100. The girder being fixed at B , the bending moment at that point will be $M_b = -PL$, and the stress-intensity, bf , will have the value $\mp \left(\frac{PL}{AD} \right)$, in which A denotes the sectional area of each flange,

or the mean of the two flanges. The area of the triangle will be $G = \bar{b}f \times \frac{L}{2}$; while the horizontal distance of its centre of gravity from the point A will be $X = \frac{2}{3}L$.

In Fig. 101 the horizontal line AB denotes the original position of the unbended girder, and may be taken to represent the neutral axis; while the curve A_1B represents the curve of the bended girder. The deflection AA_1 will be proportional to the moment of the triangular stress-diagram, as demonstrated in the last Article, and will be expressed by—

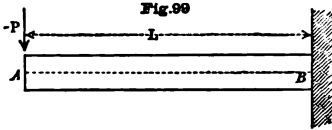

$$\overline{AA_1} = \frac{2GX}{ED} = \frac{2}{3}\bar{b}f \times \frac{L^2}{ED} \dots (3)^1$$

The slope of the girder at A_1 , or the gradient $\frac{AA_1}{Ag}$ will be proportional simply to the area of the stress-diagram, and will be

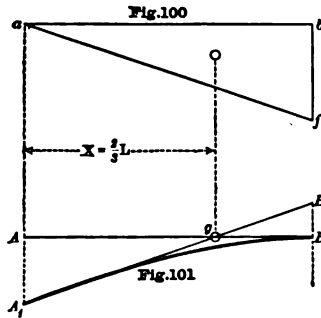

$$\frac{AA_1}{Ag} = \tan. \psi = \frac{2G}{ED} = \bar{b}f \times \frac{L}{ED} \dots (4)$$

It follows of course that the length $Ag = X$; or in other words, the point of intersection, g , is at the centre of gravity of the stress-diagram. This will always be the case;² and in order to draw the containing tangents gA_1 and gB , for any portion A_1B of a deflection curve, we may first fix the intersection of the tangents at the centre of gravity g of the strip of diagram contained between the two extremities a and b , and then lay off the inclination of the tangents, which will be proportional to the area of the same strip.

It is worthy of notice that if we continue the tangent A_1g to B_1 , as shown in Fig. 101, the vertical offset BB_1 will be only half the value of AA_1 , because $Bg = \frac{Ag}{2}$; therefore—

$$BB_1 = \frac{1}{3}\bar{b}f \times \frac{L^2}{ED} \dots (5)$$

In fact, the ordinate B_1B , and all vertical ordinates measured to the curve below the tangent A_1B_1 , are proportional to the bending moments in a cantilever fixed at B and loaded with the imaginary wedge of Fig. 100; while all the vertical ordinates measured below the tangent AB are proportional to the moments in a cantilever fixed at A and loaded with the same imaginary load.

¹ Expressing this formula in terms of the load we have—

$$\text{Deflection, } \overline{AA_1} = \frac{2}{3} \frac{PL^3}{EAD^2} \dots (3a)$$

² This is demonstrated in Art. 27, for the parallel case of the diagram of moments.

If it is desired to fill in the details of the curve, the simplest method is to set off the vertical ordinates below A_1B_1 which are all proportional to x^3 .

87. Deflection of Cantilever under a Uniform Load.—If the cantilever is covered with a distributed load of uniform intensity p , as represented in Fig. 102, the moment at any point whose distance from A is denoted by x will be $-M = \frac{px^2}{2}$, and

therefore the ordinate bf in the diagram of stress-intensity, Fig. 103, will have the value $\mp \frac{pL^2}{2AD}$

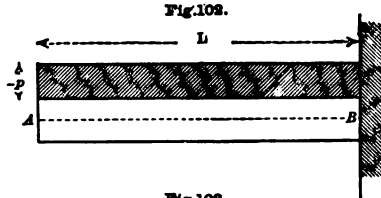

The area of the parabolic stress-diagram will be $G = bf \times \frac{L}{3}$, while the distance of its centre of gravity from the point A will be $X = \frac{3}{4}L$ ¹

Therefore in the deflection curve, Fig. 104, we have the length $Ag = X = \frac{3}{4}L$; the slope

$$\frac{AA_1}{Ag} = \tan. \psi = \frac{2G}{ED} = \frac{2}{3}bf \times \frac{L}{ED} \quad (5)$$

and the deflection offset

$$AA_1 = X \tan. \psi,$$

$$\text{or } AA_1 = \frac{1}{2}bf \times \frac{L^2}{ED} \quad (6)$$

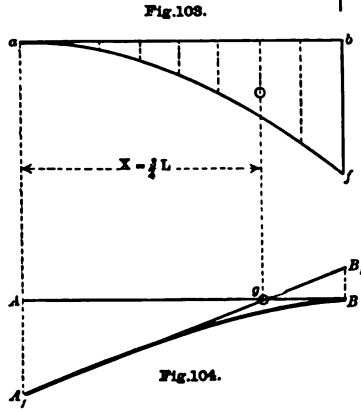

The last formula may again be expressed in terms of the load, or—

$$AA_1 = \frac{pL^4}{4EAD^2} \quad (6a)$$

The offset BB_1 will be one-third of AA_1 ; and the curve may be plotted by ordinates below A_1B_1 , which will be everywhere proportional to x^4 .

88. Deflection of a Balanced Cantilever.—If a beam or girder of uniform section is supported at the centre, as in Fig. 105, and if the ends A and C are loaded with equal weights P_a and P_c , the diagram of stress, and the deflection curve for either half of the beam will be the same as though each half were a cantilever fixed at B . This case is therefore very simple, and exactly similar to that described in Art. 86. Let the total length of the beam AC be denoted by L , and the length of each cantilever by l . Then we have—

$$\text{Stress-intensity, } bf = \mp \frac{P_a l}{AD} = \mp \frac{P_a L}{2AD}$$

$$\text{Length, } Ag_1 = Cg_2 = \frac{2}{3}l = \frac{L}{3}$$

¹ In all cases *vide* Art. 15 for the position of the centre of gravity of the diagram.

$$\text{Slope, } \frac{AA_1}{Ag_1} = \frac{CC_1}{Cg_2} = \tan. \psi = \frac{1}{2} \bar{b}f \times \frac{L}{ED} \quad \dots \quad (7)$$

$$\text{Deflection, } AA_1 = CC_1 = \frac{2}{3} \bar{b}f \times \frac{l^2}{ED} = \frac{1}{3} \bar{b}f \times \frac{L^2}{ED} \quad \dots \quad (8)$$

But now suppose the same girder to form part of a cantilever bridge, the girder being loaded at *A* and supported at *B*, while the end *C* is held down to a fixed abutment, as illustrated in Fig. 108. If the load at *A* is the same as before, the downward force P_c will also remain unaltered, and therefore the stress-diagram and the curve of the bended girder will be exactly the same as before. But we must now consider, not only the

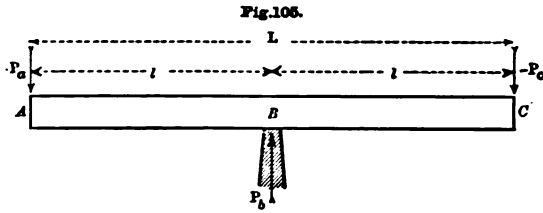

Fig. 105.

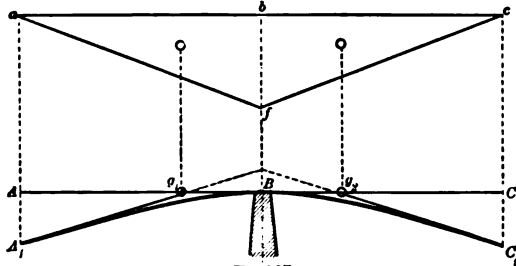

Fig. 106.

Fig. 107.

form of the curve, but also its *position in space*, or its position relatively to the fixed portion of the bridge.

We will suppose then that the abutment *C* has been carried up to the same level as the pier *B*, and that the unstrained girder has been fixed upon these two supports in a truly horizontal position, and anchored down at *C*; and it is required to trace the curve of the deflected girder when subsequently loaded with the weight P_a .

The *form* of the curve A_1BC_1 in Fig. 107 will be unaltered, but the end *C*, instead of being depressed as there shown, will remain at the original level, so that the curve in that figure will be *rotated upon the fulcrum B* into the position shown in Fig. 110. In the last named figure the line A_1C_1 , which represents a tangent drawn to the curve at *B*, will therefore be *inclined*, and will be inclined at such an angle that the height CC_1 is equal to the deflection CC_1 as before determined. For it

must be remembered that the deflections which have been calculated are deflections *from a tangent drawn to the curve at B*. Those deflections, and the resulting form of curve, depend only upon the stress-diagram; but the *position of the curve in space* can only be determined by reference to some two points in the curve which are fixed points; and in the present instance the two points which fix the position of the curve are the points *B* and *C*.

It follows, therefore, that if the two arms l_1 and l_2 are of equal length,

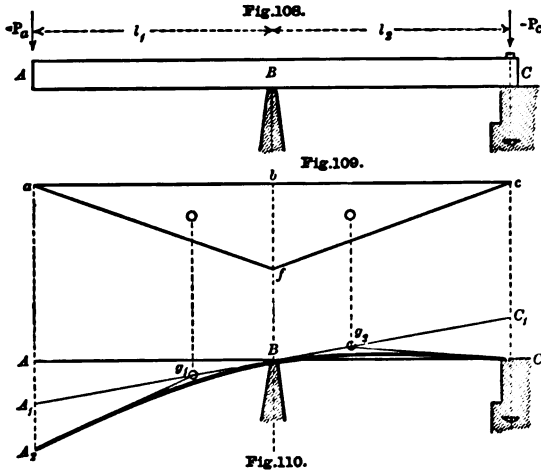

the deflection AA_2 will be just twice as great as that previously calculated; and if those arms are unequal we have the following values; viz,—

$$\text{Offset, } CC_1 = \frac{2}{3} \bar{b} f \times \frac{l_2^2}{ED}$$

$$\text{Inclination at } B = \frac{CC_1}{l_2} = \tan. \psi_b = \frac{2}{3} \bar{b} f \times \frac{l_2}{ED} \quad \dots (9)$$

$$\text{Offset, } AA_1 = l_1 \tan. \psi_b = \frac{2}{3} \bar{b} f \times \frac{l_1 l_2}{ED}$$

$$\text{Offset, } A_1 A_2 = \frac{2}{3} \bar{b} f \times \frac{l_1^2}{ED}$$

$$\text{Deflection, } AA_2 = AA_1 + A_1 A_2 = \frac{2}{3} \bar{b} f \times \frac{l_1(l_1 + l_2)}{ED} \quad \dots (10)$$

$$\text{Inclination at } A_2 = \frac{\bar{b} f}{ED} \times (l_1 + \frac{2}{3} l_2) \quad \dots \dots \dots (11)$$

This matter has an important bearing upon the design and erection of cantilever bridges; and among other things it explains the cause of the large deflection observed in the cantilever bridge recently erected across the Niagara.

When the girder is supported upon a rocking bearing at B , the inclination of the girder at that point is of little consequence; but when it has a wide bearing upon the pier or is supported upon two legs, the effect of that inclination must be carefully taken into account. If it is desired to give the girder a level bearing upon the pier B , that may be effected in the case of any given load, by calculating the offset CC_1 , and lowering the tail end of the girder by a corresponding amount. It may be remarked, however, that if the bridge is designed to resist wind-pressure upon the same cantilever principle, it is not possible to effect a corresponding lateral adjustment of the fixed end, as that adjustment would require to be varied with the varying pressure and direction of the wind.

89. **Balanced Cantilever under a Uniform Load.**—If the two arms

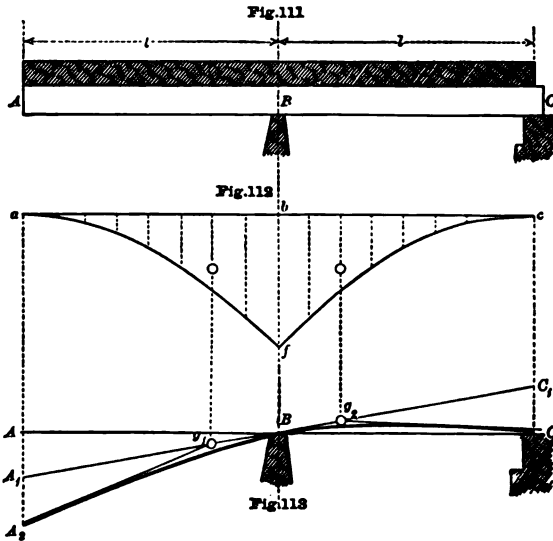

of the cantilever are of equal length and are uniformly loaded, as in Fig. 111, the girder will be exactly balanced upon the pier B , without the interference of any upward or downward force at C . Nevertheless the position of the deflection curve will be determined by the two fixed points B and C , while its form is determined by that of the stress-diagram. Each arm of the girder is of course a cantilever situated under the same conditions of stress as those already described in Art. 87, and each half of the stress-diagram in Fig. 112 is merely a repetition of that shown in Fig. 103.

The deflection of each arm (BA_2 and BC) below the tangent A_1BC_1 , in Fig. 113, will therefore be precisely the same as that shown in Fig.

104; and the points of intersection g_1 and g_2 may be fixed accordingly upon the line A_1C_1 at distances of $\frac{l}{4}$ to the right and left of the point B .

But the tangent A_1BC_1 will be inclined as described in the last example, its inclination being determined by the height CC_1 , or deflection C_1C .

Therefore if the horizontal line ABC represents in elevation the original position of the neutral axis, or represents in plan the centre line of a cantilever, the elements of the deflection curve due to a uniform load in the one case, or a uniform wind-pressure in the other case, will be as follows,¹ viz.—

$$\text{Stress-intensity, } \bar{bf} = \mp \frac{pl^2}{2AD}$$

$$\text{Offset, } CC_1 = \frac{1}{2}\bar{bf} \times \frac{l^2}{ED}$$

$$\text{Inclination at } B = \frac{CC_1}{l} = \frac{1}{2}\bar{bf} \times \frac{l}{ED} \quad \dots \dots \dots (12)$$

$$\text{Deflection, } AA_2 = 2CC_1 = \bar{bf} \times \frac{l}{ED} \quad \dots \dots \dots (13)$$

$$\text{Inclination at } A_2 = \frac{1}{2}\bar{bf} \times \frac{l^2}{ED} \quad \dots \dots \dots (14)$$

It will be noticed that although the span BC is covered with a uniform load, yet the girder is not depressed or sagged by that load, but on the contrary is bowed upwards above the chord line BC . This arises from the circumstance that the abutment C is really carrying no part of the load, and unless that fact is borne in mind, the presence of the abutment may easily give a misleading impression as to the true character of the strains. The abutment exerts no force upon the girder, and affords it no support; but its presence merely determines the tilted position of the deflection curve.

90. **Beam supported at each End and Loaded in the Middle.**—This case being exactly the converse of the balanced cantilever of Fig. 105, the stress-diagram and deflection curve of that cantilever require only to be inverted, as shown in Figs. 115 and 116.

The central load P_c takes the place of the supporting force at the centre of the cantilever, and is equal to $2P_a$. The forces P_a and P_b are now positive or upward forces, and the bending moments being positive, the deflections of the points A and C from the tangent $A_1B_1C_1$ will be *upwards* instead of downwards, but the offsets AA_1 and CC_1 will have the same values in terms of the stress-intensity \bar{bf} , or in terms of the force P_a .

The position of the curve relatively to the fixed portion of the bridge is determined in this case by the two fixed points A and C , and the

¹ These values are deduced from formulæ (5) and (6); and it is of course assumed that the girder is of uniform depth and section, and is free to turn upon the fulcrum B .

quantity commonly termed the "deflection" is the depression BB_1 , which is equal to AA_1 or CC_1 . Therefore expressing the stress and deflection in terms of the central load, we have—

$$\text{Stress intensity, } \bar{b}f = \pm \frac{P_b L'}{4AD}$$

$$\text{Deflection, } BB_1 = \frac{1}{8} \bar{b}f \times \frac{L^2}{ED} \quad \dots (15)$$

$$\text{or } BB_1 = \frac{P_b L^3}{24EAD^2} \quad \dots (15a)$$

For some purposes it will be necessary to find the offset CC_2 measured to the tangent Ag produced, and also the inclination¹ or angle $\frac{CC_2}{Cg}$. The former will be proportional to the moment of the *whole* triangle afc about

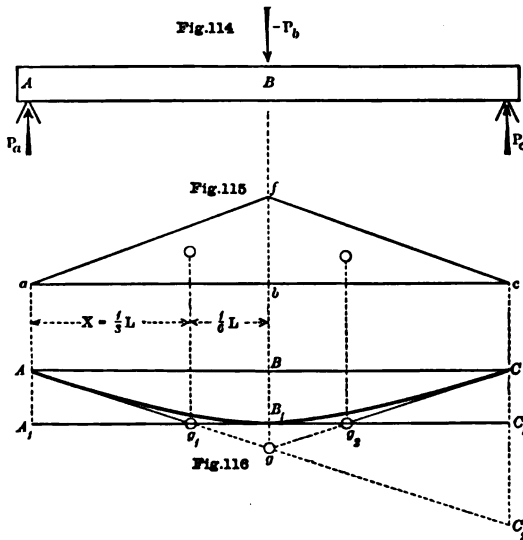

the point c , while the latter will be proportional to the area of the same triangle; therefore if G denotes that area —

$$\frac{CC_2}{Cg} = \frac{2G}{ED} = \bar{b}f \times \frac{L}{ED} \quad \dots (16)$$

$$\text{Offset, } CC_2 = \frac{2G}{ED} \times \frac{L}{2} = \frac{1}{2} \bar{b}f \times \frac{L^2}{ED} \quad \dots (17)$$

It only remains to notice that all the vertical offsets measured to the deflection curve *from the chord line AC* are proportional to the moments in a beam supported at each end and loaded with the triangular mass afc .

¹ In all cases we may take the horizontal length CB as practically equivalent to the inclined length Cg ; the difference being seldom greater than $\frac{1}{100000}$ th of the length.

91. Girder supported at each End and Uniformly Loaded.—The curve of the bent girder is always more clearly described by the deflection of the curve from its tangent than by any other means; and therefore in this case, as in the last, we may divide the stress-diagram *abcf* of Fig. 118 into two equal areas by the centre line *bf*, and then proceed to measure the deflection of each half of the girder (right and left of the centre) from the tangent *A₁B₁C₁* in Fig. 119. The moments being positive the curvature will be concave upwards, and the deflection of the

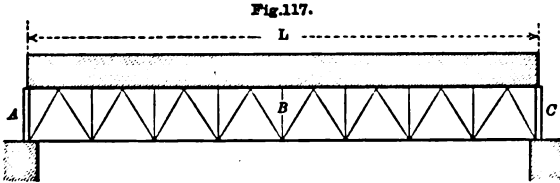

Fig. 118.

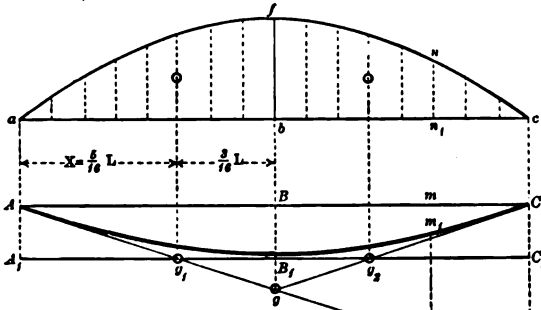
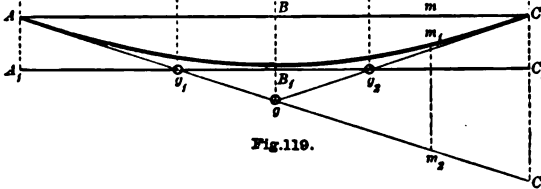

Fig. 119.



girder from the tangent will be an *upward* deflection as in the last example.

The area *afb* of either half of the stress-diagram will be $G_1 = \frac{2}{3}bf \times \frac{L}{2}$; while the horizontal distance of its centre of gravity from the point *A* will be $X = \frac{5}{16}AB = \frac{5}{16}L$.

Therefore the elements of the deflection curve will be as follows, viz.—

$$\text{Stress-intensity, } bf = \pm \frac{pL^2}{8AD}$$

$$\text{Inclination, } \frac{AA_1}{A_1g_1} = \tan. \psi_a = \frac{2G_1}{ED} = \frac{2}{3}bf \times \frac{L}{ED} \quad \dots (18)$$

$$\text{Length, } A_1g_1 = X = \frac{5}{16}L.$$

$$\text{Deflection, } BB_1 = AA_1 = \frac{5}{16}bf \times \frac{L^2}{ED} \quad \dots (19)$$

When employing this curve for the purpose of further investigations, it will sometimes be better to use the deflection offsets from the tangent AC_2 . The offset m_2m_1 , at any point, will of course be proportional to the moment of the area ann_1 about the point n_1 ; and therefore the offset C_2C will be proportional to the moment of the whole parabolic area about C . That area will be $G = \frac{2}{3}\bar{b}f \times L$; therefore—

$$\frac{CC_2}{Cg} = \frac{2G}{ED} = \frac{4}{3}\bar{b}f \times \frac{L}{ED} \dots \dots \dots (20)$$

$$\text{Offset, } CC_2 = \frac{2G}{ED} \times \frac{L}{2} = \frac{2}{3}\bar{b}f \times \frac{L^2}{ED} \dots \dots \dots (21)$$

In this example, as in the last, it may again be remarked that if the stress-diagram is taken to represent an imaginary load placed upon a girder supported at each end, the moments in that girder would be proportional to the ordinates BB_1 , mm_1 , &c., measured below the chord line AC of the deflection curve.

92. Girder uniformly Loaded and Strained over one Pier.—The form assumed by the loaded girder when it is not merely supported at each end, but also strained over one or both supports, is of great importance in the theory of continuous girders, and affords the only means of finding the stress in such bridges.

Suppose the girder described in the last example to be prolonged beyond the pier A as shown in Fig. 120, and to be loaded at I by a weight P . The diagram of moments for this case was considered in Articles 36 and 38, and is repeated as a diagram of stress-intensity in Fig. 121, in which ac is the base line. The negative ordinate ak represents the intensity of flange-stress at the pier A due to the pier moment P_1l_1 ; and drawing the straight line kc , the parabolic curve kfc is erected upon this line, and is merely a parallel projection of the parabolic diagram of Fig 118, so that the ordinate $\bar{b}f$, for example, represents the stress-intensity, $\frac{pL^2}{8AD}$, which would take place in the centre if the beam

were merely supported at each end. In the actual case the stress-intensity at that point is denoted by the ordinate $\bar{b}f$ above the base-line; and it will be evident that all ordinates above the base-line represent compression in the upper and tension in the lower flange, and *vice versa*. Therefore from A to T the girder will be deflected downwards, or hogged; while from T to C it will be sagged or deflected upwards; the point T being the "point of contrary flexure;" and the deflection of the girder at C below the tangent AC_1 will be proportional to the algebraical sum of the moments of the positive and negative areas tfc and akt .

The position of the curve in space is fixed by the two points A and C , but the curve itself is more clearly described by its deflection from the tangents. Starting from A , let AC_1 be a tangent to the curve. The inclination of this tangent is not yet known, but it will be found when

the offset C_1C is presently determined. Find the area and the centre of gravity of the figure akt , and dropping the vertical g_1g_1 from its centre of gravity, the point g_1 will fix the intersection of the tangents AC_1 and g_1C_2 . The angular deflection $C_1g_1C_2$ will be proportional to the area akt , and the downward offset or deflection C_1C_2 will be proportional to the moment of that area about C . Then drop the vertical g_2g_2 from the centre of the parabolic segment tfc , and drawing the tangent g_2C the

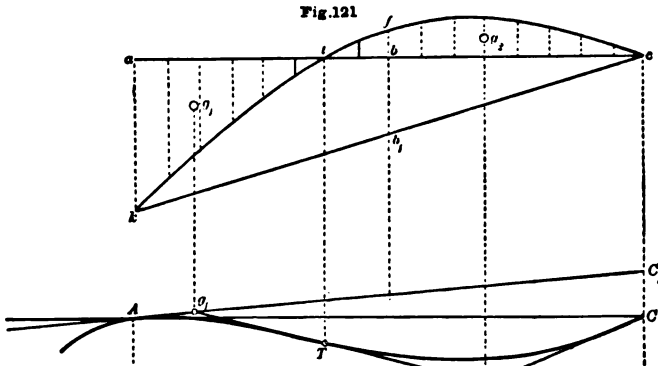
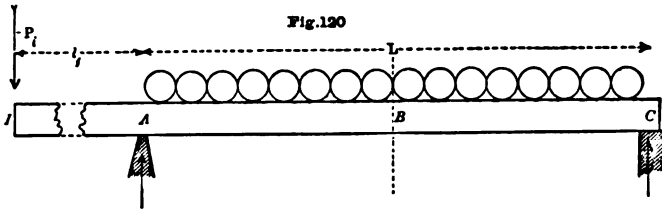

skeleton of the reverse curve is completed. The upward offset or deflection C_2C is of course proportional to the moment of the parabolic segment tfc , and thus we have the required offset $CC_1 = C_1C_2 - C_2C$. Therefore the offset CC_1 is proportional to the moment of akt , less the moment of tfc ; or, in other words, proportional to the moment of the triangle akc , less the moment of the entire parabola kfc . The moments of these two figures have already been found, and referring to formulæ (3) and (21), we have—

$$\text{Offset, } CC_1 = \left(\frac{2}{3} \overline{akc} - \frac{2}{3} \overline{b_1f}\right) \frac{L^2}{ED} \dots (22)$$

93. Girder uniformly Loaded and Strained over both Piers.—So far as the deflection of the span AC is concerned, it matters nothing by what load or forces the pier moments are produced, and therefore the last example will apply generally to the end spans of any continuous girder bridge; while the present example will apply to the intermediate spans, or indeed to any span of such a structure.

Let the stress-intensities due to the pier moments at A and C be denoted by the ordinates ak and co in Fig. 124, and drawing the line ko , the diagram will be completed by erecting upon that line the parabolic curve kfo , making the central ordinate b_1f equal to $\frac{pL^2}{8AD}$.

The deflection curve of Fig. 125 will be constructed upon the same principle as before. Starting from A let AC_1 be a tangent to the curve, whose inclination has to be determined by finding the deflection C_1C . Find the centre of gravity of each of the three areas akt_1 , t_1ft_2 , and t_2co , and drop the verticals g_1g_1 , g_2g_2 , and g_3g_3 . Then draw successively the tangents g_1C_2 , g_2C_3 , and g_3C , making the offset C_1C_2 proportional to the

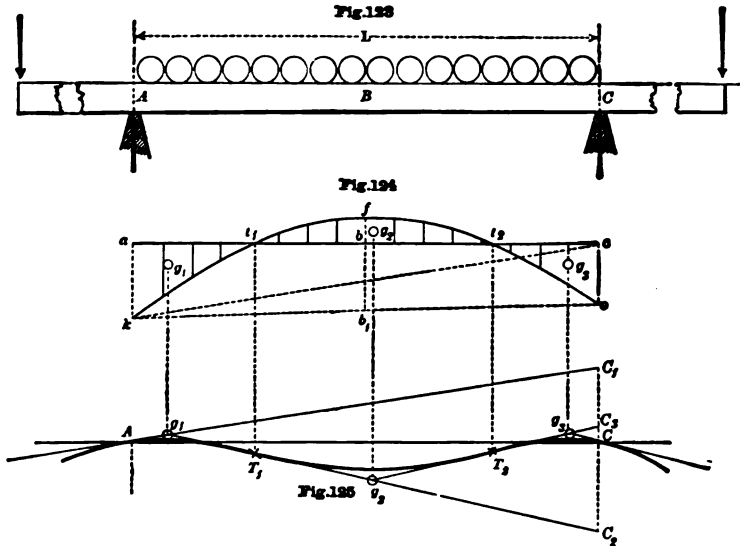

moment of the first-named area, and the offsets C_2C_3 and C_3C proportional to the moments of the second and third areas respectively. The offset CC_1 will be equal to $C_1C_2 - C_2C_3 + C_3C$; and therefore proportional to the algebraic sum of the moments of the three areas akt_1 , t_1ft_2 , and t_2co ; and therefore proportional to the moment of the trapezoid $akco$ less the moment of the parabolic area kfo . The trapezoidal area may be divided into two triangles, akc and kco , for which triangular diagrams the moments have been already found; and applying the formulæ (3), (5), and (21), we have the required offset CC_1 determining the inclination of the girder at A , or—

$$\text{Offset, } CC_1 = \left(\frac{2}{3}\overline{ak} + \frac{1}{3}\overline{co} - \frac{2}{3}\overline{b_1f}\right) \frac{L^2}{ED} \dots (23)$$

$$\text{Inclination, } \frac{CC_1}{AC} = \left(\frac{2}{3}\overline{ak} + \frac{1}{3}\overline{co} - \frac{2}{3}\overline{b_1f}\right) \frac{L}{ED} \dots (24)$$

94. The above diagrams and formulæ relate, of course, to the deflection of a parallel girder consisting of two flanges united by a web; but the same principles may without difficulty be applied to the deflection of a solid beam of uniform section; for in such a beam each pair of fibres or layers, situated respectively above and below the neutral axis by the vertical distance y , may be regarded as the flanges of a girder whose depth is $2y$; and these flanges being subjected to a stress whose intensity is $f = \frac{My}{I}$, the deflection will be proportional to the moment of the area of the stress-diagram for those fibres; and the deflection will be the same whichever pair of fibres is selected.

The beam being of uniform section, the diagram of stress-intensity for any fibre will be similar to the diagram of moments for the whole beam; and if G denotes the area of the diagram of *moments*, and X the distance of its centre of gravity from the extreme end of the beam, the deflection at that point will be proportional to the moment or product GX .

Thus referring to the primary example of the cantilever illustrated in Fig. 95, from which all the subsequent solutions have been derived, the deflection of any solid beam will be given by—

$$\text{Deflection, } BB_0 = \frac{GX}{EI} \dots \dots \dots (25)$$

in which I is the moment of inertia of the beam's cross-section.

It is worthy of notice that although the theoretic distribution of stress in the fibres of the solid beam cannot be depended upon as indicating the ultimate stress or breaking load of the beam, yet the same theory, when applied to the elastic deflection of a solid beam, as above described, appears to be in close accordance with the results of experiment; and it follows as a geometrical necessity that the longitudinal *strain* of the extreme fibres must be very nearly equal to the value deduced by that theory. It is geometrically impossible to reconcile the observed deflection of a cast-iron beam with any *smaller* amount of longitudinal strain than that deduced by theory, except by supposing that a much larger portion of the deflection is due to *shearing distortion* than is usually believed. To examine the question whether this shearing distortion can possibly explain the divergence between the theoretic strength and the theoretic deflection of a cast-iron beam, Professor Kennedy has recently made some experiments at the author's suggestion, by which the inclination of the originally vertical lines (C_1c_1 , &c., in Fig. 94) was very accurately measured by a ray of reflected light; and it was found that in the bent beam those lines are so nearly radial to the curve of deflection, that the value of the longitudinal strain in the extreme fibres must certainly be very nearly the same as that which is indicated by theory.

It will be remembered that in all cases the deflection spoken of is to be understood as the deflection of the point in question above or below a tangent AB drawn to the elastic curve at the point of origin of the

diagram of moments, and representing the original line of the unstrained girder as referred to that point.

95. The deflection of a beam or girder under any distribution of upward and downward forces may easily be traced by the methods which have been here described; but it must be remembered that the method which we have recently been dealing with will only apply to beams or girders of uniform section. If the girder is made with flanges of varying sectional area, the deflection, in many cases, can only be accurately found by constructing a diagram of the *actual intensity of stress* under the given load.

Thus, for example, the main girders of a swing bridge recently constructed by the author, were proportioned—as such girders usually are—to the maximum stress that can take effect under any of the varying conditions of the structure; and when the bridge is opened, and supported only upon the turn-

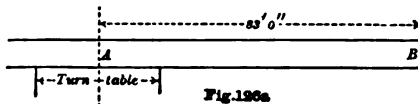

Fig. 126a

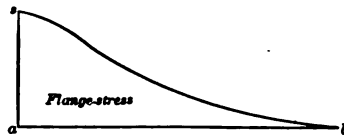

Fig. 126b

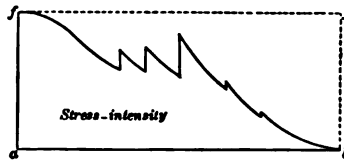

Fig. 126c

table, as shown in Fig. 126A, the intensity of stress in the flanges varies at different points within very wide limits.

It was important, however, to ascertain beforehand the probable deflection of the girders in this condition, as the proper adjustment of the work depended upon it. The actual diagram of moments, or diagram of flange-stress, is given in Fig. 126B, while the diagram of stress-intensity is represented in Fig. 126c. The moment of the latter figure about the point *b* having been calculated, the theoretic deflection

at *B* was found to be $2\frac{3}{4}$ inches, and the adjustments of the fixed supports were made accordingly. When the girders were completed and swung into position across the stream, the actual deflection was found to be only about one-tenth of an inch less than had been calculated; and although so close a coincidence must have been partly due to accident, yet it is certain that if the calculation had been made upon the hypothesis of uniform section, or of uniform stress, the result could not have been nearly so accurate—for in the former case the calculation would be equivalent to a measurement of the moment of the diagram *asb* in Fig. 126B; while in the latter case it would be equivalent to the moment of the rectangle *affb* in Fig. 126c.

96. In conclusion, it may be remarked that the initial "camber" which is required in order to bring any proposed girder into a

straight line when it is loaded, may easily be obtained by making the initial length of each strut greater than its designed length in the proportion of $(1 + \frac{f}{E})$ to 1; and at the same time making every tie shorter than its designed length in the proportion of $(1 - \frac{f}{E})$ to 1.

Thus if every member is designed with a working stress of 4 tons per square inch of gross sectional area, the struts will have to be lengthened in actual manufacture by $\frac{4}{12,000} = \frac{1}{3,000}$ th of their designed length; while the ties must be shortened in like proportion. These small increments or decrements of length are sometimes specified upon the working drawings of the bridge.

CHAPTER IX.

CONTINUOUS GIRDERS.

97. The problem of finding the bending moments in a continuous girder has formed the subject of many learned and extensive treatises ; and by the labours of Clapeyron, Bressé, Heppel, and others, a definite mathematical theory of continuous girders has been successfully built up. The formulæ deduced by these investigations are, however, very lengthy—so much so, that the computation of the stresses becomes in some cases a very tedious and laborious undertaking. Moreover, the formulæ are open to the objection that they do not exhibit, in their construction, the line of reasoning on which they depend ; and therefore no engineer can feel much confidence in using them, until he has himself followed out the complex processes of their construction.

These difficulties may, however, be removed by using *geometrical* instead of *analytical* methods ; and in working out the problem by this means, the graphic diagrams will themselves illustrate the chain of reasoning on which the solution of the problem must depend.

The main difficulty of the question arises from the fact that, when a girder is supported at more than two points, the vertical reactions or supporting forces cannot be found by the law of the lever. The external forces are therefore not all known, and consequently the internal stresses cannot be determined except by reference to the elastic deflection of the girder.

To illustrate this, we may take the case of a continuous girder of two equal spans, the girder being supported, as in Fig. 127, upon the extreme abutments, *Z* and *C*, and upon a central pier at *A*, and loaded throughout with a uniform load. It is obvious that in this case the law of the lever would be satisfied if the girder were balanced upon the central pier without pressing upon the abutments at either end ; and that it would be equally satisfied if the girder rested entirely upon the two abutments without touching or without pressing upon the central pier. Therefore, if the girder were inflexible, the smallest conceivable elevation or depression of the central bedplate would have the effect of either bringing the whole load upon the central pier, or leaving it to be entirely carried by the two abutments.

In the first case, the girder would be subjected to a severe tensile stress in the upper flange, and the diagram of stress would be represented

by the curves zk_1 and ck_1 in Fig. 128; while in the second case the stress would be equally severe in the opposite direction, the diagram being the parabola zk_2c ; and as this enormous difference of stress would be producible by the slightest inequality in the level of the three bedplates, it would be impossible to say what value (between these extremes) the stress would really have. In fact, if the girder were inflexible, the problem would be insoluble.

But the girder is elastic; and it is evident that neither of these

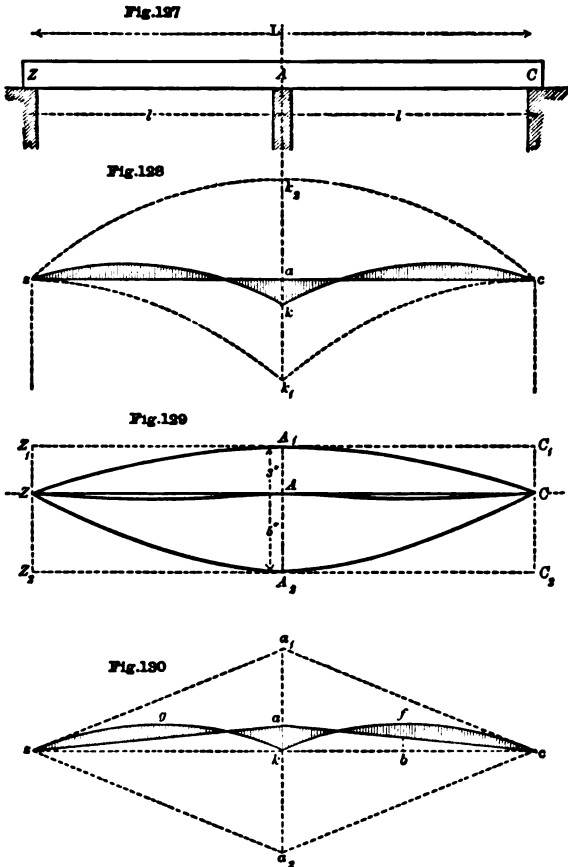

extreme stresses could really take place unless the girder were bent to the corresponding curvature, which could only happen if the central pier were elevated or depressed by a certain *appreciable* difference of level, corresponding with the upward or downward curvature.

For example, to examine these conditions more closely, we will assume that the length $ZC = L = 120$ feet, each span having the length $l = 60$ feet; also that the girder has a uniform depth of 6 feet, and each

flange a uniform sectional area of 30 square inches ; and let the girder be covered with a uniform load of 1 ton per foot from Z to C . Then the exact results in each case will be as follows :—

First, If the central pier carries the whole bridge as a balanced cantilever, the tensile stress in the upper flange at A will be $\frac{60^2}{2 \times 6} = 300$ tons, or just 10 tons per square inch, as denoted by the ordinate ak_1 ; and referring to formula (6) of the preceding chapter, it follows that each end of the girder must deflect below the tangent $Z_1A_1C_1$ (in Fig. 129) by the amount $C_1C = \frac{1}{2} \times 10 \times \frac{60^2}{12,000 \times 6} = 0.25$ feet, or 3 inches.

Therefore this great tensile stress can only take place when the central pier is raised 3 inches above the true level as shown by the curve ZA_1C .

Secondly, If the central pier carries no load at all, the girder being supported only at Z and C , the upper flange at A will be subject to a compressive stress of $\frac{120^2}{8 \times 6} = 300$ tons, or 10 tons per square inch ; and referring to formula (19) we have the central deflection (in Fig. 129) $AA_2 = \frac{5}{24} \times 10 \times \frac{120^2}{12,000 \times 6} = \frac{5}{12}$ feet, or 5 inches.

Therefore this latter stress can only take place when the central pier is lowered 5 inches below the level of the abutments as shown by the curve ZA_2C .

Thirdly, If the three supports are adjusted at the same level, it is evident that the stress will have some intermediate value between these two extremes.

It will be observed that if the central pier is gradually raised, from 5 inches below, to 3 inches above its true level (through a total range of 8 inches), the flange-stress passes from + 300 tons to - 300 tons ; while the pressure on the central pier increases from 0 to 120 tons. Now it may be shown that all these changes really take place in the same proportion throughout the range ; that is to say, if the central bedplate is wedged up inch by inch from its lowest position at A_2 , each successive inch of elevation will increase the pressure on the central pier by one-eighth of the total load, and will diminish the compressive stress in the upper flange by one-eighth of 600 tons ; so that if the bedplate is raised 5 inches (to the position A), the load on the central pier will be five-eighths of the whole load, and the stress in the upper flange will be $300 - (\frac{5}{8} \times 600) = - 75$ tons, or a tensile stress of 75 tons, equivalent to $2\frac{1}{2}$ tons per square inch.

This statement is not a demonstration, but the example will serve to illustrate the nature of the problem, and shows that the solution in any case must depend on the elastic deflection of the girder, and will be governed by the condition that the deflection curve must have such a form as to bring the three points Z , A , and C to the same level. The relation between the deflection curve and the stress-diagram was described in the

last chapter, and this interdependence will enable us to construct the stress-diagram by means of the deflection curve.

For the present we shall commence by making the usual assumption, viz., that the girder is a girder of uniform section; and it will be remembered that for such girders the diagram of moments is at the same time a diagram of flange-stress, and also a diagram of stress-intensity.

98. To carry on this examination, it will greatly facilitate matters if we first arrange the stress-diagram in such a way that we can readily trace the variations of form which it undergoes when the central pier is raised or lowered—i.e., when the pier-moment at *A* is increased or decreased. If the ordinate *ak* in Fig. 128 represents the unknown tensile stress in the upper flange, the stress-diagram will be completed by drawing the two parabolic curves *ck* and *zk*, which will be segments of the same parabola as the curves *ck*₂ and *ck*₁; in fact the only difficulty in any case is to find the value of the pier-moment or the stress *ak*; and in order to determine this variable ordinate by geometric methods it will be more convenient to exhibit the variations in the stress-diagram by moving the straight datum-lines as in Fig. 130, rather than by reconstructing the curves in new positions.

In that figure, let the straight line *zkc* be drawn as a provisional datum line, and upon it erect the parabolic diagrams *zgc* and *kfc*, treating each span as a detached girder supported at the ends; that is to say, if *p* denotes the uniform intensity of the load, make the central ordinate \bar{bf} to represent the stress $\frac{pl^2}{8D}$ or the stress-intensity $\frac{pl^2}{8AD}$. Then, as soon as we can find the value of the pier-moment or the stress *ak*, we have only to set off *ka* and draw the straight lines *za* and *ac*, which will be the datum-lines in the diagram for the continuous girder. Thus by raising or lowering the point *a* we can readily produce the entire stress-diagram for any variable value of the pier-moment or stress *ak*.

Reverting now to the deflection curve of Fig. 129, it is evident that the girder being symmetrical about *A*, and symmetrically loaded, the tangent *ZAC*, *Z₁A₁C₁*, &c. (drawn to the curve at *A*), will always be parallel to the horizontal line *ZC*; and if we measure all deflections from that tangent, we must have an elastic curve which will give no deflection at *Z* and at *C*. In other words, the reverse bending strains and reverse curves of the girder must be such as to bring the two ends to the same level as the central pier.

Now it was shown in Art. 92 that if the girder *AC* is uniformly loaded and subjected to any variable bending stress over the pier *A*, the deflection at *C* will be proportional to the moment of the triangular stress-diagram *akc*, less the moment of the parabolic area *kfc*, and will be expressed by $(\frac{2}{3}\bar{ak} - \frac{2}{3}\bar{bf}) \frac{l^2}{ED}$. Therefore the solution is very simple, and the required stress at *A* will be—

$$\bar{ak} = \bar{bf} \dots \dots \dots (1)$$

for the height \bar{ak} must be such that the moment of the triangle is exactly equal to the moment of the parabola.

It follows, of course, that the flange-stress \bar{ak} = flange-stress \bar{bf} , and bending moment \bar{ak} = bending moment \bar{bf} .

99. Geometric Measurement of the Slope.—In the last example the problem was simplified by the circumstance that the direction of the tangent A_1C was known beforehand; but if the two spans of the continuous girder are of unequal length, or unequally loaded—or again if the bridge consists of more than two spans, it must not be assumed that the girder will lie in a horizontal position over the piers. Thus if Fig. 132 represents any span in a continuous girder bridge, the lines AC_1 and CA_1 , representing tangents drawn to the deflection curve at the piers A and C , may have any inclination upwards or downwards. It has been shown, however, in Art. 93, that these inclinations may be calculated from the actual stress-diagram for the span AC ; and as the solution of the whole problem will depend upon this question, we shall now proceed to describe a geometrical artifice by which the slope of the girder may be measured directly upon the stress-diagram without further calculation.

Let the stress-diagram of Fig. 131 be drawn in the manner before

described; i.e., upon the provisional datum-line ko erect the parabolic diagram kfo for the uniform load as for a detached girder supported at each end; and whatever may be the unknown value of the pier-moments, let ak and co represent the stresses due to those moments, and draw the straight line ac for the datum-line of the diagram.

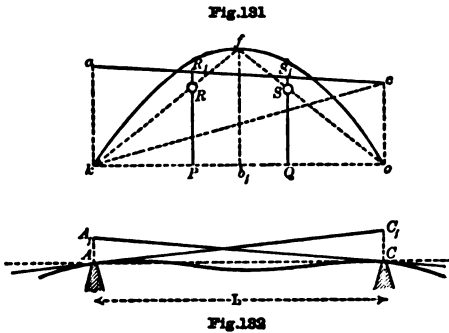

Divide the span ko into three equal parts, and at the points of division P and Q set up the verticals PR_1 and QS_1 , intersecting the datum-line in R_1 and S_1 . Then, by the well-known property of the triangles cak and kco , the height PR_1 will be equal to $\frac{2}{3}ak + \frac{1}{3}co$, while the height QS_1 will be equal to $\frac{2}{3}co + \frac{1}{3}ak$.

Now it has been shown in Art. 93, formulæ (23) and (24), that the deflection C_1C below the tangent AC_1 is expressed by—

$$C_1C = \left(\frac{2}{3}\bar{ak} + \frac{1}{3}\bar{co} - \frac{2}{3}\bar{b_1f} \right) \frac{L^2}{ED};$$

the ordinates ak , &c., being measured as stress-intensities.

Therefore if we set off PR and QS each equal to $\frac{2}{3}\bar{b_1f}$, we shall have $RR_1 = \frac{2}{3}\bar{ak} + \frac{1}{3}\bar{co} - \frac{2}{3}\bar{b_1f}$, and therefore—

$$\text{Deflection, } C_1C = \overline{RR}_1 \times \frac{L^2}{ED} \quad \dots \quad (2)$$

$$\text{Inclination, } \frac{C_1C}{AC} = \overline{RR}_1 \times \frac{L}{ED} \quad \dots \quad (3)$$

By a repetition of the same reasoning we may also represent the inclination of the girder at the pier *C* by the ordinate *SS*₁, or—

$$\text{Inclination, } \frac{AA_1}{AC} = \overline{SS}_1 \times \frac{L}{ED}$$

The points *R* and *S* may for the sake of distinction be termed the “characteristic points” in the diagram. The stresses in the continuous girder, as well as the inclination of the girder, will depend solely upon their position in the respective diagrams of the several spans; and it may be noted that their position in the diagram is *entirely independent* of the variable and as yet unknown values of the pier-moments; and having drawn the simple parabolic diagram *kfo* as for a detached span, the characteristic points in that diagram may be fixed at once by simply drawing the straight lines *fk* and *fo*, which will intersect the verticals *PR* and *QS* in the two characteristic points *R* and *S*.

Then whether the diagram is considered as representing the moments, the stresses, or the stress-intensities, the heights *RR*₁ and *SS*₁ will indicate the slope of the girder at *A* and *C* respectively. If the movable base-line *ac* passes *above* the point *R*, the slope of the girder at *A* will be *upwards* towards the middle of the span; while if it passes *below* that point, the slope will be *downwards*; and measuring the height *RR*₁ upon the scale of *stress-intensities*, we have the definite value of the slope at *A* expressed by $\overline{RR}_1 \times \frac{L}{ED}$. If the datum-line happens to pass *through* either of the points *R* and *S*, the girder must lie in a horizontal position at the corresponding pier.

100. Continuous Girder of any Number of Equal Spans.—To illustrate the general method of solution, we will first suppose that all the spans are of equal length, and that the load is uniformly distributed over each span, although the intensity of load may have different values for the several spans. For example, Fig. 133 represents a bridge of three equal spans, in which the spans *AC* and *CE* are more heavily loaded than the span *EZ*. Upon the provisional datum-line *az* in Fig. 134 construct the parabolic diagrams *amc*, *cne*, &c., for each span as for a detached girder, and let *L*₁, *L*₂, and *L*₃ denote the lengths of the spans *AC*, *CE*, and *EZ*. Divide each span into three equal parts, and at the points of division in the first span erect the verticals *PR* and *QS*, each equal to $\frac{2}{3} \overline{bm}$. Also in the second span erect verticals at *W* and *Y*, and on these verticals set off *WT* and *YU*, each equal to $\frac{2}{3} dn$; and so on for each span of the bridge, thus fixing in each span a pair of “characteristic points” *R* and *S*, *T* and *U*, *V* and *X*.

The base-line of the diagram will consist of three lines ac_1 , c_1e_1 , and

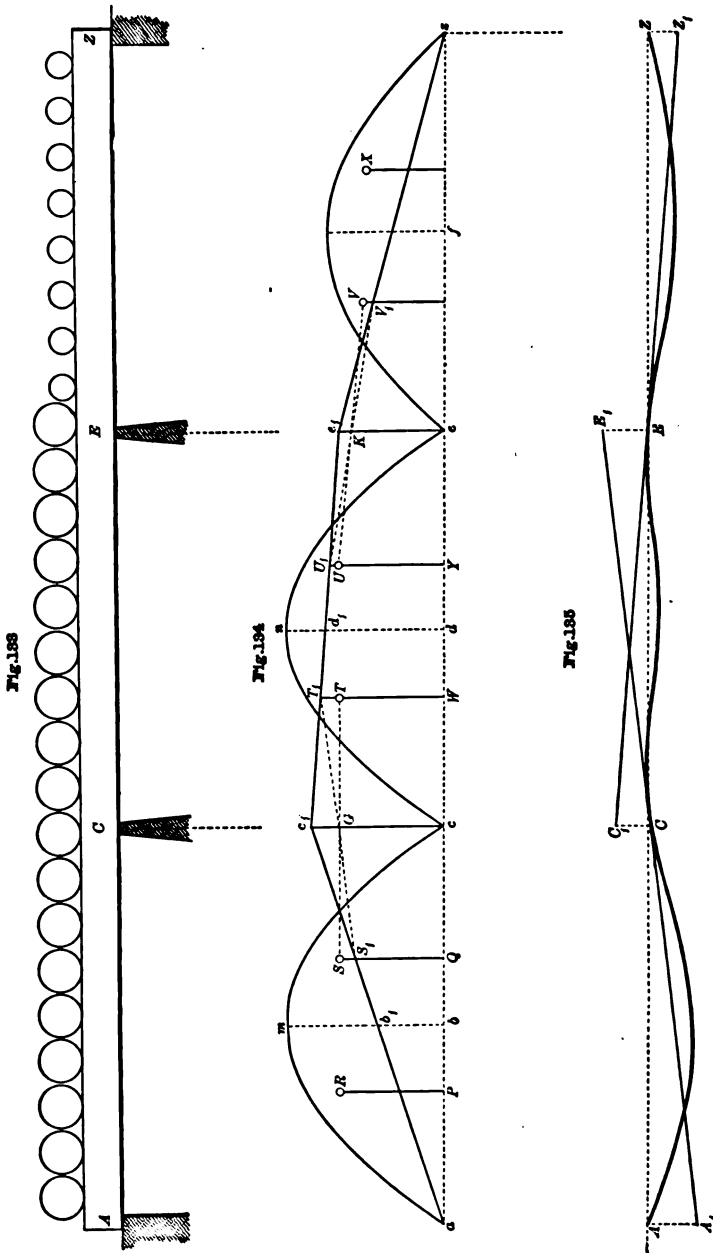

e_1z , which can be drawn as soon as the pier-moments or stresses c_1c and

e_1e are determined; so that all the stresses throughout the bridge will be determined only when the points c_1 and e_1 have been fixed.

If it so happens that the girder lies in a truly horizontal position upon the two piers, the base-line must pass through the four points $S, T, U,$ and V ; but this must not be taken for granted, and indeed will not be the case in the present instance. But let the straight lines A_1CE_1 and C_1EZ_1 , in Fig. 135, represent the tangents to the deflection curve at the piers C and E ; then, although we do not know the inclination of these lines, we know that the upward inclination of CE_1 is the same as the downward inclination of CA_1 ; and it has been shown that the former is measured by the height TT_1 and the latter by the downward or negative ordinate SS_1 in the stress-diagram. Therefore we have the necessary equation—

$$\overline{TT_1} \times L_2 = - (SS_1 \times L_1) \dots \dots \dots (4)$$

In the same way, at every pier of the bridge, we have a pair of “characteristic points” right and left of the pier, whose relative distances from the movable base-line are expressed by the same equation; thus at the pier E , we have $\overline{UU_1} \times L_2 = - (VV_1 \times L_3)$, and so on.

In the present case the spans L_1, L_2, L_3 are all equal, therefore—

$$TT_1 = -SS_1; \quad UU_1 = -VV_1.$$

It will be observed that the characteristic points are already fixed, and it is the position of the movable base-line ac_1e_1s which is determined by these equations. It follows that this movable line *must be so adjusted at each pier, as to pass over one point and under the other, and at equal distances from both.*

This reduces the problem to very simple terms, and it will be found in practice that the movable base-line can be adjusted in a few minutes by trial and error, so as to comply with this governing condition. The engineer, who is accustomed to laying down the gradients upon a railway section, will have no difficulty in effecting this familiar adjustment; for he has only to suppose that the point c is a break of gradient, and that he has to adjust his grades so as to pass under the fixed point S and over the fixed point T by equal depths of cutting and embankment.

Perhaps the quickest method will be to draw the lines ST and UV connecting each pair of fixed points and intersecting the pier-verticals at G and K . Then the point c_1 must be raised until a straight edge laid across S_1T_1 cuts through the point G ; and the same at each pier of the bridge.

101. Continuous Girder of Unequal Spans.—Suppose now that the spans are of unequal width, and let the stress-diagram be represented by Fig. 136, in which the several lines and points of intersection are distinguished by the same letters as in the last example. It has already been shown that the upward slope of the girder at the pier C (upward towards E) is measured by the ordinate $\overline{TT_1}$ multiplied by the span L_2 ,

while the same slope (downward towards *A*) is measured by $\overline{SS_1}$ multiplied by L_1 . Therefore, $SS_1 = TT_1 \times \frac{L_2}{L_1} = TT_1 \times \frac{Wc}{Qc}$.

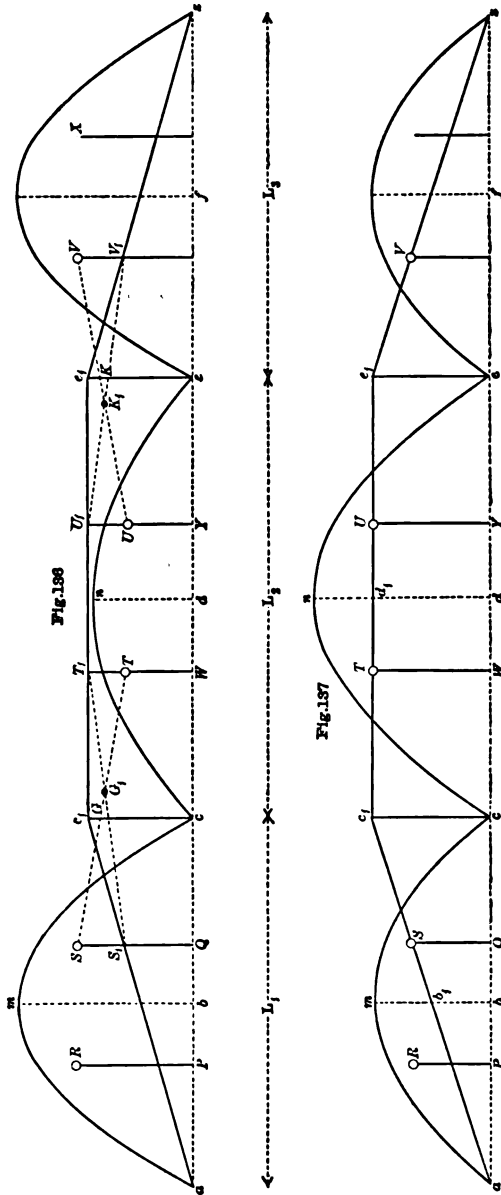

Draw the line ST intersecting the pier vertical at G ; and from T set

off $TG_1 = SG$. Then $\frac{SG}{TG_1} = \frac{Wc}{Qc}$; and it follows that the straight line S_1T_1 will have to pass through the point G_1 . The movable base-line ac_1e_1z must therefore be adjusted by raising the point c_1 until a straight-edge laid across S_1T_1 cuts through the point G_1 .

The diagram, Fig. 136, represents the stress that would take effect if the two side spans were loaded much more heavily than the central span; and illustrates the effect which such a load may produce in throwing the whole of the central span into a condition of negative bending stress, or hogging curvature, without any contrary flexure at any portion of the span. In this case the girder would of course lie at a considerable inclination over each pier, as indicated by the large ordinates SS_1 and TT_1 .

It has already been mentioned that if the girder lies horizontally upon the piers, the base-line ac_1e_1z must pass through the four points S , T , U , and V , as shown in Fig. 137, in which case cc_1 is equal to WT . It is evident that $a\bar{Q}$ being equal to two-thirds of \bar{ac} , this condition of things will only take place when $QS = \frac{2}{3}WT$; or in other words, when $\bar{dm} = \frac{2}{3}\bar{dn}$. If all the spans are of equal length, this will happen when the intensity of load on the side spans is two-thirds that of the central span. If the load is uniform throughout the bridge, the same condition may be obtained by making each of the side spans \bar{ac} and \bar{ez} shorter than the central span in the proportion of $\sqrt{\frac{2}{3}}$ to 1; or about $\frac{8}{10}$ ths the width of the central span; and it is obvious that if the bridge consists of *any number* of spans of the length L_2 with the addition, at each end, of a shorter span equal to $0.8L_2$, the moment at *each* pier will be $CC_1 = \frac{2}{3}\bar{dn}$; and the moment at the centre of every span (including the end spans) will be $\bar{d}_1n = \bar{b}_1m = \frac{1}{3}\bar{dn}$.

In a bridge of these proportions, under the uniform load, each of the end spans is in the condition of a beam fixed horizontally at one end and supported at the other end; while each of the remaining spans is in the condition of a beam fixed at both ends.

102. Effect of Irregular Loading.—It has already been pointed out that when some of the spans are more heavily loaded than others, the stresses are changed through the whole length of the bridge, as illustrated by a comparison of the two diagrams, Figs. 136 and 137; and by the methods above described we may easily trace the different forms which the stress-diagram will assume when first one and then another of the spans is covered by the rolling load.

In this way we may find approximately what is the greatest stress that will take place at any given point; and in calculating the requisite strength of the members it is not usual to go farther than this; but evidently the rolling load may sometimes cover only a *portion* of any span, and it may therefore be desirable to find the stresses that occur when any of the spans are irregularly loaded.

The solution of any such case may be effected in the same manner as before, when the "characteristic points" of the particular diagram have

been fixed. Thus, treating the span in question as a detached girder, let the figure kfo in Fig. 138 represent the irregular stress-diagram due to

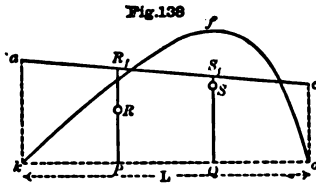

any given irregular load. Find the area and the centre of gravity of the figure kfo , and make PR equal to the height of a rectangle whose length is ko and whose moment about the point o is equal to that of the irregular figure kfo ; i.e., if m denotes the moment of the irregular figure

about o , make $PR \times \frac{L^2}{2} = m$, or $PR = \frac{2m}{L^2}$. In the same way, if n denotes

the moment of the irregular figure about k , make $QS = \frac{2n}{L^2}$. Then R and

S will be the characteristic points for the diagram; and if \overline{ac} represents the true base-line, the slope of the girder at the pier A will be expressed,

as usual, by $(\frac{2}{3}\overline{ak} + \frac{1}{3}\overline{co} - PR) \frac{L}{ED} = \overline{RR_1} \times \frac{L}{ED}$.

103. Effect of Settlement in the Piers.—We have hitherto assumed that all the supports are fixed exactly at the same level, or else that they are laid upon a true gradient, so that in either case an inflexible straight edge laid along the line of the girder would exactly touch every one of the supports. This assumption is indeed generally laid down as the basis of the theory, but it is obvious that the stresses would be materially affected if one of the piers should happen to be a little higher or a little lower than the others. In the case of the small two-span bridge illustrated in Fig. 127, the upper flange was subject to a maximum tensile stress of 75 tons at A ; but it was found that a variation of one inch in the level of the central pier made a difference of 75 tons in the flange-stress; so that a settlement of one inch in that pier would really bring the girder into the condition of two detached spans, reducing the flange-stress at A to nothing, and doubling the stress at the centre of each span.

Therefore, seeing that masonry piers are liable to settlement, and that iron piers are liable to expansion and contraction, it is evidently necessary to take account of these and other similar contingencies, and to calculate the extent of their effect. In the case just mentioned their effect is so considerable, that the bridge would probably have been a safer and more economical structure if it had been made in two detached spans; but it must not be hastily concluded that continuous girders are liable, without distinction, to such wide variations of stress, nor that the calculations are for this reason unreliable in practice; for it will presently be shown that these changes of stress depend very much upon the character of the design. A settlement of one inch in either of the piers of the Britannia Bridge would hardly be felt by the ironwork, the resulting increment of stress being nowhere greater than $\frac{1}{2}$ ton per square inch. In short, it would be as unwise to draw any such sweeping conclusion as to neglect the question

altogether ; and the true conclusion is that the question must be carefully examined for each case. By the geometrical method this may very easily be done ; for the effect of any given settlement is represented by a certain simple alteration in the position of the "characteristic points."

In the deflection diagram, Fig. 140, let the horizontal line ACE represent the *intended* level of any three consecutive piers of the bridge ; and suppose that while the piers A and E retain their original level, the

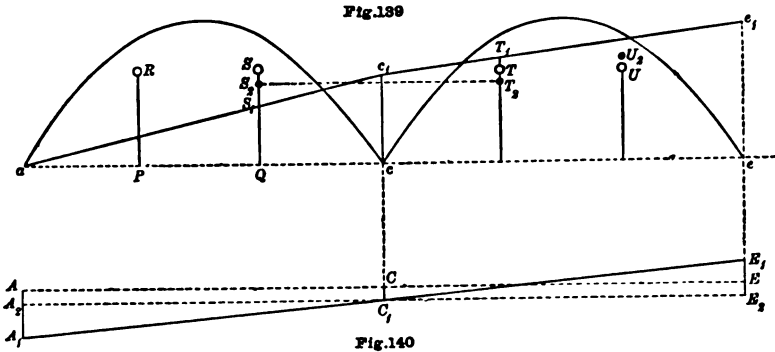

pier C settles below the chord line by the vertical distance $CC_1 = \delta$. Let $A_1C_1E_1$ represent a tangent drawn to the deflection curve at C_1 , so that AA_1 and EE_1 are the actual upward and downward deflections of the girder as measured from this tangent. Of course $\frac{AA_1}{AC}$ will not represent

the true slope of the tangent, and the original equation $\frac{AA_1}{AC} = \frac{EE_1}{EC}$ will no longer hold good. But if a horizontal line $A_2C_1E_2$ is drawn through the sunken support C_1 , the slope of the tangent will be $\frac{A_1A_2}{AC} = \frac{E_1E_2}{EC}$, or $\frac{AA_1 - \delta}{L_1} = \frac{EE_1 + \delta}{L_2}$.

Let Fig. 139 be a diagram of *stress-intensity*, in which the characteristic points R , S , T and U (for level supports) have been fixed in the manner before described, so that—

$$\overline{SS_1} \times \frac{L_1^2}{ED} = \text{deflection } AA_1; \text{ and}$$

$$\overline{TT_1} \times \frac{L_2^2}{ED} = \text{deflection } EE_1.$$

Below the point S set off, on the scale of stress-intensities, the length $SS_2 = E \cdot \frac{D\delta}{L_1^2}$, and in like manner set off below T the length

$TT_2 = E \cdot \frac{D\delta}{L_2^2}$. The points S_2 and T_2 will be the new characteristic points resulting from the settlement of the pier C ; that is to say, the points will

be so situated that $\overline{T_2T_1} \times \frac{L_2}{ED}$ will represent the upward slope $\frac{E_2E_1}{EC}$, while the equal downward slope $\frac{A_1A_2}{AC}$ will be represented on the diagram by

$$\overline{S_1S_2} \times \frac{L_1}{ED}$$

For $T_2T_1 = TT_1 + TT_2$, and by substituting the above value of TT_2 we obtain $(TT_1 + TT_2) \frac{L_2^2}{ED} = EE_1 + \delta = E_2E_1$; and in the same way

$$(\overline{SS_1} - \overline{SS_2}) \frac{L_1^2}{ED} = AA_1 - \delta = A_1A_2.$$

The new characteristic points having thus been fixed, the diagram may be completed for any given case by drawing the base-line $\overline{ac_1e_1}$, &c., as before described, making $\overline{T_2T_1} \times L_2 = \overline{S_1S_2} \times L_1$.

Thus when the central support is *lower* than the chord line joining the two adjacent supports, the effect is to *lower* the position of the two characteristic points (right and left of the sunken pier) by an amount proportional to the subsidence δ . In the same way if the central pier stands *higher* than the two adjacent piers, the couple of characteristic points S and T must be *raised* by an amount proportional to the superelevation of the pier above the chord line.

If all the piers in a bridge of several equal spans are fixed at one level, and if afterwards the n th pier alone settles down below that level by the amount δ , the result will be that the $(n-1)$ th and the $(n+1)$ th piers will be left standing with a superelevation of $\frac{\delta}{2}$ above their respective chord lines. Therefore in this case the couple of characteristic points at the n th pier will be lowered by the amount $\frac{ED\delta}{L^2}$; while the couple of points right and left of each of the latter piers will have to be *raised* at the same time by half that amount. This will further augment the resulting changes of stress, or the distortion of the movable base-line.

It will be observed that the change of stress in any case is proportional to the ratio $\frac{D}{L}$ and to the ratio $\frac{\delta}{L}$. The first of these is fixed arbitrarily by the engineer, and is usually made smaller in continuous girders than in detached spans, although there are some existing bridges in which the ratio of depth to length in some of the spans is very great; and such bridges are undoubtedly liable to great changes of stress which would ensue from the smallest error in their adjustment or from a very slight subsidence of the supports.

With regard to the ratio $\frac{\delta}{L}$, there is no reason for assuming that this will be constant for all spans. If the piers are 300 feet apart, the error of level δ , whether it arises from imperfect adjustment or from unforeseen settlement, is not likely to be any greater than if the piers were 30 feet

apart ; and it follows that this question of subsidence is of less importance in large bridges than in small ones.

104. Designed Variation in Level of Supports.—In some cases it may be desirable to fix the supports at varying levels in order to effect certain changes in the stresses. Thus, for instance, if the girder is to have a uniform section, it may be desired to reduce the maximum stress over the supports until it is no greater than the maximum stress in the centre of each span. The necessary adjustment in the level of the supports, to produce any such required adjustment of the stress, may be found by the method above described, and needs no further examination at this moment.

105. Expansion and Contraction of Iron Piers.—When a continuous girder is supported upon lofty iron piers, the expansion and contraction of the piers will generally produce an irregularity in the level of the supports, and consequently a certain change of stress, which may be estimated by means of the method above described. It may be assumed that the changes of temperature, from which these alterations proceed, will take place equally in all the piers ; while, of course, the expansion of each pier will be proportional to its height. Therefore if all the piers were of the same height, their expansion would produce no deformation in the line of the girder, and no change of stress. But in most cases these tall piers are employed in bridges or viaducts crossing deep valleys, the ends of the girder being supported upon masonry abutments at each end of the viaduct ; and the simultaneous expansion or contraction of the intervening piers will then have the effect of raising or depressing the supports by an amount which at each pier is proportional to the depth of the valley ; so that the line of supports, distorted by change of temperature, reproduces on a very small vertical scale the section of the valley itself. If the valley presents a rounded section, the distortion or flexure of the girder at any one pier is very slight, and far less than would result from the isolated elevation or depression of one pier alone.

To illustrate the general method of calculation, we may refer to Fig. 141, which represents the proportions of the Kentucky bridge,¹ consisting of three spans of 375 feet. The iron piers are each 180 feet in height, and the depth of the girder is very nearly $\frac{1}{10}$ th of the span. If we draw the line *AD* intersecting the pier *BC* in the point *F*, it will be evident that the superelevation of the point *C* above a chord-line *AE* will be measured by the expansion of the portion *BF* ; because if *F* were the base of the expanding iron pier, the simultaneous expansions of *FC* and *DE* would not affect the straightness of the line *ACE*. In the same way the superelevation of the support *E* above the chord-line *CZ* will be measured by the expansion of the portion *DG* intercepted below the line *BZ* ; and in the present example the height *BF* or *DG* will be one-half the height of the pier or 90 feet in each case.

Taking an extreme range of temperature of 120° Fahr., we may

¹ Vide *Proceedings of the Institution of Civil Engineers*, vol. liv.

suppose the supports to be adjusted in a level line at mean temperature ; and the extreme variation of 60° in either direction will produce a super-elevation or depression equal to $1\ 90\ \text{ft.} \times \cdot 0004 = \cdot 036\ \text{ft.} = \delta$. Therefore $\frac{\delta}{L} = \cdot 0001$ very nearly, while $\frac{D}{L} = \frac{1}{10}$; and multiplying the modulus of elasticity E (or 12,000 tons per square inch) by each of these ratios, we find that the vertical movement of the characteristic points S, T, U and V in Fig. 142, is equal to an ordinate representing a stress-intensity of

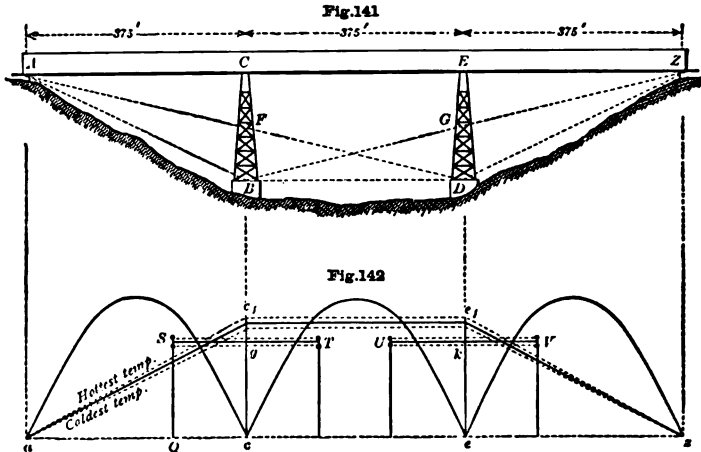

0.12 tons per square inch. The diagram is drawn as for a uniform load ; the full line ac_1e_1z represents the position of the base-line for mean temperature, and the dotted lines above and below it represent the changes due to extreme range of heat and cold. For this particular distribution of load, the greatest change of stress, produced by change of temperature, amounts to 0.288 ton per square inch, or a variation in each direction of ± 0.144 ton per square inch.

By the same method we may find the relative superelevation δ , and the altered position of the characteristic points, in any other case, by drawing a chord-line from the base of the $(n - 1)$ th to the base of the $(n + 1)$ th pier ; when $\pm \delta$ will be proportional to the height intercepted on the n th pier. If a viaduct with numerous equidistant piers crosses a valley of parabolic section, the value of δ is very small, and is the same at each pier ; but a much greater effect is produced when any one pier differs very greatly from its immediate neighbour in regard to its height from ground to summit.

106. Solution of the General Problem by Direct Geometrical Construction.—Having thus found the true position of the characteristic points for any case of irregular loading and for any irregularity in the

¹ A wrought-iron bar, when heated from 32° Fahr. to 212° , or through a range of 180° , expands by an amount which is equal to its length multiplied by 0.0012 nearly.

level of the supports, the stresses in the continuous girder will be determined by adjusting the base-line of the diagram with reference to those characteristic points in the manner described in Arts. 100 and 101. The adjustment there described may always be effected by a tentative process of trial and error; and it may here be remarked that even if the line is adjusted by the eye, so as to comply apparently with the specified conditions, the error is not likely to be greater than that which is unavoidably present in the results of the mathematical theory; for the hypothetical assumption of uniform section of flange is alone sufficient to introduce a degree of inaccuracy which is in most cases far greater than any ordinary error of graphic construction.

However, we may avoid the use of tentative methods of adjustment; for it is not very difficult to contrive geometrical processes for the direct construction of the diagram; and in some cases these methods will be very simple.

Thus, for instance, in Fig. 142, which represents the diagram for three equal spans uniformly loaded, we have to adjust the base-line so that the ordinate above each of the points T and U is equal to the ordinate below the points S and V ; and it is obvious that c_1e_1 will be a horizontal line. Therefore if we draw the lines ST and UV , intersecting the pier-verticals in g and k , we shall have $gc_1 = TT_1 = UU_1 = ke_1$; because in this example ST and UV are horizontal lines. In this example, therefore, we may effect the required adjustment at once by drawing the lines ac_1 and ze_1 , bisecting the lines Sg and kV .

In other cases the construction cannot be effected quite so simply, but various methods will suggest themselves in dealing with the diagram for any *symmetric* distribution of load. The following method is universally applicable:¹—

PROBLEM.—*In a continuous girder of uniform section, supported at any number of equal or unequal intervals by piers fixed at equal or unequal levels, to draw the diagram of stress for any regular or irregular load.*

On the straight datum-line $aceg$ in Fig. 143, construct the stress-diagram amc , cne , &c., for each span of the bridge as for a detached girder. Divide each span \overline{ac} , \overline{ce} , &c., into three equal parts, and upon the corresponding ordinates PR , QS , WT , YU , &c., set off the position of the characteristic points R , S , T , U , &c., in the manner before described; *i.e.*, if the load is uniformly distributed on any span \overline{ac} , make PR and QS each equal to $\frac{2}{3}\overline{bm}$; if the load is irregular, calculate those heights as described in Art. 102; and if the levels of the piers are irregular, correct the position of the characteristic points as described in Art. 103. Draw ST , UV , &c., joining the pair of points situated to the right and left of each pier, and intersecting the verticals cc_1 , ee_1 , &c., in the points G and K .

¹ This theorem, as well as some others contained in the present chapter, was given in a paper on "Continuous Girder Bridges" in the *Proceedings of the Institution of Civil Engineers*, vol. lxxiv.

Assuming, in the first place, that the spans are all of equal width, as in Fig. 143, the condition to be fulfilled in drawing the base-line $ac_1e_1g_1$ is that $SS_1 = TT_1$, and so on at each pier of the bridge. Divide the length cW into two parts, making $\frac{Wh}{ch} = \frac{aQ}{ac} = \frac{aQ}{ce}$, and draw the vertical hh_1 . Then starting from a , draw through G the straight line aGh_1 intersecting hh_1 in h_1 . The point h_1 will be situated in the proper base-line c_1e_1 .

Then starting again from the ascertained point h_1 proceed in the same way at the next pier; i.e. divide eZ into two parts making $\frac{Zj}{ej} = \frac{hY}{he}$, and draw the vertical jj_1 ; then through K draw the line h_1Kj_1 intersecting jj_1 in j_1 . The point j_1 will be situated in the proper base-line e_1g_1 .

Commencing also at the other end of the bridge, proceed in the same manner from each end towards the centre, thus fixing two points in the

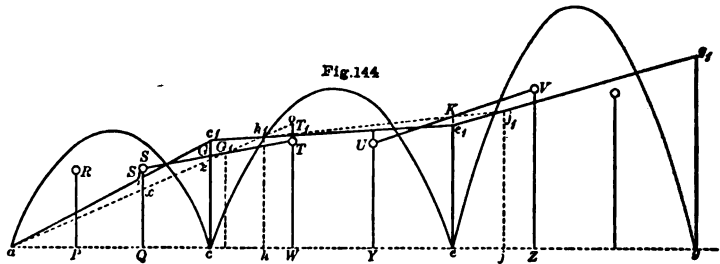
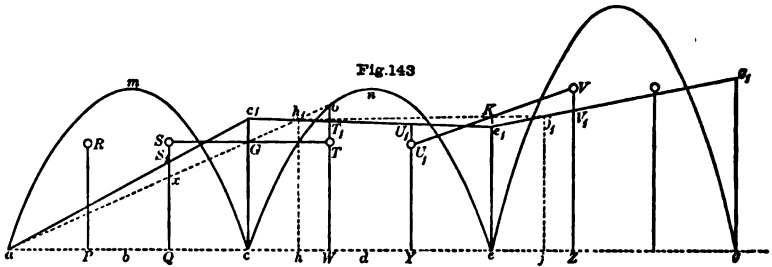

base-line of the central diagram. All the base-lines can then be completed.

Demonstration.—For let the line $\overline{aGh_1}$ be prolonged until it intersects the vertical WT (produced) at the point o ; then T_1oh_1 and c_1Gh_1 are similar triangles, and $\frac{T_1o}{c_1G} = \frac{Wh}{ch} = \frac{aQ}{ac}$.

But $\frac{S_1x}{c_1G} = \frac{aQ}{ac}$; therefore $S_1x = T_1o$.

Also the triangles ToG and SxG are similar triangles, and $To = Sx$.

Therefore $To - T_1o = Sx - S_1x$; or $TT_1 = SS_1$, which is the required adjustment.

When the span \bar{ac} is not equal to the span \bar{ce} , as illustrated in Fig. 144, join ST and UV as before, intersecting the pier verticals in G and K , and from T set off $TG_1 = SG$. Then the condition to be fulfilled is that $TT_1 \times \bar{ce} = SS_1 \times \bar{ac}$; or $TT_1 \times TG_1 = SS_1 \times SG_1$.

Divide cW into two parts, making $\frac{Wh}{ch} = \frac{aQ}{ce}$, and draw the vertical hh_1 ; then from a through the point G_1 draw the line azG_1h_1 , intersecting hh_1 in h_1 . The point h_1 will be situated in the proper base-line c_1e_1 .

The demonstration is similar to the foregoing, for—

$$\frac{T_1o}{c_1z} = \frac{Wh}{ch} = \frac{aQ}{ce}$$

$$\text{and } \frac{S_1x}{c_1z} = \frac{aQ}{ac} = \frac{T_1o}{c_1z} \times \frac{ce}{ac}$$

$$\text{also } Sx = To \times \frac{ce}{ac}$$

$$\text{therefore } SS_1 = Sx - S_1x = TT_1 \times \frac{ce}{ac}$$

which fulfils the required condition.

107. It is an unfortunate circumstance, as pointed out by M. Bressé, that while these diagrams, or the corresponding mathematical calculations, are made with the chief object of determining the necessary section of flange at different points in the girder, they are all based upon the assumption that the section of flange is going to be uniform throughout. If, after all, the flanges are made with a varying sectional area, as they usually are, the deflection curves would in consequence be modified, and the stresses would be in some degree altered. For example, we may suppose that, in a given case, the sectional area of flange is made proportional to the varying stress under a *given distribution of load*. In such a case the diagram of stress-intensity would consist of a series of rectangles above and below the base-line; and the deflection curve would form a series of alternately reversed parabolic (or circular) curves. It has been sometimes proposed to determine the stresses upon this hypothesis; but it is obvious that when the spans are unequally loaded, or when the distribution of load is in any way altered, the assumption of uniform stress-intensity would be immediately contradicted by the facts: and in most cases the assumption would probably be attended with greater inaccuracy than the hypothesis of uniform section; while the truth will generally lie between the two results obtained by these different methods.

If it is desired to attain a greater accuracy by taking into account the varying sectional area of the flanges, it must be remarked that the calculation, by whatever means it may be effected, will be extremely tedious. The geometric method described in this chapter may, however, be extended so as to embrace these conditions, and will furnish the easiest method of arriving at the desired result.¹

¹ The general outline of the method, as applied to the solution of this problem, was described by the author in a paper on "Continuous Girder Bridges," printed in the *Transactions of the Institution of Civil Engineers*, vol. lxxiv.

PART III.

THE STRENGTH OF MATERIALS.

CHAPTER X.

THE THEORETICAL STRENGTH OF COLUMNS.

108. In defining the ultimate strength of a structure, we have said that such an expression can only be understood to mean the greatest load or straining force that the structure will bear without exhibiting failure—or the load which is just sufficient to produce incipient failure; and it was remarked that, in each member, it is necessary to define what is meant by failure, as otherwise it will be impossible to specify the load that will produce it. The compression members used in the construction of a bridge may have almost any proportions between those of a tall and slender pillar and those of a flat bed-plate; and we shall therefore want some means of determining the compressive strength of struts whose proportions of height to diameter may have any varying value between those extreme limits; but the outward and visible sign of failure appears to be a different thing in the case of a tall pillar from that which is observed in the case of a cube, or in the extreme case of a thin plate or wafer.

If we take a cube of wrought iron, or one of timber or stone, we may go on loading it, until the compressive stress is sufficient to “upset” the iron, or to splinter the timber, or to crush the stone; and in the same way a cube of cast iron may be compressed until it fails by the splitting of wedge-shaped fragments from its edges.

We may take the first disintegration of these cast-iron cubes as marking their actual failure; and the load which produces this disintegration may be called the “crushing weight” of the material. But in semi-plastic materials, no such disintegration takes place, and the upsetting of a block of very ductile wrought iron or steel under compressive stress may perhaps be regarded as amounting only to a sort of cold forging, by which the cube may be reduced to a slab, or the slab to a thin plate; and if we take a thin plate of iron or any other material, there is hardly any limit to the load that it will carry; for the interior portion of the plate is prevented from

escaping by the surrounding portions and by the friction of the squeezing surfaces, and it is impossible to annihilate it.

For the same reason the most friable material, or even loose sand or water, if it is prevented from escaping laterally, will carry any load that can be placed upon it. Indeed it is probable that there can be no such thing as failure produced by a *direct* compressive force, pure and simple; because it is impossible to squeeze two ultimate particles into one, and the only way in which the idea of failure *can be conceived* in the case of a cube or slab, is by the *lateral* motion of the particles, sliding past each other and finding some lateral exit by the *shearing* of friable and crystalline materials, or by the *flow* of such plastic materials as wrought iron and steel. Therefore if there is any phenomenon that can be accepted as denoting the failure of the wrought-iron cube, it must be the first commencement of that flow, or break-down of the solid material, as shown by the bulging or upsetting of the iron.

In considering the strength of very short struts or cubes, we shall not attempt to measure the unmeasurable force that would be required to annihilate them; but we shall take as the practical measure of their strength the load that is just sufficient to produce incipient failure, either by the bulging of the wrought iron or steel, or by the splitting of the cast iron.

But if we pass from very short to very long columns, the evidence of failure will assume again a different aspect; the column will give way by bending long before it is crushed, and if the bending is carried far enough the failure of the strut will be similar to that of a beam or girder under transverse bending strain. It will first be well to consider what is the *cause* of this transverse flexure in a straight column, and what are the stresses which are thereby induced.

109. Flexure of Long Columns.—The bending of a long elastic strut may be illustrated in a very familiar way by the behaviour of an elastic walking cane under the vertical pressure of the hand. If we take a *perfectly straight* cane with a round head, and apply a gradually increasing pressure upon its top, using the sense of touch as a measure of the force applied, we find that, up to a certain point, the cane offers a solid and *sensibly unyielding* resistance to the pressure; but when it does give way it gives way all at once, and the cane may be bent double or perhaps broken, without any further *increase* of the pressure, but only by the continued application of the same pressure following up the depression of the head.

But if the cane is *not perfectly straight*, or if we apply the pressure *excentrically* upon a tee-headed stick, its behaviour will be quite different; the resistance will never have the solid unyielding character before noticed, but the deflection will begin at once; and from the first application of pressure, the resistance will be felt to be an *elastic* resistance increasing continually with the increasing deflection of the cane.

These commonplace experiences illustrate two typical cases, whose mechanical principles will have to be examined.

110. Flexure and Equilibrium of the Ideal Column.—A column

which is a perfectly straight and prismatic solid, of perfectly homogeneous material, and in which the axis coincides perfectly with the line of direct pressure, may be called an "ideal" column.

It is quite clear that, in such a column, no amount of direct strain (or equable compression of all its fibres) would produce any flexure; and that any bending *strain* must be the result of some bending *stress*; but suppose for a moment that such a column, with rounded ends, is bent to a moderate deflection under the action of a vertical load P , as shown in Fig. 145,—then the conditions which govern the equilibrium of the opposed forces may be found by the laws of elastic deflection, and thus the value of the equilibrated load P may be determined. The action of the load might in fact be replaced by the tension of a string AC uniting the ends of the bent strut; and the load P can be neither greater nor less than the tension which would be exerted upon the string by the resilient force (R) of the bow acting in the line AC .

By the graphic theorem of deflection already described in Chapter VIII., it may be shown that the force R is practically a *constant quantity* independent of the deflection within moderate limits.

Let the curve ABC represent the axis of the column (original straight); then the bending moment at any point G will be equal to the ordinate GK multiplied by the force R or by the equilibrated load P . The curve ABC may therefore be regarded as a diagram of bending moments; and the peculiar feature of the bent ideal column is that *the curve of deflection and the curve of moments must be identical*. The ordinate $BD = \delta$ is not only a measure of the deflection but also of the bending moments producing that deflection.

The geometric theorem, above referred to, shows that in any *beam* of uniform section, the curve of deflection may be constructed from the diagram of moments; that is to say, the slope of the beam will be proportional to the area of the diagram of moments, and the deflection will be proportional to the moment of that area. Therefore the curve of the bent *column* must have the following properties, viz., if a tangent FBN be drawn (parallel to AC), the inclination of the curve at any point G must be proportional to the area $BDGK$; while the deflection NG must be proportional to the moment of that area about GK as an axis. By the same rule the inclination of the tangent AT must be proportional to the area ABD , and the maximum deflection $FA = BD = \delta$ must be proportional to the moment of that area about the point A .

These equations indicate that the required curve is the "curve of sines;" but without examining its precise character it is sufficiently evident that, if the length AC is regarded as being sensibly constant, the area of the diagram, and its moment about A , will be simply proportional to the ordinate $BD = \delta$.

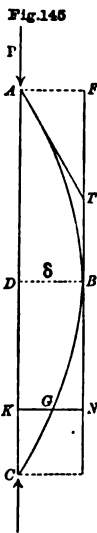

This ordinate represents, in the diagram of moments, the bending moment $R\delta$, and at the same time it represents the deflection of the strut. Therefore we have the deflection δ proportional to the bending moment $R\delta$, which shows at once that the force R is a constant quantity independent of the deflection.

111. Approximate Value of the Equilibrated Load.—It will be seen that if we try to calculate the deflection δ due to any arbitrary load P , the task will be practically impossible; but if we take the case of any given deflection, we can find the load P which would produce it, and whatever deflection we may take (within moderate limits) we shall find the same value for the load P or the resilient force R .

The value of R may be exactly measured when the exact form of the curve of moments ABD is known. If we assume that, under a moderate deflection, the curve will be nearly equivalent to a parabola, we shall have the area of the half segment ABD expressed by $G = \frac{l\delta R}{3}$, in which l denotes the length of the chord AC ; while the vertical distance from A to the centre of gravity of that figure will be $X = \frac{5}{18}l$ (as indicated in Fig. 118); and as shown in Art. 94, the deflection δ will be given by $\delta = \frac{GX}{EI}$; that is to say, in the bent column of Fig. 145 we have $FA = BD = \delta = \frac{5}{18} R\delta \frac{l^2}{EI}$

$$\text{Therefore } R = EI \cdot \frac{9 \cdot 6}{l^2} \dots \dots \dots (1)$$

This approximation does, in fact, express the value of the resilient force R , or the equilibrated load P , under any moderate deflection, with sufficient accuracy for practical purposes; but it will be noticed that there is a serious flaw in the chain of reasoning, because the parabolic curve does not comply with the conditions that must be fulfilled by the curve of the elastic column as described in the last article. Those conditions are exactly fulfilled by the curve of sines, whose figure and area differ however but slightly from those of a parabola; and when the true curve is employed, the numerator 9.6 in the above formula requires only to be replaced by $\pi^2 = 9.87$, so that the equilibrated load will be—

$$P = R = EI \frac{\pi^2}{l^2} \dots \dots \dots (2)$$

as demonstrated in the next ensuing article.

112. Curve of the Elastic Column. Exact Determination of the Equilibrated Load.—Let the curve ABC in Fig. 145 be constructed in the following manner. Divide the length of the chord $AC = l$ into any convenient number of equal parts; and suppose a semi-circular arc of the same length, and described with the radius $\kappa = \frac{l}{\pi}$, to be also divided into the same number of equal parts. Then at each point of division on the

straight line AC , set off the ordinates $BD, KG, \&c.$, proportional to the sine of the corresponding arc (or angle) in the semicircle. Thus if the length AC is divided into 180 parts, and if the central ordinate $BD = \delta$ is taken as unity, the values of the ordinates will be given by any Table of Natural Sines.

Then if a tangent FBN is drawn parallel to AC , the inclination of the curve at any point G will be proportional to the area $BDGK$, and the offset GN will be proportional to the moment of that area about GK as an axis. The truth of this proposition may be verified by any of the ordinary methods for measuring the area and moment of any diagram; and it follows that the curve thus described is the curve of deflection for any beam of uniform section, under a set of bending moments proportional at all points to the deflection from the chord AC , and is therefore the curve of the elastic column.

By accurate measurement it will be found that the area of the half segment ADB is $G = \frac{\delta l}{\pi} = \delta \kappa$, in which κ is the radius of the supposed semicircle; while the distance from A to the centre of gravity of that figure will be $X = \kappa = \frac{l}{\pi}$. Therefore by the graphic theorem of deflection

we have, as above stated, $FA = BD = \delta = \frac{GX}{EI} = \frac{R\delta^2}{EI\pi^2}$ and—

$$R = EI \cdot \frac{\pi^2}{l^2} \dots \dots \dots (2)^1$$

113. The Theoretic Deflection of the Ideal Column.—It has been

¹ The mathematical proof and measurement are as follows: Taking A as the origin of the co-ordinates x and y , the equation of the curve will be—

$$y = \delta \sin \frac{x}{\kappa} \dots \dots \dots (3)$$

Differentiating y in respect of x , the inclination of the curve at any point will be—

$$\frac{dy}{dx} = \frac{\delta}{\kappa} \cdot \cos \frac{x}{\kappa} \dots \dots \dots (4)$$

and putting $x=0$, the inclination of the tangent AT , or the fraction $\frac{AT}{FT}$ will be—

$$\frac{dy}{dx} = \frac{\delta}{\kappa} \dots \dots \dots (4a)$$

Therefore the length of the subtangent FT is equal to κ .

The integral of the general equation is—

$$\int y dx = \delta \kappa \left(1 - \cos \frac{x}{\kappa} \right) \dots \dots \dots (5)$$

and the area of the half segment ABD will be—

$$\int_0^{\frac{l}{2}} y dx = \delta \kappa = \frac{\delta l}{\pi} \dots \dots \dots (5a)$$

while the moment of that area about A is—

$$\int_0^{\frac{l}{2}} xy dx = \delta \kappa^2 = \delta \frac{l^2}{\pi^2} \dots \dots \dots (6)$$

shown that the bent column will exert a certain resilient force R , as measured and applied in the line AC , and that this force has practically one and the same value whether the deflection be great or small; its value for all moderate deflections being $R = EI \frac{\pi^2}{l^2}$. Therefore if we take a straight column with rounded or pointed ends, and apply an arbitrary and gradually increasing load P , we may expect the bar to exhibit a certain series of symptoms as hereafter described; and the author would recommend every student to make this experiment for himself, which he may do at the cost of a few shillings by means of such simple apparatus as that illustrated in Fig. 146.

Suppose then that we have a thin bar of untempered steel or wrought iron, which can easily be straightened and re-straightened until we succeed

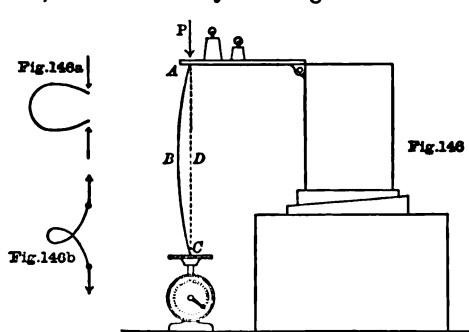

in producing a bar through which the line of pressure passes exactly along its axis. Then placing the foot of the strut upon an ordinary spring balance, we may conveniently apply the load by means of a hinged lever or flap, on which weights can be placed, and which will serve to guide the head

of the strut in its descent. As the head descends we can easily adjust the lever in a nearly horizontal position; but in any case, as the pointed ends of the strut are perfectly free to turn upon the metal plates on

Therefore the vertical distance from A to the centre of gravity of that area is $X = \kappa$. The area of the half segment ABD is therefore equal to the inclination at A multiplied by a certain constant quantity κ^2 ; and the moment of that area about A is equal to the offset PT multiplied by the same constant.

To show that the same law applies equally at every point in the curve, the point D may be taken as the origin, and the equation of the curve will then be changed to

$$y = \delta \cos. \frac{x}{\kappa}$$

The area of the figure $BDGK$ will then be expressed by $\int_0^x y dx = \delta \kappa \sin. \frac{x}{\kappa}$ which is equal to the inclination at G multiplied by the same constant κ^2 ; while the distance x_0 to the centre of gravity of the figure will be—

$$\frac{\int_0^x xy dx}{\int_0^x y dx} = x - \kappa \cdot \frac{1 - \cos. \frac{x}{\kappa}}{\sin. \frac{x}{\kappa}}$$

Therefore multiplying the area of the figure by the arm $x - x_0$, its moment about KG as an axis will be $\delta \kappa^2 \left(1 - \cos. \frac{x}{\kappa}\right)$, and will therefore be equal to the offset GN multiplied by the same constant κ^2 .

which they bear, the pressure must necessarily act along the line AC , and its value will be read off upon the spring balance; while the deflection may be measured with sufficient accuracy for this purpose by a straight-edge and a finely divided scale.

Now if we have succeeded in producing an ideal column it will behave as follows:—1st, So long as the load P is less than a certain quantity (R), there will be no deflection of the column whatever. We can easily produce such a deflection if we apply a certain *lateral* pressure to the middle of the loaded column; but the moment we remove that pressure the bow will straighten itself and will lift the incumbent load by reason of the excess of R over P .

Also it will be found that as we increase the load P , the smaller will be the amount of lateral pressure required to produce any given deflection.

2nd, If the load P is now increased until it is exactly equal to R , the behaviour of the column will be different—the load itself will not produce any deflection, but the smallest conceivable force applied to the middle of the strut will be sufficient to bend it to any required extent, no matter what may be its stiffness; and if the column is so bent, it will not now recover itself as heretofore, neither will it yield any further, but will remain supporting the load in any bent position in which it may be placed (within moderate limits). In fact the column will be in a condition of indifferent equilibrium, and will carry the load just as well when it is bent, as when it is nearly or perfectly straight.

It will be observed, however, that if the deflection is pushed beyond the elastic limit, the bar will pass into a condition of *unstable* equilibrium, and will then give way and let the load down.

3rd, If the load P is made greater than R by the smallest amount, the column will be placed in a condition of unstable equilibrium from the first, and it will either be bent double or broken; and therefore the resilient force R is the measure of the breaking load.

We may here remark that in a column of any given section, the resilient force R is directly proportional to the modulus of elasticity, but is totally independent of the ultimate strength of the material. Thus a long (ideal) column of the strongest steel would be little or no stronger than a similar column of wrought iron, because the modulus of elasticity is nearly the same in both materials; and however great the ultimate resistance of the steel may be, the crushing stress will inevitably be reached at some period of the increasing bending strain, if only the load is sufficient to overcome the resilient force of the bow, and to set up the ever-increasing deflection. The only difference that may be theoretically expected is that the steel column would take a greater ultimate deflection than the wrought-iron column, before it became actually crushed or crippled on the concave side; but the breaking weight would be nearly the same for both. Indeed, when the ever-increasing deflection has once been set up, the column may be considered as having failed for all practical

purposes, no matter what may afterwards happen to it during the course of that buckling process.

It may also be well to notice here a theoretical objection which may perhaps be urged, but which would only tend to obscure the real issues. By the employment of elliptical functions it may, perhaps, be shown that a *perfectly elastic* strut, such as a watch spring or a sword blade of Toledo steel, would recover its stable equilibrium after the deflection had proceeded beyond a certain limit, as sketched in Figs. 146A and 146B, so that a force somewhat greater than R would be necessary if we wanted to bend it into a loop or tie it in a sort of knot. But these theoretical investigations have no interest for us; for a column which is bent into such a shape cannot be said to have resisted failure in the ordinary sense of the word; moreover, the columns used in bridge construction are *not* perfectly elastic watch springs, and when their deflection passes the elastic limit, what happens to them is that they pass from a condition of indifferent equilibrium into a condition of *unstable* and not of *stable* equilibrium. This transition is a very gradual one in the case of a long slender column, so that for a very considerable extent of deflection the force R is sensibly constant; and in all practical cases it must be considered as denoting the *greatest* weight that the ideal column will carry.

114. Theoretic Strength of the Ideal Column.—It will be convenient to represent the breaking weight of columns of different proportions by a diagram such as Fig. 147, in which the ordinates give the

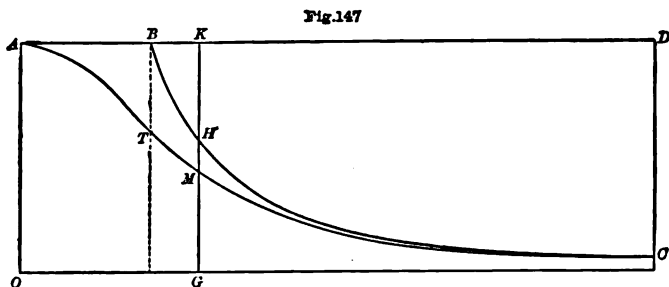

breaking weight in pounds per square inch of sectional area; while the abscissæ may represent the ratio of length to diameter, or preferably the ratio of length to “radius of gyration.”

The moment of inertia I is equal to the sectional area of the beam or column multiplied by the square of the radius of gyration (r^2). Therefore, dividing the force R by the sectional area A in square inches, we have the resilient force in pounds per square inch of the column's section expressed by—

$$p = \frac{R}{A} = \pi^2 E \frac{r^2}{l^2} \dots \dots \dots (7)$$

And this will denote the theoretic breaking weight of long columns in

pounds per square inch, or the load which is sufficient to overcome the resilience of the bow and to produce indefinite deflection.

In Fig. 147 the abscissæ OG , &c., represent the ratio $\frac{l}{r}$; and the breaking weight ρ in pounds per square inch is represented by the corresponding ordinates GH , &c., measured to the curve BHC . The curve shows that the load required to bend the ideal column is very small at the right end of the diagram, but increases very rapidly as the ratio $\frac{l}{r}$ is re-

duced; and if the curve were continued beyond B it would run up nearly parallel to the asymptote OA , indicating that it would require a nearly infinite load to bend a very short column. But bending is not the *only* kind of failure that we have to provide against; for if the compressive stress exceeds a certain intensity, the strut will be crushed, or the material will be practically broken down, as evidenced in wrought iron by the bulging or upsetting of the iron. Therefore if OA or GK represents the ultimate compressive strength of the material, as marked by these appearances of incipient failure, the horizontal line AKD will indicate this *alternative* limit to the strength of the strut; and the line $ABHC$ will denote the greatest load that can be placed upon the column without inducing failure of *either kind*.¹

If we assume that a column which has begun to bend will be fractured or crippled as soon as the maximum compressive stress on the concave side is equal to the crushing stress GK ; then GH will represent the stress-intensity due to the load, and HK the additional stress due to the bending-moment. But it is not necessary here to substantiate this assumption, for, as before remarked, we do not care what happens to the strut after it has practically failed by buckling to an indefinite extent; and the load that produces *this* failure is indicated by the ordinate GH .

115. The Practical Deflection of Columns.—It is evident that the compressive stress on the concave side of a bent column must depend upon its deflection, and that this must govern its ultimate strength; but according to the propositions above stated there is no assignable value for the elastic deflection of a column under any given load. If the load P is less than R there is *no* deflection, and if the load is equal to or greater than R the deflection has practically no limits. But these propositions will only hold good so long as the conditions are precisely those which are assumed in the Ideal Column; and it may be shown that a very small variation in those conditions will entirely alter the law of its deflection, and greatly modify the strength of the column.

As a simple illustration, let it be supposed that the neutral axis of the unstrained column is not exactly a straight line, but slightly curved, as shown by the dotted line AKC in Fig. 148. Such a curvature may

¹ Of course the lines AB and BC are governed by two different phenomena, and it is not surprising that the diagram is not a continuous curve.

either be regarded as an initial deflection or as permanent set, which may have been developed unseen during the course of an experiment, and which would entail the same consequences as though it had shown itself from the beginning. It may be assumed that the curve of permanent set *AKC*, like the curve *ABC*, will have nearly the character of a curve of sines.

Then the *elastic* deflection of the strut at any point will be represented by the space between the two curves, *BK* being the maximum elastic deflection; but the diagram of moments will be the whole segmental area *ABCD*. These two figures will therefore be no longer identical, as they were in the ideal column; but applying the same geometrical theorem, the elastic deflection *BK* must be proportional to the moment of the half segmental area *ABD*; and the equilibrated load *P* will be less than the value *R*, as previously determined, in the proportion of *BK* to *BD*.

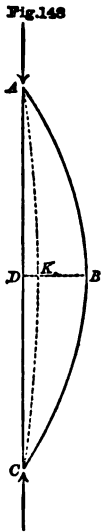

Let *R* denote, as before, the resilient force of the *ideal column*, equal to $EI \frac{\pi^2}{l^2}$, and let Δ denote the initial deflection *DK*, and δ the elastic deflection *BK*—

$$\text{Then } P = R \frac{\delta}{\Delta + \delta} \dots \dots \dots (8)$$

$$\text{and } \delta = \Delta \cdot \frac{P}{R - P} \dots \dots \dots (9)$$

Therefore the deflection will now have a certain assignable value depending on the load *P*; and *if the load is gradually increased the column will exhibit an increasing deflection*, or, in other words, it will always be in a condition of stable equilibrium; and looking at formula (9) it is evident that when the load *P* is increased to within a little of the fixed quantity *R*, the factor $\frac{P}{R - P}$ will be a very large multiple, and a very small initial curvature (Δ) will then be sufficient to produce a comparatively large deflection of the column.¹

It may be admitted that with careful workmanship columns and struts can be made, and are made, without *any* perceptible curvature or initial deflection; and therefore, although the above example may correctly represent something that takes place *after* a permanent set has been produced, yet it does not explain how a straight column can be bent at all with any load less than the theoretic ultimate strength *R*. But it may be shown that without any initial curvature, the deflection will follow a precisely similar law if the material is not perfectly homogeneous in its elasticity. Experiment has shown that test pieces, even when cut

¹ It will of course be evident that this formula ceases to be applicable when the deflection reaches the magnitude shown in Fig. 146A; but such cases are entirely outside the limits of our inquiry for reasons before stated.

from different parts of the same bar, will often exhibit very considerable differences in the modulus of elasticity; and if the modulus is a little greater on one side of the column than on the other side, the effect will be the same as though the column had an initial curvature.

The effect of such a variation of modulus is most easily seen and measured in the case of a strut consisting of two flanges or legs braced together as a girder, as shown in Fig. 149. The flanges will be of equal sectional area, and the radius of gyration r will be equal to half the depth of the girder.¹ Let the specific compressibility of the inner flange, or its unit strain per ton of stress-intensity, be denoted by $e_1 = \frac{1}{E_1}$; and in the same way let e_2 denote the specific compression of the outer flange, or $\frac{1}{E_2}$; while e may be used as denoting the average compression or $\frac{e_1 + e_2}{2}$.

Now if the two flanges were subjected to the same compressive strain (*i.e.*, shortened by the same amount), their resistances would be as E_1 to E_2 , and the *resultant line* of elastic resistance would then be moved away from the axis of the strut by the excentricity $s = r \frac{e_1 - e_2}{e_1 + e_2}$, so that the line of resistance would not coincide with the direct line of pressure of the load. On the other hand, if the two flanges were subjected to the same compressive *stress*, one would be shortened more than the other in the proportion of e_1 to e_2 ; and this could only take place by a curvature of the girder, such as AKC in Fig. 148. In fact if such a girder were bent under its load to the actual curve ABC , we should have to divide the deflection BD into two parts—first, the portion DK , producing no difference of stress in the two flanges, and therefore no “moment of resistance;” and secondly, the portion KB which would be a measure of the real moment of resistance, and would represent the elastic deflection which evokes that moment of resistance.

If this illustration is not quite clear, the matter may be examined in detail by a direct construction of the deflection curve, on the principles already described in Chapter VIII; and bearing in mind the different values of the modulus in the two flanges it will be found that the maximum deflection is expressed by—

Fig. 149



¹ In the case of a column of any other symmetric section, we may suppose these flanges to represent the effective flanges of the section, or the area of metal on each side of the neutral axis concentrated at a distance equal to the radius of gyration r ; and the deflection will then follow the same rule as in the girder-shaped strut of Fig. 149. In the case of a rectangular section, like that shown in Fig. 21, the radius of gyration is the same thing as the distance Nr .

$$\delta = \frac{\pi r}{2} \cdot \frac{e_1 - e_2}{e_1 + e_2} \cdot \frac{P}{R - P} = \frac{\pi}{2} \cdot \frac{P}{R - P} \dots \dots (10)^1$$

It appears then that if we take account of these minute irregularities of form or of material, the deflection of a column under any variable load will be expressed by $\delta = c \cdot \frac{P}{R - P}$; in which c denotes some constant representing either initial deflection or permanent set, and if neither of these is present, then representing a certain irregularity in the modulus of elasticity. The presence of a small initial curvature is sufficient to

¹ This may be shown algebraically as follows:—

The greatest bending moment being $M_0 = P\delta$, the maximum intensity of stress due to this moment, in a column of any section will be $\pm f_1 = \frac{M_0 y}{I} = \frac{M_0 y}{Ar^2}$

In the case of the braced strut of Fig. 149, the distance y of the extreme fibre from the neutral axis is equal to r ; and dividing P by the sectional area A , we may use $p = \frac{P}{A}$ as denoting the direct load in pounds per square inch; and we then have

$\pm f_1 = \frac{p\delta}{r}$ for the maximum intensity of stress due to bending moment; while the average value throughout the length of either flange will be $\pm \frac{2}{\pi} \cdot \frac{p\delta}{r}$. Therefore the average intensity of compressive stress on the inner flange is $p \left(1 + \frac{2}{\pi} \cdot \frac{\delta}{r} \right)$, and on the outer flange $p \left(1 - \frac{2}{\pi} \cdot \frac{\delta}{r} \right)$.

Then measuring, in each flange, the area of the diagram of stress-intensity for the length AB , we shall have the total extension of outer flange plus total compression of inner flange, or the excess of length of the one over the other, expressed by—

$$\frac{pl}{2} \left(e_1 - e_2 + (e_1 + e_2) \frac{2}{\pi} \frac{\delta}{r} \right) = \frac{pl}{2} \left(e_1 - e_2 + e \frac{4\delta}{\pi r} \right).$$

The inclination at A , or the slope $\frac{AF}{FT}$ in Fig. 145, will be found by dividing this excess of length by the whole depth of the girder or $2r$; therefore the slope will be $\frac{pl}{4r} \left(\frac{4e\delta}{\pi r} + e_1 - e_2 \right)$; and multiplying by the length of subtangent FT or κ , the elastic deflection, as depending on the relative compressions of the flanges, will be—

$$\begin{aligned} \text{Deflection } FA &= \delta = \frac{pl\kappa}{4r} \left(\frac{4e\delta}{\pi r} + e_1 - e_2 \right) \\ &= \frac{p\delta e\kappa^2}{r^2} + \frac{pl\kappa}{4r} (e_1 - e_2). \end{aligned}$$

Then using ρ as before to denote the resilient force of the ideal column in pounds per square inch, or $\rho = \pi^2 E \frac{r^2}{l^2} = \frac{r^2}{e\kappa^2}$, we may write the above expression—

$$\begin{aligned} \delta &= \frac{p\delta}{\rho} + \frac{pl\kappa}{4r} (e_1 - e_2). \\ &= \frac{\rho}{\rho - p} \cdot \frac{pl\kappa}{4r} (e_1 - e_2). \end{aligned}$$

$$\text{or } \delta = \frac{\pi r}{2} \cdot \frac{e_1 - e_2}{e_1 + e_2} \cdot \frac{p}{\rho - p} \dots \dots (\text{Q. E. D.})$$

produce a serious deflection, because it tends to multiply itself by setting in action a bending moment which increases the deflection, which again increases the bending moment, and so on and so on; but the ultimate limit of this process is measured by the formula, and depends upon the value of P as compared with the quantity R ; while it has also been shown that a precisely similar effect is produced by a variation in the modulus of elasticity.

In Fig. 150, the load P , and the resulting deflection δ as found by this formula, are plotted as co-ordinates of the curve OD ; and looking at this curve, we see in what manner the column ought theoretically to behave under a gradually increasing load P . The deflection ought to commence almost with the first application of the load, but ought to be very small at first and to increase very rapidly as the load increases. If the reader has ever looked into the tables of recorded deflection which accompany

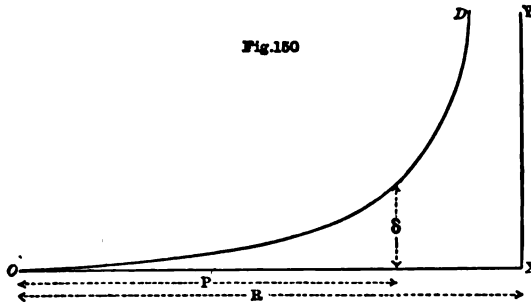

the published results of experiments, he will recognise at once that this is exactly the way in which columns *usually* behave; and if he has himself made the experiment recommended in Art. 113, he will have discovered that in nine cases out of ten, the bar will refuse to behave in the ideal manner there described, and will deflect in the manner here illustrated; indeed, the condition of indifferent equilibrium can only be produced by the greatest care in the first adjustment of the bar.

In comparing the curve OD with the results of experiment, it will of course be remembered that the vertical scale depends upon the value of the constant c ; and in different bars it is reasonable to expect that this constant will have different values.

In the ideal column $c = 0$, and the diagram will then consist of the two straight lines OX and XY ; but such a case is hardly ever recorded, and can only be produced by great care in conforming to the conditions of the ideal column. In practice it is found that, even when the bar is apparently quite straight and accurately centred, it will deflect in the manner shown in this diagram; and in such a case it is certain that this must be due to *unequal elasticity* producing an excentricity of reaction of the elastic resistance. If we could find by repeated trials the exact position of the centre of elastic resistance in any particular strut, and apply the load in the same excentric position, we might be able to produce the

ideal conditions, and should thereby greatly increase the strength of the column. This has been done by Mr. James Christie in some experiments that have been recently conducted in America, but is not practicable in the ordinary course of bridge-construction.

116. The Practical Strength of Columns.—The strength of a strut must depend upon the *greatest* stress that takes effect at any point of the strut under a given load; and therefore the stress due to bending strain must be taken into account. In a round-ended column, the greatest bending moment will be $M_0 = P\delta$; and in a column of any section the extreme stress due to that moment will be $\pm f_1 = \frac{P\delta y}{Ar^2} = \frac{p\delta y}{r^2}$

Therefore inserting the ascertained value of the deflection δ , as resulting from any given variation of modulus, we have from equation (10)—

$$\pm f_1 = \frac{\pi}{2} \cdot \frac{y}{r} \cdot \frac{e_2 - e_1}{e_1 + e_2} \cdot \frac{p^2}{\rho - p}$$

Or using ϕ to denote the quantity $\frac{\pi}{2} \cdot \frac{y}{r} \cdot \frac{e_1 - e_2}{e_1 + e_2}$, the extreme stress due to bending moment may be expressed by $\pm f_1 = \frac{\phi p^2}{\rho - p}$; and therefore the total compressive stress on the concave side in pounds per square inch will be—

$$f = p + f_1 = p \left(1 + \frac{\phi p}{\rho - p} \right) \dots \dots \dots (11)$$

This formula expresses the relation between the apparent stress p due to the load, and the greatest actual stress f on the concave side; and if we wish to find the load p that would produce any given stress f , we must solve the implied quadratic equation, and we then have—

$$p = \frac{\rho + f - \sqrt{(\rho + f)^2 - 4f\rho(1 - \phi)}}{2(1 - \phi)} \dots \dots \dots (12)$$

Therefore if there exists any quantity which can be called the ultimate compressive strength of the given material, we have only to insert that value of f in the above formula in order to find the breaking load p .

According to this formula the breaking load of columns of different proportions will be represented by a wave-line curve, such as the curve ATC in Fig. 147, in which the several ordinates GM , &c., denote the load or apparent stress p which produces the constant ultimate stress represented by the horizontal line AKD . At A the curve touches that line, while at C it approaches indefinitely near to the curve of the ideal column; but with intermediate proportions of column, the curve shows a marked reduction in the theoretic strength as calculated for the ideal column, the reduction being greatest at the point B in the diagram, where—

$$f = \rho, \text{ and where } p = f \frac{1 - \sqrt{\phi}}{1 - \phi} \dots \dots \dots (12A)$$

The form of the curve, between A and C , will depend on the value

that may be taken for ϕ , for the assumed variation of modulus. In the figure we may understand the curve to be constructed on the assumption that the variation between the elasticity of the two flanges is equal to the *greatest* difference that is commonly observed in the modulus of the given material. If the inequality in any particular bars should be less than this, the curve *ATC* will approach nearer to the curve of the ideal column, and will coincide with the line *ABC* if ϕ is taken as nothing. It will be seen, therefore, that the strength of columns *cannot be defined by any hard and fast line*, even when the average elasticity of the column and the ultimate strength of the material are accurately known; but, on the contrary, the strength may have any value less than that of the ideal column *within certain limits*. The strength of columns must therefore be represented by *an area*, as in Fig. 147, within which the results of individual experiments may be expected to place themselves at haphazard. The upper limit will be the line of the ideal column *ABC*, and it remains to determine for each material the position of the lower limit *ATC*, which must be regarded as the greatest *reliable* strength of the column in practice.

117. Observed Variations in the Elasticity of Iron and Steel.—In constructing a strut of two separate and distinct flanges, or in constructing a pier of four separate legs braced together, it is obvious that we must have regard to the greatest variation of elasticity that is likely to take place as between *separate specimens* of the same material. Thus in wrought iron the average modulus of elasticity is about 26,000,000 lbs. per square inch; but the modulus is known to vary *commonly* between 23,000,000 and 29,000,000, while occasionally the range is even greater. The variation here mentioned is not one which takes place merely between different kinds of iron, but is often observed to take place in different specimens of the same brand. Adopting these figures, therefore, the fraction $\frac{e_1 - e_2}{e_1 + e_2}$ will have the value 0.117; so that the greatest probable excentricity of reaction will be about $\frac{1}{8}$ th of the radius of gyration. In cast iron also the fraction is found to have very nearly the same value.

But if the strut is composed of a single continuous bar or solid forging, it may perhaps be supposed that the elasticity would be nearly uniform. This idea, however, appears to be contradicted by experiment. For example, a short piece was cut from the steel shaft of a big steamer, and the block having been cut up into a number of longitudinal strips, each strip was separately tested by Mr. Kircaldy for elasticity as well as for ultimate strength. The shaft had been manufactured by Messrs. Krupp of Essen, and in recording these experiments Mr. Baker remarks that "a more severe test of the quality and uniformity of the steel could not have been devised, and the admirable manner in which the several stresses were sustained could not have been surpassed." Yet sixteen of these strips, when tested under the same direct stress, exhibited an elastic strain which varied anywhere between .032 and .047; while six others which

were tested under the same transverse bending stress exhibited a deflection varying anywhere between .038 and .049. This shows that the modulus of elasticity in different parts of this block of apparently homogeneous material, must have varied within wider limits than we have taken above; but having regard to a great number of other experiments it appears that the general range of variation forms nearly the same percentage of the average elasticity in steel as it does in wrought and cast iron; and if we decide to neglect the contingency of initial curvature or other faults of workmanship, we must at least provide for this variation of modulus in each of the materials named.

Therefore in all cases we shall adopt the value 0.117 for the fraction $\frac{e_1 - e_2}{e_1 + e_2}$. But we must consider how this variation will apply to columns of different cross-sections. The value of ϕ in formula (11) appears to depend upon the ratio $\frac{y}{r}$, which varies in different forms of cross-section according as the material is mostly concentrated at the edges or at the centre of the section. Its highest value occurs in tees, angles, and bars of cruciform section; and in the case of the angles and tees which formed the subject of Mr. Christie's experiments, the average value was $\frac{y}{r} = 2.2$, so that in this case we have $\phi = 0.117 \frac{\pi}{2} \times \frac{y}{r} = 0.4$ nearly. On the other hand, its lowest value will occur in the case of a very thin hollow cylinder in which $\frac{y}{r}$ is theoretically equal to 1.42, although in the practical case of a Phoenix column it will seldom be less than 1.6; and in this case ϕ would have the minimum value of 0.3 nearly.

It will be observed, however, that if the strut consists of a continuous solid, and not of separate legs or flanges, the distribution of elasticity as among the different fibres may take place in a thousand different ways, and all that can be done is to provide against the *worst* case that is likely to occur. In the case of the steel shaft above mentioned, it so happened that the hardest group of fibres was situated nearly in the centre; and the excentricity of elastic resistance (*) was therefore very small; but it might have been very great if a column had been shaped out of this shaft so as to contain the group of hard fibres near one of its edges.

In calculating the deflection of a solid column, we have virtually supposed that, in all sections, the greatest excentricity to be provided for is some constant fraction of the radius of gyration r ; but in the nature of things we can have no certain information on this point; and therefore in seeking to estimate the *lowest probable limit* for the strength of columns, we shall take the *maximum* value of ϕ , namely 0.4, for all forms of cross-section.¹

¹ It may here be remarked that whatever value we may assume for ϕ between the extreme limits 0.4 and 0.3, the calculated strength will not vary by more than 5 per

118. **Wrought-Iron Columns.**—We can now, with very little trouble, apply the foregoing principles to columns of wrought iron, cast iron, or steel; and having traced the two curves which theoretically represent the maximum and the minimum strength of the column, we can see how the results of actual experiment will place themselves upon the diagram.

The theoretic curves, and the results of a great number of experiments in each material, are represented upon Plate F in Figs. 151 to 156 inclusive.

In each diagram the ordinates of the curve *BC* represent the values of Max. $p = \rho = \pi^2 E \frac{r^2}{l^2}$, or the load producing indefinite flexure in the ideal column; while the horizontal line *AB* represents the alternative value Max. $p = f$, or the load producing the alternative failure of the strut by crushing, or incipient disintegration or upsetting of the material; and in each diagram the wave-line curve *AC* represents the load that would produce the same stress f on the concave side of the bent column, if its elasticity is subject to irregularities as great as, but not greater than, those commonly observed in practice.

Taking formula (12) and inserting $\phi = 0.4$ as found in the last Article, the ordinates of the curve *AC* in each diagram will be given by—

$$\text{Minimum } p = \frac{f + \rho - \sqrt{(f + \rho)^2 - 2.4f\rho}}{1.2} \dots (13)$$

In wrought iron, the modulus of elasticity, in the general average of cases, has a value of $E = 26,000,000$ lbs.; and therefore the *greatest* breaking weight, in a column of uniform elasticity E , will be

$$\rho = 26,000,000 \pi^2 \times \left(\frac{r}{l}\right)^2, \text{ as shown by the curve } BC.$$

The ultimate compressive stress f , which causes the failure of short blocks of wrought iron by bulging or upsetting, is not very accurately defined by experiment, partly because the visible sign of failure is not so marked as in the crushing of cast iron; but the stress is commonly estimated at 36,000 to 50,000 lbs. per square inch; and Fig. 152 includes at the left end of the diagram some of the experiments by which this estimate is justified.

In order to determine the *lower limit* we must consistently take the lower value of f , and the curve *AC* is accordingly traced for $f = 36,000$ lbs. Then, if this value of f represented the ultimate strength of *all*

cent. in any case. In fact if the above values of ϕ are successively inserted in formula (12A) it will be seen that in one case the theoretic strength is equal to 65, and in the other 69 per cent. of the maximum strength of an ideal column; and the difference would be still less if the column had any stouter or more slender proportions.

specimens, the breaking weight of all columns ought to be included in the area ABC ; and the position of any individual experiment in this area would depend upon the particular excentricity of elastic reaction in each bar. But as the ultimate strength of the material in different specimens varies between 36,000 and 50,000 lbs., the strength of all columns (except in abnormal cases) will be included in the area A_1B_1CA . For it will be observed that however great may be the ultimate compressive strength of some specimens, the upper limit or curve B_1BC will not be raised or affected in any way; and the only addition to be made to the diagram in order to include specimens of such higher strength, is the area A_1B_1BA . The fact that a few exceptional cases lie slightly above the curve BC (as shown in the diagram) cannot possibly be explained by any superiority of ultimate strength; but is easily explained by the fact that the average modulus for the whole bar is often slightly greater than the value here taken for E .

The constellation of experiments shown in the diagrams comprises the principal results of the tests which have been recorded by different observers. The several bars and columns included in the diagram are of different forms of cross-section as shown in the tables of reference, and their dimensions vary within extremely wide limits, from rods half an inch in diameter buckling with a load of one or two cwts., up to full-sized bridge columns 12 inches in diameter, and 20 or 30 feet long, breaking with a load of 300 tons or upwards.¹

In every case the ratio $\frac{l}{r}$ is measured by the horizontal distance from the edge of the diagram, while the vertical height denotes the recorded breaking weight in lbs. per square inch.

119. Columns with Fixed Ends.—When the ends of the column are not free to turn, as we have hitherto assumed, but are held rigidly in one direction, it is generally considered that the deflection of the column will take place in a manner similar to that of a beam fixed at each end, and having two points of contrary flexure as shown in Fig. 157, in which A and C are the two points of contrary flexure. In this case the length AC would be situated under precisely the same conditions as a strut

¹ It would serve no useful purpose to repeat here *in extenso* the details of these numerous experiments. Mr. Hodgkinson's experiments are well known to most readers, while the details of the Pencoyd and Watertown tests may be examined by reference to the paper of Mr. James Christie entitled "Experiments on the Strength of Wrought-Iron Struts," and published in the *Transactions of the American Society of Civil Engineers*, 1884.

The T and L bars tested in the Pencoyd experiments varied in dimensions from $1" \times 1" \times \frac{1}{4}"$ to $4" \times 4" \times \frac{1}{4}"$, while the beams and channel sections tested at Watertown were from 4 inches to 12 inches in width.

The valuable series of experiments made by order of the Cincinnati Railway Company to test the materials proposed for the Ohio Bridge, are recorded in Mr. T. C. Clarke's paper "On Iron Bridges of very Large Span" (*Proceedings of the Institute of Civil Engineers*, 1877-78), and were made with full-sized struts varying from 8 inches to 12 inches in diameter.

with rounded ends, whose central deflection and bending moment are measured by the ordinate BD , while FK would represent the reverse deflection and the reverse bending moment taking effect at each of the fixed ends.

The diagram of positive and negative moments would therefore be not exactly the same as in a continuous beam, but in each half of the column would consist of the two segmental areas AFK and ABD .

Following the graphic method of describing the deflection curve, it is evident that in a beam of uniform section and *uniform elasticity*, these two areas must be equal, because the slope of the deflection curve at A is common to both curves; and therefore AD will be equal to AK , so that if L denotes the total length of the strut, the length of the equivalent round-ended strut AC will be $l = \frac{L}{2}$.

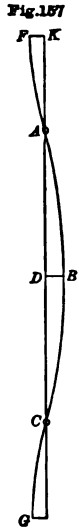

But in practice there are several circumstances which modify this deduction.

1. In a girder-shaped strut, if the relative compressibility of the two flanges is as e_1 to e_2 , the area AFK must be greater or less than the area ABD by a certain constant quantity.

2. If the average elasticity of the length AB is greater than that of the length AF in the proportion of E_1 to E_2 , the areas AFK and ABD must also be in the proportion of E_1 to E_2 .

3. The ordinate FK represents the bending moment acting upon the bar, and it represents also the *turning* moment which acts upon the body in which the bar is fixed. This body, whether it represents the jaws of a testing machine, or the flange of a girder, is not absolutely inflexible, and if any angular motion of the strut at the point F is thus permitted, the length AC will be greater than half the length of the column.

It would be difficult to calculate the probable extent of these several contingencies; but for practical purposes we may approximately cover them by taking the length l as greater than $\frac{L}{2}$ in some fixed ratio; and it would appear that in the majority of experimental cases a limiting value of $l = \frac{6}{10} L$ may be taken as giving the length of the equivalent round-ended column. The curves BC and AC in diagrams 152 and 154 are constructed on this assumption, and the reader can judge for himself how far they coincide with the upper and lower limits of strength as shown by the results of actual experiment.¹

120. Cast-Iron Columns.—The average elasticity of cast iron may be

¹ In regard to this point it may be observed that if experiments are made under *precisely the same conditions* as those which occur in bridge-construction, their results are the best and most reliable guides that we can possibly have; but, on the other hand, these results are known to depend pretty largely upon minute changes in the conditions

taken as $E = 14,000,000$ lbs., and therefore the breaking weight of the ideal column of uniform elasticity will be $\rho = 14,000,000 \pi^2 \times \left(\frac{r}{l}\right)^2$; and the limiting curves BC in Figs. 153 and 154 are constructed to represent this value.

The crushing stress f in short struts is a quantity which can be defined with tolerable accuracy, because the crushing is a well-marked and easily observed phenomenon; but in different specimens it exhibits a considerable difference of value, depending in great measure upon the kind of iron or mixture employed.

Table 1 contains the mean results of a number of experiments made by Mr. Hodgkinson upon solid cylinders $\frac{3}{4}$ inch in diameter. In each case tests were made with cylinders of one diameter and two diameters in height; but the effect of this difference of height was inconsiderable, and in some cases the higher cylinder was the stronger of the two.

TABLE 1.—Crushing Strength of Cast Iron.

Description of Iron.	Lbs. per Square Inch.
Low Moor iron, No. 1	60,489
" " No. 2	95,928
Clyde iron, No. 1	90,805
" No. 2	106,011
" No. 3	106,039
Blaenavon iron, No. 1	85,710
" " No. 2	110,000
" " No. 2	68,545
Calder iron, No. 1	74,088
Coltness iron, No. 3	101,000
Brymbo iron, No. 1	75,246
" " No. 3	76,545
Bowling iron, No. 2	75,058
Ystalifera Anthracite iron, No. 2	97,742
Yniscedwin Anthracite iron, No. 1	81,084
" " " No. 2	76,246

According to these experiments the average crushing strength of simple cast irons is about 86,300 lbs. or $38\frac{1}{2}$ tons per square inch; but in good mixtures it will be generally somewhat higher, and will average 42 tons, occasionally reaching 50 tons.

For practical purposes however we may take 80,000 lbs. as the lower limit for good ordinary cast iron, although we must then expect a few experiments to place themselves slightly below the curves AC , which of the experiment; and as it is certain that the actual conditions of a strut in any proposed bridge will be liable to such variations, theory may usefully be employed if only to indicate the direction in which such variations would tend to take effect.

in Figs. 153 and 154 represent the breaking load p , or the load producing a compressive stress of 80,000 lbs., on the concave side of the column.

But it must be remembered that the convex side of the column will sometimes suffer a *tensile* stress, and cast iron is so much weaker in tension than in compression, that columns of this material will sometimes give way by tension on the convex side.

The stress on the extreme fibre is given by $f = p \left(1 - \frac{\phi p}{\rho - p} \right)$, and will be either compression or tension according as this expression may have a positive or a negative value. Then putting f_1 = the ultimate tensile strength, it will follow that the apparent compressive stress or load p which is capable of destroying the column by tension will be—

$$p_1 = \frac{\rho - f_1 + \sqrt{(\rho - f_1)^2 + 4f_1\rho(1 + \phi)}}{2(1 + \phi)} \quad \quad (14)$$

The direct tensile strength of cast iron may be taken on the average at 14,000 lbs. as a safe limit, and the resulting values of the breaking load are described by the lower curve in Figs. 153 and 154, marked "failure by tension."

The results of Mr. Hodgkinson's experiments with solid and hollow cylindrical columns of cast iron are given in the diagrams, and appear to coincide with the theoretic limits at all proportions of length to diameter with as much accuracy as can be expected in any tests made with varying qualities of material; and this is especially noticeable in the round-ended columns, which are free from the disturbing contingencies mentioned in the last Article.

121. Steel Columns.—According to some experiments the modulus of elasticity in steel is no greater than in wrought iron; but on the average it may probably be credited with a somewhat higher modulus of $E = 29,000,000$ lbs. The strength of a long ideal column ought therefore to be only slightly greater than in wrought iron, or

$$\rho = 29,000,000 \pi^2 \times \left(\frac{r}{l} \right)^2.$$

But in short columns the superior strength of the steel will come into play, and in the practical column of unequal elasticity it will come into play to some extent at all ratios of length to diameter.

The ultimate strength of steel, whether in tension or compression, is known to vary within very wide limits; but as before stated this will not in any way affect the curve BC forming the upper limit in Figs. 155 and 156. It is necessary, however, to assume some value of f for the lower limit. Mr. Kircaldy finds that the ratio of tensile to compressive strength is the same in steel as in wrought iron; and therefore if we take f at 70,000 lbs. for hard steel, it will correspond with a tensile

strength of about 40 tons, which represents roughly one of the strongest classes of steel ordinarily used for constructive purposes. With this assumed value of f the lower limit for columns of hard steel with fixed ends is described by the wave-line curve AC in Fig. 155.

The material known as mild steel may have almost any strength between that of hard steel and that of wrought iron. If we assume as a broad average that $f=48,000$ lbs., the lower limit will be given by the curve AC in Fig. 156. The actual experiments shown in these two diagrams are those of Mr. Christie, and were made with bars of L and beam section, in which the percentage of carbon averaged 0.36 in the hard steel, and 0.12 in the mild steel.

122. Reliable Strength of Columns.—We have seen that the strength of columns is greatly affected by certain causes which cannot be guarded against; and it may reasonably be expected to suffer a consequent diminution to any unknown extent down to the limit shown by the curve AC ; and the diagrams show that this curve represents very nearly the average boundary of the constellation in each case, excluding a few abnormal examples; therefore taking this curve to represent the reliable strength of columns, the arithmetical values of the breaking load as calculated from the formulæ will be as follows:—

TABLE 2.—*Breaking Weight of Columns with Rounded Ends in Pounds per Square Inch of Sectional Area.*

Ratio $\frac{l}{r}$	Cast Iron.	Wrought Iron.	Mild Steel.	Hard Steel.
20	72,300	85,200	46,700	67,200
40	50,800	32,600	42,700	58,600
60	30,000	28,400	36,000	45,500
80	17,600	23,200	28,300	33,000
100	11,700	18,200	21,500	23,700
120	8,300	14,100	16,400	17,500
140	6,300	11,100	12,700	13,300
160	4,900	8,800	10,100	10,400
180	3,900	7,200	8,160	8,360
200	3,200	5,900	6,710	6,850
220	2,680	4,970	5,620	5,710
240	2,270	4,210	4,750	4,820
260	1,950	3,640	4,080	4,130
280	1,690	3,140	3,550	3,570
300	1,480	2,750	3,100	3,130
320	1,300	2,430	2,730	2,740
340	1,160	2,160	2,430	2,440
360	1,040	1,940	2,190	2,190
380	940	1,730	1,960	1,960
400	850	1,570	1,760	1,760

TABLE 3.—*Breaking Weight of Columns with Fixed Ends in Pounds per Square Inch of Sectional Area.*¹

Ratio $\frac{L}{r}$	Cast Iron.	Wrought Iron.	Mild Steel.	Hard Steel.
20	77,600	85,800	47,400	68,700
40	67,800	34,900	45,700	65,800
60	54,700	33,400	43,300	60,500
80	42,000	31,100	39,900	53,600
100	30,000	28,400	36,000	45,500
120	21,200	25,300	31,000	37,400
140	16,000	22,200	26,500	30,500
160	12,600	19,200	22,500	25,000
180	10,200	16,500	19,100	20,900
200	8,300	14,100	16,400	17,500
220	6,900	12,100	13,900	14,900
240	5,700	10,500	12,000	12,600
260	5,000	9,300	10,400	11,000
280	4,400	8,200	9,100	9,500
300	3,900	7,200	8,200	8,400
320	3,400	6,300	7,200	7,300
340	3,000	5,600	6,300	6,500
360	2,700	5,100	5,500	5,700
380	2,470	4,600	5,100	5,200
400	2,270	4,210	4,750	4,800

123. **Mr. Hodgkinson's Rules.**—In this chapter we have endeavoured to trace the operation of some of those natural causes which are chiefly instrumental in determining the strength of columns, with the view of finding a probable *lower limit* of strength, as affected by unknown contingencies which vary with every experiment, but which vary only within certain known limits. We may now refer to the tables and formulæ which have been constructed to represent the *average* results, or perhaps a safely *low* average of the results of experiments by different observers.

As the result of his own experiments upon cast-iron pillars, Mr. Hodgkinson deduces the following formulæ:—

I. When the length is not less than thirty times the diameter. For solid cylindrical pillars, *d* being the diameter *in inches*, and *L* the length *in feet*, the gross breaking weight of the pillar is—

$$P = A \frac{d^{3.6}}{L^{1.7}} \dots \dots \dots (15)$$

For hollow cylindrical pillars in which *d* is the external and *d*₁ the internal diameter—

$$P = A \cdot \frac{d^{3.6} - d_1^{3.6}}{L^{1.7}} \dots \dots (16)$$

¹ The calculated strength of columns with fixed ends, which is deduced from that of round-ended columns as already described, will apply to cases in which the adjustment and fixity of the ends are as accurate as they generally are in experiments with a testing machine.

The values of the coefficient *A* are as follows:—

- (1.) For solid pillars with rounded ends *A* = 14·9 tons.
- (2.) For solid pillars with flat ends 44·16 „
- (3.) For hollow pillars with rounded ends 13·0 „
- (4.) For hollow pillars with flat ends 44·3 „

II. When the length is less than thirty times the diameter. Let *b* denote the breaking weight as computed by the above formulæ; and let *c* denote the crushing load of a short block of the same sectional area assuming a hypothetical strength of forty-nine tons per square inch then—

$$P = \frac{bc}{b + \frac{3}{4}c} \dots \dots \dots (17)$$

These formulæ apply to circular sections only; and they make the breaking weight per square inch to depend not only upon the ratio of length to diameter, but also upon the size of the column.

124. **Gordon's Rules.**—The formula deduced by Gordon, and based upon the above-named experiments of Mr. Hodgkinson, expresses the breaking weight per square inch in the following form:—

For round-ended columns, whose length *l* and diameter *d* are measured in the same units—

$$p = \frac{f}{1 + 4a \frac{l^2}{d^2}} \dots \dots \dots (18)$$

For pillars which are fixed at the ends by having flat capitals and bases, it is assumed that the strength is that of an equivalent round-ended column of half that length, or $l = \frac{L}{2}$, and the formula consequently becomes—

$$p = \frac{f}{1 + a \frac{L^2}{d^2}} \dots \dots \dots (19)$$

The following are the values of *f* and *a*:—

	<i>f</i> lbs. per sq. in.	<i>a</i>
Wrought iron, solid rectangular section	36,000	$\frac{1}{3000}$
Cast iron, hollow cylinder	80,000	$\frac{1}{800}$
Cast iron, solid cylinder	80,000	$\frac{1}{100}$

The general form of Gordon's expression has been adopted by other authorities, who have modified the values of the constants. Thus M. Claudel adopts the following formula for solid cast-iron cylinders varying from 5 to 120 diameters:—

$$p = \frac{c}{1.45 + .00337 \frac{L^2}{d^2}} \dots \dots \dots (20)$$

or for columns from 5 to 30 diameters—

$$p = \frac{c}{0.68 + \frac{1}{10} \frac{L}{d}} \dots \dots \dots (21)$$

in which *c* denotes the ultimate crushing strength, varying perhaps from 36 to 49 tons. On the other hand, Dr. Ritter's formula, when expressed in tons per square inch, becomes—

$$p = \frac{44.4}{1 + .003 \frac{L^2}{d^2}} \dots \dots \dots (22)$$

It has already been remarked that Mr. Hodgkinson finds the strength per square inch to depend upon the actual size of the cast-iron column, independently of the ratio $\frac{L}{d}$; accordingly, although Gordon's expression agrees very well for small columns, it would appear that the constants may be modified in the case of larger sizes, and Mr. Baker finds the following values to represent more closely the strength of cast-iron columns 12 inches in diameter, viz.—

$$p = \frac{42.4}{1 + \frac{1}{110} \frac{L^2}{d^2}} \dots \dots \dots (23)$$

125. Summary of Results for Cast Iron.—The results of the different formulæ when applied to solid cylindrical columns of cast iron, of 1 inch and 12 inches diameter, are shown side by side in Table 4, and may be compared with the ordinates of the curve *AC* in Fig. 154, which are given in cwts. per square inch in the first column of the table, while the other columns give the values as obtained by the different formulæ above mentioned.

TABLE 4.—*Solid Cylindrical Columns of Cast Iron (Fixed Ends). Breaking Weight in Cwts. per Square Inch.*

Ratio of Length to Diameter.	Value of <i>p</i> by Limiting Curve, and Formulæ (19) & (16).	Gordon.		Hodgkinson.		Claudel.		Ritter. Formula (22).
		12" Column.	1" Column.	12" Column.	1" Column.	Min. <i>c</i> =36.	Max. <i>c</i> =49.	
		Formula (23).	Formula (19).	Formulæ (15) & (16).	Formulæ (15) & (16).	Formula (20).	Formula (20).	
10	605	605	576	605	661	430	584	683
20	375	326	360	326	382	270	366	404
30	190	184	221	184	236	162	219	240
40	118	114	144	113	144	106	144	152
50	74	77	99	77	99	74	100	104
60	50	55	72	57	74	54	73	75
70	40	41	54	43	56	40	55	57
80	31	32	42	34	44	32	43	44

M

The curve of the diagram evidently runs very near to the Gordon and Hodgkinson formulæ for a 12-inch column as well as the lower limit of the experiments. Between 30 and 60 diameters the curve is rather below the limit, and this is probably due to our having described the curve of "failure by tension" with a value of f_1 derived from direct tensile tests, whereas we should perhaps have inserted the theoretic ultimate stress deduced from transverse bending; this, however, would not greatly affect the figures.

126. **Summary of Results for Wrought Iron.**—The constants employed in Gordon's formula for wrought-iron struts have already been given.

M. Claudel gives the following for columns of 10 to 180 diameters, viz.—

$$p = \frac{25.4}{1.55 + .0005 \frac{L^2}{d^2}} \dots \dots \dots (24)$$

On the other hand Dr. Ritter gives—

$$p = \frac{19}{1 + .0015 \frac{L^2}{d^2}} \dots \dots \dots (25)$$

But Professor Rankine uses the least radius of gyration as the true measure of the stiffness in a column of any section, and deduces the formula—

$$p = \frac{f}{1 + c \cdot \frac{L^2}{r^2}} \dots \dots \dots (26)$$

in which f is taken at 36,000 lbs. for wrought iron, while the constant c is $\frac{1}{36000}$.

To compare these results, we may take the case of a solid cylindrical column, in which $r = \frac{1}{4}d$; and the results of the several formulæ will be as follows:—

TABLE 5.—*Solid Cylindrical Columns of Wrought Iron (Fixed Ends). Breaking Weight in Cwts. per Square Inch.*

Ratio $\frac{L}{d}$	Limiting Curve Δc . (18.)	Gordon. (19.)	Rankine. (26.)	Claudel. (24.)	Ritter. (25.)	Christie.
10	312	310	308	317	330	357
20	278	282	278	290	237	286
30	226	255	229	254	161	250
40	172	208	188	216	111	205
50	126	175	152	181	80	156
60	94	145	123	151	59	116
70	73	122	101	127	45	89
80	56	102	83	107	35	71

The last column in the table gives the results deduced by Mr. Christie for equivalent values of $\frac{L}{r}$ from experiments made with bars of L and T section.

127. Steel Columns—Mr. Christie's Experiments.—As the result of these recent experiments with bars of L and I section, Mr. Christie deduces no formula, but he gives the following table of average results for different ratios of length to radius of gyration, the radius being always measured in the plane of easiest flexure.

TABLE 5A.—*Flat-Ended Struts of Angle Section. Breaking Weight in Lbs. per Square Inch, deduced by Mr. Christie.*

Ratio $\frac{L}{r}$	Mild Steel.	Hard Steel.
20	72,000	100,000
40	46,000	65,000
60	41,000	58,000
80	38,000	54,000
100	35,000	47,000
120	31,500	40,000
140	27,000	33,500
160	23,000	28,300
180	19,500	23,800
200	16,500	20,000
220	14,000	16,900
240	12,000	14,000
260	10,300	11,800
280	9,000	10,200
300	7,900	9,000

The individual tests are given in Figs. 155 and 156; and if the values given in the table are plotted upon the diagrams, it will be seen that they form an irregular line, describing generally a lower limit, or at least a low average of the several tests; so that the line coincides roughly with the curve AC, crossing it in fact two or three times; but at the left end of the diagram, Mr. Christie's line leaves the lower limit and appears to aim at a *mean value* of the compressive strength of very short specimens, or rather a figure which is much above the mean value of the two or three shortest specimens, and is apparently determined by a single example near the corner A_1 of each diagram. However, for a column of about 10 diameters, or $\frac{L}{r} = 40$, Mr. Christie's figures are practically identical with those of Table 3, and for all longer columns the difference is inconsiderable.

It has already been mentioned that the strength of steel varies within extremely wide limits; and the tables and diagrams will only apply to a character of steel such as is indicated by the value assumed in each case

for the constant f , or to steel of a quality approximating to that used in Mr. Christie's experiments. The bars employed in those tests gave an average ultimate *tensile* resistance of 100,900 lbs., or 45 tons in the hard steel, and 63,400 lbs. or 28½ tons in the mild steel. The tensile and compressive strength of mild steel may have almost any value between that of hard steel and that of good wrought iron; and the stronger the steel the higher will be the value of f in formula (13).

The following values of the coefficients in Gordon's formula have been given by Mr. Baker as applicable to steel columns:—

Solid round pillars	{	Mild steel . . .	$f = 30$ tons,	$a = \frac{1}{14000}$
		Strong steel . . .	$f = 51$ tons,	$a = \frac{1}{5000}$
Solid rectangular pillars	{	Mild steel . . .	$f = 30$ tons,	$a = \frac{1}{24000}$
		Strong steel . . .	$f = 51$ tons,	$a = \frac{1}{15000}$

The character of steel here contemplated is probably in each instance stronger than that used in Mr. Christie's experiments; and the results when traced upon the diagram would give a much higher curve.

For the most ordinary ratios of length to radius of gyration, *i.e.* for all ratios greater than 20 and less than 200, the results of Mr. Christie's experiments, as given in his own tables, would be expressed with a fair degree of accuracy by the following empirical formulæ:—

$$\text{Mild steel } p = \frac{48,000}{1 + \frac{L^2}{30,000r^2}} \dots \dots \dots (27)$$

$$\text{Hard steel } p = \frac{70,000}{1 + \frac{L^2}{20,000r^2}} \dots \dots \dots (28)$$

in which r is the radius of gyration.

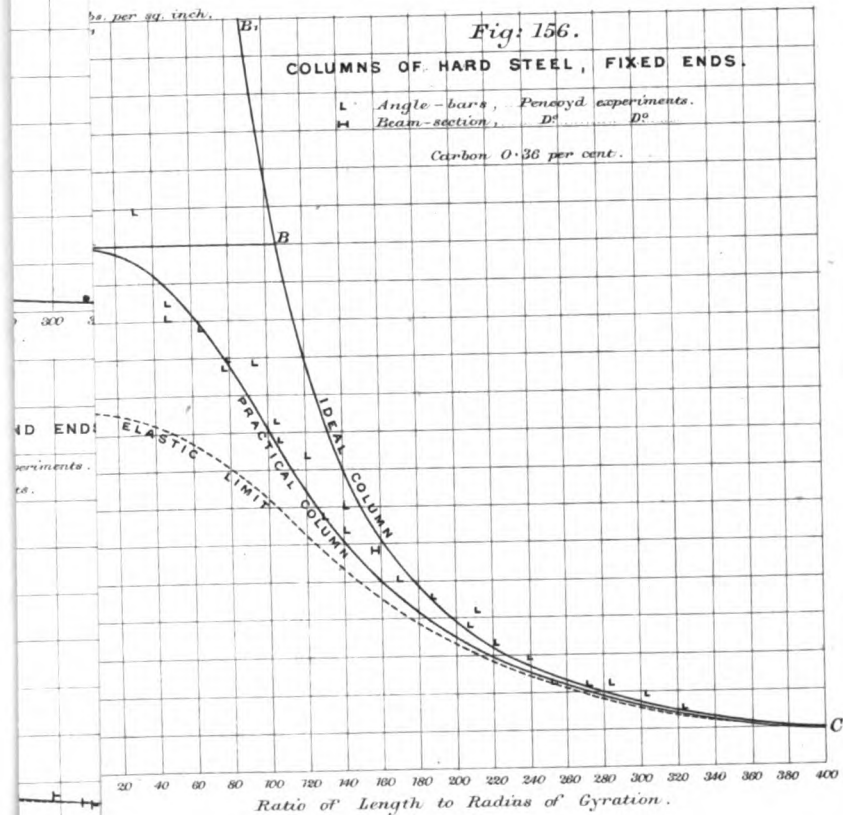
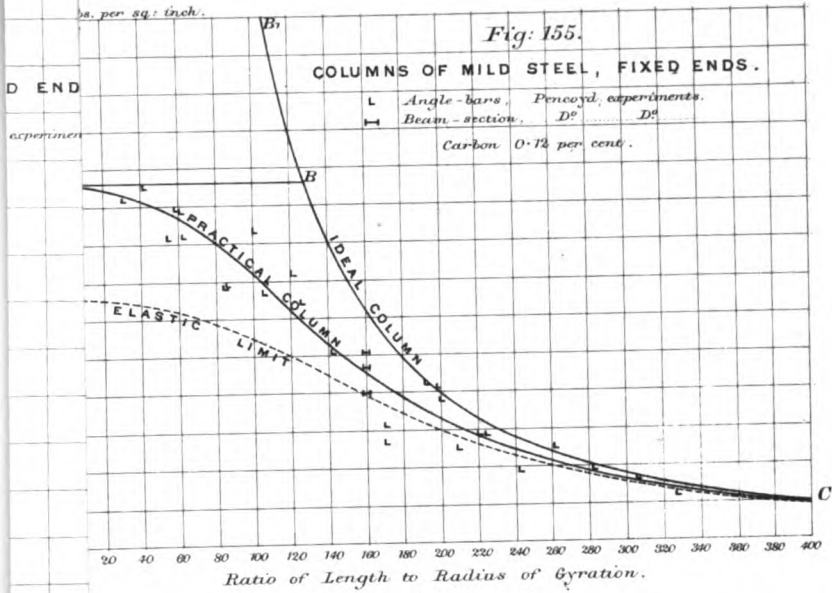

CHAPTER XI.

THE DESIGN AND CONSTRUCTION OF STRUTS.

128. *Safe Working Load.*—In the preceding chapter we have found the breaking weight for struts of different proportions; but before we can proceed to determine the safe working load, we must first decide upon the factor of safety, and we must also know something about the proportions of the strut.

With regard to the fixing of a proper factor of safety, there exists at present a great diversity of opinion, and especially amongst those who have devoted the greatest attention to the subject. The method most usually followed hitherto by practical men has been to fix the tensile or compressive working-stress at a certain fraction of the ultimate strength as ascertained by experiments made with a quiescent and gradually increased load. Some authorities prefer to take the "elastic limit" rather than the ultimate strength of the material; but as they then use a proportionately smaller factor of safety, the result comes to pretty much the same thing.

In most countries the working-stress in iron bridges is limited by certain Governmental Rules, which do not generally go beyond this elementary principle of applying a *constant* working-stress, although the standard varies slightly in different countries, and in some cases the working-stress for compression is somewhat lower than for tension.

At the same time it has been generally recognised that in applying these rules, some regard must be paid to the liability of long struts to flexure; and for this purpose the formulæ of Rankine and Gordon have been very generally employed, independently of the Government Rules, in order to determine the reduced strength of long and slender compression members. The practice of adopting a constant working-stress for all compression members, subject to such modification as may be indicated by Rankine's formula, is therefore so widely sanctioned that we must certainly be prepared to carry out our calculations on this basis.

In recent times, however, a totally different view has been taken by many engineers in regard to the proper working stress, whether in tension or compression. Wöhler's experiments have shown that the ultimate strength of materials, as ascertained in the usual manner, cannot be relied upon when applied to a structure which is subject to constant and rapid changes of load; and indeed that the breaking load depends so largely upon the *manner* of loading that in some cases it is reduced to

one half, and in other cases even to one third of its nominal amount. These experimental results are as firmly grounded as any that have been obtained by a quiescent load, while the latter have the disadvantage that they certainly do not represent the conditions which obtain in bridge-construction; and it is therefore not surprising that Wöhler's results have been regarded by some engineers as the only reliable facts on which the strength of such structures can be calculated. It is unfortunate, however, that the real meaning of Wöhler's experiments is capable of being construed in different ways; and as a natural consequence the formulæ, which have been proposed for applying them to practice, differ widely among themselves.

We must therefore leave this question for future consideration; and for reasons already mentioned, we must proceed to consider the design of compression members as based upon the rules which have hitherto been generally accepted. Accordingly we shall assume for the present that the working load is to be determined by applying a certain factor of safety to the breaking load as found by the usual experiments, or as found by Rankine's formula in the case of long struts.

129. Short Compression Members—Working Load and Sectional Area.—For a short strut, or for any compression member which is so stiff or so well supported as to be free from any liability to buckling, the breaking load in pounds per square inch will be that indicated by the several experiments shown at the left end of the diagrams, Figs. 151 to 156.

The working load is fixed in a usual way by applying a factor of safety to the breaking load; *i.e.*, if f denotes the ultimate crushing strength, or the breaking weight of a short column, the working load per square inch of sectional area will be $\frac{f}{F}$ in which F is the factor of safety; and if P denotes the greatest load that the strut has to carry, the required sectional area of the short strut will be—

$$A_0 = \frac{PF}{f} \quad . \quad . \quad . \quad . \quad . \quad . \quad (1)$$

In the case of Wrought Iron, if we take a factor $F = 4$ as applicable to the ultimate strength f estimated at sixteen tons per square inch, we shall have a working load of $\frac{1}{4}f = 4$ tons per square inch of gross section; and this value is very commonly adopted as a standard, whether it be deduced from the breaking load or from the elastic limit. In some English practice 4.5 tons is adopted, while in America it is more usual to take the working stress at four American tons or 8000 lbs. per square inch.

In the case of Steel the working load must evidently depend upon the quality of the material.¹ In the principal members of the Forth Bridge the adopted working-stress was $7\frac{1}{2}$ tons per square inch; but this was of course reduced in long struts and in members subject to great variations of stress.

¹ *Vide* Chapter X., Art. 127, and Chapter XII.

When Cast Iron is employed, it is usually considered advisable to make allowance for the uncertain character of the material, by using a higher factor of safety, or say $F=5$; and the working load is then equal to about seven tons per square inch in short columns.

130. Long Struts Liable to Buckling.—We have seen that the breaking load p per square inch of sectional area is greatly affected by the ratio of length to diameter of column, and therefore the working load must be correspondingly reduced in long and slender struts. According to the most usual method, this is done by applying the same factor of safety to the breaking weight p in every case; *i.e.*, by making the working load equal to $\frac{p}{F}$, in which p is the breaking load for a column of the given proportions.

The tables given in the last chapter, and the formulæ of Gordon and Rankine therein quoted, will give us the value of the breaking load p for any given ratio of length to diameter, or length to radius of gyration; and therefore *when we know* the exact dimensions of the strut and the figure of its cross-section, we can always find the proper working load without any difficulty. But in the ordinary process of designing the members of a bridge, we want to know the safe working load per square inch before we can determine the cross-section of the strut; and therefore the tables and formulæ given in the last chapter are incapable of any direct application for the purpose in view. They will enable us to ascertain whether any existing bridge is strong enough for its purpose, but if we have to *design* the bridge by their aid, we can only begin by guessing at a cross-section, and then go on to see whether it is strong enough, by calculating the radius of gyration, the ratio $\frac{L}{r}$, and the resulting value of p .

131. Process of Designing a Strut.—The problem generally presents itself in the following practical form:—The length of the strut having been fixed, and the maximum load calculated, we have then to decide upon a suitable form of cross-section and to determine the required sectional area of the strut.

When the length is moderate and the load comparatively great, the solution is very simple, and the difficulty only arises when these conditions are reversed. But it is precisely here that the selection of a good form becomes especially important, and the calculation of its required area especially difficult; and the question has so wide an influence upon the economic design of large bridges, that we must endeavour to examine it in some detail.

In general it is obvious that economy is to be attained by adopting a diameter which is not less than a certain moderate fraction of the length; but with a given sectional area we cannot always make the diameter as large as we should like. For example, if we have a strut 150 feet in length, we may perhaps wish to adopt a diameter of not less than $\frac{1}{8}$ th of the length, or 5 feet; but if the required sectional area amounts only to 25 square inches, how is such a strut to be constructed? A hollow

tube of square or cylindrical section would require to be made with a thickness of only $\frac{1}{8}$ th or $\frac{1}{10}$ th of an inch; and in such a case it is certain that the strength would not depend so much upon the flexure of the whole strut as upon the *secondary flexure* or local wrinkling or collapse of the thin plate, and would be greatly reduced in consequence.

The same question arises, in a different form, in dealing with struts of smaller size and with smaller loads; for the fact is that in addition to the length and diameter of the strut, there is a *third dimension* which has not yet been considered, but which determines the ratio between the sectional area and the diameter of the strut (or its radius of gyration); and which is itself determined either by geometrical necessity or by the practical requirements of manufacture, or is limited by considerations of secondary flexure.

Thus, by way of further example, we may, perhaps, have to design a series of compression members in the web-bracing of a girder, each of which is to be composed of two T irons rivetted back to back. Now, taking the case of the lightly-loaded struts near the centre of the girder, we may perhaps begin by assuming a certain working load which would be proper for a certain *assumed* diameter; then having worked out the required sectional area, we should very likely find that the strut *cannot be made* of the given diameter and given sectional area except by making the T irons so thin that in practice they could not be obtained. For a T iron cannot be rolled as thin as paper, and therefore its diameter (or its radius of gyration) cannot bear more than a certain proportion to its sectional area.

Proceeding further, we may perhaps try a smaller diameter with a correspondingly lower working-stress, and so on. In this way the proper section of T iron may be arrived at by repeated trials; and at the same time it may probably be discovered that a different *form* of cross-section would have given more satisfactory results; for, owing to the influence of the third dimension, it will be seen that a form of construction which is suitable for *one* length of strut and *one* value of the gross load, is quite unsuitable when the length or the load has a different value.

To acquire the same information in a more direct and ready manner, we must consider the influence of the third dimension.

132. The Third Dimension—Sectional Area in Terms of Load and Length.—By way of illustration we may consider the third dimension as representing a *mean thickness*, which being multiplied by the diameter d , will give the actual sectional area of the strut; and the mean thickness of a given section may be measured by the diameter multiplied by a factor or coefficient (g); so that if A is the sectional area, we should have mean thickness $= gd = \frac{A}{d}$, or $A = gd^2$.

But for the present purpose it will be better to take the radius of gyration r as the unit of measurement in each case. There can be no doubt that amongst the different sections of rolled iron bars or built struts, the radius of gyration should be taken rather than

the outside diameter, as the true measure of stiffness. It has been shown in the last chapter that when struts of very different sections are ranged together according to the radius of gyration, the results of experiment agree together as closely as could be expected; but if struts of equal diameter and of different patterns of cross-section had been ranged together, their strengths would *not* have agreed together.

But in any given pattern of cross-section, the radius of gyration r will always be a certain fraction of the diameter; and as we have expressed the sectional area A as a certain multiple of d^2 , so also it will be a certain multiple of r^2 , or say $A = g d^2 = \zeta r^2$.

The constants g and ζ will of course depend on the figure of the cross-section; thus in a solid square bar $g = 1$, and $\zeta = 12$, so that $A = d^2 = 12r^2$; and in the same way whatever may be the given figure of cross-section, its area may be expressed as a multiple of d^2 or a multiple of r^2 .

It was also found that for all proportions of column usually employed, *i.e.*, up to 40 diameters, the value of the breaking weight as given by Professor Rankine's formula (26) coincides very nearly with the lower limit which was theoretically found. Therefore taking for our present purpose the well-authenticated formula $p = \frac{f}{1 + c \frac{L^2}{r^2}}$, we may apply the factor of safety

F , and if P denotes the gross load, we have the required sectional area $A = \frac{PF}{p} = \frac{PF}{f} \left(1 + c \frac{L^2}{r^2} \right)$; or making use of the symbol $A_0 = \frac{PF}{f}$, which denotes the standard sectional area for very short struts, we may write the expression $A = A_0 \left(1 + c \frac{L^2}{r^2} \right)$.

But we have, as above, $A = \zeta r^2$, therefore $A = A_0 \left(1 + \frac{c \zeta L^2}{A} \right)$, and by reduction this gives—

$$A = \frac{A_0}{2} + \sqrt{\left(\frac{A_0}{2} \right)^2 + A_0 c \zeta L^2} \dots (2)$$

By means of this expression we may apply Rankine's formula so as to obtain the required sectional area, at one operation, in terms of the given load P and the length L , when the coefficient ζ has been determined. This will facilitate the process of calculation; and at the same time it will enable us to form a general idea as to the type of construction which will be most suitable under given circumstances.

133. The following table gives, for several elementary forms of cross-section, the general formulæ for the moment of inertia I , the sectional area A , the square of the radius of gyration or $r^2 = \frac{I}{A}$, and the coefficient

$\zeta = \frac{A}{r^2}$. In each case the supposed plane of flexure is the plane of the dimension H , and is at right angles to the neutral axis shown in dotted lines.

TABLE 6.

No.	Section.	I	A	$r^2 = \frac{I}{A}$	$\zeta = \frac{A}{r^2}$
1		$\frac{D^4}{12}$	D^2	$\frac{D^2}{12}$	12
2		$\frac{BH^3}{12}$	BH	$\frac{H^2}{12}$	$12 \frac{B}{H}$
4		$\frac{LH^3 + bh^3}{12}$	$lh + bh$	$\frac{LH^3 + bh^3}{12(LH + bh)}$	$\frac{12(LH + bh)^2}{LH^3 + bh^3}$
5 and 6		<i>Do.</i>	<i>Do.</i>	<i>Do.</i>	<i>Do.</i>
7 and 9		<i>Do.</i>	<i>Do.</i>	<i>Do.</i>	<i>Do.</i>
8 and 10		$\frac{BH^3 - bA^3}{12}$	$BH - bA$	$\frac{BH^3 - bA^3}{12(BH - bA)}$	$\frac{12(BH - bA)^2}{BH^3 - bA^3}$
7A and 9A		<i>Do.</i>	<i>Do.</i>	<i>Do.</i>	<i>Do.</i>
—		$\frac{D^4 \pi}{64}$	$\frac{D^2 \pi}{4}$	$\frac{D^2}{16}$	4π
—		$\frac{\pi}{64}(D^4 - d^4)$	$\frac{\pi}{4}(D^2 - d^2)$	$\frac{D^2 + d^2}{16}$	$4\pi \frac{D^2 - d^2}{D^2 + d^2}$

To facilitate the work of designing compression-members, we shall now go on to consider the practical value of ζ in the most ordinary forms of cross-section; so that we may be able to find the required sectional area A in terms of the net theoretical area A_0 which would be proper for very short struts.

134. Wrought-Iron Struts—General Formula for Sectional Area.—In Rankine's formula for wrought-iron columns with fixed ends, the constant c is taken as $\frac{1}{32.000}$; the length L being measured in the same units as the radius of gyration r ; but taking the length in feet and all transverse dimensions in inches, the constant will be $c = \frac{1}{320}$; and the sectional area for wrought-iron struts of any length will be—

$$A = \frac{A_0}{2} + \sqrt{\left(\frac{A_0}{2}\right)^2 + \frac{\zeta A_0 L^2}{250}} \dots \dots \dots (3)$$

in which A_0 is the net or minimum sectional area for short compression members.

This formula will be equally applicable whatever factor of safety we may ultimately see fit to adopt in determining A_0 . For the present we shall take 4 as the factor of safety, and the working load for short struts being then 4 tons per square inch, the gross load in tons will be equal to $4A_0$, or $A_0 = \frac{P}{4}$.

135. Solid Square or Rectangular Bars.—In the case of a square bar it is abundantly evident that the diameter can have only one value for a given sectional area, and therefore it would be quite useless to *assume* a diameter for the purpose of finding the working load and the corresponding sectional area; but for this section the constant relation between sectional area and diameter, or radius of gyration, is fixed by geometrical necessity, and is $A = D^2 = 12r^2$; and inserting $\zeta = 12$ in formula (3) the required sectional area is directly obtained. Thus if the load is 4 tons, the standard area (for short struts) is $A_0 = 1$ square inch; and the area for any other length of strut will then be—

$$A = \frac{1}{2} + \sqrt{\frac{1}{4} + \frac{12L^2}{250}}$$

The resulting values, in square inches, are given in the first line of Table 7 for lengths varying from $L = 2' 6''$ to $L = 20' 0''$; and taking successive values for the load P and standard area A_0 up to 10 square inches or 40 tons, the table gives the required section of strut expressed as a multiple of A_0 ; so that in every case the required area is $A = mA_0$.

TABLE 7.—Wrought-Iron Struts—Square Bars.

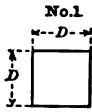
		$A = D^2 = 12r^2; \zeta = 12$ $A = \frac{A_0}{2} + \sqrt{\left(\frac{A_0}{2}\right)^2 + \frac{12A_0L^2}{250}} = mA_0$							
Length in Feet.									
Fixed ends, L=	2' 6"	5' 0"	7' 6"	10' 0"	12' 6"	15' 0"	17' 6"	20' 0"	
Round ends, l=	1' 6"	3' 0"	4' 6"	6' 0"	7' 6"	9' 0"	10' 6"	12' 0"	
P. in tons.	A_0 sq. ins.	Multiple <i>m</i> .							
4	1	1.24	1.70	2.22	2.75	3.28	3.83	4.37	4.91
8	2	1.13	1.42	1.77	2.13	2.50	2.88	3.26	3.64
12	3	1.09	1.31	1.57	1.86	2.16	2.46	2.77	3.08
16	4	1.07	1.24	1.46	1.71	1.96	2.22	2.48	2.75
20	5	1.06	1.20	1.39	1.60	1.83	2.05	2.29	2.52
24	6	1.05	1.17	1.34	1.52	1.72	1.93	2.07	2.36
28	7	1.04	1.15	1.30	1.46	1.64	1.83	2.00	2.24
32	8	1.03	1.13	1.27	1.42	1.59	1.76	1.94	2.13
36	9	1.03	1.12	1.24	1.38	1.54	1.70	1.87	2.04
40	10	1.03	1.11	1.22	1.35	1.50	1.65	1.81	1.97

*Example.*¹—Suppose that we have to construct a wrought-iron stanchion of solid square section, to be 10 feet in length, with ends rigidly fixed, and to carry a load of 20 tons, what is the required size of the bar?

The net section for a short strut would be $A_0 = \frac{20}{4} = 5$ square inches; and referring to the table, the multiple for this length and load is 1.60; therefore the required sectional area is $5 \times 1.60 = 8$ square inches.

This would give a bar 2.83, or say $2\frac{7}{8}$ inches square; and if we wish to check the result, the exact radius of gyration will be $r = 0.816$ inch, and the ratio $\frac{L}{r}$ in Rankine's formula is therefore $\frac{120}{0.816} = 147$; while the breaking

weight per square inch will be $p = \frac{16}{1 + \frac{147^2}{36,000}} = 10$ tons. The breaking

weight of the strut is therefore $8 \times 10 = 80$ tons, or four times the working load,—which is the result aimed at.

Of course the apparent working stress is in each case simply $\frac{4}{m}$, or standard working stress. It will also be seen that the multiple shows at

a glance what percentage of additional metal has to be provided to resist the flexure of the strut; thus in the foregoing example it is evident that

¹ If the reader has hitherto doubted the necessity or the usefulness of this inquiry, he may easily convince himself of it by trying to solve, in any other way, the very commonplace problem proposed in this example.

60 per cent. must of necessity be added to the net theoretic section (of a short strut) in order to stiffen the stanchion against buckling; and the comparative economy of different forms of cross-section, for different situations, may thus be examined by comparison of the tables.

Flat Bars.—If the strut is equally liable to flexure in both directions, the square bar will be stronger than any other rectangular bar of the same area, and the table (7) shows, therefore, the best that can be done in such a case with this type of section. But in practice flat bars are often used in the diagonal struts of lattice-girders, the bars being stiffened laterally by some kind of support applied at short intervals, and the unsupported length for lateral flexure being thus reduced. In such cases it will presently be shown that the bar, as regards lateral flexure, may be considered as a strut with hinged or rounded ends whose length l is equal to the distance between such points of support. In all cases we shall take the length l of round-ended struts as being equivalent to $\frac{6}{10}$ ths of the length L for fixed-ended struts, and these lengths are given in the tables as equivalent to one another.

In all bars of flat rectangular section the coefficient ζ , as shown in Table 6, will be equal to $12\frac{B}{H}$; and this value being inserted in formula (3), the required sectional area for any given proportions may be easily found.

By way of example, the following tables give the values of the multiple m for wrought-iron flats whose breadth is four times their thickness:—

TABLE 8.—Wrought-Iron Struts—Flat Bars.



		$B = 4H; A = \frac{1}{4}B^2 = 16H^2 = 48r^2; \zeta = 48.$ $A = \frac{A_0}{2} + \sqrt{\left(\frac{A_0}{2}\right)^2 + \frac{48A_0L^2}{250}}$							
		Length in Feet.							
Fixed ends, $L =$		2' 6"	5' 0"	7' 6"	10' 0"	12' 6"	15' 0"	17' 6"	20' 0"
Round ends, $l =$		1' 6"	3' 0"	4' 6"	6' 0"	7' 6"	9' 0"	10' 6"	12' 0"
P. in tons.	A_0 sq. ins.	Multiple m_1 .							
4	1	1.70	2.75	3.83	4.91
8	2	1.42	2.13	2.88	3.64
12	3	1.31	1.86	2.46	3.08
16	4	1.24	1.70	2.22	2.75	3.28	3.82
20	5	1.20	1.60	2.05	2.52	3.00	3.48
24	6	1.17	1.52	1.93	2.36	2.80	3.23
28	7	1.15	1.46	1.84	2.23	2.64	3.03
32	8	1.13	1.42	1.76	2.13	2.50	2.88	3.26	3.64
40	10	1.11	1.35	1.66	1.97	2.30	2.64	2.98	3.32
48	12	1.09	1.31	1.57	1.86	2.18	2.46	2.77	3.08
64	16	1.07	1.24	1.46	1.70	1.96	2.22	2.42	2.75
80	20	1.06	1.20	1.39	1.60	1.82	2.05	2.28	2.52

Table 8 gives the multiple m_1 for the flat bars considered in relation to flexure in the plane of their least dimension; while Table 8A gives the multiple m_2 for the same bars set on edge, and when liable only to flexure in the plane of their depth. The latter case arises in some arrangements of bracing which will be presently referred to.

In this, as in all the following tables, the first line refers to struts of very small scantling such as could only be used in secondary bracing or in very small structures.

TABLE 8A.—Wrought-Iron Struts—Flat Bars.

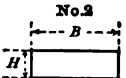
		$H = 4B; A = 16B^2 = \frac{1}{4}H^2 = 3r^2; \zeta = 3.$ $A = \frac{A_0}{2} + \sqrt{\left(\frac{A_0}{2}\right)^2 + \frac{3A_0L^2}{250}}.$							
		Length in Feet.							
Fixed ends, $L =$		2' 6"	5' 0"	7' 6"	10' 0"	12' 6"	15' 0"	17' 6"	20' 0"
Round ends, $l =$		1' 6"	3' 0"	4' 6"	6' 0"	7' 6"	9' 0"	10' 6"	12' 0"
P. in tons.	A_0 sq. ins.	Multiple m_2 .							
4	1	1.06	1.24	1.46	1.70	1.96	2.22	2.48	2.75
8	2	1.04	1.13	1.27	1.42	1.59	1.76	1.95	2.13
12	3	1.02	1.09	1.19	1.31	1.44	1.57	1.71	1.86
16	4	1.02	1.07	1.15	1.24	1.35	1.46	1.58	1.71
20	5	1.01	1.06	1.12	1.20	1.29	1.39	1.49	1.60
24	6	1.01	1.05	1.10	1.17	1.25	1.34	1.43	1.52
28	7	1.01	1.04	1.09	1.15	1.22	1.30	1.38	1.46
32	8	1.01	1.03	1.08	1.13	1.20	1.27	1.34	1.42
40	10	1.01	1.03	1.06	1.11	1.16	1.22	1.29	1.35
48	12	1.01	1.02	1.05	1.10	1.14	1.19	1.25	1.31
64	16	1.01	1.02	1.04	1.07	1.11	1.15	1.19	1.24
80	20	1.00	1.01	1.03	1.06	1.09	1.12	1.16	1.20

136. **Struts of L Section.**—In practice the thickness of L bars is generally not less than one-eighth of the width; thus an angle iron $3'' \times 3''$ may be often a little thicker than $\frac{3}{8}$ inch, but is not commonly made thinner when the bar is to be used for the ordinary purposes of bridge-work. Table 9 gives the multiple for a single equal-sided L bar, in which $t = \frac{D}{8}$. The plane of easiest flexure is on a diagonal direction.

137. **Struts of T and + Section.**—When the tee is made of equal width and depth, we may take the limiting thickness again as being

TABLE 9.—Wrought-Iron Struts—Angle Bars.

$$t = \frac{D}{8}; A = 0.234D^2 = 5.88t^2; \zeta = 5.88.$$

$$A = \frac{A_0}{2} + \sqrt{\left(\frac{A_0}{2}\right)^2 + \frac{5.88A_0L^2}{250}} = mA_0$$

Length in Feet.

Fixed ends, L=	2' 6"	5' 0"	7' 6"	10' 0"	12' 6"	15' 0"	17' 6"	20' 0"
Round ends, l=	1' 6"	3' 0"	4' 6"	6' 0"	7' 6"	9' 0"	10' 6"	12' 0"

P. in tons.	A ₀ sq. ins.	Multiple m.							
		4	1	1.13	1.41	1.75	2.11	2.48	2.85
8	2	1.07	1.24	1.46	1.70	1.94	2.20	2.46	2.72
12	3	1.05	1.17	1.33	1.52	1.71	1.92	2.13	2.34
16	4	1.03	1.13	1.26	1.42	1.58	1.75	1.93	2.11
20	5	1.03	1.11	1.22	1.34	1.49	1.64	1.80	1.96
24	6	1.02	1.09	1.19	1.30	1.43	1.56	1.71	1.86
28	7	1.02	1.08	1.17	1.28	1.38	1.50	1.63	1.77
32	8	1.02	1.07	1.15	1.26	1.34	1.46	1.57	1.70
36	9	1.02	1.07	1.13	1.23	1.31	1.42	1.53	1.64
40	10	1.01	1.06	1.12	1.20	1.29	1.38	1.49	1.59

TABLE 10.—Wrought-Iron Struts—Tee and Cruciform Section.

$$t = \frac{D}{8}; A = 0.234D^2 = 5.2t^2; \zeta = 5.2.$$

$$A = \frac{A_0}{2} + \sqrt{\left(\frac{A_0}{2}\right)^2 + \frac{5.2A_0L^2}{250}} = mA_0$$

Length in feet.

Fixed ends, L=	2' 6"	5' 0"	7' 6"	10' 0"	12' 6"	15' 0"	17' 6"	20' 0"
Round ends, l=	1' 6"	3' 0"	4' 6"	6' 0"	7' 6"	9' 0"	10' 6"	12' 0"

P. in tons.	A ₀ sq. ins.	Multiple m.							
		4	1	1.12	1.38	1.69	2.03	2.37	2.72
8	2	1.06	1.22	1.41	1.64	1.87	2.11	2.35	2.60
12	3	1.04	1.15	1.30	1.47	1.66	1.85	2.04	2.24
16	4	1.03	1.12	1.24	1.38	1.53	1.69	1.86	2.03
20	5	1.03	1.09	1.20	1.32	1.45	1.59	1.73	1.88
24	6	1.02	1.08	1.17	1.27	1.39	1.51	1.65	1.78
28	7	1.02	1.07	1.15	1.24	1.34	1.45	1.58	1.70
32	8	1.02	1.06	1.13	1.21	1.31	1.41	1.52	1.65
36	9	1.02	1.06	1.12	1.19	1.28	1.37	1.47	1.59
40	10	1.01	1.05	1.11	1.18	1.26	1.35	1.44	1.54

practically equal to one-eighth of the longest arm ; and with these proportions, the required sectional area of the strut is given in Table 10 ; which table will also apply to a cruciform section, whose thickness is one-eighth of the diameter.

The rolled cruciform section is not very frequently used in bridge-work, but the same section may be made up of four angles rivetted back to back, each angle bar having the same proportions as in No. (3) above.

138. Struts Composed of Two Tees Rivetted Back to Back.—Tee irons are frequently applied in this way for the compression members of the web-bracing, or for stiffeners to a plate web. The width of table is then very commonly made equal to twice the height, and the limiting thickness is commonly one-eighth of the depth, or one-sixteenth of the width or diameter of the strut as assumed in Table 11.

TABLE 11.—*Wrought-Iron Struts—Two Tees Back to Back.*

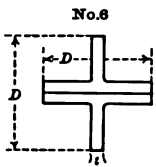
		$t = \frac{D}{16}$; $A = 0.18 D^2 = 6r^2$; $\zeta = 6.0$. $A = \frac{A_0}{2} + \sqrt{\left(\frac{A_0}{2}\right)^2 + \frac{6A_0L^2}{250}}$.							
		Length in Feet.							
Fixed ends, $L =$		2' 6"	5' 0"	7' 6"	10' 0"	12' 6"	15' 0"	17' 6"	20' 0"
Round ends, $l =$		1' 6"	3' 0"	4' 6"	6' 0"	7' 6"	9' 0"	10' 6"	12' 0"
P. in tons.	A_0 sq. ins.	Multiple m .							
8	2	1.07	1.24	1.48	1.70	1.96	2.22	2.48	2.75
16	4	1.04	1.18	1.27	1.42	1.59	1.76	1.95	2.12
24	6	1.03	1.09	1.19	1.31	1.43	1.57	1.71	1.86
32	8	1.02	1.07	1.15	1.24	1.35	1.46	1.58	1.71
40	10	1.02	1.06	1.12	1.20	1.29	1.39	1.49	1.60
48	12	1.01	1.05	1.10	1.17	1.25	1.34	1.43	1.52
56	14	1.01	1.04	1.09	1.15	1.22	1.30	1.38	1.46
64	16	1.01	1.03	1.08	1.13	1.20	1.27	1.34	1.42
72	18	1.01	1.03	1.07	1.12	1.18	1.24	1.31	1.38
80	20	1.00	1.03	1.07	1.11	1.16	1.22	1.28	1.35

139. Struts of Beam Section.—Wrought-iron beams are rolled of various sections and thicknesses ; but as before we shall take by way of example a section in which the radius of gyration is as large as it can practically be made in proportion to the sectional area. Tables 12 and 12A refer to a rolled beam whose depth is twice the width of flange, and whose thickness throughout is one-sixteenth of the depth. Of these tables, the former refers to lateral flexure, for which r_1 is the radius of gyration, while the latter refers to flexure in the plane of the depth.

TABLE 12.—Wrought-Iron Struts—Beam Section.

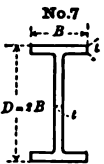

No. 7
D—tB
B
t
L

$$t = \frac{D}{16} = \frac{B}{8}; A = 0.117D^2 = 10.4r_1^2; \zeta_1 = 10.4.$$

$$= 0.8r_2^2; \zeta_2 = 0.8.$$

$$A = \frac{A_0}{2} + \sqrt{\left(\frac{A_0}{2}\right)^2 + \frac{10.4A_0L^2}{250}}.$$

Length in Feet.

Fixed ends, L=	2' 6"	5' 0"	7' 6"	10' 0"	12' 6"	15' 0"	17' 6"	20' 0"
Round ends, l=	1' 6"	3' 0"	4' 6"	6' 0"	7' 6"	9' 0"	10' 6"	12' 0"

P. in tons.	A ₀ sq. ins.	Multiple m ₁ , Lateral Flexure.							
		8	2	1.12	1.38	1.69	2.03	2.37	2.72
16	4	1.06	1.22	1.41	1.64	1.87	2.11	2.35	2.60
24	6	1.04	1.15	1.30	1.47	1.66	1.85	2.04	2.24
32	8	1.03	1.12	1.24	1.38	1.53	1.69	1.86	2.03
40	10	1.03	1.09	1.20	1.32	1.45	1.59	1.73	1.88
48	12	1.02	1.08	1.17	1.27	1.39	1.51	1.65	1.78
56	14	1.02	1.07	1.15	1.24	1.34	1.45	1.58	1.70
64	16	1.02	1.06	1.13	1.21	1.31	1.41	1.52	1.65
72	18	1.02	1.06	1.12	1.19	1.28	1.37	1.47	1.59
80	20	1.01	1.05	1.11	1.18	1.26	1.35	1.44	1.54

TABLE 12A.—Beam Section as above—Vertical Flexure.

Length in Feet.

Fixed ends, L=	5' 0"	10' 0"	15' 0"	20' 0"	25' 0"	30' 0"	35' 0"	40' 0"
Round ends, l=	3' 0"	6' 0"	9' 0"	12' 0"	15' 0"	18' 0"	21' 0"	24' 0"

P. in tons.	A ₀ sq. ins.	Multiple m ₂ , Vertical Flexure.							
		8	2	1.04	1.14	1.28	1.45	1.62	1.80
16	4	1.02	1.07	1.16	1.25	1.37	1.49	1.61	1.74
24	6	1.01	1.05	1.11	1.18	1.26	1.36	1.45	1.55
32	8	1.01	1.04	1.08	1.14	1.21	1.28	1.36	1.44
40	10	1.01	1.03	1.07	1.12	1.17	1.23	1.30	1.37
48	12	1.01	1.03	1.06	1.10	1.15	1.20	1.26	1.32
56	14	1.01	1.02	1.05	1.09	1.13	1.18	1.23	1.29
64	16	1.01	1.02	1.04	1.08	1.11	1.16	1.20	1.26
72	18	1.00	1.02	1.04	1.07	1.10	1.14	1.19	1.23
80	20	1.00	1.01	1.03	1.06	1.09	1.13	1.18	1.21

140. Struts of Channel or Double Channel Section.—Channel irons are rolled of various proportions, although the sections that are most readily obtainable in the market do not differ very greatly in their proportions of depth to width and thickness.

TABLE 13.—Wrought-Iron Struts.—Single Channel Section.

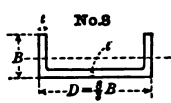

$$t = \frac{D}{16} = \frac{B}{6}; A = 0.1016D^2 = 8.8r^2; f_1 = 8.8$$

$$A = \frac{A_0}{2} + \sqrt{\left(\frac{A_0}{2}\right)^2 + \frac{8.8A_0L^2}{250}}$$

Length in Feet.

Fixed ends, L =	2' 6"	5' 0"	7' 6"	10' 0"	12' 6"	15' 0"	17' 6"	20' 0"
Round ends, l =	1' 6"	3' 0"	4' 6"	6' 0"	7' 6"	9' 0"	10' 6"	12' 0"

P. in tons.	A ₀ sq. ins.	Multiple m.							
		8	2	1.10	1.33	1.61	1.92	2.23	2.55
16	4	1.05	1.18	1.36	1.56	1.78	1.99	2.22	2.44
24	6	1.04	1.12	1.26	1.42	1.58	1.75	1.93	2.11
32	8	1.03	1.10	1.21	1.33	1.47	1.61	1.76	1.92
40	10	1.02	1.08	1.17	1.23	1.39	1.52	1.65	1.79
48	12	1.02	1.07	1.14	1.24	1.33	1.45	1.57	1.69
56	14	1.02	1.06	1.12	1.21	1.29	1.40	1.51	1.62
64	16	1.01	1.05	1.11	1.19	1.27	1.36	1.46	1.56
72	18	1.01	1.05	1.10	1.17	1.24	1.32	1.42	1.51
80	20	1.01	1.04	1.09	1.15	1.22	1.30	1.39	1.48

TABLE 14.—Wrought-Iron Struts—Two Channels Back to Back.

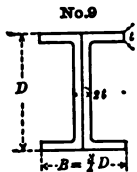

$$t = \frac{D}{16} = \frac{B}{12}; A = 0.2032D^2 = 9r_1^2; f_1 = 9.0.$$

$$= 1.5r_2^2; f_2 = 1.5.$$

$$A = \frac{A_0}{2} + \sqrt{\left(\frac{A_0}{2}\right)^2 + \frac{9A_0L^2}{250}}$$

Length in Feet.

Fixed ends, L ₁ =	2' 6"	5' 0"	7' 6"	10' 0"	12' 6"	15' 0"	17' 6"	20' 0"
Round ends, l ₁ =	1' 6"	3' 0"	4' 6"	6' 0"	7' 6"	9' 0"	10' 6"	12' 0"

P. in tons.	A ₀ sq. ins.	Multiple m ₁ , Lateral Flexure.							
		16	4	1.05	1.19	1.37	1.57	1.79	2.01
32	8	1.03	1.10	1.22	1.34	1.48	1.62	1.77	1.93
48	12	1.02	1.07	1.15	1.24	1.35	1.46	1.58	1.70
64	16	1.01	1.05	1.12	1.20	1.28	1.37	1.47	1.57
80	20	1.01	1.04	1.09	1.16	1.23	1.31	1.39	1.49
96	24	1.01	1.03	1.08	1.13	1.20	1.27	1.34	1.42
112	28	1.01	1.03	1.07	1.11	1.17	1.24	1.30	1.38
128	32	1.01	1.03	1.06	1.10	1.15	1.21	1.27	1.34
144	36	1.01	1.02	1.06	1.09	1.14	1.19	1.25	1.31
160	40	1.00	1.02	1.05	1.08	1.13	1.17	1.23	1.28

The width of flange is seldom *greater* than half the depth, and the thickness is seldom less than $\frac{1}{16}$ th. Two channels of these proportions rivetted back to back are equivalent to the four angle-irons of section No. (5), and the same multiple will then apply for flexure in the weakest direction.

But more usually the flange is about $\frac{3}{8}$ ths the depth, as shown in No. (8), and for this section Table 13 gives the multiple for a single channel, while Tables 14 and 14A refer to the lateral and vertical flexure of a strut composed of two such channels.

TABLE 14A.—Same Section as above—Vertical Flexure.

$A = \frac{A_0}{2} + \sqrt{\left(\frac{A_0}{2}\right)^2 + \frac{1.5A_0L^2}{250}}$ <p>Length in Feet.</p>									
Fixed ends, $L_2 =$		5' 0"	10' 0"	15' 0"	20' 0"	25' 0"	30' 0"	35' 0"	40' 0"
Round ends, $L_2 =$		3' 0"	6' 0"	9' 0"	12' 0"	15' 0"	18' 0"	21' 0"	24' 0"
P. in tons.	A_0 sq. ins.	Multiple m_2 , Vertical Flexure.							
16	4	1.04	1.13	1.26	1.42	1.59	1.76	1.95	2.13
32	8	1.02	1.07	1.15	1.24	1.37	1.46	1.58	1.71
48	12	1.01	1.05	1.10	1.17	1.25	1.34	1.43	1.52
64	16	1.01	1.04	1.08	1.13	1.20	1.27	1.34	1.42
80	20	1.01	1.03	1.06	1.11	1.16	1.22	1.28	1.36
96	24	1.01	1.02	1.05	1.09	1.14	1.19	1.24	1.31
112	28	1.01	1.02	1.05	1.08	1.12	1.17	1.21	1.27
128	32	1.01	1.02	1.04	1.07	1.11	1.15	1.19	1.24
144	36	1.00	1.02	1.04	1.06	1.10	1.13	1.17	1.22
160	40	1.00	1.01	1.03	1.06	1.09	1.12	1.16	1.20

It will be seen that this section resembles a rolled beam with a very thick web; and, like the rolled beam, it is much stiffer in the direction of its depth than in a lateral direction. When the strut is free to deflect in both directions, it is not necessary to take both multiples or both deflections into account, but only flexure in the weakest direction; for the effect of combined flexure in both planes, or of flexure in a diagonal direction, is included and covered in those experimental results on which Rankine's formula is based. But struts of this and other similar sections are most generally used in situations where the length l_1 for flexure in the lateral plane (B) is considerably less than the length l_2 for flexure in the other direction (D); and in such a case we should take whichever of the two multiples is the greater. Thus a vertical post 18 feet in height and carrying a load of 48 tons, may be free to deflect transversely as a hinged column, of the length $l_2 = 18$ feet, while it may perhaps be stayed longitudinally at intervals of $l_1 = 6$ feet. For the latter case

Table 14 gives a multiple of 1.24 ; while for flexure in the other direction Table 14A gives 1.34 as the multiple. The sectional area must therefore be at least $12 \times 1.34 = 16.08$ square inches ; and in general practice, the strut would then be considered stiff enough to resist flexure in either or both planes.

141. American Bridge Company's Columns.—A strut, whose radius of gyration is nearly the same in both planes, may be constructed by extending the flanges of the beam section by a pair of flat channels rivetted above and below the beam, as in No. 10, which represents a section manufactured by the American Bridge Company. This and the following built sections may easily be designed with a large diameter, unrestricted by any requirements of manufacture in rolling the component bars, or nearly so ; and thus a great resistance may be obtained against *primary* flexure, or against any flexure of the strut as a whole ; but if the section is wide and thin, we shall have to consider the contingency of *secondary* flexure or wrinkling of the component membranes, accompanied perhaps by a distortion of the cross-section.

Six of these columns, varying in sectional area from 12.5 to 20 square inches, were tested at Chicago ; and in these six the ratio ζ or $\frac{A}{r^2}$ varied from 2.27 to 2.57 and averaged 2.4 nearly. Taking this value the multiples will be those given in the following table :—

TABLE 15.—Wrought-Iron Struts—American Bridge Company's Section.

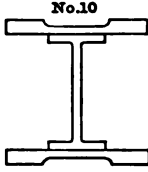
		$A = 2.4r^2 \quad \zeta = 2.4$							
$A = \frac{A_0}{2} + \sqrt{\left(\frac{A_0}{2}\right)^2 + \frac{2.4A_0L^2}{250}}$									
Length in Feet.									
Fixed ends, L =	10' 0"	15' 0"	20' 0"	25' 0"	30' 0"	35' 0"	40' 0"	50' 0"	
Round ends, l =	6' 0"	9' 0"	12' 0"	15' 0"	18' 0"	21' 0"	24' 0"	30' 0"	
P. in tons.	A ₀ sq. ins.	Multiple m.							
16	4	1.20	1.39	1.60	1.82	2.05	2.28	2.52	3.00
32	8	1.11	1.22	1.36	1.50	1.65	1.81	1.97	2.30
48	12	1.08	1.16	1.25	1.37	1.48	1.61	1.74	2.00
64	16	1.06	1.12	1.20	1.29	1.39	1.49	1.60	1.82
80	20	1.05	1.10	1.16	1.24	1.33	1.42	1.51	1.70
96	24	1.04	1.08	1.14	1.21	1.28	1.36	1.44	1.62
112	28	1.04	1.07	1.12	1.18	1.24	1.32	1.39	1.55
128	32	1.03	1.06	1.11	1.16	1.22	1.29	1.35	1.50
144	36	1.03	1.06	1.10	1.14	1.20	1.26	1.32	1.46
160	40	1.02	1.05	1.09	1.13	1.18	1.24	1.30	1.42

When tested, the strength of these columns was found to be fully up to Rankine's formula, and generally a little higher; so that the above table is experimentally substantiated for columns of 12 to 20 square inches, and may be extended to larger sizes on the same principle that experimental results are usually extended, provided that the *proportions* of the section remain the same.

It will of course be seen that if the section is made stouter in thickness the multiple for any given case will be *greater*, because the radius of gyration will be proportionately less. On the other hand, we dare not conclude that the strength may be increased by *thinning* the section and increasing its diameter; because in that case, although the radius of gyration would be proportionately larger, there would be some doubt whether this gain would not be counterbalanced by *secondary flexure* or distortion of the section. In fact the experiments show that this would be the actual result of any such alteration; for the seventh strut of the series was exactly a case in point. In this column the sectional area was 25 square inches, while the square of the radius of gyration was 18.21, so that ζ was reduced to 1.37, or considerably below the value taken in the table. But notwithstanding the large diameter and large radius of gyration this thinly proportioned column gave way at 24,000 lbs. per square inch, the strut being 26 feet in length with hinged ends; and this was the only strut of the seven which gave results considerably lower than Rankine's formula. The strut could therefore have been made stronger with the same sectional area, if the radius of gyration had been somewhat reduced by adhering to the proportions of the other examples. This shows that the sections were designed with great practical skill, and that no better results could be obtained by either increasing or diminishing the stoutness of the figure; and therefore the table represents probably the best that can be done with this form of construction for any given load and length; and a very good result it is, when the ratio of length to load is not too great.

142. American Box Section.—In America wrought-iron struts are very frequently made of box section, closed in on all sides; and although such forms are sometimes employed also in this country, yet it is generally felt that a great practical objection against them lies in the fact that the interior surface cannot be painted from time to time for the prevention of rust. Apart from this defect the form is a very good one for purposes of bridge-construction, being not only a strong section, but also a very convenient one for practical construction and for connection with other members of the bridge.

By employing very thin plates, it is obvious that this section can be built to a large diameter, even when the sectional area is very small; and thus a great stiffness may be obtained as against primary flexure of the whole strut; but in such a case it will be very necessary to inquire whether the strength is really dependent on primary flexure and equal to Rankine's formula, or whether it is limited by the resistance of the thin plates to secondary flexure or wrinkling.

Tests were made at Chicago of several of these struts constructed by the Louisville and the Baltimore Bridge Companies, and consisting of a top and a bottom plate 10 inches wide by $\frac{1}{4}$ inch thick, the sides of the box being made of a pair of channels as shown in No. (11), and 7 inches or $7\frac{1}{2}$ inches in depth. The lengths varied from 24 to 26 feet, and the tests showed that the strength was in all cases fully up to Rankine's formula, and indeed from 5 to 10 per cent. above it. In these struts the actual value of ζ or $\frac{A}{r^2}$ varied from 1.20 to 1.45, and averaged 1.30.

Taking the latter value, and assuming as before that Rankine's formula will apply to all lengths so long as the *proportions* of the section remain unaltered, the following would be the value of the multiple:—

TABLE 16.—*Wrought-Iron Struts—Lightest Box Section.*

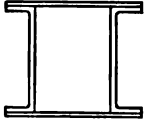
No. 11		Lightest section $A = 1.3r^2$; $\zeta = 1.3$.							
		$A = \frac{A_0}{2} + \sqrt{\left(\frac{A_0}{2}\right)^2 + \frac{1.3A_0L^2}{250}}$.							
		Length in Feet.							
Fixed ends, $L =$		10' 0"	15' 0"	20' 0"	25' 0"	30' 0"	35' 0"	40' 0"	50' 0"
Round ends, $l =$		8' 0"	9' 0"	12' 0"	15' 0"	18' 0"	21' 0"	24' 0"	30' 0"
P. in tons.	A_0 sq. ins.	Least Multiple m .							
16	4	1.12	1.24	1.38	1.53	1.69	1.86	2.03	2.37
32	8	1.06	1.13	1.21	1.31	1.41	1.52	1.65	1.87
48	12	1.04	1.09	1.15	1.22	1.30	1.38	1.47	1.66
64	16	1.03	1.07	1.12	1.17	1.23	1.31	1.38	1.53
80	20	1.02	1.06	1.10	1.14	1.19	1.26	1.32	1.45
96	24	1.02	1.04	1.08	1.12	1.17	1.22	1.27	1.39
112	28	1.02	1.04	1.07	1.10	1.15	1.19	1.24	1.34
128	32	1.02	1.03	1.06	1.09	1.13	1.17	1.21	1.31
144	36	1.01	1.03	1.06	1.08	1.12	1.15	1.19	1.28
160	40	1.01	1.03	1.05	1.08	1.11	1.14	1.18	1.26

It must be remarked, however, that although plates as thin as $\frac{1}{4}$ inch are commonly employed for bridge purposes, yet most engineers would strongly prefer a greater thickness when the plate cannot be painted on both sides; and in this case the above table would not apply except perhaps for the larger sizes. But, on the other hand, if the strut is a large one, the channel iron sides might with advantage be replaced by plate and angle-irons, as in No. (12), which represents a form of strut frequently used in America for the bracing of large girders, and sometimes for the wrought-iron piers of high viaducts or bridges. In the sections used for these purposes, it would appear that the value of ζ or $\frac{A}{r^2}$ is

seldom less than 2.40, so that the multiple m is not generally less than the value given in Table 15, and is often much greater; and there can be no doubt that a good substantial thickness of plate is always to be desired when it is consistent with a fairly good working strength; but for the economic construction of very long struts under a comparatively light load, it will be necessary to adopt the *thinnest* plates and angles that will be consistent with durability and with such a degree of stiffness *as will develop the full strength of the section*. With these objects in view it appears that a value of $\zeta = 2.0$ may be taken as being nearly the minimum for this form of construction, and assuming this value the multiples will be as shown in Table 17.

TABLE 17.—Wrought-Iron Struts—Box-Girder Section.

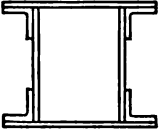
No. 12		Min. $\zeta = \frac{A}{r^2} = 2.0$.							
		$A = \frac{A_0}{2} + \sqrt{\left(\frac{A_0}{2}\right)^2 + \frac{2A_0L^2}{250}}$.							
Length in Feet.									
Fixed ends, L =	10' 0"	15' 0"	20' 0"	25' 0"	30' 0"	35' 0"	40' 0"	50' 0"	
Round ends, l =	6' 0"	9' 0"	12' 0"	15' 0"	18' 0"	21' 0"	24' 0"	30' 0"	
P. in tons.	A ₀ . sq. ins.	Multiple m .							
16	4	1.17	1.34	1.52	1.72	1.93	2.14	2.36	2.79
32	8	1.09	1.19	1.31	1.44	1.57	1.71	1.86	2.16
48	12	1.06	1.13	1.22	1.32	1.42	1.53	1.65	1.88
64	16	1.05	1.10	1.17	1.25	1.34	1.43	1.52	1.72
80	20	1.04	1.08	1.14	1.21	1.28	1.36	1.44	1.62
96	24	1.03	1.07	1.12	1.18	1.24	1.31	1.39	1.54
112	28	1.02	1.06	1.10	1.16	1.21	1.27	1.34	1.48
128	32	1.02	1.05	1.09	1.14	1.19	1.25	1.31	1.43
144	36	1.02	1.05	1.08	1.12	1.17	1.22	1.28	1.40
160	40	1.02	1.04	1.07	1.11	1.16	1.20	1.26	1.37

At the risk of repetition, it may be well to remark again that the object here is to find the lightest or most economic section for *long* struts under a *small* load. When the load is large in proportion to the length a more substantial section would generally be preferred, and the multiple would then be considerably higher; but this would be of no consequence, as the multiple in that case would still have a moderate and tolerably economic value. With this view Table 16 represents the very lowest values of the multiples that can be obtained with the box section, while Table 17 represents a more practical minimum, and Table 15 the average of ordinary practice.

To show that nothing can be gained by any farther reduction of thickness, reference may be made to Mr. Hodgkinson's experiments¹ with square tubes varying from 4" × 4" to 8 $\frac{3}{8}$ " × 8 $\frac{3}{8}$ ". In the 4-inch or 4 $\frac{1}{4}$ -inch tubes the thickness varied from .03 inch to .134 inch, or from $\frac{1}{133}$ to $\frac{1}{32}$ of the width; and the ratio $\frac{A}{r^2}$ was from 0.18 to 0.91. In the 8-inch or 8 $\frac{3}{8}$ -inch tubes the thickness varied from .06 inch to .22 inch, or from $\frac{1}{133}$ to $\frac{1}{40}$ of the width, and the ratio $\frac{A}{r^2}$ was from 0.19 to 0.70.

Struts of each section and 10 feet long were tested, while some tests were made with lengths of 5 feet and 2 ft. 6 ins.; and it was found that the strength did not depend so much upon that primary flexure of the whole strut which is allowed for in Rankine's formula, as it did upon the secondary flexure or wrinkling of the thin plates, and was almost as low in the shortest struts as in the longest; and Mr. Hodgkinson himself points out that the strength is influenced by two independent laws relating to the primary and the secondary flexure respectively; but the laws relating to secondary flexure have not been determined with sufficient accuracy for any practical purposes, and it would require a great many more experiments before this could be done. It is hardly necessary, therefore, to repeat the detailed results of these tests, which have been frequently quoted in engineering text-books. The conclusion drawn from them by Professor Rankine and some other authorities, is that when the thickness of plate is not less than $\frac{1}{30}$ th of the width, a breaking weight of 27,000 lbs. per square inch may be relied upon. But the questions that we have to deal with are these—having to design a strut of box section for a given load and length, what are the proportions that will give the greatest strength? and how far may we go in the direction of increasing diameter at the expense of thickness? To these questions Mr. Hodgkinson's experiments appear to give a perfectly conclusive answer, so far as can be judged from the small scale of their actual dimensions; for the general result appears to be that the further we go in this direction the less strength do we get out of a given sectional area. The Chicago experiments have shown what strength can be obtained by adopting the comparatively stout and substantial section of No. 11; and as compared with this standard the strength of Mr. Hodgkinson's cells was in every case very small, notwithstanding their greater diameter; and in many cases the strength of these wide and thin tubes was only a *small fraction* of what might have been obtained from the same metal by making the tubes narrower and thicker.

It may be expected theoretically that in the case of very long columns, the reduction of strength due to primary flexure would be so great, that at a certain point perhaps a wider and thinner section would become the stronger; and certainly it would be in very long columns, if anywhere,

¹ *Vide* Report of the Commission on the Use of Iron in Railway Structures.

that the advantage of Mr. Hodgkinson's wide and thin tubes ought to manifest itself.

But taking the most favourable case for this purpose, viz., the columns of 30 diameters included in Mr. Hodgkinson's tests, it appears that the strength per square inch was from 20 to 40 per cent. less than might have been obtained from a narrower column of the same length and sectional area proportioned as in No. 11, whose diameter would then be less than $\frac{1}{10}$ th of the length; and the thinner the plate, or the smaller the value of ζ , the greater was the loss of strength per square inch.

143. Hollow Cylindrical Struts.—It was remarked in the last chapter that a hollow cylindrical section, which is equally stiff in all directions, and in which the ratio $\frac{y}{r}$ is less than in any other continuous or solid section, may reasonably be expected to exhibit a high resistance, and one that approaches nearer to the strength of the ideal column than in most other forms of construction. Accordingly we find that the experimental strength of these struts is sometimes considerably above Rankine's formula, as may be seen by reference to the individual tests shown in Fig. 152. In fact, this is precisely a case where Rankine's formula begins to differ somewhat from the results of experiment, and also from the theoretical results found in the last chapter.

But at the same time it will be seen that, although the Phoenix columns are in every case high above the curve, yet several of the tubes tested by Mr. Hodgkinson are far below it. These latter experiments¹ were made with wrought-iron cylindrical tubes varying from $1\frac{1}{2}$ inch to 6 inches in diameter, and from 2 ft. 4 ins. to 10 ft. in length; while the thickness of the tubes varied from $\frac{1}{10}$ th to $\frac{1}{8}$ th of the diameter. The shortest tubes gave way at a crushing stress of $f=36,000$ to $48,000$ lbs. per square inch, a result which needs no comment except that the crushing took the form of a secondary flexure or a wrinkling or bulging of the thin plate. But referring to the longer tubes, and analysing the individual tests according to the ratio of thickness to diameter, it is somewhat remarkable that the thinnest tubes exhibited the most uniform results, and that when the thickness was from $\frac{1}{8}$ th to $\frac{1}{10}$ th of the diameter, the strength was in every case tolerably close to Rankine's formula; but with greater thicknesses, viz., from $\frac{1}{8}$ th to $\frac{1}{10}$ th of the diameter, the experiments were more discordant, and the strength varied from 30 per cent. above to 20 per cent. below Rankine's formula, as shown by the widely straying circles upon Fig. 152.

Mr. Christie's experiments, which were made with welded tubes $1\frac{1}{2}$ inch to $3\frac{1}{2}$ inches diameter, and of considerable thickness, exhibited results that were even more discordant;² and the only conclusion to be drawn is that in these cases the strength of the column must have been governed by

¹ *Vide* Report of the Commission on the Use of Iron in Railway Structures.

² *Vide* Transactions of the American Society of Civil Engineers, 1884.

some other cause than those that have been considered, and possibly by some local inequality of strength at the welded joint.

It would hardly be safe to conclude from these experiments that the minimum economic thickness for long struts is $\frac{1}{80}$ th of the diameter for 6-inch tubes; and it would be still more rash to infer that the same proportion would hold good for very large tubes without internal or external stiffeners; and therefore in default of more varied experiments it will be useless to calculate the multiple for an assumed thickness of metal.

The student can judge for himself what working stress would be justified by the experiments shown in Fig. 152; and in any calculation for which the radius of gyration is required, the following geometric method will furnish an easy solution for any given section.

In Fig. 158, draw the vertical diameter ab , intersecting the outer circumference in a , and the horizontal diameter cd , intersecting the inner surface of the tube in d , and join ad ; then the radius of gyration is one half of the length ad .

A very strong and well-supported form of strut is obtained in the

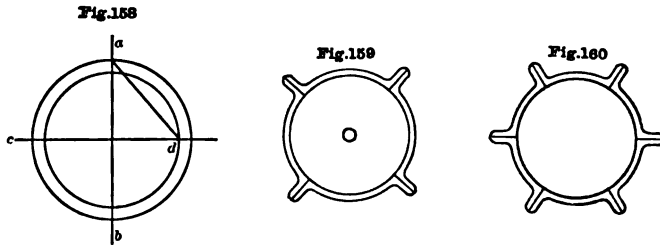

“Phoenix Column,” which is rolled in segments with longitudinal flanges and rivetted together; the segments are generally either four or six in number, as shown in Figs. 159 and 160.

These struts exhibit no such discordant results as those obtained with welded tubes, and owing either to the uniformly good quality of the metal or to the admirable form of the section, their strength is found to be considerably above Rankine’s formula, and would be more justly represented by formula (12), Arts. 116 and 117, in which f may be about 40,000 lbs. and $\phi = 0.30$ as a lower limit.¹

The columns tested at Chicago were about $8\frac{1}{4}$ inches diameter of cylinder and $\frac{5}{16}$ inch thick, the width over the flanges being $11\frac{3}{4}$ inches. This would give $\frac{A}{r^2} = 1.50$; but it is probable that with larger sizes the thickness would not require to be increased in the same proportion (so far as strength is concerned); and if we take for moderate sizes the

¹ If ϕ is taken at its proper value of 0.30 for the tubular section, and if the modulus E is taken at its actual value as ascertained for each column, it will be found that Formula (12) expresses the true strength of the Phoenix column within a small percentage of the results of the Chicago tests.

value $\zeta = 1.3$ as in Table 16, it would appear from the Chicago experiments that the multiples given in that table would apply to the Phoenix column when the load P is increased by 7 to 15 per cent. above the weights given in the first column of that table.

Hollow tubes of very large diameter have sometimes been employed for the compression members of long-span bridges, the shell being stiffened internally by longitudinal and transverse ribs or diaphragms. Thus the main compression member of the Saltash Bridge was formed of an elliptical tube, whose major and minor axes were 16 ft. 9 ins. and 12 feet respectively; the tube being stiffened internally by six longitudinal ribs and by transverse diaphragms spaced at distances 20 feet apart. This tube acts practically as an arched strut, bearing a nearly constant compressive stress from end to end; while as an example of compression members under a varying stress, we may mention the cantilevers of the Forth Bridge, in which the tapering steel tubes vary from 12 feet to 5 feet in diameter, and are stiffened internally by longitudinal and transverse stiffeners.

Further experiments are needed to determine the limiting ratio of thickness to width of unstayed surface in tubes of this construction, and also to determine the necessary section and strength of the stiffeners.

144. Braced Struts.—The economic construction of long struts is certainly facilitated by the adoption of the tubular form, but when the load is light it will often be necessary either to employ a smaller diameter than we should otherwise wish, or else to use plates much thicker than are theoretically required. Moreover, the tubular form gives rise to a good deal of trouble in the connections, and it is difficult to arrange the junction of two or three members at a panel point in such a way as to distribute the resultant pressure fairly over the whole circular section of each cylindrical strut.

For the construction of light compression members, American and continental engineers have generally preferred to adopt an open braced form of strut constructed like a lattice-girder to resist transverse bending; and when this is done, the liability to primary flexure of the whole column, and to secondary flexure of its component members, may be calculated upon tolerably safe grounds.

Primary Flexure.—Let Fig. 161 represent the half elevation of a braced strut with a Warren web, and if the strut is free to turn at the ends or not rigidly fixed in direction, let l denote the total length, and d the depth of the girder-shaped strut measured between the centres of gravity of the two flanges. Then the flanges being comparatively thin, the radius of gyration will be $r = \frac{d}{2}$; and as shown in the last chapter,

Art. 116, the maximum flange-stress due to bending moment will be $\pm f_1 = \frac{\phi p^2}{\rho - p}$, in which p is the apparent stress due to the direct compressive force or load upon the column; while it was also shown that the

flange-stress, being everywhere proportional to the deflection, is proportional to the ordinates of the curve of sines, which for this purpose may be taken as equivalent to the parabola.

Therefore making DB in Fig. 161*b* to represent the flange stress f_1 , we may draw the parabolic segment ABD as a diagram of stress due to

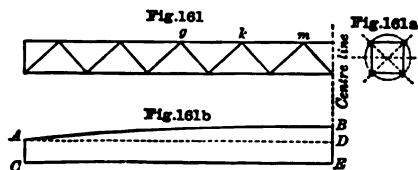

the bending moment; and making $AC = DE$ to represent the direct stress p , we shall have the figure $ABEC$ as a diagram of the compressive stress to which either limb of the strut is liable.

Taking this diagram as exhibiting the necessary sectional area of the limb, it is evident that AC represents the minimum area A_0 (for short struts), while BE denotes the sectional area A which is required for a strut of the given length l ; so that $\frac{BE}{DE}$ represents the "multiple" which we have already found for other forms of construction.

In the case of the braced strut, however, we are at liberty to adopt any depth we please without entailing a proportional increase of sectional area, and for different ratios of length to diameter the multiple will be as follows:—

TABLE 18.—*Wrought-Iron Braced Struts.*

Ratio of Length to Depth.

Fixed ends, $\frac{L}{d} = . . .$	20	25	30	35	40	45	50	60
Hinged ends, $\frac{l}{d} = . .$	12	15	18	21	24	27	30	36
Multiple for Primary Flexure m_a .								
By Rankine	1.04	1.07	1.10	1.14	1.18	1.23	1.28	1.40
By formula (13)	1.08	1.06	1.08	1.12	1.16	1.21	1.27	1.40

If the strut is equally liable to flexure in both directions, it is generally braced in both planes, the four limbs being placed at the four corners of a square, as in the cross-section Fig. 161*a*, and braced together on all four sides of the square. The stiffness of the strut is then nearly the same in all directions, the radius of gyration being equal to $\frac{d}{2}$, whether the neutral axis is taken parallel to the sides or in a diagonal direction; and it may be remarked that the strut has theoretically the same stiffness as a thin cylindrical shell of the same sectional area whose diameter is equal to

the diagonal of the square. The liability to flexure in a diagonal direction is covered by the multiples given in the above table. In the case of a strut with hinged ends, the multiple gives the maximum sectional area required at the centre, which may be reduced at the ends to the area $A^0 = AC$ in the figure; and some such reduction is frequently made in practice; but if the ends of the post are fixed, it will of course be understood that the greatest bending stress occurs equally at the ends and in the centre of the length, and the sectional area will then be made uniform throughout.

Secondary Flexure.—Treating each limb of the structure as an independent strut, which is held in line at the points of connection g, k, m , &c., but is free to deflect between those points, it is easy to see that the secondary flexure must take place in a sinuous curve, as shown in Fig. 162, the curve of sines being continued from point to point, and the ordinate y having alternately positive and negative values.

Therefore in all such cases the limb must be considered as a rounded-end strut, whose length l is equal to the distance gk between the points of support.

Each of the four limbs may consist of either of the rolled sections which have been already examined in this chapter, and it only remains to consider how the combined liability to primary and secondary flexure should be treated. Taking for each leg one-fourth of the gross load P_a , we may perhaps consider that the greatest compressive force acting in the line gk will be $P = \frac{P_a m_a}{4}$, and using this value of P we may take from the tables the multiple giving the required sectional area of the limb. This would be a very safe method, but would give more strength than is really necessary, because with a working load of only one-fourth the breaking weight, the primary deflection and bending stress will be much less than one-fourth the ultimate deflection, and therefore the working load P in each limb will never reach the value above taken, and will not be very much greater than $\frac{P_a}{4}$.

For practical purposes it will generally be sufficient to take the larger multiple of the two, and add one-fourth of the percentage indicated by the lesser multiple; thus if the multiple m for secondary flexure is the larger, it will be enough to make the gross area $A = A_0 \left(m + \frac{m_a - 1}{4} \right)$; or perhaps more correctly $A = A_0 m \cdot \frac{3 + m_a}{4}$.

Secondary Bracing.—The shearing stress due to the buckling tendency may be found from the diagram, Fig. 161*b*, on the principle already mentioned in Chapter VI., Arts. 59 and 61; and in the case of a very long strut it will be seen that all the stresses in flanges and diagonals are similar to those in a Warren girder under a uniform load; but with more moderate proportions of strut, the resulting stress in the diagonals will be very

light, and will often form only a small part of the stress which they have to undergo in the performance of other and quite different duties. If the parallel limbs of the strut are united by transverse ties and double bracing, as in Fig. 149, the bracing will partake in the general compression of the whole strut, and the resulting stress (which may be computed)

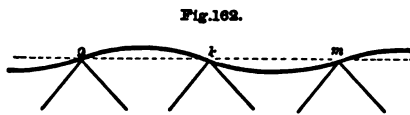

will be so much taken off from the parallel limbs. On the other hand, if the diagonals in that figure are only capable of acting as ties, they will become loosened when the strut is compressed, unless indeed they are at first screwed up with an initial tension, which would add to the compressive stress in the parallel limbs.

If Warren bracing is employed, as in Fig. 161, these effects cannot take place; but each diagonal will then be liable to either a tensile or a compressive stress, according to the direction in which the strut begins to bend.

The stress in these diagonals of the secondary bracing, so far as it is due to the shearing force, will of course be greatest at the ends

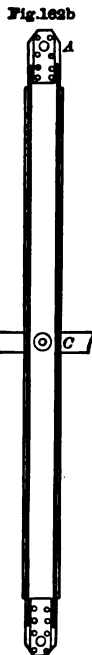
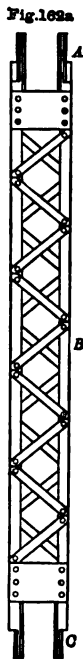

of the principal strut, decreasing to nothing at the centre; but the greatest theoretical stress will often be so light that the theoretical section must be largely increased in practice. The diagonals are generally made of flat bars, in which the proportion of thickness to width is much more unfavourable than in Table 8, but a glance at the first line of that table is sufficient to show that a very large multiple would be necessary. For the same reason it is not generally practicable to make the central diagonals any smaller than the section determined for those at the ends; and however light the stress may be, the bars are seldom made with a smaller section than about 0.7 square inch.

Struts Braced in one Direction only.—In bridge-construction a very frequent use is made of struts which are braced only in the lateral plane, the strut being composed of two channels or two beams united by lateral bracing as shown in Figs. 162a, 162b.

The channels or beams are placed with their webs in the principal plane of the main structure, so that their greatest stiffness is available against flexure in that plane; while the stiffness of the braced strut as against lateral flexure is represented by the stiffness of the lattice-girder in which the channels form merely the flanges. By adopting a liberal width in the lateral plane, the stiffness in this direction may easily be made so great that the strength will hardly be affected by

lateral flexure, and will depend only upon the stiffness of the channel bars in the plane of their depth. Accordingly this construction is very often used for the posts of large girders, which are often stayed in the middle of their length by the diagonal ties of the lattice bracing, as shown in the figure; so that the effective length of the strut as regards flexure in the principal plane is only one-half of the total height of the post.

In estimating the comparative economy of this type of construction, or in making a provisional estimate of its weight for any purpose, we must of course add the weight of the secondary bracing after finding the required multiple for the channel-bars or beam irons as given in Tables 12A and 14A. This being done, we may express the effective gross section of the strut as a multiple of the net theoretic section A_0 ; so that having found the standard sectional area A_0 (at 4 tons per square inch), the effective section of the entire strut shall be expressed by mA_0 , which will represent the sectional area of a prism having the same weight as the entire strut, including the secondary bracing.

Table 19 gives an approximate estimate of the multiple m for the type of construction shown in Figs. 162a, 162b, the length for flexure being the length AC .

TABLE 19.—*Wrought-Iron Struts—Two Channels united by Secondary Bracing.*

PROPORTIONS OF CHANNEL-BARS THE SAME AS IN TABLE 13.									
Length for Flexure in Plane of Channels.									
P. in tons.	A_0 . sq. ins.	6' 0"	9' 0"	12' 0"	15' 0"	18' 0"	21' 0"	24' 0"	30' 0"
		Multiple m .							
16	4	1.67	1.80	1.96	2.13	2.30	2.50	2.68	3.08
32	8	1.36	1.44	1.53	1.66	1.75	1.88	2.00	2.36
48	12	1.29	1.34	1.41	1.49	1.58	1.67	1.77	2.06
64	16	1.23	1.27	1.32	1.39	1.46	1.53	1.62	1.88
80	20	1.20	1.23	1.28	1.33	1.39	1.45	1.54	1.75
96	24	1.18	1.21	1.25	1.30	1.35	1.40	1.50	1.70
112	28	1.16	1.19	1.23	1.26	1.31	1.37	1.45	1.65
128	32	1.15	1.17	1.20	1.24	1.29	1.35	1.42	1.58
144	36	1.14	1.16	1.18	1.23	1.27	1.33	1.40	1.53
160	40	1.12	1.14	1.17	1.21	1.26	1.32	1.38	1.50

145. **Strut Exposed to the Action of Lateral Forces.**—In addition to the stresses due to the buckling tendency, the strut will sometimes be subjected to a transverse bending strain arising from the action of lateral forces. Thus the braced piers of a lofty viaduct are subject to a severe bending stress due to wind pressure; and in the same way every strut that is used as a girder to resist lateral pressure or to

stiffen the entire structure as against lateral forces, will be subject to stresses which are quite separate from those above considered, and must be separately allowed for. When the strut is hinged at both ends, the forces acting upon other portions of the bridge cannot produce a bending strain in the strut; but even then it should be strong enough to resist those lateral forces which may act upon the strut itself. For example, if it lies in a horizontal position it will at least have to carry its own weight, and when we consider that some of the members in a large bridge may thus be in the position of girders of 100 feet span or upwards, and of comparatively small depth, it is evident that the stresses due to their own weight cannot be neglected.

Of course if the strut stands in a vertical position, its weight cannot act as a transverse bending force; but even in this case the strut will, at least, be exposed to a horizontal wind-pressure; and if the wind-pressure is taken at 56 lbs. per square foot, this transverse force will amount to almost as much as the *weight* of a lightly-built strut.

It appears reasonable therefore that, in every strut, sufficient metal should be added (in flanges and secondary bracing) to carry, as a girder, the weight of the strut itself, apart from the metal required for resisting the proper compressive stress; and such an allowance would accord pretty nearly with the views of Mr. Shaler Smith, who recommends the adoption of a varying factor of safety increasing with the length of the column.

When the strut is of moderate length, as in the cases considered in the foregoing tables, neither the weight of the strut nor the wind-pressure acting upon its surface, will produce any serious bending stress; and if we wish to make the allowance above mentioned, it will only be necessary to add a small percentage to the multiples given in the tables. For a length of 30 feet the allowance need not be more than 8 per cent.; and this may be reduced to 4 per cent. for a length of 20 feet, and may be disregarded in the case of still shorter columns. But in long span bridges, we may frequently have struts of 100 or 150 feet in length, which will generally be braced in both planes; and for such cases the stresses due to the weight of a horizontal strut or the wind-pressure upon a vertical strut must be much more liberally allowed for.

146. The Practical Weight of Struts.—In estimating the total practical weight of a strut per foot lineal, we must allow also for the following items:—

1st. We cannot always get exactly the section that we want, because angles, tees, and channels are only rolled to certain thicknesses, increasing by $\frac{1}{8}$ th of an inch; and for this reason we may have to add from 3 to 7 per cent. to the calculated area.

2nd. In all built or rivetted sections we should add about 4 per cent. for the weight of the rivet-heads.

3rd. When the length is greater than about 24 or 30 feet, we must add from 7 to 11 per cent. for the weight of cover plates at the joints.

In all cases the sectional area found by calculation may be taken

as the *gross* area of the section, so that no addition need be made for any loss of section at the rivet-holes.

Making these several allowances, the gross weight of struts may be represented by a diagram, or a series of diagrams, such as those contained in Plate G, which refer to struts designed to carry a load varying from 32 to 160 tons. The ordinates in each case denote the multiples which must be applied to the net sectional area A_n , in order to give the gross effective section, including secondary bracing, &c., or in order to give the sectional area of a prismatic solid whose weight per foot is equal to the weight of the actual structure; while the abscissæ denote the length in feet of a strut with hinged ends. These diagrams can only be taken as a rough approximation, and chiefly as giving a general view of the relative usefulness of the different forms of construction before considered, exclusive of circular sections.

There are of course many other forms which might be considered; and, as before mentioned, there is no difficulty in designing a compression member when the load to be dealt with is large enough to admit of the employment of more complex, stiffened, or cellular structures; but the diagrams will give a general idea of what may be done under the opposite conditions; and for such cases the ordinates may be taken as representing the multiple κ to be used in the calculation of weights referred to in Chapter VII. Art. 67,—exclusive of any overlap at the ends.

The line marked "Braced Struts" refers to struts which are braced in both planes.

147. The Compression Flange of Girders.—In designing the upper chord or flange of a girder, there is generally no difficulty in obtaining a liberal width and depth of section, without waste of metal, except perhaps at the ends of a parallel girder where the stress is very small. In practice the *form* of section must depend in great measure upon the intended construction of the web bracing, and must be adapted for connection with the members of that bracing.

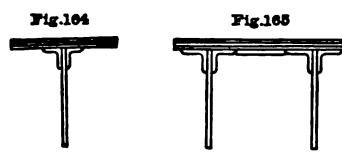
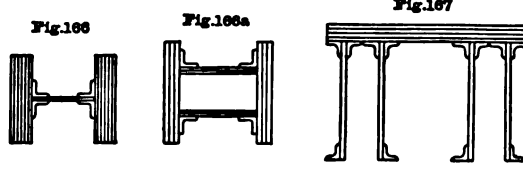

Fig. 164 represents a cross section which is commonly used in girders with a single web of plate or close lattice bracing, the lattice bars being rivetted on each side of the vertical fin.

The trough section illustrated in Fig. 165 is often used for double-webbed lattice girders, while Figs. 166, 166a, and 167 represent the upper chords of some large American bridges.



As regards the buckling tendency, the upper flange of a girder is

always held in line, in the vertical plane, by the points of connection of the web bracing; and if overhead wind bracing is employed, it is similarly supported in the horizontal plane; so that the "length for flexure" is generally not very large in comparison with the width and depth of the member. For these reasons it is a common practice to disregard the buckling tendency altogether, and to adopt the full working stress, which may be 4 or sometimes $4\frac{1}{2}$ tons per square inch for wrought-iron girders; but although this practice will be perfectly safe in the case of broad and substantial sections, or when the member is supported at short intervals in the horizontal as well as in the vertical plane, yet it is quite certain that when these conditions are reversed, such a practice must be eminently dangerous.

If this were not abundantly clear from the calculations contained in this and the preceding chapter, it might be proved by reference to the case of two or three modern bridges which have actually collapsed under the test load by the buckling of the compression members; and these examples illustrate not only the inadequacy of a prescribed uniform standard of working-stress, but also the entire inadequacy of the deflection test as a proof of strength. In one or two of these cases, at least, it is known that the working-stress in compression was not in excess of the regulation standard, and was not in fact more than about 4 tons per square inch; while the recorded deflection of the girder was less than the amount which had been specified for the test load. But immediately after this satisfactory deflection had been measured and noted, the bridge collapsed before the further testing could be completed. These cases of actual failure speak for themselves, but in how many cases the stress may be within 10 per cent. of the breaking point, nobody can tell.

148. Effective Length for Flexure.—It is not always an easy matter to decide what is the effective length l (or length of the equivalent round-ended strut) in any given case; but it is obvious that the calculated strength will depend upon this quantity, and there are certain plain principles which will help us to determine it.

It often happens that although the ends of a strut are fixed in some other part of the structure, yet the actual value of that fixity is open to question. Now referring to the diagram for fixed-ended struts, Fig. 157, it is clear that the bending moment FK , or $P \times FK$ (which is supposed to operate like the pier moment of a continuous girder), cannot really take effect in the strut unless that moment is resisted by the inherent fixity of the body that holds the end of the strut—and it must not only be resisted, but resisted without any sensible yielding or rotation of the body.

Therefore in the case of a vertical post fixed to the upper and lower flanges of a girder, as in Fig. 168, it will not be safe to take the length l as anything less than the entire length of the post; for it is well known to every one who is accustomed to the erection of ironwork, that the resistance offered by such flanges to a twisting strain is exceedingly small,

and totally insufficient to afford any rigid hold upon the strut—of the kind that would be required. The strut is nominally fixed at the ends; but it is fixed in a body which is quite incapable of holding its own position.

The case, however, would be quite altered if the post were rigidly united to a cross girder by means of corner gussets as in Fig. 169. In this case we may consider the strut as fixed at the lower end and free to turn at the upper end, and the length l may then be taken at about $\frac{3}{4}$ ths or $\frac{5}{10}$ ths of the total height; but at the same

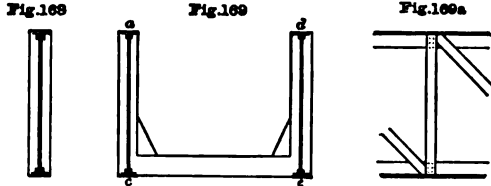

time provision must be made for the additional stress which may be due to its action as a stiffener, or as part of the U-shaped girder *aced*.

Again, it is pretty clear that if the post is firmly rivetted to a pair of deep and stiff girder flanges, as in Fig. 169a, its ends will be rigidly held against flexure *in the plane of the girder*, by reason of the great stiffness of the flange in a vertical direction, so that the length for flexure in a longitudinal direction would theoretically be not more than $\frac{1}{10}$ ths of the height. But here again it may possibly be necessary to have some regard to the reverse bending strains which would take place in the post during the deflection of the girder.

Pin Connections.—American engineers have generally held the opinion that the last-named bending strains are entirely avoided by the use of pin connections; and there can be no doubt that this form of connection obviates the contingency of many such strains, which may easily arise from imperfect adjustment during the erection of the ironwork. The recent experiments of Mr. Christie, however, have shown that the frictional resistance of close-fitting pins is, as might be expected, very considerable, and in some cases is sufficient to hold the end of the strut, which then behaves exactly as a strut with fixed ends. The frictional resistance of the joint is of course generally proportional to the load P , and its moment will be equal to P multiplied by an arm which is a certain fraction of the pin's radius. So long as the deflection FK in Fig. 157 is less than the length of this arm, the strut will be held by the friction of the joint; but when the deflection FK exceeds that length, the strut may be expected to spring suddenly round and assume the curvature of a round-ended strut, or nearly so; and this is exactly what it did in the experiments referred to.

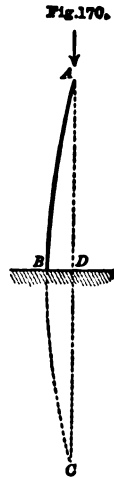

It is hardly necessary to mention that when the tight-fitting pins were eased with a file and lubricated, the holding power of the joint was very

greatly reduced ; and although Mr. Christie's experiments show that struts with dry pin connections are considerably stronger than those with round ends, yet it is very questionable whether we can safely rely upon a source of strength which may disappear with the accidental introduction of a little oil in the joint. We shall do well, therefore, to take the whole length from centre to centre as the effective length l for struts with pin connections.

Braced Piers.—In the case of an iron pier fixed at the base and carrying a load upon its top, the deflection must take place as in Fig. 170, the line of pressure AD being no longer a chord to the curve AB , but a vertical line ; so that the effective length AC for flexure will be $l = 2L$, or twice the height of the pier.

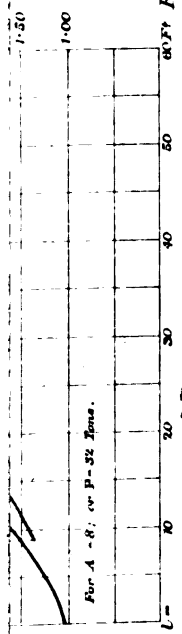

Fig. 1633

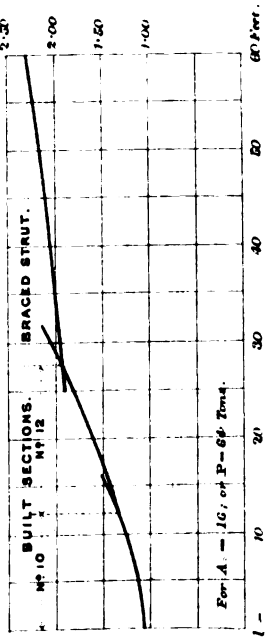

Fig. 1634

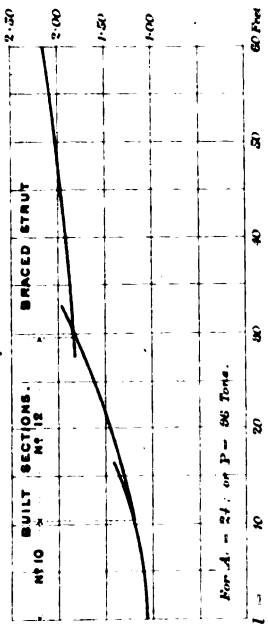

Fig. 1635

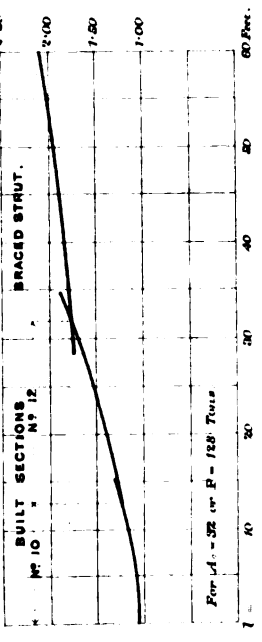
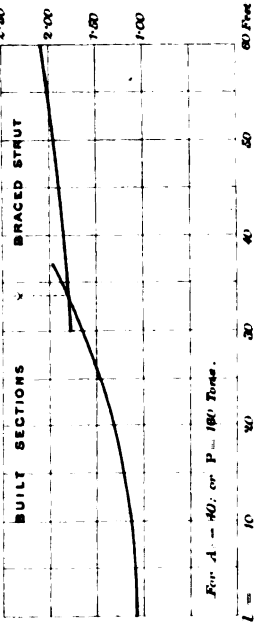
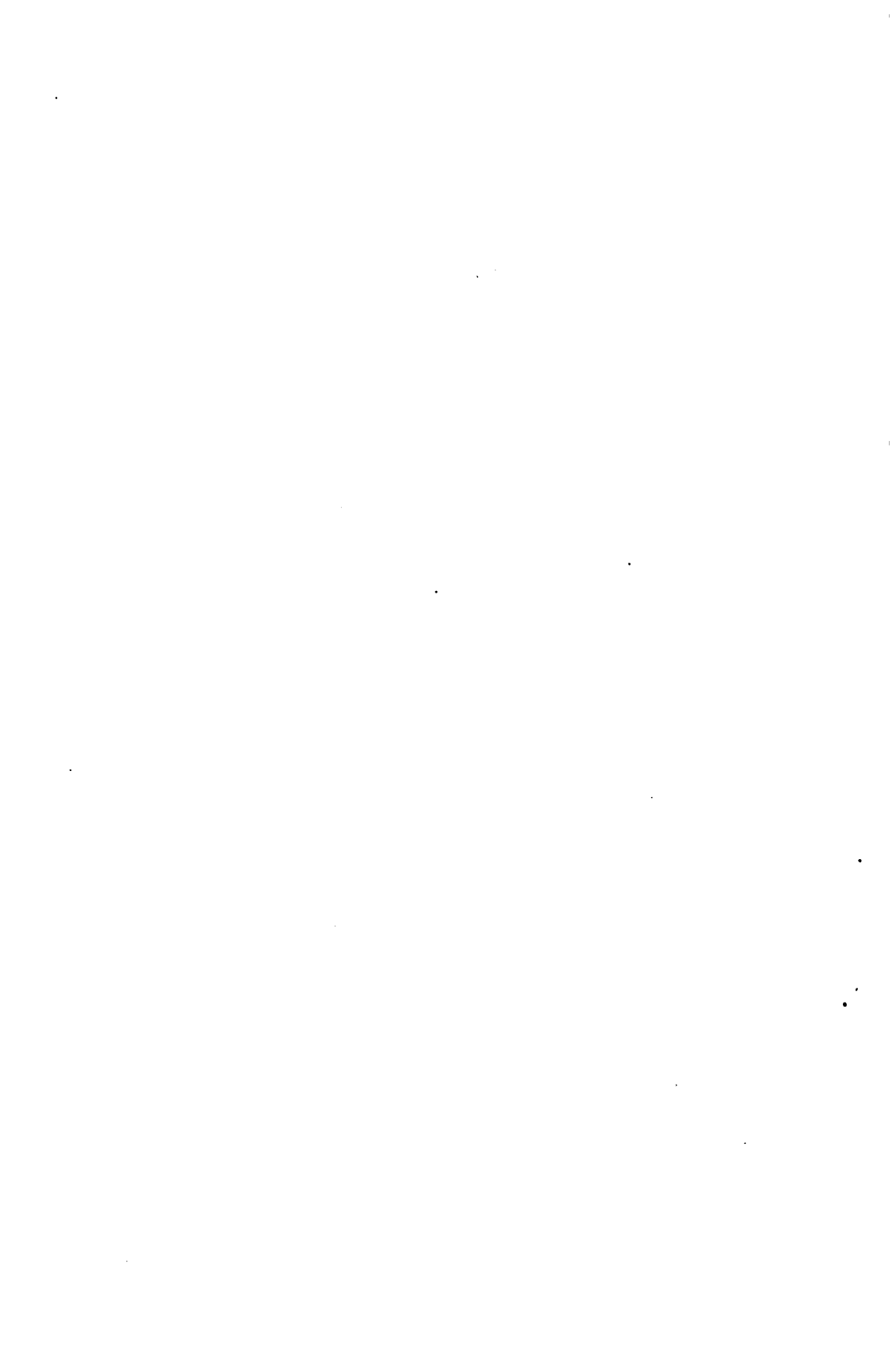

Fig. 1636





CHAPTER XII.

THE STRENGTH AND CONSTRUCTION OF TIES.

149. Tensile Strength.—The ultimate strength or tenacity of materials, under a direct and steady pull, admits of being easily measured by experiment and defined with a tolerable degree of accuracy. It is true that the strength depends partly upon the form of the specimen, the presence or absence of sharp changes of section, and some other modifying conditions; but the influence of these conditions has been pretty closely observed, and the results obtained from the enormous number of experiments that have been already made will afford an amply sufficient and reliable guide for most of the purposes of ordinary bridge-construction.

This is at least true for wrought iron, and although steel has from time to time exhibited a capriciousness of behaviour which is often remarkable and sometimes unaccountable, yet it must be remembered that the use of this material for constructive purposes is of comparatively recent date, while the conditions requisite for its successful production, manufacture, and employment, are every day becoming better known and more accurately appreciated.

150. Tensile Strength and Ductility of Wrought-Iron Bars and Plates.—It is not necessary here to examine the countless tests that have been made to ascertain the ultimate strength, the ultimate elongation, and the reduction of fractured area, in specimens of wrought iron produced in different localities or by different makers. For the present purpose it will be sufficient to notice the broad results of 587 experiments made by Mr. Kircaldy, as shown in the following table:—

TABLE 1.—*Tensile Strength of Wrought Iron.*

Number of Experiments.	Breaking Weight per Square Inch of Original Area.					
	Highest.		Lowest.		Mean.	
	Lbs.	Tons.	Lbs.	Tons.	Lbs.	Tons.
188 bars rolled	68,848	= 30·7	44,584	= 19·9	57,555	= 25·7
72 angles and straps	63,715	= 28·5	37,909	= 16·9	54,729	= 24·4
167 plates, lengthwise	62,544	= 27·9	37,474	= 16·7	50,737	= 22·6
160 do. crosswise	60,756	= 27·1	32,450	= 14·5	46,171	= 20·6

As regards the ultimate elongation it may be remarked that although the whole length of the bar is often permanently stretched to a considerable degree, a great part of the observed elongation in short test pieces is due to the local drawing out of the material at the weakest or most ductile point, and is generally confined to a small portion of the length, and accompanied by a corresponding contraction of the sectional area. In tough and ductile iron, the ultimate stretch for a 10-inch test bar may frequently amount to 26 per cent., while the accompanying contraction of area may be 50 per cent. of the gross original section; so that the stress which finally fractures the bar at the contracted neck, may be twice as intense as the apparent breaking weights given in the table, and may often amount to 40 or 50 tons per square inch of fractured area.

The elongation of the test bar, and the contraction of area, afford a valuable indication of the quality and toughness of the material, and of its capacity for adapting itself to unequal strains, the latter being a very important qualification for iron that is to be used in bridge-work.

The ductility of wrought iron varies within wide limits in bars of different brands, and is generally less in plates than in rolled bars, while the commoner kinds of plate that are manufactured for girder-work are much less ductile than the best boiler-plates.

Excluding on the one side exceptionally bad iron, and on the other side those exceptionally good qualities which are hardly obtainable at ordinary prices, we may safely reckon upon the following values, while a slightly higher value would sometimes be taken as the basis of a specification.

	Ultimate Strength per Square Inch of Original Area.	Ultimate Elonga- tion in an 8-inch Bar.
	Tons.	Per Cent.
Rivet-iron	22 to 25	20
Rolled bars	22 to 25	15 to 20
Plates of good quality, lengthwise	20 to 22	10 to 15
Plates of commoner quality, lengthwise	20	5 to 10
Plates strained crosswise	17 to 18	...

151. Tensile Strength of Iron Wire.—When iron is drawn out into wire, its strength per square inch of section appears to be greatly augmented, and reaches approximately the values above quoted for the ultimate resistance of ductile iron per square inch of contracted area. Mr. Telford found the strength of iron wire $\frac{1}{16}$ th inch in diameter to be about 36 tons per square inch; while the slightly larger wire used by Mr. Roebling in the Niagara and Cincinnati suspension cables, had a strength of nearly 100,000 lbs., or $44\frac{1}{2}$ tons per square inch. M. Navier also quotes a number of experiments by M. Seguin, from which it

appears that the strength of unannealed iron wire varies from 52 to 89 kilogrammes per square millimetre, or say from 33 to 56 tons per square inch; but when the wire was annealed, the strength fell again to 23 or 24 tons per square inch. These facts seem to indicate that the great tensile strength of iron wire is due to some molecular changes produced by the process of wire-drawing, and that those changes are undone by the process of annealing.

152. Tensile Strength of Cast Iron.—The tensile strength of cast iron is so greatly inferior to its crushing resistance, that it is seldom or never used for the construction of ties.

Mr. Hodgkinson's experiments show that the English and Scotch pure irons have a tensile strength varying from 6 to 10 tons, and averaging 7 tons per square inch of sectional area. The strength of mixed irons, however, often reaches 9 or 10 tons, and some kinds of American cast iron are still stronger.

153. Tensile Strength and Ductility of Steel.—It has already been mentioned that the strength of steel varies within exceedingly wide limits. Steel bars can readily be obtained of any tensile strength between 26 and 56 tons per square inch, while 80-ton steel may certainly be regarded as a quality that is practically producible; but for constructive purposes the strongest qualities are seldom employed, and a strength of 30 to 40 tons represents the quality of plates, bars, and angles most usually selected at the present time, although it is impossible to say whether this will continue to be the case in future.

Broadly speaking, it would appear that the stronger the steel the less is its extensibility beyond the elastic limit; and although a strong steel may offer a very high resistance to a steady and uniformly distributed stress, yet the *work* required to tear it asunder may be considerably less than in the case of milder and tougher metal, while at the same time the latter kinds of material are much more capable of adapting themselves to those local inequalities of stress which are almost certain to arise either from local inequalities of modulus or from the form of the structural details,—as in rivetted joints, &c.

A very slight difference in the chemical composition of the steel (and especially in the percentage of carbon) appears to be attended with a great difference in its tensile strength, and with a still greater difference in its extensibility beyond the elastic limit. Thus a very strong steel may have a tensile strength of 50 or 60 tons with an ultimate extensibility so small as to be almost worth nothing, and amounting perhaps to only $\frac{1}{2}$ per cent.; but by a very slight modification in its composition, the tensile strength may be reduced to 27 tons, while the ultimate extension may at the same time be increased to 20 or 25 per cent., *i.e.*, increased to forty or fifty times its previous value; and the mechanical work required to tear it asunder would then be much greater than before.

The following comparative values of the work required to break a

bar 10 inches long and 1 square inch in area are given by Professor Kennedy: ¹—

Material.	Work.
40 to 45-ton Bessemer steel	40 to 45 inch-tons
30-ton mild steel	55 to 63 „
First-rate Yorkshire bar iron	50 to 55 „
Ordinary wrought-iron plate	12 to 25 „

The Bessemer steel here mentioned must evidently have an elongation quite equal to that of the “ordinary wrought-iron plates”; but steel of a higher strength would generally have a still smaller extensibility, and would require less work to pull it asunder than the quality of steel here mentioned.

Many authorities consider that this brittleness or lack of toughness, together with some other qualities which characterise the behaviour of strong steel under ordinary treatment, render it unsuitable for constructive purposes; and accordingly it is a common practice to specify that the strength of steel shall *not exceed* a certain standard.

For the steel plates and beams used in shipbuilding, the Admiralty requirements are that the strength shall not be less than 26 nor more than 30 tons per square inch, with an elongation of 20 per cent. in a test bar 8 inches long.²

Lloyd's rule, and the regulations of the Liverpool Underwriters' Registry, admit however a slightly higher quality; the limits of strength in the former case being from 27 to 31 tons, and in the latter case from 28 to 32 tons per square inch.

The percentage of carbon which is necessary to produce a given strength appears to depend partly upon the form into which the steel is worked, being greater for thick plates than for thin ones. The rules of the French Admiralty graduate the minimum strength upon a sliding scale depending on the thickness of plates and the form of cross-section of rolled bars, while they prescribe no limit of maximum strength provided that a certain degree of ductility is obtained; and Mr. Matheson states that the steel used in the French navy is of a stronger quality than that used in the English navy.

The experience gained in shipbuilding has certainly done much to recommend and promote the successful use of steel for constructive purposes; but the requirements of shipbuilding are not entirely the same as those of bridge-construction, and there is still some difference of opinion as to the quality of steel that should be selected for the latter purpose. At the present time there are probably few engineers who would adopt so low a limit of strength as that specified for ship-plates, and many would consider that a strength of 35 to 40 tons can be obtained along with a ductility and a uniformity of material quite equal to those

¹ Vide *Proceedings of the Institution of Civil Engineers*, vol. lxi.

² Vide “Steel for Structures” (*Proceedings of the Institution of Civil Engineers*, vol. lxi.).

of good wrought iron. On the other hand there are some, and perhaps not a few, engineers who would avoid the use of steel altogether in bridge-construction whenever possible, on account of the uncertainties which still attend its employment. These uncertainties, indeed, do not appear to be confined to strong steel; and the disappointing failures which have occurred from time to time in boiler-plates and girder-work have generated a distrust which a few years ago was very strongly felt by most practical men, and which has only partially disappeared as the causes of these failures have been traced and to some extent removed.

Thus in 1877 some experiments were made by the firm of Harkort¹ at Duisberg, upon the strength of plate-webbed girders of wrought iron, hard steel, and mild steel. The girders varied from 17 to 28 feet in length, and in all cases the strength of the wrought-iron girders was fully equal to what might be expected from them, the ultimate tensile stress in the lower flange being about 24 tons per square inch, and the same under cross-breaking as in the direct tensile tests. On the other hand, all the steel girders, with one exception, gave way at a stress which was much below the ascertained direct tensile strength of the material; the separate plates and angle-bars of the lower flange were found to tear asunder one after the other, the failure sometimes commencing (in the weakest bar) when the flange-stress had only reached 12 or 14 tons per square inch, and in one case at a stress of $7\frac{1}{2}$ tons per square inch; while the total failure of the girders generally took place under a load which was considerably less than would be borne by a wrought-iron girder. The steel used in some of these girders was exceptionally strong, but in others which broke under a stress of 15 to 18 tons per square inch, the broken plates were found to have a strength of 29 to 35 tons under direct tensile test, and an elongation varying from 8 to 21 per cent., so that the failure can hardly be attributed to the use of an excessively strong steel. More favourable results were obtained in the case of some other girders which were put together with bolts in drilled holes, instead of rivets; and it was also found that in some cases girders constructed of hard steel gave better results than those in which a milder quality of steel had been employed.

It is not yet clear, however, whether the surprising weakness of the latter girders was due to any injury that had been occasioned by punching or rivetting, or to the unequal strength or ductility of the different plates and angles forming the tension-flange, or whether it is to be explained by some kind of progressive tearing action which may have destroyed the flange in detail, and which is not present in tests made with a direct pull.

Since the date of these experiments considerable progress has, no doubt, been made towards the production of a reliable and uniform quality of steel, and much additional experience has been gained in its treatment; but failures of a very remarkable kind are still occasionally recorded, and their causes, if traceable at all, have only been recognised

¹ Vide *Proceedings of the Institution of Civil Engineers.*

after the failure has taken place. Even so recently as in 1885, boiler plates of the best quality of mild steel have been known to tear across through the solid plate under a tensile stress of only 7 or 8 tons per square inch, and sometimes to give way suddenly without any apparent stress at all, although the same plates when subsequently tested in the usual manner have given the very best results, both as to strength and ductility, that could be hoped for in the best producible material.

These failures are supposed to be capable of explanation on the theory that the plates had been bent or hammered at a "blue heat"—a method of proceeding which appears to be capable of causing great mischief; or else on the theory that the material had been subjected to an enormous initial strain during the process of rivetting the plates together, or at some earlier period of their manufacture.

In the abstract it is no doubt reasonable to suppose that every one of the remarkable failures that have been observed must be the effect of *some* erroneous method of treatment, which, when duly recognised, may be successfully avoided; but at present some of these cases are still unexplained, and there is much difference of opinion as to the nature and extent of the injury that may be caused by the punching, shearing, or bending of steel plates during the ordinary processes of workmanship, and also as to the remedies to be applied or the precautions to be observed in their manufacture and treatment.

Notwithstanding the uncertainties above mentioned, the successful use of steel in shipbuilding and in the thousands of marine boilers which are in daily use, warrants the growing belief in its adaptability for purposes of bridge-construction, although as yet its employment in that-direction has been very limited; and when these uncertainties shall have been removed with the aid of further experience, there would appear to be no reason why the great strength of the material should not be utilised to a fuller extent than would now perhaps be considered judicious.

154. Working Strength of Iron and Steel in Tension.—The ultimate tensile strength given in the preceding articles, represents in each case the value derived from experiments made with a steady and gradually increasing load; and, as already remarked in the last chapter, the working stress per square inch has been commonly fixed by applying a certain factor of safety to this ultimate strength of the material, although it is known that certain modifications are necessary in practice in order to meet the effect of alternations of stress or of a load suddenly applied. But, as before, we shall postpone any discussion of this question, and shall assume that a judicious factor of safety has been adopted; and it may be mentioned that the standard working-stress in tension members, as fixed by the Governmental regulations in most countries, is nearly equivalent to *one-fourth* of the ultimate tensile strength of the material.

Wrought Iron.—Referring to the values above given for the average tensile strength of wrought iron, and applying a fourfold factor of safety, we should have, for tension members composed of plates (rolled length-

wise) a working-stress of $\frac{3}{4}^0 = 5$ tons per square inch, which is the value fixed by the Board of Trade in this country.

When, however, a tension-member is composed of *rolled bars* of good quality, such as the eye-bars which are commonly used in the main chains of a suspension bridge, the working-stress may often be increased to $\frac{3}{4}^4 = 6$ tons per square inch; and in many existing chain bridges the maximum stress would amount to at least 8 tons per square inch, if the bridge-platform were fully covered with vehicular traffic or with an ordinary stream of passengers.

In the iron wire cables of the Niagara and the Cincinnati suspension bridges, the stress is calculated to amount to 8.4 and 8 tons per square inch respectively; but it is not improbable that this stress is sometimes exceeded, or may at least be exceeded under the working conditions of the structure.

All the above values are of course reckoned as applying to the *net* sectional area of the member, deducting rivet-holes or pin-holes where they occur; but the French rule for wrought-iron railway bridges takes no notice of these deductions, but stipulates simply that the stress, whether in tension or compression, shall not exceed 6 kilogrammes per square millimetre, or say 3.81 tons per square inch of *gross* sectional area. It is obvious that this rule would in some cases entail an unnecessary waste of material, while in other cases it might be quite unsafe.

Steel.—From the facts already quoted in regard to the ultimate strength of steel, it may easily be gathered that the proper working-stress for steel bridges is a matter on which there is much difference of opinion. If we take one-fourth of the lower limit specified by the Admiralty for the minimum strength of steel plates, we shall have a working-stress of say $\frac{3}{4}^6 = 6\frac{1}{2}$ tons per square inch; and until quite recently the Board of Trade have limited the working-stress to this figure, although they have been prepared to extend it whenever the safety of adopting a higher strength of material should be assured by practical experience. Hitherto, however, the use of steel for constructive purposes in this country has been chiefly confined to ship and boiler work, and its first application on a large scale for purposes of bridge-construction, may almost be said to have commenced with the great bridge which is now being constructed to cross the Firth of Forth; and for this structure a working-stress of $7\frac{1}{2}$ tons per square inch has been adopted in the principal members of the bridge, with the consent of the Board of Trade.

In regard to the strength of steel eye-bars for suspension bridges, or for the tension chords of girders, the experience at present available is even less than in the case of steel plates. Some steel-makers of great experience have recommended for this purpose the use of steel of a very high degree of strength, such as would warrant a working-stress of 10 tons per square inch; but, on the other hand, some manufacturers appear to have found a great difficulty in producing an eye-bar of such material,

which shall be capable of resisting the complex strains that take effect in the metal surrounding the pin, and have stated that even with a comparatively mild steel it is at present impossible to guarantee an eye-bar for more than four-fifths of its theoretic strength.

155. Joints and Connections.—If a tension-member could be treated as though it were subject only to a direct pull in every part, its design would of course be a very simple matter, and there would be nothing further to consider beyond the experimental data already given for determining its sectional area. But it is evident that in every straight tie, whether continuous or composed of successive links or plates, the pull can only be applied by means of some kind of connection; and it is this which generally governs the design and construction of tension-members in the ordinary practice of bridge-construction.

For the present purpose it will chiefly be necessary to consider two forms of construction, viz, ties composed of eye-bars with pin connections, and plate-built members with rivetted joints. Several other forms of connection have of course been employed in the construction of ties, but none of them have been extensively used in bridge work. Thus the ties of some roof-trusses have been connected by screwed ends held together in a sleeve-nut, and the same method has been successfully employed to connect the wires forming the cables of the Brooklyn Bridge; and it is hardly necessary to mention that other examples are to be found in the various forms of chain-cable, including the great links of Mr. Brunel's mooring chain, which were made of successive laminæ of hoop-iron; but these forms have not found any general favour with bridge builders, and most of them are inapplicable on account of their bulk.

As regards economy of construction, it may be remarked as a general principle, that every joint which we introduce in a tie must involve some waste of material, and therefore if we have to construct a long tension-member with a given sectional area, our object must be to do with as few joints as possible in the length of the tie; but as the individual plates or bars cannot well be made above a certain weight or magnitude, we shall generally attain the greatest efficiency by making the constituent parts of great length and of small sectional area, and by avoiding the opposite proportions as far as possible.

Thus for a very long tie, the most economical form will naturally be a wire cable without any joints at all; and the next will be a chain composed of long prismatic bars of moderate section with swelled ends and pin connections, or a tie composed of long flat bars with rivetted covers.

As compared with these, any kind of plate-built member must necessarily require to be jointed at shorter intervals, and will therefore be less economical; but in plate-built tension-members economy must be aimed at by combining together long and narrow plates (in as great number as may be necessary) rather than by using shorter and broader plates, which would evidently require to be jointed with heavy cover plates at short intervals. The practical importance of this rule will become very obvious

when the weights of different forms of tension-members in existing bridges are compared one with another.

156. Eye-Bars and Pin Connections.—This very efficient form of construction has long been used in the main chains of suspension bridges, and also in the tension-members of girder bridges, as, for example, in the curved tie of the Saltash girders; while in America it is very commonly adopted both for the lower members of straight parallel girders and for the diagonals of the web bracing, and also for the upper tension-members of cantilever bridges.

Whatever may be the required strength of a tension-member, there is generally no difficulty in constructing it upon this principle. When the required sectional area of the member is very large, it is generally made up by grouping together a sufficient number of bars of moderate dimensions, strung side by side upon the same connecting pin as shown in Figs. 171 and 171a, the bars being generally not more than 6 to 9 inches in depth and about 1 inch in thickness, although in some cases heavier sections have been adopted. Thus each link in the chain of a suspension bridge may consist perhaps of 14 or 15 bars, with spaces between them equal to the thickness of the bars, and occupying therefore a total width of 29 or 30 inches upon the pin; and when a still greater sectional area is required, this is commonly obtained by placing two or sometimes three tiers of bars one above the other, as in the main chains of the Clifton suspension bridge, and in the tension-member of the Saltash girders. In each of these bridges the stress is nearly, though not exactly, uniform from end to end of the tension-member; and the required variation of sectional area is easily provided for by a slight modification in the thickness of the bars, which are all rolled to the same width of 7 inches. But in the lower chord of a parallel girder the required variation of sectional area is of course much greater, and is provided for by increasing the number of bars in the central panels of the girder, the bars being generally arranged in pairs and placed symmetrically on each side of the centre line, while their dimensions are regulated according to the sectional area required.

It is hardly necessary to remark that in order to secure a uniform distribution of stress among the several bars of any one set, the greatest care is required in the uniform spacing of the eye-holes, and in the accurate fitting of pins and eyes; but this matter presents no difficulty which cannot be efficiently met by the employment of machine tools; while the unequal distribution of stress, which may result from any unavoidable inequality in the modulus of elasticity, is not likely to be any greater in a set of eye-bars than in a member composed of plates and

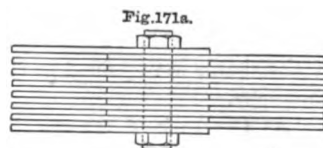

angles rivetted together, or in any other possible combination of iron-work.

157. Proportions of Eye-Bars.—Some years ago, wrought-iron links for suspension bridges were rolled in England by special machinery for the shaping of the swelled heads, but owing to the small demand for them in this country it is doubtful whether these machine-made links could now be readily procured. In America the heads are generally formed either by hammer forging or by a process of "hydraulic-forging," and in the latter case the bars are known as "weldless eye-bars;" and Mr. Shaler Smith finds that the proportions which should be adopted for the eyes depends partly upon the mode of their manufacture.

If we consider the forces that are in action in the head of an eye-bar, such as that shown in Fig. 172, it will be evident that the stresses which take effect round the eye must be very complex.

Most of the longitudinal fibres, or lines of direct stress, in the shank B are intercepted and cut off by the hole D ; and immediately to the left of the hole there can be no longitudinal tension at all; so that the pull of the fibres in B must be transferred laterally to the sections b and b , either by "lateral adhesion," which is resistance to shearing-force, or else by an oblique deviation of the lines of stress, which probably amounts to the same thing. But it would be rash to assume that the stress thus transferred to each side of the head is uniformly distributed over the section b ; indeed it is obviously reasonable to suppose that the stress will be less intense at the outer edges than in the parts nearer to the pin, though this effect might no doubt be moderated if the shank were joined to the head by a long and gradual taper of the shoulders.

At the back of the eye the stresses are still more complex, and the pull transferred from this side appears also to have the same effect of concentrating the tension in b at the edge adjoining the pin. In the first place, the pin will exert a direct pressure upon its seat, tending to upset the iron at the back of the eye and to elongate the hole; and Sir C. Fox has pointed out that if the bearing area of the pin upon the metal of the eye is too small to resist this tendency, the elongation of the hole will have the effect of drawing out the metal at the inner edges of the sections bb , and however wide these sections may be made, they will be torn asunder by a crack, commencing at the inner edge and gradually extending outwards.

For this reason the pin must never be made less than a certain diameter; and in addition to this, the metal at the back of the eye must be formed (as a beam) of sufficient transverse strength to transfer the pressure of the pin to the points of support b and b . Such a beam may evidently give way by tearing the fibres at the outer edge of the section E , or by yielding to the shearing force; and besides the duty of merely resisting the ultimate effect of these forces, the metal at the back of the eye must have a form of sufficient rigidity to transfer the load fairly and

equably to the surfaces bb , or at least to avoid an excessive concentration of the stress at the inner edges of those sections.

It would be useless to calculate the local effects of these various stresses, as the proportions of head and of pin, which are practically necessary to meet them, have been found by repeated experiments, and these will form the best possible guide in designing such details.

Diameter of Pin.—Sir C. Fox and Mr. Brunel agree in stating that the pin must have a diameter *at least* equal to two-thirds of the width of the shank B , and Mr. Shaler Smith confirms the opinion that this is the smallest diameter of pin that will develop the full strength of the bar under experimental tests. Mr. Berkley adopts a diameter equal to three-fourths the width of the shank, and in view of the possible elongation of the hole under the hammering effect of passing loads—a contingency which is not present in experimental tests, it would certainly appear to be safer to adopt this proportion in preference to the minimum value above given.

If the eye-bars are made with anything like the usual proportions of breadth to thickness, a pin of the diameter above given will always be more than strong enough to resist the shearing stress, so that in most cases the shearing strength need not be calculated.

Proportions of Head.—The head shown in Fig. 172 is drawn to the proportions determined by Mr. Berkley for wrought-iron flat eye-bars, the thickness of metal being assumed to be uniform throughout, in accordance with the usual and most convenient practice. Taking the width of shank B as the unit of measurement, the several dimensions are as follows:—

Width of shank B	= 1·00
Diameter of pin D	= 0·75
Width of metal across the eye, $b + b$	= 1·25
Width of metal behind the eye, E	= 1·00
Radius of shoulder	r	= 1·00
Radius of neck	R	= 1·50

These dimensions are, however, varied by other authorities. It has already been mentioned that Sir C. Fox considered it sufficient to make $D = 0·66 B$, and the width across the eye is given by him as $b + b = 1·10 B$. A different pattern of head has been employed in times past by Mr. Brunel, who makes the width across the eye $b + b = 1·21$, while the width E is only equal to b or $0·60$; but on the other hand the shoulder is drawn out to a very gradual taper, the radius R being equal to $7·6 B$.

Turning now to American practice,¹ Mr. Shaler Smith finds that the requisite proportions of eye-bars will depend partly upon the mode of their manufacture, and that these proportions must again be modified

¹ Paper read before the American Society of Civil Engineers, and published in *Engineering*.

whenever it may be necessary to use a pin whose diameter is *greater* than about $0.75 B$. The latter case frequently arises in the construction of American bridges, in which the diameter of pin is fixed with reference to the width of the bars in the main tension chord, while the same pin

forms the end connection for the diagonal bars of the bracing, which may often be of less width than those of the main chord; and with these narrower eye-bars the width of metal $b + b$ must bear a larger proportion to the width of shank than in the wider bars of the main chord. This requirement appears to arise solely from the disproportionate size of the pin, and it would therefore follow as a general rule, that when the size of the pin is a matter of unconstrained choice, its diameter should be not less than 0.66 nor greater than about 0.75 if the greatest efficiency is sought to be obtained.

The best proportions for hammered and for "weldless" eyes, as determined by Mr. Shaler Smith's experiments, are illustrated in Figs. 173 to 176. Fig. 173 represents a hammered eye in which the width of shank and diameter of pin are the same as in Fig. 172; while the eye-bar shown in Fig. 174 illustrates the altered proportions that would be required in a narrower bar connected with the same pin. But if the two bars were made with hydraulic-forged eyes, their proportions as determined by experiment should be those shown in Figs. 175 and 176.

In hammered eyes the width of metal behind the pin is $E = B$ (as in Mr. Berkley's proportions), but the ratio $\frac{b}{B}$ is found to depend on the diameter of the pin. When

$D = 0.75 B$, as in Fig. 173, $b + b$ is equal to $1.33 B$, and therefore greater than by Mr. Berkley's rule; at the same time the head has less metal in it than that shown in Fig. 172, and certainly looks to have the metal in the right place. Each side of the head is formed by a circular arc described about a centre situated in the vertical line passing through the centre of the pin, and if the radius of this arc is r the radius of the neck is $R = 1\frac{1}{2}r$.

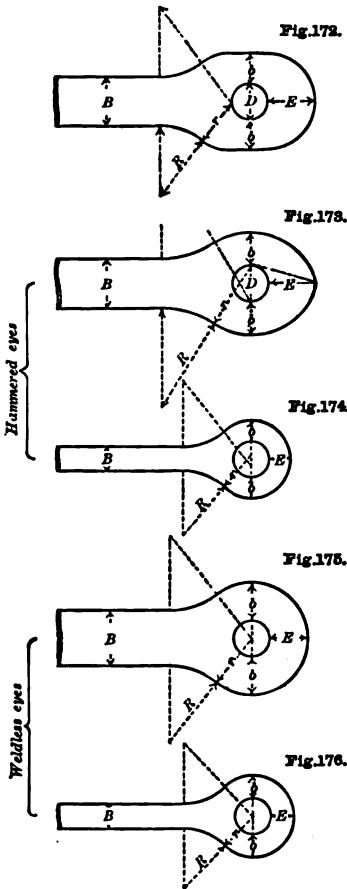

On the other hand, the heads of the "weldless" eye-bars are made of circular form, concentric with the pin, so that $E = b$, and the external radius is $r = b + \frac{D}{2}$, while the radius of the neck is $R = 1\frac{1}{2}r$ as before. This form of head, however, requires a greater width at b than either of the others.

The necessary width of metal $b + b$ across the eye, as depending on the diameter of pin, is given in the following table.

TABLE 2.—Proportions of American Eye-Bars, as determined by Mr. Shaler Smith.

Width of Shank B .	Diameter of Pin D .	Hammered Eyes.		Weldless Eyes.	
		Metal Section across the Eye $b + b$.	Maximum Thickness of Bar.	Metal Section across the Eye $b + b$.	Maximum Thickness of Bar.
1·00	0·67	1·33	0·21	1·50	0·21
1·00	0·75	1·33	0·25	1·50	0·25
1·00	1·00	1·50	0·38	1·50	0·38
1·00	1·25	1·50	0·54	1·60	0·54
1·00	1·33	1·70	0·59
1·00	1·50	1·67	0·70	1·85	0·70
1·00	1·75	1·67	0·88	2·00	0·88
1·00	2·00	1·75	1·08	2·25	1·08

The maximum thickness of bar, as given in the table, is calculated as being limited by the transverse strength of the pin of the given diameter. The bending moment is taken by Mr. Shaler Smith as equal to the pull of one bar multiplied by the distance of the bars from centre to centre when placed close together, *i.e.*, by the thickness of one bar.¹

It will be seen that so long as the thickness of the eye-bars is less than $\frac{1}{2}$ th of their width (which it generally is), the transverse strength of the pin need not be calculated, while the shearing strength of the pin will not come in question unless the thickness of the eye-bar is still greater.

When wrought-iron eye-bars are formed to the proportions given above, it has been proved by repeated experiments that the full theoretic strength of the shank will be developed; and when the bar is strained by a load equal to its theoretic breaking-weight, it will be as likely to give way at the shank as at any other point. At this moment the *average* intensity of stress in the section b will of course be less than in the shank, in the proportion $\frac{B}{b + b}$; but the *maximum* fibre stress at the

¹ The transverse strength of wrought iron, as already mentioned, is considerably greater than the amount obtained by theoretic calculation of the stress on the extreme fibre; and in the above calculation the working-stress in the extreme fibre is taken at $1\frac{1}{2}$ times the working-stress in the shank of the eye-bar.

inner edge of the section b will probably be equal to the stress in B , or nearly so.

The compressive stress upon the bearing area of the pin will of course be equal to the gross load, but in calculating its intensity it is not quite certain how the area of the bearing surface should be reckoned. Sir C. Fox takes the whole semi-cylindrical area, so that when the diameter of pin is $0.66 B$, the average intensity of compressive stress on this area would be nearly equal to the tensile stress in the shank of the bar, but would be still greater if the effective bearing area is taken as equal to the diameter of pin multiplied by the thickness of the bar. It may seem surprising that the metal should resist so great a pressure without bulging or upsetting, but this may perhaps be explained by the fact that the compressed particles receive so much extraneous support on all sides that they are not permitted to bulge; and it is well known that even a very weak material, when supported or confined in this way, will exhibit an almost unlimited weight-bearing capacity.

158. Steel Eye-Bars.—It does not by any means follow that the proportions determined by experiment for wrought-iron eyes will apply also to steel, and it has been remarked that some difficulty has been experienced in the formation of steel eyes, which seems to indicate that a different set of proportions may yet have to be found to suit this material.

In the steel cantilever bridge recently erected across the St. John's River in Canada, with a central span of 477 feet, the upper member of each cantilever has been formed of steel eye-bars, each link having a length of about 26 feet, and being composed of either two or four bars, whose section varies from $7'' \times 1\frac{3}{8}''$ to $10'' \times 1\frac{1}{2}''$ in the different panels of the bridge. The author is not aware what proportions of head were adopted in this case, but the diameter of pin is from 0.7 to $0.75 B$.

It has recently been stated¹ that the Edgemoor Iron Company of Wilmington, Delaware, are now manufacturing steel eye-bars "by a new method of upsetting, without buckling or welding," by which the full strength of the bar is developed with proportions of head which differ considerably from those of the wrought-iron eye-bars above mentioned. When D is less than B , the width $b + b$ is made equal to $1.50 B$; but this width across the eye is reduced to $1.40 B$ when D is greater than B —thus reversing the rule observed by Mr. Shaler Smith in hammered and hydraulic forged eyes. At the same time it is stated that these values of $b + b$ (which were provisionally adopted) may be reduced to 1.40 and 1.30 respectively, while still maintaining the full strength of the eye-bar; and that in some experiments the width across the eye has been reduced to $1.20 B$, and the bar has still broken through the shank. The experiments here quoted were made in 1885; the material of these bars was a very mild and ductile quality of Bessemer steel, having an ultimate strength of 60,000 to 67,000 lbs., with an elongation of 31 to

¹ Vide Mr. Wilson's paper on "Specifications for Iron Bridges," in the *Transactions of the American Society of Civil Engineers*, June 1886.

40 per cent. in 8 inches; while the pins were of large diameter, varying from 1.11 *B* to 1.30 *B*, the largest pin being used along with the smallest excess of width across the eye.

159. Rivetted Joints.—In plate-built members with rivetted joints it is not practicable to obtain the full strength of the solid section of plate; the loss of strength may be minimised by a special arrangement of the rivets, but in the ordinary practice of construction a considerable percentage of the gross section is lost at the rivet-holes. In boiler work the pitch of the rivetting is necessarily very close, and when single rivetting is employed (as sketched in Fig. 180), the strength of the joint is generally not much more than half the strength of the plate, *i.e.*, the “efficiency” of the joint is about equal to 0.50; while the efficiency is only increased to 0.66 or 0.70 when the rivets are arranged in two rows, as in Fig. 181. But in bridge work a greater efficiency is easily obtained by a judicious arrangement of the rivets; and in all cases the object aimed at must be to secure an equal strength in every part of the joint, and to make that strength approximate as nearly to the full strength of the plate as may be practicable with ordinary methods of workmanship.

For this purpose it is chiefly necessary to consider two points, *viz.*—

1. The strength of the rivets in resisting the shearing stress; and
2. The strength of the plate across the line of easiest fracture through the rivet-holes.

And in connection with these it may also be necessary to consider the bearing area of the rivets, and the tendency to upset the plate under the direct pressure of the rivet.

160. Shearing Stress on the Rivets.—Disregarding the frictional resistance of the plates, which are forcibly pressed together by the grip of the rivet, and assuming that every rivet in the joint does its fair share of work, the shearing stress on each rivet will be equal to the total pull of the tie divided by the number of rivet sections that must be sheared in order to pull the bars asunder. The number of rivet sections will either be equal to the number of rivets or to twice that number, according as the rivets are in “single-shear” or in “double-shear.”

Thus the rivet shown in Fig. 177*a* must be sheared through at two sections before the tie can be pulled asunder, and the same with regard to either of the two rivets shown in Fig. 177*b*. These rivets being in “double-shear,” the pull of the tie is, in each case, divided equally between the two ends of the rivet, and the shearing stress at each section is therefore equal to half the pull of the tie.

But when the rivets are in “single-shear,” as illustrated in Figs. 178*a* and 178*b*, each rivet has only to be sheared through at one section; and

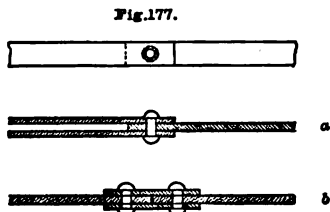

if the number of rivets were the same as before, the shearing stress on each would be twice as great. In the Figs., *a* represents a lap-joint, and *b* a butt-joint with cover plates, and the Figs. show the comparative

Fig. 17a.

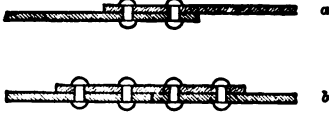

number of rivets required in each case, the shearing stress per rivet section being the same in all the Figs. Apart from the theoretic advantage of placing the rivet in double-shear, it is evident that this arrangement puts the rivet in a much better position to do its work, and avoids the one-sided pull which takes effect in single-shear, and which would doubtless be attended with an injurious twist or bending of the rivet, if that effect were not in great measure resisted by the firm grip which is produced by the contraction of the rivet in cooling.

161. Shearing Strength of Iron Rivets.—The resistance of wrought iron to a shearing stress, is nearly equivalent (per square inch of sheared section) to the ultimate strength of the same material under direct tensile stress, or at least equal to $\frac{9}{10}$ ths of that quantity; so that if the iron were of the same quality in rivets and in plates, a working-stress of $4\frac{1}{2}$ tons per square inch (at least) might be taken as equivalent to a working tensile stress of 5 tons per square inch in the tie. But rivet iron is generally stronger than plate, and frequently as much as 10 per cent. stronger; and some engineers adopt the rule of making the aggregate sectional area of the rivets equal to the net sectional area of the plate taken through the rivet holes. On the other hand there is the contingency that the stress may be more severe on some of the rivets than on others, and this may arise from several causes—the holes may not be punched quite accurately, and may have to be rimered out to bring them fair, and from this or other causes the rivet may not entirely fill the hole; and even if this is avoided by careful workmanship or by machine-drilling, the stretch of the plates, or the unsymmetrical arrangement of the rivets, may easily produce an unequal distribution of the stress.

To provide for these contingencies, the aggregate sectional area of rivets is generally made greater than the net section of the plate by about 10 per cent., and some engineers would increase it by 15 or 20 per cent., and would apply this percentage to the sectional area of rivets as calculated from their *nominal* diameter, notwithstanding the fact that the holes are generally punched $\frac{1}{8}$ th inch larger, and are supposed to be filled by the rivet when the latter is properly upset in the process of rivetting.

In view of these several considerations, the shearing stress per square inch of rivet section, which will be equivalent to a working tensile stress of 5 tons per square inch in the plate, may be taken as either $4\frac{1}{2}$ tons or 4 tons per square inch, according to the character of the joint and of the workmanship. For ready calculation the following table gives

the value of the pull T (in tons) which can be taken up by the shearing strength of one rivet section, and also the decimal coefficient N , representing the number of rivet sections required to resist a pull of 1 ton, so that the required number of rivet sections for any joint may be found by multiplying the pull of the tie (in tons) by the coefficient N .

TABLE 3.—*Strength of Iron Rivets.*

Nominal Size of Rivet.		Shearing Stress taken at 4½ Tons per Square Inch.		Shearing Stress taken at 4 Tons per Square Inch.	
Diameter.	Sectional Area.	T .	N .	T .	N .
Inch.					
$\frac{3}{8}$	0·3068	1·38	0·725	1·227	0·817
$\frac{1}{2}$	0·4417	1·987	0·503	1·767	0·566
$\frac{3}{4}$	0·6013	2·706	0·370	2·405	0·416
1	0·7854	3·534	0·283	3·142	0·318

These values are very often used without paying any regard to the intensity of pressure that may take effect upon the bearing area of the rivet ; *i.e.*, the diameter of rivet \times thickness of plate ; although some experiments appear to show that the shearing strength of the rivet is really affected by this question, or at all events that it is reduced if the intensity of bearing pressure exceeds a certain maximum.

162. Shearing Strength of Steel Rivets.—For Landore-Siemens steel having a tensile strength of 26 to 30 tons, the shearing strength is found to be 80 per cent. of the tensile strength ; but in stronger steel having a tenacity of 36 to 52 tons per square inch the percentage is less, and falls to 72 and to 63 per cent. respectively.

Rivet steel has commonly exhibited a shearing strength of 20 to 25 tons per square inch of rivet section, and in the numerous experiments that have been recently made by Professor Kennedy and by Mr. Moberly, the shearing strength of the steel rivets was very uniformly equal to nearly $24\frac{1}{2}$ tons per square inch, the tensile strength being about 29 tons.

It would appear therefore that when the calculation of strength is made with a constant factor of safety = 4, the working-stress for rivet steel of this quality may be taken at about 6 tons per square inch ; but making the same allowances as before for unequal distribution of stress, the figure may be reduced either to $5\frac{1}{2}$ or to 5 tons per square inch ; and the resulting values of T and N will then be as follows :—

TABLE 4.—*Strength of Steel Rivets.*

Nominal Size of Rivet.		Shearing Stress $5\frac{1}{2}$ Tons per Square Inch.		Shearing Stress 5 Tons per Square Inch.	
Diameter.	Area.	T.	N.	T.	N.
Inch.					
$\frac{1}{2}$	0·3068	1·687	0·593	1·534	0·652
$\frac{3}{4}$	0·4417	2·429	0·411	2·208	0·453
$\frac{7}{8}$	0·6013	3·307	0·302	3·006	0·333
1	0·7854	4·320	0·232	3·927	0·255
$1\frac{1}{8}$	0·9940	5·467	0·183	4·970	0·201

It must be remarked that the above-mentioned experiments were made with especial reference to boiler work, and the rivets were intended to be used along with steel plates having a tensile strength of about 30 tons. Thus the shearing strength of the rivets (per square inch) was equal to three-fourths of the direct strength of the plates, whereas in wrought-iron work the rivet strength is generally quite equal to the plate strength. It follows that in using steel plates of this quality the joints will require a larger rivet section than in iron plates of the same dimensions; and if a stronger quality of steel plate is used, the rivet section must be still further increased.

It must also be remarked that the shearing strength above given cannot be relied upon, unless the bearing pressure is kept within a certain limited intensity per square inch of bearing area. The relation between the two quantities is not yet made manifest; but Professor Kennedy found that when the bearing pressure amounted to 53 tons per square inch, the shearing strength of the steel rivets was reduced from 24 to $16\frac{1}{2}$ tons per square inch of rivet section; and in another case the rivets sheared at 18 tons per square inch when the bearing pressure was 46 tons per square inch. Of course this reduction of shearing strength may have been partly due to an unequal distribution of stress among the rivets, which was found commonly to reduce the *mean* strength of the rivet section (for the whole joint) from 24 to 22 tons or even to 21 tons; but beyond this ascertained loss, the reduction of strength appears to be due to excessive bearing pressure; and Professor Kennedy recommends that this pressure should not exceed 42 or 43 tons per square inch, for the quality of rivets and plates used in these experiments.

163. Strength of the Plate across Rivet Holes.—In the ordinary practice of iron girder construction, the strength of the plate per square inch of net section between the rivet holes is commonly assumed to be independent of the proportions of the joint; or, at all events, the working stress for wrought-iron ties, whether 5 tons per square inch or what not, is understood as being applicable to that net sectional area. This practice

is to a certain extent justified by the average results of experience, and by such experiments as that mentioned in Article 153; but in the case of steel it is certainly necessary to proceed with greater caution for reasons which were sufficiently exemplified in the same Article.

The most complete experimental results that have been obtained for steel are those summarised in the Report of the Research Committee on Rivetted Joints made to the Institution of Mechanical Engineers,¹ and having reference chiefly to the single or double rivetted joints of boiler work. So far as can be gathered from these and other experiments, the strength of the net section appears to be the algebraical sum of three of four separate gains and losses, due to causes which are quite distinct in themselves, but whose separate effects are not easily to be distinguished in any one experiment. These are—

1st. A *loss* due to the injury caused by punching; the amount of this loss depends on the thickness of the plate; it may be more or less perfectly removed by remedial measures, and is absent in the case of drilled plates.

2nd. A *gain* due to the perforation of the plate, by whatever means; and caused apparently by the consequent equalisation of the stress between the remaining lands, or bars of metal between the holes.

The net result so far is a gain in the case of drilled plates, and may be either a loss or a slight gain in the case of plates which are perforated by punching.

3rd. A further loss, due to the unequal distribution of stress in the width of each remaining land of plate, and its concentration at the edges of the pulling rivets; this becomes sensible when the bearing pressure is too great, just as in the case of eye-bars, but is no doubt modified by the hold of the rivet-heads.

4th. The last-named effect may evidently be intensified if the stress is unequally divided between the several rivets, and if a tear is thus commenced at the side of the most heavily pulled rivet, the effect would seem to be particularly injurious in the case of steel; for it is known that a slight nick inflicted on one side of a steel tie-bar is sometimes enough to effect a very great reduction in its strength.

Summarising the results of the above-named experiments, and some others which have been made at a recent date, the several items of gain and loss appear to have the values quoted in the next ensuing Articles.

164. Injury caused by Punching.—In punching a hard and thick plate, the metal is subjected to intense stresses which produce a molecular change in its structure, rendering it harder and more brittle or less capable of stretching. This effect appears to be confined to a narrow zone of metal surrounding each hole, but it reduces the average strength of the section between the holes to an extent depending on the thickness and quality of the plate, or on the intensity of the pressure required to punch it.

¹ Vide *Proceedings of the Institution of Mechanical Engineers*, 1885.

There is no doubt that the same injury is caused in punching iron plates, but to a less extent than in the case of steel.

From certain experiments made in 1878 by Mr. W. Parker, and reported to Lloyd's Committee,¹ it was found that thin steel plates lose comparatively little by punching, the loss of strength being only 8 per cent. for $\frac{1}{4}$ -inch or $\frac{3}{8}$ -inch plates, while for $\frac{1}{2}$ -inch plates it amounted to 26 per cent., and rose in some cases to 33 per cent. in the case of plates having a thickness of $\frac{5}{8}$ inch or $\frac{3}{4}$ inch.

The injury occasioned by punching may of course be avoided by drilling the holes instead of punching them; and in large or important girder-work it has frequently been the practice of English engineers to have all the rivet-holes drilled at uniform pitch throughout, by multiple machine-drills—a method which not only secures the full strength of the plate, but also produces an accuracy of workmanship which is quite unattainable by any process of punching.

But when plates have been punched, the injury above mentioned may be remedied to a great extent, either by annealing, which appears to undo the molecular change produced by the punching; or by rimering out the hole and thus cutting away the zone of affected metal. In the latter case the hole is of course punched smaller than the intended diameter, and the hole is then rimered out about $\frac{1}{8}$ -inch all round. One or the other of these methods is generally employed in steel work, but in wrought-iron girder-work the holes are very generally punched without adopting either of these remedies.

165. Effect of Perforation.—Apart from the structural injury inflicted by punching, the perforation of the plate has been shown by Professor Kennedy to produce a distinct increase in the tensile strength of the remaining section between the holes. These experiments were made with test pieces of the form shown in Fig. 179, and it was believed that the pull was applied in such a way as to distribute the stress evenly over the whole width in all cases; but in testing the solid plate before

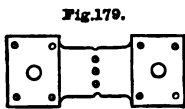

perforation, it was found by minute examination that in the vicinity of the line of ultimate fracture, the stretch was much greater in the centre than at the sides of the plate. This unequal distribution of the strain cannot take place when the plate is perforated, as in Fig. 179; because the strain, or elongation of the fibres, is then confined to the very short length of the bars between the holes, and must be nearly equal in each bar. At all events this is the cause to which Professor Kennedy attributes the observed increase of strength, about which there can be no doubt whatever.

Moreover, it is evident that the narrower we make these intervening spaces the greater will be the difference between the stress intensity at these points and at the broad untouched spaces behind the rivets; consequently the less will be the strain in these broad spaces, and the more

¹ *Transactions of the Institution of Civil Engineers*, vol. lxi.

evenly will it be divided between the several bars or lands. This view agrees, at any rate, with the results of the experiments,¹ which are summarised as follows.

For $\frac{3}{8}$ -inch plates of 30-ton steel, holes drilled to the diameter d :—

	Excess of Tenacity.
Pitch of rivetting $p = 1.9d$	20 per cent.
„ $p = 2.0d$	15 „
„ $p = 3.6d$	10 „
„ $p = 3.9d$	6.6 „

For $\frac{1}{2}$ -inch plates of 30-ton steel, drilled holes :—

Pitch of rivetting $p = 1.9d$	20 per cent.
„ $p = 2.8d$	7.8 „

When the holes are punched, these percentages of gain are, of course, subject to a deduction on account of the injury done in the punching, which varies with the thickness of the plate, and will leave a net loss if the plate exceed a certain thickness. Thus Mr. Moberly deduces from his own experiments that if the solid plate is good for 30 tons, the strength of the net section between punched holes will be as follows :²—

Thickness of plate	$\frac{1}{4}$ "	$\frac{3}{8}$ "	$\frac{7}{16}$ "	$\frac{1}{2}$ "	$\frac{9}{16}$ "	$\frac{5}{8}$ "
Ultimate strength of } net section	. 32	31	30	29	28	27

In all cases the plates were of mild and extremely ductile quality, and it is not to be assumed that the results would apply to any stronger quality of steel. It is also evident that the percentage of gain becomes very small when the pitch of the rivetting amounts to four times the diameter ; and in bridge work the pitch is seldom less than this, and is generally greater ; so that this gain of strength is really inconsiderable so far as our purpose is concerned, but the results are nevertheless important as showing the great effect of any unequal distribution of stress in a steel plate.

166. Effect of Unequal Distribution of Stress.—It has already been mentioned that in the case of eye-bars, the stress is *not* evenly distributed over the sections bb (Fig. 172), and that the strength of these sections is consequently less than that of the solid bar in the proportion $\frac{B}{b+b}$.

Comparing the eye-bar with the rivetted joint shown in Fig. 177, it seems probable that a similar concentration of stress, and drawing out of the metal would take place at the edges of the rivet hole, if the bearing area of the rivet were so small as to produce any elongation of the hole. But this tendency would be moderated by the grip of the rivet head, which must certainly distribute the pull over a certain area of metal

¹ Vide Professor Kennedy's experiments on rivetted joints, published in *Engineering*.

² Vide *Proceedings of the Institution of Civil Engineers*.

around the hole, and must also diminish the actual bearing pressure upon the rivet shank.

Any loss of strength that may be due to this cause would evidently be missed in experiments made in any such manner as that indicated in Fig. 179; for in these test pieces there were no rivets in the holes at all, and the tensile stress was imposed in a manner quite different from that which occurs in a rivetted joint.

In the case of experiments made with the complete rivetted joint (in mild plates of 30 ton steel) it was found by Professor Kennedy that the plates exhibited a distinct loss of strength amounting to 10 or 12 per cent. when the bearing pressure was 46 tons per square inch, but in most cases the actual loss could not be ascertained, because when the bearing area was too small the joint generally gave way by shearing the rivets.

It was also found that by increasing the size of the rivet head, the strength of the plate per square inch of net section might in such cases be increased by $8\frac{1}{2}$ per cent.

These results were obtained with a closer pitch of rivetting than is generally adopted in bridge-work, and it is probable that any such concentration of stress at the edge of the hole would be proportionally more intense in the case of wider rivetting.

It must also be remarked that these results apply to joints containing a very small number of rivets fitted with great care in accurately drilled holes; and it is evident that when the strength of the joint depends upon the distribution of the pull between a large number of rivets, some of which may fit badly, it may happen that an intense bearing pressure is brought upon one or two rivets, and if the result should be to draw out the edges of these holes and to start a crack in the plate, it would be difficult to estimate the extent to which the strength of the plate might be reduced.

In the case of wrought iron, experience has proved that these contingencies are not more serious than can be covered by the allowances already mentioned; but experiments are still needed to ascertain their effect upon the shearing strength and the plate strength of large joints in steel work.

167. Working-Stress on Oblique Line of Fracture.—

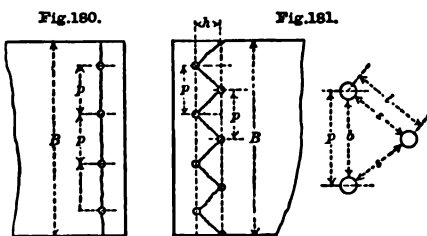

When the rivets are arranged in crow's-foot fashion as in Fig. 181, some engineers have assumed that the resistance of the plate along the zigzag line of section is practically the same as along the direct line shown in Fig. 180. At this rate the plate ought never to break along the

zigzag unless the dimension s is less than $\frac{b}{2}$; but it is well known that in

practice the fracture will generally follow the zigzag unless this line of fracture is considerably longer than the direct line.

Experiments are still needed to determine the strength of a section inclined at any variable angle with the line of direct stress, and to ascertain the best value of the ratio $\frac{h}{p}$. In Mr. Moberly's experiments¹

with $\frac{9}{16}$ -inch steel plates, the pitch was $p = 3.775$, and h was at first made equal to 1.5 inch. The line of zigzag fracture $s + s$ was then equal to $1.04b$ to $1.10b$ (according to the size of the rivet), but the plate always broke on the zigzag line; and the same thing occurred when the distance h was increased to $1\frac{5}{8}$ -inch, making the zigzag equal to $1.13b$. But in the $\frac{5}{16}$ -inch plates the line of zigzag fracture was increased to $1.33b$, and the plates then broke indifferently on either line,—some on the straight and others on the zigzag line.

This result agrees exactly with the practice of some engineers, who make the working-stress per unit of area measured on the zigzag line equal to three-fourths of the working-stress on the direct line. The value of the ratio $\frac{h}{p}$ which would yield this desired proportion depends on the diameter of the rivets, and it is obvious that the rule cannot possibly be true for all varying angles of obliquity; but for ordinary proportions of rivetting the rule is probably near enough to the truth for all practical purposes, and may be taken as equally good for iron and for mild steel.

168. Arrangement of Rivetted Joints.—Figs. 182, 183, and 184 illustrate some of the forms of joint most usually adopted in bridge work. In Fig. 182, each leaf of the cover-plate contains three rows of rivets, with four rivets in each row, but the number will of course depend upon the requirements of each case, and it will often happen that the required rivet area cannot be obtained with less than four or sometimes five rows of rivets. At the section

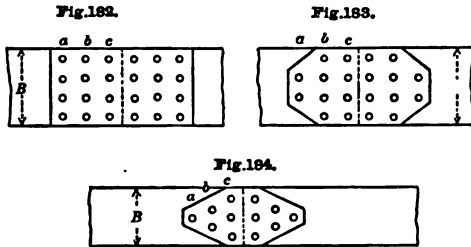

the whole tensile stress will be borne by the net section of plate, whose width will in this case be equal to $B - 4d$, in which d is the diameter of the rivet hole. The plate is not likely to give way at the section b , and still less likely to break at c , because a portion of the tensile stress has been taken up by the four rivets of line a , and another portion by the rivets of line b ; so that theoretically the stress in the principal plate at these respective lines a , b , and c will be as 3, 2, and 1; while the stress at the same lines in the cover-plate will be as 1, 2, and 3.

¹ Vide *Proceedings of the Institution of Civil Engineers.*

Obviously, therefore, the joint may be improved, and the strength better equalised by adopting the form shown in Fig. 183, or still better that of Fig. 184. In the last-named joint, if we suppose that every rivet does its fair share of the work, we shall have the following stresses and effective areas:—

At line *a*, the entire pull of the tie will take effect on the plate-section $B - d$.

At line *b*, we shall have five-sixths of the tensile stress, and the net section will be $B - 2d$.

At line *c*, we shall have one-half of the tensile stress with a net section of $B - 3d$.

But at this line the stress in the cover-plate will be equal to the entire pull of the tie, and as the cover is pierced with three holes its thickness, or the aggregate thickness of the two covers, must be greater than that of the principal plate.

It will not be difficult to find the requisite proportions of plate and rivet-section for a joint formed in this or in any other manner, and it is unnecessary here to discuss the matter further. The arrangement shown in Fig. 184 is a very efficient joint, but in the ordinary practice of bridge-construction it cannot often be used except in ties composed of a single bar; and in the tension flanges of girders, the rivets are generally arranged in the manner shown in Figs. 182 and 183.

To make up the necessary section in the tension flange of a girder, it is generally expedient, and often necessary, to pile together several layers of plates, as shown in Fig. 185; and in this case it is better to avoid the use of a double-leafed cover-plate at each joint, which may be done by

Fig. 185.



arranging the joints of the several plates in consecutive steps as shown in the Fig., so that one long cover-plate is sufficient for the whole series of joints. The number of rivets between any two consecutive joints must of course be proportioned to the shearing stress; and if all the plates have the same thickness, the shearing stress will be the same as for the extreme leaf of the cover-plate, which forms a continuous cover for the whole series.

When the flange is very wide, it will often be more economical to make up each layer in two widths of plate, arranging the widths of the superimposed plates so that the longitudinal joints break joint with one another, as well as the cross-joints.

169. The Practical Weight of Tension Members.—For purposes of computation, the gross weight of a tension member per foot lineal may be expressed as in Art. 67 by $S\gamma$, in which S is the total tensile stress and γ , the practical weight of a tie, per ton of direct stress and per foot lineal of tie, including all waste.

If t denotes the working-stress per square inch of net section, we should have for a single wire, or a tie without joints, $\gamma_t = \frac{.0015}{t}$; but to make allowance for the loss of section at rivet holes, and the weight of cover-plates and rivet heads in plate joints,—or to make allowance for the weight of the overlapping swelled heads and the pins of eye-bars, we may suppose a gross sectional area which would yield the same total weight, and which is equal to the net theoretical area multiplied by a certain coefficient κ to be derived from actual examples; and we may then write $\gamma_t = .0015 \frac{\kappa}{t}$.

The coefficient κ must include, besides the above items of loss or waste, the additional metal which is unavoidably employed when the theoretic section varies continuously from point to point, as in the flanges of parallel girders. Its value varies considerably in different types of construction and for any given form the student cannot do better than to take out the actual quantities from a type drawing. The following table may serve, however, as an approximate guide, the values being derived from actual examples of well-designed work of the different classes:—

TABLE 5.—*Examples of the Weight of Tension Members.*

	Coefficient κ .
1. Single wire, or ideal tie, without connections	1.00
2. Chains of suspension bridges, composed of eye-bars with pin-connections	1.20 to 1.25
3. Tie-bars with swelled heads, including pins at end-connections	1.33
4. Flat ties with rivetted joints	1.30 to 1.40
Do. including overlap at ends	1.50
5. Plate-built girder flanges, under a nearly uniform stress	1.40 to 1.60
Do. including overlap at ends	1.50 to 1.70
6. Plate-built girder flanges under a varying stress, such as the flanges of parallel girders	1.66 to 1.90
Do. including overlap at ends	1.80 to 2.00

CHAPTER XIII.

THE WORKING STRENGTH OF IRON AND STEEL AND THE
WORKING-STRESS IN BRIDGES.

170. **Present State of the Question.**—It has already been remarked that there is a considerable difference of opinion in regard to the proper “working-stress” to be adopted in designing the proportions of an iron or a steel bridge; the “working-stress” being, of course, understood as the maximum load per square inch that can safely be permitted, and which is adopted as a standard governing the sectional area that is to be allotted to each member of the structure. In earlier times, the working-stress was always determined by simply dividing the ultimate breaking weight of the material by a certain factor of safety; and the working-stress per square inch, thus determined, was adopted indiscriminately for all cases alike; unless indeed the instinct of the engineer should reveal to him the propriety of adopting a somewhat higher factor of safety in some cases than in others. This empirical practice makes the instinct of the engineer responsible for an arbitrary adjustment of the working-stress within limits which may often differ by 100 per cent. or even more; and therefore it can hardly be regarded as possessing any scientific accuracy.

At the present time this practice is somewhat discredited, and is being more or less superseded by newer methods, which at least furnish reasons why the factor should be higher in one case than in another, and which aim at a more precise and definite adjustment of the working-stress. The newer methods which have been proposed for this purpose exhibit a wide disagreement amongst themselves, but there can be little doubt that the earlier empirical practice is destined to give way before long to some more exact and more reasonable method of treatment.

The inadequacy of a *constant* factor of safety is tacitly admitted on all hands; for practical men have always recognised the necessity of adjusting the working-stress with some regard to the nature of the load or the manner of its application; so that the only questions at issue are as to the *reasons* for this adjustment, and as to the *extent* to which the working-stress should be varied in different cases. Thus if the structure is subjected to shocks, or to the action of a rapidly moving load producing sudden and extensive variations of stress, it is the common practice to

adopt a lower working-stress than that which might safely be adopted in the case of a steady load.

This practice, which is abundantly justified by the results of experience, might be based upon several independent reasons; and when the working-stress is determined by the arbitrary judgment of the engineer, these several reasons may perhaps be reviewed and roughly estimated in the lump; but in order to base our judgment upon some tangible ground we must examine them separately so far as they apply to the question of bridge-construction.

171. Effects producible by the Rolling Load.—The several effects which are supposed to be producible by a moving load, and which cannot be produced by the same load at rest, are as follows:—

First. If the load inflicts an actual blow by falling upon the structure from a certain height, it will be necessary to consider the “impact” of the load as well as its mere weight.

Something of this kind may perhaps take place upon a public road bridge, when, for example, the wheel of a traction engine rolls over a projecting lump in the macadam and descends with a heavy bump on the other side; but in railway bridges, with well laid permanent way, there can be no such thing as a vertical “impact” of the load, in the proper sense of the term. The word is used by some writers in this connection, but is probably meant to convey a somewhat different meaning.

Second. But with the best laid permanent way there will always be certain fluctuations in the momentary pressure of the rolling load, as indicated by the motion of the bearing springs of the carriages, which may be regarded as so many dynamometers. If these local fluctuations are allowed for in estimating the effective weight or distribution of the live load, it will not be necessary to allow for them again in fixing the working-stress; but in practice these local fluctuations will be mixed up with some other and broader ones, which may be produced by the separate causes mentioned in the two next paragraphs.

Third. If the rails are laid over the bridge in a truly horizontal line, the deflection of the bridge will produce a certain curvature of the rail surface; and if we imagine this curvature to be already existing, it is evident that the advancing load when it first enters upon the bridge will undergo a downward or falling motion, which will afterwards be brought to rest and converted into an upward motion as the load enters upon the ascending part of the curve; and the upward acceleration of the moving load will react upon the bridge, producing between the wheel and the rail a pressure somewhat greater than the mere weight of the rolling load. If the deflection curve of the bridge were an unchanging figure, and if the approaching rails were laid as tangents to the deflection curve at each end, this excess of pressure would be simply the centrifugal force due to the passage of the load at the given speed along the given curve. But the deflection curve is *not* an unchanging figure, and therefore the

centrifugal theory does not correctly represent the dynamic forces which come into play when a heavy engine advances upon the undeflected bridge at a high speed, producing as it goes an elastic deflection which varies from moment to moment. For this reason the question cannot be fully examined without taking into account the vibrations of an elastic body, which must next be referred to.

Fourth. It is well known that a load when suddenly imposed will produce a momentary deflection twice as great as that due to the same load at rest.

This very important fact is illustrated every day in the action of an ordinary spring-balance. Thus if we take a common letter-balance, selecting one which works with very little friction, and if we suddenly place upon it (without shock or impact) a letter weighing two ounces, we know that the index-finger will at once be driven down the graduated scale until it points to something like four ounces, although after a few vibrations it will of course come to rest at the figure indicating the "correct weight" of the letter. The extreme position of the index-finger upon the scale shows that the maximum *stress* as well as the maximum deflection of the spring is twice as great as would be due to the same load at rest; and in the case of an elastic girder, a column, or a suspending rod, the same thing must take place irrespective of the amplitude of the vibrations, which in these cases may be so small as to escape observation.

Applying this principle to the previous question of progressive deflection under an advancing load, it is evident that when an engine is running at high speed and enters upon a bridge of short span, its weight will be applied very suddenly, if not with absolute suddenness, and will produce a momentary deflection which may, perhaps, be greater than the normal deflection by nearly 100 per cent.; and this point must evidently be considered in connection with the curvature of the path and the increased pressure due to the upward acceleration of the load, which will mutually affect each other.

The same principle of elastic vibration has also an important bearing upon the ultimate strength of materials when tested under a suddenly imposed load. Thus a bar of steel may exhibit a tensile strength of 30 tons when the load is very gradually applied; but the bar would break under a much smaller load if the weight were applied suddenly, or so rapidly as to produce elastic vibrations. In fact if the bar were perfectly elastic for all stresses up to 30 tons, we might expect to find that a load of 15 tons, suddenly applied, would be sufficient to produce a momentary stress of 30 tons, and to break the bar. In practice the bar will *not* be perfectly elastic, and, for reasons presently to be mentioned, it will *not* break under the *first* application of such a load, but it will give way in the long run if subjected to the *repeated* application of a suddenly imposed load not much greater than 15 tons.

Fifth. Some early experiments made by Sir W. Fairbairn and others, have shown that a beam or girder, whether of wrought or cast iron, may

be broken by repeatedly applying a load equal to about one-half of the static breaking load. In these experiments the stress was alternately imposed and removed by the reciprocating action of machinery ; and the inference drawn from them was, that after the beam had been strained some thousands or millions of times by the repeated application and removal of the load, the material had become “ fatigued ” or weakened by the process, so that it could no longer offer more than a certain reduced resistance.

It must be remarked that this inference was not verified by taking a piece of the “ fatigued ” material and testing its strength under a steady load ; but it was assumed that the movable load which had been employed throughout the experiment might be taken as representing the *stress* under which the beam gave way ; and the conclusion arrived at was to the effect that whenever a beam is intended to sustain a passing load for an indefinite number of times, the *ultimate strength* of the material must be taken as only equal to about one-half of its strength as ascertained by a steady load. We shall presently see that the inference *may* be incorrect, while it is certain that the conclusion can only apply to beams which are situated under the same conditions as in the experiment.

Proceeding on similar lines, but by more complete and varied methods, Herr Wöhler has instituted a series of remarkable experiments with the view of testing the strength of materials when subjected to known *alternations* of stress many times repeated. In the older experiments above mentioned, the weight of the piece itself was very small, so that when the load was removed, the stress went back again to zero or nearly so ; but in the flanges of a large girder the stress never goes back to zero, because the stress due to the dead load is always present, and the alternations between maximum and minimum are therefore considerably less than in the beams tested by Sir W. Fairbairn.

On the other hand we may sometimes have to deal with structures in which the alternations of stress are even greater than in Fairbairn’s beam ; for in some cases the stress alternates between a positive and a negative quantity, or between alternate tension and compression.

In Wöhler’s experiments these different cases were separately tested, and it was found that in all cases the bar broke with a load less than its static breaking load, but the apparent loss of strength varied according to the extent of the stress-variation, *i.e.*, according to the difference between the Max. S and the Min. S.

The detailed results will presently be stated, but in passing it may be remarked that these experiments have generally been explained on the same principle as that before mentioned, *viz.*, on the supposition that the material experiences a certain “ fatigue ” or loss of strength, which is believed to supervene after the infliction of a large number of alternations of stress ; but again it must be remarked that this inference does not appear to have been verified by taking a piece of the “ fatigued ” material and ascertaining its strength in the ordinary way.

172. Supposed Causes of the Observed Effects.—Having thus enumerated the several effects which are known or believed to be producible by the rolling load, it may be well to notice before going further that there is a very important question involved in this matter. In the first place we have seen that a load when suddenly applied is capable of producing stresses greater than those due to its mere weight. That it does produce such stresses is a fact which has been amply confirmed by experiment; and in consequence of this increased stress the bar breaks under a load which is much less than its static breaking weight.

In the second place, we have a similar fact brought to our notice by the experiments of Fairbairn and Wöhler, namely, the fact that the bar breaks under a load which is less than its static breaking load; but here the fact is attributed—not to any increase of stress, but to a decrease in the strength of the material, which is essentially a different thing. The question is then—Are we to regard these as two separate and independent facts, or may we regard them as only two different aspects of the same truth?

Bearing this question in mind, we shall first consider the results of Wöhler's invaluable experiments, and then compare them with the known effects of dynamic action.

173. Wöhler's Experiments.—The several results obtained by the successive sets of experiments¹ may be broadly stated as follows:—

1st. A number of bars of wrought iron and steel were subjected to a load which repeatedly varied between zero and a certain fixed quantity. The stress was imposed by direct tension in one series of experiments and by transverse bending strain in another series; and in each case the load was alternately applied and removed a great number of times, until the bar was either broken or had proved its capacity to endure the stress for an indefinite number of times. At first the load was fixed at something less than the supposed ultimate strength t , and was gradually reduced in the succeeding experiments until it failed to break the bar. The greatest load that the bar would bear for an indefinite number of times without breaking was thus ascertained, and was designated the "Ursprungsfestigkeit," and denoted by the symbol u .

To illustrate the process, it will be sufficient to refer to a certain series of bars of unhardened Krupp spring-steel, which were believed to have an ultimate strength of 1100 centners per square inch, as ascertained by testing some of them under a steady load. At first the repeated load was fixed at 1000 centners, and the bar broke after 40,000 repetitions. For the next bar the load was reduced to 900 centners, and the bar broke after 72,000 repetitions. Reducing the load in the subsequent

¹ These tests were carried out on behalf of the Prussian Ministry of Commerce, and are recorded in Wöhler's papers "*Über die Festigkeitsversuche mit Eisen und Stahl*," Berlin, 1870. They were supplemented and in part confirmed by the succeeding experiments of Spangenberg.

experiments to 800, 700, and 600 centners, the number of repetitions required to break the bar rose to 132,000, to 197,000, and to 468,000 times respectively. Lastly, reducing the load to 500 centners, it was found that the bar remained unbroken after enduring 40,000,000 repetitions.

The limiting stress u was therefore believed to be somewhere between 500 and 600 centners, and to be on the safe side it was taken at $u = 500$ centners per square inch for this class of steel.

For unhardened spring-steel, obtained from Mayr of Werben, the experiments also give the same values, viz., $u = 500$ and $t = 1100$.

For hardened Krupp spring-steel the lowest values are, $u = 600$ and $t = 1200$.

For wrought iron, made for axles by the Phoenix Company, the values found were, $u = 300$ and $t = 550$.

As before mentioned, the exact value of u was not generally ascertained within 20 or perhaps 50 centners; and there was a considerable disagreement between some of the results; but broadly speaking, these experiments appear to show that, in all these materials, the limiting load or straining force u is not much greater nor much less than $\frac{t}{2}$, or one-half of the ultimate static breaking weight.

If there is any difference observable between the tested materials, it is in favour of wrought iron; so that if we are to understand the figures as indicating an actual loss of strength, we must conclude that spring-steel suffers more from "fatigue" than wrought iron; and looking at the increased "loss of strength" which accrues after an increased number of repetitions, we might also infer that the weakness is not the result of a sudden collapse at the last, but is rather due to a growing decrepitude which makes its first appearance quite early in the life of the bar.

But this very human idea does not seem to be at all verified by any experiments upon the static strength of a "fatigued" bar. Thus, for example, it was found long ago by Captain James and Lieutenant Galton, that a bar of wrought iron might be broken by the reiterated application of a load equal to one-half of the static breaking weight; but taking some of the bars which had undergone without fracture a very large number of repetitions, these bars were tested *under a steady load*, to ascertain how far the weakening process had gone; and in all cases it was found that the original strength of the bar was *quite unimpaired*, although some of the bars had undergone a far greater number of repetitions than was generally required to produce fracture.¹

2d. Another important fact, ascertained beyond question by Wöhler's experiments, is that a bar may be broken by a still smaller fraction of the static breaking load, if the bar is alternately bent upwards and down-

¹ So far as these early experiments go, they seem to show that iron knows no such thing as "fatigue," properly so called; and the author is not aware of any recorded experiments by which these ancient but positive results have been disproved in a sufficiently conclusive manner.

wards, or if the straining force alternates between a certain positive quantity v and an equal negative quantity $-v$.

The experiments seem to exhibit some little disagreement; but on the average they show that, both for wrought iron and steel, the limiting load or straining force $\pm v$, applied alternately in opposite directions, is about equal to one-third of the ultimate breaking load t , as ascertained by a steady tensile stress.

Thus we have for the three principal cases the following relative values of the breaking weight a , viz. :—

TABLE 1.—*Breaking Weight by Wöhler's Experiments.*

1. Steady load, no variation . . .	$a = t$
2. Load varying between 0 and u . . .	$a = u = \frac{t}{2}$
3. Load varying between $+v$ and $-v$. . .	$a = v = \frac{t}{3}$

3d. Wöhler also investigated some intermediate cases, in which the load was repeatedly made to alternate between two positive values, a Min. S and a Max. S. The most complete results were those obtained with unhardened Krupp spring-steel having an ultimate tensile strength of about 1100 centners per square inch; and it was found that bars of this material might be broken by repeatedly causing the load to vary between either of the following pairs of limits, viz. :—

TABLE 2.—*Breaking Weight by Wöhler's Experiments—continued.*

	Min. S.	Max. S.	a .
4. Load varying between 250 and 700 centners			700
5. " " " 400 and 800 "			800
6. " " " 600 and 900 "			900

The limiting loads were ascertained in each case by a descending series of tests, and were only fixed within a probable error of about 50 centners.

174. **Vibrations of an Elastic Body.**—To ascertain what stresses can be produced by a load suddenly imposed or suddenly varied, we may adopt a very simple method. In Fig. 187, let the elastic *strains* be represented by the horizontal distances OC , OB , &c., and let the accompanying *stresses* be represented by the corresponding ordinates CF_1 , BD , &c., so that the figure OBD will form what is called a stress-strain diagram. Within the elastic limit the stress is directly proportional to the strain, and therefore the stress-strain diagram will consist simply of a straight inclined line OD . The diagram will apply to any kind of elastic strain, whether in tension or compression, and would also apply to the elastic deflection of a beam or spring if the vertical scale of the diagram were suitably chosen. For the present purpose, however, the scale of the diagram is of no importance; and in order to obtain a

magnified view of the elastic vibrations which take place in a short strut or tie, we may suppose the vibrations of the bar to be represented by the larger vibrations of the spring of the letter-balance before referred to, the linear depression of the spring being denoted by any abscissa OC , while the corresponding ordinate CF_1 represents the resistance offered by the spring, or represents the weight of a letter which would be exactly balanced with that particular depression of the spring.

In depressing the spring from O to C , the mechanical work performed in overcoming the increasing resistance of the spring is represented by the area of the triangle OCF_1 ; but if this depression is effected by the application of a constant force $OF = CF_1$, or by the constant weight of the letter, the energy expended up to this point will be represented by the area of the rectangle OCF_1F . The energy expended is therefore greater than the work performed in compressing the spring, and the surplus has gone to the performance of another kind of work, namely the work of acceleration, by which the momentum of the moving weight

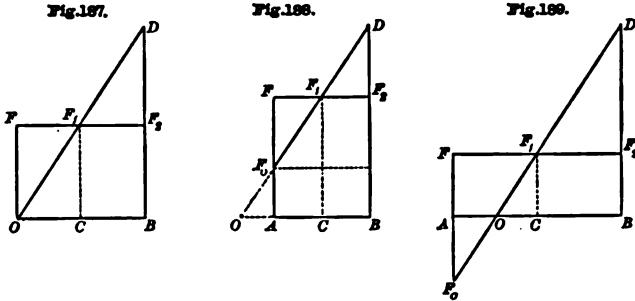

(including a part of the spring) has been raised to a certain value, and this momentum, aided by the weight of the letter, carries the spring forward beyond the point C for a further distance of $CB = CO$. In other words, the surplus of energy represented by the area FF_1O , expended in the earlier part of the stroke, has been stored up as kinetic energy, and is restored during the subsequent part of the stroke, as represented by the area F_1F_2D , which is equal to the area F_1FO of the stored energy. The depression of the spring will therefore go on until a point is reached when the whole energy expended by the weight is equalled by the whole work of overcoming spring resistance; *i.e.*, it will only stop when the triangular area OBD is equal to the area of the rectangle OBF_2F .

Of course when the spring reaches the point B , its elastic pressure is greater than the load, and it will therefore at once commence a retrograde motion, reversing each one of the previous steps; and in this way it would go on vibrating between the points B and O for an indefinite period, or until it was finally brought to rest at the point C by the brake action of the frictional resistances.

But referring again to the momentary position at B , it is evident that the extreme depression or elastic strain OB is exactly equal to twice the normal depression OC , and that the momentary stress BD is exactly equal to twice the load OF .

We may designate the momentary stress BD as the "dynamic stress" Ω due to a suddenly imposed load $Q = OF$; but it will be noticed that the dynamic stress is not due to any shock or blow or any such thing; on the contrary the stress $\Omega = 2Q$ will be momentarily produced every time that the elastic bar or spring is strained by the application of a constant force Q which suddenly comes into action at any given instant and continues its action uniformly for a sufficient length of time to produce the single vibration OB .

Proceeding now to the stresses produced by any sudden variation of the load, we may first take the case of a bar or spring which has already been strained by an initial load P , and having attained a condition of equilibrium under that load, is suddenly subjected to an additional load Q . In Fig. 188, let OBD represent, as before, the stress-strain diagram, and let OA denote the initial strain and AF_0 the initial stress, the latter being of course equal to the initial load P . Then if F_0F represents the additional load Q which is instantaneously applied, the diagram of energy for the whole load $P + Q$ will be the rectangle ABF_2F , while the diagram of work performed in compressing the spring will be the figure $ABDF_0$; and, as before, the depression of the spring will not stop until these two areas are equal. Therefore we shall have $F_2D = F_0F$, and $BD = AF_0 + 2F_0F$. In other words, the momentary "dynamic" stress will be $\Omega = P + 2Q$; although the apparent stress is only $P + Q$, if "stress" is understood to be synonymous with load or straining force.

In the same way, if the initial load or straining force is a negative quantity ($-P$), as represented by the downward ordinate AF_0 in Fig. 189; and if the bar is suddenly subjected to a straining force Q of the opposite kind, as represented by the total height F_0F , we shall again have the momentary stress $BD = 2F_0F - AF_0$, or $\Omega = 2Q - P$; although the apparent stress due to the same loads at rest would of course be CF_1 or $Q - P$.

Denoting the initial stress AF_0 in Fig. 188 by Min. S , and the apparent stress CF_1 (due to the increased load) by Max. S , we may express the above results by saying that when the load is suddenly increased from Min. S to Max. S , the bar will be subjected to a momentary stress exceeding the stress Max. S by the quantity ω which we may call the "dynamic increment;" and it will be seen that whether the initial stress Min. S is positive or negative or zero, we shall always have $\Omega = \text{Max. } S + \omega$, in which the "dynamic increment" ω represents simply the magnitude of the change of load F_0F —or algebraically $\omega = \text{Max. } S - \text{Min. } S$.

We have, from the first, taken care to distinguish between the internal stress and the external load or force to which that stress may

be due. The word "stress" is very commonly used as though it were synonymous with the load or straining force; thus when the forces which act upon the different members of a girder have been calculated by the principles of equilibrium, these forces are commonly termed the "stresses;" but we have at the outset defined stress as the internal force exerted and endured by the bar, *i.e.*, the actual pressure or tension between the particles of the strained material; and it is now evident that this quantity must not be taken as synonymous with the load. The stress is equal to the load *when the bar is in equilibrium*, but at any other time the load is not a reliable measure of the internal stress; and if any vibrations are produced in the bar, the stress will be alternately greater and less than the amount due to the load at rest.

175. Comparison between the Effects of Dynamic Action and the supposed Effects of Fatigue.—If we try to strain a bar gradually up to a certain stress by adding successive increments of load, the preceding article has shown that the operation will have to be conducted with great delicacy if we wish to prevent any vibration that would carry the stress beyond the desired point. After applying each additional weight we must allow sufficient time for the bar to regain its equilibrium; and as we get nearer the desired ultimate load, the successive increments of weight must be made smaller and smaller, as otherwise the vibration produced by the imposition of the load-increment would carry the stress beyond the amount aimed at.

Moreover, in the case of a short test-bar, it must be remembered that the presence of such vibrations could hardly be detected by the senses, for their amplitude would be so small and their rapidity so great as to render them nearly or quite invisible. Thus a steel tie-bar, one foot in length, would perform the vibration from *O* to *B*, or back again from *B* to *O* in the sixtieth part of a second, if suddenly subjected to a load of 10 tons per square inch.

Bearing these facts in mind, it is perhaps permissible to doubt whether the apparatus employed by Herr Wöhler did in fact succeed in limiting the internal stress to the intended amount without exceeding it, and whether the bars were not really subjected to the action of dynamic stresses every time that the load was applied, which was done about four times in a minute.

Without pronouncing an opinion on this point, we may at all events proceed to see what would be the effect if the load were each time applied as a constant force, commencing its action at a sharply defined period of time, and continuing its action for at least $\frac{1}{60}$ th of a second.

Referring, then, to the diagrams already given, it is easy to see that the load CF_1 , which is required to produce a given dynamic stress BD , will vary according to the initial stress AF_0 , and will always be the mean between those two stresses; *i.e.*, $CF_1 = \frac{AF_0 + BD}{2}$, in which AF_0 may be either positive or negative.

Thus if the initial stress is zero, as in Fig. 187, we have simply $CF_1 = \frac{BD}{2}$; and if we make AF_0 a negative quantity equal to $\frac{BD}{3}$, as in

Fig. 189, we shall have $CF_1 = BD \left(\frac{1 - \frac{1}{3}}{2} \right) = \frac{BD}{3}$.

Therefore if BD represents the ultimate tensile strength t as ascertained by a steady load, and if we assume that the bar is perfectly elastic for all stresses up to t , we shall have the following values of the breaking-load α for the three principal cases:—

TABLE 1a.—*Breaking Load by Dynamic Theory.*

1. Steady load, no variation . . .	$\alpha = t$
2. Load varying from 0 to u . . .	$\alpha = u = \frac{t}{2}$
3. Load varying from $-v$ to $+v$. . .	$\alpha = v = \frac{t}{3}$

These values are identical with those given in Table 1, as the broad results of Wöhler's experiments.

Again, if the load varies suddenly between two positive quantities Min. S and Max. S, the value of the breaking load will depend upon Min. S; and for the purpose of comparison with Wöhler's results it may easily be shown that a momentary stress of 1100 centners would be produced by variations of load between the following pairs of limits:—

TABLE 2a.—*Breaking Load by Dynamic Theory—continued.*

	Min. S.	Max. S.	α .
4. Load varying from . . .	250	to 675	675
5. Do.	400	to 750	750
6. Do.	600	to 850	850

Comparing these figures again with those given in Table 2, it will be seen that the difference is only trifling, and is within the probable errors of the results, as mentioned in Art. 173; so that in all cases the breaking weight as calculated from the dynamic effect of the load, coincides practically with the breaking weight observed in Wöhler's experiments.

Of course if we are to regard those experiments as revealing a special physical phenomenon, called "the fatigue of metals," it will follow that these two sets of results must be entirely independent and unrelated to each other, and their remarkable coincidence at every point in the scale must be purely accidental.

On the other hand, if we regard Wöhler's facts as only exemplifying in practice the effects of dynamic action, we may then take Wöhler's experiments as proving exhaustively that there is no such thing as fatigue in iron and steel—or in other words, that the material may always be relied upon to sustain a certain ultimate stress, undiminished by any repetitions or variations of the load.

Between these two opposite views it is necessary to make a definite choice. It is true that the facts might have been stated in such language as to avoid raising the question ; but it is really impossible to determine the proper working-stress in bridges by any rational method without making an open or an implied choice between the above-named alternatives, which are essentially irreconcilable.

As against the theory of dynamic action, the following facts may possibly be urged :—1st. In practice the bar is *not* perfectly elastic for all stresses up to the ultimate stress t . 2d. Wöhler's experiments show that a load considerably greater than $\frac{t}{2}$ may be alternately applied and removed a good many times *without producing fracture*, although it will certainly break the bar in the long run. 3d. Mr. Kircaldy has shown that in order to break a bar by a single application of a load suddenly imposed, the load must be *greater* than $\frac{t}{2}$. If we proceed to consider briefly the vibration of the bar beyond the elastic limit, it will be seen that these facts explain one another, and go to confirm the theory of dynamic action.

176. Dynamic Action beyond the Elastic Limit.—The form of the stress-strain diagram, beyond the elastic limit, is known to vary widely in different bars according to the degree of their ductility. Up to the elastic limit, or the point E in Fig. 190, the diagram consists of the straight inclined line OE as already mentioned ; but if the stress is still

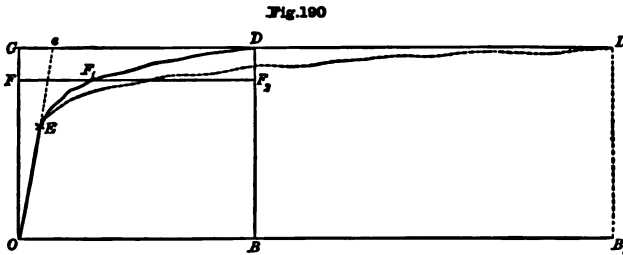

further increased by a gradual increase of the steady load, the strains are found to increase much more rapidly than before, so that the diagram no longer follows the straight line OEe , but diverges away very rapidly to the right as shown by the line OED or perhaps by the line OED_1 .

Beyond the elastic limit, the observed strain or elongation of the bar does not consist solely in an elastic stretch, but is partly and in much greater measure due to a plastic deformation or drawing out of the metal, accompanied apparently by a permanent rearrangement of the molecules ; and if the stress is removed, this plastic deformation remains as a "permanent set"—the elastic recovery of the relieved bar being approximately (though not quite exactly) represented by the length Ge or the

space contained between the lines OG and Oe , so that almost the whole of the remaining strain eD represents "permanent set" or a permanent drawing out of the plastic material.

The extent of the ultimate elongation eD varies of course according to the ductility of the material; in cast iron it is almost nothing, and the diagram is therefore nearly a straight line; in wrought iron the ultimate elongation eD may sometimes amount to 5 per cent. of the total length of the bar, and in other bars it may amount to 25 per cent., as already stated in Chapter XII.; while the ultimate elongation in different classes of steel varies still more widely. In different bars, therefore, the stress-strain diagram may assume any form between two probable limits, which, for the sake of illustration, may be represented by two such lines as Oe and OED_1 .

But in addition to this, it must also be remarked that when the load is suddenly imposed and allowed to produce dynamic vibrations, the form of the stress-strain diagram may differ considerably from that which is observed under a slowly increasing stress. On this point very little is known with any certainty; some experiments show that when the bar is suddenly broken its ultimate elongation is much less than when it is gradually stretched to the breaking point, while others appear to show that the elongation may be as great in one case as in the other; and probably the question will depend in great measure upon the quality of the individual bar. But it may perhaps be reasonable to assume that if OED_1 represents the diagram for a gradually stretched bar, the diagram for a suddenly stretched bar will follow *some* intermediate line between e and ED_1 , such for example as the intermediate line ED .

Taking then the line OED as representing the stress-strain diagram (*whatever* form it may assume in a particular bar), it is evident that the total work consumed in the stretching and fracture of the bar will be represented by the area $OEDB$; and dividing this area by the length OB , we obtain the mean resistance OF , which is obviously an exact measure of the force, which when suddenly applied will be just sufficient to break the bar.

Owing to the great bend in the line of the stress-strain diagram, the value of OF is evidently *greater* than $\frac{BD}{2}$, and may in some cases be very much greater. Indeed it is easily seen that a bar of very ductile material might require a load equal to 90 or 95 per cent. of the static breaking load, while a bar of very brittle steel would be broken by the sudden application of a weight not much greater than 50 per cent. of the static breaking load. Mr. Kircaldy's experiments show that the suddenly imposed load which is required in order to break a wrought-iron bar *at one single application* varies from 75 per cent. to 90 per cent. of the static breaking weight, and looking at the wide difference between the ultimate elongations of different bars, these results are no more and no

less than might be expected from the dynamic action of the suddenly applied load.

But again, let the line OED in Fig. 191 represent the same diagram of strain, and suppose the bar to be subjected to a sudden load OF equal to half the static breaking weight BD . Then to find the momentary deflection OH , we must make the area $OEKH$ equal to the rectangular area OFF_2H ; or in other words, the area F_1KF_2 must be equal to the triangular area OFF_1 . But these areas being equal, it is obvious that F_2K will be less than OF , and therefore the extreme momentary stress HK will not reach the value $DB = 2OF$.

Fig. 191

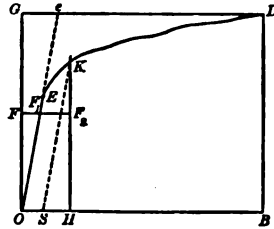

This diagram illustrates the difference between the vibrations of a perfectly elastic bar and of one which is not perfectly elastic; and it explains the reason why the load OF fails to break the bar at the first application, but is almost certain to produce that result in the long run if it is repeated a sufficient number of times.

The perfectly elastic bar is compressed or extended along the line Oe , and the return vibration follows along the same line eO , so that no energy is actually lost in these vibrations. Therefore in theory the vibrations will go on for ever, or at least for a long time, as in the case of a tuning-fork; and at the end they leave the bar in the same condition as at the beginning.

But when the bar is imperfectly elastic, a portion of the energy expended by the force OF is devoted to the work of plastic deformation, and this portion of the work is *not* restored on the return vibration. This only amounts to saying that the bar is imperfectly elastic, but the meaning and consequences of that fact will be more clearly apparent if we trace them upon the diagram. The motive force available to start the return vibration is the diminished force F_2K ; and the return vibration effected by the elastic reaction of the bar, will be performed along the line KS parallel to eO or nearly so. Therefore if the bar returns to the condition of no stress, the whole cycle of operations will be represented by the diagram $OEKSO$, which like the indicator-diagram of a steam-engine represents the energy expended at one stroke in doing work, *i.e.*, in drawing out the plastic material by the elongation OS which represents the permanent set.

It is obvious therefore that if the bar is left alone after applying the load OF the vibrations will very soon come to rest, because each vibration entails a considerable loss of energy; but at the end they will *not* leave the bar in the same condition as at the beginning, for the "permanent set" OS is permanent, and represents so much effected towards the final destruction of the bar.

It is true that the extreme stress HK is only in operation for an

infinitesimally short period of time, and it is therefore probable that it only accomplishes a very small fraction of the ultimate elongation of the bar; but if it accomplishes *anything*, however small, the bar must ultimately be broken if the same effect is repeated for a sufficient number of times.

Every time the load is applied, the bar must either vibrate as a perfectly elastic bar along the line Oe , or as an imperfectly elastic bar along some line EK , diverging more or less from the line Oe . In the former case the breaking stress BD will be inflicted at the first application of the load, while in the latter case the load will produce some permanent elongation, which must ultimately destroy the bar if the same effect is repeated *ad infinitum*.

For the present purpose, therefore, it is unnecessary to ascertain the exact curve of the stress-strain diagram, which, as we have said, will vary according to the softness or ductility of the bar. In very brittle steel the full dynamic effect will be produced almost at the first application; while in tougher metal the fracture of the bar will not be prevented but only postponed.

There is one point, however, which it may be well to notice. The stress-strain diagram, as determined by a gradually increased load, shows that a certain portion of the work of plastic deformation can be performed by a moderate stress, but other portions of the work seem to require a higher stress. Now if we suppose a certain stress HK to have been repeated so often that it has already accomplished all the elongation that can be produced under that stress, the result would of course be that the next application of that stress would produce *no further* elongation or permanent set, and this is the same thing as saying that the bar would be perfectly elastic up to the stress HK .

This is exactly what takes place in practice; for it is found that after a bar has been repeatedly strained beyond the elastic limit, the elastic limit is generally raised, though it has not perhaps been ascertained by experiment how far it would be possible to carry that process.

It will be noticed, however, that this raising of the elastic limit must have the effect of developing still further the dynamic action of the load; for we must now trace the vibrations upon a new stress-strain diagram in which the line OE is lengthened, *i.e.*, the elastic limit E must now be placed at the higher stress. The momentary stress HK produced by any given load OF will therefore be greater than before; and will therefore be sufficiently high to go on with the work of plastic deformation, and to accomplish those ulterior portions of it which demand a higher intensity of stress.

We have here sketched the gradual destruction of the bar as though it were effected at successive steps—first drawing out the metal as far as it will go with a given stress, then raising the stress (by reason of the raised elastic limit) and going on with the work to a further stage, and

so on. In practice there would of course be no marked stages or periods in the progress of these changes; but if the load $OF = \frac{BD}{2}$ is suddenly applied for an indefinite number of times, it is difficult to see how the process could stop until the bar was either rendered perfectly elastic for all stresses up to BD , or else broken by the accumulated elongation or indefinite attenuation of the bar.

If this is so, it is evident that the principles of elastic vibration, as described in Article 181, may for the present purpose be applied also to bars strained beyond the elastic limit, provided that the strain is repeated *ad infinitum*; and it is also evident that the whole of Wöhler's results may be accounted for by the dynamic action of the load, and without supposing any "fatigue" whatever.¹

177. **General Conclusions.**—The facts substantiated by Wöhler's experiments must certainly be taken as the basis of any rational practice; but in determining the working-stress in bridges, everything will depend upon the way in which we interpret those facts.

The dilemma may be stated as follows:—The observed failure of Wöhler's test-pieces under a repeated load which was less than the static breaking load, was either due to an actual diminution of the ultimate strength (called fatigue) or it was not.

1st. If due to fatigue—then the formulæ which have been devised to represent Wöhler's results, such as the formulæ of Launhardt and Weyrauch for example—must be regarded as totally inadequate to determine the working-stress in bridges; because, *ex hypothesi*, they make no allowance for the dynamic action of the rolling load.

Apart from Wöhler's results, it is perfectly well established by experiment as well as theory, that the suddenly applied or suddenly reversed load will produce a stress which may be twice or three times greater than its weight; and if fatigue is another and independent phenomenon, we must allow not only for the increased stress but also for the diminished resistance.

This view is, in fact, adopted by many authorities; but if logically carried out it would lead to some very extreme consequences. For example:—

a. A plate-iron tie will perhaps have an ultimate strength of 20 tons per square inch, when steadily loaded.

b. Another bar, which is subject to a load varying suddenly from zero to a certain quantity, will have to endure a stress twice as great as the load, but at the same time its strength will be reduced to one-half,

¹ That is to say, without any reduction in the ultimate strength of the bar. It is obvious that when the bar has been repeatedly strained beyond the elastic limit, and when the elastic limit has been raised by the process above described, we should expect to find a certain reduction in its capacity to endure work; and there can be no objection to the use of the word "fatigue" as describing *this* particular fact, which appears to be indisputable, although its bearing is quite different from that attributed to "fatigue," as it is sometimes understood.

and therefore its *breaking load* will be reduced to one-fourth, or 5 tons per square inch.

c. Another bar, subjected to sudden alternations of tension and compression, will be liable to a stress three times as great as the load, while its strength is at the same time reduced to one-third; so that its breaking load will be reduced to one-ninth, or say $2\frac{1}{4}$ tons per square inch.

There are besides some extreme cases in which the dynamic action of the rolling load is known to be even greater than in the bar *c*; and to be consistent, we must apply the same factor of safety to all these cases alike, so that the bars would have to be proportioned by adopting some such values of the working-stress as the following:—

	Factor of Safety=2.	Factor of Safety=3.
For bar <i>a</i> ,	10 tons per square inch ;	$6\frac{2}{3}$ tons per square inch
" <i>b</i> ,	$2\frac{1}{2}$ " "	$1\frac{2}{3}$ " "
" <i>c</i> ,	$1\frac{1}{3}$ " "	$\frac{2}{3}$ " "

And whatever factor we may adopt, we shall either have an excessively high working-stress in *a*, or else an excessively low working-stress in *b* and *c*.

But such an extreme view of the case is certainly not warranted by the results of experience.

2d. If we reject the first alternative, we must accept the opposite one—viz., that Wöhler's facts are to be attributed to dynamic action, and not to fatigue.

With this understanding we may accept the Launhardt-Weyrauch formula as the basis for calculating the working-stress, in all cases where the variation of load is instantaneous or nearly so, but not in cases where the variation of load is very gradual.

But if we understand Wöhler's results as being the effect of dynamic action, there seems to be no reason why we should not express them by the simple formula for dynamic stress already given in Art. 181, viz., $\Omega = \text{max. S.} + \omega$; for having accepted the theory of dynamic action and rejected the theory of fatigue, it is evident that the unknown quantity which we are in search of is—not the strength of the material, but the real value of the internal stress produced by the rolling load.

178. Different Methods of Determining the Working Load. *First Method.*—We have already said that the old rule consists in adopting a *uniform* working-stress, which has been fixed by different authorities at 5 tons per square inch for wrought iron, and $7\frac{1}{2}$ tons per square inch for steel, or at some figures approximating to those values.

This rule is arrived at either by employing a certain factor of safety (equal to about 4) as applied to the ultimate strength of the material, or by employing a smaller factor of safety as applied to the elastic limit. As regards the latter method, we have seen that the elastic limit is not really a fixed quantity, but may be arbitrarily raised by merely giving the bar a little preliminary practice; while the raising of the elastic

limit in this way will not at all strengthen the bar to resist a repeated stress or to carry a steady load.

However, whether the rule is derived in one way or the other, its effect is that a constant working load is prescribed for all cases alike without regard to any difference in the manner of loading. But experiment shows that the breaking load is quite as much affected by the manner of loading as it is by the nature of the material. The tensile strength of cast iron, wrought iron, and mild steel are nearly as 1, 2, and 3, and are not more widely different than the observed breaking load of wrought iron under the three principal conditions of loading. Therefore to use the same working load in all three cases is almost as rough a method as to use the same working-stress for all three materials.

For this reason the *real* factor of safety attained by the use of the old rule must be regarded as a widely varying quantity, which in some cases may correspond with the nominal factor of safety of four, but in other cases will be very much smaller than that figure, and it would be a great mistake to suppose that by using this rule, the bridge will be made strong enough to carry a load equal to nearly four times its actual load.

Second Method.—The old rule has sometimes been modified by employing *two* values of the working-stress—one for the flanges or principal members of the structure, and another lower one for the bars of the lattice bracing. Thus if the tension flange is designed for a working-stress of 5 tons per square inch, the lattice bars may perhaps be designed for a working-stress of 3 to $3\frac{1}{2}$ or 4 tons per square inch.

Such a modification is certainly justifiable, because the variations of load in the lattice bars are greater than in the flanges; but it only attains to a rough approximation, because in some of the lattice bars the variation of load is very little if at all greater than in the flanges, while in others it is very much greater.

Third Method.—Another modification consists in the employment of two factors of safety—one for the dead load, and another higher one for the rolling load. To carry this method out in practice, we may multiply the known weight of the rolling load by a certain coefficient, and then having calculated the max. S in each bar for the combination of dead load and augmented rolling load, we may design all the members for the same working-stress throughout.

This method appears to yield a closer approximation than the last, but it takes no account of the violence with which the moving load may be applied, or of the magnitude of the resulting changes of stress in the different members; and as compared with the indications of Wöhler's experiments, it provides too little strength in the central lattice bars which may be subjected to alternate tension and compression.¹

¹ Some American engineers add the tensile stress and the compressive stress together. If this plan is adopted *along with* a higher factor of safety for the rolling load, it goes beyond the requirements as indicated by Wöhler; but if the rolling load is treated with the same factor as the dead load, the American plan makes no allowance for those members which are subject to a stress varying between two positive quantities.

Fourth Method.—In recent times an endeavour has been made to fix the working-stress more accurately in accordance with Wöhler's ascertained results.

To express those results as nearly as they can be gathered from the experiments, Launhardt proposes the following formula for the breaking load of a member which is subject to stresses (*i.e.*, apparent stresses) varying between two positive quantities min. S and max. S, viz:—

$$a = u \left(1 + \frac{t - u}{u} \cdot \frac{\text{min. S}}{\text{max. S}} \right) \dots \dots \dots (1)$$

In this expression *a* is the breaking weight, or the so-called working-strength of the bar; while the symbols *t* and *u* represent the experimental quantities designated by those letters in Table 1, Art. 180.

To apply this formula for purposes of design, it is only necessary to divide the calculated strength *a* by the adopted factor of safety F, and the result will be the proper working-stress for any tie which is subject to stresses alternating between min. S and max. S. But when the formula is used to find the breaking load *a* = max. S for a bar which is subjected to a given initial stress min. S, we must write it in the form—

$$a = \text{max. S} = \frac{u}{2} + \sqrt{\frac{u^2}{4} + (t - u) \text{min. S}} \dots \dots \dots (1a)$$

The values yielded by the latter formula are of course meant to coincide with the experimental results, which have been given in Table 2, and they do so pretty nearly though not more exactly than the values deduced by the dynamic theory in Art. 181.

The authorities, however, are not quite agreed as to the value that should be taken for the ratio *u* : *t*. In a few of Wöhler's experiments *u* appears to be greater than $\frac{t}{2}$ and more like $\frac{2}{3}t$. The latter value is assumed by Weyrauch, who is thus enabled to construct a general formula which shall apply to all ratios of min. S to max. S, whether min. S be positive or negative. For taking $u = \frac{2}{3}t$, the fraction $\frac{t - u}{u}$ in Launhardt's formula becomes equal to $\frac{1}{3}$. But the value of *v*, as given in Table 2 for alternate tension and compression, is equal to $\frac{t}{3}$; and therefore the fraction $\frac{u - v}{u}$ is also equal to $\frac{1}{3}$. Weyrauch extends the method of Launhardt to cases of alternate tension and compression by applying to those cases the formula $a = u \left(1 + \frac{u - v}{u} \cdot \frac{\text{min. S}}{\text{max. S}} \right)$ in which min. S is the negative stress; and therefore by taking *u* at the extreme value of $\frac{2}{3}t$, Weyrauch is enabled to include every case under the general formula—

$$a = u \left(1 + \frac{\phi}{2} \right) \dots \dots \dots (2)$$

in which ϕ denotes the fraction $\frac{\text{min. } S}{\text{max. } S}$, which may be either positive or negative.¹

This is the Launhardt-Weyrauch formula, which is now being used by some engineers to fix the varying value of the working-stress in the different members of bridges. It is intended to represent simply the reduced strength a of the material, as shown (apparently) by the results of Wöhler's experiments; but we have already seen that if those results are attributed to fatigue, this formula cannot be used alone for the working-stress of bridges, because it makes no allowance for the dynamic action of the rolling load; although it may perhaps be so employed if Wöhler's results are understood in the contrary sense as being the direct effect of dynamic action.

If this method is employed, the working load will be expressed by $\frac{a}{F}$, in which F is a factor of safety (usually 3); so that for wrought iron plates having a tensile strength $t = 20$ tons, we should have $u = 20 \times \frac{2}{3} = 13.33$, and dividing by the factor of safety (3), we have—

$$\text{Working load} = 4.44 \left(1 + \frac{\text{min. } S}{2 \text{ max. } S} \right) \quad \dots \quad (2a)$$

Fifth Method.—Recognising the necessity of making some allowance for dynamic action, or “impact,” as it is often called, those engineers who believe in “fatigue” as a separate phenomenon, take the consistent course of first allowing for impact and then making a further allowance for “fatigue.” Numerous formulæ have been proposed for this purpose, among which may be mentioned those of Gerber, Seefehluer, Schäfer, and Winkler; but we have already seen that such a theory must inevitably lead to very extreme results, and it may be mentioned that these formulæ lead generally to a working-stress of about $1\frac{1}{2}$ tons per square inch for members subject to alternate tension and compression, while they allow a stress as high as $9\frac{1}{2}$ to 11 tons per square inch for girders carrying a dead load—an estimate which is not likely to meet with the approval of any government authorities in this country.

On the other hand, if this theory were true, it would follow that members subject to alternate tension and compression $\pm v$, ought to *break* under a load of about 3 tons per square inch; and as there are many bridge members which have withstood for years higher alternating stresses without failure, we may safely conclude that there is no justification for making a separate and full allowance for both “impact” and “fatigue.”

179. Alternative (Dynamic) Method of Determining the Required Sectional Area.—If the effects of elastic vibration are really such as

¹ There seems to be no reason for taking this extreme value of u , except for the sake of convenience in constructing the formula; for, as before observed, the majority of Wöhler's experiments indicate that u is nearly equal to one-half of t .

have been described, it follows that we need make no allowance for fatigue, but only for "impact," or dynamic action, whose theoretical effects are experimentally illustrated and confirmed by Wöhler's results.

For practical purposes we might perhaps express those results by Weyrauch's formula; but this would be far less convenient than the equivalent dynamic formula, and moreover would make the working strength to depend solely upon the *range* of stress variation without regard to its violence.

For example, suppose that we have to deal with two opposite cases in which the degree of violence is widely different—the first case may be that of a dock-caisson, in which, owing to the rise and fall of the tide, the stress varies between Min. S and Max. S, once every six hours, the change taking place by slow and imperceptible degrees; while the second case may be that of a cross-girder in a railway bridge, which may undergo the same variation of load almost instantaneously, together with the violent vibrations which accompany the passage of an express train. It would be contrary to common sense to suppose that these variations of load are equivalent to one another in their destructive tendencies; but if the *range* of stress variation is the same, the Weyrauch formula would give the same working strength for both structures.

To apply the dynamic theory in practice we have only to find the momentary internal stress Ω by adding the dynamic increment ω to the calculated load Max. S. When the change of load is effected instantaneously we have already seen that $\omega = \text{Max. S} - \text{Min. S}$; and if the time occupied in effecting the change is very great we have the other extreme case in which ω is nothing. For intermediate cases we may express the dynamic increment by $\omega = \eta (\text{Max. S} - \text{Min. S})$, in which η is a coefficient depending upon the violence or time rate of the load changes.

In determining the coefficient η for any given case, we ought to include the dynamic effect of the rolling load as augmented by its centrifugal force in passing over the deflection curve—the complexity of this question has been referred to in Art. 178; and we should also include some further allowance for those cumulative vibrations which cannot be calculated, but which result from the lateral impact of the wheels against the rails from the isochronous impulses delivered by the mechanism of the engine, or delivered by the elastic spring of the floor-stringers and cross-girders and from other causes.

With all these sources of vibration in view, it would be almost useless to attempt any theoretical computation of the intermediate values of η for given velocities of train and given lengths of span. At the same time it would be only reasonable to pay *some* regard to the varying conditions of different structures, not only as regards the range of the stress changes but also as regards their violence.

In the case of cross girders and vertical suspenders, there can be no doubt that we should allow for the full value of the elastic vibrations due to a sudden imposition of the load; and it will be safest to follow

the same rule for all the diagonals of the web bracing ; so that for all these members we shall take $\eta = 1$ or $\omega = \text{Max. S} - \text{Min. S}$.

In the flanges of a girder, or in the principal members of an arch or suspension bridge, the stress-changes take place more gradually, and the value of η may be correspondingly reduced. This reduction should probably bear some unknown proportion to the length of the span ; but in default of experimental data it will be safest to adopt nothing less than $\eta = \frac{1}{2}$, and the observed deflection of small bridges under a rapidly moving load seems to indicate that this value will be sufficiently great for all spans down to about 100 feet. For spans of 10 or 20 feet, the main girders should no doubt be treated on the same basis as cross girders ; and for spans intermediate between 20 and 100 feet, intermediate values of η may be interpolated.¹

In public road bridges the dynamic increment of stress may reach a much higher value under the measured march of infantry ; and in this case the amplitude of the vibrations would probably depend upon the coincidence or otherwise of the step period with the natural period of vibration of the loaded bridge ; but this dangerous effect is so well known that troops are generally ordered to fall out in crossing a bridge. With this exception, the greatest dynamic action to which public road bridges are liable is that vertical impact which results from the trotting of heavy cattle or the running of a mixed crowd ; and in most cases the above values of ω will probably be sufficient.

In applying this method, the real factor of safety may be taken at the same value as in the Weyrauch formula, and the constant working-stress for all tension members will then be $\frac{t}{3} = 6.66$ tons per square inch in wrought-iron ties, and applying the same factor in compression, the working stress will be 5.33 tons per square inch.

On the other hand, the augmented stress will in all cases be $\Omega = \text{Max. S} + \omega$; and the required sectional will be

$$\text{For ties } A = \frac{\text{Max. S} + \omega}{6.66} (3)$$

$$\text{For struts } A = \frac{\text{Max. S} + \omega}{5.33} (3a)$$

$$\text{For cross girders and web bracing } \omega = \text{Max. S} - \text{Min. S} (2b)$$

$$\text{For flanges of girders above 100 feet } \omega = \frac{\text{Max. S} - \text{Min. S}}{2} (2c)$$

The areas given by these formulæ will be found to coincide with the average of modern practice more closely than those given by the old rule ; for although that rule has been nominally consulted in the design of most existing bridges, yet in practice it has always been modified in

¹ *Vide* some later experiments quoted in Art. 188a.

some arbitrary manner in order to comply with those recognised conditions which it is certainly unable to meet.

180. The Factor of Safety.—To insure the safety of bridges it will be imperatively necessary to make use of such a factor of safety as may have been proved by practical experience to be wide enough to cover the unknown extent of our ignorance.

For that purpose the old rule of 5 tons per square inch for wrought iron, giving a nominal factor of 4 all round, has been proved to be almost always sufficient. And this fact is generally taken as a starting-point from which to determine the factor of safety that is properly applicable to any other rule. In employing any one of the newer methods above described, it must not be supposed that they are designed to provide in all cases a more liberal sectional area than would be required by the old rule. That result would of course follow if in all cases a factor of 4 were applied to the ultimate strength as reduced by the supposed "fatigue." But it is held, and with very good reason, that the old rule does not insure a *real* factor of safety equal to 4 or anything like it; for in whatever manner we may interpret Wöhler's results, they show unmistakably that when the old rule is used for all girders alike, and for all members alike, the real factor of safety will only occasionally be as large as 4, while in many cases it cannot be greater than 2, and may be even considerably less.

Therefore, if the new methods are sound, and can show a real factor of safety which is never less than 3, their employment in place of the old rule will result in making the bridge quite as strong as before—and indeed 50 per cent. stronger, because the strength of the whole structure will be limited by the strength of its weakest part.

Accordingly all the newer methods fix the working load at something greater than 5 tons when the load is unchanging, and at something less than 5 tons when the changes are very extensive. But the amount by which the old standard is raised at one end of the scale and depressed at the other end depends upon the view taken of "fatigue." And upon this also depends the value of the professed factor of safety. These points will be more clearly illustrated by the following graphic comparison of the different methods.

181. Comparative Results of the Different Methods.—The working-load, as determined by each of the foregoing methods, is shown in Plate H, Fig. 192, by the several lines *TUV* of the diagram, which give the values adopted by the several authorities for wrought-iron plates. For the sake of comparison, all the curves are constructed so as to show the working load for different values of the ratio $\frac{\text{Min. } S}{\text{Max. } S}$, this ratio having been hitherto adopted as the basis of the German methods; but according to the dynamic method, the question is really governed by the difference $\text{Max. } S - \text{Min. } S$, rather than by the above ratio, and is more simply defined without the aid of any diagram.

The heights (from datum line) to T_1 , T_5 , &c., at the left end of the figure, indicate the working-stress for a steady unchanging load, *i.e.*, for the case when $\text{Min. } S = \text{Max. } S$. The central ordinates at U_1 , U_5 , &c., denote the working-stress for a load varying between zero and a certain positive quantity, or for the case when $\text{Min. } S = 0$. The ordinates V_1 , V_5 , &c., at the other end of the diagram, represent the working-stress for a member subject to alternate tension and compression $+v$ and $-v$, or for the case when $\text{Min. } S = -\text{Max. } S$.

The first method, or old rule, is represented by the straight horizontal line $T_1U_1V_1$, drawn at 5 tons per square inch. The nominal factor of safety is 4; but this method implies that there is no such thing as fatigue, *and* no such thing as dynamic action of the rolling load. This assumption *must* be incorrect; and therefore it would be a great mistake to suppose that a bridge, designed throughout upon this rule, would be anything like strong enough to carry a load equal to four times its actual load.

The opposite view of the case is taken by the German school represented by Seefehluer, whose formula is expressed by the curve $T_5U_5V_5$. Here the factor of safety is reduced to about 2; but this method implies that fatigue is a real phenomenon, and that dynamic action is another and independent phenomenon.

Between these extremes an intermediate position is occupied by the lines $T_4U_4V_4$, and $T_6U_6V_6$. The straight line T_4V_4 expresses Weyrauch's formula. The factor of safety is 3; and the implied view is that fatigue is a real phenomenon, while dynamic action is ignored. But if the Launhardt formula is applied with the value $\nu = \frac{t}{2}$ (in closer accordance with Wöhler), the straight line T_4V_4 becomes depressed in the middle to U_6 , and is nearly expressed by the curve $T_6U_6V_6$.

The curve $T_6U_6V_6$ represents the alternative or dynamic theory. Here again the factor of safety is 3, and the results do not differ widely from the Launhardt-Weyrauch curve; but the method is based on the opposite view, namely, that there is no such thing as "fatigue," and that the apparent fatigue is really due to the dynamic action of the rolling load. Accordingly the curve can only be taken to represent the working-load in cases of instantaneous loading or instantaneous variations of load; and must be modified in cases where the changes of load are more gradually effected.

Adopting for these modifications the provisional estimate already mentioned for the different members of a girder whose span is more than 100 feet, the working load will be given by the several curves in Fig. 192a; and the values given in this diagram will be again referred to in dealing with the several classes of bridge-construction.¹

¹ It may be remarked that this diagram differs but little from that which has recently been adopted by the engineer of the Pennsylvania Railway Company for all wrought-iron bridges on that line of railway, except that in the latter case the diagram

In the present state of opinion it is impossible to say what rule may hereafter be adopted by engineers for the working load in bridge work ; but in order to meet all possible views we shall arrange the calculations in such a form that either rule may be employed without difficulty.

For the same reason it will perhaps be better to avoid any dogmatic expression of opinion upon the general question, leaving the reader to form his own conclusions ; but so far as can be gathered from the experimental data that are at present available, the author has no hesitation in expressing his own opinion that the existence of "fatigue" as an actual reduction of tensile strength, and as a phenomenon distinct from the known effects of dynamic action *is not proved* ; and that in all probability the two things are one and the same.

At all events it is very important to avoid the mistake of seeing double on this question ; and we have discussed it at considerable length because it involves issues of greater magnitude than almost any other disputable question of bridge theory.

consists of a pair of broken straight lines instead of the continuous curves shown in Fig. 192a. It will of course be understood that in this diagram the ordinates represent the working stress which is to be adopted when the maximum stress Max. S is calculated *in the usual way*, and upon the principles of static equilibrium. When the internal dynamic stress is calculated, the proper working stress is a constant quantity.

Fig: 192.

WORKING-LOAD FOR WROUGHT IRON.

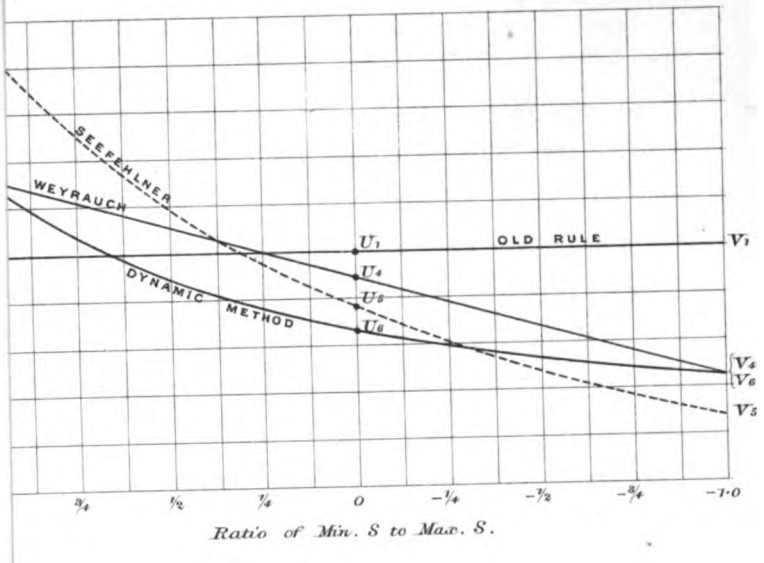
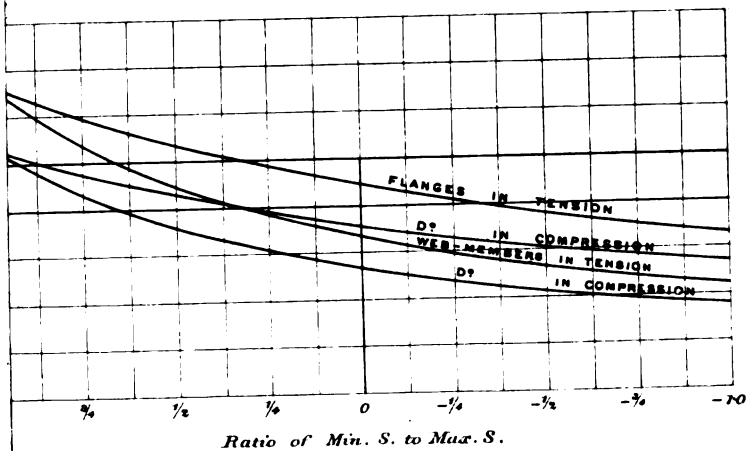

Fig: 192^a

WORKING-LOAD FOR WROUGHT IRON IN TENSION AND IN COMPRESSION.





PART IV.

THE DESIGN OF BRIDGES IN DETAIL.

CHAPTER XIV.

THE LOAD ON BRIDGES.

182. Composition of the Load.—The total load that the bridge has to carry will in all cases be made up of two portions, which must be separately dealt with, viz.—1st, The “dead load,” or the weight of the structure itself, producing in each member a stress which is at all times constant; and 2d, the “live load,” or the weight of the passing traffic, producing stresses which are subject to important variations arising from several causes. In the present chapter we shall only consider the *weights* that have generally to be dealt with.

183. The Dead Load.—It will be convenient to estimate the weight of the entire structure under two or three separate heads. 1st, The bridge platform, which will generally be a uniformly distributed load, and will include the cross girders, the flooring (whether of buckled floor-plates, planking, or what not), and the roadway covering of public bridges or the permanent way of railway bridges; 2d, the weight of the wind-bracing; and 3d, the weight of the main girders or main structure of the bridge. In bridges of moderate span, the last two items, like the first, are commonly assumed to form a load of uniform intensity per foot lineal; but in very large bridges this assumption would often be very far from the truth, especially in the case of cantilever bridges, and in all such cases the weight of each panel in the main structure must be separately computed.

The first and second items of the dead load, together with the whole of the live load, are of course supported by the main structure as an extraneous load separate from its own weight, and are sometimes called the “*useful*” load. The term does not really mean that this load is particularly useful, but it serves to convey the idea intended, viz., that the *duty of supporting* this load constitutes the *useful function of the bridge*.

For parallel girders, bowstrings, arches and suspension bridges, the weight of the main structure may be provisionally calculated from that of the "useful" load, on the principle already described in Chapter VII. ; but in the end it will generally be necessary to make a detailed calculation of the entire weight of the structure, and for such purposes the following data will be useful.

184. Weight of Materials.—In computing the weight of ironwork, it will be sufficiently accurate to assume that a bar of wrought iron having 1 square inch of sectional area will weigh 10 lbs. per yard lineal, or $3\frac{1}{3}$ lbs. per foot lineal; and that a plate 1 inch in thickness will weigh 40 lbs. per square foot; adding in the case of plate-built members 4 per cent. for the weight of the rivet heads. The weight of cast iron is about 7 per cent. less than this, and the weight of steel about 2 per cent. greater.

The following table gives the weight per cubic foot of most of the materials used in the construction of bridge flooring or in the covering of public roadways.

TABLE 1.—*Weight of Materials.*

	Lbs. per cubic foot.
Asphalte	140
Macadam, compressed	120
Granite, in kerbs or pitching	160 to 170
York landings	143
Limestone	150 to 170
Concrete	115 to 130
Brickwork	96 to 112
Creosoted pine timber	42 to 48
Pitch pine	48 to 56
English oak	60

The weight of the roadway and platform in a public road bridge will of course vary in each case according to the construction adopted, so that it would be useless to give any weights calculated from particular examples; but in the case of railway bridges the weight of the platform does not vary to so great an extent, and by way of example it may be mentioned that Mr. Baker estimates the weight of the flooring¹ and wind-bracing for a double line railway bridge carried upon two main girders at the following values:—

Span in Feet.	Dead Load per foot run exclusive of Main Girders.
10 to 100	14 cwt.
100 to 150	15 "
150 to 200	16 "
200 to 250	17 "
250 to 300	18 "

¹ *Vide Long Span Bridges.*

When the two lines of railway are supported upon three main girders, the above loads are to be reduced in each case by 2 cwts. per foot, and when upon four girders the weights are to be reduced by 4 cwts. per foot.

185. Live Load upon Public Road Bridges.—The heaviest *distributed* load upon a public road bridge will generally take place when the whole surface, of carriage-way and foot-ways, is covered with a crowd of people on foot. The weight of a crowd, when packed as closely as possible, is given by Mr. Stoney at 147 lbs. per square foot of floor. A crowd so dense as this, however, will rarely extend over the whole surface of a large bridge, and other authorities have taken a load of 100 to 120 lbs. per square foot as representing the weight of a close crowd; while many public bridges have been designed for a load of 80 lbs. only, and in some cases 40 lbs. per square foot has been assumed as the limiting load to be provided for. These lower values would probably be quite sufficient on all ordinary occasions for country bridges, or in cases where the traffic can be regulated by means of toll-gates or barriers; but for bridges that are open to the public in busy cities or main thoroughfares, it will hardly be prudent to reckon for less than a maximum distributed load of 1 cwt. per square foot, taking the combined area of carriage-way and foot-ways.

The weight of snow is not generally taken into account in connection with bridges in this country, but if it is to be allowed for, it should be considered as a rolling or rather as a movable load. Morin states that a drift of snow 20 inches in depth will weigh 10 lbs. per square foot; while Mr. Zerah Colburn estimates that the weight of saturated snow on American bridges is sometimes equivalent to 6 inches of water, or 30 lbs. per square foot.

In addition to the movable distributed load, it is also necessary to consider the stresses that may be produced in some parts of the bridge, and especially in the cross-girders, by the concentrated weight of a heavily loaded vehicle, such as a traction-engine, or a trolley carrying heavy machinery. In this respect the requirements will vary with the situation of the bridge, and the load on the heaviest pair of wheels may accordingly be taken as varying in ordinary cases from 7 to 15 tons; but in some bridges a load of 10 tons on four wheels, or 5 tons per axle, would be sufficient; while in other cases a load of 48 tons, or 24 tons per axle, would not be in excess of occasional (though very exceptional) requirements.

186. Live Load on Railway Bridges.—For English railways on the 4 ft. 8½ in. gauge, it has been a common practice to estimate the rolling load at 1 ton per foot lineal for each track; and with the engines that were most commonly in use a few years ago this estimate was near enough to the truth for bridges of 100 to 200 feet span. Such an engine and tender would weigh perhaps from 38 to 48 tons, while the length from buffer to buffer would be from 42 to 48 feet. Two such engines, covering

nearly 100 feet, would be the greatest number ever coupled together; while the following train of goods-trucks or carriages would not weigh more than $\frac{3}{4}$ ton per foot lineal on railways of the ordinary gauge, and still less in the case of the narrow-gauge railways which have been so extensively constructed of late years.

Referring, however, to lines of the standard gauge, it is evident that the engines above mentioned would impose a greater load than 1 ton per foot upon bridges of small span; for the engine (apart from the tender) would weigh from 24 to 30 tons, and this load would be carried upon a wheel-base not more than 13 to 16 feet in length, so that the load actually carried upon a small bridge would amount to nearly 2 tons per foot of span.

But the locomotives above referred to would now be considered as very light engines for the ordinary traffic of main lines; and the weights have been continuously increasing with the growth of the public traffic. Taking the engine load (upon 100 feet lineal) as represented, for three different classes of locomotive, by a distributed weight of 1·00, 1·25, and 1·33 tons per foot, and adding behind the two coupled engines a train of cars weighing $\frac{3}{4}$ ton per foot, Mr. Stoney¹ calculates the live load per foot of single line as follows:—

TABLE 2.—*Live Load for Each Track of Railway in Tons per Foot Lineal.*

Length of Span in Feet.	Engine Load in Tons per Foot.		
	Class 1. 1·0 Ton per Foot.	Class 2. 1·25 Ton per Foot.	Class 3. 1·33 Ton per Foot.
40	1·05	1·35	1·45
60	1·03	1·32	1·41
80	1·02	1·28	1·37
100	1·00	1·25	1·33
120	·98	1·22	1·30
140	·97	1·18	1·26
160	·95	1·15	1·22
180	·93	1·12	1·18
200	·92	1·08	1·14
250	·88	1·00	1·04
300	·83	·92	·94
350	·79	·83	·85
400	·75	·75	·75

But in the case of small bridges it is necessary to consider not only the greatest weight that can stand upon the bridge, but also the load upon each axle of the engine, and the greatest bending moment that can be produced by any variable position of the most heavily loaded wheels. The distributed load which would be equivalent to the most unfavourable

¹ *Vide* Theory of Strains.

position of the actual wheel loads in each class of engine, is given by Mr. Stoney as follows:—

TABLE 3.—*Effective Live Load for Railway Bridges under 40 feet in Length.*

Span.	Engine Load in Tons per Foot.		
	Class 1. 1·0 Ton per Foot.	Class 2. 1·25 Ton per Foot.	Class 3. 1·33 Ton per Foot.
12	2·00	2·50	2·67
16	1·88	2·34	2·50
20	1·68	2·10	2·24
24	1·50	1·87	2·00
28	1·35	1·68	1·79
32	1·22	1·53	1·62
36	1·11	1·39	1·48

It must be remarked, however, that for English lines the weights given in the first columns of these tables will seldom be sufficient; and that the live load is not usually taken at anything *less* than 1 ton per foot; although in the case of narrow gauge railways there is no reason why the bridges should not be proportioned to the lighter train loads that they have to carry; and for such lines the weights given in the first column will often suffice.

On the other hand, the heaviest engines contemplated in the above tables, are still too light to represent the extreme requirements of modern practice; and taking the several examples of heavy English engines quoted by Mr. Baker, it appears that we must reckon for tender-engines having a weight of 1·375 tons per foot of total length, and for some tank engines weighing as much as $1\frac{1}{2}$ tons per foot upon a total length of 30 feet; while the weight per foot of wheel-base may range from $2\frac{1}{4}$ to $3\frac{1}{4}$ tons, the greatest load on the driving-wheels being generally about 15 tons.

With these data Mr. Baker¹ estimates that the static distributed load which would be equivalent to the worst position of the wheel-loads on bridges of different spans would be as follows:—

TABLE 4.—*Live Load in Tons per Foot for Heavily Engined Lines of Railway.*

For 10 feet spans, rolling load $q=3\cdot00$ tons per foot.

20	"	"	2·40	"
30	"	"	2·10	"
60	"	"	1·50	"
100	"	"	1·375	"
150	"	"	1·25	"
200	"	"	1·125	"
300	"	"	1·00	"

¹ *Vide* Short Span Railway Bridges.

It is unnecessary here to go into any further estimate of this quantity; and whatever may be the heaviest class of engine which the bridges on any line of railway may be intended to carry, there will be no difficulty in calculating the weight per foot lineal (q) of a uniform load whose greatest bending moment would be equivalent to that produced by the actual wheel loads of the engine, assuming of course that the arrangement of wheel-base and the weight on each axle are known. But in making use of this quantity, or supposed uniform intensity of train load, it will be necessary to have regard to the points mentioned in the following Articles.

187. Distribution and Incidence of the Train Load.—So far as the flanges of the main girder are concerned, the uniform rolling load q , determined for each width of span as above described, will of course give the same maximum stress as that produced by the actual wheel loads; but it would not be correct to use the same quantity q for determining the stresses in *all* the members of any given bridge. This value will not apply at all to the cross-girders and intermediate bearers, nor to the vertical suspenders which may support the roadway; and with strictness it cannot be applied to the members of the web-bracing, so that it is really not quite accurate for anything except the main girder flanges. Thus for a bridge of 300 feet span we may perhaps take $q = 1$ ton per foot; but if the cross-girders of such a bridge were laid at intervals of 4 or 5 feet apart, it is obvious that a load of 4 or 5 tons per cross-girder would not represent anything like the weight that each cross-girder would have to carry; for however closely they may be spaced, each one of them in turn will have to support the weight of the most heavily loaded axle of the engine.

This shows, by the way, that a close spacing of the cross-girders will often amount to a downright waste of material. In some early bridges the space between the cross-girders (b) was not wider than $2\frac{1}{2}$ to 3 feet from centre to centre; and for the purpose of carrying a locomotive such a floor would be nearly as strong if every alternate cross-girder were taken out of it. Generally speaking there will be no object to be gained by placing the cross-girders at intervals shorter than about $b = \frac{Q}{q_w}$, in

which Q is the weight on the driving axle, and q_w the greatest intensity of engine load per foot of wheel-base. Thus if the engine wheels were spaced at uniform distances of 6 feet with a load of 15 tons on each axle, the cross-girders might be spaced at 6 feet centres, and their maximum load would then be 15 tons, an amount which evidently could not be reduced by any closer spacing, and would be only slightly increased if a wider spacing were adopted. For constructive reasons a wider spacing would generally be still more economical, and in modern bridges the spacing b is often increased to 10 feet and upwards, the cross-girders being united by intermediate longitudinal bearers carrying the floor and permanent way. In American bridges the spacing of the cross-girders is generally determined by the panel width of the web-bracing in the main girders, and frequently reaches 25 or even 30 feet.

Cross-Girders.—As a general rule for the load on cross-girders, we may say that when they are spaced at intervals shorter than about 5 feet, the load will consist of the heaviest weight on any axle of the engine. For intervals of 5 feet or upwards, it will be necessary to consider the several positions that may be occupied by the wheels in the heaviest part of the engine wheel-base. When the cross-girders are spaced at wide intervals, and these intervals are considered as detached spans, it would be sufficiently correct to take the load as equal to bq_w , in which b is the distance between cross-girders and q_w the greatest load per foot of wheel-base ; but if the intermediate bearers act as continuous girders, we have seen that such a girder of two equal spans would transfer five-eighths of the total load to the central support, and although this may be modified by the continuity over adjacent spans, we should do well to take at least $1.125 bq_w$ as the load on each cross-girder.

Intermediate Bearers.—Although the intermediate bearers or “stringers” may act as continuous girders so far as the dead load is concerned, yet for the live load the continuity will help them very little, and may be interfered with by the deflection of the cross-girders ; so that these bearers must in practice be considered as detached spans subject to the concentrated load or loads imposed by one or two or more axles of the engine as the case may be.

Web-Bracing of Main Girders.—In English practice it is usual to calculate the stresses in all the members of the main structure on the assumption that the rolling load consists practically of a train of uniform density advancing gradually until it covers the whole length of the bridge, the weight of the train per foot lineal being the quantity q above discussed.

But when a train, headed by a heavy engine, has advanced to any given position as sketched in Fig. 193, the shearing stress at the head of the train, or the stress in the lattice bars, is not the same as if the train were of uniform density, and accordingly it is the practice of American engineers to calculate these stresses with reference to the unequal distribution of the train-load.

Sometimes this is done by assuming a certain weight of engine per foot lineal, while in other cases the stresses are computed for the actual concentrated wheel loads which occur in a given type of engine.

The last-named method seems to aim at a degree of accuracy which is really unattainable, and in any case would be of little practical benefit. If the assumption of a uniform rolling load is not considered to be sufficiently accurate for the stresses in the lattice-bars, it will generally be sufficient to treat the train as made up of two portions ; each portion having a uniform weight per foot lineal. In this case it will be most

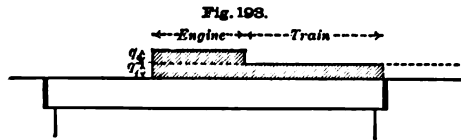

convenient to take the weight q_1 of the carrying stock as extending throughout and supplemented by an additional or excess-weight q_2 extending over the length of the engine or engines as shown in Fig. 193 ; and in ordinary English practice the actual value of these loads will not generally be greater than $q_1 = 0.80$, and $q_2 = 0.60$ ton per foot ; the engine load being then $q_1 + q_2 = 1.40$ tons per foot ; but in practice it will be safer to take q_1 at not less than 1 ton per foot ; which is the more usual practice in England.

The train will in practice be headed by not more than two engines coupled together, and if the extra weight of 0.4 ton per foot is taken as extending over a length of 100 feet, the above calculation will generally suffice for bridges of more than 100 feet span ; but in smaller bridges it will of course be necessary to take the higher loads given in Table 4 ; and in some exceptional cases it may be advisable to consider the actual load on each axle of the engine.

This estimate, however, is largely exceeded by the engineer of the Pennsylvania Railway, who provides for the unknown future requirements of the steadily-increasing traffic, by proportioning the bridges to carry a rolling load consisting of a train of cars weighing 3000 lbs. per foot, and headed by two tender-engines each weighing 88 American tons.

In taking out the stresses due to the rolling load, we shall first proceed upon the assumption of a train of unit intensity ; i.e., a train weighing 1 ton per foot lineal throughout ; and the stresses thus found will coincide with the earlier English practice. If we wish to provide for a heavier or a lighter train of uniform density, we have only to multiply these stresses by the actual weight q per foot lineal. For bridges of less than 300 feet span, on English railways, we shall take the values of q given in Table 4 ; and the calculation thus made will generally be sufficient for all members of the main girders. But as regards the lattice bars, if it is desired to go to a greater refinement, and to ascertain the effect of the unequal distribution of the train load (as shown in Fig. 193), this may be done by first finding the stresses due to the uniform rolling load q_1 in the manner above described, and then adding the stresses due to the excess load q_2 , which must be separately calculated.

188. Fluctuations in the Intensity of the Rolling Load.—If the last-named calculation were made by the more troublesome process of taking out the separate stresses due to the load on each axle in any given type of engine, the result might perhaps be regarded as possessing a claim to greater accuracy ; but the claim would be an entirely delusive one, because the particular distribution of weights aimed at in the construction of the engine, is not maintained for two minutes together when the engine is running at high speed. The observed oscillations, or relative deflections of the bearing-springs, show at once that the actual distribution of the load between the leading, driving, and trailing axles, varies from moment to moment, and varies sometimes between very wide limits. The greatest variation is commonly found to take place at the leading wheels, whose

normal load is sometimes doubled and sometimes reduced to almost nothing under the galloping or plunging of the engine.

These variations may be produced not only by irregularities in the permanent way, but also by the action of the mechanism. Thus the inclined thrust or inclined pull of the connecting-rod will make itself felt at every stroke, by transferring a certain weight from leading axle to driving axle, or *vice versa*, according as the engine is running in backward or forward gear; and in addition to the variations indicated by the bearing springs, there may be others due to the vertical acceleration of revolving or reciprocating masses, unless those masses are perfectly balanced.

But if we disregard the changes of momentum in the comparatively light masses of the motive gear, we may perhaps consider that the galloping of the engine will generally add to the load on one axle only as much as it takes from the remaining axles; for unless the entire mass of the engine is undergoing some vertical acceleration, its total pressure upon the rails must be simply equal to its weight.

The same compensating effect must evidently take place still more completely in regard to the total weight upon all the axles of the train, although every axle may show, by the continual oscillation of the bearing springs, that its individual load is subject to incessant fluctuations from moment to moment. There is therefore no conclusive evidence that these fluctuations will sensibly affect the load on the whole bridge, except in the case of very short spans; but the normal load on any one axle may be considerably increased by these fluctuations, and this increase must be reckoned for in the case of all cross-girders and intermediate bearers. These members will of course be proportioned in any case to the load under the most heavily weighted axle of the engine, and as this axle is generally situated near the centre of the engine length, the fluctuation will be less than at the leading or trailing axle; so that it will probably be sufficient to add 25 per cent. to the normal load.

For the reasons above stated we are unable to use the bearing springs as dynamometers indicating at any given moment the *total* pressure between the train and the bridge; and still less do they give us any indication as to the dynamic effect of the rolling load upon the elastic structure of the bridge. What we want for this purpose is to treat the *bridge itself* as a dynamometer, and thus to measure the momentary stress either by the momentary deflection of the whole bridge, or still better by a micrometric measurement of the direct strain in each of the individual members.

188A.—Since this work has been in the press, a paper has been published by the American Society of Engineers giving the results of a number of experiments upon the momentary deflection of bridges under the passage of the train.¹ The bridges tested were deep and stiff trusses

¹ The experiments were made by Mr. A. S. Robinson, and were reported by him to the Railway Commissioners of Ohio. Vide *Proceedings of the Institution of Civil Engineers*, vol. xc,

or girders varying from 128 to 150 feet in span, and their central deflection was recorded continuously by an instrument called a bridge-indicator.

Unfortunately, these deflections could not be compared with the deflection which is caused by the same load at rest; but the author assumes that the latter quantity may be obtained by striking a *mean* between the two extremes of the rapid secondary vibrations which the girder generally exhibited.

The "static deflection" being obtained in this way, it was found that during the passage of the engine the elastic vibrations had an extreme amplitude varying from .28 to .57 of the "static deflection;" so that the normal deflection was increased by a fraction varying from .14 to .285.

Such experiments, however, are hardly sufficient in themselves to determine the coefficient η for dynamic effect, whose value was considered in Art. 179. For the deflection of the girder gives no indication of the stress in the lattice bars; and as regards the flanges, the deflection can only be accepted as indicating the *average* intensity of stress, and not as showing the *greatest* intensity at any point in the flange. Thus the dynamic increment ω cannot be less, but it may be at some point considerably greater than that shown by the above figures.

When the bridge was being traversed by a long train of goods waggons, the elastic vibrations sometimes had an amplitude equal to the whole "static deflection," so that the normal deflection was increased by 50 per cent.; and notwithstanding the comparative lightness of the load per foot, the extreme deflection (including vibration) was sometimes as great as the highest value observed during the passage of the heavy engine.

This seems to show that the value which we have taken for the dynamic increment in the flanges, viz., $\omega = 0.50$ (Max. S - Min. S), would hardly be sufficient if we reckoned the train load at its actual weight; but as we have decided to estimate this portion of the train at nothing less than 1 ton per foot, we have a margin which will probably be sufficient to cover it.

The great vibrations which were observed during the passage of the goods waggons is attributed to the coincidence between the spacing of the wheels and the spacing of the cross girders; and to the fact that with a certain speed of train, the reiterated incidence of the wheels upon the cross-girders has a time-period coinciding with the natural period of vibration of the elastic bridge—so that the effect set up is comparable to the effect of the measured march of infantry, the impulses being due to the elastic spring of the intermediate stringers and perhaps also of the cross-girders.

CHAPTER XV.

CALCULATION OF STRESSES DUE TO THE MOVABLE LOAD.

189. General Method of Treatment.—The stresses produced by a dead load of uniform intensity have already been briefly examined ; but we have now to consider the bridge as a structure designed to carry a rolling load, or a load whose intensity in different parts of the span is subject to certain variations. We must therefore proceed to consider, in the first place, the statical effect of a load which assumes successively a number of different positions upon the bridge ; and having found the stresses to which the structure is liable under these conditions, we can then apply to each class of design those experimental or theoretical data in regard to the working strength of materials which have been examined in the preceding chapters.

It is already evident that the construction of bridges can hardly be conducted upon exact scientific principles, except by making a very large allowance for the imperfect state of our knowledge ; and therefore there is not much to be gained by any inordinate refinement in the remaining calculations. The stresses produced in some members of the bridge by the rolling load, attain their maximum value when that load covers only a certain portion of the span ; and if we assume a train of uniform weight per foot lineal, it is not very difficult to find the exact position of the train which causes the greatest stress in any given member ; and to determine the value of that stress. But we may arrive at the same results, within a small fraction, by other and simpler methods, which will be attended with far less error than many of the assumptions that are unavoidably made in bridge calculations at almost every step. Therefore as we should aim at a practical rather than a theoretical accuracy, we shall certainly prefer to adopt the method which will best help us to correct the more serious errors ; and to this end we must arrange our calculations so as to provide, where necessary, for the following varying conditions :—

1st. We have a dead load whose weight is not accurately known beforehand ; but it will certainly vary in bridges of different spans, and in some cases will vary greatly in different parts of the same span, and this unknown weight will have to be determined as a part of the calculation.

2d. We have a rolling load whose intensity varies in railway bridges of different spans, and in some cases it may be necessary to distinguish between the engine load and the train load.

3d. As regards the design, it will be convenient if we can apply the same calculations to different types of bridge, as far as that may be possible, and also to different modifications of detail or of outline, so as to ascertain readily the effect of any such modification without beginning again *de novo*.

4th. When we have found the maximum stress and the minimum stress, we have to determine the sectional area by adopting one or another of the known rules for fixing the working-stress in each member, and the calculation must be effected in such form that either rule can be easily applied.

With these objects in view, the best way will be to commence with those conditions which are known, and to eliminate one by one the conditions which vary in different cases. By this means we shall avoid having to go through the same process again and again, as we should have to do if we commenced by assuming beforehand some condition which might afterwards be found to be incorrect.

The first step will be to examine the bending moments produced by a concentrated load of unit-weight placed upon any joint, or produced by the same unit weight when spread over any one of the panels.

190. Tabulated Analysis of the Bending Moments.—To illustrate the most convenient method of tabulating the elements of the bending moments, suppose the girder to be divided into 10 equal panels as shown in Fig. 194.

Suppose in the first place that a load $Q_0 = 1$ ton is imposed successively on each one of the panel points 1 to 9; and for each position of the unit load, calculate the bending moment at every panel point. Let X denote the distance of the loaded panel-point from the left abutment A . Then the vertical reaction of the right abutment C will be an upward force

$V_{10} = Q_0 \frac{X}{L}$; while the upward force impressed upon the girder at A will

be $V_0 = Q_0 \frac{L-X}{L}$. Therefore taking Q_0 as unity, we may easily write

the decimal values of V_0 and V_{10} for each position of the unit load, as in the first and last columns of Table 1. Then if we take the panel length b as a unit of length, we can proceed with equal facility to write in the bending moments produced at each section by these external forces; for beginning at the right extremity C , we have only to write in the successive multiples of V_{10} , progressing in arithmetical order towards the left until we come to the loaded panel point, where the moment is of course $M_b = Q_0 \frac{X(L-X)}{L}$; and beginning again at the left extremity we

can in like manner write in the successive multiples of V_0 , progressing in arithmetical order towards the right until we come again to the loaded

panel point, where of course we shall arrive at the same value of the bending moment as that already found.

Thus, for example, we will take the second line in the table, which represents the moments due to the unit load Q_0 placed upon the panel point 2. Here the vertical reactions will evidently be $V_{10}=0.2$ and $V_0=0.8$; while the diagram of moments will be the triangle Ad_2C in Fig. 195. Then commencing with the force V_{10} at the right extremity, the moments of this force at the successive sections 9, 8, 7, &c., will be successively δV_{10} , $2\delta V_{10}$, $3\delta V_{10}$, &c.; and may be expressed in units of Q_0b by the decimals 0.2, 0.4, 0.6, &c., which may be written in by simply adding 0.2 at each section until we come to the loaded panel point 2, where the moment is 1.6 Q_0b . Again commencing at A with the force $V_0=0.8$, the moments at 1 and 2 are found, by successive addition, to be 0.8 and 1.6 respectively.

The remaining lines of the table are constructed in the same simple fashion, and each line gives, in units of Q_0b , the moments due to the unit

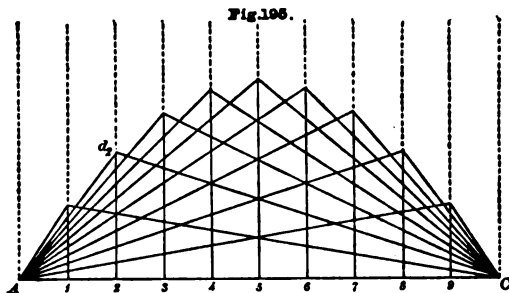
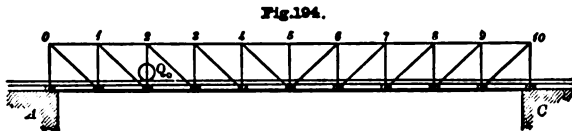

load Q_0 placed successively at each of the panel points; while the same moments are again graphically represented by the several triangles in Fig. 195.

Finally, adding up the figures in each column we have the total bending moment at each panel point due to the entire load, and expressed in the same units.

Each *line* of the table gives the moments produced at different sections by the load placed in one position, while each *column* of the table gives the moments produced at one section by the load placed in different positions; and it will be observed that the columns are an exact reproduction of the lines—thus the figures in column 2 are the same as in line 2, and so on.

TABLE 1.—Analysis of Bending Moments, in a Girder of Ten Panels, due to Unit Load on each Panel Point.

Load placed on point numbered.	V_0	Bending Moment at Sections numbered									V_{10}
		1	2	3	4	5	6	7	8	9	
1	0.9	0.9	0.8	0.7	0.6	0.5	0.4	0.3	0.2	0.1	0.1
2	0.8	0.8	1.6	1.4	1.2	1.0	0.8	0.6	0.4	0.2	0.2
3	0.7	0.7	1.4	2.1	1.8	1.5	1.2	0.9	0.6	0.3	0.3
4	0.6	0.6	1.2	1.8	2.4	2.0	1.6	1.2	0.8	0.4	0.4
5	0.5	0.5	1.0	1.5	2.0	2.5	2.0	1.5	1.0	0.5	0.5
6	0.4	0.4	0.8	1.2	1.6	2.0	2.4	1.8	1.2	0.6	0.6
7	0.3	0.3	0.6	0.9	1.2	1.5	1.8	2.1	1.4	0.7	0.7
8	0.2	0.2	0.4	0.6	0.8	1.0	1.2	1.4	1.6	0.8	0.8
9	0.1	0.1	0.2	0.3	0.4	0.5	0.6	0.7	0.8	0.9	0.9
		4.5	8.0	10.5	12.0	12.5	12.0	10.5	8.0	4.5	

This table enables us to deal with any concentrated weight or weights; but it is obvious that the given moments will not correspond exactly with those produced by a rolling load of uniform intensity, unless in the case when it covers the whole bridge.

Let the weight of the rolling load in tons per foot lineal be denoted by q , and let b represent the width of each panel in feet. Then the panel load will be $Q = qb$; and when the entire span is covered by the load, the weight on each panel point will be $Q_0 = qb$; but if the head of the train has only reached some intermediate panel point, the weight on that panel point will be only $\frac{Q}{2}$.

To follow the effects that are produced as the train progresses across the bridge, it will perhaps be sufficient to suppose that each panel in succession is covered by the train; and the bending moments due to each separate panel load may then be tabulated very readily by simple addition of the figures given in Table 1.

Thus when the train covers the panel 1-2, as represented in Fig. 196, with the distributed weight $Q = qb$, we shall have one-half of that load or $\frac{Q}{2}$ imposed upon each of the panel points 1 and 2. Therefore, referring to Table 1 for the moments due to a unit load placed at those points, we have the bending moment at section 1 equal to $\frac{0.9 + 0.8}{2} = 0.85 Qb$.

In this manner Table 1A is easily constructed, and represents the bending moments due to a unit load spread over each panel. The first line of figures gives the moments due to the panel load 0-1, and the moments are equal to one-half of those in the first line in Table 1. The second line gives the moments due to the panel load 1-2, and the values are

equal to the mean between those of line 1 and line 2 in the previous table.

In the same way the moments due to any unit panel load, contained between the n th and $(n + 1)$ th section, are found by taking the mean between the figures in Table 1, which give the moments due to a unit load upon the n th and $(n + 1)$ th panel points.

Fig. 196

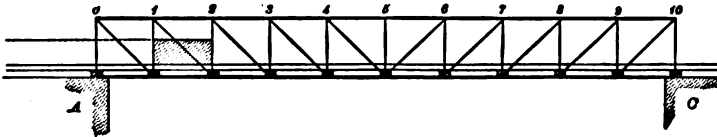

TABLE 1A.—Analysis of Bending Moments, in a Girder of Ten Panels, due to Unit Load spread over each Panel.

No. of Loaded Panel.	Bending Moment at Sections Numbered.										
	0	1	2	3	4	5	6	7	8	9	10
0-1	0	0.45	0.40	0.35	0.30	0.25	0.20	0.15	0.10	0.05	0
1-2	0	0.85	1.20	1.05	0.90	0.75	0.60	0.45	0.30	0.15	0
2-3	0	0.75	1.50	1.75	1.50	1.25	1.00	0.75	0.50	0.25	0
3-4	0	0.65	1.30	1.95	2.10	1.75	1.40	1.05	0.70	0.35	0
4-5	0	0.55	1.10	1.65	2.20	2.25	1.80	1.35	0.90	0.45	0
5-6	0	0.45	0.90	1.35	1.80	2.25	2.20	1.65	1.10	0.55	0
6-7	0	0.35	0.70	1.05	1.40	1.75	2.10	1.95	1.30	0.65	0
7-8	0	0.25	0.50	0.75	1.00	1.25	1.50	1.75	1.50	0.75	0
8-9	0	0.15	0.30	0.45	0.60	0.75	0.90	1.05	1.20	0.85	0
9-10	0	0.05	0.10	0.15	0.20	0.25	0.30	0.35	0.40	0.45	0
	0	4.50	8.00	10.50	12.00	12.50	12.00	10.50	8.00	4.50	0

The total moments due to the entire load are of course the same in both tables; and these totals will apply to the dead load when the girder is of uniform weight throughout. But in some cases the weight of the girder per foot lineal is much greater in some panels than in others, and for these cases we may use Table 1A to find the stresses in the various members due to the dead load; for if the actual gross weight of any particular panel is denoted by $P = pb$, we have only to multiply the corresponding line of figures in Table 1A by the quantity Pb in order to find all the moments due to that portion of the dead load.

As regards the rolling load, whose uniform intensity is denoted by q , it will be seen that every portion of it adds something to the bending moment at each section; and therefore at each section the greatest bending moment and the greatest flange stress take place when the bridge is loaded from end to end. Accordingly, when dealing with the flange stress, we have only to multiply the totals, at foot of either table,

by the quantity $Qb = qb^2$, in order to find the maximum bending moment at any section.

This is not the case, however, in regard to the stresses in the diagonal bracing, which may be sometimes positive and sometimes negative ; but the Min. S and the Max. S will be easily found by means of the analysis contained in the one or the other of these tables, as hereafter shown.

We have already remarked that the moments of the vertical forces here considered are quite independent of the form of the bridge ; and if the bridge consists of a girder of any shape or dimensions, supported at each end, the forces here considered are the only forces acting in the principal plane of the structure ; so that the table will apply to all independent girders, no matter what may be their outline or dimensions.

It only remains to observe that the example given in Table 1 refers to a bridge divided into 10 equal panels. The construction of a similar table, for the case of a bridge divided into any other number of equal or unequal panels, is such a simple matter that it is quite unnecessary to give any further examples ; and we may proceed, in the following chapters, to apply these tables for the determination of the stresses in different types of bridge-construction.

CHAPTER XVI.

PARALLEL GIRDERS.

191. Different Types of Parallel Girders.—In the present chapter we shall assume that the bridge is supported at each end of the span, and that the girders are of uniform depth with straight horizontal flanges. Such girders may be constructed in a variety of forms, as illustrated in Plate F at the end of this chapter; and according to the arrangement of the web they may be distinguished as plate girders, Warren girders, lattice girders, Linville trusses, and so forth; but to a great extent they may all be treated on the same basis.

In the first instance, however, we shall assume that the web consists of some form of single triangulation, composed of bars which are alternately inclined in opposite directions, as in the Warren girder; or composed of vertical posts and inclined ties; or inclined struts and vertical ties. When these cases have been dealt with, the other combinations will follow easily.

192. Horizontal Stress at each Joint of the Flanges.—The flange stress in any parallel girder with a single system of bracing is easily to be found from the bending moments as tabulated in the manner described in the last chapter. The greatest bending moment produced at any given section by the live load, occurs when the bridge is fully loaded, and we have therefore only to deal with the totals at foot of Table 1, which give the moments expressed in units of Qb ; and dividing these moments by the depth d of the girder, we obtain the flange stress $\pm H$ at each joint, the upper flange being in compression and the lower flange in tension. Therefore if we take d as unity, the figures given in Table 1 will represent the flange stress; and in any parallel girder with single bracing, the horizontal thrust H_1, H_2 &c., at any *joint* of the upper flange, will have the values given by the same figures in Table 2, the tabular number being multiplied by $Q \frac{b}{d}$.

If the dead load is of uniform intensity p per foot lineal, we need only refer to the totals at foot of the table; and the maximum flange stress at any joint will be given by the tabular number multiplied by $(P + Q) \frac{b}{d}$.

The particular bar of the flange to which this stress will apply, depends upon the arrangement of the bracing.

193. Horizontal (Shearing) Stress in each Panel of the Web.—The compressive stress in the upper flange of the girder is not due to the pressure of any extraneous bodies acting at its opposite ends as in a column, but is due entirely to the action of the web, and therefore the stresses in the web may easily be deduced from those in the flanges.

Thus in the case of the girder shown in Fig. 197, the upper flange is not acted upon by any extraneous horizontal force at the end 0, and therefore the horizontal stress H_1 , which takes effect at the pin 1, must be

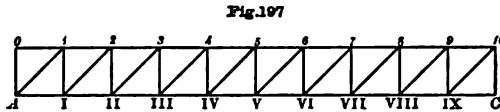

produced entirely by the thrust of the diagonal A-1; and consequently H_1 must be the horizontal component of the compressive stress in that diagonal.

At the same time it is evident that H_1 represents the flange stress in the bar 1-2; while the bar 0-1 is subject to no stress at all.

Again, at the pin 2, we have the horizontal stress H_2 , which may be less, but is generally greater than H_1 ; and the difference, or $H_2 - H_1$, must be equal to the horizontal component of the thrust in the diagonal 1-2.

In the same way the horizontal stress applied to the upper flange by each panel of the web is equal to the flange stress at the right joint minus the flange stress at the left joint, and can be found by simple subtraction.

TABLE 2.—*Horizontal Flange Stress in a Parallel Girder of Ten Equal Panels, produced by Unit Load on each Joint.*

Depth of girder $d=1$; Panel width $b=1$; Panel load $Q=1$.

Position of Load.	H_1	H_2	H_3	H_4	H_5	H_6	H_7	H_8	H_9
At No. 1	0·9	0·8	0·7	0·6	0·5	0·4	0·3	0·2	0·1
2	0·8	1·6	1·4	1·2	1·0	0·8	0·6	0·4	0·2
3	0·7	1·4	2·1	1·8	1·5	1·2	0·9	0·6	0·3
4	0·6	1·2	1·8	2·4	2·0	1·6	1·2	0·8	0·4
5	0·5	1·0	1·5	2·0	2·5	2·0	1·5	1·0	0·5
6	0·4	0·8	1·2	1·6	2·0	2·4	1·8	1·2	0·6
7	0·3	0·6	0·9	1·2	1·5	1·8	2·1	1·4	0·7
8	0·2	0·4	0·6	0·8	1·0	1·2	1·4	1·6	0·8
9	0·1	0·2	0·3	0·4	0·5	0·6	0·7	0·8	0·9
Total . .	4·5	8·0	10·5	12·0	12·5	12·0	10·5	8·0	4·5

TABLE 3. — *Horizontal Stress applied by each Panel of the Web in the same Girder.*

Position of Load.	Number of Panel.									
	0-1	1-2	2-3	3-4	4-5	5-6	6-7	7-8	8-9	9-10
At No. 1	0.9	-0.1	-0.1	-0.1	-0.1	-0.1	-0.1	-0.1	-0.1	-0.1
2	0.8	0.8	-0.2	-0.2	-0.2	-0.2	-0.2	-0.2	-0.2	-0.2
3	0.7	0.7	0.7	-0.3	-0.3	-0.3	-0.3	-0.3	-0.3	-0.3
4	0.6	0.6	0.6	0.6	-0.4	-0.4	-0.4	-0.4	-0.4	-0.4
5	0.5	0.5	0.5	0.5	0.5	-0.5	-0.5	-0.5	-0.5	-0.5
6	0.4	0.4	0.4	0.4	0.4	0.4	-0.6	-0.6	-0.6	-0.6
7	0.3	0.3	0.3	0.3	0.3	0.3	0.3	-0.7	-0.7	-0.7
8	0.2	0.2	0.2	0.2	0.2	0.2	0.2	0.2	-0.8	-0.8
9	0.1	0.1	0.1	0.1	0.1	0.1	0.1	0.1	0.1	-0.9
Positive total .	4.5	3.6	2.8	2.1	1.5	1.0	0.6	0.3	0.1	0.0
Negative total	-0.0	-0.1	-0.3	-0.6	-1.0	-1.5	-2.1	-2.8	-3.6	-4.5
Sum . . .	4.5	3.5	2.5	1.5	0.5	-0.5	-1.5	-2.5	-3.5	-4.5

To determine the stresses in the several panels of the web, we may use the bending moments as given in Table 1 ; and repeating the figures of that table we have the values of $H_1, H_2, H_3, \&c.$, in Table 2, as representing the flange stress at each joint in units of $Q \frac{b}{d}$. Then making the subtractions $H_2 - H_1, H_3 - H_2, \&c.$, we may tabulate, as in Table 3, the horizontal components of the stress in each panel of the web. Thus the first line in each table gives the horizontal stress, in flanges and web respectively, due to a unit load placed at joint No. 1. In the first panel of the web 0-1 the stress is a positive or compressive stress, and is given by $H_1 - H_0 = 0.9$; but in the next and all succeeding panels the difference $H_{n+1} - H_n$ is negative, and the stress in the web diagonals is therefore a negative or tensile stress, whose horizontal component is -0.1 in every bay.

Each line of the table is constructed in the same way, and shows that in all cases the load produces a positive stress in all panels to its left and a negative stress in all panels to its right.

Each column of Table 3 shows the positive and negative stresses produced in any given diagonal by the unit load placed successively upon the several joints; and adding up separately the positive and the negative values, we obtain the greatest stress of either kind that can be produced by the passage of the rolling load. The algebraical sum of the whole represents of course the horizontal stress in each panel of the web due to the entire load.

For a rolling load of uniform intensity, we only want the three totals given at the foot of the table, which express the horizontal stress in units of $Q \frac{b}{d}$. Of course the vertical component in each diagonal is equal to the horizontal component $\times \frac{d}{b}$; and therefore the table gives the vertical stress in each diagonal in units of Q —no matter what may be the depth of the girder.

194. Exact Method of Finding the Maximum Shearing Stress.—The figures given in Table 3 represent the exact stresses that would occur under successive positions of a train of uniform density headed by a concentrated wheel load equal to $\frac{Q}{2}$.

But if the train is of uniform density *throughout*, the shearing stresses can never be quite so high as the figures given in the table. If it errs at all, therefore, the table errs on the safe side; and being based upon an assumption which is really nearer to the truth than the assumption of a uniform train load, it is practically more correct than the exact values which may be found upon the latter hypothesis.

We shall therefore use the table in preference to the mathematical maximum; but as some authorities prefer the latter, we may consider briefly how it may be arrived at.

To find the exact position of the head of the train which produces the greatest shearing stress in any panel, let AC in Fig. 198 represent the span, and let DE represent the panel in question.

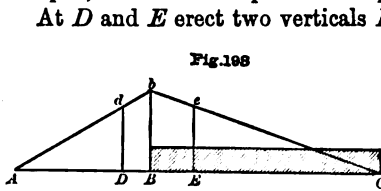

Fig. 198

At D and E erect two verticals Dd and Ee of any equal height; and through d and e draw the straight lines Adb and Ceb intersecting each other at b . Then dropping the vertical bB , the point B will be the point in question, and the greatest positive shearing stress

will occur when the train covers BC , while the greatest negative stress will occur when the length AB is covered.

For if any load is placed at the point B , the resulting diagram of flange stress for that load will be represented by the triangle AbC ; and the flange stress Dd being (by construction) equal to the flange stress Ee , the resulting stress in the web-panel DE , or $H_1 - H_2$ will be nothing.

But if any element of load is placed to the right of B the resulting triangle will indicate a greater flange stress at E than at D , and will therefore indicate a positive shearing stress in the web-panel DE ; and *vice versa*.

Consequently the greatest shearing stress takes place when every point between B and C is loaded with its element of the uniform train load. The resulting maxima and minima can be found without difficulty,

and by way of comparison with Table 3, the following are the exact values for the girder of Fig 197.

	Number of Panel.									
	0-1	1-2	2-3	3-4	4-5	5-6	6-7	7-8	8-9	9-10
Positive	4.5	3.55	2.72	2.00	1.39	0.89	0.50	0.22	0.05	0.
Negative	-0.	-0.05	-0.22	-0.50	-0.89	-1.39	-2.00	-2.72	-3.55	-4.5
Sum	4.5	3.50	2.50	1.50	0.50	-0.50	-1.50.	-2.50	-3.50	-4.5

195. Practical Maxima and Minima.—We shall here adopt the values given in Table 2 and Table 3 ; and for parallel girders of any moderate span, we may assume without much error that the dead load will be uniformly distributed. On that assumption, the horizontal stresses due to the dead load p will be represented by the algebraical sum of the quantities in each column ; while the positive and negative totals will indicate the greatest stresses of either kind due to the live load of intensity q .

As these figures will apply to any form of single bracing, and to any proportion of span to depth of girder, we may at once complete the calculations, up to this point, for girders divided into any desired number of equal panels.

In the following tables N is the number of panels, while H_p and H_q denote the horizontal stresses due to the dead and live load respectively in units of P_d^b and of Q_d^b .

The girder being symmetrical, it will only be necessary to give the stresses for the left half of the span. If all the diagonals of the web are inclined in the direction shown in Fig. 197, the positive sign in Table 3 will indicate compression and the negative sign tension. If the diagonals are inclined in the opposite direction this rule will be exactly reversed.

TABLES OF HORIZONTAL STRESS IN THE FLANGES AND WEB OF A PARALLEL GIRDER OF N EQUAL BAYS,

Expressed in units of $P \frac{b}{d}$ or $Q \frac{b}{d}$

TABLE 4.—N = 4.

Shearing Stress.

Panel	0-1	1-2
Max. H_q (for movable load)	1.50	0.75
Min. H_q do.	0.	-0.25
H_q (for total load) or H_p	1.50	0.50

Flange Stress.

No. of joint	1	2
H_q or H_p	1.5	2.0

TABLE 5.—N = 5.

Shearing Stress.

Panel	0-1	1-2	2-3
Max. H_q	2.0	1.2	0.6
Min. H_q	0.	-0.2	-0.6
H_q or H_p	2.0	1.0	0.

Flange Stress.

No. of joint	1	2	3
H_q or H_p	2.0	3.0	3.0

TABLE 6.—N = 6.

Shearing Stress.

Panel	0-1	1-2	2-3
Max. H_q	2.50	1.667	1.00
Min. H_q	0.	-0.167	-0.50
H_q or H_p	2.50	1.50	0.50

Flange Stress.

No. of joint	1	2	3
Max. H_q or H_p	2.50	4.0	4.50

TABLE 7.—N = 7.

Shearing Stress.

Panel	0-1	1-2	2-3	3-4
Max. H_q	3.00	2.143	1.429	0.857
Min. H_q	0.	-0.143	-0.429	-0.857
H_q or H_p	3.00	2.00	1.00	0.

Flange Stress.

No. of joint	1	2	3	4
Max. H_q or H_p	3.00	5.0	6.0	6.0

TABLE 8.—N = 8.

Shearing Stress.

Panel	0-1	1-2	2-3	3-4
Max. H_q	3.50	2.625	1.875	1.25
Min. H_q	0.	-0.125	-0.375	-0.75
H_q or H_p	3.50	2.50	1.50	0.50

Flange Stress.

No. of joint	1	2	3	4
Max. H_q or H	3.50	6.0	7.50	8.0

TABLE 9.—N = 9.

Shearing Stress.

Panel	0-1	1-2	2-3	3-4	4-5
Max. H	4.00	3.111	2.333	1.667	1.111
Min. H_q	0	-0.111	-0.333	-0.667	-1.111
H_q or H_p	4.0	3.0	2.0	1.0	0

Flange Stress.

No. of joint	1	2	3	4	5
H_q or H_p	4.0	7.0	9.0	10.0	10.0

TABLE 10.—N = 10.

Shearing Stress.

Panel	0-1	1-2	2-3	3-4	4-5
Max. H_q	4.50	3.60	2.80	2.10	1.50
Min. H_q	0	-0.10	-0.30	-0.60	-1.00
H_q or H_p	4.50	3.50	2.50	1.50	0.50

Flange Stress.

No. of joint	1	2	3	4	5
H_q or H_p	4.5	8.0	10.5	12.0	12.5

TABLE 11.—N = 11.

Shearing Stress.

Panel	0-1	1-2	2-3	3-4	4-5	5-6
Max. H_q	5.00	4.091	3.272	2.545	1.919	1.363
Min. H_q	0.	-0.091	-0.272	-0.545	-0.919	-1.363
H_q or H_p	5.0	4.0	3.0	2.0	1.0	0.

Flange Stress.

No. of joint	1	2	3	4	5	6
H_q or H_p	5.0	9.0	12.0	14.0	15.0	15.0

TABLE 12.—N = 12.

Shearing Stress.

Panel	0-1	1-2	2-3	3-4	4-5	5-6
Max. H_q	5.50	4.583	3.75	3.0	2.333	1.75
Min. H_q	0.	-0.083	-0.25	-0.5	-0.833	-1.25
H_q or H_p	5.5	4.5	3.5	2.5	1.5	0.5

Flange Stress.

No. of joint	1	2	3	4	5	6
H_q or H_p	5.5	10.0	13.5	16.0	17.5	18.0

TABLE 13.—N = 13.

Shearing Stress.

Panel	0-1	1-2	2-3	3-4	4-5	5-6	6-7
Max. H_q	6.00	5.077	4.231	3.462	2.769	2.154	1.615
Min. H_q	0.	-0.077	-0.231	-0.462	-0.769	-1.154	-1.615
H_q or H_p	6.0	5.0	4.0	3.0	2.0	1.0	0.

Flange Stress.

No. of joint .	1	2	3	4	5	6	7
H _q or H _p .	6·0	11·0	15·0	18·0	20·0	21·0	21·0

TABLE 14.—N = 14.

Shearing Stress.

Panel . .	0-1	1-2	2-3	3-4	4-5	5-6	6-7
Max. H _q .	6·50	5·571	4·714	3·929	3·214	2·571	2·0
Min. H _q .	0·	-0·071	-0·214	-0·429	-0·714	-1·071	-1·5
H _q or H _p .	6·5	5·5	4·5	3·5	2·5	1·5	0·5

Flange Stress.

No. of joint .	1	2	3	4	5	6	7
H _q or H _p .	6·5	12·0	16·5	20·0	22·5	24·0	24·5

TABLE 15.—N = 15.

Shearing Stress.

Panel . .	0-1	1-2	2-3	3-4	4-5	5-6	6-7	7-8
Max. H _q .	7·0	6·067	5·20	4·40	3·667	3·0	2·4	1·867
Min. H _q .	0·	-0·067	-0·20	-0·40	-0·667	-1·0	-1·4	-1·867
H _q or H _p .	7·0	6·0	5·0	4·0	3·0	2·0	1·0	0·

Flange Stress.

No. of joint .	1	2	3	4	5	6	7	8
H _q or H _p .	7·0	13·0	18·0	22·0	25·0	27·0	28·0	28·0

TABLE 16.—N = 16.

Shearing Stress.

Panel . . .	0-1	1-2	2-3	3-4	4-5	5-6	6-7	7-8
Max. H_q . . .	7.5	6.562	5.687	4.875	4.125	3.437	2.812	2.25
Min. H_q . . .	0.	-0.062	-0.187	-0.375	-0.625	-0.937	-1.312	-1.75
H_q or H_p . . .	7.5	6.5	5.5	4.5	3.5	2.5	1.5	0.5

Flange Stress.

No. of joint . . .	1	2	3	4	5	6	7	8
H_q or H_p . . .	7.5	14.0	19.5	24.0	27.5	30.0	31.5	32.0

We have said that the figures given in the above tables will apply to parallel girders of any proportion of depth to span, and to different types of single intersection bracing ; but we have now to consider how they may be used to find the stresses in each bar of a girder of any given type.

196. Girders Braced with Inclined Struts and Vertical Ties.—This construction is sometimes, though not very frequently adopted, each half of the span being similar to the left half of Fig. 197.

The horizontal stress in each bar of the web, and at each joint of the flanges, is given by the figures in the left half of Tables 2 and 3, or one of the Tables 4 to 16, according to the number of panels.

If Fig. 199 represents any bay of the bracing, it is obvious that the compressive stress at n must be borne by the bar nm , so that the stress in that bar is denoted by H_n . For the same reason H_M denotes the tensile stress in the bar NM of the lower flange ; and $H_m - H_n$ is the horizontal component of the compressive stress in the diagonal mN .

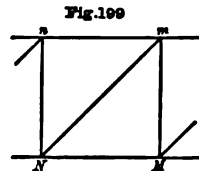

It is unnecessary to consider this type of bracing in further detail, as it is not often adopted.

197. Girder Braced with Vertical Posts and Inclined Ties.—This form of construction is illustrated in Fig. 201. With the exception of the counter-braces, which for the sake of distinction are shown in dotted lines, each half of the span is similar to the right half of Fig. 197. Therefore the figures in the right half of Table 3 will give the horizontal

stresses in the diagonals, the positive sign indicating compression and the negative sign tension ; while the rules contained in the last article, and illustrated in Fig. 199, will apply equally to any bay in the right half of Fig. 201.

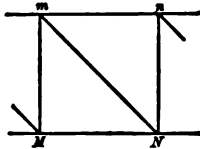

But it will be convenient to deal in all cases with the left half of the span ; and if we turn Fig. 199 end for end, it may of course be taken to represent a bay in the left half of our girder, as shown

in Fig. 200 ; and we shall then have again—

$$\begin{aligned}
 H_m &= \text{horizontal compressive stress in } mn ; \\
 H_M &= \text{do. tensile do. in } MN ; \\
 H_n - H_m &= \text{do. do. do. in } mN ; \\
 H_m - H_n &= \text{do. compressive do. in } mN .
 \end{aligned}$$

The stress in each diagonal has the same value as before, but the brace being inclined in the opposite direction the stress is of the opposite kind. Thus, for example, in the girder of Fig. 201, which is divided into 10 equal bays, the horizontal stresses in the left half of the span will be as follows :—

TABLE 10A.—Horizontal Stresses in Units of $Q \frac{b}{d}$.—Fig. 201.

Number of Panel . . .	0-1	1-2	2-3	3-4	4-5	
Braces {	Max. H_q . . .	-4.50	-3.60	-2.80	-2.10	-1.50
	Min. H_q . . .	0.	0.10	0.30	0.60	1.00
	Sum H_q (or H_p) . . .	-4.50	-3.50	-2.50	-1.50	-0.50
Upper flange do. . .	4.50	8.00	10.50	12.00	12.50	
Lower flange do. . .	0.	-4.50	-8.00	-10.50	-12.00	

In all cases compression is denoted by the positive, and tension by the negative sign ; then the third line of the above table, being the algebraical sum of the first and second lines, will give the horizontal tensile stress in the braces due to the entire load ; and the algebraical sum of the third, fourth, and fifth lines must, in every panel, be equal to zero ; because at every vertical section the thrusts must balance the pulls. In writing the table down rapidly this rule will serve as a check. At the same time it will be convenient in practice to denote by Max. H the greatest horizontal stress that takes effect in a bar, no matter whether it be a tensile or compressive stress ; and then of course Min. H will either denote the least stress of the same kind, or the greatest stress of the opposite kind. Thus, in the above table, the maximum horizontal stress H_q , in either of the braces, is a tensile stress ; and Min. H_q is a compressive stress.

Example.—The above figures will of course apply to a girder of any span and of any depth, and to any values of the dead and live load. But to illustrate their application, let Fig. 201 be taken to represent

a double line railway bridge of 120 feet span, consisting of two main girders, with cross-girders attached to the joints of the lower chord I to IX inclusive. The span being divided into 10 equal panels, the panel width will be $b = 12$ feet.

For a span of 120 feet it appears from Art. 174, Table 3, that we should take the live load at $q = 1.25$ tons per foot for each line; so that the live load on each joint will be $Q = qb = 15$ tons.

As regards the dead load, we may estimate the weight of the cross-girders, flooring, permanent way, and wind-bracing at $w_1 = 0.75$ tons per foot; but for the main girders we can only at present make a provisional assumption. Putting their combined weight at $w = 0.75$ tons per foot, the dead load on each girder will be $p = \frac{w + w_1}{2} = 0.75$ tons per foot; and the panel load on each joint I to IX will be $P = pb = 9$ tons.

With these loads, the stress in any bar of the web may be determined at once in terms of its vertical component without reference to the depth of the girder; for we have already seen that the values of the shearing stress H_v given in the tables, denote not only the horizontal components in units of $Q \frac{b}{d}$ but also the vertical components in terms of Q . Therefore multiplying H_p in Table 10a by $P = 9$ tons, and H_v by $Q = 15$ tons, we obtain the vertical stress in each diagonal due to the dead and live load respectively as given in Table 10v. The stress in the diagonals will be the same whether the load is applied at the top or at the bottom of the vertical posts; but the compressive stress in the verticals will of course depend upon that question. If the entire dead and live load were applied at the lower joints, it is evident that the vertical compression in any post mM (Fig. 200) would be equal to the vertical component of the tensile stress in mN ; but adding upon the top of each post a load equal to one-half of the panel weight of either girder, or say 2.2 tons, we have the compressive stress in each vertical as given in the following table:—

TABLE 10v.—Vertical Stresses in a Girder of 120 Feet Span.—Fig. 201.

Member.	Dead Load	Live Load.		Combined Load.		Ratio.	Diff.
	V _p .	Max. V _p .	Min. V _p .	Max. V.	Min. V.	$\frac{\text{Min. V.}}{\text{Max. V.}}$	$\frac{\text{Max. V.} - \text{Min. V.}}$
Braces	0-I	-40.5	-67.5	0.	-108.0	-40.5	...
	1-II	-31.5	-54.0	1.5	-85.5	-30.0	...
	2-III	-22.5	-42.0	4.5	-64.5	-18.0	...
	3-IV	-13.5	-31.5	9.0	-45.0	-4.5	...
	4-V	-4.5	-22.5	15.0	-27.0	10.5	...
Posts	A-0	42.7	67.5	0.	110.2	42.7	0.388
	1-I	38.7	54.0	-1.5	87.7	32.2	0.368
	2-II	24.7	42.0	-4.5	66.7	20.2	0.303
	3-III	15.7	31.5	-9.0	47.2	6.7	0.142
	4-IV	6.7	22.5	-15.0	29.2	-8.3	-0.284
	5-V	2.2	0.	0.	2.2	2.2	1.0

This table refers to a girder constructed *without* the counterbraces indicated in dotted lines in Fig. 201.

The columns V_p , Max. V_q , and Min. V_q are obtained as above described, and give the vertical stresses due to the dead and live load respectively.

The column Max. V gives the greatest stress of either kind due to the combined dead and rolling load, the figures being the sum of V_p and Max. V_q .

The column Min. V gives the least stress of the same kind or the greatest stress of the opposite kind, the figures being the algebraical sum of V_p and Min. V_q . This column shows that the braces are always under a tensile stress, except in the case of the brace 4-V, which will sometimes be subject to a compressive stress whose vertical component is 10.5 tons. Also the post 4-IV will sometimes be subject to a tensile stress of 8.3 tons.

The column $\frac{\text{Min. } V}{\text{Max. } V}$ is easily constructed, and the values are equivalent, both in the posts and in the braces, to the ratio $\frac{\text{Min. } S}{\text{Max. } S}$, which will be used in finding the required sectional areas by the Launhardt-Weyrauch method.

The column Max. $V - \text{Min. } V$ gives the dynamic increment of stress in the verticals for the case of a train travelling at unlimited speed and imposing the live load instantaneously upon each member. These values will be employed in finding the sectional areas by the dynamic theory mentioned in Chapter XIII.

All the results obtained hitherto are independent of the depth of the girder; but that dimension must now be fixed in order to find the horizontal flange stress and the inclined stress in the diagonals. And it is obvious that the direct stress in the inclined braces will be equal to the vertical component multiplied by cosec. θ , the angle of inclination with the horizontal being denoted by θ . In other words, if mM in Fig. 200 represents the vertical component, the direct stress will be represented by mN .

We will now suppose that the girder of Fig. 201 is designed to have a depth of 12 feet or $\frac{1}{10}$ th of the span; so that $\frac{b}{a} = 1$, and consequently all the braces will be inclined at an angle of 45° . The figures of Table 10A give us the horizontal flange stress in units of $P\frac{b}{a}$ and of $Q\frac{b}{a}$; therefore multiplying those figures by $P = 9$ tons, and by $P + Q = 24$ tons, we obtain the greatest and least stress in each bar of the flanges, as in Table 10s. Also multiplying the vertical stresses Max. V and Min. V in Table 10v by cosec. $\theta = \sqrt{2} = 1.414$, we obtain the direct stresses Max. S and Min. S .

TABLE 10s.—*Direct Stresses in a Girder of 120 feet span and 12 feet depth.—Fig. 201.*

Member.	Max. S.	Min. S.	Min. S. Max. S.	Max. S - Min. S.	
Upper Chord	0-1 .	108·0	40·5	0·375	67·5
	1-2 .	192·0	72·0	0·375	120·0
	2-3 .	252·0	94·5	0·375	157·5
	3-4 .	288·0	108·0	0·375	180·0
	4-5 .	300·0	112·5	0·375	187·5
Lower Chord	A-I .	0·	0·	...	0·
	I-II .	-108·0	-40·5	0·375	-67·5
	II-III .	-192·0	-72·0	0·375	-120·0
	III-IV .	-252·0	-94·5	0·375	-157·5
	IV-V .	-288·0	-108·0	0·375	-180·0
Braces	0-I .	-152·7	-57·3	0·375	-95·4
	1-II .	-120·9	-42·4	0·350	-78·5
	2-III .	-91·2	-25·4	0·278	-65·8
	3-IV .	-63·6	-6·4	0·100	-57·2
	4-V .	-38·2	14·8	-0·387	-53·0

198. **Girder with Inclined Ties and Counterbraces.**—In the last example it was found that, under a certain position of the rolling load, a reverse shearing stress of 10·5 tons (vertical) takes place in the panel 4-5, producing a compressive stress of 14·8 tons (direct) in the brace 4-V; and referring to Table 3 it will be seen that this takes place when the joints V to IX are weighted with the live load.

But if it is intended that the diagonals shall act only as ties, this reverse shearing stress may be provided for by introducing the counterbraces 5-IV, &c., as shown in dotted lines in Fig. 201, Plate I. This will prevent the insistence of any compressive stress in the brace 4-V, and the tensile stress in that member will vary between 38·2 tons and zero, so that the ratio $\frac{\text{Min. S}}{\text{Max. S}}$ will be zero; and the quantity Max. S - Min. S will be 38·2 tons.

We may also estimate approximately that the greatest shearing stress to be borne by the counterbrace 5-IV will be the reverse shearing stress of 10·5 tons, producing a direct tension of 14·8 tons. But strictly speaking, the stresses in brace and counterbrace will depend upon the initial tension imposed upon them in their first adjustment. Supposing that adjustment to be made without slackness and without strain, we can estimate the stress upon either of two assumptions. 1st. If the adjustment is made when the girder is lying on its side, and when the brace 4-V is consequently without strain, the counterbrace will not come into play until the normal stress in the brace (due to the dead load) has been reduced to zero by the contrary shearing stress of the live load; and in this case the above estimate will be nearly correct. 2d. If the adjust-

ment is made when the girder is upright, and carrying the entire dead load, the brace will have a certain initial tension, and the counterbrace will begin to suffer strain directly this initial tension in the brace is reduced below its normal quantity. In this case it will be safest to take the total shearing stress due to the live load, or $\text{Min. } V_q = 15$ tons, as the vertical stress in the counterbrace.¹

The way in which the normal tensile stress in each brace is reduced by the action of the rolling load, is clearly to be seen by reference to Table 3; and it is evident that if the dead load were very light, every panel except those at the extreme ends would be liable to a reverse shearing stress; and the question whether a given panel requires to be counterbraced will therefore depend upon the relative magnitude of the dead and live loads. But when the vertical stresses have been tabulated as in Table 10v, it will at once be seen how far the counterbracing should extend. In the present example the table shows that the normal tension in the brace 3-IV is sometimes reduced to a very small quantity; and in order to provide against an over-estimate of the dead load, or an under-estimate of the rolling load, it will certainly be advisable to counterbrace that panel. In connection with this it may also be necessary to examine the effect of a rolling load containing an engine or engines with a heavily loaded wheel-base.

Apart from this question, the stresses in the flanges, and in all the remaining members, will of course be the same as in the last example, except that we shall have to provide for a maximum load of $15 + 2 \cdot 2 = 17 \cdot 2$ tons upon the central post; while the post 4-IV will be subject to a load varying from 29·2 to 2·2 tons; and all the stresses are easily obtainable from the tables, whatever may be the number of counterbraced panels.

199. Girder with Inclined Terminal Struts.—The construction as above described is sometimes modified by reversing the inclination of the diagonal in the first and last panels, as shown in Fig. 202, Plate I, the girder being terminated at the ends by a pair of inclined struts instead of vertical posts.

The remaining panels of the truss are unaltered in construction, and the stresses are unaltered in every panel except in 0-1 and 9-10, where they are exactly reversed, because in these panels the bracing is of the first kind, as in Fig. 199. The shearing stress, without being changed in value, gives a positive or compressive stress in the diagonal A-1. The tensile stress in the bar A-I of the lower chord is given by H_1 , which in this example is equal to $-4 \cdot 5 Q \frac{b}{d}$; and the compressive stress in the line 0-1 of the upper chord is $H_0 = 0$.

For this type of construction, therefore, the Table 10A will be modified in the first column as follows:—

¹ An exact analysis of the elastic strains would probably give an intermediate value between 10·5 and 15 tons.

TABLE 10B.—*Horizontal Stresses in Units of $Q \frac{b}{a}$.*—Fig. 202.

Number of panel . . .		0-1	1-2	2-3	3-4	4-5
Braces	Max. H_q . .	4.5	-3.6	-2.8	-2.1	-1.5
	Min. H_q . .	0.	0.10	0.3	0.6	1.0
	Sum H_q (or H_p) . .	4.5	-3.5	-2.5	-1.5	-0.5
Upper flange	do. . .	0.	8.0	10.5	12.0	12.5
Lower flange	do. . .	-4.5	-4.5	-8.0	-10.5	-12.0

This table will apply to a girder of 10 panels, of any span or depth ; and it is unnecessary to illustrate its application to any particular example. For a girder of 120 feet span and 12 feet depth, the stresses already found will of course apply to this type with the modifications above indicated ; and it will readily be seen that the vertical 1-I acts merely as a suspender carrying the panel load $P + Q$.

200. **Warren Girder with Vertical Suspenders.**—The girder illustrated in Fig. 203, Plate I., is a Warren girder, in which the web-bracing consists of five isosceles triangles ; but as the upper joints are loaded by means of the vertical ties or suspenders, the platform is really divided into 10 panels and supported at each of the points 1 to 9 inclusive. The stresses may therefore be taken from Table 10, due regard being paid to the direction in which each diagonal is inclined. In the 1st, 3d, and 5th panels, the bracing is of the first kind, and the stresses will follow the rule of Fig. 199. In the 2d and 4th panels the bracing is of the opposite kind, and the stresses will follow the rule of Fig. 200.

Therefore, for this type of construction, the table of horizontal stresses must be written as follows :—

TABLE 10C.—*Horizontal Stresses in Units of $Q \frac{b}{a}$.*—Fig. 203.

Number of Panel . . .		0-1	1-2	2-3	3-4	4-5
Braces	Max. H_q . .	4.5	-3.6	2.8	-2.1	1.5
	Min. H_q . .	0	0.1	-0.3	0.6	-1.0
	Sum H_q (or H_p) . .	4.5	-3.5	2.5	-1.5	0.5
Upper flange	do. . .	0.	8.0	8.0	12.0	12.0
Lower flange	do. . .	-4.5	-4.5	-10.5	-10.5	-12.5

Each of the verticals 1, 3, 5, 7, 9, will act as a suspender carrying the load $P + Q$; but the remaining verticals will have no function except to support and stiffen the upper flange of the girder.

If the platform is carried upon the upper chord the horizontal stresses

will be the same, but the last-named series of verticals will then act as pillars.

On the other hand, if the girder is turned upside down, as in Fig. 203A, the inclination of every brace will be reversed, and the horizontal stresses in each member will have the same value as before, but of the opposite kind, so that the table will be as follows:—

TABLE 10D.—Horizontal Stresses in Units of $Q \frac{b}{d}$ —Fig. 203A.

Number of panel . . .		0-1	1-2	2-3	3-4	4-5
Braces	Max. H_q . . .	-4.5	3.6	-2.8	2.1	-1.5
	Min. H_q . . .	0.	-0.1	0.3	-0.6	1.0
	Sum H_q (or H) . . .	-4.5	3.5	-2.5	1.5	-0.5
Upper flange	do.	4.5	4.5	10.5	10.5	12.5
Lower flange	do.	0.	-8.0	-8.0	-12.0	-12.0

In this case, of course, each of the verticals 1, 3, 5, 7, 9, will act as a post carrying the load $P + Q$; and no verticals are required at the intervening joints, unless for the purpose of suspending the weight of the lower chord.

201. Warren Girder without Verticals.—The same girder may be constructed as in Figs. 205 and 205A without vertical ties or posts; and

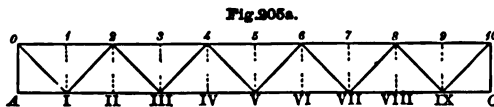
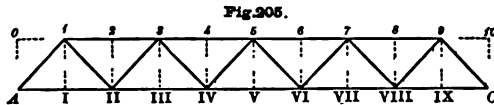

if the load is equally divided between all the joints, the omission of the verticals will make no difference to the stresses; but in general the roadway and the live load are carried by the joints of one flange, while the other is only loaded with one half the weight of the main girder, and the stresses are consequently somewhat modified.

In Fig. 205 suppose the whole load to be attached to the lower joints, the live load on each joint being $Q = 2bq$; then considering the bridge as a girder of 10 panels loaded with the weight Q placed at each of the alternate joints II, IV, VI, VIII, we may take out from Tables

2 and 3 the stresses due to those particular loads ; and summing them up we shall have the following figures, which give the vertical shearing stress in units of Q , and the horizontal stresses in units of $Q \frac{b}{a}$.

Flange Stress.

H_1	H_2	H_3	H_4	H_5
2·0	4·0	5·0	6·0	6·0

Shearing Stress.

	0-1	1-2	2-3	3-4	4-5
Positive . . .	2·0	2·0	1·2	1·2	0·6
Negative . . .	0·	0·	-0·2	-0·2	-0·6
Sum . . .	2·0	2·0	1·0	1·0	0·

The table of stresses in each bar will therefore be as follows :—

TABLE 10E.—*Horizontal Stress in Units of $Q \frac{b}{a}$.*—Fig. 205.

Number of Panel . . .	0-1	1-2	2-3	3-4	4-5	
Braces {	Max. H_q . . .	2·0	-2·0	1·2	-1·2	0·6
	Min. H_q . . .	0·	0·	-0·2	0·2	-0·6
	Sum H_q (or H_p) . . .	2·0	-2·0	1·0	-1·0	0·
Upper flange do. . .	0·	4·0	4·0	6·0	6·0	
Lower flange do. . .	-2·0	-2·0	-5·0	-5·0	-6·0	

These figures will give us all that we want, on the assumption that the load is carried entirely at the lower joints ; but in order to make an exact calculation we must remember that one half of the weight of the main girders is applied at the upper joints, and we may therefore divide the dead load into two parts, taking Table 10E for the weight of the platform and Table 10C for the weight of the main girders.

If the girder were inverted as shown in Fig. 205A, and if each of the lower joints I, III, V, VII, IX, were subject to the same load Q , we

should proceed in the same way to take out from Tables 2 and 3 the stresses due to the loads on those alternate joints as follows:—

Flange Stress.

H ₁	H ₂	H ₃	H ₄	H ₅
2.5	4.0	5.5	6.0	6.5

Shearing Stress.

	0-1	1-2	2-3	3-4	4-5
Positive . .	2.5	1.6	1.6	0.9	0.9
Negative . .	0.	-0.1	-0.1	-0.4	-0.4
Sum . .	2.5	1.5	1.5	0.5	0.5

and the horizontal stresses in Fig. 205A would be as shown in the following table: ¹—

TABLE 10F.—*Horizontal Stresses in Units of $Q\frac{b}{d}$ —Fig. 205A.*

Number of Panel . . .		0-1	1-2	2-3	3-4	4-5
Braces	Max. H _q . .	-2.5	1.6	-1.6	0.9	-0.9
	Min. H _q . .	0.	-0.1	0.1	-0.4	0.4
	Sum H _q (or H _p) . .	-2.5	1.5	-1.5	0.5	-0.5
Upper flange do. . .		2.5	2.5	5.5	5.5	6.5
Lower flange do. . .		0.	-4.0	-4.0	-6.0	-6.0

The Warren girder is more commonly constructed with the diagonals inclined at an angle of 60° as in Fig. 204, Plate I; but the same method is applicable whatever may be the proportions of the girder or the inclination of the diagonals.

202. Single Lattice or Double Warren Girder.—In the girder illustrated in Fig. 206, each panel is braced with two diagonals intersecting each other and forming a single lattice. The roadway may be carried either

¹ This hypothetical case will be useful in dealing with duplex systems of bracing, although it does not represent quite accurately the distribution of load that would take place in such a bridge as Fig. 206A.

upon the upper or the lower flange ; and taking the latter case first, we will suppose the load to be attached to the joints I to IX, each joint being loaded with the dead load $P = pb$ and with the live load $Q = qb$.

The girder is in all respects equivalent to the two girders Figs. 205 and 205A welded into one ; the loads applied at the joints I, III, V., &c., will produce in each member the stresses given in Table 10F ; while the loads applied at the intervening joints II, IV, VI, VIII will be borne by the other system of bracing shown in Fig. 205, and will produce the stresses given in Table 10E. Therefore we have only to add together the figures given for each bay in Tables 10E and 10F, and we have the stresses as follows :—

TABLE 10G.—Horizontal Stresses in Units of $Q \frac{b}{d}$.—Fig. 206.

Number of Panel . . .		0-1	1-2	2-3	3-4	4-5
Diagonal struts	Max. H_q . .	2.0	1.6	1.2	0.9	0.6
	Min. H_q . .	0.	-0.1	-0.2	-0.4	-0.6
	Sum H_q (or H_p) .	2.0	1.5	1.0	0.5	0.
Diagonal ties	Max. H_q . .	-2.5	-2.0	-1.6	-1.2	-0.9
	Min. H_q . .	0.	0.	0.1	0.2	0.4
	Sum H_q (or H_p) .	-2.5	-2.0	-1.5	-1.0	-0.5
Upper flange do. . .	2.5	6.5	9.5	11.5	12.5	
Lower flange do. . .	-2.0	-6.0	-9.0	-11.0	-12.0	

If the load is carried upon the upper joints it will easily be seen that the stresses given in the table will change places—those given for the diagonal struts will apply with changed signs to the diagonal ties ; while those given for the upper flange will apply with changed signs to the lower flange, and *vice versa*.

The upper and lower joints of the girder are sometimes united by verticals, as shown in Fig. 207 ; and the verticals may be so adjusted as to divide the load equally, or nearly so, between the two systems of bracing. Assuming this to be done, we may regard the girder as equivalent to the two girders, Figs. 203 and 203A, united in one, each of the component girders carrying one-half of the load, or a weight of $\frac{Q}{2}$ at each joint. Therefore, dividing the figures of Tables 10C and 10D by two, we have the stresses resulting in each of the component girders ; and adding these stresses together, where they apply to the same bar, we have the following :—

TABLE 10v.—*Horizontal Stresses in Units of $Q \frac{b}{d}$* —Fig. 207.

Number of panel . . .		0-1	1-2	2-3	3-4	4-5
Diagonal struts	Max. H_q . . .	2·25	1·80	1·40	1·05	0·75
	Min. H_q . . .	0·	-0·05	-0·15	-0·30	-0·50
	Sum H^q (or H_p) . . .	2·25	1·75	1·25	0·75	0·25
Diagonal ties	Max. H_q . . .	-2·25	-1·80	-1·40	-1·05	-0·75
	Min. H_q . . .	0·	0·05	0·15	0·30	0·50
	Sum H_q (or H_p) . . .	-2·25	-1·75	-1·25	-0·75	-0·25
Upper flange do. . .	2·25	6·25	9·25	11·25	12·25	
Lower flange do. . .	-2·25	-6·25	-9·25	-11·25	-12·25	

When the roadway is attached to the lower flange, each of the verticals in this type of girder is supposed to act as a suspender and to convey one-half of the load to the upper joint; but it has before been mentioned that there is some ambiguity as to the extent of its action, and the question whether it conveys less or more than one-half of the load will depend upon its initial adjustment and upon the elastic strains throughout the girder. This is practically exemplified in the Charing Cross railway bridge, where it may be seen that some of the verticals show signs of a slight tendency to buckling, thus showing apparently that they are suffering a compressive stress, or, at all events, are not strained by any tensile force.

But however this may be, a comparison of the last two tables is sufficient to show at once how far the stresses would be modified if the vertical ties did not act at all; and therefore this contingency may easily be provided for by taking the former table wherever it gives the higher stress of the two.

Example.—Let Fig. 207 represent a double-line railway bridge consisting of two main girders; the span being 120 feet, and the depth 12 feet.

Then taking the dead load at $p=0·75$, and the live load at $q=1·25$ tons per foot, the loads on each joint will be $P=9$ tons and $Q=15$ tons, as in a previous example.

For the present purpose we will suppose the roadway to be attached to each vertical at the middle of its height; and that therefore the load is equally divided between the upper and lower joints, as assumed in Table 10k.

The value of $\frac{b}{d}$ in this example is again equal to 1, and multiplying H_q by P and by Q , we obtain the direct flange stress S_p and S_q ; while

the direct stress in any diagonal is equal to the horizontal stress multiplied by $\sqrt{2}$.

The compression members only need be considered, as the stress in the tension members is exactly the same.

TABLE 10K.—Direct Stresses in a Girder 120 feet span and 12 feet depth.—Fig. 207.

Member.	Dead Load.	Live Load.		Combined Load.		Ratio.	Diff.	
	Sp.	Max. S.	Min. S.	Max. S.	Min. S.	Min. S. Max. S.	Max. S. - Min. S.	
Upper flange	0-1	20.2	33.8	0.	54.0	20.2	0.375	33.8
	1-2	56.2	93.8	0.	150.0	56.2	0.375	93.8
	2-3	83.2	138.8	0.	222.0	83.2	0.375	138.8
	3-4	101.2	168.8	0.	270.0	101.2	0.375	168.8
	4-5	110.2	183.8	0.	294.0	110.2	0.375	183.8
Diagonal struts	A-1	28.6	47.7	0.	76.3	28.6	0.375	47.7
	I-2	22.3	38.2	-1.1	60.5	21.2	0.350	39.3
	II-3	15.9	29.7	-3.2	45.6	12.7	0.278	32.9
	III-4	9.6	22.3	-6.4	31.9	3.2	0.100	28.7
	IV-5	3.2	15.9	-10.6	19.1	-7.4	-0.387	26.5

203. "Linville" Truss.—Another form of duplex bracing is that of the Linville truss illustrated in Fig. 208, Plate I. In all the types of parallel girder hitherto considered, a vertical section taken at any one of the panel points will intersect nothing between the upper and lower flanges, and consequently the flange stress at any joint is measured by bending moment / depth, and in either flange is borne either entirely by the

flange, or by the combined horizontal stress of the flange and of some diagonal member attached to the joint in question. But in the Linville girder this is not the case, because a vertical section wherever taken will intersect one or more of the inclined ties; and the tensile stress in the lower flange will consequently be less than the compressive stress in the upper flange by an amount which is always equal to the horizontal stress in the tie or ties intersected. It is evident, however, that the bracing is composed of two distinct systems, the girder being equivalent to the two girders, Figs. 209 and 210, united

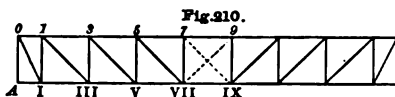
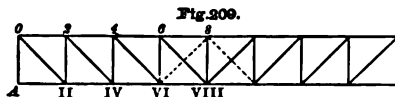

in one. Therefore if the load on each joint of Fig. 208 is denoted by $Q = qb$, we have to find the stresses produced in each girder, Figs. 209 and 210, by a load Q placed on each joint, and this will give us the

stresses in the diagonals ; while the flange stress in any panel will be the sum of the stresses in the two component girders.

By way of illustration we may take the case of a girder of 16 panels, as shown in Fig. 208, and the first system will then consist of 8 panels having the uniform width $B=2b$, for which Table 8 will give us the horizontal shearing stresses in units of $Q\frac{B}{d}$ or the vertical shearing stresses in units of Q .

The second system of Fig. 210 might be treated in the manner already employed for the Warren girder ; but a simpler method will be to find the vertical shearing stresses by subtracting the figures of Table 8 from those of Table 16, as follows :—

TABLE 16A.—*Vertical Shearing Stress in Units of Q.*—Fig. 208.

First System, Fig. 209, from Table 8.

Panel in Table 8 .	0-1		1-2		2-3		3-4	
„ in Fig. 208.	0-1	1-2	2-3	3-4	4-5	5-6	6-7	7-8
Max. V_q .	3·5	3·5	2·625	2·625	1·875	1·875	1·25	1·25
Min. V_q .	0·	0·	-0·125	-0·125	-0·375	-0·375	-0·75	-0·75
Sum . .	3·5	3·5	2·5	2·5	1·5	1·5	0·5	0·5
<i>Second System, Fig. 210, by subtraction.</i>								
Max. V_q .	4·0	3·062	3·062	2·25	2·25	1·562	1·562	1·00
Min. V_q .	0·	-0·062	-0·062	-0·25	-0·25	-0·562	-0·562	-1·00
Sum . .	4·0	3·0	3·0	2·0	2·0	1·0	1·0	0·
Panel in Fig. 210	0-1	1-3		3-5		5-7		7-8

The vertical shearing stress will be the same whether the load is applied at the top or at the bottom of each post, and will be expressed by the above figures in units of Q , whatever may be the depth of the girder.

The direct stress will of course be $S = V \operatorname{cosec} \theta$; and the horizontal component will be $H = V \operatorname{cotan} \theta$.

In practice the braces are very commonly inclined at an angle of 45° , so that $\operatorname{cotan} \theta = \frac{B}{d} = 1$, except in the terminal brace 0-I, in which $\operatorname{cotan} \theta = \frac{1}{2}$. For a girder of such proportions, therefore, the above figures will give H_q in units of $Q\frac{B}{d}$, without any alteration, except in the brace 0-I of the second system, for which $H_q = \frac{1}{2} = 2$.

Then commencing at 0, and summing up the horizontal stresses applied at each joint, when the whole girder is loaded, we have the greatest flange stresses as follows :—

TABLE 16B.—*Flange Stress in Units of $Q \frac{B}{d}$* —Fig. 208.

Upper Flange.

No. of Panel.	0-1	1-2	2-3	3-4	4-5	5-6	6-7	7-8
In girder, Fig. 209	3·5	3·5	6·0	6·0	7·5	7·5	8·0	8·0
„ „ 210.	2·0	5·0	5·0	7·0	7·0	8·0	8·0	8·0
„ „ 208.	5·5	8·5	11·0	13·0	14·5	15·5	16·0	16·0
<i>Lower Flange.</i>								
In girder, Fig. 209	0·	0·	-3·5	-3·5	-6·0	-6·0	-7·5	-7·5
„ „ 210.	0·	-2·0	-2·0	-5·0	-5·0	-7·0	-7·0	-8·0
„ „ 208.	0·	-2·0	-5·5	-8·5	-11·0	-13·0	-14·5	-15·5

It may be well to notice how great a difference there is between the stresses of the upper and lower flange, as the author has seen it somewhere stated that these stresses are equal. But it will be noticed that when the girder is fully loaded, the sum of the horizontal stresses in flanges and inclined ties is in every panel equal to zero, *i.e.*, the thrusts balance the pulls.

204. Double Lattice Girder.—If the systems of bracing are again reduplicated as shown, for example, in Fig. 211, Plate I., the stresses may be found by combining the stresses of the several systems in the manner already described.

Thus, suppose the second system of Linville bracing shown in Fig. 210 to be altered at the end panels by inclining the last brace parallel to the others, and attaching it to the centre of the end pillar 0-A, so that the brace shall have the position of the short lattice bar E-I in Fig. 211. Then the double lattice girder of Fig. 211 will be equivalent to the upright Linville girder combined with an inverted Linville girder; and if the load is equally divided between the upper and lower joints, each of the component girders will carry one half.

Therefore if the live load on each bay is denoted by $Q = qb$, the vertical stress $\pm V_q$ (in units of Q) will be exactly one half the value given in Table 16A for every diagonal including the end braces E-I and E-I; while the horizontal components will be $H_q = V_q \cot. \theta$, or in the case of lattice bars inclined at 45° , $H_q = V_q$.

The flange stress in any bay will be the sum of the stresses in each of the component girders; but the alteration introduced in the first panel will modify the flange stress in that panel, although it will not affect the stress in any other bay of either flange. In the panel 0-1 the stress in the upper flange of Fig. 210 will be unaltered, but the lower chord $A-I$ would then be subjected to a compressive stress equal to one half of the horizontal component in the brace $E-I$. Making this change and summing up the flange stresses in the upright and in the inverted girders, we have the flange stress for the double lattice girder of Fig. 211 as follows:—

TABLE 16C.—*Flange Stress in Units of $Q \cot. \theta$ or $Q \frac{B}{d}$* —Fig. 211.

No. of Panel	0-1	1-2	2-3	3-4	4-5	5-6	6-7	7-8
Upper flange	1.75	5.25	8.25	10.75	12.75	14.25	15.25	15.75
Lower flange	-1.75	-5.25	-8.25	-10.75	-12.75	-14.25	-15.25	-15.75

These values presuppose that the load is equally divided between the upper and lower joints. If, however, the verticals are altogether omitted (which is seldom done in practice), and if the load is attached to the lower flange, the diagonal ties will be more heavily strained than the diagonal struts, and the upper flange more heavily strained than the lower flange. This inequality has already been illustrated in the case of the single lattice girder of Fig. 206, and is shown in Table 10G. At the same time it may be noticed that in this case the horizontal stress in the tie $E-I$ will be greater than in the strut $E-1$, and the difference will constitute a horizontal force applied to the centre of the end pillar and tending to bend it inwards.

All this is exactly reversed if the load is applied to the upper flange; but if it is equally divided between the upper and lower joints by means of the verticals, the stresses in struts and ties are equal, and there is no bending stress upon the end pillars.

205. Plate-Webbed Girder.—The stresses in a plate girder may readily be found by the methods above described. If the girder of Fig. 212 is considered as a girder of N panels, the flange stress at each panel point, and the shearing stress acting at the upper and lower edges of each panel of the web, will be given by one of the Tables 4 to 16.

The horizontal shearing stress is greater in the end panels than in those nearer the centre, and naturally the shearing stress on the several rivets in any one panel increases in the same ratio. The greatest vertical shear takes place at the ends of the girder and is always equal to $(p + q) \frac{L}{2}$. The least vertical shearing stress takes place at the centre and is equal to $\pm q \frac{L}{8}$.

PARAL

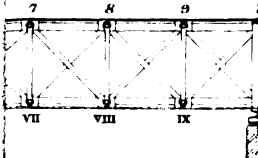
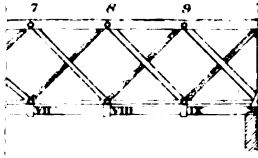
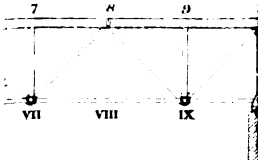
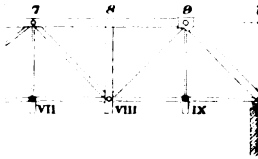
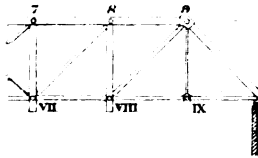
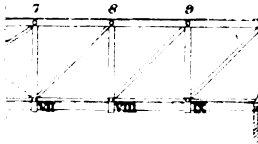

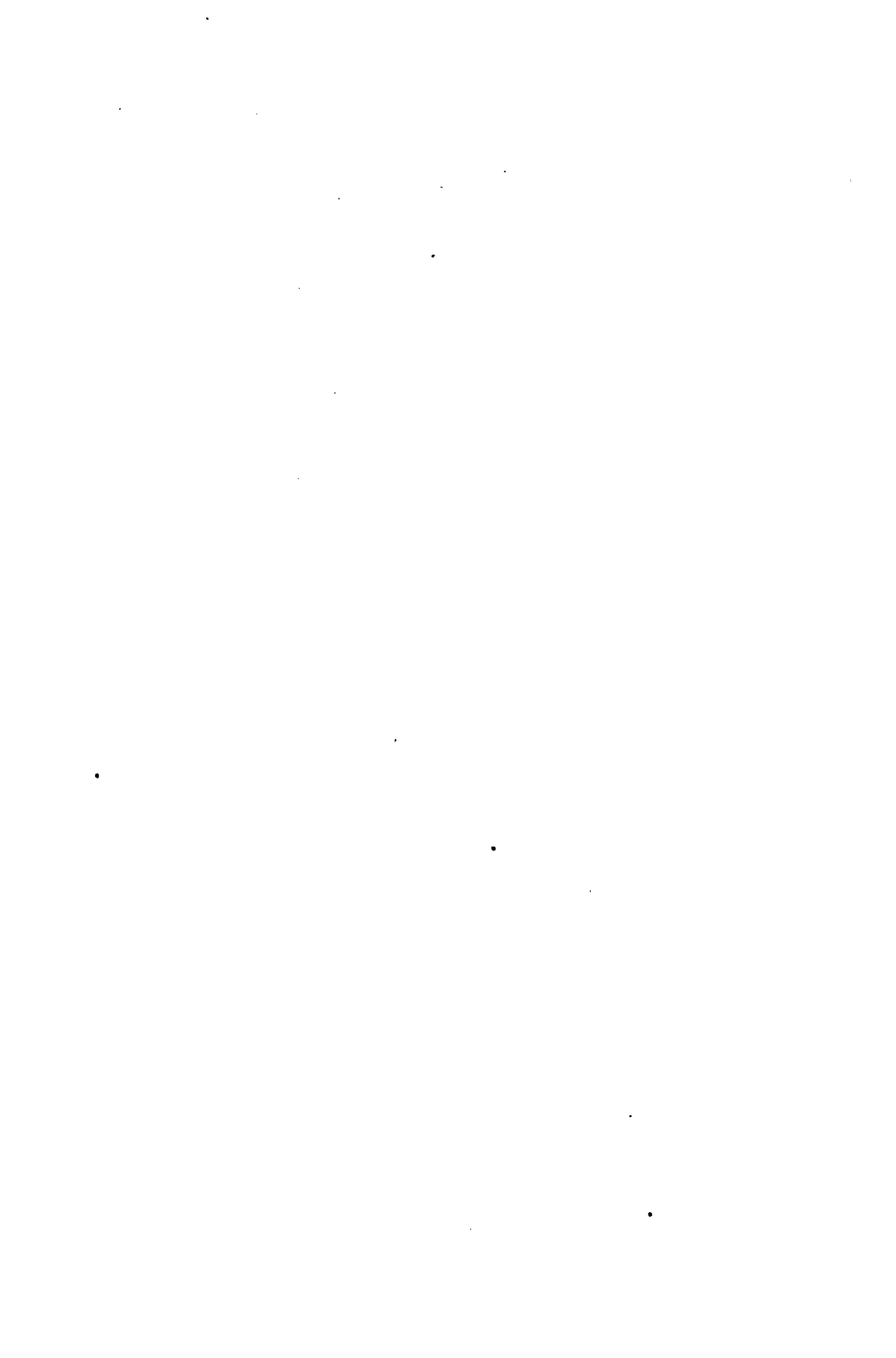

In practice the calculated shearing stress may be used to determine the required dimensions of the rivetting, but it cannot always be used to determine the thickness of the plate web. The determination of dimensions must, however, be considered separately in the next chapter.

The calculations which have been here described will generally be sufficient for that purpose, and may be readily applied to any given case, whatever may be the dimensions of the girder, the number of panels, or the value of the dead and live load. There are, of course, several other methods of making these calculations, but the tabulated form which we have here adopted is eminently convenient in practice, and affords a ready means of estimating and comparing the *weights* of structures by dealing alone with the rectangular components of stress and the rectangular co-ordinates of space; and this computation of the weight of the girder is a matter which we have yet to deal with.

CHAPTER XVII.

PARALLEL GIRDERS (*continued*)—DIRECT CALCULATION OF THE WEIGHT OF METAL.

206. In the previous chapter we have examined most of the known types of parallel girder, and have considered the stresses which are produced by dead and live loads of any given intensities.

In proceeding to design the details of a girder-bridge, these calculated stresses must be used as the basis on which to determine the requisite strength or scantling of each member ; but it will be observed that the calculation cannot be completed until we have ascertained the weight of the main girders, which will always form a considerable item in the dead load, and in large spans will form the chief portion of the entire load. Therefore, as the weight of the girders depends upon the scantling allotted to the various members, we have as yet no means of making the calculations except by trial and error.

The method most commonly adopted has been to make a provisional guess or empirical estimate of the weight of the main girders by the aid of known examples, and then having calculated the resulting stresses and the requisite sectional areas, to check that provisional estimate by measuring the mass of metal in the design thus arrived at. If the measurement differs from the provisional estimate, the whole of the calculation must be gone through again, and this process may have to be repeated several times before the final and initial estimates can be made to agree.

In the present chapter we shall consider how the same result may be obtained by one direct computation ; but while keeping this object in view we must first consider what sectional areas would in practice be allotted to the various members, assuming that the stresses are accurately known.

207. Theoretical and Practical Determination of the Sectional Areas of Members from their known Stresses.—To illustrate the various practical and theoretical methods of determining the proportions of a girder, we may take the example mentioned in Art. 197 of the preceding chapter, for which the stresses have already been worked out. The bridge consists of a pair of main girders of 120 feet span and 12 feet depth, carrying a double line of railway, the cross-girders being attached to the lower flange. The girders are of the type shown in Fig. 201

without counterbraces, so that some of the diagonals will be subject to alternate tension and compression.

The live load is taken at $1\frac{1}{2}$ tons per foot for each line, and the total dead load at $1\frac{1}{2}$ tons per foot, of which 15 cwt. is the ascertained weight of the platform, and the remaining 15 cwt. is the *assumed* weight of the main girders.

If the last-named assumption is correct, the maximum and minimum stresses will have the values given in Tables 10v and 10s of Art. 197; and from these stresses the sectional area of each member will have to be determined by one or another of the methods described in Chapter XIII, whose several results are compared together in the following tables.

First Method.—If we begin by consulting the old rule, and taking a uniform working stress of 5 tons per square inch for tension members, we have only to divide the Max. S by 5, and we obtain the sectional areas given in square inches in column A_0 . But in using the old rule it is generally considered necessary to modify the working stress in some arbitrary manner. The areas given in column A_0 would in practice be taken as sufficient for the net section of the lower flange; but they would not be deemed sufficient for the diagonal braces. The stress in the diagonal 4-V undergoes a great and violent change from 38 tons tension to 15 tons compression; and in the next diagonal the variation of load is also very great, though not quite so severe; and for both these members a lower working stress would be certainly adopted. The practical engineer, after revolving these points in his mind, would very likely decide that the working stress must not be greater than 4 tons per square inch in the diagonals, and the resulting sectional areas would be those given in column A_1 .

But even this would not be deemed sufficient for the central diagonals, and here he would perhaps resort to the plan of adding the tensile and compressive stresses together, which would augment the section of the diagonal 4-V to $\frac{38+15}{4} = 13.3$ square inches, but would leave the next brace untouched.

It is obvious, however, that this arbitrary adjustment does not perfectly accomplish the result aimed at; for there is no reason why the working stress in the brace 0-I should be less than in the lower flange, of which it virtually forms a part; and from this point the working load should be reduced in the successive braces according to the extent and violence of the stress variations.

This practical object is more precisely attained by the newer methods whose results are shown in columns A_4 , A_5 , and A_6 .

Fourth Method.—The areas as determined by the Weyrauch formula are given in column A_4 . This method, which was described in Chapter XIII, makes the working load equal to $4.44 \left(1 + \frac{1}{2} \cdot \frac{\text{Min. S}}{\text{Max. S}}\right)$, a quantity which of course varies in the different members of the web-bracing. In

this particular girder the sections of all the members, as given by this rule, appear to be somewhat lighter than would be adopted in the average of English practice.

Parallel Girder of 120 feet span.—Fig. 201. Sectional Areas as Determined by the Different Methods. Tension Members.

		Max. S.	Min. S.	A_0 .	A_1 .	A_4 .	A_5 .	A_6 .
Lower Flange	I-II .	-108·	-40·5	21·6	21·6	20·4	20·4	21·3
	II-III	-192·	-72·	38·4	38·4	36·2	36·2	37·8
	III-IV	-252·	-94·5	50·4	50·4	47·5	47·5	50·
	IV-V	-288·	-108·	57·6	57·6	54·3	54·3	56·7
Diagonal Braces	0-I .	-152·7	-57·3	30·5	38·2	28·8	28·8	37·2
	1-II .	-120·9	-42·4	24·2	30·2	23·1	23·1	30·
	2-III	-91·2	-25·4	18·2	22·8	18·2	19·0	23·5
	3-IV	-63·6	-6·4	12·7	15·9	13·7	15·5	18·
	4-V .	-38·2	+14·8	7·7	9·6 to 13·3	10·7	14·5	13·7

Fifth Method.—Column A_5 gives the sectional areas as determined by Seefehner's method, represented by the corresponding curve in the diagram of Fig. 192, and the figures show that in this particular case the results do not differ widely from those of the Weyrauch formula; although in other cases this method would give very extreme results—such as a working load of $9\frac{1}{2}$ tons per square inch in all members of a girder carrying a dead load only.

Sixth Method.—Column A_6 gives the sectional areas as determined by the alternative (dynamic) method proposed in Chapter XIII., and which takes account not only of the range, but also in some degree of the violence of the stress changes; the allowance made for such variations being greater in the case of the web bracing than in the flanges. The sectional areas are found by formula (3) of Chapter XIII., viz., $A = \frac{\text{Max. S} + \omega}{6\cdot66}$. In

every member this method gives a somewhat greater area than the Weyrauch formula; and its results agree very closely with the sections which would be allotted to each one of the members in ordinary modern practice—not only in the case of this particular girder, but in all ordinary cases.

Compression Members.—In determining the section of the compression members we must of course take account of the liability to buckling. Taking a working load of 4 tons per square inch, the sectional area of each panel of the flange, as determined by the old rule, will be given by the figures in column A_0 of the following table:—

Parallel Girder of 120 feet Span.—Fig. 201. Sectional Areas as Determined by the Different Methods. Compression Members.

		Max. S.	Min. S.	A_0 .	A_1 .	A_2 .	A^3 .	A .
Upper Flange	0-1	108·	40·5	27·	27·	25·5	25·5	26·6
	1-2	192·	72·	48·	48·	45·2	45·2	47·3
	2-3	252·	94·5	63·	63·	59·4	59·4	62·
	3-4	288·	108·	72·	72·	67·9	67·9	71·
	4-5	300·	112·5	75·	75·	70·7	70·7	74·
Vertical Posts	0-A	110·2	42·7	27·6	31 to 35	26·	25·	33·3
	1-I	87·7	32·2	21·9	25 to 29	21·2	21·	26·8
	2-II	66·7	20·2	16·7	20 to 23	16·2	16·8	21·2
	3-III	47·2	6·7	11·8	14·2 to 18·	12·5	14·7	16·4
	4-IV	29·2	-8·3	7·3	10·2 to 14·	10·	10·	12·5

If the upper flanges of the two main girders are united and mutually supported by overhead bracing, or if the member is designed with a broad and stiff cross-section, the liability to buckling may be neglected, and column A_0 will give the gross sectional area that would commonly be adopted in practice for the upper flange.

But if the old rule is used for the vertical posts of the web, their section will certainly be too weak to resist the buckling tendency. To meet this, some engineers would simply reduce the working load to $3\frac{1}{2}$ or 3 tons per square inch for all the posts alike ; but in America it is more usual to calculate the sectional area of each post by Gordon's or Rankine's formula. We have already seen that Rankine's formula can only be applied to this purpose in back-handed fashion by repeated trial and error ; but the formulæ and tables given in Chapter XI. will enable us to find the required area for any of the types of cross-section there referred to.

If we decide to adopt a very efficient form of cross-section, such as that shown in Table 15 (Art. 141), we can take the multiples given in that table for a length of $l=12$ feet, and we shall have the required sectional areas as given in column A_1 of the above table by the lesser of the two limits.

These areas, however, will only be sufficient if the most efficient proportions are adopted for the cross-section of each post ; and to do this might possibly involve the selection of rolled sections of different dimensions for each post, so that in practice the areas would have to be slightly greater in some of the posts at all events. On the other hand, if we select a less efficient form of cross-section, such as that shown in Table 11 of Chapter XI., or any cruciform section, the sectional areas will approximate to the higher limit given in column A_1 .

These figures represent therefore the sectional areas which in ordinary practice would be allotted to these vertical posts, after reference to the formulæ of Rankine or Gordon.

The sectional areas, as determined by the newer methods, are given as before in columns A_2 , A_3 , and A_4 . In employing either of these methods

for long struts liable to buckling, the most usual practice is to compare the result with that required by Rankine's formula, and to take whichever value is the highest.¹ In the present case, the unsupported length of 12 feet is so great in proportion to the load, that the sectional area required by Rankine's formula is greater in every post than the area resulting from Weyrauch's or Seefehner's method, so that the former value would be taken. But the areas given in column A_6 , and determined by the dynamic method, are in every case sufficient to comply with Rankine's formula, and coincide very closely with the mean of the two values given in column A_1 , or with the area which would be allotted to each member considered as a strut liable to buckling.

It is easy to see that this coincidence would not exist if the girder were designed for a lighter load or with a greater depth. Thus in the case of a single line bridge of the same span, the dead and live loads would be reduced to nearly one half, and the ratio between the *load* and the *length* of the vertical posts being reduced in the same proportion, the multiple m for Rankine's formula would be greater. But for double line bridges of any ordinary dimensions, it will generally be found that the sectional areas given by the "sixth" method are sufficient to comply with Rankine's formula, and agree pretty nearly with the average of modern practice in parallel girders of the most usual proportions.

208. Practical Weight of Girders.—We are now in a better position to deal with the important question of the weight of metal required in the construction of girders. For the purposes of bridge design some measurement of this quantity is indispensable, and it can only be made upon the basis of the theoretical areas of the several members; while there is really no difficulty in making a satisfactory measurement upon this basis, provided that the areas are fixed by a method which gives their real and not their imaginary values.

We have seen that the areas adopted in practice are in some cases 100 per cent. greater than those given by the old rule, and when the mass of metal is calculated by that rule it is commonly multiplied by a very large factor to cover this discrepancy, and sometimes a much higher factor has been used for the vertical than for the horizontal members. But it is obvious that this method can only yield very discordant results, because the same factor cannot correctly be applied to all the different cases that arise in practice. On the other hand, if the newer methods are employed, the calculated areas will approximate closely to their real values, and no empirical factor will be needed unless for the purpose of covering the *practical waste of construction* in joints and cover-plates, and in adapting the verticals to act as stiffeners in certain cases.

¹ Some engineers have used Rankine's formula for buckling *along with* a reduced or "fatigued" resistance of the material as determined by Weyrauch; but the propriety of this double allowance has not been proved by experiment—is not substantiated by theory, and appears to be controverted by the experienced opinion of eminent practical men. *Vide* a paper by the author upon the "Practical Strength of Columns," *Transactions of the Institution of Civil Engineers*, vol. lxxxvi.

It will be necessary, however, to formulate the calculation so as to include the weight of the main girders in their total dead load, and for this purpose the "Weyrauch" method is inapplicable, because the ratio $\frac{\text{Min. } S}{\text{Max. } S}$ cannot be found until the weight of the main girders has been ascertained, which is precisely the unknown quantity of the problem. But if we determine the sectional areas by the "sixth" or dynamic method, they will be still more closely in accordance with practice; and adopting this method we may obtain a direct solution of the problem as follows.

The girder will have to carry three distinct loads, viz. : 1st. Its own weight, which may be taken as a uniform weight per foot, equally divided between the upper and lower joints; 2d. The dead weight of the platform and wind ties; and 3d. The rolling load.

Let w = the unknown weight of the main girders.

p = the ascertained weight of platform, &c.

q = the rolling load.

(All in tons per foot lineal).

S_w = the stress in any member due to w .

S_p = the stress in any member due to p .

Max. S_q = the maximum stress due to q .

Min. S_q = the minimum stress due to q .

Max. S = the maximum total stress.

Min. S = the minimum total stress.

The sectional area of any tie is determined by

$$A = \frac{\text{Max. } S + w}{6.66} = \frac{S_w + S_p + \text{Max. } S_q + w}{6.66}$$

in which $w = \text{Max. } S - \text{Min. } S$ in the case of the web.

$= \frac{1}{2}(\text{Max. } S - \text{Min. } S)$ in the case of the flanges.

A little consideration will show that in all cases w does not depend upon the unknown value of S_w , but solely upon the variations of stress produced by different positions of the rolling load, so that $\text{Max. } S - \text{Min. } S = \text{Max. } S_q - \text{Min. } S_q$. Therefore the sectional area of each member is really made up of three items— a_0 , a' , and a'' —which may be separately calculated from the stresses S_w , S_p , and $(\text{Max. } S_q + w)$; the two first being simply the stresses due to the dead load, while the third represents the greatest stress due to the rolling load, including the augmented effect produced by sudden imposition or rapid variation.

The cubic content of each member is equal to its length multiplied by its sectional area; and summing up these products we can easily find the cubic content or weight of the whole girder for any given load, the stresses due to that load having first been found.

If this calculation were made separately for each of the three loads above mentioned, we should then have the total weight of the girder = $W = W_w + W_p + W_q$; or dividing the total weight by the span, the weight per foot lineal may be denoted by $w = w_w + w_p + w_q$.

We have already seen, in Chapter VII., that the weight of the girder

for a dead load p may easily be obtained by dealing with the rectangular co-ordinates and the rectangular components of stress, and is expressed by $W_p = pL \cdot \Sigma \gamma (\alpha RL + \beta D)$; and dividing again by the span L we have the weight per foot $= w_p = pL \cdot \Sigma (\alpha R + \frac{\beta}{R})$, in which R is the ratio of span to depth of girder, γ is the specific weight of the member per ton of stress, while α and β are coefficients whose values are given in Tables 1 to 16 of that chapter.

Treating in the same way the rectangular components of the stresses S_w and $(\text{Max. } S_q + \omega)$, which have been discussed in Chapter XVI., we may readily find the altered values of α and β applicable to the corresponding dead load w divided between the upper and lower joints, and to the rolling load q .

These values have been calculated for most of the ordinary types of parallel girder, and are given in Tables 1 to 8A of the present chapter,

where μ denotes the quantity $(\alpha R + \frac{\beta}{R})$ for the dead load w

$$\begin{array}{ccccccc} \mu' & \text{''} & \text{''} & \text{''} & \text{''} & \text{''} & P \\ \mu'' & \text{''} & \text{''} & \text{''} & \text{''} & \text{''} & \text{for the rolling load } q \end{array}$$

so that $w_w = w L \cdot \Sigma \gamma \mu$
 $w_p = p L \cdot \Sigma \gamma \mu'$
 $w_q = q L \cdot \Sigma \gamma \mu''$

Therefore the total weight of the main girders per foot lineal will be

$$w = w_w + w_p + w_q = L (w \Sigma \gamma \mu + p \Sigma \gamma \mu' + q \Sigma \gamma \mu'')$$

Consequently we have

$$\begin{aligned} w(1 - L \Sigma \gamma \mu) &= L(p \Sigma \gamma \mu' + q \Sigma \gamma \mu'') \\ \text{or } w &= \frac{L(p \Sigma \gamma \mu' + q \Sigma \gamma \mu'')}{1 - L \Sigma \gamma \mu} \end{array} \quad (1)$$

which is the solution desired.

In this expression, which is applicable not only to parallel girders but to all other types of bridge construction, the specific weight γ will depend almost entirely upon the character of the joints and connections, and is a function of the practical skill evinced in the manufacture of *details*, while μ is a function of the theoretical skill evinced in the general design.

The value of γ , as explained in Chapter VII., will be $\cdot 0015 \frac{\kappa}{t}$, in which t is the unit working stress and κ a coefficient greater than unity and including the percentage of waste material in cover plates, rivet holes, &c. But as we are now proportioning the members to the augmented stress Ω , we must of course take $t = 6\cdot66$ in wrought-iron ties, and $5\cdot33$ in compression members; so that $\gamma_t = \frac{\cdot 0015 \kappa}{6\cdot66} = \cdot 000225 \kappa$, and $\gamma_c = \frac{\cdot 0015 \kappa}{5\cdot33} = \cdot 000281 \kappa$.

The percentage of waste material, as shown in good examples of the different kinds of workmanship, has already been discussed in Art. 169, and the values of κ there given will generally suffice for all tension members.

In compression members composed of rivetted plate and angles, the percentage of waste is generally from 20 to 30 per cent. less than in ties of a similar construction, because there is no loss of section to be allowed for at the rivet holes; so that we may take $\kappa = 1.40$ to 1.60 for the posts of the web (including overlap at the ends), and for the compression flange of a parallel girder we may take $\kappa = 1.70$.

For an approximate calculation of the weight of girders which are built throughout of rivetted ironwork, we may in practice lump all the members together and take $\kappa = 1.77$ throughout, so that in this case we should have $\gamma_t = .0004$ and $\gamma_c = .0005$.

The values here given will apply with tolerable accuracy to all cases within the limits above indicated, *if the girders are of ordinary proportions*; but in any particular example a more accurate calculation may be made by selecting for each set of members a special value of κ according to the character of their construction.

WEIGHT OF PARALLEL GIRDERS.

TABLES OF THE COEFFICIENT μ FOR THEORETICAL MASS OF METAL.

TABLE 1.—Parallel Girders, with Vertical Posts and Inclined Ties. Through Bridges.—Fig. 201.

Number of Panels.	Compression Members.		Tension Members.	
	Flange.	Web.	Flange.	Web.
N=3 $\left\{ \begin{array}{l} \mu \\ \mu' \\ \mu'' \end{array} \right.$	0.111 R	1.166 ÷ R	0.037 R	.074 R + .666 ÷ R
	0.111 "	0.666 "	0.037 "	.074 " + .666 "
	0.166 "	1.760 "	0.055 "	.196 " + 1.76 "
N=4 $\left\{ \begin{array}{l} \mu \\ \mu' \\ \mu'' \end{array} \right.$	0.109 R	1.50 ÷ R	0.047 R	.062 R + 1.0 ÷ R
	0.109 "	1.00 "	0.047 "	.062 " + 1.0 "
	0.164 "	2.375 "	0.070 "	.156 " + 2.5 "
N=5 $\left\{ \begin{array}{l} \mu \\ \mu' \\ \mu'' \end{array} \right.$	0.104 R	1.70 ÷ R	0.056 R	.048 R + 1.2 ÷ R
	0.104 "	1.20 "	0.056 "	.048 " + 1.2 "
	0.156 "	3.04 "	0.084 "	.128 " + 3.2 "
N=6 $\left\{ \begin{array}{l} \mu \\ \mu' \\ \mu'' \end{array} \right.$	0.102 R	2.00 ÷ R	0.06 R	.042 R + 1.5 ÷ R
	0.102 "	1.50 "	0.06 "	.042 " + 1.5 "
	0.153 "	3.61 "	0.09 "	.108 " + 3.88 "
N=7 $\left\{ \begin{array}{l} \mu \\ \mu' \\ \mu'' \end{array} \right.$	0.10 R	2.214 ÷ R	0.064 R	.036 R + 1.714 ÷ R
	0.10 "	1.714 "	0.064 "	.036 " + 1.714 "
	0.15 "	4.245 "	0.096 "	.093 " + 4.57 "
N=8 $\left\{ \begin{array}{l} \mu \\ \mu' \\ \mu'' \end{array} \right.$	0.098 R	2.50 ÷ R	0.067 R	.031 R + 2.0 ÷ R
	0.098 "	2.00 "	0.067 "	.031 " + 2.0 "
	0.147 "	4.81 "	0.100 "	.082 " + 5.25 "
N=9 $\left\{ \begin{array}{l} \mu \\ \mu' \\ \mu'' \end{array} \right.$	0.096 R	2.72 ÷ R	0.069 R	.027 R + 2.22 ÷ R
	0.096 "	2.22 "	0.069 "	.027 " + 2.22 "
	0.144 "	5.43 "	0.103 "	.073 " + 5.93 "
N=10 $\left\{ \begin{array}{l} \mu \\ \mu' \\ \mu'' \end{array} \right.$	0.095 R	3.00 ÷ R	0.070 R	.025 R + 2.50 ÷ R
	0.095 "	2.50 "	0.070 "	.025 " + 2.50 "
	0.143 "	6.00 "	0.105 "	.066 " + 6.00 "

Note.—In all cases the end pillars of the girder are included in the weight.

TABLE 1A.—*Parallel Girders, with Vertical Posts and Inclined Ties.*
Deck Bridges.—Fig. 201.

Number of Panels.	Compression Members.		Tension Members.	
	Flange.	Web.	Flange.	Web.
N=3 $\left\{ \begin{array}{l} \mu \\ \mu' \\ \mu'' \end{array} \right.$	0·111 R	1·166 ÷ R	0·037 R	·074 R + ·666 ÷ R
	0·111 "	1·666 "	0·037 "	·074 " + ·666 "
	0·166 "	3·33 "	0·055 "	·196 " + 1·76 "
N=4 $\left\{ \begin{array}{l} \mu \\ \mu' \\ \mu'' \end{array} \right.$	0·109 R	1·50 ÷ R	0·047 R	·062 R + 1·0 ÷ R
	0·109 "	2·00 "	0·047 "	·062 " + 1·0 "
	0·164 "	3·875 "	0·070 "	·156 " + 2·5 "
N=5 $\left\{ \begin{array}{l} \mu \\ \mu' \\ \mu'' \end{array} \right.$	0·104 R	1·70 ÷ R	0·056 R	·048 R + 1·2 ÷ R
	0·104 "	2·20 "	0·056 "	·048 " + 1·2 "
	0·156 "	4·56 "	0·084 "	·128 " + 3·2 "
N=6 $\left\{ \begin{array}{l} \mu \\ \mu' \\ \mu'' \end{array} \right.$	0·102 R	2·00 ÷ R	0·060 R	·042 R + 1·5 ÷ R
	0·102 "	2·50 "	0·060 "	·042 " + 1·5 "
	0·153 "	5·11 "	0·090 "	·108 " + 3·88 "
N=7 $\left\{ \begin{array}{l} \mu \\ \mu' \\ \mu'' \end{array} \right.$	0·10 R	2·214 ÷ R	0·064 R	·036 R + 1·714 ÷ R
	0·10 "	2·714 "	0·064 "	·036 " + 1·714 "
	0·15 "	5·75 "	0·096 "	·093 " + 4·57 "
N=8 $\left\{ \begin{array}{l} \mu \\ \mu' \\ \mu'' \end{array} \right.$	0·098 R	2·50 ÷ R	0·067 R	·031 R + 2·0 ÷ R
	0·098 "	3·00 "	0·067 "	·031 " + 2·0 "
	0·147 "	6·31 "	0·100 "	·082 " + 5·25 "
N=9 $\left\{ \begin{array}{l} \mu \\ \mu' \\ \mu'' \end{array} \right.$	0·096 R	2·72 ÷ R	0·069 R	·027 R + 2·22 ÷ R
	0·096 "	3·22 "	0·069 "	·027 " + 2·22 "
	0·144 "	6·94 "	0·103 "	·073 " + 5·93 "
N=10 $\left\{ \begin{array}{l} \mu \\ \mu' \\ \mu'' \end{array} \right.$	0·095 R	3·00 ÷ R	0·070 R	·025 R + 2·50 ÷ R
	0·095 "	3·50 "	0·070 "	·025 " + 2·50 "
	0·143 "	7·50 "	0·105 "	·066 " + 6·60 "

TABLE 2.—*Linville Girders, Double Bracing. Through Bridges.*
Fig. 208.

Number of Panels.	Compression Members.		Tension Members.	
	Flange.	Web.	Flange.	Web.
N=14 $\left\{ \begin{array}{l} \mu \\ \mu' \\ \mu'' \end{array} \right.$	0·100 R	2·50 ÷ R	0·067 R	0·033 R + 2·0 ÷ R
	0·100 "	2·00 "	0·067 "	0·033 " + 2·0 "
	0·150 "	4·79 "	0·100 "	0·090 " + 5·14 "
N=16 $\left\{ \begin{array}{l} \mu \\ \mu' \\ \mu'' \end{array} \right.$	0·098 R	2·75 ÷ R	0·069 R	0·029 R + 2·25 ÷ R
	0·098 "	2·25 "	0·069 "	0·029 " + 2·25 "
	0·147 "	5·375 "	0·103 "	0·079 " + 5·81 "
N=18 $\left\{ \begin{array}{l} \mu \\ \mu' \\ \mu'' \end{array} \right.$	0·096 R	3·00 ÷ R	0·070 R	·026 R + 2·5 ÷ R
	0·096 "	2·50 "	0·070 "	·026 " + 2·5 "
	0·144 "	5·96 "	0·105 "	·070 " + 6·42 "
N=20 $\left\{ \begin{array}{l} \mu \\ \mu' \\ \mu'' \end{array} \right.$	0·095 R	3·25 ÷ R	0·071 R	·024 R + 2·75 ÷ R
	0·095 "	2·75 "	0·071 "	·024 " + 2·75 "
	0·143 "	6·55 "	0·106 "	·064 " + 7·15 "

TABLE 2A.—*Linville Girders. Deck Bridges.—Fig. 208.*

Number of Panels.	Compression Members.		Tension Members.	
	Flange.	Web.	Flange.	Web.
N=14 $\left\{ \begin{array}{l} \mu \\ \mu' \\ \mu'' \end{array} \right.$	0.100 R	2.50 ÷ R	0.067 R	.033 R + 2.0 ÷ R
	0.100 "	3.00 "	0.067 "	.033 " + 2.0 "
	0.150 "	6.285 "	0.100 "	.090 " + 5.14 "
N=16 $\left\{ \begin{array}{l} \mu \\ \mu' \\ \mu'' \end{array} \right.$	0.098 R	2.75 ÷ R	0.069 R	.029 R + 2.25 ÷ R
	0.098 "	3.25 "	0.069 "	.029 " + 2.25 "
	0.147 "	6.875 "	0.103 "	.079 " + 5.81 "
N=18 $\left\{ \begin{array}{l} \mu \\ \mu' \\ \mu'' \end{array} \right.$	0.096 R	3.00 ÷ R	0.070 R	.026 R + 2.5 ÷ R
	0.096 "	3.50 "	0.070 "	.026 " + 2.5 "
	0.144 "	7.46 "	0.105 "	.070 " + 6.42 "
N=20 $\left\{ \begin{array}{l} \mu \\ \mu' \\ \mu'' \end{array} \right.$	0.095 R	3.25 ÷ R	0.071 R	.024 R + 2.75 ÷ R
	0.095 "	3.75 "	0.071 "	.024 " + 2.75 "
	0.143 "	8.05 "	0.106 "	.064 " + 7.15 "

TABLE 3.—*Linville Girders, with Inclined Terminal Struts. Through Bridges.—Fig. 213.*

Number of Panels.	Compression Members.		Tension Members.	
	Flange.	Web.	Flange.	Web.
N=14 $\left\{ \begin{array}{l} \mu \\ \mu' \\ \mu'' \end{array} \right.$.0926 R	.0047 R + 2.036 ÷ R	.0732 R	.024 R + 1.57 ÷ R
	.0926 "	.0047 " + 1.643 "	.0732 "	.024 " + 1.643 "
	.139 "	.0094 " + 4.06 "	.110 "	.071 " + 4.4 "
N=16 $\left\{ \begin{array}{l} \mu \\ \mu' \\ \mu'' \end{array} \right.$.0923 R	.0037 R + 2.28 ÷ R	.0737 R	.022 R + 1.81 ÷ R
	.0923 "	.0037 " + 1.875 "	.0737 "	.022 " + 1.87 "
	.1384 "	.0073 " + 4.61 "	.1106 "	.065 " + 5.0 "
N=18 $\left\{ \begin{array}{l} \mu \\ \mu' \\ \mu'' \end{array} \right.$.092 R	.003 R + 2.53 ÷ R	.074 R	.021 R + 2.05 ÷ R
	.092 "	.003 " + 2.11 "	.074 "	.021 " + 2.11 "
	.138 "	.006 " + 5.17 "	.111 "	.059 " + 5.62 "
N=20 $\left\{ \begin{array}{l} \mu \\ \mu' \\ \mu'' \end{array} \right.$.0915 R	.0025 R + 2.77 ÷ R	.075 R	.019 R + 2.30 ÷ R
	.0915 "	.0025 " + 2.35 "	.075 "	.019 " + 2.35 "
	.1372 "	.0048 " + 5.74 "	.112 "	.055 " + 6.3 "

TABLE 4.—*Warren Girder, with Vertical Ties. Through Bridge.—*
Fig. 203.

Number of Panels in Lower Flange.	Compression Members.		Tension Members.		
	Flange.	Web.	Flange.	Web.	
N = 8	μ	·078 R	·020 R + 1·437 ÷ R	·086 R	·012 R + 1·125 ÷ R
	μ'	·078 "	·020 " + 1·25 "	·086 "	·012 " + 1·250 "
	μ''	·117 "	·043 " + 2·78 "	·129 "	·034 " + 3·156 "
N = 10	μ	·080 R	·015 R + 1·70 ÷ R	·085 R	·010 R + 1·25 ÷ R
	μ'	·080 "	·015 " + 1·50 "	·085 "	·010 " + 1·50 "
	μ''	·120 "	·038 " + 3·78 "	·127 "	·024 " + 3·42 "
N = 12	μ	·081 R	·012 R + 2·00 ÷ R	·0845 R	·009 R + 1·50 ÷ R
	μ'	·081 "	·012 " + 1·75 "	·0845 "	·009 " + 1·75 "
	μ''	·122 "	·028 " + 4·04 "	·1267 "	·024 " + 4·42 "
N = 14	μ	·0816 R	·010 R + 2·21 ÷ R	·0842 R	·008 R + 1·75 ÷ R
	μ'	·0816 "	·010 " + 2·00 "	·0842 "	·008 " + 2·0 "
	μ''	·1224 "	·025 " + 5·04 "	·1263 "	·019 " + 4·67 "
N = 16	μ	·082 R	·009 R + 2·47 ÷ R	·084 R	·007 R + 2·00 ÷ R
	μ'	·082 "	·009 " + 2·25 "	·084 "	·007 " + 2·25 "
	μ''	·123 "	·021 " + 5·30 "	·126 "	·018 " + 5·67 "
N = 20	μ	·0825 R	·007 R + 2·97 ÷ R	·0838 R	·006 R + 2·50 ÷ R
	μ'	·0825 "	·007 " + 2·75 "	·0838 "	·006 " + 2·75 "
	μ''	·1238 "	·016 " + 6·55 "	·1257 "	·015 " + 6·92 "

TABLE 4A.—*Warren Girder, with Vertical Struts. Deck Bridge.*
Fig. 203A.

Number of Panels in Upper Flange.	Compression Members.		Tension Members.		
	Flange.	Web.	Flange.	Web.	
N = 8	μ	·086 R	·012 R + 2·00 ÷ R	·078 R	·020 R + 1·437 ÷ R
	μ'	·086 "	·012 " + 2·25 "	·078 "	·020 " + 1·25 "
	μ''	·129 "	·034 " + 5·156 "	·117 "	·043 " + 2·78 "
N = 10	μ	·085 R	·010 R + 2·25 ÷ R	·080 R	·015 R + 1·70 ÷ R
	μ'	·085 "	·010 " + 2·50 "	·080 "	·015 " + 1·50 "
	μ''	·127 "	·024 " + 5·42 "	·120 "	·038 " + 3·78 "
N = 12	μ	·0845 R	·009 R + 2·50 ÷ R	·081 R	·012 R + 2·00 ÷ R
	μ'	·0845 "	·009 " + 2·75 "	·081 "	·012 " + 1·75 "
	μ''	·1267 "	·024 " + 6·42 "	·122 "	·028 " + 4·04 "
N = 14	μ	·0842 R	·008 R + 2·75 ÷ R	·0816 R	·010 R + 2·21 ÷ R
	μ'	·0842 "	·008 " + 3·0 "	·0816 "	·010 " + 2·00 "
	μ''	·1263 "	·019 " + 6·67 "	·1224 "	·025 " + 5·04 "
N = 16	μ	·084 R	·007 R + 3·00 ÷ R	·082 R	·009 R + 2·47 ÷ R
	μ'	·084 "	·007 " + 3·25 "	·082 "	·009 " + 2·25 "
	μ''	·126 "	·018 " + 7·67 "	·123 "	·021 " + 5·30 "
N = 20	μ	·0838 R	·006 R + 3·50 ÷ R	·0825 R	·007 R + 2·97 ÷ R
	μ'	·0838 "	·006 " + 3·75 "	·0825 "	·007 " + 2·75 "
	μ''	·1257 "	·015 " + 8·92 "	·1238 "	·016 " + 6·55 "

Note.—In this table it is assumed that the lower chord is supported by vertical suspenders, and that the whole weight of the girder and its load is carried by the two end pillars.

TABLE 5.—*Warren Girder. Through Bridges.—Fig. 204 without Verticals.*

Number of Panels in Lower Flange.	Compression Members.		Tension Members.	
	Flange.	Web.	Flange.	Web.
N = 4 $\left\{ \begin{array}{l} \mu' \\ \mu'' \end{array} \right.$	·078 R	·020 R + 1·25 ÷ R	·086 R	·012 R + 0·75 ÷ R
	·078 "	·016 " + 1·0 "	·078 "	·016 " + 1·0 "
	·117 "	·037 " + 2·375 "	·117 "	·037 " + 2·375 "
N = 5 $\left\{ \begin{array}{l} \mu' \\ \mu'' \end{array} \right.$	·080 R	·015 R + 1·50 ÷ R	·085 R	·010 R + 1·0 ÷ R
	·080 "	·012 " + 1·2 "	·080 "	·012 " + 1·2 "
	·120 "	·034 " + 3·36 "	·120 "	·026 " + 2·64 "
N = 6 $\left\{ \begin{array}{l} \mu' \\ \mu'' \end{array} \right.$	·081 R	·012 R + 1·75 ÷ R	·0845 R	·009 R + 1·25 ÷ R
	·081 "	·010 " + 1·50 "	·081 "	·010 " + 1·50 "
	·122 "	·026 " + 3·67 "	·122 "	·026 " + 3·67 "
N = 7 $\left\{ \begin{array}{l} \mu' \\ \mu'' \end{array} \right.$	·0816 R	·010 R + 2·0 ÷ R	·0842 R	·008 R + 1·50 ÷ R
	·0816 "	·009 " + 1·714 "	·0816 "	·009 " + 1·714 "
	·1224 "	·024 " + 4·65 "	·1224 "	·020 " + 3·92 "
N = 8 $\left\{ \begin{array}{l} \mu' \\ \mu'' \end{array} \right.$	·082 R	·009 R + 2·25 ÷ R	·084 R	·007 R + 1·75 ÷ R
	·082 "	·008 " + 2·0 "	·082 "	·008 " + 2·0 "
	·123 "	·019 " + 4·94 "	·123 "	·019 " + 4·94 "
N = 10 $\left\{ \begin{array}{l} \mu' \\ \mu'' \end{array} \right.$	·0825 R	·007 R + 2·75 ÷ R	·0838 R	·006 R + 2·25 ÷ R
	·0825 "	·006 " + 2·50 "	·0825 "	·006 " + 2·50 "
	·1232 "	·015 " + 6·20 "	·1232 "	·015 " + 6·20 "

TABLE 5A.—*Warren Girder. Deck Bridges.—Fig. 204.*

Number of Panels in Upper Flange.	Compression Members.		Tension Members.	
	Flange.	Web.	Flange.	Web.
N = 4 $\left\{ \begin{array}{l} \mu' \\ \mu'' \end{array} \right.$	·086 R	·012 R + 1·75 ÷ R	·078 R	·020 R + 1·25 + R
	·078 "	·016 " + 2·0 "	·078 "	·016 " + 1·0 "
	·117 "	·037 " + 4·375 "	·117 "	·037 " + 2·375 "
N = 5 $\left\{ \begin{array}{l} \mu' \\ \mu'' \end{array} \right.$	·085 R	·010 R + 2·0 ÷ R	·080 R	·015 R + 1·5 ÷ R
	·080 "	·012 " + 2·2 "	·080 "	·012 " + 1·2 "
	·120 "	·034 " + 5·36 "	·120 "	·026 " + 2·64 "
N = 6 $\left\{ \begin{array}{l} \mu' \\ \mu'' \end{array} \right.$	·0845 R	·009 R + 2·25 ÷ R	·081 R	·012 R + 1·75 ÷ R
	·081 "	·010 " + 2·50 "	·081 "	·010 " + 1·5 "
	·122 "	·026 " + 5·67 "	·122 "	·026 " + 3·67 "
N = 7 $\left\{ \begin{array}{l} \mu' \\ \mu'' \end{array} \right.$	·0842 R	·008 R + 2·50 ÷ R	·0816 R	·010 R + 2·0 ÷ R
	·0816 "	·009 " + 2·714 "	·0816 "	·009 R + 1·714 "
	·1224 "	·024 " + 6·65 "	·1224 "	·020 " + 3·92 "
N = 8 $\left\{ \begin{array}{l} \mu' \\ \mu'' \end{array} \right.$	·084 R	·007 R + 2·75 ÷ R	·082 R	·009 R + 2·25 ÷ R
	·082 "	·008 " + 3·00 "	·082 "	·008 " + 2·0 "
	·123 "	·019 " + 6·94 "	·123 "	·019 " + 4·94 "
N = 10 $\left\{ \begin{array}{l} \mu' \\ \mu'' \end{array} \right.$	·0838 R	·006 R + 3·25 ÷ R	·0825 R	·007 R + 2·75 ÷ R
	·0825 "	·006 " + 3·50 "	·0825 "	·006 " + 2·50 "
	·1232 "	·015 " + 8·20 "	·1232 "	·015 " + 6·20 "

TABLE 6.—*Single Lattice Girder. Through Bridges.—Fig. 206.*

Number of Panels.	Compression Members.		Tension Members.	
	Flange.	Web.	Flange.	Web.
$N=6 \begin{cases} \mu \\ \mu' \\ \mu'' \end{cases}$.081 <i>R</i> .088 ,, .132 ,,	.021 <i>R</i> +1.25÷ <i>R</i> .014 ,,+1.0 ,, .042 ,,+2.5 ,,	.081 <i>R</i> .074 ,, .111 ,,	.021 <i>R</i> +0.75÷ <i>R</i> .028 ,,+1.0 ,, .060 ,,+2.17 ,,
$N=8 \begin{cases} \mu \\ \mu' \\ \mu'' \end{cases}$.082 <i>R</i> .086 ,, .129 ,,	.016 <i>R</i> +1.50÷ <i>R</i> .012 ,,+1.25 ,, .034 ,,+3.156 ,,	.082 <i>R</i> .078 ,, .117 ,,	.016 <i>R</i> +1.0÷ <i>R</i> .020 ,,+1.25 ,, .043 ,,+2.78 ,,
$N=10 \begin{cases} \mu \\ \mu' \\ \mu'' \end{cases}$.0825 <i>R</i> .085 ,, .127 ,,	.0125 <i>R</i> +1.75÷ <i>R</i> .010 ,,+1.50 ,, .028 ,,+3.78 ,,	.0825 <i>R</i> .080 ,, .120 ,,	.0125 <i>R</i> +1.25÷ <i>R</i> .015 ,,+1.50 ,, .034 ,,+3.42 ,,
$N=12 \begin{cases} \mu \\ \mu' \\ \mu'' \end{cases}$.0827 <i>R</i> .0845 ,, .1267 ,,	.0104 <i>R</i> +2.00÷ <i>R</i> .009 ,,+1.75 ,, .024 ,,+4.42 ,,	.0827 <i>R</i> .081 ,, .122 ,,	.0104 <i>R</i> +1.50÷ <i>R</i> .012 ,,+1.75 ,, .028 ,,+4.04 ,,
$N=14 \begin{cases} \mu \\ \mu' \\ \mu'' \end{cases}$.0829 <i>R</i> .0842 ,, .1263 ,,	.009 <i>R</i> +2.25÷ <i>R</i> .008 ,,+2.0 ,, .021 ,,+5.04 ,,	.0829 <i>R</i> .0816 ,, .1224 ,,	.009 <i>R</i> +1.75÷ <i>R</i> .010 ,,+2.0 ,, .024 ,,+4.67 ,,
$N=16 \begin{cases} \mu \\ \mu' \\ \mu'' \end{cases}$.083 <i>R</i> .084 ,, .126 ,,	.008 <i>R</i> +2.50÷ <i>R</i> .007 ,,+2.25 ,, .018 ,,+5.67 ,,	.083 <i>R</i> .082 ,, .123 ,,	.008 <i>R</i> +2.00÷ <i>R</i> .009 ,,+2.25 ,, .021 ,,+5.30 ,,

TABLE 6A.—*Single Lattice Girder. Deck Bridges.—Fig. 206.*

Number of Panels.	Compression Members.		Tension Members.	
	Flange.	Web.	Flange.	Web.
$N=6 \begin{cases} \mu \\ \mu' \\ \mu'' \end{cases}$.081 <i>R</i> .074 ,, .111 ,,	.021 <i>R</i> +1.25÷ <i>R</i> .028 ,,+1.50 ,, .060 ,,+3.167 ,,	.081 <i>R</i> .088 ,, .132 ,,	.021 <i>R</i> +0.75÷ <i>R</i> .014 ,,+0.50 ,, .042 ,,+1.50 ,,
$N=8 \begin{cases} \mu \\ \mu' \\ \mu'' \end{cases}$.082 <i>R</i> .078 ,, .117 ,,	.016 <i>R</i> +1.50÷ <i>R</i> .020 ,,+1.75 ,, .043 ,,+3.78 ,,	.082 <i>R</i> .086 ,, .129 ,,	.016 <i>R</i> +1.0÷ <i>R</i> .012 ,,+0.75 ,, .034 ,,+2.156 ,,
$N=10 \begin{cases} \mu \\ \mu' \\ \mu'' \end{cases}$.0825 <i>R</i> .080 ,, .120 ,,	.0125 <i>R</i> +1.75÷ <i>R</i> .015 ,,+2.00 ,, .034 ,,+4.42 ,,	.0825 <i>R</i> .085 ,, .127 ,,	.0125 <i>R</i> +1.25÷ <i>R</i> .010 ,,+1.0 ,, .028 ,,+2.78 ,,
$N=12 \begin{cases} \mu \\ \mu' \\ \mu'' \end{cases}$.0827 <i>R</i> .081 ,, .122 ,,	.0104 <i>R</i> +2.00÷ <i>R</i> .012 ,,+2.25 ,, .028 ,,+5.04 ,,	.0827 <i>R</i> .0845 ,, .1267 ,,	.0104 <i>R</i> +1.50÷ <i>R</i> .009 ,,+1.25 ,, .024 ,,+3.42 ,,
$N=14 \begin{cases} \mu \\ \mu' \\ \mu'' \end{cases}$.0829 <i>R</i> .0816 ,, .1224 ,,	.009 <i>R</i> +2.25÷ <i>R</i> .010 ,,+2.50 ,, .024 ,,+5.67 ,,	.0829 <i>R</i> .0842 ,, .1263 ,,	.009 <i>R</i> +1.75÷ <i>R</i> .008 ,,+1.50 ,, .021 ,,+4.04 ,,
$N=16 \begin{cases} \mu \\ \mu' \\ \mu'' \end{cases}$.083 <i>R</i> .082 ,, .123 ,,	.008 <i>R</i> +2.50÷ <i>R</i> .009 ,,+2.75 ,, .021 ,,+6.30 ,,	.083 <i>R</i> .084 ,, .126 ,,	.008 <i>R</i> +2.00÷ <i>R</i> .007 ,,+1.75 ,, .018 ,,+4.67 ,,

TABLE 7.—*Single Lattice Girder, with Vertical Ties. Through Bridges.*
Fig. 207.

Number of Panels.	Compression Members.		Tension Members.	
	Flange.	Web.	Flange.	Web.
$N=6 \begin{cases} \mu \\ \mu' \\ \mu'' \end{cases}$.081 R .081 ,, .122 ,,	.021 R + 1.25 ÷ R .021 ,, + 1.17 ,, .051 ,, + 2.67 ,,	.081 R .081 ,, .122 ,,	.021 R + 0.75 ÷ R .021 ,, + 1.17 ,, .051 ,, + 2.67 ,,
$N=8 \begin{cases} \mu \\ \mu' \\ \mu'' \end{cases}$.082 R .082 ,, .123 ,,	.016 R + 1.50 ÷ R .016 ,, + 1.44 ,, .039 ,, + 3.35 ,,	.082 R .082 ,, .123 ,,	.016 R + 1.0 ÷ R .016 ,, + 1.44 ,, .039 ,, + 3.35 ,,
$N=10 \begin{cases} \mu \\ \mu' \\ \mu'' \end{cases}$.0825 R .0825 ,, .1237 ,,	.0125 R + 1.75 ÷ R .0125 ,, + 1.70 ,, .0310 ,, + 4.00 ,,	.0825 R .0825 ,, .1237 ,,	.0125 R + 1.25 ÷ R .0125 ,, + 1.70 ,, .0310 ,, + 4.00 ,,
$N=12 \begin{cases} \mu \\ \mu' \\ \mu'' \end{cases}$.0827 R .0827 ,, .124 ,,	.0104 ,, + 2.00 ÷ R .0104 ,, + 1.96 ,, .0259 ,, + 4.65 ,,	.0827 R .0827 ,, .124 ,,	.0104 R + 1.50 ÷ R .0104 ,, + 1.96 ,, .0259 ,, + 4.65 ,,
$N=14 \begin{cases} \mu \\ \mu' \\ \mu'' \end{cases}$.0829 R .0829 ,, .1243 ,,	.009 R + 2.25 ÷ R .009 ,, + 2.21 ,, .022 ,, + 5.29 ,,	.0829 R .0829 ,, .1243 ,,	.009 R + 1.75 ÷ R .009 ,, + 2.21 ,, .022 ,, + 5.29 ,,
$N=16 \begin{cases} \mu \\ \mu' \\ \mu'' \end{cases}$.083 R .083 ,, .1245 ,,	.008 R + 2.50 ÷ R .008 ,, + 2.47 ,, .0196 ,, + 5.94 ,,	.083 R .083 ,, .1245 ,,	.008 R + 2.0 ÷ R .008 ,, + 2.47 ,, .0196 ,, + 5.94 ,,

In this table it is assumed that the floor is attached to the lower flange, and that one half of its weight is effectually transmitted to the upper joints by the vertical ties; but nothing is added for vertical stiffening.

TABLE 7A.—*Single Lattice with Vertical Struts. Deck Bridges.*
Fig. 207.

Number of Panels.	Compression Members.		Tension Members.	
	Flange.	Web.	Flange.	Web.
$N=6 \begin{cases} \mu \\ \mu' \\ \mu'' \end{cases}$.081 R .081 ,, .122 ,,	.021 R + 1.25 ÷ R .021 ,, + 1.75 ,, .051 ,, + 3.833 ,,	.081 R .081 ,, .122 ,,	.021 R + 0.75 ÷ R .021 ,, + 0.75 ,, .051 ,, + 1.833 ,,
$N=8 \begin{cases} \mu \\ \mu' \\ \mu'' \end{cases}$.082 R .082 ,, .123 ,,	.016 R + 1.50 ÷ R .016 ,, + 2.00 ,, .039 ,, + 4.47 ,,	.082 R .082 ,, .123 ,,	.016 R + 1.00 ÷ R .016 ,, + 1.00 ,, .039 ,, + 2.47 ,,
$N=10 \begin{cases} \mu \\ \mu' \\ \mu'' \end{cases}$.0825 R .0825 ,, .1237 ,,	.0125 R + 1.75 ÷ R .0125 ,, + 2.25 ,, .0310 ,, + 5.10 ,,	.0825 R .0825 ,, .1237 ,,	.0125 R + 1.25 ÷ R .0125 ,, + 1.25 ,, .0310 ,, + 3.10 ,,
$N=12 \begin{cases} \mu \\ \mu' \\ \mu'' \end{cases}$.0827 R .0827 ,, .124 ,,	.0104 R + 2.00 ÷ R .0104 ,, + 2.50 ,, .0259 ,, + 5.73 ,,	.0827 R .0827 ,, .124 ,,	.0104 R + 1.50 ÷ R .0104 ,, + 1.50 ,, .0259 ,, + 3.73 ,,
$N=14 \begin{cases} \mu \\ \mu' \\ \mu'' \end{cases}$.0829 R .0829 ,, .1243 ,,	.009 R + 2.25 ÷ R .009 ,, + 2.75 ,, .022 ,, + 6.36 ,,	.0829 R .0829 ,, .1243 ,,	.009 R + 1.75 ÷ R .009 ,, + 1.75 ,, .022 ,, + 4.36 ,,
$N=16 \begin{cases} \mu \\ \mu' \\ \mu'' \end{cases}$.083 R .083 ,, .1245 ,,	.008 R + 2.50 ÷ R .008 ,, + 3.00 ,, .0196 ,, + 7.00 ,,	.083 R .083 ,, .1245 ,,	.008 R + 2.0 ÷ R .008 ,, + 2.0 ,, .0196 ,, + 5.0 ,,

In the preceding table it is assumed that the floor is carried upon the upper flange, and that one half of its weight is effectually transmitted to the lower joints by the vertical struts ; but nothing is added for vertical stiffening.

TABLE 8.—*Double Lattice Girders, with Vertical Ties.—Through Bridges.*
Fig. 211.

Number of Panels.	Compression Members.		Tension Members.	
	Flange.	Web.	Flange.	Web.
N=12 $\left\{ \begin{array}{l} \mu \\ \mu' \\ \mu'' \end{array} \right.$	·0827 R	·021 R+1·25 ÷ R	·0827 R	·021 R+0·75 ÷ R
	·0827 ,,	·021 ,, +1·21 ,,	·0827 ,,	·021 ,, +1·21 ,,
	·124 ,,	·051 ,, +2·75 ,,	·124 ,,	·051 ,, +2·75 ,,
N=16 $\left\{ \begin{array}{l} \mu \\ \mu' \\ \mu'' \end{array} \right.$	·083 R	·016 R+1·50 ÷ R	·083 R	·016 R+1·0 ÷ R
	·083 ,,	·016 ,, +1·47 ,,	·083 ,,	·016 ,, +1·47 ,,
	·1245 ,,	·039 ,, +3·41 ,,	·1245 ,,	·039 ,, +3·41 ,,
N=20 $\left\{ \begin{array}{l} \mu \\ \mu' \\ \mu'' \end{array} \right.$	·083 R	·0125 R+1·75 ÷ R	·083 R	·0125 R+1·25 ÷ R
	·083 ,,	·0125 ,, +1·73 ,,	·083 ,,	·0125 ,, +1·73 ,,
	·125 ,,	·0310 ,, +4·05 ,,	·125 ,,	·0310 ,, +4·05 ,,
N=24 $\left\{ \begin{array}{l} \mu \\ \mu' \\ \mu'' \end{array} \right.$	·0833 R	·0104 R+2·00 ÷ R	·0833 R	·0104 R+1·50 ÷ R
	·0833 ,,	·0104 ,, +1·98 ,,	·0833 ,,	·0104 ,, +1·98 ,,
	·125 ,,	·0259 ,, +4·69 ,,	·125 ,,	·0259 ,, +4·69 ,,
N=28 $\left\{ \begin{array}{l} \mu \\ \mu' \\ \mu'' \end{array} \right.$	·0833 R	·009 R+2·25 ÷ R	·0833 R	·009 R+1·75 ÷ R
	·0833 ,,	·009 ,, +2·23 ,,	·0833 ,,	·009 ,, +2·23 ,,
	·125 ,,	·022 ,, +5·33 ,,	·125 ,,	·022 ,, +5·33 ,,
N=32 $\left\{ \begin{array}{l} \mu \\ \mu' \\ \mu'' \end{array} \right.$	·0833 R	·008 R+2·50 ÷ R	·0833 R	·008 R+2·0 ÷ R
	·0833 ,,	·008 ,, +2·49 ,,	·0833 ,,	·008 ,, +2·49 ,,
	·125 ,,	·0196 ,, +5·98 ,,	·125 ,,	·0196 ,, +5·98 ,,

It is here assumed that the vertical ties are sufficiently numerous and effective to transfer one half of the suspended load to the upper joints throughout ; but nothing is added for vertical stiffeners.

TABLE 8A.—*Double Lattice Girders, with Vertical Struts. Deck Bridges. Fig. 211.*

Number of Panels.	Compression Members.		Tension Members.	
	Flange.	Web.	Flange.	Web.
N=12 $\left\{ \begin{array}{l} \mu' \\ \mu'' \end{array} \right.$	·0827 R	·021 R+1·25 ÷ R	·0827 R	·021 R+0·75 ÷ R
	·0827 ,,	·021 ,, +1·75 ,,	·0827 ,,	·021 ,, +0·75 ,,
	·124 ,,	·051 ,, +3·833 ,,	·124 ,,	·051 ,, +1·833 ,,
N=16 $\left\{ \begin{array}{l} \mu' \\ \mu'' \end{array} \right.$	·083 R	·016 R+1·50 ÷ R	·083 R	·016 R+1·0 ÷ R
	·083 ,,	·016 ,, +2·00 ,,	·083 ,,	·016 ,, +1·0 ,,
	·1245 ,,	·039 ,, +4·47 ,,	·1245 ,,	·039 ,, +2·47 ,,
N=20 $\left\{ \begin{array}{l} \mu' \\ \mu'' \end{array} \right.$	·083 R	·0125 R+1·75 ÷ R	·083 R	·0125 R+1·25 ÷ R
	·083 ,,	·0125 ,, +2·25 ,,	·083 ,,	·0125 ,, +1·25 ,,
	·125 ,,	·0310 ,, +5·10 ,,	·125 ,,	·0310 ,, +3·10 ,,
N=24 $\left\{ \begin{array}{l} \mu' \\ \mu'' \end{array} \right.$	·0833 R	·0104 R+2·00 ÷ R	·083 R	·0104 R+1·50 ÷ R
	·0833 ,,	·0104 ,, +2·50 ,,	·083 ,,	·0104 ,, +1·50 ,,
	·125 ,,	·0259 ,, +5·73 ,,	·125 ,,	·0259 ,, +3·73 ,,
N=28 $\left\{ \begin{array}{l} \mu' \\ \mu'' \end{array} \right.$	·0833 R	·009 R+2·25 ÷ R	·0833 R	·009 R+1·75 ÷ R
	·0833 ,,	·009 ,, +2·75 ,,	·0833 ,,	·009 ,, +1·75 ,,
	·125 ,,	·022 ,, +6·36 ,,	·125 ,,	·022 ,, +4·36 ,,
N=32 $\left\{ \begin{array}{l} \mu' \\ \mu'' \end{array} \right.$	·0833 R	·008 R+2·50 ÷ R	·0833 R	·008 R+2·00 ÷ R
	·0833 ,,	·008 ,, +3·00 ,,	·0833 ,,	·008 ,, +2·00 ,,
	·125 ,,	·0196 ,, +7·00 ,,	·125 ,,	·0196 ,, +5·00 ,,

It is here assumed that the vertical struts are sufficiently numerous and effective to transfer one half of the deck load to the lower joints; but nothing is added for vertical stiffeners.

209. Examples of the Weight of Parallel Girders.—To illustrate the calculation of weights, as required in the ordinary practice of designing bridge work, we may take two or three different types of construction, selecting such dimensions as will correspond with some existing examples of English, Continental, and American practice, so that we can compare the calculated weight with the actual weights of those structures.

1st Example.—A double line railway bridge, with two main girders of the type shown in Fig. 208, has to be constructed across a clear span of 187 feet, giving an effective span $L=193$ feet between the points of support. The ratio of length to depth is $R=8$, and the girders will be united by overhead wind-bracing, the roadway being carried upon the lower flanges.

The weight of the roadway and wind-bracing is ascertained to be $p=0·75$ tons per foot, while the live load for this span will be $1·125$ tons per foot for each line, or $q=2·25$. But we now require to find the weight of the main girders before we can proceed to calculate the stresses.

Suppose that the girder is to be constructed of rivetted plate and angles throughout, and upon the outline shown in Fig. 208. Then we may take for all compression members $\gamma_c = \cdot 0005$, and for all tension members $\gamma_t = \cdot 0004$; and adding together the values given for web and flanges in Table 2 ($N = 16$), we get—

	Compression Members.	Tension Members.
$\mu =$	1·125	1·065
$\mu' =$	1·065	1·065
$\mu'' =$	1·848	2·182

Therefore, multiplying by γ_c and γ_t , we have—

$$\begin{aligned} \Sigma\gamma\mu &= \cdot 000988 \\ p\Sigma\gamma\mu' &= \cdot 000958 \times 0\cdot 75 = \cdot 000718 \\ q\Sigma\gamma\mu'' &= \cdot 001797 \times 2\cdot 25 = \cdot 004043 \\ &\hline &= \cdot 004761 \end{aligned}$$

The weight of the main girders per foot lineal will therefore be $w = \frac{L(p\Sigma\gamma\mu' + q\Sigma\gamma\mu'')}{1 - L\Sigma\gamma\mu} = \frac{193 \times \cdot 004761}{1 - (193 \times \cdot 000988)} = \frac{919}{809} = 1\cdot 13$ tons.

In this example, the dimensions, load, and character of construction correspond exactly with those of the 187 feet spans of the Kuilemburg viaduct; and in that bridge the actual weight of the main girders is 1·13 tons per foot of effective span, or 1·09 tons per foot of total length.

2d Example.—We may next take a bridge whose dimensions correspond with the 263 feet spans of the same viaduct, the effective span of the girders between the points of support being $L = 275$ feet, while the ratio of span to depth is $R = 10$. In the Kuilemburg bridge the number of panels appears to be 21, but we may take the values given in Table 2 for $N = 20$, as this variation would not appreciably affect the final result. The weight p is the same as before, and the rolling load being $q = 2\cdot 0$, we shall then have—

$$\begin{aligned} \Sigma\gamma\mu &= \cdot 001128 \\ p\Sigma\gamma\mu' &= \cdot 001103 \times 0\cdot 75 = \cdot 000827 \\ q\Sigma\gamma\mu'' &= \cdot 002009 \times 2\cdot 0 = \cdot 004018 \\ &\hline &= \cdot 004845 \end{aligned}$$

Therefore $w = \frac{275 \times \cdot 004845}{1 - (275 \times \cdot 001128)} = \frac{1\cdot 3324}{0\cdot 69} = 1\cdot 93$ tons per foot.

The actual weight of the Kuilemburg girders is 1·97 tons per foot of span, or 1·92 tons per foot of their total length.

3d Example.—To compare the formula with good English practice, we may select the case of the Charing Cross railway bridge, in which the span is $L = 154$ feet, while the depth of girder measured between the centres of gravity of the flanges is $\frac{1}{2}$ th of that quantity. The main

girders are of the type shown in Fig. 207, but with 14 panels, so that we shall take $R=12$ and $N=14$.

The two main girders carry four lines of railway, the cross-girders being attached to the lower flange, while a projecting footway is carried on one side of the bridge outside the main girder. The weight of the platform, permanent way, and footway is $p=1.50$ tons per foot, and the bridge is calculated for a rolling load of $1\frac{1}{4}$ tons per foot on each line, so that $q=4 \times 1\frac{1}{4}=5$ tons per foot for the railway, to which we have to add 0.63 tons for the live load of the footway. The flanges are built of rivetted plate and angles, and form in this shallow girder the chief portion of the weight. The diagonals and verticals are each composed of a pair of bars with swelled heads and pin connections; but the verticals are used as stiffeners, and, like the diagonal struts, are braced together transversely with secondary bracing, and therefore we shall not much over-estimate the weight if we apply to the whole girder the same values of γ_c and γ_t as we have used in rivetted girders.

Then referring to Table 7 ($N=14$) and using the above value of R , we obtain

$$\begin{aligned} \Sigma\gamma\mu &= .001145 \\ p\Sigma\gamma\mu' &= .001160 \times 1.5 = .00174 \\ q\Sigma\gamma\mu'' &= .001980 \times 5.63 = .01115 \\ & \underline{\hspace{10em}} \\ & .01289 \end{aligned}$$

Therefore $w = \frac{154 \times .01289}{1 - (154 \times .001145)} = \frac{1.985}{.824} = 2.41$ tons per foot.

The actual weight of the Charing Cross girders is 380 tons, or 2.47 tons per foot of span, or 2.31 tons per foot of their total length.

The weight of each pair of girders is made up as follows—

	Tons.	Cwts.	
Top flange . . .	140	9	$\kappa = 1.70$
Bottom flange . . .	135	11	$\kappa = 2.00$
Web and pillars . . .	104	0	$\kappa = 1.71$ for struts and ties together.
	<hr style="width: 20%; margin: 0 auto;"/>		
	380	0	

These detailed quantities afford an example of the percentage of waste material, as set forth in the above values of κ , which include the overlap of the flanges beyond the points of support at each end of the girder, as part of the waste material. It will be observed that altogether the waste is greater in these horizontal members than in the members of the web; and the same remark applies also to the Kuilemburg girders.

4th Example.—We will now apply the formula to a bridge of 515 feet span, which we will suppose to be designed upon American principles; and we can then compare the result with the weight of the Linville truss which crosses the Ohio with a span of 515 feet.

The web-bracing consists of vertical posts of box-section, and diagonal ties and counterbraces inclined at 45°, the outline of the girder being exactly as represented in Fig. 213.

The bridge carries a single line of railway, and the live load for which the girders have been calculated is $q = 0.8$ tons per foot; while the ascertained weight of the platform and lateral and transverse wind-bracing is $p = 0.55$ tons per foot.

The number of panels is 20, and the ratio of span to depth is $R = 10$, therefore referring to Table 3, for $N = 20$, we get

	Compression Members.	Tension Members.
$\mu =$. . . 1.217	1.170
$\mu' =$. . . 1.175	1.175
$\mu'' =$. . . 1.994	2.300

But for the coefficient γ we must here adopt the values which properly apply to each class of detailed construction. In the Ohio bridge, the lower chord and all the tension members are formed of eye-bars with swelled heads, and pin connections; and in this class of work the waste material would not be more than 20 to 25 per cent. if the links were strung closely together as in the chain of a suspension bridge; while the extra weight of the connections required for adapting the joints to girder construction will only increase the waste to about 33 per cent. (including the pins).

The compression members in this girder are of course rivetted structures, but the loss of metal will be less than in a rivetted tension flange, and on the whole will not exceed 70 per cent.

We shall therefore take for all compression members $\kappa = 1.70$ and $\gamma_c = .00048$; and for all tension members $\kappa = 1.33$ and $\gamma_t = .0003$, in accordance with the values already given.

$$\begin{aligned} \text{Then } \Sigma\gamma\mu &= .000935 \\ p\Sigma\gamma\mu' &= .0009165 \times .55 = 000504 \\ q\Sigma\gamma\mu'' &= .0016471 \times .80 = 001318 \\ &\hline &= .001822 \end{aligned}$$

$$\text{Therefore } w = \frac{515 \times .001822}{1 - (515 \times .000935)} = \frac{.938}{.518} = 1.80 \text{ tons per foot.}$$

The actual weight of the main girders in the Ohio bridge is 1.79 tons per foot.

This is the longest span that has yet been crossed by any parallel girder; and notwithstanding the economical character of the details, the weight of the main girders bears so large a proportion to the load they have to carry, that we may regard a span of 515 feet as approaching pretty nearly to the maximum for wrought iron girder bridges of this class.

In each one of the foregoing examples, the weight given by the

formula agrees very closely with the actual weight of the girders, and is sufficiently accurate to be taken at once as the basis for the final calculation of the stresses in each member.

The same method will evidently be applicable to girders of all proportions if a suitable value of κ is taken. In double-line bridges of any *ordinary* proportions the coefficient κ will represent very little more than the unavoidable waste of construction in the details. But in compression members the coefficient κ must be taken at a somewhat higher value whenever the compression members of the web are used as stiffeners, or when independent vertical stiffeners are required, and also whenever the ratio of load to length of strut is less than in the examples above given. This will generally be the case in single-line bridges of small span; and it will also be the case in many close lattice girders, and in all girders whose depth is extravagantly great in proportion to their span.

But however great may be the height of the web-pillars, in very large girders, they will generally be designed of such diameter as to admit a working-stress not less than that given by the "dynamic" method. In very high girders this will be effected by using secondary bracing; and then, without altering the value of κ , we may take formula (1) to represent the mass of metal in the direct elementary members of the girder, exclusive of the secondary bracing—the latter being considered as a portion of the lateral or transverse wind-bracing and included in the first measurement of the useful load p .

Such extreme cases may however be treated with equal facility by including the secondary bracing in the weight of the strut, and adopting of course a suitable value of κ for the practical weight of the braced strut according to its length and its load. For this purpose the values of κ given in the diagrams Figs. 163 to 163D, may be taken as an approximate estimate.

210. Limiting Span.—The formula (1) for the weight of girders shows evidently that the limiting span, for any given type of girder, will be reached when the denominator $1 - L \cdot \Sigma \gamma \mu$ is equal to 0; and therefore the limiting span is—

$$L_{\infty} = \frac{1}{\Sigma \gamma \mu} \dots \dots \dots (2)$$

For example, if we adopt the proportions and general design of the Ohio bridge, the limiting span for wrought-iron girders will be—

$$L_{\infty} = \frac{1}{.000935} = 1070 \text{ feet.}^1$$

This figure is of course based on the assumption that, in such an imaginary case, the working-stress would be $6\frac{3}{4}$ tons in tension, the

¹ This assumes that κ will not be increased when the dimensions are doubled, which is not quite correct; but it is hardly worth while to estimate the increase for such an impossible case.

factor of safety being 3; because the load would be entirely dead load. If the factor of safety is 4, the limiting span will be $\frac{3}{4}$ ths of the above quantity, or 802 feet.

It will of course be seen that to build such a span is practically impossible, because the amount of metal required to carry any useful load would be infinite, however small the useful load may be. The girders would therefore be totally incapable of carrying anything beyond their own weight; and this would be equally true whether two girders or twenty girders were employed to span the opening, and equally true whether the girders were made with the lightest possible section or the heaviest possible section.

The *practical* limit to the width of span is therefore certainly less than L_{∞} , but may approach to that quantity as nearly as may be consistent with the length of the promoter's purse. But speaking practically, it is obvious that the economy of long-span bridges will depend chiefly upon the value of the quantity $\Sigma\gamma\mu$; while in smaller bridges it will depend chiefly upon the quantities $p\Sigma\gamma\mu'$ and $\Sigma\gamma\mu''$.

211. Economy in Details.—The economy or the wastefulness of a design, so far as it depends upon the choice of details or of materials, is represented by the factor γ , which is proportional to $\frac{\kappa}{t}$

We have already seen that the coefficient κ (for waste of construction) varies widely in different classes of work and especially in the tension members. In the eye-bars of the Ohio bridge $\kappa = 1.33$, while in the tension flanges of the Charing Cross and other similar bridges the coefficient κ is equal to 2.00, or 50 per cent. greater. This waste of metal in the rivetted trough-shaped flange is perhaps of little consequence in small bridges, and considering the difference in the cost per ton, may probably involve no waste of money, and may even be cheaper. But the case is very different in long-span bridges, where any waste of material in the details may entail an enormous expenditure of material in the whole bridge, owing to the stress produced by its own useless weight, and the weight of the material which is required to carry it.

To illustrate this point we may compare the weight of the Ohio bridge with the weight that would have been required if the same general design had been carried out with tension members built up of rivetted ironwork, as in the Kuilemburg girders.

The actual weight of the girders, as stated in the last article, is 1.79 tons per foot, or 921 tons; and taking the higher value of γ as applicable to the Kuilemburg style of details, we find that the weight would be increased to 2.44 tons per foot or 1257 tons; so that the employment of rivetted tension members in the place of eye-bars would increase the weight of metal by 36 per cent., or by 336 tons of wrought iron.

If the span had been greater, the difference would have been still more striking.

212. Economy in the Choice of Material.—The specific gravity of

iron, in its various forms of cast iron, wrought iron, and steel, is so nearly the same that we may take the specific weights of members composed of these three materials as varying inversely with the working-stress that is proper to each.

Cast iron is therefore eminently unsuitable for tension members, and eminently suitable for short compression members which are not liable to buckling. When efficiently braced, it has occasionally been used with economy and success in the upper flanges of parallel girders and roof trusses, and still more frequently in the piers of tall viaducts; but since the disastrous failure of the Tay bridge, this class of construction has been viewed with disfavour by the governmental authorities in England.

As between rivetted structures of wrought iron and of mild steel, we may take it that the working-stress in tension will be as 5 to 7·5, or as 1·00 to 1·50. It follows that for rivetted tension flanges of mild steel the coefficient γ , or the weight per foot and per ton of load, will be the same as that given for wrought-iron eye-bars. Therefore the advantage that is apparently to be gained by the use of the stronger material may be entirely lost by the waste of steel in cover plates and the loss of section at the rivet-holes. This comparison is certainly a rough one, because steel plates can be made in greater lengths than wrought iron and require fewer cover plates; but on the other hand the covers should be longer on account of the small shearing strength of the rivets; and it must also be remembered that wrought-iron eye-bars can easily be obtained with a greater tensile strength than 20 tons per square inch, which is all that we have given them credit for. Altogether there can be little doubt that, strength for strength, the tension chord of a parallel girder can be made of wrought-iron eye-bars of good quality, with quite as little material as would be required if the flange were built of plates and angles of the best quality of mild steel.

On the other hand it is evident that when the same kind of connections can be used for steel as for wrought iron, the selection of the stronger material for the tension members will be attended with a considerable saving of weight, which will especially show itself in long span bridges. Thus if steel eye-bars can be made to develop an effective strength of 30 tons per square inch of shank, together with the necessary degree of ductility, the value of γ would be reduced to 0·002 nearly, unless the swelled heads are made larger than in wrought-iron eye-bars.¹

As regards the choice of material for compression members, we must consider the relative economy of wrought iron and steel from a different point of view. In short struts, the compressive strength of mild steel may be from 33 to 50 per cent. greater than that of wrought iron, while the compressive strength of strong steel may be twice as great as that of wrought iron, and even more. But there are two reasons why this ratio fails to give any reliable measure of the relative economy of the different

¹ In regard to practical difficulties in the manufacture of steel eye-bars, *vide* Arts. 154-158.

materials. The first was referred to in Chapter X., where it is shown that the strength falls off as the length of the strut is increased, and falls off more rapidly in mild steel than in wrought iron, and more rapidly in hard than in mild steel; so that when the strut is very long and slender there is very little difference between the strengths of the three materials. This fact renders it highly important to design all steel compression members with a liberal diameter.

The second reason is explained in Chapter XI., which describes the practical conditions that limit the diameter of struts when their sectional area is small in comparison with their length, and it is obvious that the same conditions will operate more severely in the case of steel than in the case of wrought iron.

For example, if we take the vertical posts in the web of the "Ohio" girders, which are 51 ft. 6 ins. in height, we shall find that these box-shaped members are designed with the view of obtaining as large a diameter as possible, and with that object are composed of plates which are nearly as thin as it would be practicable to make them. Now if steel were employed instead of wrought iron, the thickness of the plates could hardly be reduced, and therefore the sectional area could only be reduced by diminishing the diameter which is already very small in proportion to the height; and it will follow that the substitution of steel in the place of wrought iron would scarcely be attended with *any* saving of weight in these long and lightly loaded struts. The same remark would also apply to the compression flange of the girder at and near the ends of the span; so that the superior economy of steel would in practice only show itself in the more heavily strained portions of the flange and web, and would not effect a very large saving in the weight of the entire girder.

These considerations must in like manner influence the choice of material for any other type of bridge-construction. There is no doubt that for long span bridges the use of steel offers a considerable and very valuable advantage; but its apparent economy will disappear in practice unless the details are designed in the most efficient form. To realise its economic advantages the tension members must be composed of eye-bars; while the struts must be so arranged that the load is large in comparison to the length, and must be then designed with the most efficient sections.

213. Economy in Design.—The theoretical economy of any type of girder may perhaps be measured by summing up the products of stress \times length; but if the calculation is based upon the old rule for determining sectional areas, or upon the assumption that γ will have the same value for all lengths of strut and all descriptions of tie, the results will be quite unreliable. In this chapter we have determined the sectional areas by a rule which, in most ordinary cases, gives their practical value; and within the limits mentioned the coefficient γ will have a constant value for each class of detail. The tables will therefore serve as a means of estimating

the weight for the ordinary purposes of design ; but if they are applied to girders of extraordinary proportions, or to any case outside of the prescribed limits, it will be necessary to consider whether the coefficient γ will suffice, and especially whether it will be large enough to cover the liability to buckling in long struts.

Keeping this in view, we may draw from the tables some general deductions.

Type of Bracing.—If we compare together the respective values of μ , μ' , or μ'' , for different types of bracing, as applied to a girder of given span and depth, we shall find that there is very little difference between them on the score of economy, and very much less than the difference which results from the choice of detail. Thus if we take $R=10$ in a series of through bridges of the several types treated in Tables 1, 4, 5, 6, 7, making $N=10$ in each case, we find that on the average the values of μ , μ' , or μ'' , do not differ by more than 10 per cent. at the outside. One type may show a slight superiority as regards the dead load, which is perhaps reversed when the live load comes in question ; but in the average of cases the difference will not be greater than we have stated.

If we come to the double systems of bracing treated in Tables 2, 3, and 8, we shall again find very little difference in their relative economy.

Theoretically, the double lattice girder of Fig. 211 comes out 8 or 9 per cent. lighter than the others ; but in practice this would seldom be the case, for we have already found that in a close lattice girder the coefficient γ must be increased in order to include the vertical stiffeners or else to include the secondary bracing which must be employed to stiffen the long and slender diagonal struts.

Comparing the double lattice with the single lattice girders of either of the respective types, there is generally a difference of about 8 per cent. in favour of the latter ; but here it must be remembered that the floor longitudinals will have a span twice as great in the latter as in the former ; while the upper flange of the girder will also have an unsupported length twice as great. In many cases this will nearly or quite neutralise the small advantage which apparently exists in favour of the wide panels. But on the other hand the unsupported length of the struts will be greater in single lattice girders, and in steel bridges this will more than compensate the disadvantages.

Having regard to such small differences as do exist, the only inference to be drawn is that there is no type of parallel girder that can be universally adopted as the best ; but the selection must be governed by the ratio of dead to live load, the length of span, the material to be employed, and the facilities which may exist for the construction and erection of particular classes of work.

Proportions of Girder.—In the early days of bridge-construction, when the girder was treated as an improved form of beam, the depth was often as little as $\frac{1}{8}$ th of the span ; but such proportions have generally

been abandoned, and in modern times there are few bridges of 200 feet span and upwards which have a depth less than $\frac{1}{10}$ th, and few in which the depth is much greater than $\frac{1}{3}$ th of the span.

Within these limits, we have seen that the coefficient γ is tolerably constant, but would have to be increased if a greater depth were adopted. The values of μ are applicable to any ratio of depth to span, and we may first consider the economic value of depth by supposing each of the types shown in Figs. 201 to 212 to be successively designed with a ratio $R = 10, 9, 8, 7, \&c.$, leaving the number of panels unaltered, but making the inclination of the diagonals to vary with the depth.

The weight of a set of members being $W = \gamma\mu L = L\gamma\left(\alpha R + \frac{\beta}{R}\right)$, we may differentiate W in respect of R , and we have

$$\frac{\delta W}{\delta R} = L\gamma\left(\alpha - \frac{\beta}{R^2}\right)$$

Therefore putting $\frac{\delta W}{\delta R} = 0$, we have the most economic ratio of depth to span, or—

$$R = \sqrt{\left(\frac{\beta}{\alpha}\right)} (3)$$

Applying to each set of members a coefficient γ suitable to their construction, and summing the products, we may denote $\Sigma\gamma\alpha$ by A , and $\Sigma\gamma\beta$ by B , so that the weight of the girder is expressed by $w = (A + B)L$; and then we shall have—

$$\text{Economic } R = \sqrt{\left(\frac{B}{A}\right)} (3a)$$

Now if we could assume that γ is a constant quantity and independent of the depth, this formula would indicate that in most cases the economic depth is considerably greater than the proportion usually adopted in practice, and would often be as great as one-sixth of the span; but at the same time the tables show that the advantage to be gained by adopting this greater depth is so extremely small that it would vanish altogether if the increased depth entailed any considerable increase in the coefficient γ as applied to the vertical posts. If we take for those members a slightly higher value of γ , such as would probably be necessitated by the greater depth, the economic depth will be reduced quickly to one-seventh or to one-eighth of the span; and it becomes evident that in practice there will be very little difference in the total weight of the girder, whether the depth be $\frac{1}{10}$ th, $\frac{1}{8}$ th, or $\frac{1}{6}$ th of the span.

Again if we take a constant depth, and compare the relative weights of girders with a varying number of panels, we shall find that the wider panels show a certain small advantage, which is not much greater than the attendant disadvantage; viz., the extra weight of metal required in

the longitudinals to span the wider panels. Lastly, if we take a constant angle of bracing and try the effect of simultaneously increasing the depth and the width of panel, we shall find a more marked economy in favour of great depth and wide panels; but at the same time we shall of course have to provide for *both* of the compensating disadvantages. Thus taking the form shown in Fig. 201 and treated in Table 1, we may divide the span into any number of panels from 10 down to 3; and the latter extreme will represent the form of construction adopted in the Chepstow bridge, which has a span of 300 feet divided into 3 panels of 100 feet each, while the depth is $\frac{1}{4}$ th of the span.

So far as the value of ω is concerned, the three-panel bridge should be the lightest; but the extra metal required to stiffen the long unsupported struts in flange and web, and to construct the subsidiary longitudinals in spans of 100 feet each, is so great, that the Chepstow bridge will not compare favourably with other lattice girders of the same span and of more usual proportions.

Summing up the above results we may perhaps state the following conclusions in regard to economy of design:—

1. If the sectional areas are determined by the old rule, it is impossible to find the most economic depth, except by using an arbitrary factor for the relative weights of horizontal and of vertical members; and the economic depth will then depend entirely upon the factor that may be arbitrarily chosen; while no factor can correctly be applied to all cases alike, nor can the same factor be applicable to both struts and ties.

2. By using the newer methods, a truer estimate may be obtained; but still no general rule can be given for the economic depth, which in each case will depend upon the following varying conditions.

3. The economic depth depends upon the ratio of the dead to the live load, and *cæteris paribus* will be greater in long spans than in short ones.

4. It depends also upon the character of the details; and if the tension flange is composed of eye-bars it will be less than if that member is composed of rivetted plate.

5. It depends partly upon the material employed, and will probably be less in steel than in wrought-iron bridges.

6. The economic depth can hardly be considered apart from the spacing of the panels; and in public-road bridges with heavy platforms it will be less than in railway bridges.

7. The weight of the girder will be very slightly increased by adopting a depth which is 10 or 20 per cent. less than the theoretical economic depth; and such a reduction may be justifiable on grounds not hitherto considered—such as wind pressure.

8. For railway bridges of 200 to 500 feet span, a depth of $\frac{1}{10}$ th to $\frac{1}{8}$ th of the span will be either the most economical, or very nearly the most economical, that can be chosen; and any advantage that may be

obtained by a greater depth will reach only a small fraction of the saving that may be effected by other means—such as by employing rolled eye-bars in the place of plate-built tension members.

9. The economy of American girders may perhaps, in some degree, be due to the skill evinced in the outline design, and partly also to the adoption of a liberal depth, but in much greater measure is due to the saving of waste material in the joints, effected by the economical character of the details.

CHAPTER XVIII.

PARABOLIC GIRDERS, POLYGONAL TRUSSES, AND CURVED GIRDERS.

214. Different Forms of "Parabolic" Girder.—In the general classification of bridge structures contained in Chapter V., we have included in the second group all those parabolic or polygonal forms of girder which may be constructed by giving to the outline elevation of the girder the same form as that of the diagram of moments for the uniform load. That is to say, the depth of girder must be everywhere proportional to the bending moment. Thus if the load is uniformly distributed *along the girder* the elevation will be either that of an upright or an inverted bowstring of parabolic form, or that of an arch and chain bridge of the Saltash type. If the load is divided into numerous panels and transferred to the main girders at short intervals between the panel-points, the curved members will follow a line closely approximating to the parabolic curve as in Figs. 215, 216, and 217, of Plate J. But if the girder is divided into a few wide panels, its outline will be of polygonal form, as in Fig. 218, the polygon being inscribed in a parabolic curve so that each of its angles touches that curve, while each of its sides corresponds to a bay of the floor panelling.

All the different forms that may be designed in accordance with these definitions can be treated upon the same principles, and the stresses due to the dead and live loads may be determined by a general rule of extreme simplicity.

215. Horizontal Stress in the Flanges.

Let L = the length of span.

D = the central height of the *parabolic curve*,¹ or the central depth of the bow and chain bridge.

p = the dead load per foot lineal.

q = the rolling load ,,

Then we have already seen, in Chapter V., that the horizontal component of the stress in either flange due to the dead load p is the same in every panel, and is expressed by

$$H_p = \frac{pL^2}{8D} \dots \dots \dots (1)$$

¹ When the girder is divided into an even number of panels, the depth D is the central depth of the girder; but with an odd number of panels D is always somewhat greater than the depth of the central panel. *Vide Art. 49.*

It will be seen immediately that every element of the rolling load adds a positive and never a negative quantity to the flange stress ; so that the maximum stress occurs when the rolling load covers the whole span, and therefore

$$\text{Max. } H_q = \frac{qL^2}{8D} \dots \dots \dots (2)$$

The direct stress in any inclined bar of the polygon or parabola is of course equal to the horizontal stress multiplied by sec. θ , or by the secant of the angle of inclination ; but we shall presently find a geometric method of measuring the direct stress in every member of the girder by means of the general elevation, and in the simplest possible manner.

216. Horizontal Stress in the Diagonals of the Web.—We have seen that the uniform dead load produces no stress in the diagonals, the whole of the shearing stress being resisted by the vertical component of the inclined stress in the curved members. Therefore if the web consists of a single system, as in Fig. 218, there can be no stress in the diagonals ; but the load will be suspended from the joints of the polygon by the verticals, and if b denotes the width of each panel, the dead load on each vertical will be $P = pb$.

If the panels of the web are counterbraced, as in Figs. 215, 216, and 217, the diagonals may be adjusted with any arbitrary degree of initial tension so as to entirely relieve the tension of the verticals or even throw them into compression ; but we shall here suppose that the diagonal braces have been adjusted without any initial tension under the dead load.

To find the maximum and minimum stresses produced by different positions of the rolling load, we may apply the rules already given in Chapters XV. and XVI., taking the live load at each joint at $Q = qb$.

Thus the bending moments due to each element of the live load, as given in Table 1, Art. 190, will apply equally well to the parabolic girder of ten panels shown in either of the Figs. 215, 216, or 217 ; and would apply to *any* girder of ten equal panels whatever may be its outline. In the parabolic girder the depth at each vertical must bear a certain ratio to the central depth D ; and taking $D = \text{unity}$, we have the depth at each vertical in the present case as follows :—

	No. of Joint.					
	0	1	2	3	4	5
$d =$	0	0.36	0.64	0.84	0.96	1.00

Therefore dividing the bending moment by the depth d , we obtain the horizontal flange stress at each joint, due to the load Q placed in successive positions, as follows, in units of $Q \frac{b}{D}$.

TABLE 2A.—Horizontal Flange Stress in a Parabolic Girder of Ten Equal Panels, produced by Unit Load on each Joint.

Central depth $D=1$; Panel width $b=1$; Panel load $Q=1$.

Position of Load.	H ₁	H ₂	H ₃	H ₄	H ₅	H ₆	H ₇	H ₈	H ₉
At No. 1	2·500	1·250	0·833	0·625	0·500	0·417	0·357	0·313	0·278
„ 2	2·222	2·500	1·667	1·250	1·000	0·833	0·714	0·625	0·556
„ 3	1·944	2·187	2·500	1·875	1·500	1·250	1·071	0·937	0·833
„ 4	1·667	1·875	2·143	2·500	2·000	1·667	1·429	1·250	1·111
„ 5	1·389	1·563	1·786	2·083	2·500	2·083	1·786	1·563	1·389
„ 6	1·111	1·250	1·429	1·667	2·000	2·500	2·143	1·875	1·667
„ 7	0·833	0·937	1·071	1·250	1·500	1·875	2·500	2·187	1·944
„ 8	0·556	0·625	0·714	0·833	1·000	1·250	1·667	2·500	2·222
„ 9	0·278	0·313	0·357	0·417	0·500	0·625	0·833	1·250	2·500
Total .	12·500	12·500	12·500	12·500	12·500	12·500	12·500	12·500	12·500

Then proceeding as before to subtract H_n from H_{n+1} , we have the horizontal stress in each panel of the web as in the following table:—

TABLE 3A.—Horizontal Stress in each Panel of the Web, in a Parabolic Girder of Ten Equal Panels.

Position of Load.	Number of Panels.									
	0-1	1-2	2-3	3-4	4-5	5-6	6-7	7-8	8-9	9-10
At 1	2·500	-1·250	-·417	-·208	-·125	-·083	-·060	-·044	-·035	-·278
2	2·222	·278	-·833	-·417	-·250	-·167	-·119	-·089	-·069	-·556
3	1·944	·243	·313	-·625	-·375	-·250	-·179	-·134	-·104	-·833
4	1·667	·208	·268	·357	-·500	-·333	-·238	-·179	-·139	-·111
5	1·389	·174	·223	·297	·417	-·417	-·297	-·223	-·174	-·1389
6	1·111	·139	·179	·238	·333	·500	-·357	-·268	-·208	-·1667
7	0·833	·104	·134	·179	·250	·375	·625	-·313	-·243	-·1944
8	0·556	·069	·089	·119	·167	·250	·417	·833	-·278	-·2222
9	0·278	·035	·044	·060	·083	·125	·208	·417	1·250	-2·500
+ Total	12·500	1·250	1·250	1·250	1·250	1·250	1·250	1·250	1·250	0
- Total	0·	-1·250	-1·250	-1·250	-1·250	-1·250	-1·256	-1·250	-1·250	-12·500
Sum	12·500	0·	0·	0·	0·	0·	0·	0·	0·	-12·500

Adding up the positive and the negative stresses, the totals give the horizontal components of the greatest compressive and the greatest tensile stress that would take effect in the diagonals under different positions of the rolling load.

In every panel of the web bracing, the positive total is equal to the negative total, and is exactly equal to one-tenth of the maximum horizontal stress in the flanges. If we divide the girder into any other number of panels, we shall find that in every case the maximum horizontal stress in any diagonal is expressed by $\pm h = \frac{H_g}{N}$, in which N is the number of panels, and H_g the flange-stress $\frac{qL^2}{8D}$ due to the rolling load.

It may be remarked that a strict mathematical investigation, based upon the assumption that the train is of uniform weight throughout its length, would lead to a slightly different result, and would give for each diagonal of the web

$$\pm h = \frac{H_g}{N+1}.$$

But we have already seen that the stresses derived from the table are in practice nearer to the truth than those which may be calculated upon that basis; and as before we shall prefer to take $\pm h = \frac{H_g}{N}$.

In a single system of bracing, such as that of Fig. 218, this expression gives the compressive and tensile stress to which each diagonal will be liable; so that the stress (horizontal) will vary between $-\frac{H_g}{N}$ and $+\frac{H_g}{N}$; but when every panel is counterbraced as in Figs. 215, 216, and 217,—the diagonals are designed to act in tension only, and the stress in each will vary between zero and $-\frac{H_g}{N}$, supposing of course that they are adjusted without any initial tension. The greatest compressive stress in any vertical post will then be equal to the vertical component of the greatest stress in either of the diagonals attached to its extreme end.

217. Graphic Method of Determining the Greatest Stress in each Member of any Parabolic Girder.—It follows from the above calculations that the greatest stress in any member of the web bracing is *directly proportional to its length*; and all the required stresses in flanges and web may be simply scaled off from the outline elevation of the girder, as follows:—

At each end of the span AC , set up as in Fig. 218, the vertical lines AG and CK each equal to four times the depth of the parabola, so that the lines GC and KA would form tangents to the parabolic curve at A and C . Now let the heights AG and CK represent, on a suitable scale of tons, the upward reactions of the abutments when supporting the entire live load qL ; i.e., make $AG = \frac{qL}{2}$. Then using the same scale, the length of the chord or flange AC will represent the maximum stress in that member. The length of any diagonal will represent the greatest direct stress in that diagonal; and the length of any vertical post will

represent its greatest compressive stress. To find the direct stress in any inclined member of the parabolic or polygonal flanges, such as ED in Fig. 218, it is only necessary to continue the line ED until it intersects the verticals AG and CK in the points R and S , when the length RS will at once measure the direct stress in the member.

This very expeditious method will be equally applicable to the upright or the inverted bowstring, or to a girder of the Saltash type; and will be equally correct whether the girder is divided into an odd or an even number of panels, and whether the panels be wide or narrow or of regular or irregular widths.

Having thus ascertained the stresses due to the live load, we may readily obtain the maximum and the minimum stress in each member, by adding together algebraically the stresses due to the dead and live loads respectively.

Example 1.—Let Fig. 215 represent an upright bowstring of 120 feet span, and with a central depth of 15 feet or $\frac{1}{8}$ th of the span, and forming one of a pair of main girders carrying a double line of railway.

For the sake of illustration, we will assume the same loads as those taken in the parallel girder of Arts. 197 and 202; viz., a total dead load of $1\frac{1}{2}$ ton per foot, and a total live load of $2\frac{1}{2}$ tons per foot; the dead load being divided into two equal parts, of which one, representing the weight of the platform, is carried at the lower joints, and the other, representing the assumed weight of the girder, is equally divided between the upper and lower joints.

Then taking each girder separately, the horizontal stress in either flange due to the dead load will be $H_p = \frac{pL^2}{8D} = \frac{0.75 \times 120^2}{8 \times 15} = 90$ tons; and in the same way the horizontal flange stress due to the live load will be $\frac{1.25 \times 120^2}{8 \times 15} = 150$ tons. This gives us the direct tensile strength in the lower chord, and the horizontal component of the compressive stress in every bay of the upper chord. Then multiplying by $\sec. \theta$, or measuring the length RS in Fig. 218, for each bay, we have the direct stress in each bay of the upper flange as given in columns S_p and Max. S_q of the following table.

Under the dead load, the diagonals will suffer no stress; but each vertical will carry as a tie the weight of one panel of the floor and half the weight of one panel of the girder; the tensile stress being therefore $-S_p = \frac{12(0.75 + 0.375)}{2} = 6.75$ tons.

Under the live load, the maximum tension in any diagonal, or compression in any vertical, will be proportional to its length; and, as in the lower chord AC , will amount to $\frac{150}{120} = 1.25$ tons for every foot of its length; and the stresses, as scaled off from the drawing, will be as follows:—

Table of the Direct Stresses in a Bowstring Girder of Ten Equal Panels.
Span = 120 Feet ; Central depth = 15 Feet.—Fig 215.

Member.	Dead Load.	Live Load.		Combined Load.		
	S_p .	Max. S_r .	Min. S_r .	Max. S.	Min. S.	
Upper flange	0-1	98·5	164·5	0·	263·0	98·5
	1-2	95·5	159·0	0·	254·5	95·5
	2-3	92·5	154·5	0·	247·0	92·5
	3-4	91·0	151·5	0·	242·5	91·0
	4-5	90·0	150·0	0·	240·0	90·0
Lower flange	- 90·0	- 150·0	0·	- 240·0	- 90·0	
Verticals	1-I	- 6·75	- 15·0	6·75	- 21·75	0·
	2-II	- 6·75	- 15·0	12·00	- 21·75	5·25
	3-III	- 6·75	- 15·0	15·75	- 21·75	9·00
	4-IV	- 6·75	- 15·0	18·00	- 21·75	11·25
	5-V	- 6·75	- 15·0	18·75	- 21·75	12·00
Diagonal ties	1-II	0·	- 16·45	0·	- 16·45	0·
	2-II	0·	- 19·20	0·	- 19·20	0·
	2-II	0·	- 19·20	0·	- 19·20	0·
	3-II	0·	- 21·75	0·	- 21·75	0·
	3-IV	0·	- 21·75	0·	- 21·75	0·
	4-III	0·	- 23·45	0·	- 23·45	0·
4-V	0·	- 23·45	0·	- 23·45	0·	
5-IV	0·	- 24·00	0·	- 24·00	0·	

In this table, as before, Max. S indicates the greatest stress in any member, whether of tension or compression ; while Min. S indicates the least stress of the same kind or the greatest stress of the opposite kind. The verticals are therefore classed in the table as ties, because in every case the member is liable to a greater tensile stress than its highest compressive stress.

It will be noticed, however, that the given stresses are based on the assumption that the uniform load is suspended from the bow by means of the verticals and not by any tensile stress in the diagonals. Whether this would really be the case or not will depend upon the initial adjustment of the bracing ; but at all events it *may* occur, and therefore the verticals should at least be proportioned to carry the given tensile stress Max. S ; and then we must consider whether the sectional area is also sufficient to carry the greatest compressive stress.

If the diagonals are not strained under the dead load, the greatest compression in the verticals may be taken as the algebraical sum of the compression due to the live load S_p , and the tension S_p due to the dead load. But if the verticals do not act as suspenders to carry the dead

load, their greatest compressive stress will be equal to the whole value of Min. S_p ; and may reach any higher value if the diagonals are tightened up with a severe initial tension.

It may perhaps be considered judicious to provide against such a contingency; but this is seldom done in practice; and it may be remarked that the ambiguity which we have here observed is not by any means confined to the bowstring girder, but exists in the same degree in every kind of girder in which the web is composed of braces and counter-braces.

Example 2.—If we now suppose the same bridge to be constructed as in Fig. 216, with the inverted form of bowstring, and with the same loads, the stresses in the upper chord, and in each bay of the parabolic chain, will have the same values as in the lower chord and parabolic arch of the previous example, but will of course be of the opposite kinds.

The greatest tensile stress in each diagonal will also be the same as in the corresponding diagonal of the upright bowstring; but the verticals between the upper and lower chord will no longer act as ties, but as struts. Under the dead load each post will carry the weight of one bay of the upper chord, or say one half of the weight of one bay of the main girder, so that $S_p = \frac{4.5}{2} = 2.25$ tons compression; while the greatest compressive stress due to the live load will be equal to the vertical component of the greatest stress in the inclined ties attached to the post. For the vertical posts, therefore, the maximum and minimum stresses will have the following values:—

Inverted Bowstring.—Fig. 216.

Member.	Dead Load.	Live Load.		Combined Load.		
	S_p .	Max. S_q .	Min. S_q .	Max. S .	Min. S .	
Vertical posts	{ I-I 2-II 3-III 4-IV 5-V	2.25	12.00	0.	14.25	2.25
		2.25	15.75	0.	18.00	2.25
		2.25	18.00	0.	20.25	2.25
		2.25	18.75	0.	21.00	2.25
		2.25	18.75	0.	21.00	2.25

Between the parabolic chain and the suspended roadway, the verticals will of course act as ties; the roadway girders may be supported at intermediate points as shown in the Fig. by suspenders attached to the joints of the chain, and the whole weight of the platform and live load will of course be divided between the whole series of verticals.

Example 3.—In the bow-and-chain bridge of Fig. 217 the stresses will be easily found by the same methods. The horizontal components of all the stresses will be the same as before, and the direct stress in the

inclined bays may readily be measured, both in the flanges and diagonals. In regard to the verticals, we may perhaps consider the weight of the main girder to be equally divided between the upper and lower joints; and then if the rise of the arch is equal to the dip of the chain, the weight of the girder will produce no stress in the verticals.¹

If these proportions are followed, the total weight of the platform and its live load will be equally divided between the bow and the chain, so that between those members the verticals will act as ties carrying one half of the weight of one panel; while the greatest compressive stress due to the live load will be again equal to the vertical stress in the attached diagonals.

Therefore if the loads and general dimensions of span and depth are the same as in the previous examples, we shall have the following stresses in the vertical posts:—

Bow and Chain Bridge.—Fig. 217.

Member.	Dead Load.	Live Load.		Combined Load.		
	Sp.	Max. Sq.	Min. Sq.	Max. S.	Min. S.	
Vertical posts.	1-I	-2.25	+9.5	-7.5	7.25	-9.75
	2-II	-2.25	+14.0	-7.5	11.75	-9.75
	3-III	-2.25	+17.0	-7.5	14.75	-9.75
	4-IV	-2.25	+18.5	-7.5	16.25	-9.75
	5-V	-2.25	+18.5	-7.5	16.25	-9.75

218. Determination of Sectional Areas.—Upon the basis of the above calculated stresses, the sectional areas of the several members in the upright bowstring of Fig. 215 would be determined as follows:—

By the old rule of 5 tons per square inch in tension and 4 tons in compression, the areas as found from Max. S would be those given in column A_0 of the following table. In practice these areas would be adopted for the net section of the lower flange and gross section of the upper flange; but the areas given by the old rule for the web-members would have to be largely increased. In the case of the diagonal ties the working stress would be arbitrarily reduced to 4 or $3\frac{1}{2}$ tons per square inch, while the verticals would perhaps be treated by adding the tension and the compression together and then taking a reduced working stress of 4 tons per square inch; and the results would be those given in column A_1 .

¹ In the Saltash bridge these proportions are followed, but the weight of the bow is greater than that of the chain, and the excess is equalised between the two members by the vertical posts, which transfer one-half of the excess to the lower flange.

Sectional Areas for Bowstring, Fig. 215; by Different Methods.

Member.	Max. S.	Min. S.	Δ°	A_1	$\frac{\text{Min. S.}}{\text{Max. S.}}$	A_s	A_e	
Top flange	0-1	263.0	98.5	65.8375	62.8	64.8
	1-2	254.5	95.5	63.6375	60.2	63.1
	2-3	247.0	92.5	61.8375	58.5	61.0
	3-4	242.5	91.0	60.6375	57.4	59.7
	4-5	240.0	90.0	60.0375	56.7	59.0
Lower flange	-240.	-90.	48.0375	45.4	47.2	
Verticals	1-I	-21.75	0.	4.35	5.44	0.	4.9	6.5
	2-II	-21.75	5.25	4.35	6.75	-.24	5.5	7.3
	3-III	-21.75	9.00	4.35	7.70	-.41	6.1	7.9
	4-IV	-21.75	11.25	4.35	8.25	-.51	6.5	8.2
	5-V	-21.75	12.00	4.35	8.44	-.55	6.8	8.3
Diagonal ties	1-II	-16.45	0.	3.3	4.1 to 4.7	0.	3.7	4.9
	2-I	-19.2	0.	3.8	4.8 ,, 5.5	0.	4.3	5.8
	2-III							
	3-II	-21.75	0.	4.4	5.4 ,, 6.2	0.	4.9	6.5
	3-IV							
	4-III	-23.45	0.	4.7	5.8 ,, 6.7	0.	5.3	7.0
4-V								
5-IV	-24.0	0.	4.8	6.0 ,, 6.9	0.	5.4	7.2	

The newer methods of determining the sectional areas have already been described, and their results in this particular example are given in columns A_4 and A_e . The former relates to the Weyrauch method, in which the working stress depends upon the ratio $\frac{\text{Min. S.}}{\text{Max. S.}}$; and, as before noticed, the areas thus determined are somewhat less than would be adopted in English practice. The results of the dynamic or "sixth" method are given in column A_6 , and as before they will be seen to agree very nearly with the sectional areas which would be adopted as a minimum in average practice.

It must be remarked, however, that the areas determined for the verticals by any method of calculation can only be regarded as a theoretical minimum which in practice will frequently be exceeded for several reasons. In the upright bowstring the main girders cannot be united by overhead bracing, except perhaps at one point in the centre, and the verticals must therefore be designed as stiffeners with a broad plate section or in the form of a braced strut. In the latter case the area found by the "sixth" method may probably be sufficient for the vertical sides of the strut, but will not include the secondary bracing; and will certainly be insufficient to represent the area of a plate-built strut of I or + section, which is designed to act both as a strut and as a stiffener.

It will also be seen that, in all parabolic girders, the stress in the web-members, and their theoretical areas, are always very small in proportion to their length; so that in this respect they resemble the most lightly loaded members in the central portion of the web of a parallel girder; and in the case of the inverted bowstring, or a bridge of the Saltash type, the question of liability to buckling becomes the chief factor in determining the necessary section of the verticals. That is to say, if we calculate the sections of the vertical posts of Fig. 216 by either of these methods, we shall find it sometimes impossible to design the section with a sufficient width to resist the buckling tendency except by increasing the sectional area—for reasons which have been explained in Chapter XI.

On consulting the tables given in Chapter XI. it will be found that the area given by the "sixth" method approximates most nearly to the actual requirements, but will have to be increased in some of the posts by 10 or 20 per cent. in order to represent the section required by Rankine's formula; while in some cases a still greater increase would be required in order to adapt the member to act as a stiffener in a very tall girder.

To illustrate this, we may take the case of the Saltash bridge, which has a central depth of 56 feet from bow to chain. The greatest possible tensile stress in the central verticals is about 20 tons, and the greatest compressive stress about 28 tons; so that the sectional area as given by the "dynamic" method would be 14.25 square inches.

The struts are formed of a cruciform section built of thin plate and angle irons, and their actual sectional area is 24.7 square inches.

If these posts had been designed purely for the purpose of resisting compression, there is no doubt that the same strength might have been obtained with much less material by adopting a hollow box or tubular section; but being adapted also to act as stiffeners, the form chosen for this purpose necessitates the additional metal.

In estimating the weight of such a girder, it will therefore be advisable to take a coefficient, for excess of sectional area, not less than $\frac{24.7}{14} = 1.75$ as applied to the central posts. But in practice the section

adopted for the central posts will generally be adhered to for all the others; and taking all the posts together the coefficient will be about $\kappa = 2.20$ to 2.60, including the weight of connections.

As regards the vertical suspenders it will not be sufficient to assume that the entire rolling load is equally divided between them, but the sectional area of each must be proportioned to the greatest panel load due to the engine wheel base. In a span of 120 feet we have taken the live load at $1\frac{1}{4}$ tons per foot for each line; but on a 12-foot panel the engine load will be at least $2\frac{1}{2}$ tons per foot. In the same way if the span were 400 feet we might take the live load at 1 ton per foot; but for a 40-foot panel the load would be about 2 tons per foot. Of course

each case must be treated on its own conditions, and with reference to the actual engine loads as exemplified in Art. 174; but on the average we may take the panel load at about twice the intensity of live load assumed for the whole span.

219. Weight of Parabolic Girders.—In estimating the weight of the main girders for the purpose of ascertaining the total dead load, we may proceed by the method already described in the preceding chapter. The weight of the floor, permanent way, and wind bracing, is first to be ascertained and denoted by p . This will include the weight of the suspended roadway girders in the case of such a bridge as that shown in Fig. 216 or 217, and also the weight of any overhead bracing; so that the remaining weight of metal shall represent solely the main truss, or the amount required for the purpose of carrying the useful load.

Then reckoning the sectional areas as ascertained by the "dynamic" method, and adding together, for each set of members, the product of that area multiplied by the length, their weight will be expressed by the coefficient γ multiplied by $(w\mu + p\mu' + q\mu'')$; the latter coefficients relating respectively to the girder load w , the platform load p , and the live load q .

In calculating the coefficients μ , μ' and μ'' , in the following tables, it is assumed that the diagonals carry no part of the uniform load, and that the weight of the main girder is equally divided between the upper and the lower joints; and in the case of the vertical suspenders, the panel load is taken as equivalent to twice the rolling load q , for the reason already stated.

With these allowances the theoretical sectional areas will nearly approximate to the practical requirements, so that the coefficient γ will represent no arbitrary factor, but only the ascertainable waste of construction (which has already been discussed in previous chapters)—except only in the case of the vertical posts, for which we may generally take the values of γ mentioned in the preceding article, as representing a practical average. It will readily be understood, however, that the value of γ in any particular example may sometimes be found to differ considerably from the values we have quoted, and will depend in each case upon the skill evinced in the design of the details; so that the calculated weights can only be taken to represent the result which may be achieved by the adoption of well-designed details and a judicious choice of sections.

On these conditions we may estimate the weight w of the main girders, in tons per foot, by means of the formula—

$$w = \frac{L(p\sum\gamma\mu' + q\sum\gamma\mu'')}{1 - L\sum\gamma\mu}$$

with sufficient accuracy for the purposes in view.

In the following tables of the coefficients μ , μ' , μ'' , the symbol R denotes the ratio of span to central depth of girder.

WEIGHT OF PARABOLIC GIRDERS.

TABLE 9.—Upright Bowstring. Through Bridge.—Fig. 215.

No. of Panels.	Upper Flange or Bow.	Verticals.	Lower Flange.	Diagonal Ties.
N = 8 $\left\{ \begin{array}{l} \mu \\ \mu' \\ \mu'' \end{array} \right.$	0·125 R + ·6562 ÷ R	·3281 ÷ R	0·125 R	0°
	·125 „ + ·6562 „	·6562 „	·125 „	0°
	·1875 „ + ·9844 „	1·845 „	·1875 „	·047 R + 2·038 ÷ R
N = 10 $\left\{ \begin{array}{l} \mu \\ \mu' \\ \mu'' \end{array} \right.$	0·125 R + ·66 ÷ R	·33 ÷ R	0·125 R	0°
	·125 „ + ·66 „	·66 „	·125 „	0°
	·1875 „ + ·99 „	1·987 „	·1875 „	·040 R + 2·602 ÷ R
N = 12 $\left\{ \begin{array}{l} \mu \\ \mu' \\ \mu'' \end{array} \right.$	0·125 R + ·662 ÷ R	·331 ÷ R	0·125 R	0°
	·125 „ + ·662 „	·662 „	·125 „	0°
	·1875 „ + ·993 „	2·124 „	·1875 „	·034 R + 3·153 ÷ R
N = 14 $\left\{ \begin{array}{l} \mu \\ \mu' \\ \mu'' \end{array} \right.$	0·125 R + ·663 ÷ R	·331 ÷ R	0·125 R	0°
	·125 „ + ·663 „	·663 „	·125 „	0°
	·1875 „ + ·994 „	2·260 „	·1875 „	·0306 + 3·7 ÷ R
N = 16 $\left\{ \begin{array}{l} \mu \\ \mu' \\ \mu'' \end{array} \right.$	0·125 R + ·664 ÷ R	·332 ÷ R	0·125 R	0°
	·125 „ + ·664 „	·664 „	·125 „	0°
	·1875 „ + ·996 „	2·394 „	·1875 „	·0275 R + 4·238 ÷ R

TABLE 10.—Inverted Bowstring with Suspended Roadway.—Fig. 216.†

Number of Panels in the Web.	Compression Members.		Tension Members.		
	Upper Flange.	Vertical Posts.	Lower Flange or Chain.	Vertical Suspenders.	Diagonals.
N = 8 $\left\{ \begin{array}{l} \mu \\ \mu' \\ \mu'' \end{array} \right.$	0·125 R	·328 ÷ R	0·125 R + ·664 ÷ R	0°	As in Table 9.
	·125 „	0°	·125 „ + ·664 „	0·274 ÷ R	
	·1875 „	1·235 „	·1875 „ + ·996 „	1·096 „	
N = 10 $\left\{ \begin{array}{l} \mu \\ \mu' \\ \mu'' \end{array} \right.$	0·125 R	·330 ÷ R	0·125 R + ·665 ÷ R	0°	Do.
	·125 „	0°	·125 „ + ·665 „	0·285 ÷ R	
	·1875 „	1·518 „	·1875 „ + ·997 „	1·140 „	
N = 12 $\left\{ \begin{array}{l} \mu \\ \mu' \\ \mu'' \end{array} \right.$	0·125 R	·331 ÷ R	0·125 R + ·665 ÷ R	0°	Do.
	·125 „	0°	·125 „ + ·665 „	0·292 ÷ R	
	·1875 „	1·795 „	·1875 „ + ·998 „	1·168 „	
N = 14 $\left\{ \begin{array}{l} \mu \\ \mu' \\ \mu'' \end{array} \right.$	0·125 R	·332 ÷ R	0·125 R + ·665 ÷ R	0°	Do.
	·125 „	0°	·125 „ + ·665 „	0·298 ÷ R	
	·1875 „	2·050 „	·1875 „ + ·998 „	1·192 „	
N = 16 $\left\{ \begin{array}{l} \mu \\ \mu' \\ \mu'' \end{array} \right.$	0·125 R	·332 ÷ R	0·125 R + ·666 ÷ R	0°	Do.
	·125 „	0°	·125 „ + ·666 „	0·303 ÷ R	
	·1875 „	2·339 „	·1875 „ + ·999 „	1·212 „	

Note.—This table does not include any weight of metal in the towers which may be either of iron or masonry.

TABLE 11.—*Bow-and-Chain Bridge, with Suspended Roadway.*
Fig. 217.

No. of Panels in the Web.	Compression Members.		Tension Members.		
	Bow.	Vertical Posts.	Chain.	Suspenders.	Diagonals.
$N=8 \begin{cases} \mu' \\ \mu'' \end{cases}$	$\cdot 125 R + \cdot 328 \div R$ $\cdot 125 \text{ ,, } + \cdot 328 \text{ ,,}$ $\cdot 1875 \text{ ,, } + \cdot 492 \text{ ,,}$	0 $\cdot 328 \div R$ $1\cdot 471 \text{ ,,}$	$\cdot 125 R + \cdot 332 \div R$ $\cdot 125 \text{ ,, } + \cdot 332 \text{ ,,}$ $\cdot 1875 \text{ ,, } + \cdot 498 \text{ ,,}$	0 $0\cdot 137 \div R$ $0\cdot 548 \text{ ,,}$	As in Table 9.
$N=10 \begin{cases} \mu \\ \mu'' \end{cases}$	$\cdot 125 R + \cdot 330 \div R$ $\cdot 125 \text{ ,, } + \cdot 330 \text{ ,,}$ $\cdot 1875 \text{ ,, } + \cdot 495 \text{ ,,}$	0 $\cdot 330 \div R$ $1\cdot 750 \text{ ,,}$	$\cdot 125 R + \cdot 332 \div R$ $\cdot 125 \text{ ,, } + \cdot 332 \text{ ,,}$ $\cdot 1875 \text{ ,, } + \cdot 498 \text{ ,,}$	0 $0\cdot 143 \div R$ $0\cdot 570 \text{ ,,}$	Do.
$N=12 \begin{cases} \mu \\ \mu'' \end{cases}$	$\cdot 125 R + \cdot 331 \div R$ $\cdot 125 \text{ ,, } + \cdot 331 \text{ ,,}$ $\cdot 1875 \text{ ,, } + \cdot 496 \text{ ,,}$	0 $\cdot 331 \div R$ $2\cdot 029 \text{ ,,}$	$\cdot 125 R + \cdot 332 \div R$ $\cdot 125 \text{ ,, } + \cdot 332 \text{ ,,}$ $\cdot 1875 \text{ ,, } + \cdot 499 \text{ ,,}$	0 $0\cdot 146 \div R$ $0\cdot 584 \text{ ,,}$	Do.
$N=14 \begin{cases} \mu \\ \mu'' \end{cases}$	$\cdot 125 R + \cdot 332 \div R$ $\cdot 125 \text{ ,, } + \cdot 332 \text{ ,,}$ $\cdot 1875 \text{ ,, } + \cdot 497 \text{ ,,}$	0 $\cdot 332 \div R$ $2\cdot 298 \text{ ,,}$	$\cdot 125 R + \cdot 338 \div R$ $\cdot 125 \text{ ,, } + \cdot 333 \text{ ,,}$ $\cdot 1875 \text{ ,, } + \cdot 500 \text{ ,,}$	0 $0\cdot 149 \div R$ $\cdot 596 \text{ ,,}$	Do.
$N=16 \begin{cases} \mu \\ \mu'' \end{cases}$	$\cdot 125 R + \cdot 332 \div R$ $\cdot 125 \text{ ,, } + \cdot 332 \text{ ,,}$ $\cdot 1875 \text{ ,, } + \cdot 498 \text{ ,,}$	0 $\cdot 332 \div R$ $2\cdot 568 \text{ ,,}$	$\cdot 125 R + \cdot 333 \div R$ $\cdot 125 \text{ ,, } + \cdot 333 \text{ ,,}$ $\cdot 1875 \text{ ,, } + \cdot 500 \text{ ,,}$	0 $0\cdot 151 \div R$ $\cdot 606 \text{ ,,}$	Do.

Note.—This table does not include any weight of metal in the towers which may be either of iron or of masonry.

Example.—To illustrate the application of the tables, we may take the case of a bow-and-chain girder, constructed as in Fig. 217, for a single line railway bridge of 500-foot span, and with a depth equal to $\frac{1}{8}$ th of the span. The suspended roadway, whose weight will form part of the useful dead load p , will be heavier than in the case of the Ohio bridge, although the wind bracing may be nearly the same in both structures. For the present purpose we may assume that the platform will be constructed as in the Saltash bridge, the roadway being carried between a pair of longitudinal girders 8 feet in depth, and its weight per foot will then be greater than the weight of the corresponding ironwork in the Ohio bridge by about 0.1 ton, or possibly 0.15 ton. We shall therefore take the weight of platform, permanent way, and wind bracing at $p = 0\cdot 55 + 0\cdot 15 = 0\cdot 70$ ton per foot.¹

In regard to the coefficient for waste of material, we may assume that all the tension members except the vertical suspenders will be composed of eye-bars, for which $\kappa = 1\cdot 33$ and $\gamma = \cdot 0003$. But some portion of the

¹ For the sake of comparison we have here assumed the flooring (between the roadway girders) to be constructed as lightly as in the Ohio Bridge; although, in fact, the floor of the Saltash Bridge is heavier, and is, moreover, heavily ballasted; so that the case assumed does not coincide with the Saltash Bridge in regard to the useful load.

suspenders will be used as stiffeners, and therefore we shall take for all these members $\kappa = 2.66$ and $\gamma = .0006$.

The main compression boom will have a nearly uniform section, and in such a member we may take $\kappa = 1.60$ and $\gamma = .00045$, these values being exclusive of any overhead wind bracing connecting the upper members. For the vertical posts we have just seen that $\kappa = 2.50$ on the average, so that $\gamma = .0007$; and finally we shall take the rolling load at $q = 1$ ton per foot in accordance with English practice.

Then referring to the values of μ , μ' , and μ'' given in Table 11 for a girder of 10 panels, in which $R = 8$; and multiplying by the coefficient γ proper to each set of members, we have

$$\begin{aligned} \Sigma \gamma \mu &= .000,7811 \\ p \Sigma \gamma \mu' &= .000,8206 \times 0.7 = .000,5744 \\ q \Sigma \gamma \mu'' &= .001,5609 \times 1.0 = .001,5609 \\ &\hline & .002,1353 \end{aligned}$$

Therefore the weight of the main structure per foot will be—

$$\frac{500 \times .002,135}{1 - (500 \times .000781)} = 1.75 \text{ tons.}$$

This calculation does not include the weight of the platform; and therefore in order to compare it with the weight of a parallel girder we must add the excess of ironwork required in the platform, amounting to 0.1 or 0.15 ton per foot, which would bring the total weight of ironwork to 1.85 or 1.90 tons per foot, as against 1.80 tons in the Ohio bridge. But it must be remembered that we have here designed the bow-and-chain bridge for a heavier rolling load; and if all the conditions were equal there would be very little difference in the economy of the two forms of construction.

With the aid of Tables 9 and 10, the reader may easily compare the weight of an upright or inverted bowstring of the same span and depth, or the weight of either type when constructed with different ratios of span to depth. If we repeat the above calculation for an inverted bowstring of the same span and depth, we shall find the weight of the main structure to be 1.78 tons per foot, or nearly the same as in the bow-and-chain bridge; while the weight of the inverted bowstring for a span of 500 feet and a depth of 50 feet will be about 2.40 tons per foot.

220. Limiting Span.—Adhering to the proportions of the girder shown in Fig. 217, the limiting span would be reached when $L \cdot \Sigma \gamma \mu = 1$, *i.e.*, when $L = \frac{1}{\Sigma \gamma \mu} = \frac{1}{.000781} = 1280$ feet. But, as before remarked, this would only be true on the assumption that γ does not rise in value when the dimensions are doubled. In the vertical posts the coefficient would probably increase, but that increase would make very little difference in the limiting span, because the only quantity affecting that question is the

weight of metal required to carry the main girders, and for this purpose the verticals hardly come into action at all.

The fact that it is possible to construct a parabolic girder of wrought iron that would carry its own weight across a span of 1280 feet with a depth of $\frac{1}{8}$ th of the span, indicates that for spans greater than 500 feet this form of construction would be considerably more economical than the parallel girder; and this advantage would be still further increased if a larger depth were chosen.

221. Economic Construction.—To a great extent the economic construction of the bowstring will depend on the same conditions as those mentioned in the case of parallel girders. In bridges of moderate span the weight of the girder will be more largely affected by the character of the details than by the choice of bracing or of general arrangement; while the relative weight of the bowstring and the straight girder will also depend upon the same question so long as the usual proportions of depth to span are adhered to in both cases. But it must be remarked that the weight of the parabolic girder may sometimes be greatly reduced by adopting a more liberal depth.

222. Economic Proportions.—In most of the large parabolic girders that have been hitherto erected the depth is about $\frac{1}{8}$ th of the span, and for bridges of moderate span these proportions may perhaps be nearly as good as any other; but in very wide spans economy becomes a much more important question, and here there can be little doubt that the parabolic girder would exhibit a great economic advantage if designed with a greater depth.

In this respect the bowstring offers a remarkable contrast to the straight girder. The products B or $\Sigma\gamma\beta$, for vertical stress \times vertical height are very small in comparison with the products A or $\Sigma\gamma\alpha$ for horizontal stress \times horizontal length; and if we apply the same formula, Economic $R = \sqrt{\left(\frac{B}{A}\right)}$, on the assumption that γ is independent of the depth, we shall find that the bowstring ought theoretically to be constructed almost in the form of a semicircle or of an inscribed polygon.

In the tension-members, γ is practically independent of the depth; and if the upper flange or bow is supported at short intervals, the value of γ in this member will not be sensibly affected by the depth, so that the only considerable variation in that coefficient will be in the vertical posts.

If for the latter members we take a coefficient for excess of material, $\kappa = 2.0$, we shall find the economic depth to be about one-third of the span.

For such an enormous height, it is certain that the excess of metal in the vertical posts would have to be much greater in order to adapt them to act as stiffeners; but if for this purpose we multiply their section by 3, thus making $\kappa = 6$, we shall still find that the economic depth is nearly equal to $\frac{1}{8}$ th of the span.

With a depth of $\frac{1}{8}$ th of the span, and with a factor of safety equal to

3, we have seen that the limiting span of the bow-and-chain bridge is about 1280 feet; which would be reduced to 960 feet if the factor of safety is taken at 4 (for a load which is entirely dead load). But if the depth can be increased to $\frac{1}{4}$ th of the span, the limiting span, with the larger factor of safety, will theoretically be increased to about 1600 feet, or twice that of the parallel girder.

We say theoretically, because the calculation, like most others of the same kind, is really based upon artificial assumptions; some of which would not hold good in the case of such an extravagant span. In practice, one of the chief questions would be as to the amount of metal required in stiffeners and transverse bracing to resist wind pressure, and this would certainly increase with the depth of the girder.

Without going into this question in detail, we may safely conclude that for parabolic girders of very large span, the depth should certainly be far greater than $\frac{1}{8}$ th of the span; and that the economy of the bridge will thereby be very considerably enhanced. But for such spans the exact value of the economic depth can only be determined by including the whole question of wind-pressure; and on this will depend the weight of the girder, and the real value of the limiting span.

223. Curved Girders.—Intermediate between the parallel and the parabolic forms of outline, we may have girders of various designs distinguished by the general characteristic that the central depth is made larger than the depth at the ends. Thus the upper flange may have a parabolic outline, as in Fig. 219 (Plate J), the depth at the centre being perhaps twice as great as at the ends; and the girder might then be regarded as a mean between the parallel and the parabolic forms. With a given depth at the centre, the flange stress at that point will of course be the same as in either of the other forms; and the shearing stress in the centre of the web, due to the live load, will also be the same. But at each end of the girder the stress in flanges and web will occupy a mean position between those of the other forms.

When the depth of the girder at each panel-point has been fixed, all the stresses can readily be found by the methods already described, which will apply to any form of girder supported at each end. It is therefore unnecessary to work out the results for any particular outline of girder, as this may be arbitrarily varied in a number of different ways.

In point of economy, we may take it that the weight of the girder shown in Fig. 219 will not differ widely from the mean between the weights of a parallel girder and a bowstring having the same central depth; supposing, of course, that the details are of the same kind in each.

The largest span of the Kulemburg viaduct is constructed nearly in the form shown in Fig. 219, and has a clear span of 492 feet, so that the effective span is only a few feet less than that of the Ohio bridge already mentioned; while the total length of the girders is almost exactly the same, or 515 feet in both bridges.

The bridge is constructed for a double line, and the main girders

PARABOLIC GIRDERS.

Plate. J.

Fig: 215.

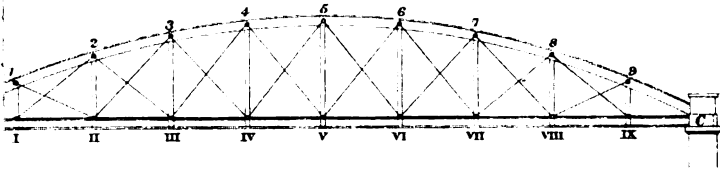

Fig: 216.

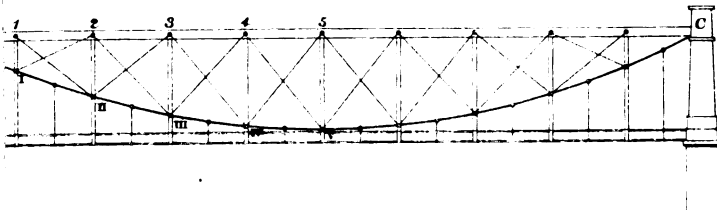

Fig: 217.

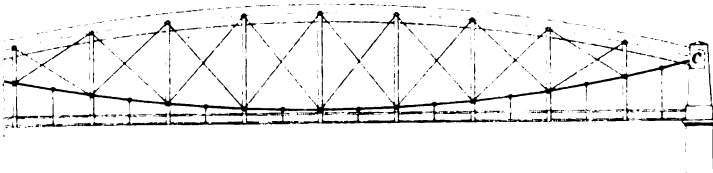

Fig: 218.

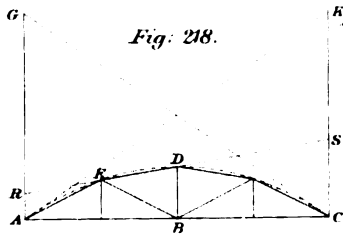
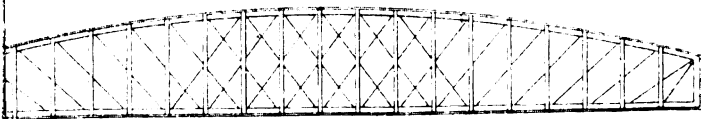

Fig: 219.





weigh 1786 tons; while the total weight of ironwork in the span is 2234 tons. Mr. T. C. Clarke has calculated¹ that the Ohio bridge, if constructed for the double line, would weigh 1626 tons in all, or in other words that the Kuilemburg bridge is 37 per cent. heavier than the American example. But there can be no doubt that this excess of weight is due—not to the general form of the design but to the character of the details, which are composed throughout of rivetted plate ironwork of the same class as in the other spans of the Kuilemburg viaduct. We have already seen in Art. 211 that if the Ohio design had been carried out with such details, the girders would have been just 36 per cent. heavier; so that there remains only a doubtful quantity of 1 per cent. as attributable to any difference in the general design.

Various other forms of curved girder have been proposed, approximating more nearly to the parabolic outline. Some of these have aimed at securing a uniform direct stress in all the members of the polygon, or a uniform stress in all the diagonals of the web; but if either of these objects is obtained the stress will no longer be uniform throughout the straight tie, as this can only occur (under a uniform load) when the parabolic outline is adhered to.

¹ Vide *Proceedings of the Institution of Civil Engineers*, vol. liv.

CHAPTER XIX.

SUSPENSION BRIDGES AND ARCHES—FLEXIBLE CONSTRUCTION.

(The illustrations referred to in this chapter are contained in Plate K at the end of Chapter XXII.)

224. Curve of Equilibrium.—It has already been shown that a load distributed in any given manner may be carried by an equilibrated chain or funicular polygon of a certain figure, or by an equilibrated arch of the same figure; and that the figure which must be given to the arch or chain for this purpose depends upon the distribution of the load, and is in fact none other than an upright or inverted reproduction of the diagram of moments for that particular distribution of the load.

In Chapter IV. we have examined the various forms assumed by the diagram of moments under different loads; and the figure of the equilibrated arch or chain for any given load may therefore be readily constructed by the methods described in that chapter.

Thus, for example, if the load is uniformly distributed along the horizontal roadway, the arch or chain must have the figure of a parabolic curve or of a parabolic polygon according as the load is suspended to the chain at very short intervals or at intervals of considerable width. The arch or chain will therefore have the same figure as in the bowstring or inverted bowstring of Figs. 215 and 216, and if from those Figs. we remove the straight chord and the whole of the web-bracing, we shall have remaining a linear arch or a suspension chain which will be in equilibrium under the uniform load; and the stresses in these members will be exactly the same as when they formed part of the parabolic girder.

But when a train crosses the bridge, the distribution of the load is continually changing, and if the flexible chain or arch is to support the load in each changing position, its curve must be altered for each new position of the load, and must always correspond with the diagram of moments for the actual position of the load at the time being. Thus in Fig. 220 (Plate K), suppose that the half span AB is covered with a uniform load, while the remaining half BC is without any load at all. Then the diagram of moments or curve of equilibrium will consist of a parabolic curve AdB and a straight line BC . Or again, if the half span BC is covered with the dead load of intensity p , and the remaining half AB with a load of greater intensity $p + q$, the curve of moments or curve

of equilibrium will occupy an intermediate position, and will consist of two parabolic arcs Ad_1B , and Be_1C ; and whatever may be the ratio of $p+q$ to p , the vertical dips d_1d_2 and e_1e_2 will be in the same proportion.

If the load is moved from the left to the right half of the span, the curve of moments will of course be reversed (left to right), as shown by the dotted curves of the figure.

In order that the structure may carry this unequal load as an equilibrated chain or arch, its figure must be distorted in the manner shown in the diagram.¹ In the suspension bridge the more heavily loaded portion must be depressed and the lightly loaded portion must be elevated; while in the arch the process must be reversed,—the heavily loaded part must be elevated, and the lightly loaded part must be depressed.

For this reason the suspension chain is always in stable equilibrium, while the linear arch is always in unstable equilibrium. That is to say, if the equilibrated load changes its position in the slightest degree, it will produce in each of these flexible members a bending stress which neither of them is able to resist, and to which they immediately yield; but the resulting distortion in the case of the chain reduces and quickly annuls the bending stress, while in the case of the arch the distortion increases the bending stress; so that the slightest disturbance of equilibrium is sufficient to destroy the linear arch, while the flexible suspension chain will always adapt itself to the load, however great may be the changes in its distribution.

The same comparison holds good in regard to *any* distortion of the two structures, whether that distortion takes place in the main plane of the structure, or in the horizontal plane, or in the vertical transverse plane, and whether it be due to lateral wind pressure or to the buckling tendency, or to inequality of loading. It is hardly necessary to say that there is no reason for constructing an arch in this flexible and perilously unstable form, while it is equally unnecessary to adopt a flexible construction for the suspension bridge; but the above comparison shows that on all grounds it is more feasible to construct a rigid suspension bridge than to construct a rigid arch.

In order to withstand the slightest inequality of loading or the slightest wind pressure, it is absolutely necessary that the arch should be stiffened. The same necessity does not exist in the case of the suspension bridge; but here also rigidity is required if we wish to prevent the distortion from reaching inconvenient proportions.

If we determine to prevent such distortions from taking place at all in either structure, we shall find that the bending moments which have to be resisted are the same in both, and that they may be met by the same arrangements in the suspension bridge as in the arch, and that in both structures it is not difficult to obtain a rigidity which is greater

¹ The chain will not occupy exactly the series of positions shown in the diagram, because, its length being unaltered, the central dip DB will be slightly changed for each new position; but in all cases the line of the chain will consist of two portions whose form and relative deflections will be as described.

than that of the girder ; but the suspension bridge will always possess the advantage that a tie possesses as compared with a strut, *viz.*, the advantage that is derived from stable equilibrium.

In the present chapter, however, we have to consider the flexible form of construction, which has commonly been adopted in chain bridges from time immemorial.

225. The Common Chain Bridge.—We have seen that if the load is uniformly distributed, the chain will lie in a parabolic curve ; and in practice the chain will generally coincide more nearly with that figure than with any other geometric curve ; although it will depart slightly from the parabolic form on account of the inequality in the weight of the chain and suspenders, which is greater at the ends than at the centre of the span.

If the chain were of uniform section throughout, which it ought not to be—and if it carried no load beyond its own weight, which is not the case in practice—the curve of equilibrium would be the “catenary.” The mathematical properties of this curve are given in many text-books ; but they have little or no application to the practical construction of suspension bridges. They are, in fact, only true for a certain hypothetical distribution of load which never occurs in practice, *viz.*, a load consisting solely in the weight of a chain of uniform section. But if such a chain carries a horizontal platform of uniform weight, its curve will depart from the catenary and approximate to the parabola ; and the more heavily the platform is loaded the more nearly will the curve coincide with the parabola.

The exact curve of the chain for any given case may be found by tracing the inclinations of the successive links, starting from the centre of the span, and estimating the total weight of the structure between the link in question and the centre of the span. If W denotes that weight, and θ the angle of inclination of the link, we shall have $\tan. \theta$ proportional to W .

In all cases the curve will coincide with the diagram of moments ; and if M denotes the moment of the whole load at the centre of the span and D the central deflection or dip of the chain, the horizontal stress at the centre will be $H = \frac{M}{D}$, which will of course represent the horizontal component of the tensile stress in every link of the chain.

For the present purpose, and perhaps for most ordinary purposes, we may assume that the total dead load is uniformly distributed along the span ; and if p denotes its weight per foot we shall have—

$$H = \frac{pL^2}{8D}. \quad . \quad . \quad . \quad . \quad . \quad . \quad . \quad (1)$$

The direct stress in any inclined bar of the chain or backstays will of course be equal to $H \sec. \theta$, and may be geometrically measured as described in Art. 217.

226. Determination of Sectional Areas.—As regards the effect of stress variation, it may be remarked that those changes in the bending moment which accompany the passage of the rolling load across a girder bridge are translated into changes of form and not so much into changes of stress in the suspension chain; so that in every link the stress would perhaps change very gradually between S_p and S_{p+r} . But it is difficult to estimate what local excess of stress may occur during the oscillations of the chain; and for that reason it will probably be well to make as full an allowance for the effects of stress-variation in the chain as in the flanges of a girder.

In the vertical suspenders we may assume, as before, that the rolling load coming upon each suspender is twice as great as the normal panel load, and is equivalent to a load suddenly applied.

227. Weight of the Chain Bridge.—Adopting therefore the same method of computing the sectional areas for dead and live load respectively as in the case of girder bridges, we shall have the following coefficients μ , μ' , and μ'' as applicable to the chain and suspenders of the common suspension bridge.

TABLE 12.—*Weight of the Common Chain Bridge.*—Fig. 225.

No. of Suspenders.	Tension Members.	
	Chain.	Vertical Suspenders.
N very large $\left\{ \begin{array}{l} \mu \\ \mu' \\ \mu'' \end{array} \right.$	0.125 $R + .666 \div R$	0.
	0.125 „ + .666 „	0.33 $\div R$
	0.1875 „ + 1.000 „	1.33 „

Then if p denotes the ascertained weight per foot of the platform and wind-bracing, and q the rolling load per foot lineal, the weight of the chains and suspenders in tons per foot will be $w = \frac{L(p\Sigma\gamma\mu' + q\Sigma\gamma\mu'')}{1 - L\Sigma\gamma\mu}$.

This does not include the backstays or side spans, nor does it include the towers or end pillars; but these portions of the structure can easily be worked out independently, and their weight will depend in each case upon the varying features of the general design.

The coefficient for waste of material in the chains is not greater than $\kappa = 1.2$ to 1.25, or $\gamma = .00027$ to .00028.

228. Changes of Temperature.—If the temperature of a bar of iron is raised from the freezing to the boiling point, *i.e.*, through 180° Fahr. or 100° Cent., its length is thereby increased by $\frac{1}{80}$ th per cent. or by $\frac{1}{800}$ th of its original length λ . The elongation $\Delta\lambda$ due to any given range of temperature ΔT can therefore be easily calculated.

If the chain of a suspension bridge is thus elongated by any rise of

temperature, while the span of the bridge remains unaltered, the dip of the chain will of course be increased, and the consequent deflection or depression of the roadway in the centre of the span may easily be found as follows:—

Let l = the half span AD (in Fig. 225).

D = the central dip of the chain DB .

λ = the length of the semi-parabola AB measured along the curve.

Then by the properties of the parabola—

$$\lambda = \sqrt{l^2 + \frac{4}{3}D^2}$$

and—

$$D = 0.866 \sqrt{\lambda^2 - l^2}$$

Now if the length of the half chain is increased by $\Delta\lambda$ we shall have the increased dip of the chain—

$$D + \Delta D = 0.866 \sqrt{(\lambda + \Delta\lambda)^2 - l^2}$$

In England the observed expansion of iron structures from their coldest length appears to be about $\Delta\lambda = \frac{\lambda}{2400}$, corresponding to an effective range of temperature of about 60° Fahr. But in America, and indeed in most foreign countries, the range of temperature is considerably greater, and a range of 100° to 150° is commonly provided for.

The cables of the Cincinnati suspension bridge have a span of 1057 feet and a dip of 89 feet at mean temperature; but the dip varies by as much as two feet between the summer and the winter. This variation, however, is partly due to the expansion of the side spans, which is of course attended with a horizontal motion of the saddles upon the summit of each pier, so that the central span L is reduced, while the length of the central cables is at the same time increased.

Suppose each side span to consist of a semi-parabola whose horizontal length is l_1 and whose vertical rise is D_1 ; then the length of that semi-parabola being $\lambda_1 = \sqrt{l_1^2 + \frac{4}{3}D_1^2}$, the horizontal motion of the saddle due to any elongation $\Delta\lambda_1$, will be given by the necessary increase of l_1 , which is now augmented to $l_1 + \Delta l_1 = \sqrt{(\lambda_1 + \Delta\lambda_1)^2 - \frac{4}{3}D_1^2}$.

Whatever may be the length or form of the side spans, let Δl_1 represent the horizontal motion of the saddles due to the expansion of the side chains; then the central span being reduced by $2\Delta l_1$, the augmented dip of the chains at the centre of the span will be

$$D + \Delta D = 0.866 \sqrt{(\lambda + \Delta\lambda)^2 - (l - \Delta l_1)^2}$$

The stress in the chains should of course be calculated for the lowest temperature and least dip.

229. Limiting Span.—If we take the dip of the chain, at the coldest temperature, to be fixed at $\frac{1}{10}$ th of the span, which corresponds with the proportions of the Clifton suspension bridge, we shall have $R = 10$, and

$\mu = 1.25 + 0.066 = 1.316$. Therefore taking 3 as the real factor of safety, the limiting span of the wrought iron chain bridge will be

$$L = \frac{1}{\Sigma \gamma \mu} = \frac{1}{1.316 \times .00027} = 2800 \text{ feet.}$$

Or if we take 4 as the factor of safety, and a working stress of 5 tons per square inch under a dead load, the limiting span will be

$$L = \frac{3}{4} \times 2800 = 2100 \text{ feet.}$$

But we have here given the wrought-iron chains credit for an ultimate strength of 20 tons per square inch only; a strength which is very commonly exceeded in rolled bars; and if a stronger material is adopted, the limiting span will be proportional to the working stress.

230. Economic Proportions.—As in the case of the parabolic girder, the economy of the chain bridge, and its limiting span, may be greatly increased by adopting a more liberal depth. Thus if we take $R=8$, the limiting span, with a working stress of 5 tons per square inch, will be increased to 2560 feet; and if we adopt a depth equal to one-fourth of the span, the limiting span will be theoretically increased to 4160 feet.

But in practice it is impossible to adopt the most economic proportions or anything like them, because the greater the dip of the chain the greater will be the distortion produced by the rolling load, and the greater will be the oscillations attending its passage across the bridge. The oscillations that have already been noticed are liable to be augmented by two or three other causes. If the bridge is constructed with side spans similar to one-half of the central span, any excess of load upon the central span will straighten the chains of the side spans and produce a horizontal motion of the saddles, attended with a further depression of the central chains. In addition to this it may be remarked that the opposing vertical forces at any point of the roadway are balanced in a very sensitive manner, and it is consequently easy to produce a considerable oscillation by the repeated application of a very moderate force, if the time-interval corresponds with the natural period of vibration of the chain. In this way the wind has been known to raise waves in the platform of a suspension bridge like the waves of the sea.

These reasons have contributed to limit the proportions adopted in practice, and a tolerable degree of steadiness has been attained by stretching the chains to a flat curve. In most of the existing examples the dip does not exceed $\frac{1}{10}$ th of the span, and in many cases a depth of $\frac{1}{12}$ th to $\frac{1}{15}$ th has been adopted with advantage—so far as stability is concerned, but of course with a considerable sacrifice of economy.

As a means of carrying a uniformly distributed load over a wide span, the flexible suspension bridge is probably the most economical form of construction possible; and even with the inefficient proportions above mentioned, its economy and facility of erection have given it a great advantage over any of the forms of girder hitherto considered.

Suspension bridges of 700 and 800 feet span were long ago erected in Europe ; and in America several bridges have been constructed upon this principle of 1000 feet span and upwards ; while the Brooklyn Bridge, of 1600 feet span, is at this moment the widest of all existing bridges.¹ But the flexible suspension bridge is always under the disadvantage that it can only offer a yielding support to the roadway, and we have now to examine some of the various methods by which it may be either stiffened or rendered rigid in itself.

As compared with the flexible suspension bridge, the linear arch, which is its correlative, has the disadvantage that it is an utterly impracticable structure ; but the methods which are applicable for stiffening the one are equally applicable to the other.

¹ The Forth (Cantilever) Bridge, of 1700 feet, is now in course of construction.

CHAPTER XX.

SUSPENSION BRIDGES AND ARCHES—RIGID CONSTRUCTION.

(The illustrations referred to in this chapter are contained in Plate K at the end of Chapter XXII.)

231. Conditions to be Fulfilled.—To prevent or to moderate the oscillations of a flexible suspension bridge, a great number of expedients have been proposed, of the class which may be described as palliative measures, such as a partial stiffening of the roadway, aided perhaps by the introduction of inclined ties, or by the use of stays or guys by which the chains are moored in all directions; but these methods have never succeeded in producing that degree of solid rigidity which is essential for the purposes of rapid and heavy railway traffic, and which is easily obtainable in any good form of girder. The rigidity of a girder bridge is due to the employment of certain definite and obvious means, and the same degree of rigidity can only be obtained in the arch or suspension bridge by the use of the same means—that is to say, the structure must be so designed that no deflection can possibly be produced by the rolling load, except such as is due to the elasticity of the material; and the proportions must be so designed that the deflection due to that unavoidable cause is no greater than in a girder. Accepting this as an essential condition, we may omit any reference to a great number of those half measures which have been proposed from time to time; and we must proceed to design the structure, not as a flexible erection which requires to be stiffened by some auxiliary expedients, but as a rigid structure which cannot be sensibly distorted except by breaking it.

Proceeding on these lines we shall find that in theory it is possible to construct a bridge with any required degree of rigidity by using the linear arch or linear chain, together with a roadway girder of the proper stiffness; but in practice, as well as in theory, the rigidity can be more easily and more certainly obtained by designing the arch or suspension rib as a deep and stiff girder. But whichever of these methods is selected, the bending stresses to be provided for, and the conditions to be observed in regard to temperature changes, are very similar and indeed almost identical in both; while they may perhaps be most easily studied by taking first the case of the rigid roadway girder supported by a flexible arch or flexible suspension chain.

In either case we have to provide for certain bending stresses which are produced by the unequal distribution of the rolling load, and these bending moments are the same whether they are resisted by the inherent stiffness of the arch, or by the stiffness of an auxiliary roadway girder.

In either case, also, we have to provide for a certain rise and fall at the crown of the arch due to changes of temperature.

The arched rib or the horizontal roadway girder may be made in either of the following forms:—

1. Rigidly fixed at each end.
2. Hinged at each end.
3. Hinged also in the centre.
4. Hinged near one abutment.

Whichever of these methods is adopted, the bending stress due to the unequal distribution of the rolling load will be the same in the horizontal roadway girder as in the arched rib or in the suspension bridge; while the stresses due to change of temperature will be very similar whether the roadway or the arch is constructed in rigid form.

232. Flexible Arch or Chain with Rigid Roadway.—In the first place we will suppose that the roadway girder of Fig. 225, Plate K, is to be made in one length from a to c , and suspended to the chain or supported upon the arch by numerous vertical rods or columns spaced at short intervals.

The girder will be made quite straight, and at mean temperature it will lie in a straight line, and its weight as well as that of the uniform dead load will be carried entirely by the parabolic arch or chain.

But if the temperature is now raised by the quantity ΔT , the original versine of the arch or chain will be increased to $D + \Delta D$, and the girder must consequently be deflected upwards or downwards by the amount ΔD —upwards in the case of the arch, and downwards in the case of the chain bridge. Thus if the original versine D was $\frac{1}{10}$ th of the span, we find by reference to Art. 228, that a rise of temperature of 60° would increase the length of the parabolic arch by $\frac{1}{2400}$ th, and would increase the versine by nearly 0·8 per cent., so that the upward deflection of the girder would be nearly equal to $\frac{1}{1200}$ th of its length; and a similar downward deflection would ensue if the temperature were lowered by 60° .

In addition to this we must remember that the arch will be compressed when the live load comes upon it, and if the stress due to that load amounts to 2 tons per square inch, the arch will be shortened by $\frac{2}{12 \cdot 000}$ ths of its length, producing a further deflection of the girder amounting to $\frac{4}{12 \cdot 000}$ ths of the span; or a total deflection (due to both causes together) of $\frac{1 \cdot 4}{12 \cdot 000}$ ths of the span.

Now if we refer to Art. 91, we see that a flange stress (in the girder) of 1 ton per square inch will be attended with a deflection equal to $\frac{5}{24} \frac{L^2}{D_1 E}$ in which D_1 is the depth of the girder, and E the modulus of elasticity.

Therefore denoting the ratio $\frac{L}{D_1}$ by R_1 , the deflection produced by a flange stress of 1 ton per square inch will be $\frac{5}{24} R_1 \times \frac{L}{12,000}$; or if we make the depth of girder equal to $\frac{1}{24}$ th of the span, the deflection will be equal to $\frac{5}{12,000}$ ths of the span for every ton per square inch; and the girder will consequently suffer a stress of two tons per square inch in accommodating itself to the fall of temperature, without the insistence of any live load at all; while the flange stress will be still further increased owing to the further depression of the arch under the live load.¹

The strength of the girder which remains available for doing its own proper duty is therefore reduced to about one-half; and it is obvious that it would be still further reduced if a more substantial proportion of depth to span were chosen. In the case of the suspension bridge these effects will be further augmented by the elongation of the backstays or side spans, and the deflection and stress of the roadway girder will consequently be $1\frac{1}{2}$ or 2 times the amount above calculated. It is evident, therefore, that a rigid bridge cannot be constructed upon this principle except at the cost of a large expenditure of useless metal in the girders.

The deflection and the resulting useless stress in the girder is nearly proportional to the ratio $\frac{D_1}{D}$; and the best results would be attained by making the rise of the arch D very large in proportion to the depth of girder D_1 .

233. Roadway Girder Fixed at the Ends.—We have hitherto supposed that the roadway girder is hinged at each end, or at all events is supported upon the abutments (like any other girder) in such a way as to admit of its deflecting freely; but if the girder is fixed in direction at each end, its deflection will be like that of a continuous beam, and it will take twice as much stress as before in order to make it assume a given deflection in the centre. The difficulties mentioned above will therefore be greatly increased by fixing the girder rigidly at each end, and in practice this would never be done. The question is only of interest because it represents exactly the difficulties that occur when a rigid arched rib is fixed in direction at the ends.

234. Roadway Girder Hinged at the Centre.—The difficulties above mentioned are entirely removed if the girder is hinged in the middle as in Fig. 226, so that the joint can rise and fall with the changes of temperature. To introduce this central hinge will in fact be only in accordance with the practice which is followed in all other kinds of iron construction—viz., that of making due allowance for expansion and contraction. In the girder bridge this must be done by carrying the ends upon rollers; but in the arch the span is an unalterable quantity, and as

¹ To find the exact stress in the flanges, it will be necessary to remember that the elastic resistance of the deflected girder will relieve the arch of a part of its load.

the structure cannot expand in that direction, its expansion must be allowed for in the rise of the arch. The slight distortion in the line of the roadway which takes place with any change of temperature, will not be appreciably *increased* by the introduction of the central hinge; for whether the hinge is introduced or not, the arch will certainly rise and fall in obedience to the changes of temperature; and that this distortion is attended with no serious results is proved by the fact that no such results have been experienced in any of the hinged or unhinged arches which already exist in great numbers and of all spans up to 500 feet.

The central hinge will also give us the further advantage that we can now make the girder or rib as deep as we please, and can thus secure any desired degree of rigidity; while the stresses will become clearly defined and are easily ascertained.

We have already found that the greatest distortion of the curve of moments, or the greatest distortion of the flexible suspension chain, takes place as in Fig. 220, when one-half of the span is covered with the rolling load.

In Fig. 226 let the whole span be covered with the dead load of intensity p , and let the half span ab be covered also with the live load of intensity q . Then the total load on the bridge will be $L(p + \frac{q}{2})$.

If the girders are sufficiently rigid, the parabolic curve of the arch or suspension chain will not be sensibly distorted, and consequently the load transferred to the chain by the suspenders must of necessity be uniformly distributed over each foot of the entire span; so that the suspenders will exert upon the roadway girders a uniformly distributed supporting force equivalent to $(p + \frac{q}{2})$ per foot lineal. It follows that the girder ab will be subjected to an unbalanced load of $\frac{q}{2}$ per foot lineal (uniformly distributed); while the girder bc will be subjected to an unbalanced supporting force of equal intensity applied by the vertical suspenders.

To meet these bending stresses, each girder must be designed as an independent girder of the span $l = \frac{L}{2}$, subjected to a uniform load whose intensity is $\pm \frac{q}{2}$; and as each girder will be subject to alternate upward and downward bending stresses, every member must be designed to act as a strut in which the stress varies from a certain maximum compression to an equal maximum tension, so that the working stress ought not to be greater than about 2.0 tons per square inch.

The bending moments at different parts of the roadway girders, due to this unequal distribution of load, are represented by the parabolic curves asb and bsc in Fig. 227; and if m denotes the horizontal distance of

any joint from the central hinge *B*, the bending moment will be expressed by

$$\pm M = \frac{qm(l-m)}{4} \dots \dots \dots (2)$$

In the centre of each girder, this becomes

$$\pm M = \frac{ql^2}{16} \dots \dots \dots (3)$$

The roadway girders must evidently be held down at the abutments as well as supported, because the ends would otherwise rise under certain positions of the load ; and the girders may either be formed of uniform depth, or as parabolic bowstrings, in which the horizontal flange stress would be uniform throughout.

In some text-books it has been stated that the values of the bending-moment as above given are the *maximum* for any position of the rolling load ; but this is not quite accurate, and if successive positions of the load are analysed, it will be found that the greatest bending moment at any point in the girder is given by

$$\pm M = \frac{qm(l-m)}{4} \left(1 + \frac{m}{2l+m} \right) \dots \dots \dots (4)$$

These values are represented by the dotted curves *as₁b* and *bs₁c* in Fig. 227.

The design we have here considered is not by any means an economical one, because the duty of carrying the rolling load is to a great extent performed twice over, once by the arch or chain, and once again by the roadway girders. The chain must be made strong enough to carry the *whole* load, just as if it formed part of an inverted bowstring ; but in the bowstring girder it supports the rolling load in *any* position without any further increment of stress ; while in the present design we have to provide for the unequal distribution of weight by adding a pair of girders which if put together would be more than sufficient to carry the load across one half of the span without any aid from the chain. Thus for a span of 1000 feet we should have to provide roadway girders of sufficient strength to carry the rolling load across 500 feet, and then to provide chains capable of carrying the whole load (including the great weight of the girders) across the span of 1000 feet.

235. Arched Rib or Suspension Rib, Hinged at the Centre.—Instead of employing a flexible arch or chain with a rigid roadway, it is in every way more advantageous to make the curved rib rigid in itself. By this means a degree of rigidity can be obtained which is greater than that of the girder bridge ; and as the functions of arch and of roadway girder are performed by the same member, the waste of material that was observed in the duplex system, last described, may be entirely avoided. The rib, acting as arch or chain, will be subject to a certain horizontal stress *H* ; while, in addition to this, it will have to bear (as girder) an occasional

bending stress or flange stress $\pm H_m$. To carry the whole uniform load the sectional area of the rigid arch or suspension rib need be no greater than that of the flexible arch or chain; and if suitable proportions are adopted this sectional area will be sufficient, or nearly so, to resist all the bending stresses that occur during the passage of the rolling load; i.e., it will be sufficient to resist the total stress $H + H_m$.

The rib will of course consist, like any other girder, of an upper and a lower member united either by a plate web or by diagonal bracing. Its depth must be great enough to insure the requisite degree of rigidity; and it may either be made with a uniform depth throughout as in Fig. 224, or the depth may be proportioned to the bending moment as in Figs. 228 and 223A, thus giving to each half rib the form of a parabolic girder or nearly so.

The last named method is by far the better of the two, and the parabolic ribs possess not only the advantage of greater stiffness, but also the economic advantage above described, viz., that the united sectional areas of the upper and lower members need be no greater, or very little greater, than that of a single flexible chain or arch designed to carry the same total load; and having this sectional area they will resist the bending action of the unequal load without suffering any further or greater stress.

To illustrate this point, let the rigid suspension bridge of Fig. 223 be constructed with two parabolic semi-ribs AB and BC , hinged together in the centre, and let the central depth OP of each semi-rib be equal to half the dip DB . Then the outline of each rib will consist of a straight line AB , and a parabolic curve AoB ; to which curve the straight upper member BC will form a tangent; while the neutral axis of the rib, or the line which everywhere bisects its vertical depth, will be a continuous parabolic curve passing through A , B , and C .

Let D denote the central dip DB of the entire parabola having the span $AC = L$. Then the horizontal stress running through the suspension bridge, when covered throughout with the dead load p and the live load q , will be $H = (p + q) \frac{L^2}{8D}$; and this stress will at all sections be divided equally between the upper member APB and the lower member AOB , the stress in each being $H_1 = -(p + q) \frac{L^2}{16D}$; and this stress will not be exceeded when one half of the span is covered with the live load.

For the bending moment due to any given unequal distribution of load will be the same as in the roadway girders of Fig. 226; and when the live load covers the half span AB the bending moments will be those represented by the parabolic diagrams asb and bsc in Fig. 227. It is evident therefore that the horizontal flange stress in the parabolic rib AB , due to these moments, will be uniform throughout; and if D_1 denotes the central depth OP , the uniform horizontal flange stress will be expressed

$$\text{by } \pm H_m = \frac{qL^2}{16D_1} = \frac{qL^2}{32D}.$$

But the tensile stress running through the whole suspension-bridge will now be reduced to $H = -\left(p + \frac{q}{2}\right) \frac{L^2}{8D}$; and in each member the total horizontal stress will be $H_2 = \frac{H}{2} + H_m$.

We have, therefore—

$$\text{In the upper member of } AB. \quad H_2 = -p \frac{L^2}{16D}$$

$$,, \quad \text{lower} \quad ,, \quad ,, \quad . \quad H_2 = -(p+q) \frac{L^2}{16D}.$$

$$\text{In the upper member of } BC. \quad H_2 = -(p+q) \frac{L}{16D}$$

$$,, \quad \text{lower} \quad ,, \quad ,, \quad . \quad H_2 = -p \frac{L^2}{16D}.$$

Therefore if the members are designed, as they must be, to carry the entire load $p+q$, they will be strong enough to carry the unequal load; for in no part is the tensile stress greater than that due to the entire load. At the same time it may be observed that the tensile stress is nowhere *less* than that due to the dead load p , so that the stresses will not alternate between tension and compression like those in the auxiliary roadway girder.

To provide for the greater bending stresses due to certain other positions of the load, and represented by the dotted curves in Fig. 227, the upper member will have to be slightly enlarged at and near the abutments; but when this has been done, its weight, as well as that of the lower member and of the diagonal bracing, will be no greater than in the inverted bowstring of the span l . It follows, therefore, that a suspension bridge of 1000 feet span, constructed in this form, will have nearly the same weight per foot as a parabolic girder of 500 feet span; while it may be shown that its rigidity will be considerably greater.

The exact values of the maximum and minimum stress will be examined in a later chapter.

235A. Other Forms of Hinged Rib.—It only remains to notice here that the arch or suspension bridge may be constructed in rigid form, and with due allowance for expansion and contraction, by placing the hinge either at the centre of the span or near one of the abutments.

Thus in Fig. 225 the roadway-girder may be hinged at the point t , and connected with the abutment by a short flap which would rise and fall with change of temperature. The chain would then always preserve its parabolic form from A to T , and the rise and fall due to change of temperature would take place at the joint T .

In the same way a rigid curved rib may be hinged near one abutment, or an inverted bowstring girder may be treated in the same way

as shown in Fig. 230.¹ In the latter diagram the suspension-link CS is adjusted with such an inclination (at mean temperature) that it forms a tangent to the parabolic chain of the girder, and is attached at S to a saddle resting upon the pier; while at A the weight is borne by another saddle, which, like the first, is anchored back to the abutments by backstays. This being done, it is obvious that the upper flange would be relieved of all compressive stress under the uniform load, as the pull of the chain would then be taken by the backstays extending from each tower to the anchorages.

But, under the effect of alternate cold and heat, the upper flange would be liable to alternate tension and compression; and unless the suspending link is made of great length, the rise and fall of the joint C will so materially affect its angle of inclination that the temperature changes would produce a great stress in the upper flange. The same thing would also occur in the chain bridge hinged excentrically as shown in Fig. 225, where the rise and fall of the joint T would materially increase or decrease the tensile stress in the parabolic chain; while the vertical bar Tt would be subjected to a heavy stress, sometimes tensile and sometimes compressive, which would be produced not only by changes of temperature, but also by variations in the position of the live load. In the ensuing chapters, it will be convenient to consider first the excentric position of the hinge as illustrated in the suspended bowstring of Fig. 230, and then the rigid rib with a central hinge.

¹ The latter form of construction was described by Mr. Baker in his work on Long Span Bridges.

CHAPTER XXI.

BOWSTRING GIRDERS USED AS ARCHES OR AS SUSPENSION
BRIDGES.

(The illustrations referred to in this chapter are contained in Plate K at the end of Chapter XXII.)

236. Application of an Exterior Horizontal Force.—We have seen that the upright bowstring may be converted into an arch if the ends of the bow are supported by abutments which are capable of resisting their horizontal thrust. The horizontal force or reaction of the abutments takes the place of the horizontal pull which was exerted by the lower chord of the bowstring; so that the lower chord can be dispensed with. If the same force is exerted upon the bowstring when the lower chord is present, that member will be relieved of all tensile stress; and if a smaller horizontal force is exerted by the abutments, or is in any way impressed upon the feet of the bowstring, the tensile stress in the lower chord will be by so much reduced. Thus if H_a denotes the horizontal exterior force, and $-H$ the normal tensile stress in the lower chord of a bowstring supported at the ends, the stress in the lower chord of the compressed bowstring will be equal to $H_a - H$.

It is obvious also that the same thing will take place, *mutatis mutandis*, in the upper boom of an inverted bowstring, if an exterior pulling force is applied at each end.

237. Series of Relieved Bowstrings.—Acting upon the above principle, we may construct a viaduct of three or any number of spans consisting of a series of bowstring girders in which the thrust of each bow is met by the counter thrust of the neighbouring bow, just as it is in a series of masonry arches; and under the uniform load, the ties of bowstrings will then be relieved of all tensile stress. To produce this result, it is necessary to arrange matters so that the load will in some way call forth the requisite reaction of the abutments; and this might be done by simply cutting the horizontal tie at any point in either span.

Thus the central span may be constructed as a hinged rib, as in Fig. 229; and if the three arches have the same span and rise, the horizontal tie will suffer no stress at any point so long as the load is uniform over the whole bridge. The dead load will therefore produce no stress; but when the live load covers the central span only, there

will be a compressive stress in the lower flange of the side spans equal to $\frac{qL^2}{8D}$; and a similar tensile stress when the live load covers the side span only. The same thing may be done with a series of inverted bowstrings used as suspension bridges and coupled together over the piers, so that the pull of one chain is transferred to that of the neighbouring span.

In either case the horizontal reaction of the fixed abutments is equal and opposite to the horizontal thrust (or pull) of the *hinged* rib, and depends upon the load that may be imposed upon that rib.¹

238. Single Span Crossed by a Suspended Bowstring.—It has sometimes been proposed to construct an inverted bowstring, as in Fig. 230, in which the compressive stress of the upper boom is relieved by the employment of somewhat similar means. At the point *C* the girder is suspended by an inclined link *CS*, forming a tangent to the parabolic curve of the lower member, and connected with a backstay which is anchored in a heavy abutment. The opposite end *A* of the bowstring is of course anchored back in the same way; and the parabolic chain and backstays form together a suspension bridge which carries the uniform load without any assistance from the upper boom. For when the load is uniformly distributed, the horizontal pull exerted by the inclined link *CS* is of course exactly equal to the thrust that would be exerted by the boom in a parabolic girder supported at each end.

The stresses that take effect in the straight boom under any *unequal* distribution of the rolling load, may be readily found by subtracting the external force, or the horizontal pull H_{10} (of the inclined link) from the compressive stress already found for the parabolic girder; and a single example will be sufficient to make this method quite clear, and to illustrate the general properties of such a design.

In Fig. 230 let the depth *D* be one-tenth of the span, so that the inclined link *CS*, which forms a tangent to the parabolic curve, has a rise of 1 vertical to 2·5 horizontal, or $\tan. \theta = 2\cdot5$. Then whatever may be the vertical load V_{10} carried by the link at *C*, the horizontal pull of the link will be $H_{10} = 2\cdot5 V_{10}$.

In Table 2A, Art. 216, we have already found the horizontal flange stress in a parabolic girder of 10 equal panels supported at each end, due to a load $Q = 1$ ton placed successively at each of the joints 1 to 9 inclusive; and whatever may be the depth of the girder, those figures will give the stress in units of $Q\frac{b}{D}$. In the present example, the panel width

b is one-tenth of the span, and equal to *D*, so that the table gives the flange stress in units of $Q = qb$.

Each element of the load will produce at *C* the vertical reaction V_{10} (as before found) which will be accompanied by a horizontal pull $H_{10} =$

¹ The exterior force may be fixed at any arbitrary and unchanging value, if it is applied by independent means at either end of the viaduct; and the hinged span is then not wanted.

$2.5V_{10}$; and subtracting H_{10} from the compressive stress given in Table 2A, we have the stresses $H_1, H_2, \&c.$, at each joint of the upper boom, as given in the following table:—

TABLE 10Y.—*Horizontal Stress at each Joint in the Boom of a Suspended Bowstring of Ten Equal Panels, Fig. 230, produced by Unit Load on Each Joint.*

Central Depth $D = 1$; Panel Width $b = 1$; Panel Load $Q = 1$.

Position of Load.	Flange Stress at Each Joint.									External Force.	
	H_1	H_2	H_3	H_4	H_5	H_6	H_7	H_8	H_9	H_{10}	V_{10}
No. 1	2.250	1.000	.583	.375	.250	.167	.107	.063	.028	-.25	.1
2	1.722	2.000	1.167	.750	.500	.333	.214	.125	.056	-.50	.2
3	1.194	1.437	1.750	1.125	.750	.500	.321	.187	.083	-.75	.3
4	.667	.875	1.143	1.500	1.000	.667	.429	.250	.111	-1.00	.4
5	.139	.313	.536	.833	1.250	.833	.536	.313	.139	-1.25	.5
6	-.389	-.250	-.071	.167	.500	1.000	.643	.375	.167	-1.50	.6
7	-.917	-.813	-.679	-.500	-.250	.125	.750	.437	.194	-1.75	.7
8	-1.444	-1.375	-1.286	-1.167	-1.000	-.750	-.333	.500	.222	-2.00	.8
9	-1.972	-1.937	-1.893	-1.833	-1.750	-1.625	-1.417	-1.000	.250	-2.25	.9
$\frac{1}{2}$ at No. 10	-1.250	-1.250	-1.250	-1.250	-1.250	-1.250	-1.250	-1.250	-1.250	-1.25	.5
Total positive }	5.972	5.625	5.179	4.750	4.250	3.625	3.000	2.250	1.250	-12.50	
Total negative }	-5.972	-5.625	-5.179	-4.750	-4.250	-3.625	-3.000	-2.250	-1.250		
Sum	0	0	0	0	0	0	0	0	0		

In order to make up the full complement of the load, we have added at the joint 10 one half of the panel load on 9-10, or a load of $\frac{Q}{2}$; and when the full load is thus completed, the stress in the upper boom, which is of course equal to the algebraical sum of the stresses due to each separate element of the load, is everywhere equal to zero.

But adding up separately the positive increments of stress and the negative increments of stress, the totals, as given at the foot of the table, show the greatest compressive and the greatest tensile stress to which the boom is subjected during the passage of the rolling load.

At every joint the greatest compression is equal to the greatest tension; but its amount varies in different parts of the boom, and is greatest at the left end of the span, and least at the end where the inclined link is attached.

As regards the web-bracing, a little consideration will show that the stress in any diagonal, under any given distribution of load, will be exactly the same as in a parabolic girder supported at each end. For the external horizontal force, whatever may be its value, is applied to the whole

length of the upper boom, so that the horizontal stress in any brace, or $H_n - H_{n-1}$ is exactly the same as though no external horizontal force had been applied.

All the stresses in the web-bracing and vertical posts may therefore be found by the method of direct measurement already described in Art. 217.

The stress in the parabolic chain, like that in the web-bracing, is unaffected by the external force or horizontal pull of the inclined link.

If the depth D of the suspended bowstring is greater than that assumed in the present example, the inclination of the link CS will be proportionately greater, and the horizontal pull H_{10} will be proportionately less. It follows, therefore, that the figures given in the above table will represent the flange stress in the boom of a suspended bowstring of any depth in units of $Q \frac{b}{D}$.

The tabular figures, as before mentioned, are slightly in excess of those which may be deduced from an exact mathematical analysis proceeding upon the assumption that the train is of uniform weight throughout its length. If m denotes the horizontal distance of any joint in the upper boom from the hinge C , the mathematical formula for the greatest stress at that joint due to any position of the rolling load is:—

$$\pm H = \frac{qL^2}{8D} \left(\frac{m}{L+m} \right) \dots \dots \dots (5)$$

while the greatest horizontal stress in any diagonal of the web is—

$$\pm h = \frac{qL^2}{8D} \left(\frac{b}{L+b} \right) \dots \dots \dots (6)$$

in which b is the horizontal width of the panel traversed by the diagonal.¹

239. Changes of Temperature.—A noteworthy feature in the design last noticed is its extreme sensitiveness to change of temperature. With a given rise of the thermometer ΔT , the whole of the bowstring will expand together, and there will be no change of form except at the hinge C ; but in consequence of the expansion of the boom, the short suspending link CS will undergo a considerable change in the angle of its inclination.

Thus if Fig. 230 represents a bridge of 400 feet span, with a suspending link 5 feet in length, it may easily be calculated that a fall of temperature of 60° would change the inclination from 1 in 2.5 to about 1 in 3.4, and the horizontal pull would be increased in like proportion. This would throw a tensile stress of about $\frac{1}{3} \frac{(q+p)L^2}{8D}$ upon the upper boom; while a compressive stress of nearly the same amount

¹ A demonstration of these formulæ was given by the author in a paper on "Arched Ribs and Suspension Bridges," published in *Engineering*, vol. xx., 1875.

would occur with a 60° rise of temperature. But if we increase the length of the suspending link these temperature effects will be rapidly diminished. By taking a link 10 feet in length, instead of 5 feet, the stress due to expansion will be reduced to less than one half; and the longer we make the link, the less will be the effect of heat and cold. In the designs shown in Figs. 224 and 228, the link reaches the greatest possible length, and is equal to one half of the span; and the stress due to the extreme changes of temperature is so small as to be hardly worth considering.

In the case of a viaduct of several spans, constructed as in Fig. 229, the temperature effect will of course be augmented by the expansion of the side spans; but in a bridge of four or five spans its resulting stress would still be less than in the case of the suspended bowstring of Fig. 230. If the viaduct were constructed without a hinged span, and the lower chord continuous from end to end, it would of course be necessary to apply the external compressive force by some independent means which would follow up the temperature changes.

CHAPTER XXII.

RIGID ARCHED RIBS OR SUSPENSION RIBS.

(The illustrations referred to in this chapter are contained in Plate K at the end of this chapter.)

240. The invention of the masonry arch has been variously ascribed to the Romans, the Assyrians, and even to the ancient Egyptians; although it may be doubted whether the mechanical principles which govern its equilibrium were really understood until a more recent date. But however this may be, it is quite certain that the suspension bridge *invented itself*, and arranged its own curve of equilibrium without any aid from the calculations of its first constructor, but simply by obedience to the action of gravity upon the flexible hides or ropes which formed, in early times, the main cables of the bridge.

The *form* of the suspension bridge having thus been dictated, and automatically determined, by the flexibility of the ropes, it is perfectly natural that this flexibility should come to be regarded as the essential characteristic of the suspension principle; and it is equally natural that iron suspension bridges should have been constructed of flexible chains, just as iron arches were at first constructed of tapering voussoirs resembling the stones in a masonry arch. But we have seen that the essential principles of the suspension bridge are altogether independent of flexibility in the cables, which is merely an accidental feature arising from the nature of the materials that were originally employed, but which cannot be regarded otherwise than as a *defect* incidental to the employment of those materials, and one which should be rigorously avoided in an iron suspension bridge.

Therefore, in proceeding to design either an arch or a suspension bridge in iron or steel, we must get rid of those traditional ideas which have naturally associated themselves with the older forms of construction. In the case of the arch, we are not bound to follow the lines of the masonry construction; and in the suspension-bridge it will be equally unnecessary to perpetuate the defects of the earlier materials.

In either case, what we want is not a flexible, but an inflexible bridge, or at least one which shall have the same degree of rigidity as an ordinary girder. In the previous chapters we have glanced at some of the methods which have been adopted for stiffening a *flexible* bridge; but

we have now to consider the construction of a bridge which shall be *inflexible* in itself.

Before proceeding to examine the mechanical principles of the rigid arch or suspension rib, it is only necessary to remark that one of the first conditions introduced by the employment of iron is the necessity for providing for its expansion and contraction under changes of temperature. This provision is equally important in all other forms of bridge, and is seldom neglected in the design of girders or cantilevers; while in the arch or suspension rib it can effectively be made by hinging the rib at the centre. If the rib is not hinged, it will have to undergo bending stresses under every change of temperature, similar to those described in Art. 232, so that a large portion of the available strength of the iron will be employed in a useless resistance to the expansive effect of heat. We shall assume therefore that the rib is constructed with a central hinge, which will obviate all temperature strains, while it will not interfere with the rigidity of the suspension rib any more than the hinged joints in a cantilever bridge or the pin connections in an American truss.

241. Hinged Rib of any Arbitrary Form.—Let the bridge be composed of two rigid semi-ribs *AB* and *BC*, as in Fig. 221, hinged together at *B*, and hinged also at the ends *A* and *C*. Then whether the ribs be straight or curved, and whether their depth be uniform or varied in any conceivable manner, the forces acting upon them may be graphically determined as follows:—

Suppose a load *Q* to be attached or suspended to the rib *AB* at any point *K*; and in order to trace the separate effects of this load, let the structure be supposed to have no weight in itself. Then the rib *BC* being hinged at both ends, can only act as an inclined link, and can exert no force upon the rib *AB* except a *direct pull* in the line *CB*, whose magnitude may be denoted by R_1 .

Drawing the vertical *EFKG*, and producing the line *CB* through *G* to *g*, it is obvious that the load *Q* will exert a moment about the fulcrum *A*, equal to $Q \times AF$; and this moment must be balanced by the moment $R_1 \times AP$, the line *AP* being drawn at right angles to *Cg*. Therefore

$$R_1 = Q \frac{AF}{AP}$$

The force R_1 is resolved at *C* into the vertical component V_1 and the horizontal component *H*, and the latter force must evidently be opposed by an equal horizontal force *H* at the abutment *A*, and represents the horizontal stress running through the entire system.

The vertical reaction of the abutment applied at *C*, and applied also at *B* to the rib *AB*, will therefore be—

$$V_1 = R_1 \times \frac{BD}{BC} = R_1 \times \frac{AP}{AC} = Q \times \frac{AF}{AC}$$

The remainder of the load *Q* is of course carried by the abutment *A*, where the vertical reaction will be $V = Q \times \frac{FC}{AC}$; so that the load is

divided between the two abutments in accordance with the law of the lever, as in a girder bridge.

The horizontal component of the force R_1 will be—

$$H = R_1 \times \frac{DC}{CB} = R_1 \times \frac{AP}{Ag},$$

the line Ag being vertical and equal to $2BD$.

$$\text{Therefore } H = Q \times \frac{AF}{2BD}$$

Draw AE parallel to gC , and let the vertical line EG represent the weight Q . Then EG is resolved into $GA = R$, and $GB = R_1$. The force GA is resolved into $GF = V$, and $AF = H$; while the force GB or AE is resolved into $EF = V_1$ and $AF = H$.

If a series of equal weights be attached to the rib AB at any other points, and acting on the vertical lines $e_1g_1, e_2g_2, \&c.$, intersecting the chord line AC in the points $f_1, f_2, \&c.$, the vertical reactions at A will be represented by the lines $f_1g_1, f_2g_2, \&c.$; while the vertical reactions at C will in like manner be represented by $e_1f_1, e_2f_2, \&c.$, and the horizontal force H due to each of these loads will be represented by the horizontal lengths $Af_1, Af_2, \&c.$

As regards the effect of any distributed load, or of any series of weights, it is sufficiently clear from this illustration that the forces V, V_1 , and H for any *series* of weights will be the same as though all the weights were concentrated at their common centre of gravity.

To express the results in algebraical language—

Let L = the span AC ;

D = the versine BD , measured to the central hinge;

X = the horizontal distance AF to the point of attachment of a single weight Q .

$$\text{Then } V = Q \cdot \frac{L - X}{L} \dots \dots \dots (7)$$

$$V_1 = Q \cdot \frac{X}{L} \dots \dots \dots (8)$$

$$H = Q \cdot \frac{X}{2D} \dots \dots \dots (9)$$

Again, if the horizontal roadway of the bridge is weighted with a distributed load of uniform intensity q per foot lineal, extending from the abutment A for any given distance x , the weight of the load will be qx , and the distance of its centre of gravity from A will be equal to $\frac{x}{2}$.

Therefore we shall have—

$$V = qx \cdot \frac{L - \frac{1}{2}x}{L} \dots \dots \dots (10)$$

$$V_1 = qx \frac{\frac{1}{2}x}{L} = \frac{qx^2}{2L} \dots \dots \dots (11)$$

$$H = qx \frac{\frac{1}{2}x}{2D} = \frac{qx^2}{4D} \dots \dots \dots (12)$$

Having thus determined the forces acting at the ends of the semi-ribs, it will not be difficult to find the stresses in ribs of any given outline or any given form of construction ; and it is obvious that the same formulæ will apply equally to the arch and the rigid suspension rib.

The rib may be designed in a great number of different forms ; but it will be sufficient to notice two of these, viz., 1st, the form shown in Fig. 224, where each rib is a parallel girder whose neutral axis coincides with the parabolic curve of the arch ; and 2nd, the form shown in Fig. 228 or 223A, in which each rib is a parabolic girder.

241A. Hinged Rib, having a Parabolic Curve for its Neutral Axis.

—In Fig. 222, let *ABC* represent the neutral axis of a curved rib, hinged at *A* at *B* and at *C*; and suppose the rib *AB* to be loaded with a single weight *Q* attached at any point *K*. The external forces *V*, *V*₁, and *H*, acting at the ends *A* and *B*, have already been determined in formulæ 7, 8, and 9, in which *X* is the horizontal distance *AF*; and the bending moment which takes effect upon the rib at any point *O* may be readily found as follows :—

Let the co-ordinates of the point *O* be denoted by *AN*=*n*, and *NO*=*y*; and for convenience let *m* denote the horizontal distance *ND*, and *z* the distance *FD*.

Now if the weight *Q* is attached to the rib at any point between *A* and *O*, the bending moment will be simply the sum of the moments of the external forces acting at *B*; and if the weight is attached between *O* and *B*, we have only to find the moments of the exterior forces acting at *A*.

1st. For a weight attached between *A* and *O*, we have therefore the bending moment at *O*, or—

$$M = V_1m + H(D - y) \dots \dots \dots (13)$$

Here we may notice that each of the forces *V*₁ and *H* produces a positive or sagging moment at *O*, and therefore every weight attached to the rib at any point or points between *A* and *O* produces a positive bending moment.

2nd. For a weight attached between *O* and *D*, we have the bending moment—

$$M = Vn - Hy \dots \dots \dots (14)$$

Here, on the other hand, we have the forces *V* and *H* producing moments in contrary directions, and the bending moment *M* may be either positive or negative according to the position of the weight. If the

weight is attached very near to the point *O*, the moment Vn will be greater than Hy , and M will be positive; but if the weight is attached very near to the central hinge *B*, the conditions will be reversed and M will be negative. There is therefore a certain intermediate position at which the weight might be placed, and where it would produce no bending moment at all; and it will easily be seen that this will occur when $Vn = Hy$, or in other words when the resultant R passes directly through the point *O*.

We have already seen in Fig. 221, that if the load acts at any vertical line EG , the resultant at *A* will be the line AG ; and therefore to find the required position of the weight, we have only to draw the straight lines AOG and CBG through the points *O* and *B* until they intersect each other in the point *G*, and the vertical FKG will represent the required position of the weight.

It follows, therefore, that the greatest positive bending moment at the point *O* due to any possible distribution of the rolling load, will take place when the load covers the length AF ; and the greatest negative moment will occur when the load covers the length FC .

The position of the point *F*, or the horizontal distance $FD = z$, may be found by mathematical analysis as well as by the geometric method above described; and its value is—

$$z = m \cdot \frac{l}{2l + m} \dots \dots \dots (15)$$

in which l is the length of the half span AD . Then making $x = l - z$, and applying the formulæ of the last article, we obtain the following results:—

1st. When the live load covers the whole span, there is no bending moment at any point in the parabolic neutral axis.

2nd. When the live load covers the half span AB , the rib AB is subjected to a positive bending moment at every point whose value is—

$$M = q \cdot \frac{m(l - m)}{4} \dots \dots \dots (16)$$

while the rib BC is subjected to a negative moment of the same value. These moments are the same as in the roadway girders of Fig. 226, and are represented by the full lines of the diagram in Fig. 227.

3rd. The *greatest* positive bending moment at any point in either rib is—

$$\text{Max. } M = \frac{qm(l - m)}{4} \left(1 + \frac{m}{2l + m} \right) \dots \dots \dots (17)$$

and the greatest negative moment has the same value. These moments are represented by the dotted curves in Fig. 227.

4th. If the vertical depth of the rib, at the point in question, is

denoted by d , the horizontal component of the flange stress due to the above bending moments will be—

$$H_m = \pm \frac{M}{d}$$

and the total horizontal stress in either flange will be—

$$H_2 = \frac{H}{2} \pm \frac{M}{d} \dots \dots \dots (18)$$

in which H is the horizontal stress running through the arch or suspension rib.

The value of the latter force varies with the distribution of the load, and consequently the *greatest stress in either flange* is not coincident either with the greatest value of H or with the greatest value of M .

The distribution of load which produces the greatest stress in either flange, and the value of that stress, depend in each case upon the depth d ; and the method of ascertaining it must next be considered.

It is important to notice that the greatest flange stress in an arched rib does *not* correspond with the greatest bending moment as measured about the neutral axis, but it *does* correspond with the greatest bending moment as measured about one joint, as shown in the next ensuing article.

242. Maximum Stress in the Flanges of a Hinged Rib.—When the whole figure of the arched rib or suspension rib has been determined, it will be possible to find the distribution of load which produces the greatest stress in either flange; and for this purpose it is only necessary to apply the geometric method in a slightly different manner. For example, in Fig. 223 we have a suspension bridge in which each rib is a parabolic girder, while in Figs. 223A and 224 we have two forms of arched rib, whose neutral axis in each case is a parabolic curve, while the depth of rib OP is uniform in Fig 224, but varies in Fig. 223A like the ordinates of a parabolic curve. For either of these forms of construction, or indeed for any other *defined* form of rib, we may obtain a geometrical solution as follows:—

Let a single weight Q be supposed to act at any vertical line FG whose horizontal distance from B is denoted as before by z .

Then if we take a vertical section OP at any panel point in the rib, we may determine the horizontal flange stress at P by applying the usual method of moments in the same way as in any girder bridge; *i.e.*, having found the external forces, and calculated their combined moment M about the joint O , the horizontal stress at P will be simply $\pm H_p = \frac{M}{OP}$.

The external forces V , V_1 , and H have already been found in Art. 240, and proceeding as before, we find that if the weight is attached at any point between A and N , the moment about O will be positive, and will also be positive if the weight is hung at a short distance to the

right of N ; but will be negative if the weight is attached near the central hinge.

As before, therefore, we find that there is a certain intermediate position where the weight produces no moment about O , and therefore no stress at P . This critical position, however, is not the same as in Fig. 222; for evidently it will only occur when $V \times AN = H \times NO$, or in other words, when the resultant R lies in a direct line *through the joint* O , which is now situated in one of the flanges and not in the neutral axis of the rib. But it is also obvious that the critical position of the weight may be found by the same method as before, so that we have only to draw through the joint O and through the central hinge B the straight lines AOG and CBG until they intersect in the point G , when the vertical FG will give us the required position of the weight.

Therefore at any vertical section ON , whose horizontal distance from A is $AN = n = l - m$, we shall have the greatest positive moment about O when the rolling load covers the length $AF = x = l - z$; and taking the forces to the left of the section, this moment will be—

$$M = Vn - (H \times NO) - \frac{qn^2}{2} \dots \dots \dots (19)$$

To apply this formula it is only necessary to insert the values of V and H given in formulæ (10) and (12); but it is already evident that the critical distribution of the rolling load (or the distance z) will depend upon the height of the ordinate NO , and therefore upon the depth of the rib. It follows that no general formula can be given which shall be applicable in all cases to parallel arched ribs of different depths constructed as in Fig. 224; but when the depth of the rib *has been fixed* there will be no difficulty in treating each case separately by means of the geometrical method and the formulæ above given.

But in the case of the parabolic ribs of Fig. 223, the proportions are geometrically fixed, and consequently the maximum stress at any joint can be determined. The central depth of the rib being equal to $\frac{BD}{2}$, the upper member AB becomes a straight line, and we have at any section $NP = BD \times \frac{AN}{AD} = D \frac{l - m}{l}$, and $NO = 2D \frac{m(l - m)}{l^2}$; therefore—

$$\frac{NP}{OP} = \frac{l}{2m}; \quad \frac{NO}{OP} = 1 + \frac{l}{2m}; \quad \frac{AN}{NO} = \frac{l^2}{2mD};$$

and with these ratios the moments and stresses can be readily calculated.¹

¹ This form of suspension bridge, which is shown more completely in Fig. 228, was first investigated by the author in a paper read at the Scottish Society of Arts and published in *Engineering* of April 1875, and was patented at a somewhat earlier date. Other designs, bearing more or less resemblance to this form, have been independently proposed by Professor Thomson, M. Oudry, Herr Lange, and other engineers. In some of these designs, however, the resemblance is more superficial than real, as, for example,

243. Rigid Suspension Bridge with Parabolic Ribs.—In Fig. 228 the neutral axis of the rib is a continuous parabolic curve bisecting every vertical section OP , while each rib may be regarded as a suspended parabolic girder having a straight upper member and a parabolic lower member, which meet at the central hinge.

Under any given distribution of the rolling load, the stresses may be found by the method of moments described in the preceding articles and illustrated in Fig. 223; and applying the formulæ already given the following results are obtained:—

1. For a dead load of intensity p , uniformly distributed over the whole span $AC=L$, we have the horizontal stress at any point O or P of the upper or lower member—

$$H_p = - \frac{pL^2}{16D} \dots \dots \dots (20)$$

and there is no stress in the diagonal bracing.

2. When the live load covers the whole span, the stress due to that load is of course $H_q = - \frac{qL^2}{16D}$; and as before there is no stress in the diagonal bracing.

3. When the live load covers the half span AB , we have the resulting stress at any point in the lower members of the rib AB , or in the upper member of the rib BC —

$$H_q = - \frac{qL^2}{16D} \dots \dots \dots (21)$$

This load produces, by itself, no stress in the upper member AB , nor in the lower member of the rib BC , nor in any bar of the diagonal bracing; and this is readily accounted for by the fact that the strained members AOB and BC , form together an equilibrated chain for the load in question.

4. The maximum and minimum horizontal stress in any bar of the lower member AOB , due to any position of the rolling load upon the bridge, will be—

$$\text{Max. } H = H_p + \text{Max. } H_q = - (p + q) \frac{L^2}{16D} \dots \dots \dots (22)$$

$$\text{Min. } H = H_p = - p \frac{L^2}{16D} \dots \dots \dots (22a)$$

5. At any joint P of the upper member, the greatest stress producible in the case of the Monongahela Bridge, which was constructed upon the principle proposed by Lange, and consists of a parabolic chain lying in the continuous curve ABC of Fig. 220, and two straight members AB and BC . Any rigidity that this bridge may possess must depend upon the capacity of those straight members to resist a compressive stress; and the stresses in general are widely different from those which occur in Fig. 228.

by the rolling load *alone* occurs when that load extends from *C* to *F*, the distance *FD* being given by—

$$z = m \cdot \frac{l}{l+m} \dots \dots \dots (23)$$

and its value is then—

$$\text{Max. } H_q = -\frac{qL^2}{16D} \left(1 + \frac{m}{l+m}\right) \dots \dots \dots (24)$$

If a rolling load extended from *A* to *F*, while the remainder of the span was subject to no load at all, the resulting stress at the joint *P* would be a positive or compressive stress, whose value is given by—

$$\text{Min. } H_q = \frac{qL^2}{16D} \left(\frac{m}{l+m}\right) \dots \dots \dots (25)$$

It follows that the maximum and minimum values of the tensile stress at *P* will be—

$$\text{Max. } H = H_p + \text{Max. } H_q = -\frac{L^2}{16D} \left\{ p + q \left(1 + \frac{m}{l+m}\right) \right\} \dots (26)$$

$$\text{Min. } H = H_p + \text{Min. } H_q = -\frac{L^2}{16D} \left\{ p - q \left(\frac{m}{l+m}\right) \right\} \dots (27)$$

6. The greatest stress in any diagonal of the web is the same as in a parabolic girder, *i.e.*, if *b* denotes the horizontal width of the panel, the horizontal component of the greatest stress in the diagonal will be—

$$\text{Max. } H_q = -\frac{qL^2}{16D} \left(\frac{b}{l+b}\right) \dots \dots \dots (28)$$

The above formulæ will suffice to determine all the stresses; but we have hitherto preferred to work them out by tabulating the elements of stress due to the separate elements of the load. The latter plan will often be useful, and admits of being easily applied to special cases where we may have an unequal distribution of the dead load; and it may therefore be desirable to follow the same plan in the present case.

To construct such a table for a rigid suspension rib of any given number of panels, it is only necessary to treat each rib as a suspended bowstring in the manner already described in Art. 238. In fact, a little reflection will show that the figures already given in Table 10y for the suspended bowstring, will correctly represent the horizontal stresses produced in the rib *AB* of Fig. 228, by a load *Q* placed successively at each joint of *that rib*; so that it only remains to complete the table by adding the horizontal stress produced by a similar load placed upon every joint of the fellow rib *BC*.

Therefore adding up in Table 10y the elements of H_{10} , we find that when every joint of the rib *AB* is loaded, the horizontal stress in the straight suspending link *BC* is $-12.5 Q \frac{b}{d}$; and of course the straight

member AB suffers a like stress when every joint of the rib BC is loaded. Adding, therefore, this negative stress to the totals at the foot of Table 10x, we obtain the following values of Max. H_v and Min H_v at each joint in the upper member of a rib of ten equal panels.

TABLE 10z.—*Horizontal Stress at each Joint in the Upper Member AB of a Suspension Rib of Ten Equal Panels.*—Fig. 228.

Central Depth, $OP = 1$; Panel Width, $b = 1$; Panel Load, $Q = 1$.

	H_1	H_2	H_3	H_4	H_5	H_6	H_7	H_8	H_9
Positive total or Min. H	5.972	5.625	5.179	4.750	4.250	3.625	3.000	2.250	1.250
Negative total or Max. H	-18.472	-18.125	-17.679	-17.250	-16.750	-16.125	-15.500	-14.750	-13.750
Sum	-12.5	-12.5	-12.5	-12.5	-12.5	-12.5	-12.5	-12.5	-12.5

The above figures relate, of course, to the stress H_v , due to the live load *alone* ; while the total stress will be the algebraical sum of the stresses due to the dead and live load respectively. It follows that the upper member, in a bridge of any considerable size, will not be subject at any point to a compressive stress, nor to any great reduction of the normal tensile stress.

For reasons already explained, the above values are slightly in excess of the quantities calculated by the mathematical formula, and are really to be preferred as approximating more closely to the truth. For the same reason it will be better to treat the diagonals in the same way as already described for the ordinary bowstring, and to measure the maximum stress in each diagonal or post by simply scaling its length.

It is unnecessary to give the detailed calculations of direct stress, and the required sectional area of each member for any particular example. In determining the sectional areas it will of course be necessary to make due allowance for the variations of stress which occur during the passage of the train, and the working stress must be accordingly adjusted by one or other of the methods already described.

244. Weight of the Rigid Suspension Bridge.—Before we can calculate the stresses for any given case we require to know the weight of the suspension ribs, and for this purpose we shall proceed by the method which we have before adopted in the case of girder bridges. The weight of the bridge per lineal foot will be somewhat less at the centre of the span than at the piers ; but to be on the safe side we may assume the unknown weight of the main structure w to be uniform throughout the span, and to be equally divided between the upper and lower joints of the rib.

The remaining part of the dead load, including the weight of the

platform and wind bracing, will be denoted by p as before ; and the rolling load by q ,—both in tons per foot lineal.

The sectional area required in each member to meet the maximum stress, and to meet the greatest variation of stress, will be determined by the dynamic method before described ; and the sectional area of each member being multiplied by its length, the weight of any set of members will be expressed by $\gamma (w\mu + p\mu' + q\mu'')$; in which μ , μ' , and μ'' are coefficients applying to the several portions of the load, while γ is another coefficient expressing the practical weight per foot of a tie or strut carrying a unit load.

The coefficients μ , μ' , and μ'' are given in Table 13, and will apply to any bridge of the form shown in Fig. 228, whatever may be the ratio of dip to span, that ratio being denoted by $R = \frac{L}{D} = \frac{AC}{BD}$

The values given in the table apply to the whole of the main structure, or the proper weight-carrying structure, between A and C , and are of course exclusive of the weight of metal that may be required in the platform and wind-bracing to resist wind-pressure.

The latter weights are to be included in the load p , and to be ascertained independently ; and this being done, the required weight of the main structure will be expressed as before by the formula—

$$w = \frac{L (p\Sigma\gamma\mu' + q\Sigma\gamma\mu'')}{1 - L \cdot \Sigma\gamma\mu}$$

TABLE 13.—Weight of Rigid Suspension Bridge with Parabolic Ribs. Fig. 228.

Panels.		Tension Members.			Struts.
No.	Width.	Upper and Lower Chains (together).	Diagonal Ties.	Vertical Suspensers.	Posts.
N=10	$\frac{L}{20} \begin{matrix} \mu \\ \mu' \\ \mu'' \end{matrix}$	0·125 $R + \cdot 830 \div R$ ·125 „ + ·830 „ ·2241 „ + 1·392 „	0· 0· 0·020 $R + 1\cdot 381 \div R$	0· 0·143 $\div R$ 0·570 „	0·165 $\div R$ 0· 0·759 „
N=12	$\frac{L}{24} \begin{matrix} \mu \\ \mu' \\ \mu'' \end{matrix}$	0·125 $R + \cdot 831 \div R$ ·125 „ + ·831 „ ·2245 „ + 1·394 „	0· 0· 0·017 $R + 1\cdot 646 \div R$	0· 0·146 $\div R$ 0·584 „	0·166 $\div R$ 0· 0·898 „
N=14	$\frac{L}{28} \begin{matrix} \mu \\ \mu' \\ \mu'' \end{matrix}$	0·125 $R + \cdot 831 \div R$ ·125 „ + ·831 „ ·2247 „ + 1·396 „	0· 0· 0·0153 $R + 1\cdot 912 \div R$	0· 0·149 $\div R$ 0·596 „	0·166 $\div R$ 0· 1·025 „
N=16	$\frac{L}{32} \begin{matrix} \mu \\ \mu' \\ \mu'' \end{matrix}$	0·125 $R + \cdot 832 \div R$ ·125 „ + ·832 „ ·2248 „ + 1·398 „	0· 0· 0·0138 $R + 2\cdot 175 \div R$	0· 0·152 $\div R$ 0·606 „	0·166 $\div R$ 0· 1·170 „

Example 1. Rigid Suspension Bridge of 500 feet span.—In estimating the weight of the rigid suspension bridge, we will assume that the pro-

portions are the same throughout as those shown in Fig. 228, the central dip is $\frac{1}{10}$ th of the span, the central depth of each rib is $\frac{1}{10}$ th of its horizontal length, and each rib is divided into twelve panels whose width is $\frac{1}{4}$ th of the span, while the roadway is suspended to the rib at an intermediate point in the centre of each panel as well as at each panel-point.

Then, as $R = 10$, we have the following coefficients :—

	μ	μ'	μ''
Upper and lower chains	1·333	1·333	2·385
Diagonals	0·	0·	·335
Vertical suspenders	0·	0·015	·059
Vertical struts of the web	0·017	0·	·090

As regards the coefficient for waste of material, and for stiffening the compression members, we shall suppose that the main chains are composed of eye-bars, and the waste material in these members need not then be greater than 20 or 25 per cent. ; but to allow for a more convenient form of connection at the joints of the web, we shall assume, as before, that $\kappa = 1·33$ in all tension members except the vertical suspenders ; and as some of these may have to act as vertical stiffeners we shall double the coefficient and make $\kappa = 2·66$.

In regard to the vertical posts of the web, it is evident that the average height of the rib is only half the height of a parabolic girder of the same span, the tallest strut being only 25 feet in height as against 56 feet in the Saltash bridge ; and therefore the metal required for lateral stiffening of the rib and for the stiffening of the strut will be considerably less. But in order to be on the safe side we may take $\kappa = 2·50$ as before, and the coefficient γ for each set of members will then be the same as in the previous examples, viz :—

	κ	γ
Upper and lower chains	1·33	·0003
Diagonals	1·33	·0003
Vertical suspenders	2·66	·0006
Vertical posts	2·50	·0007

The weight of the suspended roadway, the permanent way, and the wind-bracing, may again be taken at $p = 0·7$ ton per foot as in the bow-and-chain bridge ; and taking the live load at $q = 1$ ton per foot, we have the several products as follows :—

$$\begin{aligned} \Sigma \cdot \gamma \mu &= \cdot 000412 \\ p \Sigma \cdot \gamma \mu' &= \cdot 000409 \times \cdot 70 = \cdot 000,2863 \\ q \Sigma \cdot \gamma \mu'' &= \cdot 000915 \times 1 \cdot 0 = \cdot 000,9150 \\ & \underline{\hspace{10em}} \\ & \cdot 001,2013 \end{aligned}$$

Therefore the weight of the main structure per foot will be—

$$w = \frac{500 \times \cdot 001,2013}{1 - (500 \times \cdot 000412)} = 0·76 \text{ ton per foot.}$$

This calculation is of course exclusive of the towers, the ironwork in the platform, and the wind-bracing.

It appears, therefore, that with the same strength in every part, this bridge can be constructed with less than half the weight of metal required in a parallel girder of the "Ohio" type, or a bow-and-chain bridge of the Saltash type; but this comparison refers only to the main span, and it must be remembered that the suspension bridge cannot be built without the addition of either side spans or backstays, and of heavy anchorages at each end.

If the situation happens to be suitable for a central span of 500 feet, and two side spans of 200 or 250 feet each, the side spans may be constructed with a single parabolic rib similar to the semi-rib of the central span; and in this case the total length of 1000 feet would be built for about 0.76 ton per foot, but of course the anchorages and towers would still remain to be estimated for.

But if the problem in hand is simply to cross a single opening of 500 feet in the most economical way, the suspension bridge will be handicapped not only by the cost of anchorages, &c., but also by the backstays extending from each tower to the abutment.

In such a case, we may perhaps estimate that the weight of the towers, backstays, anchorage chains, and of saddles and anchor plates, would amount to almost as much as the weight of the central span. The gross weight of ironwork would still be less than in the 500 feet girder, but as a set-off against this saving we should have to reckon the cost of the heavy masonry abutments.

What this latter item would amount to depends upon the situation. In some cases, as in the Clifton bridge, the anchorage has been tunnelled into the natural rock without the construction of any masonry at all; but in other cases this natural advantage would not present itself, and a heavy abutment would have to be built.

We may safely conclude that whatever may be the economic advantage of the suspension system at a span of 500 feet, that advantage will diminish in bridges of smaller span, and will increase in bridges of larger span. The precise point at which it becomes more economical than the ordinary single girder cannot be determined without reference to the local circumstances in each case, such as the height of the roadway above the water-level, the height and nature of the banks on each side, the relative cost of iron and of masonry, and some other questions; but in the case of very large spans the weight of ironwork in the central span becomes the chief factor in determining the question of cost, and to illustrate its increasing importance we may next take the case of a span of 1000 feet.

Example 2. Wrought-Iron Suspension Bridge of 1000 feet span.— Keeping to the proportions shown in Fig. 228, the values of μ , &c., will of course be the same as before; and we may also adhere to the same values of the coefficients κ and γ ; for it is obvious that the length of

each vertical strut and its maximum load will be exactly the same as in a parabolic girder of 500 feet span, and the metal required for stiffening will not be greater in one case than in the other. But it will be necessary to consider the probable weight of the platform and wind-bracing, for it is evident that in a bridge of this span the necessary rigidity and resistance to wind-pressure can only be obtained by adopting a great width of platform, or by some special arrangement of the structure such as that of two single-line bridges placed side by side at a distance of 60 or 70 feet apart and braced together.

To estimate the weight of platform and wind-bracing for such long span bridges, we may take for our present purpose the approximate formula given by Mr. Baker,¹ viz. :—

For girder bridges	$p = \frac{2}{3} \sqrt{L}$
For cantilever bridges	$p = \frac{7}{12} \sqrt{L}$
For suspension bridges	$p = \frac{1}{2} \sqrt{L}$

These formulæ give the weight in cwts. per foot lineal; and although a lower value is given for suspension bridges than for other types of construction, we shall prefer to take the highest value given for girder bridges, and we shall have $p = \frac{2}{3} \sqrt{1000} = 21$ cwts. per foot. But to this we shall again add 7 cwts. per foot for the weight of timber, &c., in the platform; and the total weight of platform and wind-bracing will then be $p = 28$ cwts. = 1·4 ton, or 0·7 ton per foot for each single-line bridge, supposing that the structure will consist of two single-line bridges placed side by side.

Therefore for *each* of these bridges we have—

$$\begin{aligned} \Sigma \gamma \mu &= \cdot 000412 \\ p \Sigma \gamma \mu' &= \cdot 000409 \times \cdot 70 = \cdot 000,2863 \\ q \Sigma \gamma \mu'' &= \cdot 000915 \times 1 \cdot 0 = \cdot 000,9150 \\ &\hline &= \cdot 001,2013 \end{aligned}$$

and the weight of *each* bridge per foot will be—

$$w = \frac{1000 \times \cdot 001,2013}{1 - (1000 \times \cdot 000412)} = 2 \cdot 05 \text{ tons per foot.}$$

The total weight of ironwork in the central span will therefore be—

Two single-line bridges	4·10 tons per foot
Platform, &c.	1·05 „
	5·15 „
Total	5·15 „

It is needless to say that it would be quite impossible to construct a parallel girder or a bowstring girder of this span except by the expenditure of a prodigious amount of metal, if indeed it could be built at all;

¹ *Vide* Long Span Bridges, p. 66.

and therefore whatever may be the cost of towers and backstays, the suspension bridge would be almost infinitely more economical than either type of girder.¹

It has been shown in Art. 235 that we may approximately estimate the weight of the parabolic ribs in Fig. 228 as being nearly equal to the weight of an inverted bowstring of half the span; *i.e.*, each member in the 1000 feet suspension bridge will have nearly the same length and sectional area as in the inverted bowstring of 500 feet span. This estimate is practically borne out by the calculation, for we find the weight of the single-line bridge to be 2.05 tons per foot, while the weight of the inverted bowstring of 500 feet was found to be 1.78 tons per foot when the depth was $\frac{1}{3}$ th of the span, and 2.4 tons per foot when the depth was $\frac{1}{10}$ th of the span, as it is in each rib of the suspension bridge. Thus the suspension principle renders it practicable to construct a bridge of double the span with the same weight per foot.

245. Weight of Rigid Suspension Bridges in Steel.—The safe working stress in steel tension members may be taken at a higher value than in wrought iron, in the proportion of $7\frac{1}{2}$ tons per square inch to 5 tons per square inch. We have already noticed the practical difficulties and uncertainties which attach to the realisation of this estimate, both as regards the strength of rivetted joints and that of eye-bars; but these difficulties are certainly in a fair way of being removed if they are not already overcome; and at all events, the above estimate is in accordance with the actual practice of bridge-builders at the present date.

Therefore taking the waste material in the connections of the eye-bars at 33 per cent. as before, the specific weight of the steel tension member will be expressed by $\gamma = .0002$, and we may adopt this value for the chains and diagonal ties.

We might perhaps apply the same reduction to the vertical suspenders and vertical posts; but in regard to the latter, we have already seen that it is not practicable to reduce the sectional area of a long and lightly loaded strut in anything like the proportion of the strength of steel to that of wrought iron. Therefore, in order to be on the safe side, we shall make no reduction at all in these members on account of the employment of steel; the struts and vertical suspenders will be *made* of steel, but will have exactly the same sectional area as though they were made of wrought iron, *i.e.*, we shall take their specific weight at the same value as in wrought iron, or $\gamma = .0006$ for the suspenders, and $\gamma = .0007$ for the vertical posts.

Multiplying these values of γ by the coefficients μ , &c., we have for the weight of the whole—

$$\begin{aligned}\Sigma\gamma\mu &= .0002785 \\ \Sigma\gamma\mu' &= .0002756 \\ \Sigma\gamma\mu'' &= .0006430\end{aligned}$$

¹ The weight of a bowstring of 900 feet span is estimated by Mr. Baker at 46 tons per foot for a double-line bridge.

Example. Bridge of 1500 feet span.—It remains only to determine for each span the weight of the platform and wind-bracing; and for the present purpose we may again take Mr. Baker's estimate, which for steel bridges is as follows:—

For girder bridges	p	in cwts. = $\frac{4}{3}\sqrt{L}$
For cantilever bridges	p	„ = $\frac{7}{15}\sqrt{L}$
For suspension bridges	p	„ = $\frac{1}{3}\sqrt{L}$

Selecting the highest value, as before, and making a further addition of 7 cwts. per foot for the permanent way and timber of the roadway platform, we have for the 1500 feet span $p = \frac{4}{3}\sqrt{1500} + 7 = 24$ cwts. per foot or 0.6 ton on each single-line bridge; and for the rolling load we shall uniformly take $q = 1$ ton per foot. Therefore—

$$\begin{aligned} p \Sigma \gamma u' &= \cdot 000165 \\ q \Sigma \gamma u'' &= \cdot 000643 \\ \hline &= \cdot 000808 \end{aligned}$$

and the weight of each single-line bridge will be—

$$w = \frac{1500 \times \cdot 000808}{1 - (1500 \times \cdot 000279)} = 2\cdot 08 \text{ tons per foot.}$$

The total weight of steel in the central span will then be—

Two single-line bridges	4.16 tons per foot
Platform and wind-bracing86 „
Total	5.02 „

Proceeding in the same way with higher spans, we obtain the following results for the total weight of steel in the central span of bridges up to 3000 feet span in tons per foot—

	Span.			
	1500 Feet.	2000 Feet.	2500 Feet.	3000 Feet.
Main structure	4.16	7.50	13.6	31.4
Platform and wind-bracing	.86	1.00	1.1	1.2
Total	5.02	8.50	14.7	32.6

As before, this table does not include the weight of the towers or of the anchorages.

In making use of these figures it will be well to bear in mind the two following points :—

1st. The calculation is based upon the assumption that the working stress in each member is adjusted according to the extent of the *stress variations*, in conformity with the newer methods that are now being adopted. In applying such a method to the comparatively moderate spans that we have hitherto been dealing with, we have found the results to agree very well with the average practice of engineers. But when either of the newer methods is applied to very large bridges, it will always lead to a higher working stress (in the principal members) than has hitherto been generally allowed; because in very large spans the stress in these members is almost entirely a *dead* stress. Thus in the case of the 1500 feet span, our method has virtually fixed the working load in the main chains at a value varying from 8.0 to $8\frac{3}{4}$ tons per square inch; while in the diagonal ties the working load is only 5 tons per square inch, and in the vertical struts only 2 tons per square inch—or even less in some of the struts, owing to the large allowance that we have made for stiffening.

If the newer methods are sound in principle, there is no valid reason why the higher working stress should not be employed in long-span bridges, provided that the same method is applied impartially to all the members; but notwithstanding the liberal allowance of sectional area which this method would give in the case of the web-members, it is very probable that the adoption of the higher working load in the flanges would be objected to by the existing authorities, and that no higher stress than $7\frac{1}{2}$ tons per square inch would be permitted in any part of the structure.

In order to comply with this regulation in the case of the 1500 feet bridge, it would be necessary to increase the sectional area of the chains, and the weight of the whole structure would be increased from 5.02 to 6.12 tons per foot; and in the case of the wider spans, the increase would be still more considerable.

But in dealing with very wide spans, it will be quite easy to comply with this regulation without increasing the estimated weight of the bridge, if we adopt a slightly greater ratio of depth to span. Thus for a span of 1500 or 2000 feet, we may take the depth at $\frac{1}{8}$ th of the span, as is usual in parabolic bridges. Then calculating the chains for a maximum working load of $7\frac{1}{2}$ tons per square inch, and calculating the web-members by the newer method as before, the weight of the 2000 feet span comes out again at 8.50 tons per foot, while the 1500 feet span is reduced to 4.80 tons per foot. In the same way, if we adopt for the larger spans an increasing ratio of depth, making the depth of the 3000 feet bridge equal to about $\frac{1}{7}$ th of the span, we find by repeating the same calculation that in each case the bridge can always be constructed for the weight above given.

2nd. The remaining point to be borne in mind is that the weight of

the wind-bracing has been taken at an approximate and perhaps a somewhat rough estimate. We have assumed a weight which is largely in excess of the formula given by Mr. Baker for suspension bridges; but that formula is avowedly only an approximation, and in practice each case must be separately treated, and the weight of the wind-bracing must be ascertained from a detailed calculation of the wind stresses, which will form the first step in the process of determining the required strength of the structure.

246. Deflection of the Arched Rib or Rigid Suspension Rib.—The deflection which we have here to consider has nothing in common with the *distortion* that takes place in a flexible chain, and which has already been referred to. The change of form, which is necessitated in the case of the flexible chain whenever the load changes its position, cannot take place in the braced rib any more than it can occur in a braced bowstring or any other kind of girder. But the rigidly constructed rib, like the girder, will be subject to a certain deflection due to the elasticity of the material.

It has been shown in Chapter VIII that the vertical deflection of a girder is due to, and is measured by, the linear compression of the upper member and the linear extension of the lower member, and is in fact proportional to the sum of those elastic strains. Thus in the case of the inverted bowstring of Fig. 216, the central deflection is proportional to the horizontal compression or shortening of the straight boom, added to the extension of the parabolic chain, and these two strains will be nearly equal. Or again, in the case of the upright bowstring, the deflection is proportional to the linear compression of the bow added to the linear extension of the tie.

In the case of the arch there is no yielding tie, and consequently no elastic extension of the chord AC to be reckoned for; and it follows that the elastic deflection of the arch under a full load is equal to about *one-half* of the deflection of a parabolic bowstring.

In the same way, if the ends A and C of the suspension chain in Figs. 216, 225, or 228, were held by unyielding abutments, or by unyielding backstays, the deflection of the suspension bridge under a full load would be equal to *one-half* the deflection of a bowstring, or an inverted bowstring girder.

If the suspension bridge of Fig. 228 is constructed with two side spans whose united width is equal to that of the central span, the elongation of the straight chains of the side spans will be just equivalent to the compression of the boom in the inverted bowstring, and the deflection of the rigid suspension bridge will then be equal to that of the bowstring girder.

But if the backstays are inclined at the angle that is usually adopted where there are no side spans, their length will be not much more than half that of the central span, and their elastic elongation being in the same proportion, the deflection of the central span will be about

three-fourths as great as in a bowstring girder of the same span and depth.

Again, if we consider the elastic deflection that takes place in the semi-rib *AB*, when that half of the bridge is covered with the rolling load, the stresses that have been worked out for that distribution of load show (on the same principle) that the deflection of the rib *AB* will be equal to one-half of the deflection of a parabolic girder having the same length and depth. The rigidity of the suspension-rib under a passing load, as well as under the full load, is therefore greater than that of the girder-bridge.

247. Limiting Span and Economic Proportions.—The limiting span occurs as in all other cases when $L \cdot \Sigma \gamma \mu = 1$; and its width evidently depends upon the ratio of depth to span, and also upon the working stress that may be adopted for a load that is almost entirely a dead load. Taking the factor of safety at either 4 or 3, according as the old rule or the newer method is relied upon, and taking the ratio $\frac{L}{D}$ at $R = 10, 8, 7, 6$, we have the limiting span of the steel suspension rib as follows:—

	Limiting Span in Feet.			
	R=10.	R=8.	R=7.	R=6.
Factor=4 . . .	2700	3250	3550	4000
Factor=3 . . .	3600	4250	4600	5000

It will readily be seen that so far as the central span is concerned, the economy of the structure will be considerably increased by adopting a liberal proportion of depth to span; and in the case of very wide spans it may be *necessary* to adopt a depth somewhat greater than $\frac{1}{10}$ th and reaching perhaps $\frac{1}{8}$ th or even $\frac{1}{6}$ th of the span. But the central span is not the only thing to be considered in determining the economic depth; for the height of the towers and the length of the backstays will be directly proportional to the depth, and the weight and cost of these members must also be taken into consideration.

It follows that no general rule can be given for the economic depth, as this will depend upon those local conditions which affect the cost of towers, backstays, and anchorages, and which have been already referred to.

ARCHES ANI

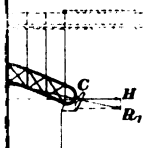
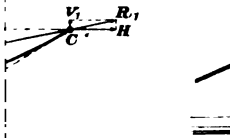
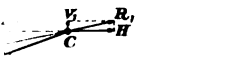
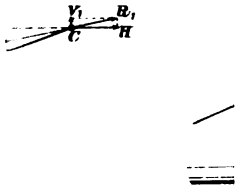
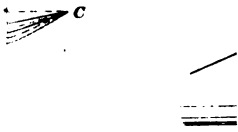



CHAPTER XXIII.

CONTINUOUS GIRDERS AND CANTILEVER BRIDGES.

248. Continuous Girder Bridges.—The mechanical principles by which the stresses in a continuous girder are governed have been fully considered in Chapter IX. ; and we have traced out in that chapter a geometrical method by which the diagram of moments may be constructed for a bridge of any given spans under any given distribution of load. As the stress at each point in the bridge depends upon the number and the relative width of the several spans, it is obvious that each case must be separately treated, and that no useful object would be gained by exemplifying the application of the method in detail to any particular bridge of this class.

In calculating the maximum stresses, it will often be sufficient to assume that the rolling load covers—first, the whole length of one span, then the whole length of the next span, and so on throughout the bridge—and then to take the greatest stress produced by any combination of loaded spans ; but if it is desired to find the stresses due to any intermediate position of the rolling load, the calculation may be made by the methods described in Chapter IX.

In bridges of *moderate span* it will also be generally sufficient to assume that the dead load is uniformly distributed ; but it may be observed that the weight of the main girders will in practice be considerably greater at the piers than at the centre of the span ; and in large bridges this inequality will have an important effect upon the stresses. In all *long span* bridges, therefore, it will be necessary to find approximately the actual distribution of the metal in the main girders, and to construct the diagram of moments accordingly.

For this reason the weight of a continuous girder of very wide span cannot be accurately calculated on the principle that we have adopted for other forms of construction, and it would consequently be useless to attempt any determination of the coefficients μ , μ' , and μ'' . In the case of a parallel girder supported at each end, the flanges have their greatest section at the centre, while the web-members have their greatest section at the ends of the span ; and if we include the end-pillars as a portion of the web (as we have always done) the weight of the main girder may be taken without any serious error, as being uniformly distributed. In the case of the parabolic girder, the distribution of metal is

still more uniform, the flanges being slightly heavier at the ends, while the web is slightly heavier at the centre of the span; but in the continuous girder, the flanges as well as the web-members have their greatest sectional area at the piers, and the weight of the girder per foot lineal is considerably less at the centre than at the ends of the span.

This distribution of the weight is of course a favourable one, and is attended with a valuable economic advantage in bridges of great span, although it is hardly worth considering in spans of less than 200 or 300 feet.

Whatever may be the actual distribution of the dead and live load, the stresses in any one span of the bridge may readily be found as soon as we have ascertained the value of the "pier moments," or the position of the points of contrary flexure. For when these values are known, we have only to draw the straight base-line across the diagram of moments, as explained in Chapter IX., and we have at once the positive and negative bending moments at every point in the span. Thus in Fig. 231, Plate L., let the curve ABC represent the diagram of moments for *any* given distribution of the load upon the span AC (considered as an independent span), and let Aa and Cc represent the pier moments, or let f and f_1 represent the two points of contrary flexure; then drawing the straight line aff_1c , we have the positive and negative bending moments represented by the ordinates above and below that base-line.

249. Mechanical Adjustment of the Points of Contrary Flexure.—

In a continuous girder, properly so called, the value of the pier moments (or the position of the points of contrary flexure) is determined by the continuity of the girder and by the resulting conditions which govern its elastic deflection. The calculation is therefore laborious, and has to be repeated for each new position of the load, while the results are to a certain extent ambiguous, and rest upon assumptions which can seldom be made to correspond with the actual facts.

But if we destroy the continuity of the girder by severing it at certain points, or by introducing a form of connection which practically amounts to a hinge at each of those points, we may avoid all this complexity and ambiguity; for in this way the points of contrary flexure may be mechanically fixed, just as they were fixed in the arched rib or rigid suspension rib by the employment of the same means.

These advantages can be obtained in the girder bridge, as in the arch or suspension bridge, without sacrificing in any degree the stability of the structure; provided that in each case the hinges are so situated that no distortion of the whole structure can ensue by the turning of these hinges.

In the case of the arched rib, no distortion of the structure could ensue from the introduction of a single hinge at the centre, and in the same way hinges may be located in the continuous girder, subject to the same conditions, by two or three different methods.

Thus, for example, in Fig. 231, it is evident that if the girder is

hinged at f and at f_1 , those points must of necessity become the points of contrary flexure, and the structure will practically consist of an independent girder ff_1 , supported at each end by the cantilevers zf and ef_1 . This method of construction is followed in each of the examples shown in Plate L., Figs. 233, 234, 235, and 236; and it is obvious that the introduction of the hinges can be attended with no possible distortion of the structure under any position of the load, provided that the cantilevers zf and ef_1 are rigid girders extending across the side spans, and are anchored down as well as supported at the points z and e .

A similar, and nearly equivalent, result may be obtained by placing the hinges in the side spans instead of in the central span.

Thus in Fig. 232, if a hinge is introduced at z and another at e , the base-line ze will again be the datum-line of the diagram, and between those points the stresses under the uniform load will have the same value as before, and will be defined with equal precision. This method is followed in the Kentucky bridge already illustrated in outline in Fig. 141. The bridge consists¹ of three equal spans of 375 feet each, and each of the side spans is hinged at a point whose distance (za) from the adjacent pier is 75 feet. In this case there is of course no necessity for any anchorage at y and g , as the girder can never exert any lifting force at those points; and if the girder is a rigid continuous beam from z to e , no distortion of the structure can take place under any position of the load.

The hinges may therefore be located either in the central span or in the side spans, and in each case the girder may be supported at the piers A and C upon rocking bearings, or so that they are capable of assuming freely any slope that their elastic deflection may give them; and the introduction of these hinged bearings will not in any way destroy the perfect stability of the structure.

On the other hand, it is hardly necessary to observe that hinges must not be introduced simultaneously in the side spans and in the central span, as this would destroy the stability of the structure just as effectually as the introduction of two hinges in the length of an arched rib.

250. Cantilever Bridge Hinged in the Side Spans.—The bending moments at all points of a cantilever bridge will depend upon the load that may be imposed upon the hinged portion; that is to say, *the pier-moments will be fixed by the load upon the hinged portion without reference to the load upon the portion that is not hinged.*

Thus if the hinges are placed at z and at e in Fig. 232, the moment Aa will depend solely upon the load that may be imposed upon the span ya ; while the moment Cc will depend solely upon the load that may be imposed upon the span cg .

For any given loads upon the side spans, the moments Aa and Cc can readily be found by the formulæ or the graphic methods described in Chapter IV., and these moments being laid down upon the diagram,

¹ Vide *Proceedings of the Institution of Civil Engineers*, vol. liv.

the straight line ac will form the base-line for the moments of the central span, *whatever may be the load upon that span.*

The bending moments in the central girder will then depend also upon the loading of that girder, and if the curves ABC and AB_1C represent the moments for the central span under a light load and under a heavy load alternately, the bending moments will be represented by the ordinates measured from the straight base-line to each of those curves alternately.

The points of contrary flexure, in the continuous unbroken girder of the central span, will therefore change their position with each change in the distribution of the rolling load; but their position can always be found by a simple calculation of the moments, and without any reference to the deflection or elasticity of the girder.

In calculating the maximum and minimum stresses in such a bridge, it follows from what we have said that the side spans za and eg may be treated separately and with reference only to the maximum and minimum loads upon those spans. But to find the greatest flange stress at any point in the central span, we must consider the bending moments that take place when the side spans are lightly loaded, and also when they are heavily loaded and the central span lightly loaded. It will also be necessary to compute the stresses for the case in which one side span is lightly loaded and the other heavily loaded, and this will be especially necessary in determining the stress in the web-members.

There will be no difficulty in treating each case according to its own particular conditions, with the aid of the formulæ and the methods of calculation already described.

To provide for changes of temperature, it will of course be necessary to allow for the longitudinal expansion and contraction of the entire length of girder; and this will generally be done by fixing the girder to one of the piers, and by placing all the remaining points of support upon rollers.

251. Cantilever-and-Girder Bridge.—If a continuous girder of three spans is hinged at two points in the central span, as for example at the points f and f_1 in Fig. 231, the structure becomes a cantilever-and-girder bridge, consisting virtually of the central independent girder ff_1 carried upon the ends of the balanced cantilevers zf and ef_1 , and would generally be designated as a "cantilever bridge."

Here, again, the pier-moments are determined solely by the load that may be imposed upon the *hinged portion* of the structure, *i.e.*, upon the central span ac , and are independent of the load that may be carried upon the side spans.

Therefore the maximum and minimum stresses at any point in the central span ac may be calculated independently, and with reference only to the maximum and minimum loads upon that span.

But, as before, the stresses in the unhinged portions za and ce will depend not only upon the loading of those portions, but also upon the

loading of the central span ; and we shall again find that in the continuous spans za and ce , the point of contrary flexure may sometimes change its position according to the distribution of the rolling load.

For example, let the curve ABC in Fig. 231 represent the curve of moments for the central span ac considered as an independent girder supported at a and at c ; and loaded with the dead load only.

Then if f and f_1 represent the points at which the girder is hinged, we have only to draw the horizontal line zff_1e , and the ordinates above and below that line will represent the positive and negative bending moments at all points in the bridge ; so that Aa and Cc will represent the pier moments.

The side spans za and ce will be always weighted by their own dead load, and sometimes also by the rolling load covering those spans ; and as before mentioned, they will of course have to be anchored down at z and at e , as well as supported at those points. For any given distribution of load upon the central and side spans, we can readily find the magnitude of the downward or upward force that must be applied at z and at e to counterbalance the bridge, by applying the method of moments described in Chapter IV. ; and the curve of bending moments zA and Ce , for each of the side spans, may then be constructed, or the bending moments calculated in the manner described in that chapter.

Thus if the arm az is equal in length and in weight to the arm af , and is weighted with the dead load only, the curve zA will be similar to the curve fA , and at every point between z and a the girder will be subject to a negative bending moment.

But if the span za is now covered with a rolling load, the curve of moments will be changed and will assume some such form as the curve zsA . The girder will then be subjected to a negative bending moment at all points between a and s , and to a positive or sagging moment for the remainder of its length, so that a point of contrary flexure will now make its appearance at s .

We can easily discover whether, in any given case, the girder will be liable to a positive bending moment, by examining the direction of the vertical force which acts upon the girder, or of the opposite force exerted by the girder, at z . If the girder exerts an upward pull upon the anchorage, the bending moment will be always negative ; but if the girder exerts a downward pressure upon the abutment the moment will always be positive for some portion of the length.¹

Thus, for example, in the case of an equal-armed cantilever, we may take it that if the construction and weight of the tail-end za are the same as in the projecting portion af , the cantilever will be exactly balanced upon the pier A so far as its own weight is concerned ; and therefore the vertical pull of the anchorage at z will be simply equal to half the weight of the independent girder ff_1 , supposing that no rolling load is present on any part of the bridge.

¹ This question was fully examined in Art. 26.

But if the span $za (= L_1)$ is now covered with a rolling load, of intensity q , that load will exert about a the moment $\frac{qL_1^2}{2}$, and would, in itself, cause the girder to exert a downward pressure at z equal to $\frac{qL_1}{2}$.

Therefore if $\frac{pl}{2}$ denotes the half weight of the independent girder ff_1 , the vertical force, which must be applied to the cantilever at z , will be either an upward or a downward force according as qL_1 is greater or less than pl . In the former case the girder will be subjected to a positive bending moment for some portion of its length; but in the latter case the bending moment will always be negative throughout both arms of the cantilever.

If we design the cantilever bridge with such proportions that the central girder ff_1 has a great length in comparison with that of the side-span za , we may avoid the occurrence of any reverse bending stress in the side spans; but with the proportions that are most commonly adopted, we shall have to provide for that reverse bending stress.

252. Different Forms of Cantilever Bridge.—Proceeding upon the last-named principle, viz., that of locating the hinges in the central span, the cantilever bridge of three spans may be constructed in a variety of forms according to the outline that may be selected for the cantilevers and for the intermediate girder; and these questions will have to be considered in connection with the lateral stability of the bridge, the resistance to wind pressure, and the provision for expansion and contraction due to changes of temperature.

The cantilever principle has been adopted, of late years, for some of the largest railway bridges; and its economic advantage as compared with other forms of girder is so great that it may sometimes be employed in preference to a simple independent girder for crossing a single span of great width, even although the side spans may be unnecessary for any other purpose than to balance the central span.

This seems indeed to have been the object in the case of the St. John's River Bridge, where it would appear that the side spans might easily have been constructed in much lighter form by any of the ordinary methods, or by viaducts consisting of several short spans; but the cantilever principle appears to have been adopted in order to facilitate the construction of the central span, which has a width of 477 feet.

The general form of this bridge is illustrated¹ in diagrammatic outline in Fig. 233, which is a half elevation representing one cantilever and one half of the central independent span. In the same way Figs. 234, 235, and 236 represent, in half elevation, the forms of design which have been adopted in other and still larger bridges.

The little intermediate span, between the cantilevers, is in all cases crossed by an independent girder constructed in some one of the forms

¹ Vide *Engineering*, vol. xlii.

which are already familiar to us; and in each case the cantilever consists of two arms of equal or nearly equal length balanced upon the pier, and of course anchored down at the tail-end; but the construction of the cantilever is different in each case.

In Fig. 233 the cantilever has a tapered form, the lower or compression member being horizontal, while the upper member is inclined in straight lines. The cantilever has a central depth of 80 feet at the apex, while each arm has a length of 190 feet. The railway platform is carried between the lower booms. The upper or tension member is formed of steel eye-bars like the chain of a suspension bridge; but in order to provide against the compressive stress due to the positive bending moment mentioned in the last article, the upper member of the side span is formed as a braced strut for the first three panels from the anchorage.

In Fig. 234 the tapering of the cantilever is exactly reversed; the railway is carried upon the upper chord, which is horizontal, while the lower member is laid in straight inclined lines. This figure represents in principle the form adopted in the Niagara bridge and also in the bridge over the Fraser River. The former has a span of 470 feet between the piers, the cantilevers being 56 feet deep in the centre; while the latter bridge has a central span of 315 feet, the maximum depth of the cantilevers¹ being 35 feet. In both of these bridges the upper straight member is formed, as in the previous example, of steel eye-bars, the same precaution being taken against the reverse bending stress.

Fig. 235 represents the half elevation of a bridge which is proposed to be erected across the St. Lawrence at Quebec, and for which the engineers are Sir James Brunlees and Mr. A. Light, with whom the author of this work is associated as joint assistant engineer. Owing to the great depth of the estuary, it is impossible to cross the channel with a less span than 1442 feet in the clear, the depth of water in the central channel being nearly 200 feet. The cantilevers have a maximum height of 258 feet over each of the river-piers. The lower member is a straight horizontal boom of tapering form, while the upper member is designed with the curved outline shown in the figure. The upper member is composed of steel eye-bars throughout; and the reverse bending-stress in the side spans, which has before been alluded to, is annulled by straining the girder over an intermediate support or tower built a few feet in advance of the anchorage-abutment.

It will be seen that the vertical shearing stress in the arms of the cantilever is borne partly by the inclined upper member and partly by the diagonal ties of the web. This vertical stress accumulates from each end towards the piers, where the whole of it is borne by, and equally divided between, the four radiating struts or pillars which spring from the summit of each pier, like the arms of a fan. The cross section, Fig. 235a, shows that the bridge is designed as two single-line bridges united by transverse bracing. Each line of railway is carried upon the back of

¹ Vide *Engineering*, vol. xxxviii.

the lower compression-boom, and passes through the little archways at the base of the steel pillars, as shown in the figure. The compression-boom of each single-line cantilever is built of H section (resembling the strut of the American Bridge Co. upon a larger scale), and carries the railway upon the cross-bar of the H.

Lastly, we have in Fig. 236 an outline sketch illustrating the general form of one of the cantilevers of the Forth Bridge, which is now being erected under the direction of the engineers, Sir John Fowler and Mr. B. Baker; and in this great work our list of bridges comes to a fitting termination and climax. To the engineers of this bridge belongs the credit of introducing the cantilever system for long-span bridges; and in regard to the structure itself, it is probably not too much to say that it is unequalled by any other work of human construction, whether as regards the boldness of its design, or the magnitude of the natural difficulties that have to be surmounted in its execution.

It would be out of place to enter here upon any detailed description of this bridge,¹ but we may briefly remark that each of the two principal spans has a width of 1700 feet, the cantilevers having a maximum depth of 343 feet, and a projection of 680 feet. The main compression member has a curved outline, and, like all the other compression members, is formed of hollow tubular section, built of steel plates with internal stiffeners. The sides of the cantilevers, and the columns which rise from the piers, are battered in each direction, so that at the base the cantilevers have a lateral width of 120 feet from centre to centre of columns; while at the centre of the span the width of the bridge is reduced to about 32 feet.

253. Distribution of Weight, and Calculation of the Stresses.—In a cantilever bridge of great span, the weight of the main girders is so unequally distributed that it would be useless to calculate the stresses upon the basis of any assumed weight per foot lineal. Fortunately, however, this form of girder admits of being treated step by step—at least so far as the central span is concerned; for it has already been remarked that the maximum and minimum stresses in the central span are determined solely by the maximum and minimum loads upon that span.

In practice the most convenient plan will be to begin by tabulating the stresses in each member due to each element of the load, in the manner already described, *i.e.*, either the stresses due to a unit load placed upon each joint, or those due to a distributed load of unit intensity spread over each panel. Then, to find the actual stresses, we have only to multiply the figures of this table by the actual panel-loads as soon as those loads are ascertained, which may be done as follows, commencing at the centre of the span.

The short independent girder, which spans the gap between the cantilevers, may be treated by the methods already described, and its weight

¹ *Vide* Mr. Baker's paper on the Forth Bridge, read before the British Association at Montreal, and published in *Engineering*, September 1884.

having thus been estimated, the load upon the extreme end of each cantilever will of course be one-half of the weight of that girder plus one-half of its rolling load. This total load being multiplied by the figures of the table, we shall at once obtain the stress in each bar of the cantilever due to the weight of the independent girder and its load; and the stresses thus given *for the members of the first panel* in the cantilever will represent very nearly the maximum stress upon those members. For the table will show at a glance that the only stress remaining to be added to those members is the stress due to the weight of the dead and live load upon the panel itself, and the weight of this panel may be provisionally estimated as being only slightly greater than the weight per foot of the independent girder.

Then calculating the required sectional area and the weight of each member in the first panel, we obtain the exact value of that panel-load; which in like manner has to be multiplied by the figures in the table corresponding to that panel-load.

Thus we may obtain the actual weight of the total load on each panel in succession; and may successively fill up the table of maximum stresses for each member of the cantilever.

The process, in fact, consists in treating each panel as a bracket, or as a pair of brackets (according to the character of the bracing); the bracket being loaded with a known weight at its outer end, and subject to no other stresses except those arising from its own weight and the weight of its own length of platform. The process would be quite direct and simple but for the necessity of estimating the latter items beforehand. But after a few trials it will be found that there is no difficulty in guessing these items with tolerable accuracy, as the weight per foot increases gradually in each successive panel; and if the first guess should be inaccurate, the error is rectified at once in dealing with the panel in question, so that no ambiguity remains in regard to the subsequent calculations.

At each step of the calculation, it is of course necessary to add the weight of the platform and wind-bracing upon the panel in question; these items having been first ascertained by a measurement of the quantities of material contained in the platform as designed, and in the members of the wind-girder. In practice, therefore, the calculation of the wind-stresses and of the consequent weight of wind-bracing, must form the first step in the design of any long-span bridge.

254. Weight of the Cantilever Bridge.—As already mentioned in the last article, it will be impossible to estimate the total weight of a cantilever bridge by the methods which we have employed in other forms of bridge-construction.

We have broadly considered, in Chapter V., the stresses that take effect in a cantilever bridge or a cantilever-and-girder bridge, under the uniform load—both when the girder is of uniform depth and also when the depth is proportional to the bending moment; and in the next chapter

we examined the methods by which the weight of a girder may be calculated from the known stresses.

Those methods would afford an easy solution if we could only assume that the dead load is uniformly distributed ; but if we omit to consider the unequal distribution of metal in the cantilever bridge, we shall be neglecting the chief source of the economic advantage that belongs to it.

Whatever form of bridge-construction we may adopt for carrying a given load, we shall have to provide in some way for the bending moments due to that load ; but the magnitude of those moments will depend chiefly upon the intensity of the load *at and near the centre of the span*, and in much less degree upon the intensity of load at and near the piers. The distribution of the *live* load cannot be modified by the selection of any particular form of girder, and the same is true as regards the dead weight of the platform ; but so far as the weight of the girder itself is concerned, we can greatly reduce the intensity of the load at and near the centre of the bridge by adopting suitable proportions in the cantilever bridge,¹ and although we may thus increase the intensity of load at and near the piers, yet there will be a large balance of advantage in favour of this altered distribution.

To illustrate the point still further, suppose that the curve *ABC* in Fig. 231 represents the moments due to *any* given distribution of the total load. Then we have seen that if the girder is of uniform depth throughout, and hinged at the points *f* and *f*₁, the flange-stress, and the mass of metal in the flanges, will be represented by the areas contained between that curve and the straight line. On the other hand, if the depth of the girder is made proportional to the bending moment, or if we adopt the outline of the diagram of moments in Fig. 231 as the elevation of the girder, the horizontal stress in the flanges of the independent girder or bowstring *ff*₁ and of the cantilevers will be uniform throughout. The united sectional area and weight of the two principal members or flanges will then be nearly twice as great as in the arch or suspension bridge, and will be distributed almost uniformly over the whole span.

This view of the case would seem to indicate that the arch must be more economical than the cantilever whatever may be the given distribution of the load ; and there can be no doubt that it would be far more economical than a cantilever *of the proportions shown in Fig. 231*. But in the cantilever bridge we are not obliged to adopt such an extremely small depth of bowstring, and by increasing the depth of this intermediate girder and the depth of the cantilevers at their extreme ends, we can greatly reduce their weight per foot lineal at and near the centre of the bridge. In fact, there can be no doubt that this portion of the span can then be constructed for a smaller weight per foot than would be possible in the arch or suspension bridge, notwithstanding the fact that we have two principal members to construct in the place of one.

¹ So far as the author is aware, this economic feature of the cantilever system was first pointed out by Mr. B. Baker in his work on Long-Span Bridges.

On the other hand, we must always expect to find that the weight of metal in the cantilevers at and near the piers will be much greater than that of the arch or suspension bridge; and the balance of advantage on the whole can only be ascertained by a detailed comparison in each individual case.

To obtain the full advantage of the cantilever system, it is tolerably clear that the bending moments at *and near* the centre of the span must be kept at the lowest attainable figure, or nearly so; that is to say, the independent girder ff_1 must be made to extend over a small portion only of the total span; but the best value of the ratio $\frac{ff_1}{ac}$ will depend upon the width of the total span.

Taking the best proportions of intermediate span to total span, and the most economic depth of cantilever for each span, Mr. Baker estimates the total¹ weight of steel cantilever bridges for spans of 1500 feet to 3000 feet as follows; the weight of platform and wind-bracing in each case being estimated by the formula $p = \frac{1}{8} \sqrt{L}$, referred to in Art. 245:—

	Span.			
	1500 Feet.	2000 Feet.	2500 Feet.	3000 Feet.
Main girders	6·85	12·33	24·33	80·18
Platform and wind-bracing . . .	0·75	·87	·97	1·07
Total weight of steel in tons } per foot	7·60	13·20	25·30	81·25

These figures include not only the weight of the whole structure between the points of support, but also that of the end pillars, or vertical towers and bracing, which are erected upon the summit of each pier.

255. Deflection of the Cantilever Bridge.—The deflection of a cantilever of uniform depth has been considered in Arts. 84 and 86, and that of a balanced cantilever in Arts. 88 and 89. To apply the same principles to a cantilever of varying depth, it is only necessary to remember that the element of deflection due to the strain of the flanges in each panel will be inversely proportional to the depth of that panel; and in this way the deflection of a cantilever of any given outline may be calculated.

It was shown also in Arts. 88 and 89 that if the equal-armed cantilever is erected in a straight horizontal line when it is not strained by any load, the girder will assume an inclined position at its central point of support as soon as it is loaded upon both arms. If the cantilever is supported at the pier upon a rocking bearing, or is free to assume this inclined position,

¹ Vide Long-Span Bridges, p. 75.

the bending stresses will not be in any way interfered with, and the anchorage will come into play in the manner that has been hitherto assumed. But if the cantilever is supported at the pier upon a broad bearing, or is fixed in direction at that point, the vertical force at the anchorage will be considerably affected, and may be reversed in direction. In this case the bending stresses throughout the side spans will of course be greatly altered, and the negative bending stress may extend further than that which we have already noticed as due to unequal loading.

In order to bring the anchorage force into play in the manner that is naturally assumed in a cantilever bridge, the girder must lie naturally in a horizontal position over the pier, and the tail end must therefore be *depressed* by the amount due to its natural deflection. If this adjustment is made during erection, the cantilever may be made to act in the normal manner so far as the dead load is concerned, the tail end being adjusted with an initial depression equal to the calculated deflection due to that load. It will then be only necessary to consider the further deflection due to the live load; and the stresses as affected by this deflection can only be ascertained by reference to the elasticity of the several parts of the structure. This would involve a very complex investigation, whose general outline may be gathered by observing that if the girder were *rigidly* fixed at the pier, the side span would become a beam fixed at one end and supported at the other; and it would then be found that the attachments at the pier have to resist a "couple" of very large magnitude; but in consequence of this couple the "rigidity" or fixity at the pier would become modified, owing to the elastic strain of the diagonal bracing over the pier.

The same consideration must also be borne in mind in dealing with the wind-stresses in a cantilever-bridge; for here it is impossible to provide that initial deflection which would be required to bring the anchorage into play.

256. Relative Economy of Different Forms of Bridge-Construction.—In comparing the cost and weight of different forms of bridge, it will always be necessary to take into account the local conditions, and especially the natural features of the ground.

Referring in the first place to long-span bridges, it is evident that when the problem to be solved consists simply in finding the best means of crossing a single wide opening, the cantilever bridge is under a disadvantage owing to the necessity of constructing two side spans, whose united length and weight will be nearly equal to that of the central span. In such a case the cantilever system would effect no saving as compared with the total weight of an independent girder, a bowstring, or an arch, unless its weight per foot lineal were less than one-half the weight of the other structures.

In this respect the rigid suspension bridge is under the same disadvantage, because the combined weight of the towers, backstays, and anchorages would again be nearly equal to the weight of the central span.

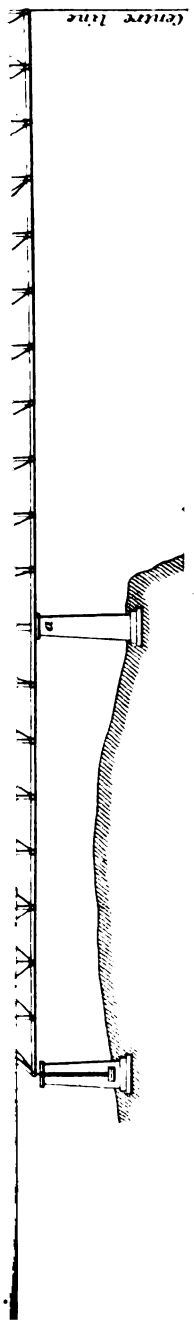



Therefore if the object in view is to cross a single opening, we shall have to take the calculated weights of ironwork in the rigid suspension bridge and in the cantilever bridge, and multiply each of them by 2, and then compare them with the weights of the other structures. And in comparing the suspension with the cantilever system we must debit the former with the cost of the masonry abutments.

But when the river or estuary admits of being conveniently crossed by a bridge of three spans, the central opening being about twice as great as the side openings, the case becomes very different. There we may take it that the choice will lie between a continuous girder of uniform depth, a cantilever bridge, and a rigid suspension bridge.

For moderate spans the continuous girder will probably be almost as economical as any other form of bridge; but for very large spans it will run into too much weight, and the only possible forms in which the bridge can be built will be the cantilever and the suspension bridge.

In comparing, for such a case, the relative economy of these two types of construction, reference may be made to the calculated weight of the rigid suspension bridge, as given in Art. 245; but in comparing these with the estimate quoted in the last article it must be remembered that we have to add to the suspension bridge not only the cost of the masonry abutments, but also the weight of the anchorages contained in the abutments, and the weight of metal in the towers.

As a general rule, it may safely be said that there is no form of bridge which can be considered the best for all situations; and this applies to small as well as to great bridges.

Referring now to bridges of moderate span, we have already considered in detail the economy that may be effected by a judicious choice in the type and general proportions of the bridge, and also by adopting an efficient form of tension-member and an efficient section of strut. But in selecting between different forms of bridge-construction, or between different arrangements of detail for bridges of great or small span, regard must always be had to the practical cost of production, the relative prices of different materials and of different classes of workmanship, the local facilities for the manufacture of this or that class of work, and last but not least, the practical difficulties to be surmounted in the erection of the bridge.

CHAPTER XXIV.

ON WIND-PRESSURE AND WIND-BRACING.

257. One of the most important questions that we have to deal with in the construction of large bridges is the pressure of the wind. For it is obvious that the stability of a bridge does not depend merely upon its power of carrying weight; and the main purpose of all our calculations will be defeated unless we also take into account the stresses due to wind-pressure.

In bridges of very large span, it will often be found that, notwithstanding the great weight of the structure, the stresses produced in some of the members by a gale of wind are almost or quite as great as those produced by the whole dead and live load.

Thus, for example, in the principal members of the Forth Bridge, the maximum stresses due to these separate forces have been estimated by Mr. Baker as follows:—

Stress due to dead load	2282 tons
,, live load	1022 „
,, wind	2920 „
		6224
Total	

It appears, therefore, that in designing bridges of such magnitude, a correct estimate of the wind forces is quite as important as a correct estimate of the load; but it must be confessed that the knowledge we actually possess upon this subject is at present very small, and totally inadequate to the requirements of modern engineering.

Of course the existing lack of information is partly due to the nature of the subject; for it is hardly possible to define with any precision what degree of violence can be taken as representing the greatest wind-storm that we have to provide against; but on this head we have a tolerably extensive array of observations; and the uncertainties which still surround the question are in much greater measure due to our ignorance as to the true application and bearing of the data that we already possess.

It may, perhaps, be conjectured, that until the destruction of the Tay Bridge by a wind-storm in 1879, the question of wind-pressure had hardly received from practical engineers the attention and the studied research which its importance really demands. The wind-pressure upon

any given bridge was calculated (if calculated at all) by the arbitrary rule of multiplying an assumed pressure in pounds per square foot by "the superficial area of the structure;" but it is obvious that such a rule can have no definite meaning unless the area of the structure is in some way defined; and as one engineer would measure the area "seen in elevation," while another would take twice or perhaps four times that quantity as the effective area of the structure, the result of the calculation would of course vary accordingly.

Thus in the case of a bridge consisting of a pair of double-webbed lattice girders, it is evident that each lattice bar shown in the general elevation represents in fact four lattice bars which are situated in a direct line, one behind the other; and if the wind happens to blow exactly broadside on to the bridge, it may perhaps be conceived, rightly or wrongly, that the front bar would shelter all the others; but if the wind happens to veer a point or two, each one of the three leeward bars must be exposed to the direct action of the wind-stream, and must certainly experience *some* considerable pressure, although perhaps not so great a pressure as the windward bar.

In such a case it is certain that the effective area of the structure will lie somewhere between the area "as seen in elevation," and an area which is four times as great; but within these limits its value may vary to any extent, and unless it can be determined, the rule will have no meaning, and there will be very little use in fixing the standard wind-pressure at any determinable quantity per square foot.

But this example only illustrates *one* of the many questions that must be answered before we can apply any standard pressure per square foot. It is pretty evident that to find the total pressure upon the bridge, we must treat each bar separately, and must multiply the area of each bar (or the standard wind-pressure) by some coefficient, which will probably depend upon the distance intervening between that bar and the next bar to windward; but in addition to this it will be found that the coefficient for each bar depends also upon the figure of the bar's cross section, upon the contiguity of other members, and indeed upon the general form of the entire structure.

It is now evident that the whole question of wind-pressure will divide itself into two parts: first, to estimate the violence of the greatest wind-storm that has to be resisted, and to express it either by some maximum velocity or by the pressure exerted upon some body of fixed form and dimensions, such as a thin plate having an area of 1 square foot; and secondly, to calculate the force that would be exerted upon a bridge or a body of any given form by a wind-storm of the given intensity.

To determine the first question, a number of experiments have been made at various times. The *velocity* has been measured by several methods, and has been continuously recorded by the anemometers attached to meteorological stations in different parts of the world. The *pressure* exerted upon plates and other bodies has also been measured by means

of dynamometer springs, pendulum vanes, or Pitot water-tubes; or has been deduced from the observed overturning of walls, buildings, and railway-carriages, or from the heeling of ships at sea; while it has again been calculated from the observed resistance of the air to the rapid motion of certain bodies.

In each case, however, the effective pressure must depend upon the form of the body and upon some other conditions affecting the experiment; and, therefore, the several results of this *first* series of observations cannot be compared together, and cannot be applied to the purpose in view, except by referring to the questions involved in the *second* part of the inquiry.

For the latter purpose we must have recourse to another class of data, derived from what we may call *philosophical* experiments, whose object has been to ascertain the laws which govern the action of wind-pressure upon bodies of different forms and under different conditions. It is here that our knowledge is most at fault; and with the exception of some recent tests which have been made by Mr. Baker for the special purposes of the Forth Bridge, we are almost entirely dependent upon the labours of our ancestors, whose experiments were generally made upon a very small scale and with very imperfect apparatus. However, such as they are, we must first consider the principles that may be deduced or reasonably inferred from their results, as otherwise it will be impossible to make any practical use of the wind-pressures recorded by other observations.

258. Pressure and Velocity of the Wind.—It appears from the ancient authorities that the pressure of the wind varies, like that of effluent water, with the square of the velocity. It is true that this general law is not quite in accordance with the results of certain experiments upon the resistance of bodies falling or moving through the air; and, in the case of projectiles especially, the resistance of the air appears to vary according to some higher power of the velocity. But it has not yet been ascertained that the pressure of the wind is the same thing as the resistance offered by the air to a moving body; and it is generally assumed that, for such velocities of wind as are commonly observed in this country, the pressure is nearly proportional to the square of the velocity.

To calculate its value, Smeaton adopted the formula $p = \frac{V^2}{200}$, in which V is the velocity in miles per hour, and p is the corresponding pressure in pounds per square foot.

This rule has been generally followed, although its accuracy has often been questioned; and it is obvious that it can only apply to the pressure exerted upon a body of some particular form, such as a thin plate having an area of one square foot.

259. Pressure upon Surfaces of Different Areas.—It has also been assumed that the total wind-pressure upon any given surface is propor-

tional to its superficial area, or, in other words, that the pressure is uniform upon each unit of the surface. But this assumption is doubtful for many reasons.

In the first place, it was found by De Borda that the pressure per square foot on a plate 9 inches square is about 29 per cent. *greater* than on a plate $4\frac{1}{2}$ inches square, the velocity being the same in both cases.

But on the other hand it must be remarked, that the velocity of the wind-stream is not likely to be uniform at all points. The velocities recorded by a fixed anemometer are known to exhibit great variations from moment to moment; and this has been explained by supposing that the air does not move in straight parallel lines, but whirls occasionally in circular eddies, like those which may be noticed upon the surface of a running stream. Thus the average velocity recorded during any hour by a fixed stream-gauge would be greatly increased now and then whenever it happened to be struck by one of these whirling eddies; and in the same way the average velocity or average pressure taken over a wide section of the stream would be considerably less than the maximum pressures exerted here and there by an impinging eddy.

On this ground it has been argued that the average wind-pressure which takes effect at any one time over a large surface will be considerably less than the maximum pressure occasionally recorded by a fixed wind-gauge of small dimensions. This view has certainly been confirmed by the experiments recently made at the Forth Bridge, in which the pressures upon a small wind-gauge and upon a board 20 feet \times 15 feet were simultaneously recorded.

These records, taken at all sorts of wind-pressures, from the highest to the lowest, show that the average pressure upon the *large* surface is in general not more than *two-thirds* of the pressure upon the small wind-gauge, whose area was $1\frac{1}{2}$ square feet.

The area of the larger board was, after all, very small in comparison with the extent of surface exposed in a large bridge; and in the absence of further experiments in this direction, it is impossible to say whether the average pressure per square foot over the whole surface of a bridge would or would not be reduced to a still smaller fraction of the maximum local pressure. To determine this question, the experiment would have to be still further extended, and this might be done without much difficulty—not, perhaps, by enlarging the board, but rather by comparing together the simultaneous records of a series of wind-gauges fixed upon poles at different elevations, and placed side by side at considerable distances apart.

260. Pressure upon Curved Surfaces.—The force exerted by the wind upon any body does not depend merely upon the area which it presents to the wind-stream, but also upon the convexity or concavity of the windward surface; and we are sometimes forcibly reminded of this fact when we incautiously allow the wind to get on the wrong side of an umbrella.

It has been calculated by M. Bressé that the pressure upon a sphere ought to be one-half and upon a solid cylinder two-thirds of the pressure on their diametral sections. But taking the standard pressure on a thin flat plate as unity, it appears from Borda's experiments that the actual coefficient for the sphere is 0.41, and for the cylinder 0.57.

According to Didion, the coefficient for a parachute, whose depth is one-third of its diameter, is nearly equal to 2.00.

In practice it is usual to take a coefficient of 0.50 for round bars or cylindrical pillars; and we might perhaps infer that in the case of octagonal or polygonal bars the coefficient would lie between 1.0 and 0.50, according to the number of sides in the polygon; but on this point experiments are still wanting.

In the same way we might reasonably infer that the coefficient for bars of channel section, or for any bodies presenting a concave surface to the wind, will lie somewhere between the values found for a flat plate and for a parachute, or between 1.0 and 2.0.

In all such cases—and these are of very frequent occurrence—the coefficient will certainly be greater than unity; but its value can only be found by experiments which have not yet been made.

261. Wind-Pressure upon Solid Bodies.—We are constantly speaking of a wind-pressure per square foot of surface; but it would be misleading to suppose that the force exerted upon any body by the wind arises only from pressure upon the front surface. On the contrary, the action of the wind upon the sides and rear of the body must certainly be taken into account.

When the wind-stream meets the body, the stream-lines are deflected on each side, and converge again in the rear of the body, in some such curves as those sketched in Fig. 237. The pressure on the windward surface is due, in some degree at all events, to the convexity of the stream-lines on that side of the body; and for the same reason the concavity of the stream-lines at the rear is attended with a "negative pressure," or relative vacuum, which takes effect upon the leeward surface.

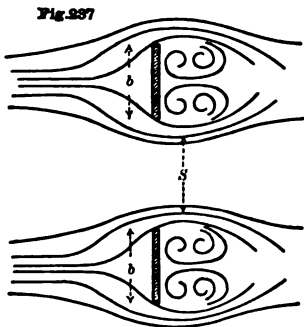

These respective effects may perhaps be illustrated by the elevation and depression of the water-level which may be observed on the up-stream and down-stream sides of a bridge-pier standing in a rapid current.

According to Du Buat and Thibault, the total pressure of a running stream of wind or water upon a fixed body is considerably greater than the resistance opposed by the fluid to a body moving at the same velocity; but in either case the pressure upon the front surface accounts for only two-thirds of the total force, the remaining one-third being due

to the negative pressure upon the rear. This applies, however, only to the case of a thin flat plate; and if we take a rectangular body of any other proportions, it appears from the experiments of Du Buat and Duchemin that the pressure on the front surface will be unaltered, while the negative pressure at the rear is reduced by increasing the thickness of the plate, or the length of the body in the direction of the wind stream; and therefore the total wind force will depend upon this dimension. Thus taking the effective wind-pressure upon a thin plate as unity, the total pressure upon a cube is found to be represented by the coefficient 0·80; while the pressure upon a prism presented endwise to the wind is about 0·72 for a length of two diameters, which is reduced to a minimum value of about 0·71 for a prism of three diameters; but for any greater length of prism the coefficient is found to be somewhat greater, owing probably to the skin-friction upon the sides of the prism.

These experimental data have an important bearing upon many of the questions at issue; and although further experiments are much needed, we may perhaps, in the meantime, draw the following conclusions:—

1. If a bridge consists of a pair of plate-girders, we shall have to reckon for the entire wind-pressure upon the windward girder as upon a thin plate; and we should have to add something for the additional, though perhaps reduced, pressure upon the leeward girder as another thin plate. But if the two girders are united at the lower edge by a continuous horizontal floor, and at the upper edge by a continuous plate, the structure will be converted into a rectangular box, as in the Britannia bridge, and the wind-pressure upon the whole structure will then be not only less than the total pressure upon the two girders above considered, but will be considerably *less* than the pressure upon one girder taken separately.

This is easily understood, because in the tubular bridge the front of the leeward girder is protected from any positive pressure, and the rear of the windward girder from any negative pressure; the former can only act upon the outside windward surface of the box, and the latter upon the outside leeward surface; while the contrary pressures upon the interior surfaces must be equal and must balance each other. At the same time the negative pressure is not so active as in the case of a single plate, owing to the greater width of the entire solid body.

2. In the majority of cases we shall have a pair of girders united at the lower edge by the continuous flooring, but not united at the upper edge. In such cases it is sometimes assumed that the pressure on the whole structure is augmented by the presence of the horizontal floor. But it is very doubtful whether the skin-friction upon the floor is not partially compensated or neutralised, or more than neutralised, by the protecting effect above described.

3. It is evident also that the total pressure upon a railway carriage is less than the pressure that would take effect upon one of its sides taken

separately, and the total pressure upon a house is less than the pressure experienced by one of its walls standing alone. We must therefore bear this in mind if we deduce from the observed overturning of buildings or carriages the maximum pressure of any wind-storm. Thus if we calculate the stability of a railway carriage as requiring a pressure of 30 lbs. per square foot of its area to overturn it, the overturning of that carriage would indicate a wind-pressure of $\frac{30}{0.8} = 37.5$ lbs. per square foot upon the thin plate, or thereabouts.

4. But again we must distinguish between the pressure experienced by a wall when standing alone and the pressure acting upon its outer surface when it forms the windward side of a house. In the former case we have the full effect of the negative pressure or vacuum at the rear, while in the latter case we have no such effect; and according to the data above quoted, the effective pressure would be reduced by one-third. Therefore if we find by experiment that it takes a uniform load of 30 lbs. per square foot to break the windows in a certain house, we may conclude that the breaking of those windows by a storm would indicate a pressure of something like $\frac{30}{0.66} = 45$ lbs. per square foot as measured upon a thin plate freely exposed to the wind.

It does not appear that these several facts have always been taken into account when the wind-pressure has been deduced from such observations.

262. Pressure of Wind upon a Grating.—Looking at the deflected curves of the wind-stream as they are sketched in Fig. 237, it would appear that the wind flowing through each orifice of a grating assumes something like the stream-lines of the “contracted vein;” and the question arises whether the effective pressure upon the grating is not proportional to the whole area of the frame minus the combined areas of the contracted streams s . This quantity would evidently be greater than the aggregate area of the bars b ; and in the case of a close lattice girder, the difference might turn out to be very considerable.

The author has long ago suggested that it would be worth while to ascertain this by direct experiment. M. Gaudard, however, takes it for granted, and expresses the pressure upon a lattice girder by the formula—

$$P = p (S - k\sigma)$$

in which p is the wind-pressure per square foot, S the entire area of the girder, σ the combined area of the openings, and k a coefficient of contraction. He also states that according to D'Aubuisson the value of k would be 0.65 for small orifices, but would probably vary inversely as the ratio of the perimeter to the surface, and would therefore approach to unity in the case of large openings.

263. Pressure of the Wind upon Bodies Sheltered by a Grating.—In most lattice-girder bridges, the case that we have to consider is really

that of two gratings placed one behind the other; and if it is difficult to ascertain the pressure upon the first, it is still more difficult to calculate the pressure exerted upon the second grating by the wind which filters through the first, or to find the value of the shelter that is afforded by the windward lattice. Evidently a close lattice girder will afford a better shelter than one consisting of large open panels and very narrow bars; and it is sometimes assumed that the wind-pressure on the leeward girder is reduced to a lower intensity which is proportional to the area of the orifices in the windward lattice; while M. Gaudard assumes that it will be proportional to the combined area of the contracted wind-streams,

$$\text{or } p_1 = p \cdot \frac{k\sigma}{S}.$$

But neither of these assumptions can be regarded as having any certain foundation; and the most that can be said is that they *may* be approximately true for bridges in which the girders are fixed at some particular distance apart, and in which the lattice bars have some particular form of cross section.

On the other hand, it is *probable* that the shelter afforded by the windward lattice depends partly upon the form of the bars, so that a grating of round bars, for example, would afford a less shelter than a similar grating of flat and thin bars.

And it is *certain* that the wind-pressure upon the leeward girder will depend *in very large measure* upon the distance between the girders.

264. Pressure of the Wind upon Bodies partially Sheltered.—In the case of most large bridges, consisting, as they generally do, of wide open panels and comparatively narrow bars, we may put aside the notion of a protecting grating, and may proceed to consider the wind-pressure upon any individual *bar* of the leeward girder, and the shelter it would receive from the corresponding bar in the windward girder. And to fix the ideas we will suppose the girders to be fixed at a distance of 20 feet apart, and that the bar in question is a vertical or diagonal brace, having a great length and a section of, say, 6 inches \times 1 inch.

To calculate the pressure upon the leeward bar, it is certain that, in the present state of our knowledge, we must proceed upon *some* assumption which will be more or less gratuitous; but the assumption ought to be at least consistent with common sense.

Now the long and narrow bar that we are here considering cannot afford a better protection to the leeward bar than would be given by an ordinary lamp-post; and we know by everyday experience that in a heavy gale of wind there is not much shelter to be found under the lee of a lamp-post at a distance of 20 feet from it. But this represents practically the amount of shelter that would be afforded under the most favourable circumstances, *i.e.*, when the wind is blowing exactly in the line of the two posts; and it is almost incredible that the wind-pressure on bridges should ever have been calculated on the assumption that the

windward bar would *always* afford a perfect and complete shelter to the leeward bar, whatever might be the direction of the wind.

In such a case, then, we may reasonably conclude that the wind-pressure upon the two bars will be nearly the same, or, in other words, that the total wind-force is nearly equal to twice the pressure upon the windward bar taken alone.

But now suppose that the two bars are placed side by side, and touching each other, as they may be, for example, at the joints of a suspension chain. Here it is evident that the total wind-force upon the two bars, or even upon twenty bars placed side by side, would be *less* than the wind-force upon one bar taken separately; for if twenty of such bars were packed together, we should have a solid rectangular body whose length is about three times its width of face, and the coefficient for such a body would be about 0.72.

Again, if we take out every alternate bar, or if we have a chain consisting of 10 bars with a space of 1 inch between them, the section will be only slightly changed, and each bar will be so well sheltered by its neighbours that the wind-force upon the whole chain can hardly be much greater than upon a single bar. It appears, therefore, that when the intervening distance is very small, the coefficient for the leeward bar will be almost zero; but when the two bars above mentioned are separated by a space of 20 feet it will be nearly equal to 1.0. For intermediate cases its value will *probably* depend upon the ratio of the distance to the width of bar, and probably also upon the form of the bar's cross-section; but upon these very important questions we have at present no adequate data for our guidance.

Taking two flat discs, placed one behind the other at a distance of one diameter apart, Thibault found that the coefficient for the leeward disc, measured separately, was about 0.70; but this result appears to be quite at variance with the recent experiments of Mr. Baker, who has found the following values for the *total* force exerted upon the two discs when placed at different distances apart:¹—

	Distance apart in terms of the Diameter.				
	1.0	1.5	2.0	3.0	4.0
Coefficient for total pressure .	1.0	1.25	1.40	1.60	1.80

It is worthy of notice that these values relate to the total force exerted upon *both* discs, or upon a bar or frame carrying the two discs, and are not derived from a separate measurement of the force acting upon the leeward disc. For it is quite possible, and indeed likely, that *the shelter is mutual*, or, in other words, that the leeward disc reduces the effective pressure upon the windward disc by protecting it against the negative pressure or "suction" on the rear surface—just as in the case of the

¹ Mr. Baker also found that the total pressure was but little increased by introducing a third disc between the two. Thus the coefficient is 1.80 when 3 discs occupy a total length of 3.6 diameters, or when 4 discs occupy a length of 3.5 diameters.

tubular girder, in which we have seen the same mutual protection afforded by each wall to its neighbour.

This mutual effect, which would partly explain the observed discrepancy between the results above quoted and the earlier ones of M. Thibault, may be described as follows without using the word "suction:"—

Let the absolute pressures upon the front and rear surfaces of the windward disc be denoted by p_1 and p_2 , while p_3 and p_4 denote the pressures upon front and rear of the leeward disc, as illustrated in Fig. 238, all these pressures being positive. Then the total moving force must be $p = p_1 - p_4 + (p_3 - p_2)$; and the quantity $(p_3 - p_2)$ will depend upon the motion of the air between the two discs.

In the tubular girder of Fig. 239 there is no motion of the air inside the tube, or at least none that can produce any difference between p_2 and p_3 ; the wind-stream being deflected in parallel lines above and below the tube.

If the discs are placed at a short distance apart, these parallel stream-lines are only slightly modified in some such manner as that shown in Fig. 238; the pressure p_2 will not be *greatly* reduced by the slight concavity of the wind-stream, and will be considerably larger than the pressure p_4 , which is greatly reduced by the concavity of the stream-lines at the rear of the leeward plate. Therefore the force acting upon the windward plate, or $p_1 - p_2$, will be considerably less than it would have been if the plate were standing alone, as in Fig. 237.

The deflection of the stream-lines also seems to indicate that each of the pressures p_2 , p_3 and p_4 will depend upon the distance intervening between the discs. This view of the case, if correct, would go far to explain the result obtained by Thibault; but further experiments are needed to determine the forces $(p_1 - p_2)$ and $(p_3 - p_4)$; and also to ascertain the value of the shelter afforded by long and narrow bars and by members having such forms of cross-section as are commonly used in bridge-work.

265. Dynamic Effect of Sudden Gusts.—Up to this point we have been speaking of wind "pressure" as though it were a static force; but every one must have noticed that it commonly produces the most destructive effect when it comes in violent gusts. We have already examined in Chapter XIV. the dynamic action of a load that is suddenly imposed upon an elastic bar or beam, and also that of a load whose magnitude is suddenly increased; and in each case we have seen that the variable

Fig. 238

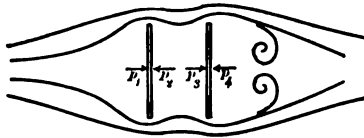
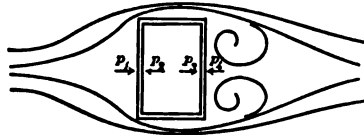

Fig. 239



portion of the load produces a stress and a deflection which are just twice as great as those due to the same load at rest.

Thus if we could imagine that after a period of perfect calm the wind-pressure could be instantaneously raised to a certain value p_1 , there can be no doubt that this sudden gust would produce in any iron or steel bridge a stress equivalent to that produced by a constant pressure of twice the intensity, or $2p_1$.

In the same way, if a wind blowing with a steady pressure p is suddenly augmented to the pressure $p + \Delta p$, the stress will be proportional to $p + 2\Delta p$.

But in each case this extreme stress would only be reached if the increment of pressure is *instantaneously* applied, and if it endures for a sufficient length of time to produce one complete vibration of the elastic body.

We know by common experience that in gusty weather the wind-pressure is subject to great variations, and that the pressure increases very rapidly when a gust comes on; but we can hardly judge, perhaps, whether the impulse is absolutely instantaneous, although it is certain that our nerve vibrations are sometimes not quick enough to give us adequate notice of its approach, and we often lose our hats in consequence.

But we have also seen that unless the pressure of such a gust is augmented by very slow gradations, which it certainly is not, the stress will always be greater than that due to the maximum pressure, and may be expressed by—

$$\Omega = \text{Max. } p + \eta (\text{Max. } p - p)$$

in which p is the steady pressure under which the bridge was in equilibrium before the advent of the gust, and η is a coefficient less than unity.

From these general principles it would appear that the following inferences may reasonably be drawn :—

1. If we are to allow for the effects of those stress-variations which are due to changes of *load*, it will be equally proper at least to make some corresponding allowance for those which are due to sudden changes of *wind-pressure*.

In both cases we are very ignorant as to the real value of the coefficient η , and not more so in one case than in the other. The *local* changes of wind-pressure will probably be more sudden than those changes which may be observed in the average pressure over a wide area; and probably the values before taken for the flanges and web of the main girder will be applicable to the corresponding members of the wind-girder, as nearly as any others that could be chosen in the present state of our knowledge.

2. The *deflection* of the bridge, or of any elastic body, under a sudden gust of wind will reach a momentary maximum proportional to the dynamic stress Ω . If the gust commences suddenly and lasts long enough to

produce a complete vibration, the extreme deflection will be twice as great as that due to the maximum pressure. Therefore when we are considering the records of any wind-gauge whose indications are measured by the deflection of a spring, we must be prepared to expect that these records will indicate a pressure which is considerably higher than the real pressure of the wind—at least in gusty weather, and that they will consequently disagree with such evidences of the wind-pressure as may be derived from other and independent sources.

3. For the reason last mentioned, some engineers have concluded that the indications of a dynamometer spring cannot be relied upon for calculating the wind-pressure upon bridges. This is no doubt true so far as the *pressure* is concerned; but iron bridges are elastic bodies, and the question is whether the dynamometer does not measure correctly the *stress* to which a bridge is liable under the dynamic action of the wind-gust. To compare the two cases together, it will be necessary to remember that in a large and heavy bridge the period of vibration will be very much longer than in the light spring of the wind-gauge. Thus a mere puff of wind might be enough to carry the dynamometer to the full extent of its proper vibration; while owing to its short duration the same puff might produce no appreciable effect upon the mass of the bridge. But on the other hand, it must be observed, that if the gust lasts long enough to sway the bridge across the full extent of its vibration, it will produce *the same stress* in the bridge as that indicated by the dynamometer.

Again, the wind-gauge will very likely indicate the successive effects of innumerable impulses following each other in quick succession; but in the case of the bridge the effects of these short-lived impulses will be integrated, as it were, and the maximum stress will be proportional to their average rather than their maximum energy.

In this respect the different conditions of the two bodies may perhaps be illustrated by comparing the behaviour of a small elastic twig and of a tall poplar-tree in a gale of wind. The oscillations of the smaller body are more rapid and sometimes more extensive (in proportion to its size) than those of the large tree; whose period of vibration may perhaps be not very different from that of a good-sized bridge; but the oscillations of the tree show pretty clearly that its maximum deflection is greater than that due to the actual wind-pressure at any one moment, and may serve to illustrate upon an enlarged scale that augmented deflection which we may certainly believe to take place in the tall iron piers as well as in the girders of a viaduct, and which must in like manner be accompanied by an augmented stress, or a stress greater than that due to the maximum wind-pressure.

It may easily be seen that these oscillations would be still further increased if a succession of gusts should happen to sway the bridge rhythmically, keeping time with its natural period of vibration; indeed it would be impossible to fix by theory any probable limit to such

dynamic action. Some valuable information might perhaps be gained by means of a continuously recording wind-gauge or dynamometer whose period of elastic vibration is made to coincide with that of an ordinary or of any particular bridge; but the author is not aware that any such experiments have ever been carried out.

266. Observations of Wind-Pressure.—The principles which we have imperfectly reviewed in the preceding articles, will help us to estimate the relative values of the different observations that have been made to determine the force of storms, or to determine the greatest wind-pressure that should be provided for in designing our bridges.

The various observations that have been recorded may be divided into measurements of velocity and measurements of pressure; and the latter quantity, as we have already noticed, has been deduced from two or three different classes of measurement, which must be distinguished from each other. The pressure exerted upon a thin plate which is freely exposed is a different thing from the pressure exerted upon a house¹ or upon a railway carriage, and a different thing from the pressure which acts upon the front surface of a thin plate inserted in the windward wall of a house.

Again, a gust of wind which begins suddenly to blow at a certain pressure may register twice that pressure upon a wind-gauge; but it will not drive an anemometer at a velocity equal to twice its own velocity, and it will not upset a railway carriage whose static moment of stability is greater than the upsetting moment of its own pressure. Therefore the pressures that have been registered or deduced by these several methods of measurement will have to be reduced to one common standard by dividing each of them by its proper coefficient.

For wind-gauges in which the pressure is measured by the frictionless resistance of a spring, the coefficient may be anything between 1·0 and 2·0, according to the steadiness or otherwise of the wind; and in some rare cases may even be greater than 2·0; while for other methods of measurement the coefficients proper to each case have been already considered; and dividing by these coefficients, we shall have in each case the equivalent wind-pressure upon a thin flat plate, freely exposed, and having an area of 1 square foot.

Thus, taking the coefficient of 0·50 for a round surface as applicable to the human body, it has been estimated that a man could not possibly stand (at any angle) against a greater pressure than about 23 lbs. per square foot upon the standard plate. But we know that in some storms it is not possible to stand without some kind of assistance.

With regard to the upsetting of railway vehicles, M. Seyrig has tabulated the weights and particulars of a number of carriages and vans which have been blown over, from which it appears that the side-pressure

¹ The coefficient for the effective pressure upon a house, or upon any solid body touching the ground at one edge, has not been determined; but in all probability it is much smaller than in the case of a railway carriage or of any elevated body which deflects the wind-stream both above and below.

necessary to overturn them varied from 26 to 30 pounds per square foot of their surface, and in one case reached 34 pounds per square foot; but in each case there were other vehicles in the same train which required somewhat higher pressures, and none of these were overturned. We have already seen in Art. 261 that a pressure of 30 lbs. upon the carriage is equivalent to a pressure of about 37·5 pounds upon the standard plate. Railway carriages are not often blown over in England; but it must be remembered that the wind-pressure on a surface so near the ground is certainly less than upon an elevated structure. On the other hand, it appears from the evidence of the Tay Bridge Commission, that the train which was crossing that bridge at the moment of its destruction was not blown over from the rails, although it was in a most exposed position, and practically unsheltered by the bridge.

On the whole, the evidence derived from railway carriages and other similar sources goes to show that the wind-pressure in this country is very seldom if ever greater than the values above quoted. But much higher pressures have been recorded by dynamometer springs; and this is only in accordance with what might be expected from the dynamic action mentioned in the last article. In fact, if we apply the several coefficients proper to each class of observation, we must expect to find that a squally wind, whose greatest actual pressure upon a railway carriage is 30 lbs. per square foot, will at one and the same time exhibit the following apparent pressures:—

1. By overturning carriages, 30 lbs. per square foot.
2. Pressure upon the standard thin plate, 37·5 " "
3. Pressure as recorded by a dynamometer, 40 to 75 " "

These figures represent pretty nearly the pressures actually recorded by the respective methods of measurement. Thus the wind-gauges erected by the engineers of the Forth Bridge have already registered pressures running up to 40 lbs., and in one instance to 65 lbs. per square foot, and in the latter case the momentary deflection of the spring would have been still greater if it had not been checked at that point by a fixed stop.

267. Existing Rules and Practice.—In estimating the wind-pressure and the resulting stresses in the members of a bridge, the practice of engineers has varied widely. As regards the standard pressure per square foot, a value of 30 to 40 lbs. has, until recently, been considered sufficient for any bridges in this country; while in America the figure has commonly been taken at 30 to 50 lbs. per square foot. But, as before mentioned, these figures have but little meaning unless the area of the bridge is in some way defined; and it is also necessary to consider the additional area of the train.

The engineer of the Pennsylvania Railway takes a pressure of 30 lbs. as applied to the area of the truss "seen in elevation," to which he adds the area of a train considered as a continuous wall, whose upper edge is 12' 6", and its lower edge 2' 6" above the rails.

But when the wind-pressure exceeds 30 lbs., it is assumed that there will be no train upon the bridge; and a maximum wind-pressure of 50 lbs. is taken as applying to the structure alone.

These two cases are taken alternately, and the maximum stress per square inch in the wind-bracing is fixed at 15,000 lbs. per square inch in bar ties, and at 12,000 lbs. per square inch in plate ties.

It would appear that in America a somewhat similar estimate of wind-pressure has been nominally adopted for many years past; but if we compare these pressures, taken over the area of a single girder only, with the actual section of the wind-braces in many American bridges, we shall find that the resulting stress would be very high indeed, and would sometimes approach, if it did not exceed, the elastic limit.

But the case is still worse as regards many English bridges, in which we sometimes find no wind-bracing at all, while in other bridges the bracing is totally insufficient to resist anything like the pressures above mentioned; and the fact that these bridges have stood for a great many years, along with many other structures whose resistance is even less than that of the weakest bridge, shows conclusively that no such pressures have been experienced in the localities where they are situated.

After the destruction of the Tay Bridge, a special committee was appointed by the Board of Trade to consider the question of wind-pressure; and the rules recommended by the committee are in effect as follows:—

1. That a maximum pressure of 56 lbs. per square foot should be provided for.
2. That the effective area should be taken at once to twice the front surface, according to the extent of the openings in the lattice girders.
3. That a factor of safety of four for the ironwork, and of two for the whole bridge overturning as a mass, should be adopted.

The author is not aware how far these rules may be modified in the case of small bridges erected in low-lying and sheltered districts.

268. Calculation of the Wind-Stresses.—In most bridges the wind-pressure, acting over the whole surface, will be resisted by a horizontal wind-girder lying in the plane of the bridge-floor, which in some cases may be assisted by another and similar wind-girder constructed overhead. Of course each class of bridge must be treated according to its design; but in the majority of cases the principal wind-girder or girders will have a uniform width, and may be considered as parallel girders with open lattice bracing; and the stresses may be calculated accordingly.

As regards the web-members of these wind-girders, or the diagonal wind-braces, it will be observed that a uniform wind-pressure, distributed over the whole span, would produce no stress at all in the central panel. But we cannot assume that the wind-pressure will always be uniformly distributed; and, on the other hand, we need not assume that the wind will blow with its maximum force over one half of the span while a per-

fect calm reigns over the other half. In practice the author has adopted the intermediate and more reasonable supposition—treating one half of the wind-pressure as a steady load distributed over the whole span, and the other half as a rolling load. At the same time, the whole of the wind-pressure acting upon the train must of course be taken as a rolling load, because it travels with the train.

The flanges of the wind-girder may sometimes be constructed independently of the main structure, or so that they have very little duty beyond that of resisting wind. But in ordinary cases these members will be constituted by the flanges of the main girders, and then it will be necessary to consider the greatest stress arising from the combined action of load and of wind.

On this question many engineers have adopted the view mentioned in the last article, viz., that there will be no train on the bridge when the wind blows with a greater force than 30 lbs. per square foot, and that consequently the bridge will be relieved not only of the *weight* of the train, but also of the wind-pressure on its surface. But perhaps this view is open to some reasonable doubt. It is true that when such a gale is blowing it would be hardly possible for a train to reach the bridge; but it is conceivable that it might be caught there by a sudden squall, and this indeed is just what appears to have happened in the case of the Tay Bridge.

269. Conclusion.—Reviewing the several questions that have been considered in this and some preceding chapters, it cannot fail to be noticed that there are many points on which further experiments are needed before bridges can be designed upon correct and positive principles. This is true as regards the working strength of iron and steel; and still more true in regard to wind-pressure.

On both these questions the existing data are really insufficient for the requirements of *ordinary* bridge construction; but of late years engineers have been called upon to design bridges of extraordinary dimensions, and it is here that the importance of correct calculation reaches its highest commercial value, while at the same time it is precisely in these cases that the greatest uncertainty exists.

We have seen, for example, how large a proportion of the metal in a long-span bridge is required for the purpose of resisting wind-pressure and for the purpose of carrying the metal that resists wind-pressure. But we have also seen that it is really impossible to estimate the wind-stresses within 100 per cent. of their real value. For if we look only at the different coefficients that are applicable to bars of different form and in different positions, we cannot help seeing that any standard wind-pressure that can be adopted will give results which may be twice too high for one bridge, and not half high enough for a bridge of another construction.

In this state of uncertainty, the responsible engineer will generally be disposed to err on the safe side; but it must be remarked that this

will be a very expensive proceeding. Indeed, any one who has been through the process of calculating the details for a long-span bridge cannot fail to be impressed with the fact that these uncertainties entail at each step a *direct* expenditure of some hundreds or perhaps thousands of pounds sterling, and an indirect expenditure which can only be measured in tens or hundreds of thousands; while at the same time he cannot help confessing that this lavish expenditure may be perfectly useless, for if the material is not really wanted for resisting wind-pressure, it can serve no purpose except to burden, and therefore to weaken, the bridge. On the other hand, he knows that an error in the opposite direction might be attended with still more disastrous results.

The information, whose absence seems to necessitate this wasteful expenditure, might certainly be obtained without any great difficulty or expense; and in view of its importance, it is surprising that measures have not been taken to obtain it.

But the experimental facts that are really wanted are facts of a certain class. We are already overwhelmed with experimental tests, which have been made with the most superb apparatus, for discovering the ultimate strength of particular specimens of iron, or for ascertaining the velocity of the wind at particular times and places; and there is not much further knowledge to be gained by a repetition of such experiments. But what is chiefly wanting is to extend and complete the *scientific* experiments of our great-grandfathers,—experiments which for the most part were conducted with simple and rudimentary apparatus, and were probably never intended to be applied to the vast problems for which we have been using them, but which possess the inestimable advantage that they were directed—not to the repeated measurement of one particular quantity, but to the discovery of truth.

INDEX.

- AMERICAN** and English practice compared, 89, 326, 332.
American Bridge Company's columns, 196.
American trusses. See **BOLLMAN, FINK, PRATT, KENTUCKY, LINVILLE, and OHIO.**
American Phoenix columns, 201, 202.
Analysis of moments due to a rolling load, 274, 275.
Angle iron struts, 190, 191.
Annealing iron wire, 214.
Annealing punched plates, 231.
Arch, derivation of, 45, 370.
— linear. See **LINEAR ARCH.**
— polygonal, 71.
Arched ribs, bending stresses, 361 to 364, 371 to 379.
—— deflection of, 387.
—— effects of temperature changes, 353 to 355, 357 to 359, 371.
—— rigid construction, 357 to 388.
—— stresses due to rolling load, 361 to 364, 371 to 379.
Asphalte, weight of, 264.
Auxiliary girders, in arches or suspension bridges, 357 to 361.
- BARs**, strength of wrought iron, 213.
— with swelled ends. See **EYE-BARS.**
Beam, loaded uniformly, bending moments, 48.
—— deflection, 127.
—— loaded with a single weight, moments, 45, 46.
—— deflection, 125.
—— strained over one pier, moments, 52, 55.
—— deflection, 128.
—— strained over both piers, moments, 54, 57.
—— deflection, 129.
—— stress in the extreme fibres, 22, 25.
—— shearing stress in, 36.
Bending moments. See **MOMENTS.**
—— strain, 22 to 37.
—— stress in columns, 155, 166, 170.
Board of Trade rules for working stress, 218, 219.
—— for wind-pressure, 416.
Bollman truss, construction of, 74.
—— stresses in, 75.
—— weight of, 100, 109.
Borda, experiments on wind-pressure, 405, 406.

- Bow-and-chain bridge, construction of, 72, 333.
 ——— economical proportions, 347.
 ——— limiting span, 346.
 ——— stresses in, 63, 64, 336 to 339.
 ——— weight of, 345.
- Bowstring girders, 65.
 ——— economical proportions, 347.
 ——— limiting span, 346.
 ——— stresses in, 63, 64, 333 to 338.
 ——— weight of, 101, 111, 343.
 ——— used as arches, 65, 363 to 369.
- Braced piers of viaducts, 207, 212, 327.
 ——— struts, 203, 206, 207.
- Bracing of bowstring girders, 64, 334, 336, 337.
 ——— of parallel girders, 64, 80 to 88, 280 to 303.
 ——— of rigid suspension bridge, 377, 378.
 ——— of suspended bowstring, 367, 368.
- Brickwork, weight of, 264.
- CAMBER** of girders. *See* INITIAL CAMBER.
- Cantilever bridges, construction of, 62, 64, 391 to 396.
 ——— deflection of, 121 to 124, 399.
 ——— stresses in, 62, 64, 392 to 397.
 ——— weight of, 397 to 400.
- Cantilever, loaded at the end, moments, 39.
 ——— deflection, 119.
 ——— loaded irregularly, 43.
 ——— loaded uniformly, moments, 41.
 ——— deflection, 121.
 ——— with fixed anchorage, moments, 44.
 ——— deflection, 121 to 124.
- Cast iron columns, 172 to 177.
- Cast iron, crushing strength of, 172.
 ——— tensile strength of, 215.
 ——— transverse strength of, 26.
- Cellular struts. *See* STRUTS.
- Centre of gravity, 20, 21.
 ——— graphically determined, 40, 41.
- Centre of elastic resistance in columns, 161 to 165, 167, 168.
- Centrifugal force, effect on deflection, 239, 240.
- Chain bridges. *See* SUSPENSION BRIDGE.
- Chains, flat link. *See* EYE-BARS.
- Channel-iron struts, 193 to 195, 206.
- Charing Cross Bridge, 300, 322.
- Christie's experiments on struts, 170 to 180, 201, 211.
- Columns, deflection of, 156, 161 to 165.
 ——— different modes of failure, 153, 160, 173.
 ——— of cast iron, wrought iron, and steel, 177 to 179.
 ——— of uniform elasticity, 154 to 160.
 ——— of varying elasticity, 161 to 168.
 ——— strength of, 160, 166, 169 to 180.
- Comparative anatomy of bridges, 59 to 90.

- Comparative economy of bridges, 4, 91, 112, 326 to 332, 346, 355, 383 to 386, 400.
- Comparative economy of iron and steel, 327.
- Concrete, weight of, 264.
- Continuous girders, 134 to 152, 389 to 392.
- Contraction of area in test bars, 214.
- Counterbracing, 293, 338.
- Cover-plates, 235, 236.
- Creosoted timber, weight of, 264.
- Cross-girders, 258, 268, 269.
- Cruciform iron struts, 191, 192.
- Crushing strength of cast iron, 172.
- of materials, 12, 153.
- of wrought iron, 169.
- Curve of the bended beam, 115 to 133.
- of the elastic column, 156.
- of the linear arch, 65.
- of the suspension chain, 68, 69, 350 to 352.
- Cylindrical struts, 185, 201, 203.
- DEFLECTION** an unreliable test of strength, 113, 210.
- curve, 113 to 133.
- of cantilever bridges, 121 to 124, 399.
- of cantilevers, 121 to 124.
- of continuous girders, 128 to 130.
- of girders, 125 to 128.
- of girders of uniform section, 119 to 131.
- of girders under uniform stress, 117.
- of girders with varying section, 132.
- of struts of uniform elasticity, 157 to 159.
- of struts of varying elasticity, 161 to 165.
- of solid beams, 131.
- under a load suddenly applied, 240 to 245.
- Depth of girders and arches, 330 to 332, 347, 359, 395.
- Diagonals. See BRACING.
- Diagram of bending moments, 32, 38 to 58, 134 to 152, 155, 162, 361, 374.
- of flange-stress, 59 to 88.
- of metal in bridges, 91.
- of stress-intensity, 114, 119.
- Didion's experiments on wind-pressure, 406.
- Drilled rivet holes, 232.
- Du Buat's experiments on wind-pressure, 406.
- Ductility of steel, 215 to 218.
- of wrought iron, 213, 214.
- Dynamic action of a load suddenly applied, 239, 244 to 252.
- of sudden wind-gusts, 411.
- method of fixing the working stress, 257 to 262.
- stress, 246 to 248.
- ECONOMY** in bridge-construction. See COMPARATIVE ECONOMY.
- Elastic bodies, vibrations in, 240, 244 to 252, 411.
- Elastic limit, raised by repetitions of stress, 252.

- Elasticity, 9, 10.
 — limit of, 249 to 252.
 — modulus of, 11, 167, 169, 172, 173.
 — variations in, 167.
- Equilibrium, 8.
 — curve of, in arches, 66.
 — in chains, 68, 69, 350 to 352.
 — of columns, 154 to 157, 161 to 165.
 — of structures in general, 9.
 — indifferent in columns, 159.
 — stable in columns, 161 to 165.
 — stable in suspension bridges, 351.
 — unstable in arches, 351.
- Excentricity of reaction in columns, 168.
- Expansion and contraction of iron, 147.
 — of iron arches, 357 to 360, 368, 371.
 — of iron piers, 147, 148.
 — of suspension chains, 353, 354, 357 to 360, 371.
 — of suspended bow-string, 368.
- Experiments by Baker upon wind-pressure, 404, 405, 410
 — by Borda upon wind-pressure, 405, 406.
 — by Christie on struts, 170 to 179, 201, 211.
 — by Cincinnati Railway Company on struts, 170.
 — by Duchemin upon wind-pressure, 407.
 — by Du Buat upon wind-pressure, 407.
 — by Didion upon wind-pressure, 406.
 — by Edgemoor Iron Company on steel links, 226.
 — by Fairbairn on fatigue of metals, 240.
 — by Galton on fatigue of metals, 242.
 — by Harkort on steel girders, 217.
 — by Hodgkinson on cast-iron columns, 172, 175, 177.
 — on crushing strength, 172.
 — on cylindrical struts, 201.
 — on wrought-iron cellular struts, 200.
 — on wrought-iron columns, 170.
 — by Kennedy, on bending strain, 131.
 — on effect of perforation, 232.
 — on rivetted joints in steel, 229 to 234.
 — on steel rivets, 229, 230.
 — by Kircaldy on tensile strength of iron, 213.
 — on working strength of iron, 250.
 — on variations of elasticity, 167.
 — by Moberly on rivetted joints in steel, 229, 233.
 — by Parker on strength of punched plates, 232.
 — by Research Committee on rivetted joints, 231.
 — by Robinson on the vibration of bridges, 271.
 — by Seguin on strength of iron wire, 214.
 — by Shaler Smith upon eye-bars, 224.
 — by Telford on strength of iron wire, 214.
 — by Thibault upon wind-pressure, 410.
 — by Wöhler on working strength of iron and steel, 241 to 244.
 — upon the indifferent equilibrium of columns, 158.

Eye-bars, employed as tension members, 221, 323, 345, 380.
 — proportions of, 222 to 226.
 — steel, 226.
 — tensile strength of, 213, 218, 226.
 — weight of, 237.

FACTOR of safety, 181, 218, 238, 255, 260 to 262.

Failure of bridges by buckling, 210.

— of struts, 12, 153, 160, 173.

Fairbairn's experiments on fatigue, 240.

Fatigue, apparent evidences of, 240 to 242, 247.

— contradictory results, 242.

— measurement of, by experiments, 241 to 244.

— probable nature of, 242, 247 to 252.

Fink truss, construction of, 77, 78.

— stresses in, 78.

— weight of, 99, 109.

Flange-stress, in different forms of bridge, 60 to 90.

— in cantilevers, 62, 64, 72, 73, 391 to 397.

— in parabolic girders, 63, 65, 333 to 341.

— in parallel girders, 80 to 88, 279 to 304.

— in rigid arched ribs, 361 to 364, 375.

— in rigid suspension bridge, 361 to 364, 375 to 379.

— in suspended bowstring, 365 to 369.

Flexure, primary and secondary, 183, 200, 205.

Forth Bridge, 203, 219, 356, 396.

French rules for steel plates, 216.

— for working stress, 218.

Friction of pin-connections, 211.

GALTON, experiments on fatigue, 242.

Girders, bowstring, 63 to 65, 101, 111, 333 to 347.

— camber of, 132.

— cantilever, 39 to 44, 62, 64, 119 to 124, 391 to 401.

— continuous, 134 to 152, 389 to 392.

— curved, 72, 348, 349.

— deflection of, 114 to 132.

— depth of, 330 to 332, 347, 359, 395.

— English and American, 89, 323, 327, 332.

— lattice, 79 to 88, 105 to 108, 289 to 320.

— parabolic, 63 to 65, 111, 333 to 346.

— parallel, 61, 62, 79 to 88, 105 to 108, 279 to 332.

— plate-webbed, 30 to 35, 61, 70, 304.

— Warren, 85, 86, 107, 108, 295 to 298, 316, 317.

— weight of, 91 to 108, 306 to 324, 343, 399.

Government rules. See BOARD OF TRADE.

Granite, weight of, 264.

Graphic representation of moments, 32, 38 to 58.

— of moment of resistance, 23, 24, 28, 29.

— of moment of inertia, 28, 29.

— theory of bridge-construction, 59 to 71.

— of columns, 153 to 180.

- Graphic theory of continuous girders, 134 to 152.
 — of deflection, 113 to 133.
- HARKORT**, experiments on steel girders, 217.
 Heat, effect of. *See* EXPANSION.
- Hinges, in arched ribs, 357, 361 to 364, 371.
 — in auxiliary girders, 359.
 — in cantilever bridges, 390 to 393.
 — in continuous girders, 390 to 393.
 — in rigid suspension bridges, 361 to 364, 371.
- Hodgkinson's experiments on cast-iron columns, 172, 175, 177.
 — on crushing strength, 172.
 — on cylindrical struts, 201.
 — on wrought-iron cellular struts, 200.
 — on wrought-iron columns, 170.
- IMPACT**, 239, 257 to 262.
- Inertia, moment of. *See* MOMENT and GRAPHIC.
- Initial camber of girders, 132, 133.
- Initial stress in bracing, 293, 338.
- Inverted bowstrings, construction of, 68, 336 to 344.
 — stresses in, 68, 333 to 342.
 — weight of, 111, 343 to 345.
- JOINTS** and connections, 220, 235.
 — economy in, 220, 326 to 332.
 — efficiency of, 227.
 — in single and double shear, 227.
 — pin connections, 221 to 226.
 — rivetted. *See* RIVETTED.
 — weight of, 236, 237.
- KENNEDY**, experiments on perforated plates, 232.
 — on rivetted joints in steel, 229 to 234.
 — on steel rivets, 229, 230.
- Kentucky Bridge, 148, 391.
- Kircaldy, experiments on tensile strength, 213.
 — on working strength, 250.
 — on variations of elasticity, 167.
- Kuilemburg Bridge, 321, 348.
- LATERAL** adhesion, untenable theory of, 27, 36.
- Lattice girders, different types of, 79 to 88, 279 to 303.
 — end pillars of, 304.
 — stresses in, 79 to 88, 279 to 303.
 — weight of, 99, 108, 318 to 322.
- Launhardt-Weyrauch formula, 256, 307.
- Limestone, weight of, 264.
- Limiting span of parabolic girder, 346.
 — of parallel girder, 325.
 — of suspension bridge, flexible, 354.
 — of suspension bridge, rigid, 388.

- Linear arch, curve of equilibrium, 65, 66, 350.
 ——— stresses in, 66, 71.
 ——— theoretical weight of, 101, 111.
 ——— unstable equilibrium of, 351.
- Linville truss, construction of, 79 to 84, 289, 293, 301.
 ——— stresses in, 79 to 84, 279 to 303.
 ——— weight of, 98, 106, 313 to 315, 323.
- Live load on public bridges, 265.
 ——— on railway bridges, 265 to 271.
- Lloyd's rules for steel plates, 216.
- Load, division of, 263.
 ——— distinguished from stress, 9, 10, 246.
 ——— on cross-girders, 269.
 ——— on bridges, 263 to 272.
 ——— on locomotive axles, 265 to 271.
 ——— on stringers, 269.
 ——— suddenly applied, 10, 244.
 ——— suddenly varied, 245, 246.
- Locomotives, weight of, 265 to 271.
- MACADAM**, weight of, 264.
- Manufacture of eye-bars, 222, 226.
- Measurement of stress and strain, 10, 23, 24.
- Mechanical adjustment of points of contrary flexure, 62, 63, 64, 390.
- Moberly's experiments on rivetted joints, 229, 233.
- Modulus of elasticity, 10.
 ——— in cast iron, 172.
 ——— in steel, 174.
 ——— in wrought iron, 10, 169.
 ——— observed variations in, 167, 168.
- Moment of a force about an axis, 13.
 ——— of inertia, 28 to 30.
 ——— of resistance, 25.
- Moments due to a single weight, 39.
 ——— due to two or more weights, 40.
 ——— due to an irregular load, 43.
 ——— due to a uniform load, 41.
 ——— in a balanced cantilever, 44.
 ——— in a beam supported at each end, 45 to 50.
 ——— in a beam strained over one pier, 52 to 56.
 ——— in a beam strained over both piers, 54 to 58.
 ——— in a panelled bridge, 51.
 ——— tabulated analysis of, 274, 275.
- NEGATIVE** pressure of wind on rear surface, 406, 408, 410, 411.
- Neutral axis, in a beam, 23 to 29.
 ——— position of, 23 to 29.
- Niagara cantilever bridge, 395.
- OAK**, weight of, 264.
- Oblique fracture in iron and steel plates, 234, 235.
- Observations of wind-pressure, 402, 403, 414.

- Ohio Bridge, 84, 323, 324, 327, 348.
- Opposition of forces, 8, 9, 13 to 21.
- Origin of the arch, the girder, and the suspension-bridge, 1, 22, 90, 370.
- Oscillation of bearing springs, 239, 270, 271.
- of elastic bodies. *See* VIBRATION.
- of girders. *See* VIBRATION.
- of suspension-bridges, 350, 351, 355, 356.
- PANEL, economic width of, 51, 328, 329.
- Panelled bridges, construction of, 51, 70.
- moments, 70.
- stresses in, 70, 80 to 90, 279 to 304.
- weight of, 105 to 111, 313 to 321, 344, 380.
- Parabolic bridges, construction of, 63, 333.
- girders, different types of, 63, 333.
- economic proportions of, 347.
- limiting span, 346, 347.
- stresses in, 65, 68, 333 to 345.
- weight of, 101, 111, 343 to 345.
- Parachute, wind-pressure upon, 405, 406.
- Parallel girders, different types of, 61, 80 to 90, 279 to 304.
- economic proportions, 328 to 332.
- limiting span, 325.
- stresses in, 80 to 90, 279 to 305.
- weight of, 97 to 99, 105 to 108, 306 to 324.
- Parallelogram of forces, geometrical demonstration, 16, 17.
- Parker's experiments on strength of punched plates, 232.
- Perforated plates, increased strength of, 232.
- Phoenix columns, 170, 201, 202.
- Pier-moment, in cantilever bridges, 62, 391 to 394.
- in continuous girders, 62, 134 to 150, 390, 391.
- Piers, expansion and contraction of, 147, 148.
- settlement of, 144 to 146.
- Pillars. *See* COLUMNS and STRUTS.
- Pin-connections. *See* EYE-BARS.
- Plate-girders, construction of, 28, 61, 304.
- flange-stress in, 30 to 32, 61, 304.
- shearing stress in the web, 33 to 35, 304.
- Plate, strength of wrought iron, 213, 218.
- strength of mild steel, 215 to 219.
- Platform of railway bridges, weight of, 264.
- Polygonal arches, 71.
- Polygonal girders or trusses, 71, 333 to 336.
- Pratt truss, construction of, 79.
- stresses in, 80 to 84, 289 to 293.
- weight of, 98, 105, 313 to 315.
- Pressure of wind. *See* WIND.
- Proportions of eye-bars, 222 to 226.
- of girders, 328 to 332, 347, 395.
- Public road bridges, load on, 265.
- Punching, injury caused by, 231.

QUEBEC Bridge, 395.

RADIUS of gyration in struts, 185.

Railway bridges, live load upon, 265 to 272.

—— weight of platform, 264.

Rankine's formula for long struts, 178, 183.

—— inverted for purposes of bridge design, 183 to 187.

Rectangular bar struts, 187 to 190.

Reduced strength of plate in rivetted joints, 230 to 234.

Reduction of wind-pressure to a standard, 414, 415.

Relieved bowstrings, 365 to 369.

Repetitions of stress, effect of, 240 to 252.

—— elastic limit raised by, 252.

—— ultimate strength uninfluenced by, 252.

Resilience of a bent bow or an elastic column, 154 to 157.

Resistance, moment of. *See* MOMENT.

Resolution of forces, 18.

Resultant of inclined forces, 16, 17.

—— of elastic resistance in a strut, 161 to 168.

Reversed bending stress in cantilever bridges, 392 to 395.

Rigid suspension bridge, construction of, 361, 377.

—— deflection of, 387.

—— economic proportions, 386, 388.

—— limiting span, 388.

—— stresses in, 361, 362, 371 to 379.

—— weight of, in iron, 379 to 383.

—— weight of, in steel, 384 to 386.

Rigidity in arches and suspension bridges, 351, 357, 370, 387.

Rivets, bearing pressure on, 230.

—— in single and double shear, 227.

—— shearing strength of, 228 to 230.

Rivet iron, 228.

Rivet steel, 229.

Rivetted joints, arrangement of, 235, 236.

—— efficiency of, 227.

—— in ironwork, 227 to 236.

—— in steel, 229 to 236.

Roadway girders. *See* AUXILIARY GIRDERS.

Robinson, experiments on the vibration of bridges, 271.

Rolling load on public bridges, 265.

—— on railway bridges, 265 to 271.

—— variations in, 270 to 272.

SAFETY, factor of. *See* FACTOR.

Saltash Bridge, 72, 333 to 349.

Secondary bracing, 203 to 208.

Sectional area of members, determination of, 254 to 262.

—— of struts, 182 to 200.

Settlement of piers in continuous girder bridges, 144 to 146.

Shearing strain, measurement of, 35, 131.

—— stress, in a plate web, 32 to 27.

—— in a solid beam, 36, 37.

- Shearing strength of iron pin-connections, 225.
 — of iron rivets, 228.
 — of steel rivets, 229.
- Shipbuilding, steel plates used in, 216.
- Sickle-girder, 72.
- Side-span of cantilever bridge, stresses in, 393.
- Skin friction, a part of wind-pressure, 406, 407.
- Shaler Smith's experiments on eye-bars, 224, 225.
- Snow, weight of, 265.
- Span, limiting. *See* LIMITING.
- St. John's River Bridge, 394.
- Steel, Admiralty rules for ship plates, 216.
 — cantilever bridges, 394 to 401.
 — weight of, 397 to 399.
 — columns, strength of, 173, 174, 179, 180.
 — comparative economy of iron and steel, 327.
 — ductility of, 215 to 218.
 — economic use of, in ties, 327.
 — in struts, 328.
 — elasticity of, 167, 173.
 — eye-bars, 219, 226.
 — "fatigue" of spring-steel, 242, 243.
 — girders tested at Duisberg, 217.
 — injuries produced in the manipulation of, 218, 231 to 234.
 — Lloyd's rules for ship-plates, 216.
 — modulus of elasticity, 173.
 — plates, strength of, 215 to 219, 230 to 234.
 — proportion of carbon in, 179, 215, 216.
 — rivets, strength of, 229, 230.
 — rivetted joints in, 227 to 235.
 — shearing, strength of, 229, 230.
 — struts, design of, 181 to 212, 327.
 — strength of, 173 to 180.
 — tensile strength of, 215 to 217.
 — variations in the elasticity of, 167, 168.
 — unexplained failures in, 213, 217, 218, 233.
 — weight of, 92.
 — working strength of, 182, 219, 238 to 262.
- Straight link suspension bridges, construction of, 71, 77.
 — stresses in, 71, 77.
 — weight of, 100, 110.
- Strain, 9, 10.
 — relation between, and stress, 10.
 — shearing. *See* SHEARING.
- Strength. *See* CRUSHING, TENSILE, SHEARING.
 — definition of, 11.
 — of columns. *See* COLUMNS.
 — of joints, 220 to 235.
 — working. *See* WORKING STRENGTH.
- Stress, definition of, 9.
 — distinguished from straining force, 9, 10, 246.
- Stresses in a bent beam, 23 to 37.

Stresses in bridge-members. *See* ARCH, GIRDER, BOWSTRING, SUSPENSION BRIDGE, &c.

Struts, construction and design of, 181 to 212.

— limits to diameter of, 183, 184.

— of angle iron, 190, 191.

— of beam section, 192, 193, 196.

— of box section, 197 to 200.

— of channel iron, 193 to 195.

— of cylindrical section, 201 to 203.

— of cruciform section, 191, 192.

— of rectangular section, 187 to 190.

— of square section, 187 to 189.

— of tee iron, 191, 192.

— secondary bracing of, 204 to 208.

— weight of, 207, 208.

Suspended bowstring, construction of, 363 to 369.

— expansion of, 364, 368.

— stresses in, 365 to 367.

Suspension bridge, construction of, 68, 69, 350 to 356.

— expansion and contraction of, 353, 354.

— oscillations of, 350, 351, 355.

— rigid. *See* RIGID SUSPENSION BRIDGE.

— stresses in, 68, 69.

— weight of, 101, 103, 112, 353 to 355.

TABLES, bending moments due to rolling load, 274, 276, 277.

— calculated sectional area of struts, 188 to 199.

— flange-stress in parabolic girders, 335.

— in parallel girders, 280 to 304.

— in rigid suspension bridge, 379.

— in suspended bowstring, 367.

— moment of inertia and radius of gyration, 185.

— proportions of eye-bars, 223, 224.

— rivet strength for iron rivets, 229.

— for steel rivets, 230.

— sectional area of members determined by different methods, 308, 309, 341.

— of braced struts, 204, 207.

— shearing stress in parabolic girders, 335, 338 to 340.

— in parallel girders, 281 to 302.

— strength of columns, 174, 177, 178, 179.

— tensile strength of wrought iron, 213, 214.

— weight of American trusses, 109.

— weight of cantilever bridges in steel, 399.

— weight of linear arch, 111.

— weight of materials used in construction, 264.

— weight of parabolic girders, 111, 344, 345.

— weight of parallel girders, 105 to 108, 313 to 321.

— weight of platforms in railway bridges, 264.

— weight of rigid suspension bridge, in iron, 380.

— weight of rigid suspension bridge, in steel, 385.

— weight of rolling load, 266, 267.

— weight of suspension bridges, 109, 110, 112, 353.

- Tables, weight of tension members, 237.
 — working strength by Wöhler's experiments, 244.
 — working strength by dynamic theory, 248.
- Tay Bridge, 402, 415, 417.
- Tee-iron struts, 191, 192.
- Telford, experiments on strength of iron wire, 214.
- Temperature, effects. *See* EXPANSION.
- Tensile strength of cast iron, 215.
 — of steel, 215 to 219.
 — of wrought iron, 213.
 — of wire cables, 214.
- Tension members, economic construction of, 220, 326 to 332.
 — weight of, 236, 237.
- Testing bridges by observations of their deflection, 113, 210.
- Theory of continuous girders, 134 to 152.
 — of columns, 153 to 180.
 — of deflection, 113 to 133.
 — of "fatigue," 240 to 262.
 — of lateral adhesion, 27, 36.
- Thibault, experiments on wind-pressure, 410.
- Thickness of struts, limits of, 183 to 203.
- Thrust of arches, 65.
- Ties, strength and construction of, 213 to 237.
- Trapezoidal trusses, construction of, 76, 79.
 — stresses in, 76, 79.
 — weight of, 110.
- Truss. *See* PRATT, LINVILLE, BOLLMAN, FINK.
- Tubular girders, wind-pressure upon, 407, 411.
 — struts, 201 to 203.
- ULTIMATE strength, 11.
 — of materials. *See* CRUSHING, TENSILE, SHEARING.
- Unbalanced force, effect of, 6 to 8.
- Uncertain behaviour of steel, 213, 217, 218.
- Unequal stress in rivetted joints, 233.
- Uniform load, moments of, 41, 42, 48 to 50.
- Upper flange of girders, construction of, 209, 210.
- Upright and inverted arches, 65, 68, 69, 71.
 — bowstrings, 65, 68, 71.
- Useful load, 91.
- VARIATIONS in the elasticity of iron and steel, 167, 168.
 — in the load on railway bridges, 239, 270, 271.
 — of stress, effect of, 240 to 262.
 — of wind-pressure, 411 to 413.
- Velocity and pressure of the wind, 404.
- Vibrations of an elastic body, 240, 244 to 248.
 — of an imperfectly elastic body, 249 to 252.
 — of bridges, 271, 272.
 — of bearing springs, 239, 270.

- Vibrations, stress due to, 240, 244 to 252.
 Violence of wind-gusts, 411 to 413.
- WALLS** of buildings, wind-pressure upon, 407, 408, 414.
- Warren girder, construction of, 79, 295 to 298.
 — stresses in, 85, 86, 295 to 298.
 — weight of, 98, 107, 108, 316, 317.
- Waste metal in construction, 92, 207, 208, 220, 236.
- Web of plate-girders, stresses in, 33 to 35, 304.
 — of lattice-girders, stresses in, 65, 79 to 88, 280 to 303.
 — of parabolic girders, stresses in, 65, 334 to 345.
- Weight of Bollman truss, 100, 109.
 — bow-and-chain bridge, 345.
 — bowstring girders, 101, 111, 344.
 — bridges, general formulæ, 91 to 97, 310 to 312.
 — cantilever bridges, 399.
 — Charing Cross Bridge, 322.
 — Fink truss, 99, 109.
 — girders, as part of their load, 306, 310 to 312.
 — inverted bowstring, 111, 344.
 — Kuilemburg girders, 321, 348, 349.
 — lattice girders, 99, 108, 318 to 321.
 — Linville truss, 98, 106, 313 to 315, 323.
 — linear arch, 101, 111.
 — locomotive engines, 266, 267.
 — materials used in construction, 264.
 — metal in an inclined bar, 93.
 — Ohio Bridge, 323, 324.
 — Pratt truss, 98, 105, 313 to 315.
 — parabolic girders, 101, 111, 343 to 345.
 — parallel girders, 97 to 99, 313 to 323.
 — platforms of railway bridges, 264.
 — rigid suspension bridge, in iron, 379 to 383.
 — rigid suspension bridge, in steel, 384 to 386.
 — rivet heads, 264.
 — straight link bridges, 100, 109, 110.
 — struts, 207, 208.
 — suspension bridges, 101, 103, 112, 353.
 — tension members, 236, 237.
 — ties in a girder equal to the theoretic weight of struts, 96.
 — Warren girder, 98, 107, 108, 316, 317.
 — wind-bracing, 383, 385, 387.
- Weyrauch formula. *See* LAUNHARDT.
- Wind-bracing, construction of, 416, 417.
 — stresses in, 416, 417.
 — weight of, 383, 385, 387.
 — working stress in, 416.
- Wind, pressure and velocity of, 404.
- Wind-pressure as a rolling load, 416, 417.
 — due to sudden gusts, 411 to 414.
 — dynamic action of, 411 to 414.
 — experiments still wanting, 405, 406, 407, 409, 418.

- Wind-pressure recorded by dynamometers, 411 to 414.
 — surface of bridges exposed to, 403, 407, 411.
 — upon a grating, 408.
 — upon bodies sheltered by a grating, 409.
 — upon bodies partially sheltered, 409 to 411.
 — upon curved surfaces, 405, 406.
 — upon houses, 407, 408, 414.
 — upon parachutes, 406.
 — upon prismatic bodies, 406, 407, 415.
 — upon railway carriages, 407, 415.
 — upon solid bodies, 406 to 408, 415.
 — upon thin plates, 404, 410, 415.
 — upon surfaces of different areas, 405.
 — upon windows, 408, 414.
 — upon walls of buildings, 408, 414.
 Wire, tensile strength of, 214.
 Work required in breaking a test-bar, 216, 249 to 252.
 Working load in struts, 181, 182, 183, 309.
 — in ties, 218, 219, 254.
 Working strength of iron and steel, 238 to 262.
 Working stress in cables of suspension bridges, 219.
 — in chains of suspension bridges, 219.
 — in rivetted joints, 230 to 234.
 — in rolled bars, 218.
 — in steel structures, 219, 386.
 — in wrought-iron plates, 218, 262.
 — under varying loads, 238 to 262.
 Wrought-iron bars, tensile strength of, 213, 218.
 — plates, tensile strength of, 213, 218.
 — weight of, 92, 264.
 ZIGZAG fracture in rivetted joints, 234, 235.

THE END.

